

Tribeca

Series

TRIBECA L.

Companion Luminaires



**Tribeca Series
APWS-107**
p. 12-15
"Architectural Plaster"

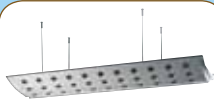

**Tribeca Series
APPD-350**
p. 54-55
"Architectural Plaster"





APWS-107.01

Tribeca S.

Designer - Yves Blayo



- NP
- MW
- SW
- RD
- BL
- OL
- EB
- SG
- SM
- PG
- PM
- CG
- CM

• Mounting

Wall mount on octagonal J-Box (4x4)

• Material

Fibre Reinforced Plaster™ and Polyester Film

• Lamp type (lamp not included)

 x 1
CFQ18W G24q-2
Compact Fluorescent, Quad-tube, 4-Pin

 x 1
CFQ26W G24q-3
Compact Fluorescent, Quad-tube, 4-Pin

• Voltage and Ballast

- All our fluorescent lighting fixtures are available in 120 or 277 Volts
- All our ballasts are electronic and are less than 10% THD
- For 347 Volt ballast, please consult the factory
- For electronic dimming ballast, please consult the factory

• Dimensions (Length x Height x Depth)



10.6" x 14.6" x 3.1"

• Weight

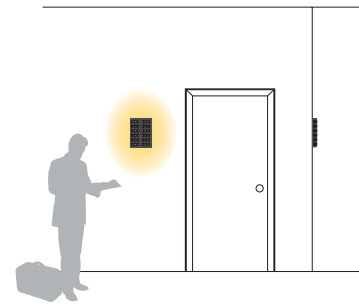
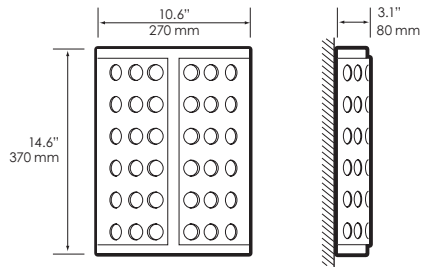
4.1 lbs.



HOW TO SPECIFY

SERIES	MODEL#	LAMP TYPE	VOLTAGE	FINISH
APWS	107.01	→ _____	→ _____	→ _____
		 CFQ18W  CFQ26W	120 = 120 Volts 277 = 277 Volts	NP = NATURAL PLASTER SG = SILVER GLOSS MW = MATTE WHITE SM = SILVER MATTE SW = SATIN WHITE PG = PLATINUM GLOSS RD = RED PM = PLATINUM MATTE BL = BLUE CG = COPPER GLOSS OL = OLIVE CM = COPPER MATTE EB = EBONY
Architectural Plaster Wall Sconce				

APWS-107.03

Tribeca L.

Designer - Yves Blayo

MW

RD

BL

OL

EB

SM

PM

CM

• Mounting

Wall mount on octagonal J-Box (4x4)

• Material

Fibre Reinforced Plaster™ and Polyester Film

• Lamp type (lamps not included)

 x 2
F80WT5HO G5
Fluorescent Tube, 2-Pin

 x 4
F80WT5HO G5
Fluorescent Tube, 2-Pin

• Voltage and Ballast

- All our fluorescent lighting fixtures are available in 120 or 277 Volts
- All our ballasts are electronic and are less than 10% THD
- For 347 Volt ballast, please consult the factory
- For electronic dimming ballast, please consult the factory

• Dimensions (Length x Height x Depth)



27.6" x 72.0" x 4.5"

• Weight

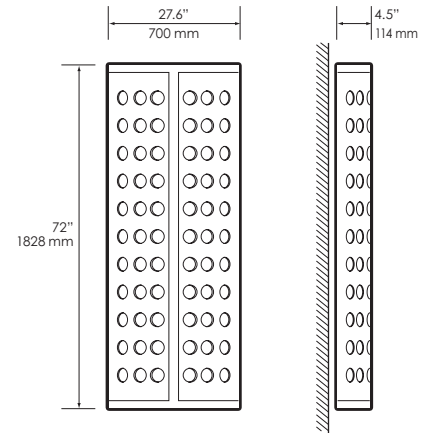
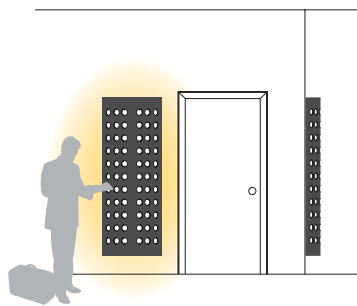
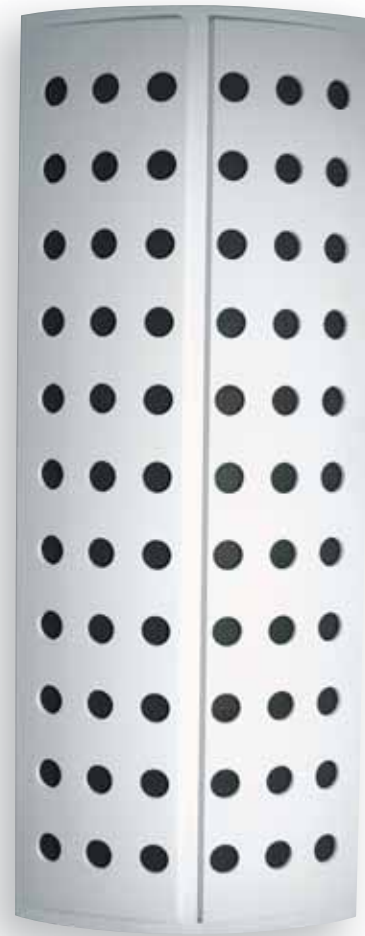
62.4 lbs.



HOW TO SPECIFY

SERIES	MODEL#	LAMP TYPE	VOLTAGE	FINISH
APWS	107.03	→ _____	→ _____	→ _____
		 2x F80WT5HO  4x F80WT5HO	120 = 120 Volts 277 = 277 Volts	MW = MATTE WHITE RD = RED BL = BLUE OL = OLIVE EB = EBONY SM = SILVER MATTE PM = PLATINUM MATTE CM = COPPER MATTE
Architectural Plaster Wall Sconce				





APPD-350.02

Tribeca

Designer - Yves Blayo

MW

RD

BL

OL

EB

SM

PM

CM

Mounting

Pendant mount on octagonal J-Box (4x4)

Material

Fibre Reinforced Plaster™ and Polyester Film

Lamp type (lamps not included)

⎓ x 2
F80WT5HO G5
Fluorescent Tube, 2-Pin

⎓ x 4
F80WT5HO G5
Fluorescent Tube, 2-Pin

Voltage and Ballast

- All our fluorescent lighting fixtures are available in 120 or 277 Volts
- All our ballasts are electronic and are less than 10% THD
- For 347 Volt ballast, please consult the factory
- For electronic dimming ballast, please consult the factory

Dimensions (Length x Height x Depth)

71.9" x 5.5" x 27.6"

Weight

64.4 lbs.

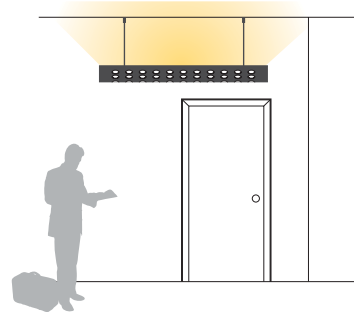
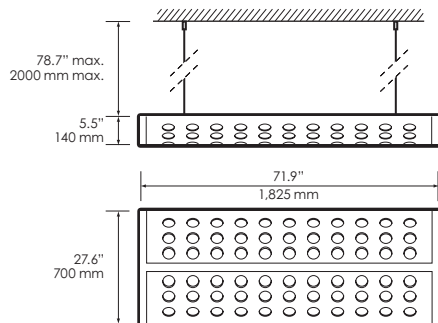

HOW TO SPECIFY

SERIES	MODEL#	LAMP TYPE	VOLTAGE	FINISH
APPD	350.02	→ _____	→ _____	→ _____
		<p>⎓ x 2 F80WT5HO</p> <p>⎓ x 4 F80WT5HO</p>	<p>120 = 120 Volts</p> <p>277 = 277 Volts</p>	<p>MW = MATTE WHITE SM = SILVER MATTE</p> <p>RD = RED PM = PLATINUM MATTE</p> <p>BL = BLUE</p> <p>OL = OLIVE</p> <p>EB = EBONY CM = COPPER MATTE</p>
Architectural Plaster Pendant				

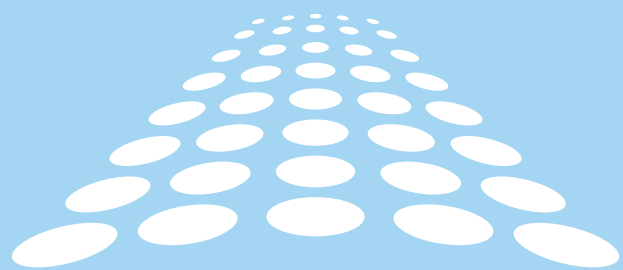

sedap

n o r t h a m e r i c a