

7% price increase effective January 1, 2009

NOW! Tables - ships in 10 days

Boat Shape - Panel End Base - WoodPlus Laminates ONLY

Description	Model Number	Depth	Length	Wgt	List Prices	
					WoodPlus	Standard
36" wide, 18" wide base	TB3672-PEB	36	72	130	1785	1938
	Top: 1 piece; Base: 2 PEB					
48" wide, 24" wide base	TB4896-PEB	48	96	206	2273	2440
	TB48120-PEB	48	120	250	2804	3038
Top: 1 piece; Base: 2 PEB.						

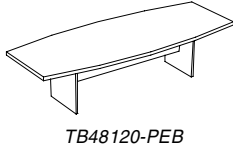

TB48120-PEB

Boat Shape - Radius Cube Base - WoodPlus Laminates

48" wide	TB4896-RC	48	96	344	4030	4230
24" wide base	TB48120-RC	48	120	424	4336	4570
	Top: 1 piece; Base: 2 RC.					

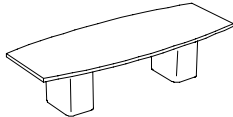

TB48120-RC

Racetrack Shape - Half Cylinder Base - WoodPlus Laminates

36" wide, 18" wide base	TR3672-HC	36	72	246	2671	2866
	Top: 1 piece; Base: 2 HC					
42" wide, 18" wide base	TR4296-HC	42	96	296	3157	3357
	Top: 1 piece; Base: 2 HC					
48" wide, 24" wide base	TR48120-HC	48	120	424	3500	3734
	Top: 1 piece; Base: 2 HC					

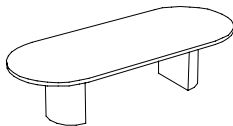

TR48120-HC

* Conference tables on this page qualify for MAGNA NOW! 10 day shipping program. You must specify MAGNA NOW! on your purchase order. For large orders, please check with Customer Service since factory volume may affect leadtime.

IMPORTANT: Tables are standard with wood grain running length of table.

October 2007, Magna Design, Inc.

CMR-3

Magna NOW! conference tables - available in 10 days*

7% price increase effective January 1, 2009

Ordering Information - Quick Spec

Order Examples with required Quick Spec information:

Qty	Model Number	Top Edge	Top Finish	Top Edge Finish	Vertical Finish	Vertical Edge Finish	Pull Number	Option 1	Option 2	Option 3
1	TR58120-ACE-HC	2100	WP23	W23	WP23					
2	TDE58216-RC	3200	WP41	W31	WP31					
1	STV8-3684-24	CL	WP61	W41	WP61	WP61	13	UPD	LHD	TVT-SH
1	ST8-2LF-3084-24-LOCK	CL	WP61	W41	WP61	WP61	13	UHD		
1	PDB-4872-WPE				WP41	WP41		PS		
1	CRL-MF-3430-RACK-WP2		WP2-61		WP2-88			UD	CA	
1	TT3672-CLEG	WPES	WP81	CP88						
2	TB-BE-46168-ACE-RC-WP2		CP2-28		WP2-71					

Required Order information

- Quantity required
- Model Number as shown in Price Catalogs
- Top Edge required (with few exceptions such as WP2 finish colors and Accessories)
- Finish Colors: varies by product chosen
- Pull Number (if there are drawers or doors, excluding ACT tables)
- Options: as required

Finish Colors, Pulls, Top Edges

WoodPlus tops

- WP-31 Medium Cherry
- WP-71 Dark Cherry
- WP-73 Cognac
- WP-48 Sipp'g Seattle Java-1
- WP-41 Natural Maple
- WP-81 Fusion Maple
- WP-45 Anigre
- WP-23 Cordovan
- WP-61 Pear
- WP-04 Solar Oak

WoodPlus verticals

- All WoodPlus top colors plus
- CP-76 Espresso
- CP-98 Slate
- CP-88 Black

WoodPlus XTRA tops

- WP-05 Rift Oak
- WP-15 Midnight - 1,3
- WP-33 Blossom Cherry - 2
- WP-35 Golden Cherry - 3
- WP-37 Mocha Cherry - 3
- WP-67 Chocolate Pear - 3
- WP-75 Chestnut

WoodPlus XTRA verticals

- 1 - Hi-Brite table tops, worksurfaces All other surfaces are suede texture.
- 2 - Hi-Lustre table tops, worksurfaces All other surfaces are suede texture.
- 3 - No matching 3mm WPE edge

WoodPlus2 tops only

- CP2-28 Med Grey Speckle
- CP2-38 Beige Speckle.

WoodPlus2 tops and verticals

- WP2-45 Anigre
- WP2-71 Dark Cherry
- WP2-81 Fusion Maple
- WP2-31 Medium Cherry
- WP2-41 Natural Maple
- WP2-61 Pear

WoodPlus2 verticals only

- CP-76 Espresso
- CP-98 Slate
- CP-88 Black





















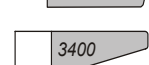





WoodPlus2 XTRA tops only

- WP2-18 Shadow Oak
- WP2-65 Beech
- CP2-74 Platinum
- CP2-78 Bronze
- CP2-72 Shark Gray
- CP2-80 Cashmere Fiber

Upcharge for XTRA WoodPlus and XTRA WoodPlus2 finishes is \$600 per finish per order.

For additional finishes please see the finish section on our website at <http://www.magnadesign.com> or contact Customer Service for details at 800-233-2304.

All edges available on WoodPlus ACT and Conference tables

WoodPlus 3 mm PVC Equations	Standard Wood Equations	Detailed Wood	2000 Wood	3000 Wood	WP2 Table, Credenza, Towers, Lecterns
					 Table outside edge Worksurface front edge
					
					 Door and Drawer edge Worksurface joint edge
					
					 WPK or STDK 'reverse knife' edge is available with 3mm PVC (WPK) or 3mm wood (STDK) edge, see reverse knife edge pricing page.
					

For Modular tables, Credenzas, Towers, Lecterns

~~7% price increase effective January 1, 2009~~

Conference and Meeting Products - Table of Contents

MAGNA NOW! tables - ship in 10 business days 3

How to order 4

General Information 7

Planning Information and Room Layouts 9

Specifications 15

Finishes 19

ACT Tables 21

Basic shape options:

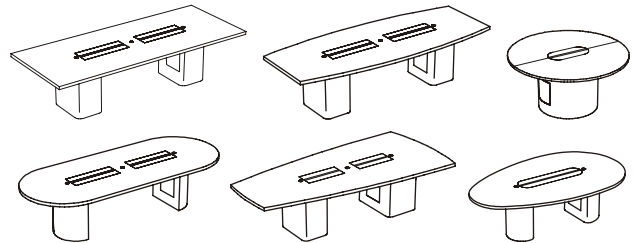

MINI - ACT units and options 54

Conference Tables 59

Basic shape options:

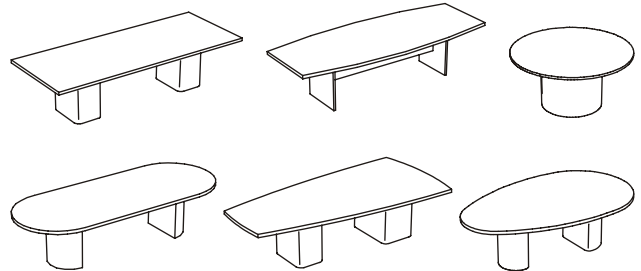

Modular Conference tables 91

Modular Tables and Modular Assemblies 101

Basic top and base options:

Assemblies:

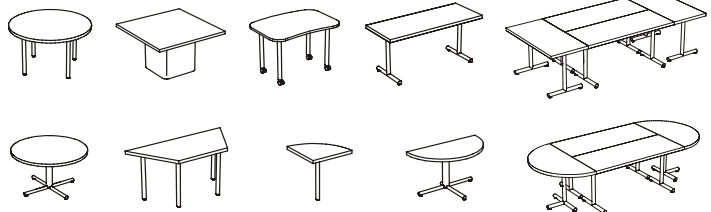

7% price increase effective January 1, 2009

Conference and Meeting Products - Table of Contents

Presentation Units, Marker Boards, Multimedia Lecterns 115

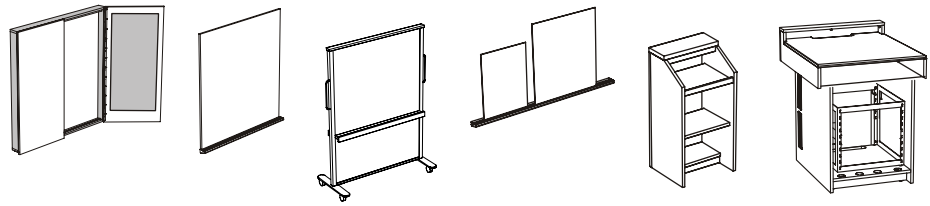

Credenzas & Occasional Tables 123

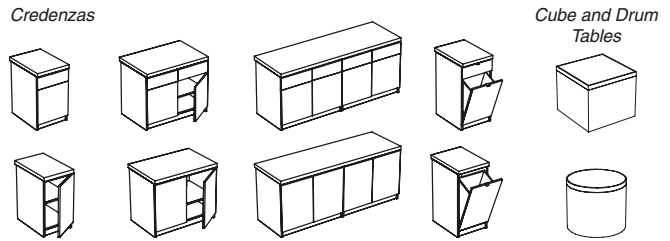

Storage Towers 137

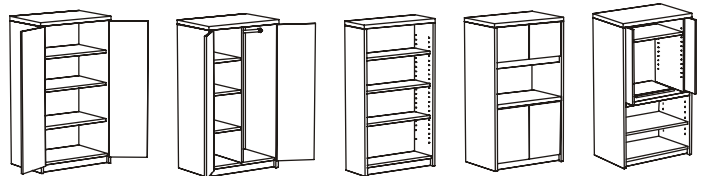

Mobile Units 153

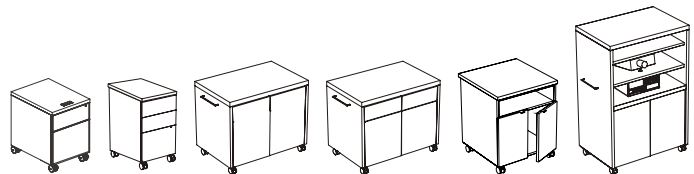

Index at back of price list 157

~~7% price increase effective January 1, 2009~~

Pricing and Delivery Information

PRICES:

Prices are subject to change without notice and the price list with the later date supersedes all previous price lists.

Prices do not include charges for cartoning, installation, or inside delivery.

Cartoning charges will be added to orders weighing under 250 lb.

DELIVERY:

All prices include delivery outside the Zone 1 region.

Zone 1 includes Washington, Oregon, Alaska, Hawaii, and British Columbia. Prices in Zone 1 reflect Factory Will Call. Zone 1 dealer discounts are adjusted accordingly.

A freight surcharge will be added to Zone 2 orders totaling less than \$10,000 LIST. The freight surcharge will be 10% of NET invoice total.

A Fuel Surcharge will be added to all invoices that include delivery.

Please see our website <http://www.magnadesign.com> for current details.

Standard delivery will be made on a dock-to-dock basis or to a sidewalk. Should you have special requirements such as inside delivery or prior notification please contact Magna Design's traffic department. Special delivery requirements will be handled on an as-available basis and will likely result in additional charges.

All Shipments are FOB Magna Plant, Lynnwood, Washington.

MAGNACAD INFORMATION



MagnaCad

The MagnaCad graphic drawing and presentation software package includes the complete symbol libraries for 2D layout drawings and 3D isometric illustrations. Magna product Symbol libraries are linked directly to specification and pricing information.

Product graphic and specification packages are available for use with 20-20's GIZA software, Data One's Design Express software and Project Matrix's Project Spec software. Software such as 20-20 GIZA, Design Express or Project Spec may be purchased directly from the software provider. Magna provides just the graphic and specification information for our product lines that can be used in these third party software products.

LIFETIME LIMITED WARRANTY

Magna Design warrants that its conference room products are free from defects in design, material and workmanship under normal single shift use and with proper care and maintenance. This lifetime warranty will remain in effect commencing with the date of purchase from Magna Design but only so long as the original purchaser continues to own the product. This lifetime warranty applies to all product and components not excluded below:

WoodPlus2 finishes on products purchased January 2002 or later - **LIFETIME**

Drawer slides - **LIFETIME**

LIFETIME for ALL PRODUCT and COMPONENTS, not listed below

Healthcare products - **ten (10) years**

Electrical components and functional mechanisms, like keyboard trays - **five (5) years**

Wood finishes - **three (3) years.**

Leatherlam - **twelve (12) months**

During the term of this Warranty, MAGNA DESIGN will repair or replace with the same or comparable product or part without charge any product or part that malfunctions or fails to conform to this Warranty. THIS REMEDY OF REPAIR OR REPLACEMENT IS PURCHASER'S SOLE AND EXCLUSIVE REMEDY WITH REGARD TO ANY PRODUCT DEFECT.

This Warranty does not apply to:

- Any damage caused during shipment.
- Any product installed or used other than in accordance with MAGNA DESIGN guidelines.
- Any product that has been repaired, altered, or modified by any person other than MAGNA DESIGN.
- Any attachment added to a product.
- Any fabric or upholstery material.
- Any part or material provided by Purchaser.
- Any damage caused by misuse, abuse, or negligence on the part of Purchaser or any third party.

THERE ARE NO OTHER WARRANTIES, EITHER EXPRESSED OR IMPLIED, INCLUDING ANY WARRANTY OF MERCHANTABILITY OR OF FITNESS FOR A PARTICULAR PURPOSE. UNDER NO CIRCUMSTANCES WILL MAGNA DESIGN BE LIABLE FOR ANY CONSEQUENTIAL OR INCIDENTAL DAMAGES ARISING FROM ANY PRODUCT DEFECT.

This warranty is in effect for products shipped on or after **May 1, 1998**.

~~7% price increase effective January 1, 2009~~

Terms and Conditions

QUOTATIONS:

Price quotations on non-catalog or special orders will not be valid after thirty (30) days without written approval from Magna Design, Inc.

CREDIT TERMS

Net thirty (30) days after invoice date upon credit approval.

ORDERING :

When ordering, please include complete identification and description of the product being ordered using Magna specifications and terminology. All orders must be in writing.

TELEPHONE ORDERS:

All telephone orders must be confirmed with a written purchase order.

ACKNOWLEDGMENTS:

All orders when accepted will be acknowledged by mail indicating the terms and conditions by which the order was accepted and a description of the items being ordered. Orders will be completed and shipped in accordance with the information on the acknowledgment and the purchaser intent. If the acknowledged information is incorrect we must receive written instruction to change.

CHANGE ORDERS:

Order entry will take place upon receipt of a purchase order from an authorized Magna Design dealer. Subsequent order changes will be subject to a minimum \$25 processing fee. Actual change order charges may be higher depending on the status of the job at the time a change is made.

CANCELLATIONS:

A 15% minimum restocking charge will be applied on cancellations of standard products. Cancellations will not be accepted on special or custom products.

CUSTOM OR SPECIALS:

A 50% deposit may be required on special or custom product orders. Returns or cancellations on special or custom products will not be accepted.

RETURNED GOODS:

Returned merchandise will not be accepted for return without twenty (20) days prior written notice and written Returned Goods Authorization (RGA) from Magna. Returned goods will be subject to a minimum 15% restocking and refurbishing charge in addition to shipping costs. (See Warranty policy for defective goods.)

LEAD TIMES:

To current accounts with approved credit, *enterable* orders will be made available (in standard finishes) within 2 to 6 weeks depending upon shipping program: Magna NOW! or Magna FLEX. All orders are subject to current inventories. Leadtimes may vary according to factory volume.

DELIVERY:

Orders will be delivered in accordance with the delivery dates indicated on the order acknowledgment and partial shipments may be made unless the order instructions indicate that an order must be shipped complete.

SHIPPING:

We reserve the right to use our own discretion in selecting routes and freight carriers. We will attempt to meet any special routing requirements that you may have but assume no liability for damages or costs incurred by our inability to do so.

FUEL SURCHARGE:

Effective June 1, 2007, we implemented a fuel surcharge. Please contact customer service or visit our website for current information.

STORAGE:

Storage charges will be charged on orders not accepted or picked up within five (5) days of acknowledged delivery dates unless we are notified thirty (30) days in advance. Storage will be charged at the rate of 2% for the first fifteen (15) days delay and 3% for each fifteen (15) day period thereafter.

FREIGHT CLAIMS:

Before signing a delivery receipt, make certain that goods are inspected for possible damage. If there is visual damage, record the extent of the damage on all copies of the bill of lading before signing. If there is no visual damage to goods that are cartoned or crated, we strongly suggest that the merchandise be unpacked and inspected immediately. If damages are discovered, save the packaging and contact the carrier immediately for inspection. Claims for damages should be filed with the delivering carrier and payment for the goods may not be withheld pending settlement of the carrier damage claims. Magna assumes no liability for freight damage or the workmanship or cost of repairs made by others without prior written authorization.

SPECIFICATIONS:

All published dimensions and weights are approximate and we assume no liability for errors or inaccuracies in product literature. We reserve the right to modify or change product design and/or delete product models without prior notice.

FINISHES:

We take great care in matching color and texture of materials in our product. However, it is impossible to guarantee exact matching in all cases.

7% price increase effective January 1, 2009

Planning Information and Room Layouts

Family of Products

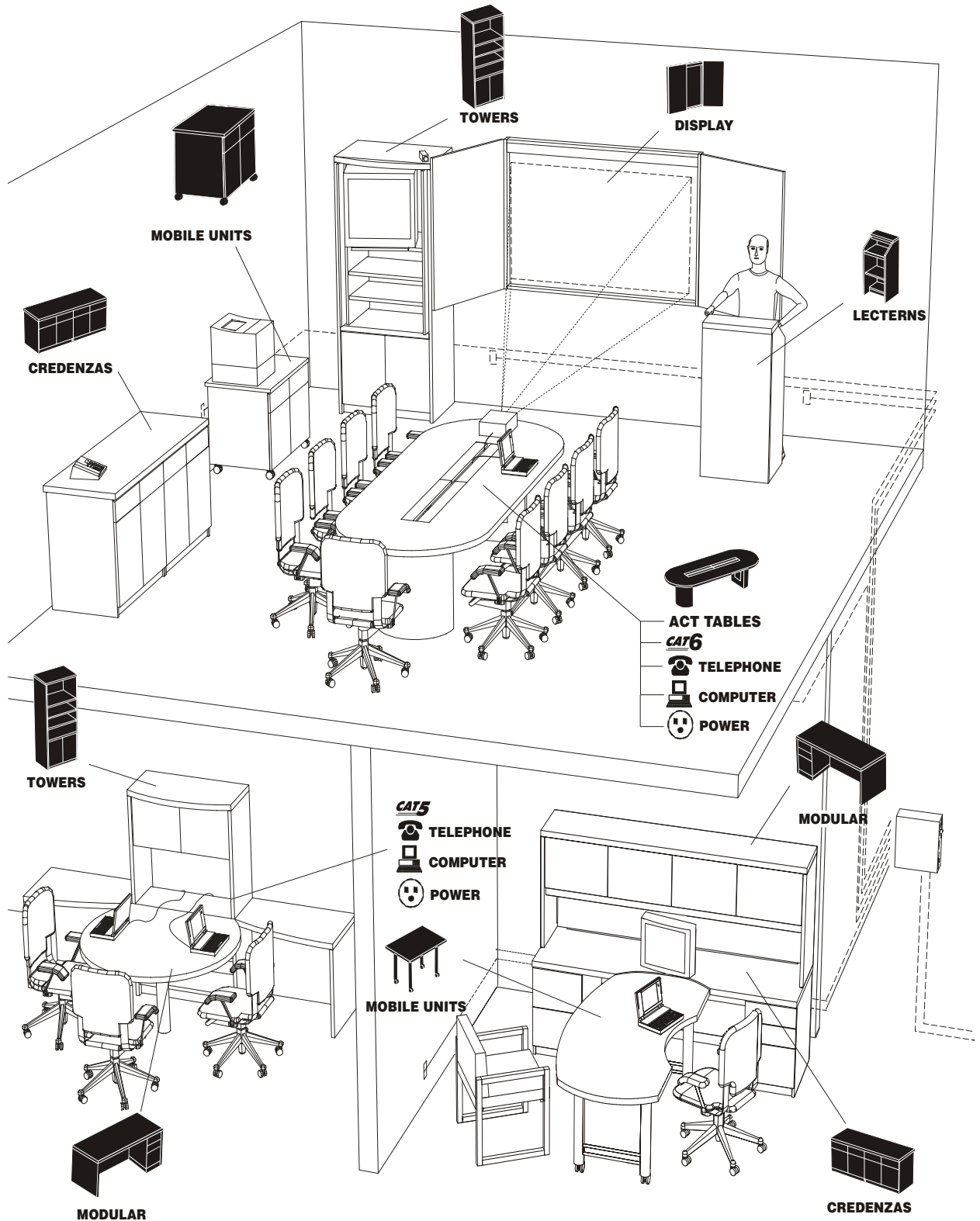

Planning Information and Room Layouts

Conference and ACT table edges

WoodPlus Edge Profiles - all are 3mm wide

WPE
3mm PVC

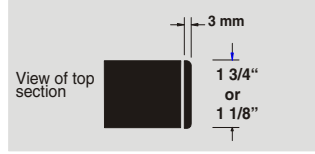

Tops are
1 1/8" thick



*WoodPlus
Smooth*



*WoodPlus
Reeded*

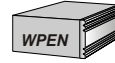

*WoodPlus
Neo Classic*

Tops are
1 3/4" thick



*WoodPlus
Smooth*



*WoodPlus
Reeded*



*WoodPlus
Neo Classic*

Wood Edge Profiles - all are 3mm wide

STD
3mm
Hardwood

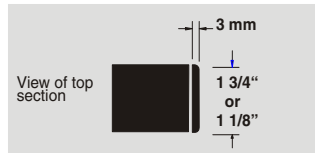

Tops are
1 1/8" thick



*Wood edge
Smooth*



*Wood edge
Reeded*

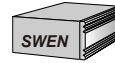

*Wood edge
Neo Classic*

Tops are
1 3/4" thick

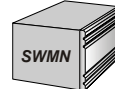
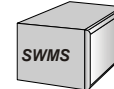

Detailed Wood Edges - all are 3/8" wide

DET
3/8"
Hardwood

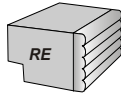
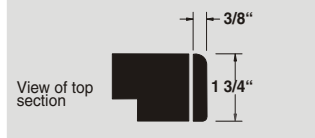

Reeded

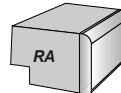

Radius

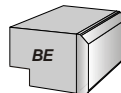

Beveled

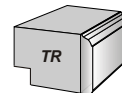

Transitional

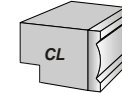

Classic

Reverse Knife Edges - all are 3mm wide

**Reverse
Knife
Edge**

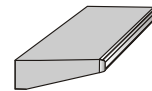
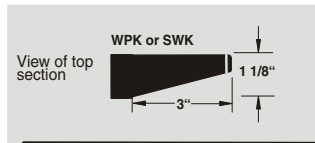

WPK - 3mm PVC

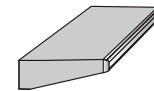

SWK - 3mm wood

Aluminum Edge Profiles - 3mm wide

ALUM
3mm

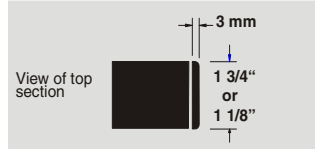

Tops are
1 3/4" thick

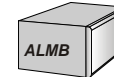

Brushed

Tops are
1 1/8" thick



Brushed

2000 Wood edge - all are 1 3/4" high

2000
2" Hardwood

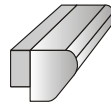
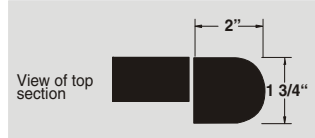

2200

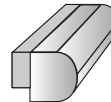

2100

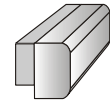

2300

3000 Wood edge - all are 3" wide

3000
3" Hardwood

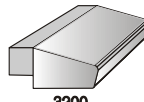
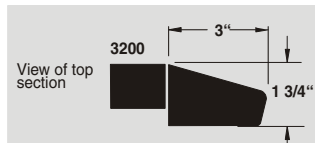

3200

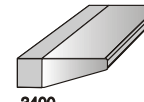
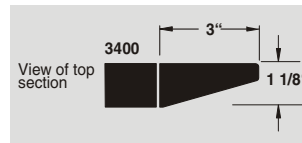

3400

7% price increase effective January 1, 2009

Planning Information and Room Layouts

Reverse knife edge

Knife Edge Information and Pricing

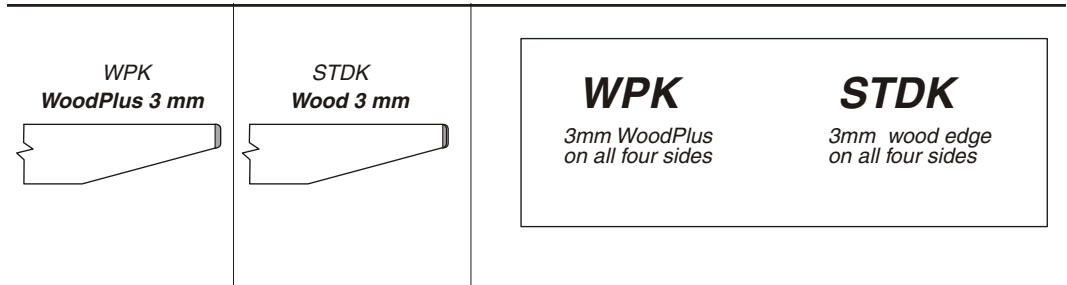

Upcharge for reverse knife edge. Specify either a 3mm WPK PVC edge or a 3mm STDK hardwood edge finish.

Table length or diameter	List Price	
round 58" or less	542	add to the WPE edge price
round 66" or 72"	814	add to the WPE edge price
table 60" long or less	542	add to the WPE edge price
table 72 long	814	add to the WPE edge price
table 84 long	1037	add to the WPE edge price
table 96 long	1077	add to the WPE edge price
table 120 long	1257	add to the WPE edge price
table 144 long	1397	add to the WPE edge price
table 150 long	1397	add to the WPE edge price
table 168 long	1548	add to the WPE edge price
table 180 long	1548	add to the WPE edge price
table 192 long	1701	add to the WPE edge price
table 216 long	1701	add to the WPE edge price
table 240 long	1952	add to the WPE edge price
table 288 long	2388	add to the WPE edge price
Kaizen table	1610	add to the WPE edge price
Wing table	3472	add to the WPE edge price

Reverse Knife edge is on all sides of table top

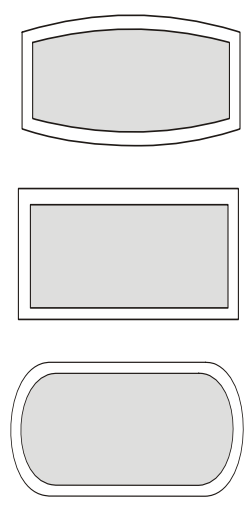
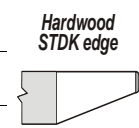
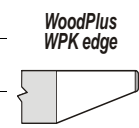

Planning Information and Room Layouts

Table Seating Capacity

Standard Table Top Shapes and Sizes

Shape	Sizes	Seating Capacities
Round or Square	30D.....	2 Seats
	36D.....	2 or 3 Seats
	42D or 48D.....	4 Seats
	54D.....	5 Seats
	58D or 60D.....	5 or 6 Seats
	66D or 72D.....	6 Seats
Egg	5896.....	7 Seats
Rectangular, Arrow	4872.....	6 Seats
	4884.....	6 Seats
	4896.....	6-8 Seats
	48120.....	8-10 Seats
	48144.....	10-12 Seats
	48150.....	10-12 Seats
	48168.....	12 seats
	58120.....	10 Seats
	58144.....	12 Seats
	58150.....	12 Seats
	58168.....	12 Seats
	58180.....	12-14 Seats
	58192.....	14 Seats
	58216.....	16 Seats
	58240.....	18 Seats
	58288.....	20-22 Seats
Boat	4872.....	6 Seats
	4884.....	6 Seats
	4896.....	6-8 Seats
	48120.....	8-10 Seats
	48144.....	10-12 Seats
	48150.....	10-12 Seats
Boat and Delta	48168.....	12 Seats
	58120.....	8-10 Seats
	58144.....	10 Seats
	58150.....	10-12 seats
	58168.....	12 Seats
	58180.....	12-14 Seats
Racetrack	58192.....	14 Seats
	58216.....	16 seats
	58240.....	18 Seats
	58288.....	20-22 Seats
	4872.....	6 Seats
	4884.....	6 Seats
	4896.....	6-8 Seats
	48120.....	8-10 Seats
	48144.....	8-12 Seats
	48150.....	10 Seats
48168.....	10-12 Seats	
Racetrack	58120.....	8-10 Seats
	58144.....	8-10 Seats
	58150.....	10-12 Seats
	58168.....	10-12 Seats
	58180.....	12-14 Seats
	58192.....	12-14 Seats
	58216.....	14-16 Seats
	58240.....	16-18 Seats
	58288.....	20-22 Seats

Examples

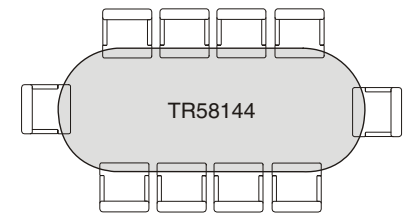
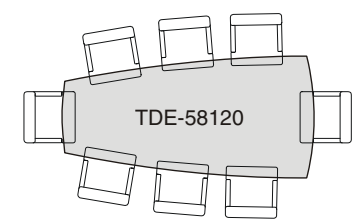
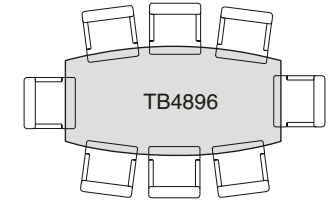
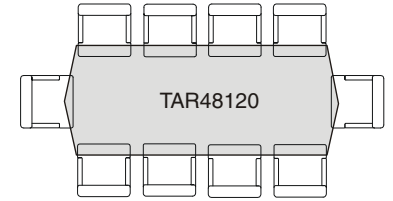
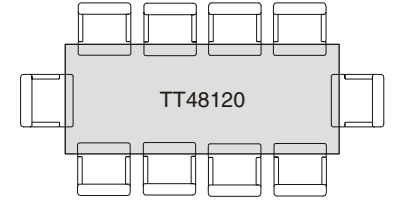
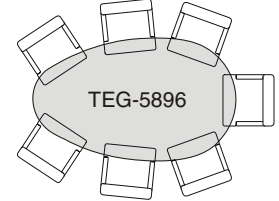
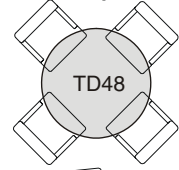

7% price increase effective January 1, 2009

Planning Information and Room Layouts

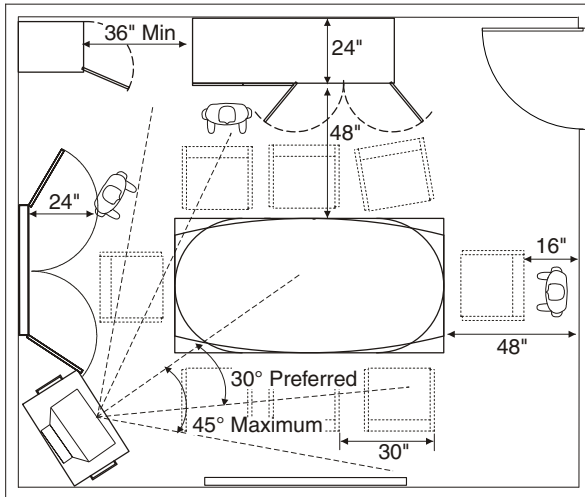

Spacing

- ▶ Allow 48" between table and wall for minimum clearances
- ▶ Allow 60" between table and wall for primary aisle space
- ▶ Allow 24" to walk between chair and wall without turning sideways
- ▶ Allow 30" side to side per chair
- ▶ Allow 32" to 34" between table and back of chair to rise from chair
- ▶ Allow 38" to 40" between table and back of chair to rise from chair when confined by other sitters
- ▶ Allow 56" between table and visual display board with 24" doors (VDB4848)
- ▶ Allow 68" between table and visual display board with 36" doors (VDB4872)
- ▶ Allow 36" bending space to use under counter cabinets or lower shelves of bookcase
- ▶ Allow 72" between table and wall for 24" deep Storage Towers and Credenzas
- ▶ Allow 30" between table and back of chair to use Keyboard
- ▶ Allow 24" to 30" for standing and presenting material on wall
- ▶ TV or Monitor viewing preferred at 30° from center of screen; 45° maximum

Definitions:

Seating Capacity: Chart below shows range from Comfortable Seating to Full Seating

Suggested Room Size: Allows 56" to walk between wall and chair back, 32" to rise from table and 24" to walk

Minimum Room Size: Allows minimum of 48" wall to table to walk sideways between wall and chair back.

<u>Table Size</u>	<u>Seating Capacity</u>	<u>Suggested Room Size</u>	<u>Minimum Room Size</u>
72" (6') Long X 48" Wide	4-6	15' 4" X 13' 4"	14' X 12'
84" (7') Long X 48" Wide	4-6	16' 4" X 13' 4"	15' X 12'
96" (8') Long X 48" Wide	6-8	17' 4" X 13' 4"	16" X 12'
120" (10') Long X 48" Wide	8-10	19' 4" X 13' 4"	18' X 12'
144" (12') Long X 48" Wide	10-12	21' 4" X 13' 4"	20' X 12'
150" (12.5') Long X 48" Wide	10-12	21' 10" X 13' 4"	21' X 12'
168" (14') Long X 48" Wide	12-14	23' 4" X 13' 4"	22' X 12'
120" (10') Long X 58" Wide	8-10	19' 4" X 14' 2"	18' X 12' 10"
144" (12') Long X 58" Wide	10-12	21' 4" X 14' 2"	20' X 12' 10"
150" (12.5') Long X 58" Wide	10-12	22' 4" X 14' 2"	21' X 12' 10"
168" (14') Long X 58" Wide	12-14	23' 4" X 14' 2"	22' X 12' 10"
180" (15') Long X 58" Wide	12-14	24' 4" X 14' 2"	23' X 12' 10"
192" (16') Long X 58" Wide	14-16	25' 4" X 14' 2"	24' X 12' 10"
240" (20') Long X 58" Wide	18-20	29' 4" X 14' 2"	28' X 12' 10"
288" (24') Long X 58" Wide	22-24	33' 4" X 14' 2"	32' X 12' 10"

7% price increase effective January 1, 2009

Planning Information and Room Layouts

Conference Room Typicals

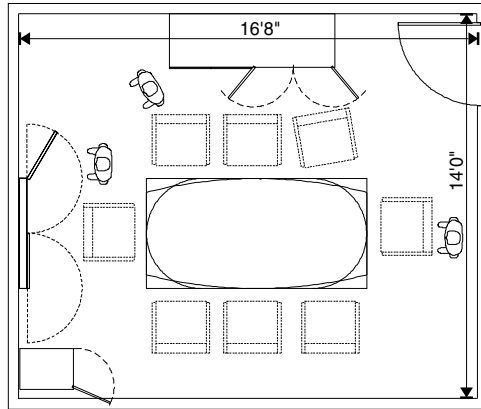

48" x 96" (8') Conference Table
Seating for 6 to 8
Minimum Room: 16'0" x 12'0"
Preferred Room: 17'4" x 13'4"

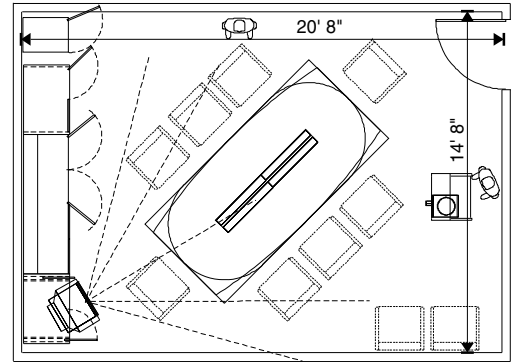

58" x 120" (10') ACT table
Seating for 8 to 10
Minimum Room: 18'0" x 12'10"
Preferred Room: 19'4" x 14'2"

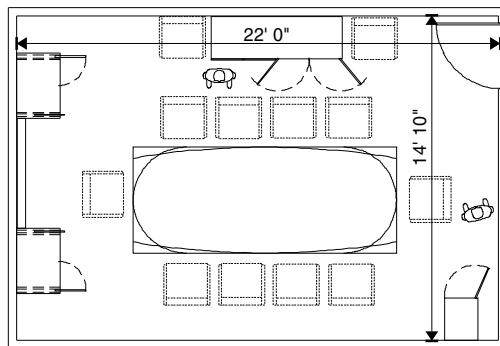

58" x 144" (12') Conference table
Seating for 10 to 12
Minimum Room: 20'0" x 12'10"
Preferred Room: 21'4" x 14'2"

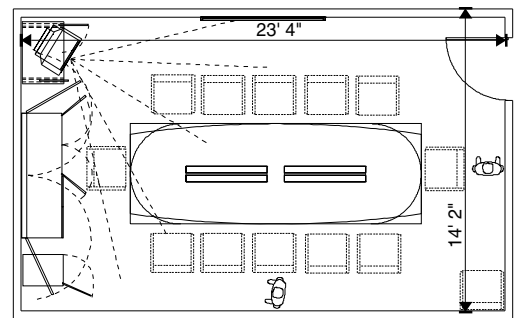

58" x 168" (14') ACT table
Seating for 10 to 12
Minimum Room: 22'0" x 12'10"
Preferred Room: 23'4" x 14'2"

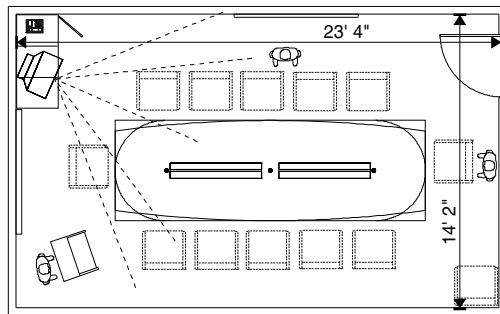

58" x 180" (15') ACT table
Seating for 12 to 14
Minimum Room: 23'0" x 12'10"
Preferred Room: 24'4" x 14'2"

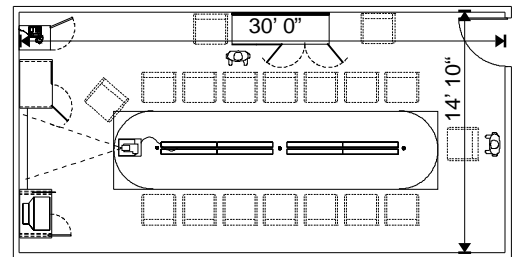

58" x 240" (20') Act Table
Seating for 16 to 18
Minimum Room: 28'0" x 12'10"
Preferred Room: 29'4" x 14'2"

~~7% price increase effective January 1, 2009~~

Specifications - ACT and Kaizen WoodPlus Tables

Product Overview

ACT Technology Tables and Kaizen Articulating Technology Tables accommodate power, voice and data needs through a center utility bay accessed beneath hinged doors in the top surface. The utility bay is easily customized to fit a client's needs. ACT and Kaizen tables are code sensitive with the ability to hard-wire connections to building sources. A qualified electrician is required. Tables are available in laminate with a variety of edge details including PVC, and various hardwood edges. Tables bases are laminate Radius Cube and Half Cylinder. All tables are shipped RTA (ready to assemble).

SPECIFICATION HIGHLIGHTS

All components are available in Magna WoodPlus, WoodPlus XTRA, and Colorplus finishes as well as many standard Pionite or WilsonArt laminates.

Hardwood Edge Banding

All hardwood edge material is select grade and is available in standard finishes. Lyptus wood is available for all hardwood edges on medium to dark finish colors. Lyptus grain pattern is similar to mahogany grain pattern.

Table Tops

All table tops use a three ply balanced construction which consists of an industrial board core surfaced with standard high-pressure laminate with plastic backing sheet .

Table top sections are tite-jointed together. Standard edges of PVC or hardwood are available per the Price List. Microphone grommets are available as options on the ACT and KAIZEN tables.

Leatherlam table tops are available, because of material considerations, please contact customer service.

Special Top Laminates

Special Top Laminates are available on ACT tables. Please contact Customer Service for availability and upcharge.

Table Top Grain Direction

All wood grain laminate table tops have grain running along the length of the table.

Table top sections

Tables 120" (10') and shorter are built with one (1) piece tops.

120" (10') tops can be built with two piece tops.

Tables 144" (12') up to 240" (20') are built with two (2) piece tops.

144" (12') length tops can be built in one piece;

Tables over 240" (20') to 288" (24') are built with three (3) piece tops.

Leatherlam top: maximum length is 96" (8'), maximum width is 48" (4').

Table top End Grain Match

For multiple piece Laminate woodgrain tops (grain along the length of the table), the end grains will match as closely as possible.

Table Top Inlays

Table tops have optional inlays available that are set between the top laminate and the edge material. Inlays are available in Black PVC, Brushed Brass and Satin Chrome at 3mm wide (approximately 1/8") and require the use of the Detailed Wood, 2000 Wood or 3000 Wood edge.

Table Top Hinged Doors

Top hinged doors with 180° hinges allow access to utility bay. Doors are standard with 3mm edge and are available in all WoodPlus, WoodPlus XTRA, and ColorPlus finishes. These table top hinged door most often match the top finish color. Black brush grommet is standard full length of doors.

Utility Bay

Center Utility Bay is black laminate, and standard with wire manager and electrical outlets on each side of bay.

Wire manager is equipped with Faceplate Bezels and blank inserts; quantities based on size. Bezels and inserts are by PASS and SEYMOUR, available through electrical distributors nation-wide. Each bezel may house from 1 to 2 jacks and/or connectors depending on client specifications or requirements.

On the web, go to PASS and SEYMOUR website at www.passandseymour.com/ or check our webpage on inserts at www.magnadesign.com/inserts.html.

Electrical outlets (15 AMP on a 20 AMP circuit) are installed on both sides of the bay; quantities based on size.

All outlets are standard with two hardwired power entries (one for each side of bay) located at one end of the table. For power connection in the center table base, please see options.

Kaizen tables are powered only at the center base.

Power and data remain connected even when table is reconfigured.

Please see ACT table overview pages for quantities and locations of electricals outlets and bezels.

Inserts for faceplate bezels

Bezels and inserts are by PASS and SEYMOUR, available through electrical distributors nation-wide. Each bezel may house from 1 to 2 jacks and/or connectors depending on client specifications or requirements.

On the web, go to PASS and SEYMOUR website at www.passandseymour.com/ or check our webpage on inserts at www.magnadesign.com/inserts.html.

Table Bases

All Half Cylinder and Radius Cube bases are available in standard laminate to match or complement table tops. Radius Cube bases at table ends are 2/3 cube. One power access door in one of the end bases is included. Larger tables have center supports – full cylinder for half cylinder bases and full radius cube for radius cube bases. Additional power access doors are available as options.

~~7% price increase effective January 1, 2009~~

Specifications – WoodPlus Conference Products

Conference Tables, Modular Tables, Cube and Drum Tables

Table tops are available in laminate with a variety of edge details including PVC and various hardwood edges. A variety of table bases are shown ranging from metal pedestal bases to laminate conference table bases. All tables are shipped RTA (ready to assemble). Cube and drum tables are available in laminate with a selection of edge details.

SPECIFICATION HIGHLIGHTS

Laminate

All laminate components are available in Magna WoodPlus / Colorplus finishes as well as the new XTRA WoodPlus finishes and many standard Pionite / Panolam and WilsonArt laminates.

Hardwood

All hardwood edge material is select grade and is available in standard finishes. Lyptus wood is available for all hardwood edges on medium to dark finish colors. Lyptus grain pattern is similar to mahogany grain pattern.

Table Tops

All table tops use a three ply balanced construction which consists of an industrial board core surfaced with standard high-pressure laminate with plastic backing sheet. Fixed table top sections are tite-jointed together. Standard edges of PVC or hardwood are available per the price list.

Leatherlam table tops are available, because of material considerations, please contact customer.

Table Top Grain Direction

All wood grain laminate table tops have grain running along the length of the table.

Table top sections

Tables 120" (10') and shorter are built with one (1) piece tops.

Tables 144" (12') up to 240" (20') are built with two (2) piece tops.

144" (12') length tops can be built in one piece;

Tables over 240" (20') to 288" (24') are built with three (3) piece tops.

Leatherlam top: maximum length is 96" (8'), maximum width is 48" (4').

Table Top End Grain Match

For multiple piece Laminate woodgrain tops (grain along the length of the table), the end grains will match as closely as possible.

Table Top Inlays

Table tops have optional inlays available that are set between the top laminate and the edge material. Inlays are available in Black PVC, Brushed Brass and Satin Chrome at 3mm wide (approximately 1/8") and require the use of the Detailed Wood, 2000 Wood or 3000 Wood edge.

Cylinder, Radius Cube and Panel End Bases

All cylinder, half cylinder, cube and panel end bases are available in standard laminate to match or complement table tops. All half cylinder, full cylinder and radius cube bases are standard with metal stretchers when needed. Laminate Panel End bases come standard with a 3mm edge. Panel end bases include a matching 3/4 height stretcher between all end panels.

Metal Table Bases

Metal bases with rigid construction in various configurations are used for Modular and Mobile tables. Metal bases include round column legs (COL), T-leg (TLEG), 4 prong pedestal (COLX), 3 prong pedestal (COLT), T-leg with 2 vertical columns (TLEG2) and C-leg with wiremanager (CLEG-WM). Bases are finished with Black or Silver Powder Coat .

Slide table bases

SLIDE table is available with two different bases. The 'EC' are available with levelers, casters or a combination of levelers and casters. Finish is Silver. The 'ARCT' base includes a flip top with single release handle, available in silver or black.

Cube and Drum Tables

All cube and drum tables are offered in laminate with 1 3/4" tops and PVC or solid hardwood edges. Detailed edges use solid hardwood edges on the top to match Modular 8.

Adjustable Glides

All table bases except Cube and Drum tables have adjustable glides.

Credenza Cabinets

Cabinet case is finished on all exposed surfaces with the cabinet back inset between the case tops and sides. All doors, cabinet case sides and back are 3/4" thick. Doors and cabinet sides and backs are constructed with vertical grain patterns or are solid ColorPlus finish. Credenza top with wood edge to match the conference room table wood edge is now available for all wood edges and inlays. Open credenza with single row of drawers is also available for use between storage towers.

Pulls

Pulls #10, #12, #13, #14, #15, #18 and #19 for drawer fronts, hinged doors, recycle bins.

Pull #21 is available at an upcharge per pull.

ACT and Kaizen table top doors and BHD Base Hinged Doors do not have pulls.

Locks

Locks are available on hinged doors as an option. Removable lock cylinders provide for keying alike or re-keying in the field.

Specifications – ACT WoodPlus² Tables

WoodPlus² Conference Product Specifications

Product Overview

WoodPlus² Conference products consist of ACT (ACessing Technology) Tables, Conference Tables and Conference Credenzas along with Presentation accessories including Visual Display boards and framed White Boards. WoodPlus² tables are a maximum of 46" wide and 168" long. Top shapes are Bow Ended Rectangle or Boat, Racetrack, Wedge and Egg. ACT Table bases are Half Cylinder, Radius Half Cylinder or Radius Cube bases. Credenzas are offered in Door Storage or Recycling configurations.

SPECIFICATION HIGHLIGHTS

All exposed surfaces shall be Magna WoodPlus² / ColorPlus² laminates. Standard finishes shall include WoodPlus² wood grain patterns, ColorPlus² speckle patterns and ColorPlus² solid colors as described in the finishes section. XTRA WoodPlus² / ColorPlus² finishes are also available as described in the finishes section.

WoodPlus² ACT Technology tables

ACT (Accessing Technology) Tables accommodate power, voice and data needs through a center utility bay accessed beneath hinged doors in the top surface. The utility bay is easily customized to fit a client's needs. ACT tables are also code sensitive with the ability to hard-wire connections to building sources (qualified electrician required). All tables are shipped RTA (ready to assemble).

Tops

All WoodPlus² tops are 1-1/8" thick with a formed edge. WoodPlus² top construction consists of a 48 LB MDF core surfaced with rigid thermoformed polymer-based decorative composite sheet and a balancing backer sheet. ACT table tops include microphone grommets; see Price Catalog for quantity per table size.

Table Top Grain Direction

WoodPlus² ACT and Conference tables are standard with grain running the length of the table.

Table Top End Grain Match

For multiple piece woodgrain tops, the end grains will match as closely as possible.

Edges

WoodPlus² / ColorPlus² horizontal and vertical surfaces come with rounded, soft edges that are a seamless and integrated part of the surface.

Table Top Hinged Doors

Top hinged doors with 180° hinges allow full access to utility bay and match the top finish. Doors have a formed integral edge. Brush grommet is standard full length of doors.

Utility Bay

Center Utility Bay is black laminate, and standard with wire manager and electrical outlets on each side of bay.

Wire manager is equipped with Faceplate Bezels and blank inserts; quantities based on size. Bezels and inserts are by PASS and SEYMOUR, available through electrical distributors nation-wide. Each bezel may house from 1 to 2 jacks and/or connectors depending on client specifications or requirements.

On the web, go to PASS and SEYMOUR website at www.passandseymour.com/ or check our webpage on inserts at www.magnadesign.com/inserts.html.

Electrical outlets (15 AMP on a 20 AMP circuit) are installed on both sides of the bay; quantities based on size. All outlets are standard with two hardwired power entries (one for each side of bay) located at one end of the table. For power connection in the center table base, please see options.

Please see ACT table overview pages for quantities and locations of electricals outlets and face plate bezels.

Inserts for faceplate bezels

Bezels and inserts are by PASS and SEYMOUR, available through electrical distributors nation-wide. Each bezel may house from 1 to 2 jacks and/or connectors depending on client specifications or requirements.

On the web, go to PASS and SEYMOUR website at www.passandseymour.com/ or check our webpage on inserts at www.magnadesign.com/inserts.html.

Half Cylinder and Radius Cube Table Bases

All half cylinder and radius cube bases are available in standard WoodPlus² woodgrain and ColorPlus² finishes. See finish section for available finishes. Radius Cube bases at table ends are 2/3 cube. Half Cylinder and Radius Cube bases have one power access door (hinged door in one of the bases at the table end). Larger tables have center supports – full cylinder for half cylinder bases and full radius cube for radius cube bases. Additional power access doors (hinged door in base at end of table) are available as options.

Adjustable Glides

All table bases have adjustable glides.

~~7% price increase effective January 1, 2009~~

Specifications – WoodPlus² Conference Products

WoodPlus² Conference and Modular Tables

Tops

All WoodPlus2 tops are 1-1/8" thick with a formed edge. WoodPlus2 top construction consists of a 48 LB MDF core surfaced with rigid thermoformed polymer-based decorative composite sheet and a balancing backer sheet.

Table Top Grain Direction

WoodPlus2 ACT and Conference tables are standard with grain running the length of the table.

Edges

WoodPlus2 / ColorPlus2 horizontal and vertical surfaces come with rounded, soft edges that are a seamless and integrated part of the surface.

Cylinder, Half Cylinder and Radius Cube Table Bases

All cylinder, half cylinder and radius Cube bases are available in standard WoodPlus2 woodgrain or ColorPlus2 finishes. Metal stretchers are provided with half cylinder and radius cube bases as needed to support top. Larger tables have center supports – full cylinder for half cylinder bases and full radius cube for radius cube end bases. The radius cube end bases are 2/3 the 'length' of a center radius cube.

Slide table bases

SLIDE table is available with two different bases. The 'EC' are available with levelers, casters or a combination of levelers and casters. Finish is Silver. The 'ARCT' base includes a flip top with single release handle, available in silver or black.

COL Column bases

Metal base with columns uses rigid construction and is finished with Black or Silver Powder Coat.

Adjustable Glides

All table bases have adjustable glides.

Wire Management

Optional Grommets and wire managers are available. Finish is satin black.

WoodPlus2 Credenzas

Tops

All WoodPlus2 tops are 1-1/8" thick with a formed edge. WoodPlus2 top construction consists of a 48 LB MDF core surfaced with rigid thermoformed polymer-based decorative composite sheet and a balancing backer sheet.

Edges

WoodPlus2 / ColorPlus2 horizontal and vertical surfaces come with rounded, soft edges that are a seamless and integrated part of the surface.

Credenza Cabinets

Cabinet case is finished on all exposed surfaces with the cabinet back inset between the case tops and sides. All doors, cabinet case sides and back are 3/4" thick. Vertical grain on the doors, drawer faces, backs and sides.

Pulls

Pulls #10, #12, #13, #14, #15, #18 and #19 are available at no extra charge. Pull #21 is available at an upcharge per pull.

Locks

Locks are available on hinged doors as an option. Removable lock cylinders provide for keying alike or re-keying in the field.

Finishes

WoodPlus2, XTRA WoodPlus2, ColorPlus2 and XTRA ColorPlus2 polymer finishes with formed edges.

WoodPlus2, XTRA WoodPlus2, ColorPlus2 and XTRA ColorPlus2 components are manufactured using thermoformed polymer based, decorative composite sheets in wood grain, speckle and solid patterns. The result is a seamless component; work surface, table top, drawer or door face with exceptional wear and appearance characteristics.

Cleaning and Care

WoodPlus2, XTRA WoodPlus2, ColorPlus2 and XTRA ColorPlus2 may be cleaned with mild cleaning agents that contain no bleach or bleach substitutes. Under no circumstances can acetone or polish remover be used to clean any of the surfaces. Using it will void the warranty on the product and can do considerable damage to the surface.

7% price increase effective January 1, 2009

Finishes - ACT Conference Modular Table Finishes

Table Top Finishes

WoodPlus Colors

- WP-41 Natural Maple
- WP-81 Fusion Maple
- WP-45 Anigre
- WP-04 Solar Oak
- WP-61 Pear
- WP-31 Medium Cherry
- WP-71 Dark Cherry
- WP-73 Cognac
- WP-48 Sipping Seattle Java - 1
- WP-23 Cordovan

WoodPlus XTRA colors

- WP-05 Rift Oak
- WP-15 Midnight - 1
- WP-35 Golden Cherry
- WP-33 Blossom Cherry - 2
- WP-75 Chestnut
- WP-37 Mocha Cherry
- WP-67 Chocolate Pear

Upcharge of \$600 per XTRA finish per order

- 1 - Hi-Brite texture on table tops and worksurfaces
All other surfaces are suede texture.
- 2 - Hi-Lustre texture on table tops and worksurfaces.
All other surfaces are suede texture.

Additional finishes (about 100) from Pionite / Panolam line of woodgrain, solid and patterned laminates are available.

See our website for currently available finishes
www.magnadesign.com/products/finishes/finishes-added.htm

Edges:

- WoodPlus PVC edges in a complimentary or contrasting color
- Hardwood to match available for a one time charge of \$268 List

Leadtime is four to six weeks.

Please contact Customer Service at 800-233-2304 for details and pricing.

Leatherlam top finishes

Available in five standard Leatherlam finishes: Caviar, Chocolate, Bordeaux, Cashmere, Oasis. Minimum upcharge is \$1720 per 4' x 8' top. Only single piece table tops with WPE, STD, DET or Aluminum edges are available. Inlay with DET only. Contact customer service for actual upcharge required.

Special Top Laminates

WilsonArt standard laminates
Pionite standard laminates
Please check with customer service for acceptability of other special top laminates.
Upcharge for each special top laminate is \$150 per finish per order.

Special Top Laminates must meet the following criteria:
Dark solid colors, including Black,
NOT available for tops
Available in 5 x 12 sheets (horizontal grade)

and
available in 4 x 8 sheets (vertical grade).
Acceptable texture is suede or Hi-Brite.
Glossy, Chemsurf finishes are not acceptable.
Acceptable texture compatible with applied

edges.

ACT Table doors in special top laminate \$600 LIST

Table edge finishes

3 mm PVC , WoodPlus Edge

- 1-3/4" thick tops: WPMS, WPMN, WPMR,
- 1-1/8" thick tops: WPES, WPEN, WPER

- WP-41 Natural Maple
- WP-81 Fusion Maple
- WP-45 Anigre
- WP-04 Solar Oak
- WP-05 Rift Oak
- WP-61 Pear
- WP-33 Blossom Cherry
- WP-73 Cognac
- WP-48 Sipping Seattle Java
- WP-75 Chestnut
- WP-31 Medium Cherry
- WP-71 Dark Cherry
- WP-23 Cordovan
- CP-88 Black

Finishes for Hardwood edges:

- 1-3/4" thick tops: SWMS, SWMN, SWMR,
- 1-1/8" thick tops: SWES, SWEN, SWER,

RA. BE. TR. RE. CL,

1000. 1100, 1200.

2000, 2001, 2002, 2003, 2004. 2100. 2200, 3200, 3300, 3400 (as available)

- W-04 Solar Oak
- W-15 Midnight
- W-23 Cordovan
- W-31 Medium Cherry
- W-33 Blossom Cherry
- W-35 Golden Cherry
- W-41 Natural Maple
- W-45 Anigre (color match only)
- W-48 Sipping Seattle Java (color match only)
- W-61 Pear
- W-71 Dark Cherry
- W-73 Cognac
- W-75 Chestnut
- W-81 Fusion Maple (color match only)

Lyptus Hardwood edges

Available for all wood edges listed above:
SWES, SWEN, SWER, SWMS, SWMN, SWMR,
RA. BE. TR. RE. CL,
1000. 1100, 1200.
2000, 2001, 2002, 2003, 2004. 2100. 2200,
3200, 3300, 3400 (as available)

Please use the price shown for the wood edge being ordered. No upcharge for Lyptus wood edge.
Grain is similar to a mahogany grain pattern.
Available in a medium to dark finish color.

Lyptus is a hardwood grown in sustainable forests which matures in about 15 years rather than the 70 or more years required for mahogany and other hardwoods. After harvesting, Lyptus regrows using the same roots and will be ready for harvesting in about 15 years.

7% price increase effective January 1, 2009

Finishes - ACT Conference Modular Table Finishes

Table Base

**CYL (Cylinder), HC, RHC (Half Cylinder),
RC (Radius Cube), PEB (Panel End Base) - 3,
METRO - 3**

WoodPlus Colors

WP-04 Solar Oak
WP-23 Cordovan
WP-31 Medium Cherry
WP-41 Natural Maple
WP-45 Anigre
WP-48 Sipping Seattle Java - 1
WP-61 Pear
WP-71 Dark Cherry
WP-73 Cognac
WP-81 Fusion Maple
CP-76 Espresso
CP-88 Black
CP-98 Slate

WoodPlus XTRA Colors

WP-05 Rift Oak
WP-15 Midnight - 1
WP-33 Blossom Cherry - 2
WP-35 Golden Cherry
WP-37 Mocha Cherry
WP-67 Chocolate Pear
WP-75 Chestnut

- 1 - Table tops have Hi-Brite texture while table bases have suede texture
- 2 - Table tops have Hi-Lustre texture while table bases have suede texture

WilsonArt standard laminates
Pionite standard laminates
ONLY if Available as 'vertical grade' laminate

Vertical finishes (other than Table Top)

**Credenzas, Storage Towers,
Video Towers, Mobile Units**

WoodPlus Colors

WP-04 Solar Oak
WP-23 Cordovan
WP-31 Medium Cherry
WP-41 Natural Maple
WP-45 Anigre
WP-48 Sipping Seattle Java - 1
WP-61 Pear
WP-71 Dark Cherry
WP-73 Cognac
WP-81 Fusion Maple
CP-76 Espresso
CP-88 Black
CP-98 Slate

WoodPlus XTRA Colors

WP-05 Rift Oak
WP-15 Midnight - 1
WP-33 Blossom Cherry - 2
WP-35 Golden Cherry
WP-37 Mocha Cherry
WP-67 Chocolate Pear
WP-75 Chestnut

- 3 - METRO and PEB bases have suede finish

WoodPlus2 and WoodPlus2 XTRA Finishes

WoodPlus2 tops, doors, drawer faces

WP2-23 Cordovan
WP2-31 Medium Cherry
WP2-41 Natural Maple
WP2-45 Anigre
WP2-61 Pear
WP2-71 Dark Cherry
WP2-81 Fusion Maple
CP2 -28 Med Grey Speckle
CP2-38 Beige Speckle.

WoodPlus2 XTRA tops, doors, drawer faces

WP2-18 Shadow Oak
WP2-65 Beech
CP2-72 Shark Gray
CP2-74 Platinum
CP2-78 Bronze
CP2-80 Cashmere Fiber

Upcharge of \$600 per XTRA finish per order

WoodPlus2 verticals

(other than doors, drawer faces)

WP2-23 Cordovan
WP2-31 Medium Cherry
WP2-41 Natural Maple
WP2-45 Anigre
WP2-61 Pear
WP2-71 Dark Cherry
WP2-81 Fusion Maple
CP2-76 Espresso
CP2-98 Slate
CP2-88 Black

Metal Bases

COL, COLX, COLT, CLEG, TLEG, TLEG2

Black or Silver Powder Coat

Specifications subject to change without notice

7% price increase effective January 1, 2009

ACT Table Overview

Overview - ACT Tables

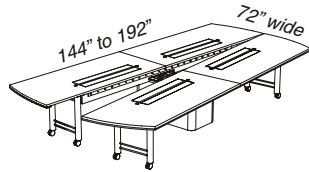

'ACT Kaizen articulating table," on page 34

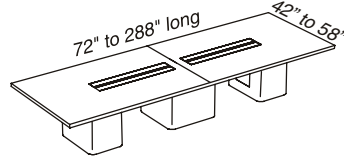

'Rectangular ACT - Radius Cube Base," on page 38

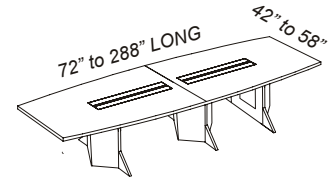

'Arrow ACT - Triangle Base," on page 37

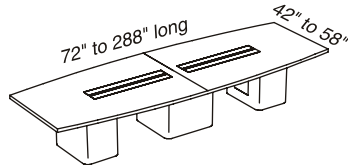

'Boat Shape ACT - Radius Cube Base," on page 40

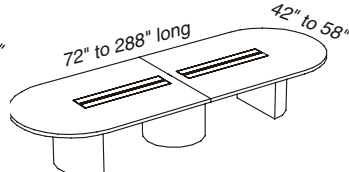

'Racetrack ACT - Half Cylinder Base," on page 42

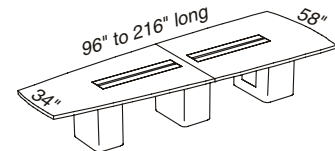

'Racetrack ACT - with Narrow Half Cylinder Base," on page 43

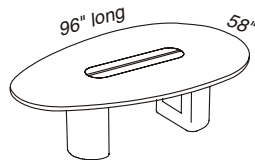

'Egg Shape ACT - Radius Half Cylinder Base," on page 44

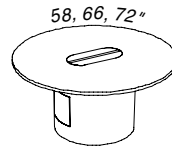

'Delta ACT - Radius Cube Base," on page 44

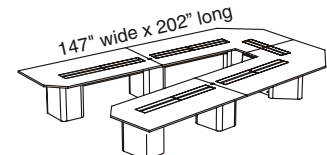

'ACT WING table," on page 46

Overview - ACT WoodPlus2 Tables

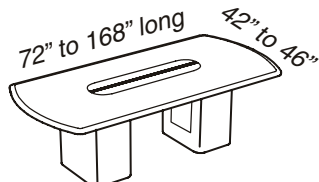

'ACT WoodPlus2 Boat Bow End with Radius Cube Base," on page 48

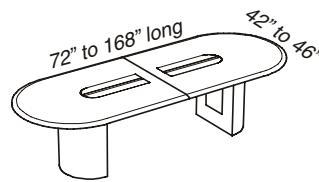

'ACT WoodPlus2 Racetrack with Half Cylinder Base," on page 49

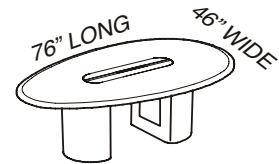

'ACT WoodPlus2 'Egg' with Radius Half Cylinder Base," on page 49

Overview - ACT Base Hinged Door, Brush Grommet details

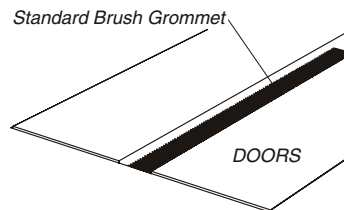
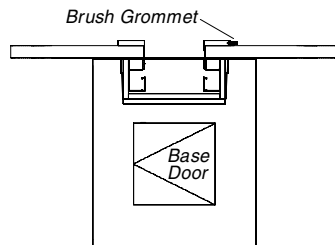

7% price increase effective January 1, 2009

ACT Table Overview

Overview - ACT Table Shapes

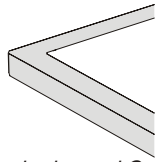

Standard eased Corner

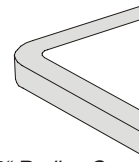

C3R -3" Radius Corner Option

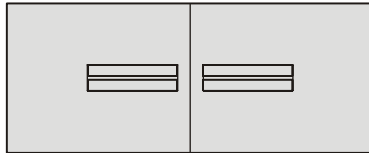

Rectangular - 58 x 150

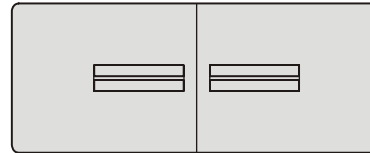

Rectangular - 58 x 150 with C3R

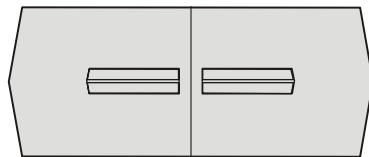

Arrow - 58 x 150

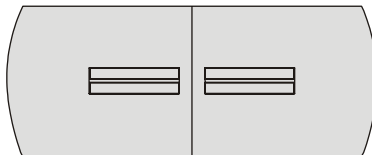

Rectangular with Bow End option - 58 x 150

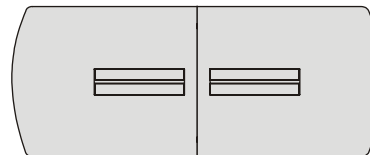

Rectangular Bow End & C3R - 58 x 150

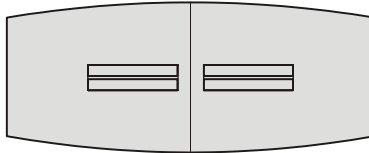

Boat Shape - 58 x 150

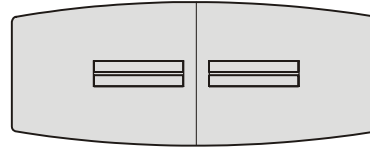

Boat Shape - 58 x 150 with C3R

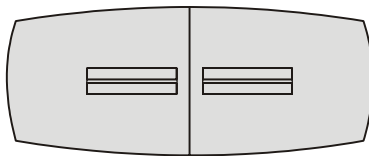

Boat Shape - 58 x 150 with Bow End Option

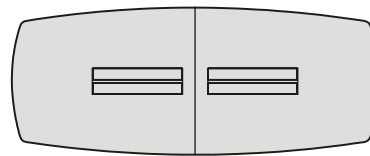

Bow End Boat Shape - 58 x 150 with C3R

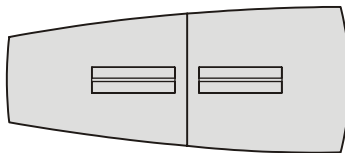

Delta Shape - 58 x 144

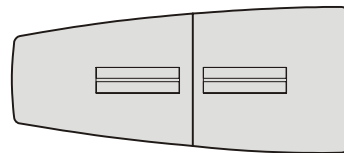

Delta Shape - 58 x 144 with C3R

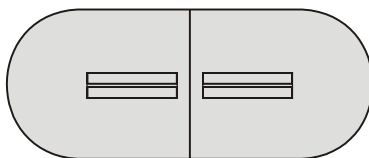

Racetrack Shape - 58 x 150

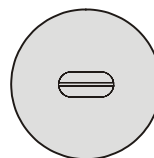

Round Shape - 58" diameter

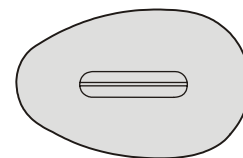

"Egg" Shape - 58 x 96

7% price increase effective January 1, 2009

ACT Table Overview

Overview - ACT Top Door and Base Configurations

42" - 48" wide Tables

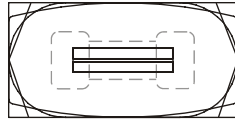

Table sizes: 42 and 48" wide
72, 84 and 96" long
Single pair of Access doors

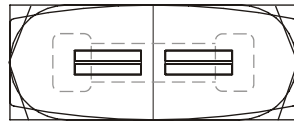

Table size: 42 and 48" wide and 120" long
Two pair of Access doors

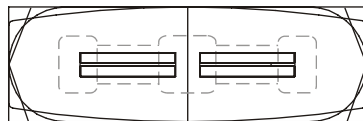

Table sizes: 42 and 48" wide 144 and 150" long
Two pair of Access doors, and center base

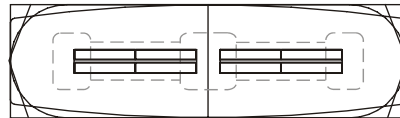

Table size: 42 and 48" wide and 168" long
Four pair of Access doors, center base

58" Wide Tables

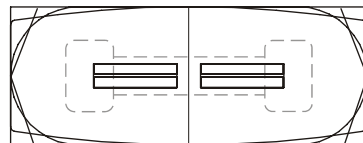

Table sizes: 58120, 58144 and 58150
Two pair of Access doors

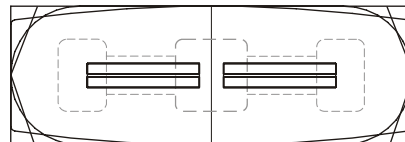

Table size: 58168
Two pair of Access doors, and center base

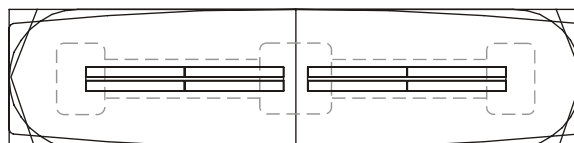

Table sizes: 58180, 58192, 58216 and 58240
Four pair of Access doors, center base

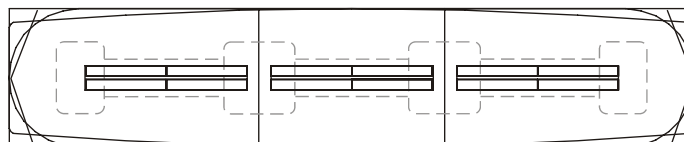

Table size: 58288
Six pair of Access doors, two center bases

58" Wide Egg Shape Table

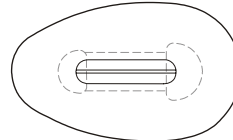

Table size: 5896
Single pair of Access doors

58" Wide Delta Shape Tables

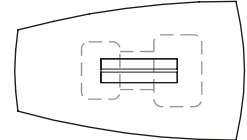

Table size: 5896 and 58120
Single pair of Access doors

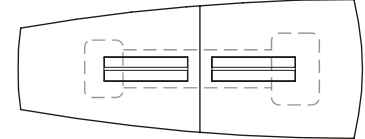

Table sizes: 58144 and 58150
Two pair of Access doors

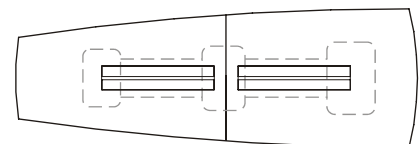

Table size: 58168
Two pair of Access doors, Center base

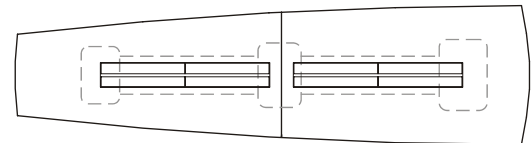

Table sizes: 58192 and 58216
Four pair of Access doors, Center base

Round Tables

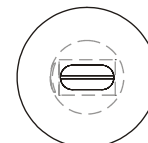

Table size: 58" diameter
Single pair of Access doors

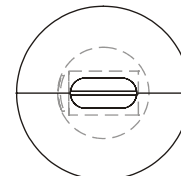
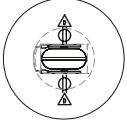

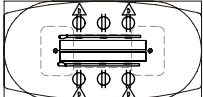
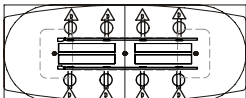
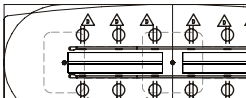

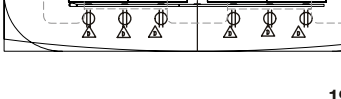
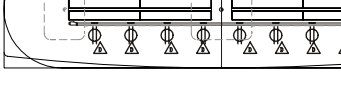
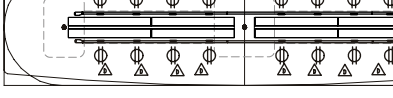
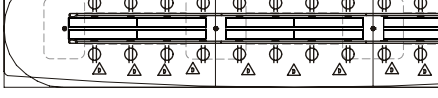

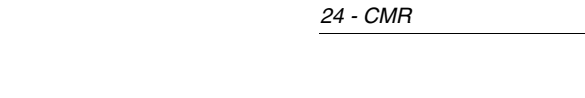

Table size: 66 and 72" diameter,
2 piece top,
Single pair of Access doors

7% price increase effective January 1, 2009

ACT Table Overview

Overview - ACT Table MO20 Electrical Packages

	<i>Description</i>	<i>Model Number</i>	<i>Duplexes</i>	<i>Outlets Total</i>	<i>Face Plate Bezels</i>	<i>Microphone Grommets</i>	<i>Seating Capacity</i>
	Electrical Package 58, 66 or 72" Round	MO20-58D MO20-66D MO20-72D	2 4 4	4 8 8	2 4 4	None None None	5 6 6
	72" Long Table	MO20-72	4	8	4	None	6
	84" Long	MO20-84	4	8	4	None	6
	96" Long	MO20-96	6	12	4	2 - optional	6-8
	120" Long	MO20-120	8	16	8	3 - optional	8-10
	144" Long	MO20-144	8	16	8	3 - optional	8-10
	150" Long	MO20-150	8	16	8	3 - optional	8-10
	168" Long	MO20-168	12	24	12	3 - optional	10-12
	180" Long	MO20-180	12	24	12	3 - optional	10-12
	192" Long	MO20-192	12	24	12	3 - optional	12-14
	216" Long	MO20-216	16	32	16	3 - optional	14-16
	240" Long	MO20-240	16	32	16	3 - optional	16-18
	288" Long	MO20-288	24	48	20	4 - optional	20-22

ACT Tables are equipped with two Power Entry cables and a Base Hinged Door (BHD) at one end base of each table. For Delta or Egg table, the large end will be used.
A qualified electrician is required to hardwire the power cable to the floor connection.

7% price increase effective January 1, 2009

ACT Table Overview

Overview - ACT Table MO20 Electrical Details

Electrical connection:

ACT Tables are equipped with two Power Entry cables and a Base Hinged Door (BHD) at one end of each table.

For Delta and Egg tables, the large end will be used

A qualified electrician is required to hardwire the power cable to the floor connection.

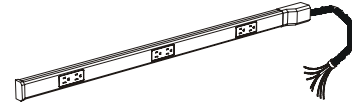

MO20-96 (for 96" long table) includes 2 each of unit shown- 3 duplex each side of utility bay and Hardwire (not plug-in) Power Entry

Table Size	Outlets	Faceplate Bezels
60 dia	2 duplex	2 bezels
72/84	4 duplex	4 bezels
96	6 duplex	4 bezels
120	8 duplex	8 bezels
144	8 duplex	8 bezels
150	8 duplex	8 bezels
168	12 duplex	8 bezels
180	12 duplex	12 bezels
192	12 duplex	12 bezels
216	16 duplex	16 bezels
240	16 duplex	16 bezels
288	24 duplex	20 bezels

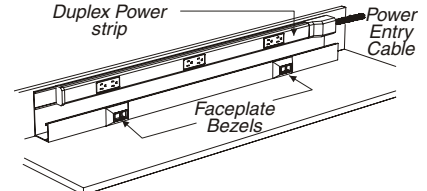

Complete electrical and data access assembly in utility bay (view of one side). Shipped with pigtail ready for hardwiring.

Each Bezel holds one 2A insert

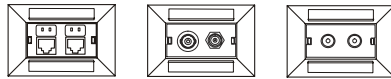

Bezels 2A with inserts

Faceplate Bezels are supplied with a BLANK 2A filler insert.

Insert Information:

Inserts fit into the Bezel supplied with ACT tables, and are available from any national electrical supplier.

Pass and Seymour manufactures the Bezels used in our ACT tables.

ACT tables are shipped with Blank inserts.

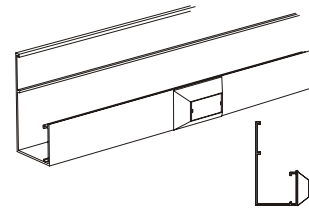

ACT Tables include Wire management and Faceplate Bezels with blank 2A inserts

7% price increase effective January 1, 2009

ACT Table Overview

Optional Plug end electrical for ACT tables

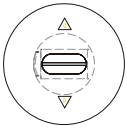
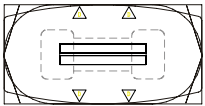
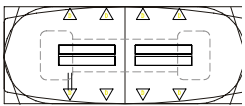
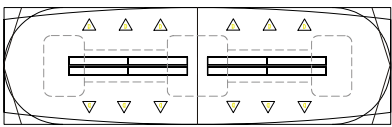
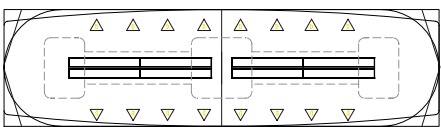
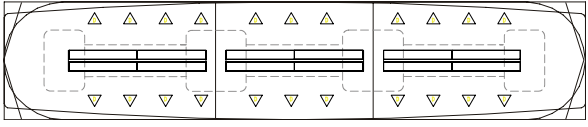
	Table length	Duplexes	Qty	Plug end model	List Price add	Notes
	58 dia	4	2	AC-PLUG-2-24	250	
	66 dia	4	2	AC-PLUG-2-24	250	
	72 dia	4	2	AC-PLUG-2-24	250	
	72	6	2	AC-PLUG-3-36	250	
	84	6	2	AC-PLUG-3-36	250	
	96	6	2	AC-PLUG-3-36	250	
	120	10	2	AC-PLUG-5-60	250	Includes 2nd BHD base hinged door, for one at each end of table, or includes BHD in center with access added to utility bay.
	144	12	4	AC-PLUG-3-36	645	
	150	12	4	AC-PLUG-3-36	645	
	168	12	4	AC-PLUG-3-36	645	Includes 2nd BHD base hinged door, for one at each end of table, or includes BHD in center with access added to utility bay.
	180	16	4	AC-PLUG-4-48	805	
	192	16	4	AC-PLUG-4-48	805	
	216	20	4	AC-PLUG-5-60	805	Includes 2nd BHD base hinged door, for one at each end of table, or includes BHD in center with access added to utility bay.
	240	24	4	AC-PLUG-6-72	945	
	288	24	6	AC-PLUG-4-48	1058	Includes 2nd BHD base hinged door, one at each base in the center of table and access from the utility bay to the center bases.

Plug end powerstrips are UL labeled, 15 Amp with 6' long cord.

- AC-PLUG-2-24 has two outlets and is 24" long.
- AC-PLUG-3-36 has three outlets and is 36" long.
- AC-PLUG-4-48 has four outlets and is 48" long.
- AC-PLUG-5-60 has five outlets and is 60" long.
- AC-PLUG-6-72 has six outlets and is 72" long.

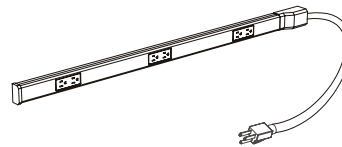

AC-PLUG-3-36 shown

7% price increase effective January 1, 2009

ACT Table Overview

Boat TB shaped top table base information

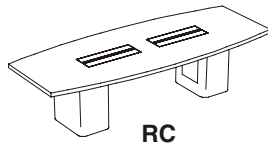

RC

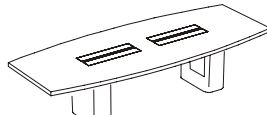

RCN

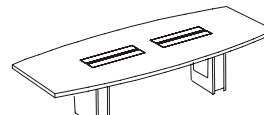

METRO

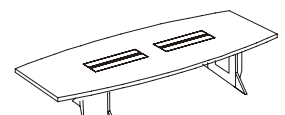

TRI

Wide	Long	(A) MLC	RC base (C)				RCN base (C)				METRO base (C)				TRI base (C)			
			Qty	End	Center	IFE	Qty	End	Center	IFE	Qty	End	Center	IFE	Qty	End	Center	IFE
42	72	20	2	9x18		14	2	8x18		15	2	6x18		16	2	8x30		14
42	84	24	2	9x18		18	2	8x18		20	2	6x18		18	2	8x30		18
42	96	24	2	12x18		18	2	8x18		20	2	6x18		18	2	8x30		20
42	120	24	2	12x18		18	2	8x18		20	2	6x18		18	2	8x30		20
42	144	24	3	12x16	18x18	18	3	8x16	12x18	20	3	6x16	8x18	18	3	8x30	15x30	20
42	150	24	3	12x16	18x18	18	3	8x16	12x18	20	3	6x16	8x18	18	3	8x30	15x30	20
42	168	24	3	12x16	18x18	18	3	8x16	12x18	20	3	6x16	8x18	18	3	8x30	15x30	20
46	72	25	2	14x20		18	2	8x20		21	2	6x20		22	2	8x30		21
46	84	25	2	14x20		18	2	8x20		21	2	6x20		22	2	8x30		21
46	96	25	2	14x20		18	2	8x20		21	2	6x20		22	2	8x30		21
46	120	25	2	14x20		18	2	8x20		21	2	6x20		22	2	8x30		21
46	144	25	3	14x18	20x20	18	3	8x18	14x20	21	3	6x20	8x20	22	3	8x30	15x30	21
46	150	25	3	14x18	20x20	18	3	8x18	14x20	21	3	6x20	8x20	22	3	8x30	15x30	21
46	168	25	3	14x18	20x20	18	3	8x18	14x20	21	3	6x20	8x20	22	3	8x30	15x30	21
48	72	20	2	12x22		14	2	8x22		15	2	6x22		16	2	8x30		18
48	84	24	2	12x22		18	2	8x22		20	2	6x22		18	2	8x30		18
48	96	24	2	12x22		18	2	8x22		20	2	6x22		18	2	8x30		18
48	120	24	2	16x22		18	2	8x22		20	2	6x22		18	2	8x30		18
48	144	24	3	14x20	24x24	18	3	8x20	14x24	20	3	6x20	8x24	18	3	8x30	15x30	18
48	150	24	3	14x20	24x24	18	3	8x20	14x24	20	3	6x20	8x24	18	3	8x30	15x30	18
48	168	24	3	14x20	24x24	18	3	8x20	14x24	20	3	6x20	8x24	18	3	8x30	15x30	18
58	120	26	2	20x28		20	2	8x28		22	2	6x28		20	2	12x34		24
58	144	26	2	20x28		20	3	8x24	16x30	22	3	6x24	8x30	20	2	12x34		24
58	150	26	2	20x28		20	3	8x24	16x30	22	3	6x24	8x30	20	2	12x34		24
58	168	26	3	16x24	30x30	20	3	8x24	16x30	22	3	6x24	8x30	20	3	12x34	22x34	24
58	180	26	3	16x24	30x30	20	3	8x24	16x30	22	3	6x24	8x30	20	3	12x34	22x34	24
58	192	26	3	16x24	30x30	20	3	8x24	16x30	22	3	6x24	8x30	20	3	12x34	22x34	24
58	216	28	3	16x24	30x30	20	3	8x24	16x30	24	3	6x24	8x30	24	3	12x34	22x34	24
58	240	28	3	16x24	30x30	20	3	8x24	16x30	24	3	6x24	8x30	24	3	12x34	22x34	24
58	288	28(B)	4	16x24	30x30	20	4	8x24	16x30	24	4	6x24	8x30	24	4	12x34	22x34	24

(A) - MLC - center of the monument locaton is this distance from the end of the table

(B) - MLC - center base monument locaton is 104" or 8' 8" from the end of the table

(C) - IFE - Inset From End - how far is the base from the end of the table

Monument cutout for

RC Radius Cube and RCN Radius Cube Narrow bases is 6" less in each dimension. Exception for RC or RCN bases 8" or 9" long.

METRO bases at 6" wide is 3.75", at 8" wide is 5.75". For length, deduct 4" from the length of the base.

TRI end bases at 28 long, opening is 5" diameter, TRI center bases at 28" long, opening is 7".

TRI end bases at 34 long, opening is 7" diameter, TRI center bases at 34" long, opening is 7".

7% price increase effective January 1, 2009

ACT Table Overview

Boat TB shaped top table base information

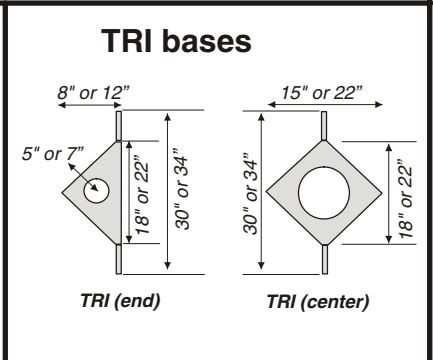
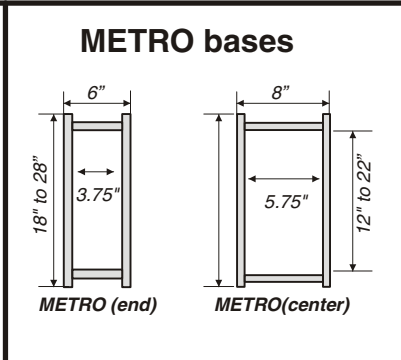
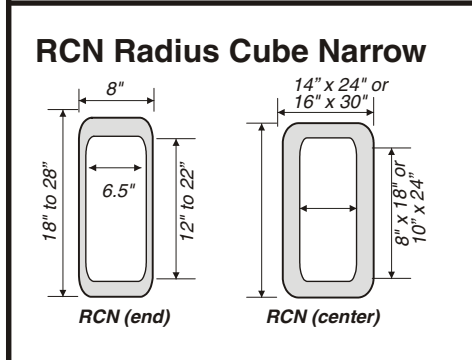
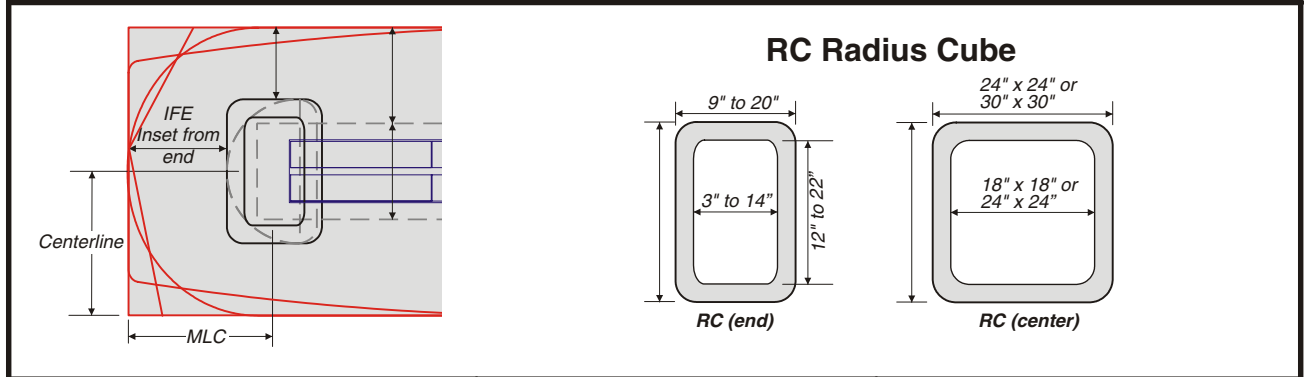
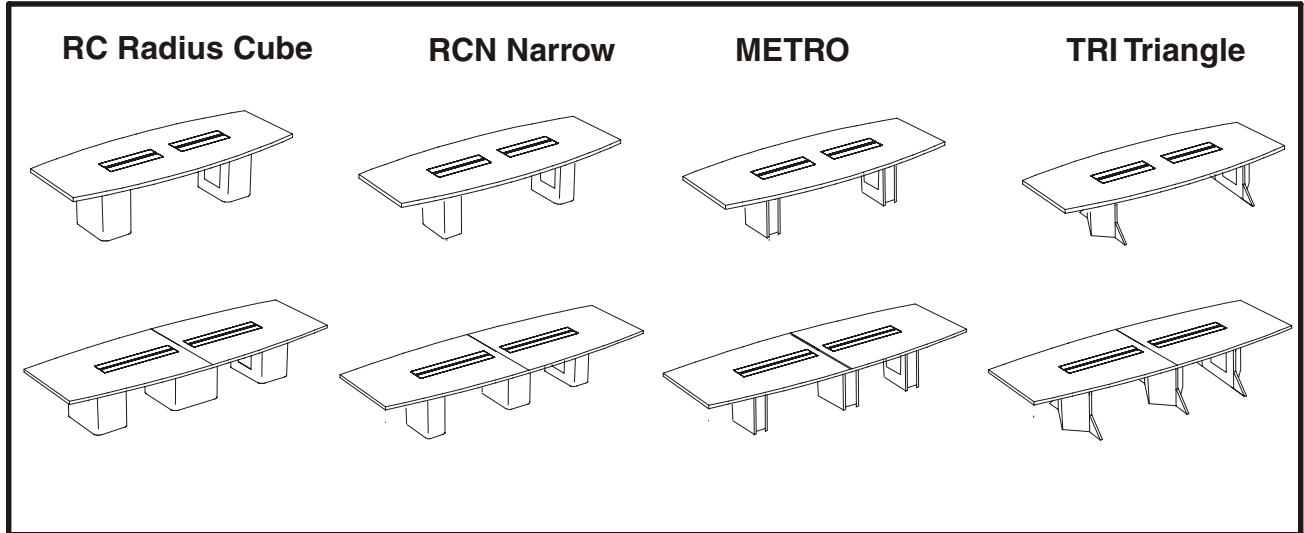

7% price increase effective January 1, 2009

ACT Table Overview

Rectangle TT and Arrow TAR table base information

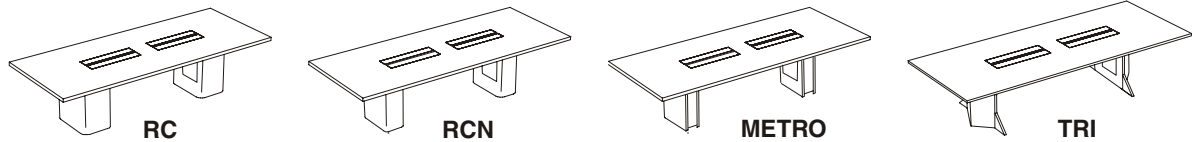

		(A)	RC base (C)				RCN base (C)				METRO base (C)				TRI base (C)			
Wide	Long	MLC	Qty	End	Center	IFE	Qty	End	Center	IFE	Qty	End	Center	IFE	Qty	End	Center	IFE
42	72	24	2	12x18		18	2	8x18		20	2	6x18		21	2	8x30		18
42	84	24	2	12x18		18	2	8x18		20	2	6x18		21	2	8x30		18
42	96	24	2	12x18		18	2	8x18		20	2	6x18		21	2	8x30		18
42	120	24	2	12x18		18	2	8x18		20	2	6x18		21	2	8x30		18
42	144	24	3	12x18	18x18	18	3	8x18	12x18	20	3	6x18	8x18	21	3	8x30	15x30	18
42	150	24	3	12x18	18x18	18	3	8x18	12x18	20	3	6x18	8x18	21	3	8x30	15x30	18
42	168	24	3	12x18	18x18	18	3	8x18	12x18	20	3	6x18	8x18	21	3	8x30	15x30	18
46	72	25	2	14x20		18	2	8x20		21	2	6x20		22	2	8x30		21
46	84	25	2	14x20		18	2	8x20		21	2	6x20		22	2	8x30		21
46	96	25	2	14x20		18	2	8x20		21	2	6x20		22	2	8x30		21
46	120	25	2	14x20		18	2	8x20		21	2	6x20		22	2	8x30		21
46	144	25	3	14x20	20x20	18	3	8x20	14x20	21	3	6x20	8x20	22	3	8x30	15x30	21
46	150	25	3	14x20	20x20	18	3	8x20	14x20	21	3	6x20	8x20	22	3	8x30	15x30	21
46	168	25	3	14x20	20x20	18	3	8x20	14x20	21	3	6x20	8x20	22	3	8x30	15x30	21
48	72	24	2	16x24		18	2	8x24		22	2	6x24		23	2	8x30		18
48	84	24	2	16x24		18	2	8x24		22	2	6x24		23	2	8x30		18
48	96	24	2	16x24		18	2	8x24		22	2	6x24		23	2	8x30		18
48	120	24	2	16x24		18	2	8x24		22	2	6x24		23	2	8x30		18
48	144	24	3	16x24	24x24	18	3	8x24	14x24	22	3	6x24	8x24	23	3	8x30	15x30	18
48	150	24	3	16x24	24x24	18	3	8x24	14x24	22	3	6x24	8x24	23	3	8x30	15x30	18
48	168	24	3	16x24	24x24	18	3	8x24	14x24	22	3	6x24	8x24	23	3	8x30	15x30	18
58	120	30	2	20x30		20	2	8x30		26	2	6x30		26	2	12x34		24
58	144	30	2	20x30		20	2	8x30		26	2	6x30		26	2	12x34		24
58	150	30	2	20x30		20	2	8x30		26	2	6x30		26	2	12x34		24
58	168	30	3	20x30	30x30	20	3	8x30	16x30	26	3	6x30	8x30	26	3	12x34	22x34	24
58	180	30	3	20x30	30x30	20	3	8x30	16x30	26	3	6x30	8x30	26	3	12x34	22x34	24
58	192	30	3	20x30	30x30	20	3	8x30	16x30	26	3	6x30	8x30	26	3	12x34	22x34	24
58	216	30	3	20x30	30x30	20	3	8x30	16x30	26	3	6x30	8x30	26	3	12x34	22x34	24
58	240	30	3	20x30	30x30	20	3	8x30	16x30	26	3	6x30	8x30	26	3	12x34	22x34	24
58	288	30(B)	4	20x30	30x30	20	4	8x30	16x30	26	4	6x30	8x30	26	4	12x34	22x34	24

(A) - MLC - center of the monument location is this distance from the end of the table

(B) - MLC - center base monument location is 104" or 8' 8" from the end of the table

(C) - IFE - Inset From End - how far is the base from the end of the table

Monument cutout for

RC Radius Cube and RCN Radius Cube Narrow bases is 6" less in each dimension. Exception for RC or RCN bases 8" or 9" long
METRO bases at 6" wide is 3.75", at 8" wide is 5.75". For length, deduct 4" from the length of the base.

TRI end bases at 28 long, opening is 5" diameter, TRI center bases at 28" long, opening is 7".

TRI end bases at 34 long, opening is 7" diameter, TRI center bases at 34" long, opening is 7".

7% price increase effective January 1, 2009

ACT Table Overview

Rectangle TT and Arrow TAR table base information

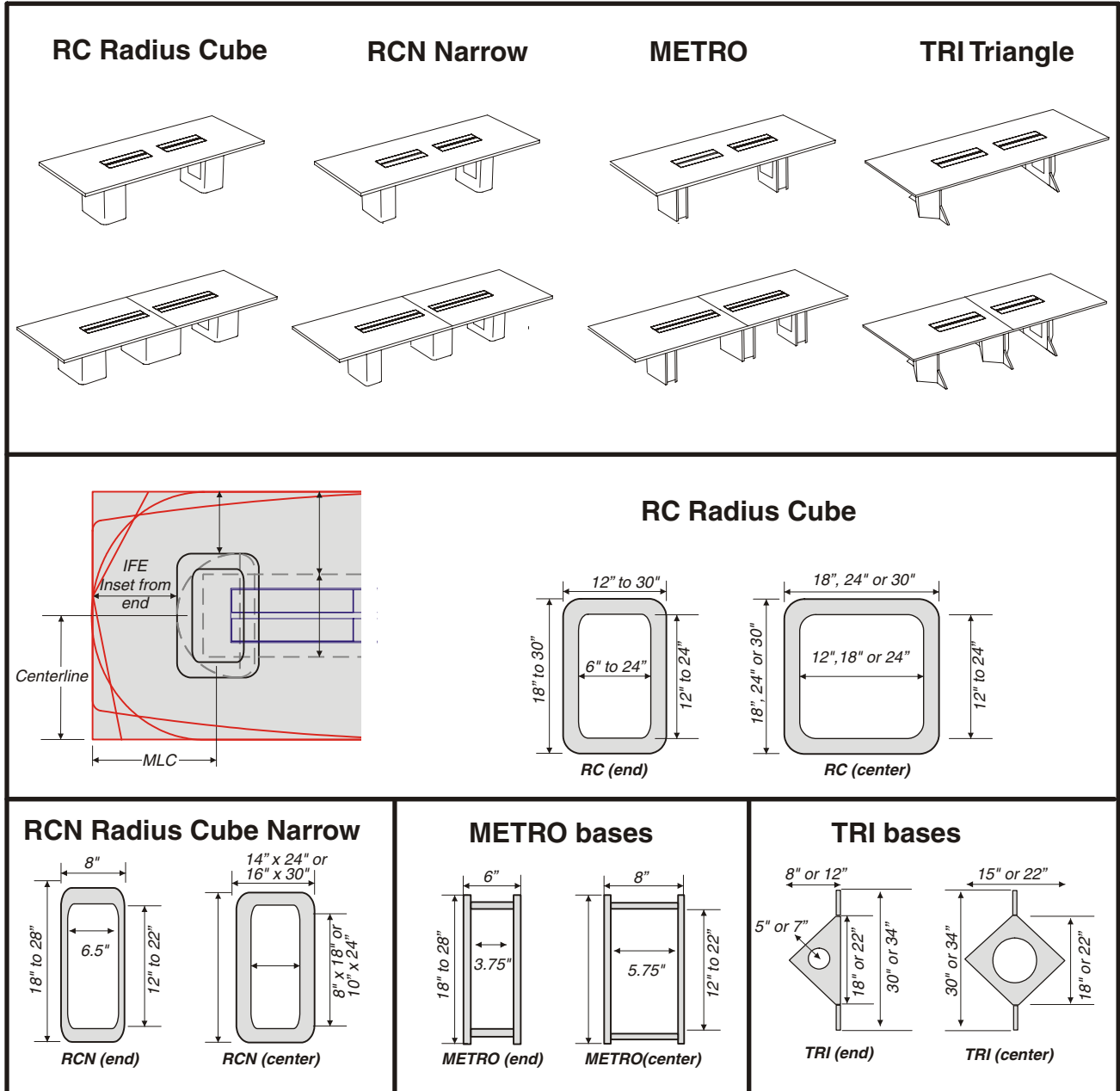

7% price increase effective January 1, 2009

ACT Table Overview

Racetrack TR table base information

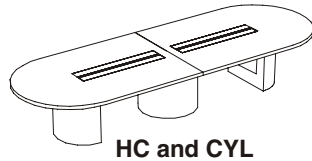
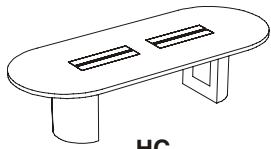

Wide	Long	(A) MLC	HC base			(C) IFE
			Qty	End	Center	
42	72	24	2	10x18		18
42	84	24	2	10x18		18
42	96	24	2	10x18		18
42	120	24	2	10x18		18
42	144	24	3	10x18	18x18	18
42	150	24	3	10x18	18x18	18
42	168	24	3	10x18	18x18	18
46	72	25	2	11x20		18
46	84	25	2	11x20		18
46	96	25	2	11x20		18
46	120	25	2	11x20		18
46	144	25	3	11x20	20x20	18
46	150	25	3	11x20	20x20	18
46	168	25	3	11x20	20x20	18
48	72	24	2	13x24		18
48	84	24	2	13x24		18
48	96	24	2	13x24		18
48	120	24	2	13x24		18
48	144	24	3	13x24	24x24	18
48	150	24	3	13x24	24x24	18
48	168	24	3	13x24	24x24	18
58	120	30	2	16x30		20
58	144	30	2	16x30		20
58	150	30	2	16x30		20
58	168	30	3	16x30	30x30	20
58	180	30	3	16x30	30x30	20
58	192	30	3	16x30	30x30	20
58	216	30	3	16x30	30x30	20
58	240	30	3	16x30	30x30	20
58	288	30(B)	4	16x30	30x30	20

HC at ends, CYL in center

HC at ends

HC (end)

CYL in center

CYL (center)

- (A) - MLC - center of the monument location is this distance from the end of the table
- (B) - MLC - center base monument location is 104" or 8' 8" from the end of the table
- (C) - IFE - Inset From End - how far is the base from the end of the table

Monument cutout for

HC Half Cylinder bases are 4" less in length and 6" less in width.

CYL Full Cylinder bases are 6" less in each dimension

7% price increase effective January 1, 2009

ACT Table Overview

Delta TDE table base information

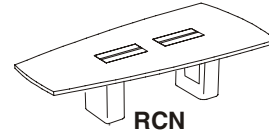
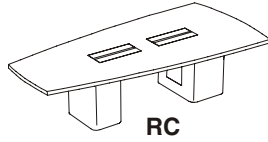

Wide	Long	MLC (A)		RC base (C)					RCN base (C)						
		Small	Big	Qty	Small	IFE	Big	IFE	Center	Qty	Small	IFE	Big	IFE	Center
58	96	35	28	2	14x20	28	20x30	18		2	8x20	31	16x30	20	
58	120	35	28	2	14x20	28	20x30	18		2	8x20	31	16x30	20	
58	144	35	28	2	14x20	28	20x30	18		2	8x20	31	16x30	20	
58	150	35	28	2	14x20	28	20x30	18		2	8x20	31	16x30	20	
58	168	35	28	3	14x20	28	20x30	18	30x30	3	8x20	31	16x30	20	16x30
58	180	35	28	3	14x20	28	20x30	18	30x30	3	8x20	31	16x30	20	16x30
58	192	35	28	3	14x20	28	20x30	18	30x30	3	8x20	31	16x30	20	16x30
58	216	35	28	3	14x20	28	20x30	18	30x30	3	8x20	31	16x30	20	16x30

(A) - MLC - center of the monument locaton from the end of the table - SMALL is the small end of the table, BIG is the big end of the table.

(C) - IFE - Inset From End - how far is the base from the end of the table

Monument cutout for

RC Radius Cube and RCN Radius Cube Narrow bases is 6" less in each dimension. Exception for RC or RCN bases 8" or 9" long.

<p>RC Radius Cube RCN Narrow</p>	<p>RC Radius Cube</p>
	<p>RCN Radius Cube Narrow</p>

7% price increase effective January 1, 2009

ACT Table Overview

Round TD table base information

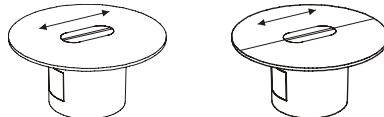

Diameter	(A)		CYL base		(C)
	MLC	Qty	Diameter	IFE	
58	29	1	30	14	
66	33	1	36	15	
72	36	1	36	18	

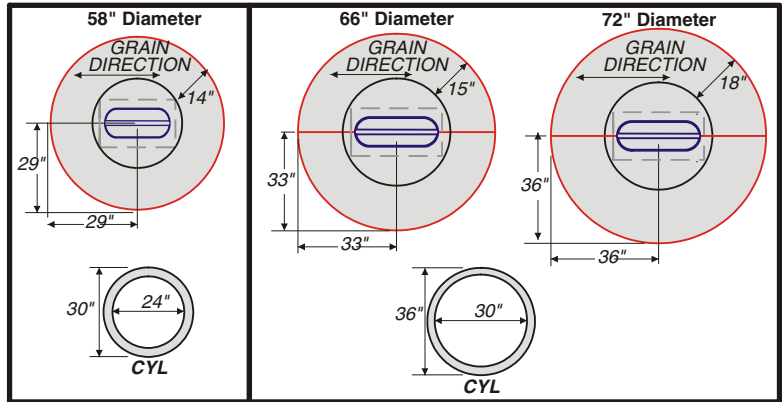

(A) - MLC - center of the monument locaton is this distance from the edge of the table

(C) - IFE - Inset From End - how far is the base from the edge of the table

Monument cutout for CYL Full Cylinder bases are 6" less in each dimension

Egg shaped TEG table base information

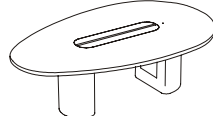

	(A)		RHC base			(C)
	MLC	Qty	Small	Big	IFE	
46	76		2	12x18	15x24	
58	96		2	12x16	17x28	

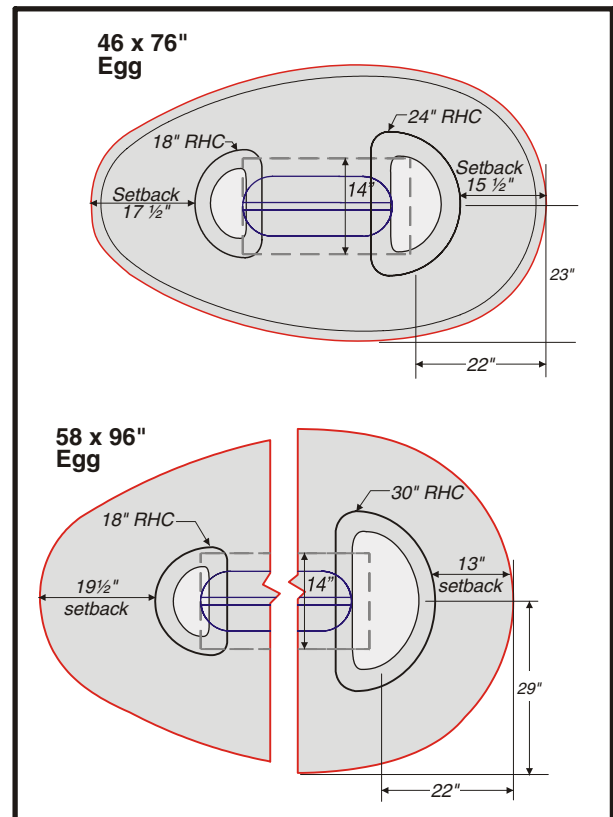

(A) - MLC - center of monument location shown in drawing to th e right.

(C) - IFE - Inset From End - shown in drawing o the right

Monument cutout for RHC Radius Half Cylinder bases are 6" less in each dimension

7% price increase effective January 1, 2009

ACT Tables

ACT Kaizen articulating table

Description	Model Number	Wgt	List Prices				
			WoodPlus	Standard	Detailed	2000	3000
KAIZEN table	TKZ-72144-AACE-RC	990	33647	33959	34426	35747	36655
	TKZ-72168-AACE-RC	1080	35149	35616	36039	37455	38427
	TKZ-72192-AACE-RC	1170	35388	35855	36501	37858	39004

KAIZEN table opens at either end or at both ends

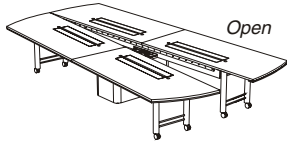

Open

Closed

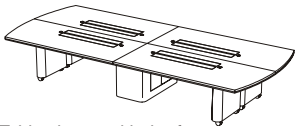
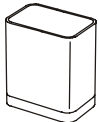

Table shown with the four RC-COVERS in place



Center Base Silver Accent

Top: 2 sides. Bases: Power entry at center of table and includes BHD Base Hinged Door. Includes MO20 ACT electrical outlets and faceplate bezels for data inserts and connectors. Includes the MINI-COVERS at the top of the HLEGs.

H-Leg standard finish is Black or Silver. Black will be provided unless otherwise specified.

Description	Model Number	Wgt	List Prices				
			WoodPlus	Standard	Detailed	2000	3000
H-Leg Covers	TKZ-RC-COVERS	32	1264	1264	1264	1264	1264

Four RC covers included, one for each HLEG on the table. RC covers match the center base finish color.

Description	Model Number	Wgt	List Prices				
			WoodPlus	Standard	Detailed	2000	3000
Silver Accent Center Base	BASE-SILVER-ACCENT-KAIZEN	0	328	328	328	328	328

Silver Accent strip for center base - 3" high.

Seating capacity and room size	for the 144" (12') long table	seats 10 to 12	minimum room size 14' 6" by 20'
	for the 168" (14') long table	seats 14 to 16	minimum room size 16' 6" by 22'
	for the 192" (16') long table	seats 16 to 18	minimum room size 18' 6" by 24'

144, 168, 192

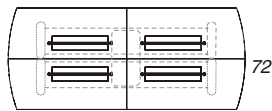

ACT Model Numbers: Shape 72 B ACE RC e.g. TKZ-72 168-ACE-RC

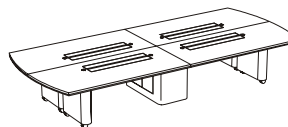

Table is closed

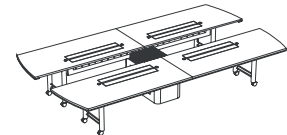
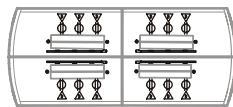

Table open at both ends



168" long table shown above

Table	Duplex	Bezels
144"	8	8
168"	12	12
192"	16	16

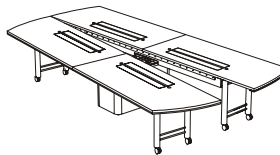

Table open end is to the right

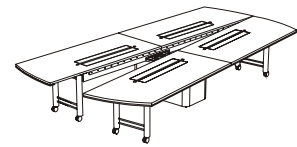

Table open end is to the left

IMPORTANT: Tables are standard with wood grain running length of table.

Finish Colors

Specify ACT table Finish Colors.

For ACT tables table top doors match top finish.

For non-standard top laminates, please contact Customer Service for availability and upcharge.

Custom color wood edge on outside of table

See the end of this section for pricing on all options and accessories.

Edge Options Information

- ACT tables are available with the following edge options:
- WoodPlus 3 mm PVC edge
 - Standard 3 mm Wood Edge
 - Detailed 3/8" Wood Edge
 - 2000 Series hardwood edges
 - 3000 Series hardwood edges

WoodPlus 3 mm PVC	Standard Wood	Detailed Wood	2000 Wood	3000 Wood
Equations WPES	Equations SWES	RE	2000	1000
Modular 8 WPER	Modular 8 SWER	RA	2001	1100
WPMS	SWMS	BE	2002	1200
WPEN	SWEN	TR	2003	2200
WPMN	SWMN	CL	2004	2100
WPMP	SWMP			3200
				3400

7% price increase effective January 1, 2009

ACT Tables

Mobile Utility Tables

Description	Model Number	Wgt	List Prices			
			WoodPlus	Standard	Detailed	Wood Edges
with Casters	MUT-2419-CA	35	907	956	1141	

The MUT table base is available in black or silver.
The top adjusts from 29" to 39".

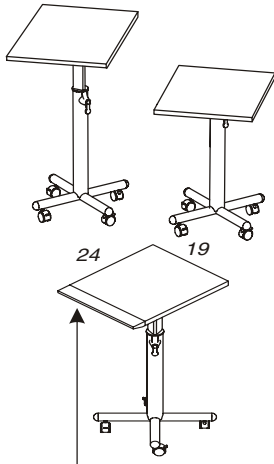

3400 edge shown along the 19" front edge of top

Match table edge	CREDENZA-2000-1LONG	356	
	CREDENZA-3000-1LONG		485

Match the tables 2000 series or 3000 series edge on one of the 19" long MUT table edges

Add inlay	CREDENZA-INLAY-BLACK	96	96
	CREDENZA-INLAY-BRASS	137	137
	CREDENZA-INLAY-CHROME	137	137

Add an inlay along the 2000 series or 3000 series edge

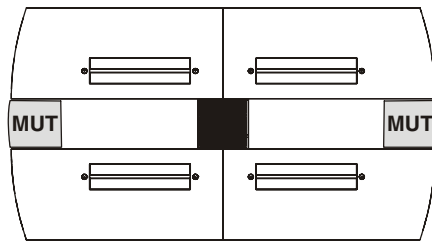

Two Mobile Utility Tables are used to expand the Kaizen table seating capacity

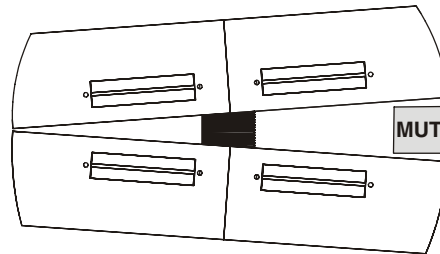

A Mobile Utility Table is used to hold the video projector or as a speaker's mini-lectern

IMPORTANT: Tables are standard with wood grain running length of table.

Finish Colors

Specify ACT table Finish Colors.

For ACT tables table top doors match top finish.

For non-standard top laminates, please contact Customer Service for availability and upcharge.

Optional custom color wood edge is available

Notes:

- ACT tables are shipped RTA (ready to assemble)
- MO20 ACT Electrical is included. See overview page for details.
- ACT top doors are shipped installed in the ACT table top
- Utility Bay is assembled with electrical included
- one Base Hinged Door (BHD) included with each ACT table It is installed on one of the 'end' base components Additional available as options.

Options

Options are built-in at factory

- INLAY -available ONLY with Detailed or larger edge
- INP Black 3mm (1/8") Inlay
- INB Brushed Brass 3mm Inlay or
- INC Satin Chrome 3mm Inlay
- Rectangle top with Bow End or C3R options uses the 'shape inlay' price.
- When a Rectangular table top is ordered with 2000 Series edge and an inlay, please add the optional Bow End (BE) or the Corners with 3" Radius (C3R).

Options

Options are built-in at factory

- BHD Base Hinged Door first one is included in ACT table in one of the base ends (RC, HC) or in TRI center base
- Additional BHD are available in RC, HC, RHC or in full Cylinder
- For Power source in Center base PE-C1
- Power Entry cables and access door in center base instead of end base.
- See the end of this section for pricing on all options and accessories.

7% price increase effective January 1, 2009

ACT Tables

Arrow ACT - Pyramid Base

Description	Model Number	Wgt	List Prices				
			WoodPlus	Standard	Wood Edges		
					Detailed	2000	3000
48" Wide	TAR4884-ACE-PYR	360	7990	8190	8658	9539	9984
	TAR4896-ACE-PYR	389	7900	8089	8736	9923	10368
	TAR48120-ACE-PYR	487	9124	9358	9792	11055	11726

Top: 1 piece. Base: 2 PYR. Includes MO20 ACT electrical outlets. Power entry at one end base. 1 BHD Base Hinged Door included at Power entry end.

TAR48144-ACE-PYR	597	11338	11634	12117	13438	14346
TAR48150-ACE-PYR	612	11801	12095	12748	14609	15517
TAR48168-ACE-PYR	655	13226	13584	14116	15532	16504

Top: 2 piece. Base: 3 PYR. Includes MO20 ACT electrical outlets. Power entry at one end base. 1 BHD Base Hinged Door included at Power entry end.

58" Wide	TAR58120-ACE-PYR	529	9455	9689	10123	11386	12057
-----------------	------------------	-----	-------------	------	-------	-------	-------

Top: 1 piece. Base: 2 PYR. Includes MO20 ACT electrical outlets. Power entry at one end base. 1 BHD Base Hinged Door included at Power entry end.

TAR58144-ACE-PYR	635	10040	10336	10819	12140	13048
TAR58150-ACE-PYR	652	10464	10758	11411	13191	14099

Top: 2 piece. Base: 2 PYR. Includes MO20 ACT electrical outlets. Power entry at one end base. 1 BHD Base Hinged Door included at Power entry end.

TAR58168-ACE-PYR	773	13312	13670	14202	15618	16590
TAR58180-ACE-PYR	807	12784	13225	14173	15857	16829
TAR58192-ACE-PYR	840	13761	14223	14763	16231	17377
TAR58216-ACE-PYR	986	13461	13902	15010	16738	17884
TAR58240-ACE-PYR	1052	14971	15438	16084	17884	19245

Top: 2 piece. Base: 3 PYR. Includes MO20 ACT electrical outlets. Power entry at one end base. 1 BHD Base Hinged Door included at Power entry end.

TAR58288-ACE-PYR	1337	18314	18710	19872	21731	23435
------------------	------	--------------	-------	-------	-------	-------

Top: 3 piece. Base: 4 PYR. Includes MO20 ACT electrical outlets. Power entry at one end base. 1 BHD Base Hinged Door included at Power entry end.

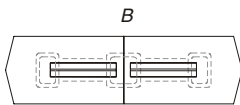
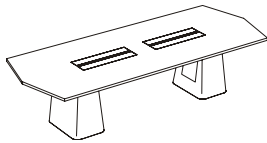

ACT Model Numbers:
Shape A B ACE Base
e.g. TAR 48 168 ACE PYR

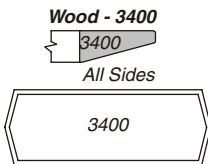

IMPORTANT: Tables are standard with wood grain running length of table.

Finish Colors

Specify ACT table Finish Colors.

For ACT tables table top doors match top finish.

For non-standard top laminates, please contact Customer Service for availability and upcharge.

Custom color wood edge on outside of table

See the end of this section for pricing on all options and accessories.

Edge Options Information

ACT tables are available with the following edge options:

- WoodPlus 3 mm PVC edge
- Standard 3 mm Wood Edge
- Detailed 3/8" Wood Edge
- 2000 Series hardwood edges
- 3000 Series hardwood edges

WoodPlus 3 mm PVC	Standard Wood	Detailed Wood	2000 Wood	3000 Wood
Equations WPES	Equations SWES	RE	2000	1000
Modular 8 WPER	Modular 8 SWER	RA	2001	1100
WPMS	SWMS	BE	2002	1200
WPEN	SWEN	TR	2003	2200
WPMN	SWMN	CL	2004	2100
WPMP	SWMP			

7% price increase effective January 1, 2009

ACT Tables

Arrow ACT - Triangle Base

Description	Model Number	Wgt	List Prices				
			WoodPlus	Standard	Wood Edges		
					Detailed	2000	3000
42" wide	TAR4272-ACE-TRI	321	5440	5635	6008	6684	7206
26" wide base	Top: 1 piece; Base: 2 TRI. Includes MO20 ACT electrical outlets and power entry.						
	TAR4284-ACE-TRI	350	5717	5917	6385	7266	7711
	TAR4296-ACE-TRI	379	6076	6276	6744	7625	8070
	TAR42120-ACE-TRI	467	6825	7059	7493	8756	9427
	Top: 1 piece; Base: 2 TRI. Includes MO20 ACT electrical outlets and power entry.						
	TAR42144-ACE-TRI	577	7375	7671	8154	9475	10383
	TAR42150-ACE-TRI	592	7650	7946	8429	9750	10658
	TAR42168-ACE-TRI	630	8243	8601	9133	10549	11521
	Top: 2 piece; Base: 3 TRI. Includes MO20 ACT electrical outlets and power entry.						
48" wide	TAR4872-ACE-TRI	311	5440	5635	6008	6684	7206
26" wide base	Top: 1 piece; Base: 2 TRI. Includes MO20 ACT electrical outlets and power entry.						
	TAR4884-ACE-TRI	340	5717	5917	6385	7266	7711
	TAR4896-ACE-TRI	369	6076	6276	6744	7625	8070
	TAR48120-ACE-TRI	467	6825	7059	7493	8756	9427
	Top: 1 piece; Base: 2 TRI. Includes MO20 ACT electrical outlets and power entry.						
	TAR48144-ACE-TRI	567	7375	7671	8154	9475	10383
	TAR48150-ACE-TRI	582	7650	7946	8429	9750	10658
	TAR48168-ACE-TRI	625	8243	8601	9133	10549	11521
	Top: 2 piece; Base: 3 TRI. Includes MO20 ACT electrical outlets and power entry.						
58" wide	TAR58120-ACE-TRI	509	7096	7330	7764	9027	9698
32" wide base	Top: 1 piece; Base: 2 TRI. Includes MO20 ACT electrical outlets and power entry.						
	TAR58144-ACE-TRI	575	7959	8255	8738	10059	10967
	TAR58150-ACE-TRI	592	8042	8338	8821	10142	11050
	Top: 2 piece; Base: 2 TRI. Includes MO20 ACT electrical outlets and power entry.						
	TAR58168-ACE-TRI	683	8591	8949	9481	10897	11869
	TAR58180-ACE-TRI	717	10035	10393	10925	12341	13313
	TAR58192-ACE-TRI	830	10218	10680	11220	12688	13834
	TAR58216-ACE-TRI	896	10530	10992	11532	13000	14146
	TAR58240-ACE-TRI	962	11079	11546	12192	13992	15353
	Top: 2 piece; Base: 3 TRI. Includes MO20 ACT electrical outlets and power entry.						
	TAR58288-ACE-TRI	1217	12152	12548	13710	15569	17273
	Top: 3 piece; Base: 4 TRI. Includes MO20 ACT electrical outlets and power entry.						

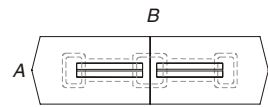
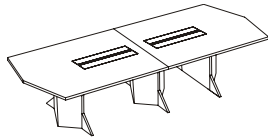
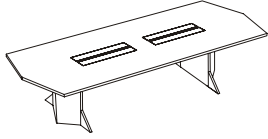

ACT Model Numbers:
Shape A B ACE Base
e.g. TAR 48 168 ACE PYR

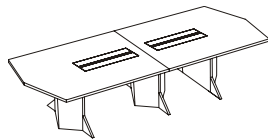
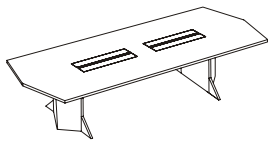

Table base 'wedges' are available in either black or silver finish.

Finish Colors

Specify ACT table Finish Colors.

For ACT tables table top doors match top finish.

For non-standard top laminates, please contact Customer Service for availability and upcharge.

Optional custom color wood edge is available

Notes:

- ACT tables are shipped RTA (ready to assemble)
- MO20 ACT Electrical is included. See overview page for details.
- ACT top doors are shipped installed in the ACT table top
- Utility Bay is assembled with electrical included
- one Base Hinged Door (BHD) included with each ACT table It is installed on one of the 'end' base components Additional available as options.

Options

Options are built-in at factory

- INLAY -available ONLY with Detailed or larger edge
- INP Black 3mm (1/8") Inlay
- INB Brushed Brass 3mm Inlay or
- INC Satin Chrome 3mm Inlay
- Rectangle top with Bow End or C3R options uses the 'shape inlay' price.
- When a Rectangular table top is ordered with 2000 Series edge and an inlay, please add the optional Bow End (BE) or the Corners with 3" Radius (C3R).

Options

Options are built-in at factory

- BHD Base Hinged Door first one is included in ACT table in one of the base ends (RC, HC) or in TRI center base
- Additional BHD are available in RC, HC, RHC or in full Cylinder
- For Power source in Center base PE-C1
- Power Entry cables and access door in center base instead of end base.
- See the end of this section for pricing on all options and accessories.

7% price increase effective January 1, 2009

ACT Tables

Rectangular ACT - Radius Cube Base

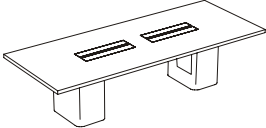
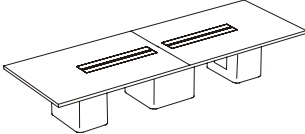
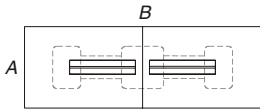
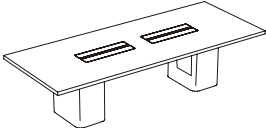
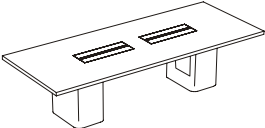
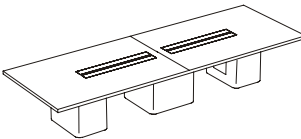
Description	Model Number	Wgt	List Prices				
			WoodPlus	Standard	Detailed	2000	3000
 <p>42" wide 24" wide base</p>	TT4272-ACE-RC	321	5029	5229	5530	6051	6572
	Top: 1 piece; Base: 2 RC. Includes MO20 ACT electrical outlets and power entry.						
	TT4284-ACE-RC	350	5490	5690	6047	6816	7261
	TT4296-ACE-RC	379	5682	5882	6239	7008	7453
	TT42120-ACE-RC	467	6282	6516	6839	7991	8662
	Top: 1 piece; Base: 2 RC. Includes MO20 ACT electrical outlets and power entry.						
	TT42144-ACE-RC	577	7504	7816	8172	9381	10178
	TT42150-ACE-RC	592	8435	8747	9103	10312	10442
	TT42168-ACE-RC	630	9041	9508	9820	10995	11222
	Top: 2 piece; Base: 3 RC. Includes MO20 ACT electrical outlets and power entry.						
 <p>48" wide 24" wide base</p>	TT4872-ACE-RC	331	5029	5229	5530	6051	6572
	Top: 1 piece; Base: 2 RC. Includes MO20 ACT electrical outlets and power entry.						
	TT4884-ACE-RC	360	5490	5690	6047	6816	7261
	TT4896-ACE-RC	389	5682	5882	6239	7008	7453
	TT48120-ACE-RC	487	6282	6516	6839	7991	8662
	Top: 1 piece; Base: 2 RC. Includes MO20 ACT electrical outlets and power entry.						
	TT48144-ACE-RC	597	7504	7816	8172	9381	10178
	TT48150-ACE-RC	612	8435	8747	9103	10312	10442
	TT48168-ACE-RC	655	9041	9508	9820	10995	11222
	Top: 2 piece; Base: 3 RC. Includes MO20 ACT electrical outlets and power entry.						
	TT58120-ACE-RC	529	6707	6941	7264	8416	9087
	Top: 1 piece; Base: 2 RC. Includes MO20 ACT electrical outlets and power entry.						
	TT58144-ACE-RC	635	7143	7455	7811	9020	9817
	TT58150-ACE-RC	652	7945	8257	8613	9822	9952
	Top: 2 piece; Base: 2 RC. Includes MO20 ACT electrical outlets and power entry.						
	TT58168-ACE-RC	773	9340	9807	10119	11300	11549
	TT58180-ACE-RC	807	9578	10045	10357	11550	12522
	TT58192-ACE-RC	840	9694	10161	10584	11941	12976
	TT58216-ACE-RC	986	9834	10301	10724	12081	13116
	TT58240-ACE-RC	1052	10359	10826	11361	12999	14299
Top: 2 piece; Base: 3 RC. Includes MO20 ACT electrical outlets and power entry.							
TT58288-ACE-RC	1337	12581	12977	13917	15665	17368	
Top: 3 piece; Base: 4 RC. Includes MO20 ACT electrical outlets and power entry.							

ACT Model Numbers:
Shape A B ACE Base
e.g. TT 58 168 ACE RC

IMPORTANT: Tables are standard with wood grain running length of table.

Finish Colors

Specify ACT table Finish Colors.

For ACT tables table top doors match top finish.

For non-standard top laminates, please contact Customer Service for availability and upcharge.

Custom color wood edge on outside of table

See the end of this section for pricing on all options and accessories.

Edge Options Information

- ACT tables are available with the following edge options:
- WoodPlus 3 mm PVC edge
 - Standard 3 mm Wood Edge
 - Detailed 3/8" Wood Edge
 - 2000 Series hardwood edges
 - 3000 Series hardwood edges

	WoodPlus 3 mm PVC	Standard Wood	Detailed Wood	2000 Wood	3000 Wood
Equations	WPES	SWES	RE	2000	1000
Modular 8	WPER	SWER	RA	2001	1100
	WPMS	SWMS	BE	2002	1200
	WPEN	SWEN	TR	2003	2200
	WPMN	SWMN	CL	2004	2100
	WPMP	SWMP			

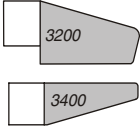

7% price increase effective January 1, 2009

ACT Tables

Rectangular ACT - Triangle Base

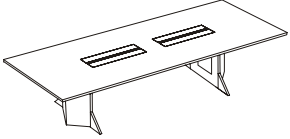
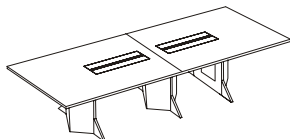
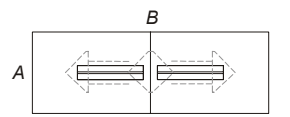
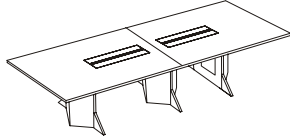
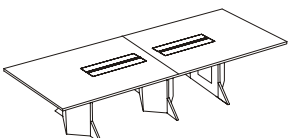
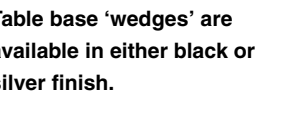
Description	Model Number	Wgt	List Prices					
			WoodPlus	Standard	Wood Edges			
					Detailed	2000	3000	
	42" wide	TT4272-ACE-TRI	321	5029	5229	5530	6051	6572
	24" wide base	Top: 1 piece; Base: 2 TRI. Includes MO20 ACT electrical outlets and power entry.						
		TT4284-ACE-TRI	350	5490	5690	6047	6816	7261
		TT4296-ACE-TRI	379	5682	5882	6239	7008	7453
		TT42120-ACE-TRI	467	6282	6516	6839	7991	8662
Top: 1 piece; Base: 2 TRI. Includes MO20 ACT electrical outlets and power entry.								
		TT42144-ACE-TRI	577	7504	7816	8172	9381	10178
		TT42150-ACE-TRI	592	8435	8747	9103	10312	10442
		TT42168-ACE-TRI	630	9041	9508	9820	10995	11222
	Top: 2 piece; Base: 3 TRI. Includes MO20 ACT electrical outlets and power entry.							
			TT4872-ACE-TRI	331	5029	5229	5530	6051
	48" wide							
	24" wide base	Top: 1 piece; Base: 2 TRI. Includes MO20 ACT electrical outlets and power entry.						
		TT4884-ACE-TRI	360	5490	5690	6047	6816	7261
		TT4896-ACE-TRI	389	5682	5882	6239	7008	7453
		TT48120-ACE-TRI	487	6282	6516	6839	7991	8662
Top: 1 piece; Base: 2 TRI. Includes MO20 ACT electrical outlets and power entry.								
		TT48144-ACE-TRI	597	7504	7816	8172	9381	10178
		TT48150-ACE-TRI	612	8435	8747	9103	10312	10442
		TT48168-ACE-TRI	655	9041	9508	9820	10995	11222
	Top: 2 piece; Base: 3 TRI. Includes MO20 ACT electrical outlets and power entry.							
			TT58120-ACE-TRI	529	6707	6941	7264	8416
	58" wide							
	30" wide base	Top: 1 piece; Base: 2 TRI. Includes MO20 ACT electrical outlets and power entry.						
		TT58144-ACE-TRI	635	7143	7455	7811	9020	9817
		TT58150-ACE-TRI	652	7945	8257	8613	9822	9952
		Top: 2 piece; Base: 2 TRI. Includes MO20 ACT electrical outlets and power entry.						
		TT58168-ACE-TRI	773	9340	9807	10119	11300	11549
		TT58180-ACE-TRI	807	9578	10045	10357	11550	12522
		TT58192-ACE-TRI	840	9694	10161	10584	11941	12976
		TT58216-ACE-TRI	986	9834	10301	10724	12081	13116
		TT58240-ACE-RC	1052	10359	10826	11361	12999	14299
	Top: 2 piece; Base: 3 RC. Includes MO20 ACT electrical outlets and power entry.							
		TT58288-ACE-RC	1337	12581	12977	13917	15665	17368
Top: 3 piece; Base: 4 RC. Includes MO20 ACT electrical outlets and power entry.								

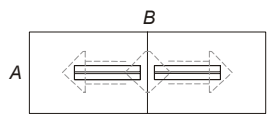

ACT Model Numbers:
Shape A B ACE Base
e.g. TT 58 168 ACE RC

Table base 'wedges' are available in either black or silver finish.

IMPORTANT: Tables are standard with wood grain running length of table.

Finish Colors
Specify ACT table Finish Colors.

For ACT tables table top doors match top finish.

For non-standard top laminates, please contact Customer Service for availability and upcharge.

Optional custom color wood edge is available

Notes:

- ACT tables are shipped RTA (ready to assemble)
- MO20 ACT Electrical is included. See overview page for details.
- ACT top doors are shipped installed in the ACT table top
- Utility Bay is assembled with electrical included
- one Base Hinged Door (BHD) included with each ACT table. It is installed on one of the 'end' base components. Additional available as options.

Options
Options are built-in at factory

- INLAY -available ONLY with Detailed or larger edge
- INP Black 3mm (1/8") Inlay
- INB Brushed Brass 3mm Inlay or
- INC Satin Chrome 3mm Inlay
- Rectangle top with Bow End or C3R options uses the 'shape inlay' price.
- When a Rectangular table top is ordered with 2000 Series edge and an inlay, please add the optional Bow End (BE) or the Corners with 3" Radius (C3R).

Options
Options are built-in at factory

- BHD Base Hinged Door first one is included in ACT table in one of the base ends (RC, HC) or in TRI center base
- Additional BHD are available in RC, HC, RHC or in full Cylinder
- For Power source in Center base PE-C1
- Power Entry cables and access door in center base instead of end base.
- See the end of this section for pricing on all options and accessories.

7% price increase effective January 1, 2009

ACT Tables

Boat Shape ACT - Radius Cube Base

Description	Model Number	Wgt	List Prices					
			WoodPlus	Standard	Wood Edges			
					Detailed	2000	3000	
42" wide 24" wide base	TB4272-ACE-RC	321	5440	5640	6053	6684	7206	
	TB4284-ACE-RC	350	5717	5917	6385	7266	7711	
	TB4296-ACE-RC	379	6076	6276	6744	7625	8070	
	TB42120-ACE-RC	467	6825	7059	7493	8756	9427	
Top: 1 piece; Base: 2 RC. Includes MO20 ACT electrical outlets and power entry.								
48" wide 24" wide base	TB42144-ACE-RC	577	7632	7944	8411	9732	10640	
	TB42150-ACE-RC	592	8561	8873	9340	10661	11569	
	TB42168-ACE-RC	630	9167	9634	10057	11473	12445	
	TB4872-ACE-RC	331	5440	5640	6053	6684	7206	
48" wide 30" wide base	TB4884-ACE-RC	360	5717	5917	6385	7266	7711	
	TB4896-ACE-RC	389	6076	6276	6744	7625	8070	
	TB48120-ACE-RC	487	6825	7059	7493	8756	9427	
	TB48144-ACE-RC	597	7632	7944	8411	9732	10640	
58" wide 30" wide base	TB48150-ACE-RC	612	8561	8873	9340	10661	11569	
	TB48168-ACE-RC	655	9167	9634	10057	11473	12445	
	TB58120-ACE-RC	529	7096	7330	7764	9027	9698	
	TB58144-ACE-RC	635	7959	8271	8738	10059	10967	
58" wide 30" wide base	TB58150-ACE-RC	652	8678	8990	9457	10778	11686	
	TB58168-ACE-RC	773	9465	9932	10355	11771	12743	
	TB58180-ACE-RC	807	10035	10502	10925	12341	13313	
	TB58192-ACE-RC	840	10218	10685	11331	12688	13834	
	TB58216-ACE-RC	986	10530	10997	11643	13000	14146	
	TB58240-ACE-RC	1052	11079	11546	12192	13992	15353	
	TB58288-ACE-RC	1337	12708	13175	14266	16125	16142	
	Top: 2 piece; Base: 2 RC. Includes MO20 ACT electrical outlets and power entry.							
	Top: 2 piece; Base: 3 RC. Includes MO20 ACT electrical outlets and power entry.							
	Top: 3 piece; Base: 4 RC. Includes MO20 ACT electrical outlets and power entry.							

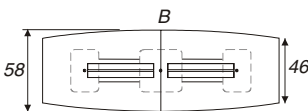
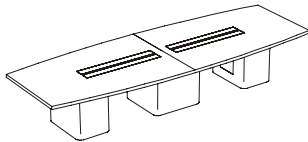
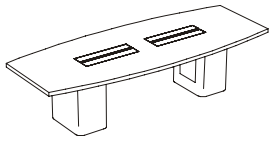

ACT Model Numbers:
Shape width B ACE Base
e.g. TB 58 168 ACE RC

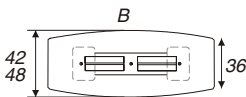

ACT Model Numbers:
Shape width B ACE Base
e.g. TB 48 120 ACE RC

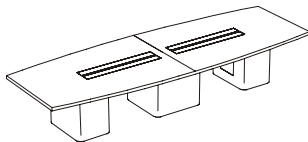
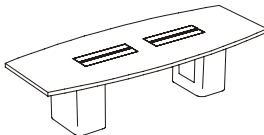

IMPORTANT: Tables are standard with wood grain running length of table.

Finish Colors

Specify ACT table Finish Colors.

For ACT tables table top doors match top finish.

For non-standard top laminates, please contact Customer Service for availability and upcharge.

Custom color wood edge on outside of table

See the end of this section for pricing on all options and accessories.

Edge Options Information

- ACT tables are available with the following edge options:
- WoodPlus 3 mm PVC edge
 - Standard 3 mm Wood Edge
 - Detailed 3/8" Wood Edge
 - 2000 Series hardwood edges
 - 3000 Series hardwood edges

	WoodPlus 3 mm PVC	Standard Wood	Detailed Wood	2000 Wood	3000 Wood
Equations	WPES	SWES	RE	2000	1000
Modular 8	WPER	SWER	RA	2001	1100
	WPMS	SWMS	BE	2002	1200
	WPEN	SWEN	TR	2003	2200
	WPMN	SWMN	CL	2004	2100
	WPMP	SWMP			

7% price increase effective January 1, 2009

ACT Tables

Boat Shape ACT - Triangle Base

Description	Model Number	Wgt	List Prices					
			WoodPlus	Standard	Wood Edges			
					Detailed	2000	3000	
42" wide	TB4272-ACE-TRI	321	5440	5640	6053	6684	7206	
24" wide base	TB4284-ACE-TRI	350	5717	5917	6385	7266	7711	
	TB4296-ACE-TRI	379	6076	6276	6744	7625	8070	
	TB42120-ACE-TRI	467	6825	7059	7493	8756	9427	
	Top: 1 piece; Base: 2 TRI. Includes MO20 ACT electrical outlets and power entry.							
	TB42144-ACE-TRI	577	7632	7944	8411	9732	10640	
	TB42150-ACE-TRI	592	8561	8873	9340	10661	11569	
	TB42168-ACE-TRI	630	9167	9634	10057	11473	12445	
Top: 2 piece; Base: 3 TRI. Includes MO20 ACT electrical outlets and power entry.								
48" wide	TB4872-ACE-TRI	331	5440	5640	6053	6684	7206	
24" wide base	TB4884-ACE-TRI	360	5717	5917	6385	7266	7711	
	TB4896-ACE-TRI	389	6076	6276	6744	7625	8070	
	TB48120-ACE-TRI	487	6825	7059	7493	8756	9427	
	Top: 1 piece; Base: 2 TRI. Includes MO20 ACT electrical outlets and power entry.							
	TB48144-ACE-TRI	597	7632	7944	8411	9732	10640	
	TB48150-ACE-TRI	612	8561	8873	9340	10661	11569	
	TB48168-ACE-TRI	655	9167	9634	10057	11473	12445	
Top: 2 piece; Base: 3 TRI. Includes MO20 ACT electrical outlets and power entry.								
58" wide	TB58120-ACE-TRI	529	7096	7330	7764	9027	9698	
30" wide base	Top: 1 piece; Base: 2 TRI. Includes MO20 ACT electrical outlets and power entry.							
	TB58144-ACE-TRI	635	7959	8271	8738	10059	10967	
	TB58150-ACE-TRI	652	8678	8990	9457	10778	11686	
Top: 2 piece; Base: 2 TRI. Includes MO20 ACT electrical outlets and power entry.								
	TB58168-ACE-TRI	773	9465	9932	10355	11771	12743	
	TB58180-ACE-TRI	807	10035	10502	10925	12341	13313	
	TB58192-ACE-TRI	840	10218	10685	11331	12688	13834	
	TB58216-ACE-TRI	986	10530	10997	11643	13000	14146	
	TB58240-ACE-TRI	1052	11079	11546	12192	13992	15353	
Top: 2 piece; Base: 3 TRI. Includes MO20 ACT electrical outlets and power entry.								
	TB58288-ACE-TRI	1337	12708	13175	14266	16125	16142	
Top: 3 piece; Base: 4 TRI. Includes MO20 ACT electrical outlets and power entry.								

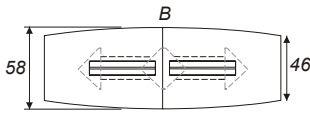
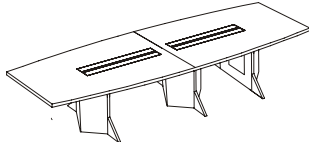
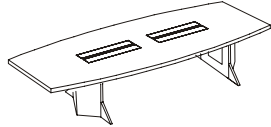

ACT Model Numbers:
Shape width B ACE Base
e.g. TB 58 168 ACE TRI

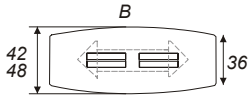

ACT Model Numbers:
Shape width B ACE Base
e.g. TB 48 120 ACE TRI

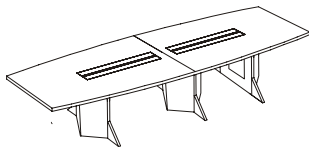

Table base 'wedges' are available in either black or silver finish.

IMPORTANT: Tables are standard with wood grain running length of table.

Finish Colors

Specify ACT table Finish Colors.

For ACT tables table top doors match top finish.

For non-standard top laminates, please contact Customer Service for availability and upcharge.

Optional custom color wood edge is available

Notes:

- ACT tables are shipped RTA (ready to assemble)
- MO20 ACT Electrical is included. See overview page for details.
- ACT top doors are shipped installed in the ACT table top
- Utility Bay is assembled with electrical included
- one Base Hinged Door (BHD) included with each ACT table It is installed on one of the 'end' base components Additional available as options.

Options

Options are built-in at factory

- INLAY -available ONLY with Detailed or larger edge
- INP Black 3mm (1/8") Inlay
- INB Brushed Brass 3mm Inlay or
- INC Satin Chrome 3mm Inlay
- Rectangle top with Bow End or C3R options uses the 'shape inlay' price.
- When a Rectangular table top is ordered with 2000 Series edge and an inlay, please add the optional Bow End (BE) or the Corners with 3" Radius (C3R).

Options

Options are built-in at factory

- BHD Base Hinged Door first one is included in ACT table in one of the base ends (RC, HC) or in TRI center base
- Additional BHD are available in RC, HC, RHC or in full Cylinder
- For Power source in Center base PE-C1
- Power Entry cables and access door in center base instead of end base.
- See the end of this section for pricing on all options and accessories.

7% price increase effective January 1, 2009

ACT Tables

Racetrack ACT - Half Cylinder Base

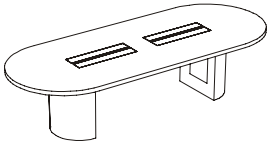
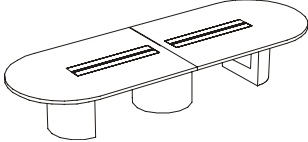
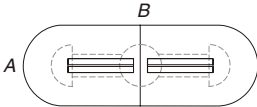
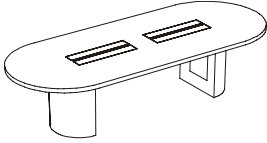
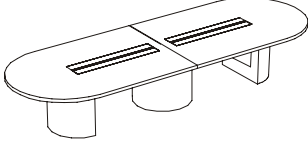
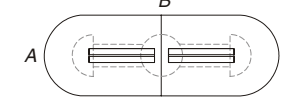
Description	Model Number	Wgt	List Prices					
			WoodPlus	Standard	Wood Edges			
					Detailed	2000	3000	
	42" wide	TR4272-ACE-HC	321	5440	5640	6053	6684	7206
	24" wide base	TR4284-ACE-HC	350	5717	5917	6385	7266	7711
		TR4296-ACE-HC	379	6076	6276	6744	7625	8070
		TR42120-ACE-HC	467	6825	7059	7493	8756	9427
Top: 1 piece; Base: 2 HC. Includes MO20 ACT electrical outlets and power entry.								
	48" wide	TR42144-ACE-HC	577	7375	7687	8154	9475	10383
	24" wide base	TR42150-ACE-HC	592	7650	7962	8429	9750	10658
		TR42168-ACE-HC	630	8243	8710	9133	10549	11521
		Top: 2 piece; Base: 2 HC, 1 CYL. Includes MO20 ACT electrical outlets and power entry.						
	48" wide	TR4872-ACE-HC	311	5440	5640	6053	6684	7206
	24" wide base	TR4884-ACE-HC	340	5717	5917	6385	7266	7711
		TR4896-ACE-HC	369	6076	6276	6744	7625	8070
		TR48120-ACE-HC	467	6825	7059	7493	8756	9427
Top: 1 piece; Base: 2 HC. Includes MO20 ACT electrical outlets and power entry.								
	48" wide	TR48144-ACE-HC	567	7375	7687	8154	9475	10383
	24" wide base	TR48150-ACE-HC	582	7650	7962	8429	9750	10658
		TR48168-ACE-HC	625	8243	8710	9133	10549	11521
		Top: 2 piece; Base: 2 HC, 1 CYL. Includes MO20 ACT electrical outlets and power entry.						
	58" wide	TR58120-ACE-HC	509	7096	7330	7764	9027	9698
	30" wide base	TR58144-ACE-HC	575	7959	8271	8738	10059	10967
		TR58150-ACE-HC	592	8042	8354	8821	10142	11050
		Top: 2 piece; Base: 2 HC. Includes MO20 ACT electrical outlets and power entry.						
	58" wide	TR58168-ACE-HC	683	8591	9058	9481	10897	11869
	30" wide base	TR58180-ACE-HC	717	10035	10502	10925	12341	13313
		TR58192-ACE-HC	830	10218	10685	11331	12688	13834
		TR58216-ACE-HC	896	10530	10997	11643	13000	14146
		TR58240-ACE-HC	962	11079	11546	12192	13992	15353
		Top: 2 piece; Base: 2 HC, 1 CYL. Includes MO20 ACT electrical outlets and power entry.						
TR58288-ACE-HC	1217	12152	12548	13710	15569	17273		
Top: 3 piece; Base: 2 HC, 2 CYL. Includes MO20 ACT electrical outlets and power entry.								

ACT Model Numbers:
Shape A B ACE Base
e.g. TB 58 168 ACE RC

ACT Model Numbers:
Shape A B ACE Base
e.g. TB 58 168 ACE RC

IMPORTANT: Tables are standard with wood grain running length of table.

Finish Colors

Specify ACT table Finish Colors.

For ACT tables table top doors match top finish.

For non-standard top laminates, please contact Customer Service for availability and upcharge.

Custom color wood edge on outside of table

See the end of this section for pricing on all options and accessories.

Edge Options Information

- ACT tables are available with the following edge options:
- WoodPlus 3 mm PVC edge
 - Standard 3 mm Wood Edge
 - Detailed 3/8" Wood Edge
 - 2000 Series hardwood edges
 - 3000 Series hardwood edges

	WoodPlus 3 mm PVC	Standard Wood	Detailed Wood	2000 Wood	3000 Wood
Equations	WPES	SWES	RE	2000	1000
Modular 8	WPER	SWER	RA	2001	1100
	WPMS	SWMS	BE	2002	1200
	WPEN	SWEN	TR	2003	2200
	WPMN	SWMN	CL	2004	2100
	WPMP	SWMP			

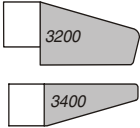

7% price increase effective January 1, 2009

ACT Tables

Racetrack ACT - with Narrow Half Cylinder Base

Description	Model Number	Wgt	List Prices				
			WoodPlus	Standard	Wood Edges		
					Detailed	2000	3000
48" wide	TR4872-ACE-HCN	311	5440	5640	6053	6684	7206
20" wide HC,	TR4884-ACE-HCN	340	5717	5917	6385	7266	7711
18" Dia CYL	TR4896-ACE-HCN	369	6076	6276	6744	7625	8070
	TR48120-ACE-HCN	467	6825	7059	7493	8756	9427

Top: 1 piece; Base: 2 HCN. HCN are 20" diameter plus the 'wedge' on both sides. Includes MO20 ACT electrical outlets and power entry.

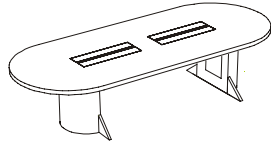

TR48144-ACE-HCN	567	7375	7687	8154	9475	10383
TR48150-ACE-HCN	582	7650	7962	8429	9750	10658
TR48168-ACE-HCN	625	8243	8710	9133	10549	11521

Top: 2 piece; Base: 2 HCN, 1 CYL.

HCN are 20" diameter plus the 'wedge' on both sides. Center Cylinder is 18" diameter. Includes MO20 ACT electrical outlets and power entry.

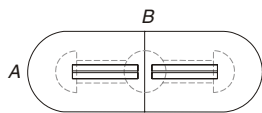

ACT Model Numbers:
Shape A B ACE Base
e.g. TB 58 168 ACE RC

58" wide	TR58120-ACE-HCN	509	7096	7330	7764	9027	9698
20" wide HC,	TR58144-ACE-HCN	575	7959	8271	8738	10059	10967
24" Dia CYL	TR58150-ACE-HCN	592	8042	8354	8821	10142	11050

Top: 2 piece; Base: 2 HCN. HCN are 20" diameter plus the 'wedge' on both sides. Includes MO20 ACT electrical outlets and power entry.

TR58168-ACE-HCN	683	8591	9058	9481	10897	11869
TR58180-ACE-HCN	717	10035	10502	10925	12341	13313
TR58192-ACE-HCN	830	10218	10685	11331	12688	13834
TR58216-ACE-HCN	896	10530	10997	11643	13000	14146
TR58240-ACE-HCN	962	11079	11546	12192	13992	15353

Top: 2 piece; Base: 2 HCN, 1 CYL.

HCN are 20" diameter plus the 'wedge' on both sides. Center Cylinder is 18" diameter. Includes MO20 ACT electrical outlets and power entry.

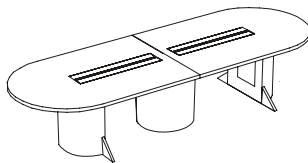

TR58288-ACE-HCN	1217	12152	12548	13710	15569	17273
-----------------	------	--------------	-------	-------	-------	-------

Top: 3 piece; Base: 2 HCN, 2 CYL.

HCN are 20" diameter plus the 'wedge' on both sides. Center Cylinders are 24" diameter. Includes MO20 ACT electrical outlets and power entry.

IMPORTANT: Tables are standard with wood grain running length of table.

Finish Colors

Specify ACT table Finish Colors.

For ACT tables table top doors match top finish.

For non-standard top laminates, please contact Customer Service for availability and upcharge.

Optional custom color wood edge is available

Notes:

- ACT tables are shipped RTA (ready to assemble)
- MO20 ACT Electrical is included. See overview page for details.
- ACT top doors are shipped installed in the ACT table top
- Utility Bay is assembled with electrical included
- one Base Hinged Door (BHD) included with each ACT table It is installed on one of the 'end' base components Additional available as options.

Options

Options are built-in at factory

- INLAY -available ONLY with Detailed or larger edge
- INP Black 3mm (1/8") Inlay
- INB Brushed Brass 3mm Inlay or
- INC Satin Chrome 3mm Inlay
- Rectangle top with Bow End or C3R options uses the 'shape inlay' price.
- When a Rectangular table top is ordered with 2000 Series edge and an inlay, please add the optional Bow End (BE) or the Corners with 3" Radius (C3R).

Options

Options are built-in at factory

- BHD Base Hinged Door first one is included in ACT table in one of the base ends (RC, HC) or in TRI center base
- Additional BHD are available in RC, HC, RHC or in full Cylinder
- For Power source in Center base PE-C1
- Power Entry cables and access door in center base instead of end base.
- See the end of this section for pricing on all options and accessories.

7% price increase effective January 1, 2009

ACT Tables

Delta ACT - Radius Cube Base

Description	Model Number	Wgt	List Prices				
			WoodPlus	Standard	Detailed	2000	3000
One piece top	TDE5896-ACE-RC	462	7320	7554	7988	9251	9922
	TDE58120-ACE-RC	529	8056	8290	8724	9987	10658
Top: 1 piece; Base: 2 RC. Includes MO20 ACT electrical outlets and power entry.							
Two piece top two bases	TDE58144-ACE-RC	635	9004	9316	9783	11104	12012
	TDE58150-ACE-RC	652	9096	9408	9875	11196	12104
Top: 2 piece; Base: 2 RC. Includes MO20 ACT electrical outlets and power entry.							
Two piece top three bases	TDE58168-ACE-RC	773	10154	10621	11044	12460	13432
	TDE58180-ACE-RC	807	10740	11207	11630	13046	14018
	TDE58192-ACE-RC	840	11472	11939	12585	13942	15088
	TDE58216-ACE-RC	986	11809	12276	12922	14279	15425

Top: 2 piece; Base: 3 RC. Includes MO20 ACT electrical outlets and power entry.

Power entry is standard from the wide end of the table.

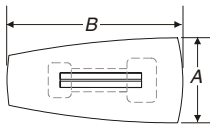
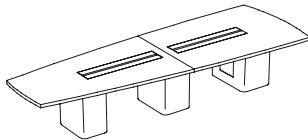
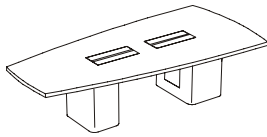

ACT Model Numbers:
Shape A B ACE Base
e.g. TDE 58 120 ACE RC

Egg Shape ACT - Radius Half Cylinder Base

One piece top	TEG5896-ACE-RHC	462	8011	8245	8679	9942	10613
----------------------	-----------------	-----	-------------	------	------	------	-------

Top: 1 piece; Base: 2 RHC. Includes MO20 ACT electrical outlets and power entry.

Power entry is standard from the wide end of the table.

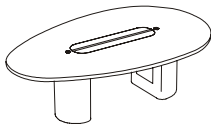

TEG5896-ACE-RHC

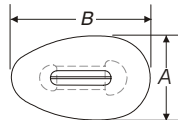

ACT Model Numbers:
Shape A B ACE Base
e.g. TEG 58 96 ACE RHC

IMPORTANT: Tables are standard with wood grain running length of table.

Finish Colors

Specify ACT table Finish Colors.

For ACT tables table top doors match top finish.

For non-standard top laminates, please contact Customer Service for availability and upcharge.

Custom color wood edge on outside of table

See the end of this section for pricing on all options and accessories.

Edge Options Information

- ACT tables are available with the following edge options:
- WoodPlus 3 mm PVC edge
 - Standard 3 mm Wood Edge
 - Detailed 3/8" Wood Edge
 - 2000 Series hardwood edges
 - 3000 Series hardwood edges

WoodPlus 3 mm PVC	Standard Wood	Detailed Wood	2000 Wood	3000 Wood
Equations WPES	Equations SWES	RE	2000	1000
Modular 8 WPER	Modular 8 SWER	RA	2001	1100
WPMS	SWMS	BE	2002	1200
WPEN	SWEN	TR	2003	2200
WPMN	SWMN	CL	2004	2100
WPMP	SWMP			

7% price increase effective January 1, 2009

ACT Tables

Round ACT - Full Cylinder Base

Description	Model Number	Wgt	List Prices				
			WoodPlus	Standard	Wood Edges		
					Detailed	2000	3000
58" Diameter	TD58-ACE-CYL	220	6076	6276	6744	7625	8070

One piece top. Includes MO20 ACT electrical outlets and power entry.

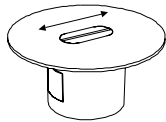

TD58-ACE-CYL

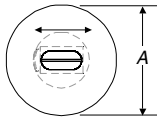

ACT Model Numbers:
Shape A ACE Base
e.g. TD 58 ACE CYL

66" and 72" Diameter	TD66-ACE-CYL	255	7375	7687	8154	9475	10383
	TD72-ACE-CYL	310	7375	7687	8154	9475	10383

Two piece tops. Includes MO20 ACT electrical outlets and power entry.

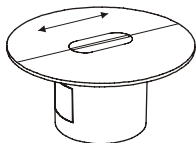

TD66-ACE-CYL or
TD72-ACE-CYL

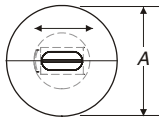

ACT Model Numbers:
Shape A ACE Base
e.g. TD 72 ACE CYL

IMPORTANT: Tables are standard with wood grain running length of table.

Finish Colors

Specify ACT table Finish Colors.

For ACT tables table top doors match top finish.

For non-standard top laminates, please contact Customer Service for availability and upcharge.

Optional custom color wood edge is available

Notes:

- ACT tables are shipped RTA (ready to assemble)
- MO20 ACT Electrical is included. See overview page for details.
- ACT top doors are shipped installed in the ACT table top
- Utility Bay is assembled with electrical included
- one Base Hinged Door (BHD) included with each ACT table It is installed on one of the 'end' base components Additional available as options.

Options

Options are built-in at factory

- INLAY -available ONLY with Detailed or larger edge
- INP Black 3mm (1/8") Inlay
- INB Brushed Brass 3mm Inlay or
- INC Satin Chrome 3mm Inlay
- Rectangle top with Bow End or C3R options uses the 'shape inlay' price.
- When a Rectangular table top is ordered with 2000 Series edge and an inlay, please add the optional Bow End (BE) or the Corners with 3" Radius (C3R).

Options

Options are built-in at factory

- BHD Base Hinged Door first one is included in ACT table in one of the base ends (RC, HC) or in TRI center base
- Additional BHD are available in RC, HC, RHC or in full Cylinder
- For Power source in Center base PE-C1
- Power Entry cables and access door in center base instead of end base.
- See the end of this section for pricing on all options and accessories.

7% price increase effective January 1, 2009

ACT Tables

Wing Table ACT - Radius Cube Base

Description	Model Number	Wgt	List Prices				
			WoodPlus	Standard	Detailed	2000	3000
ACT WING table	TW-1712-ACE-RC	19975		20910	21978	24915	27207

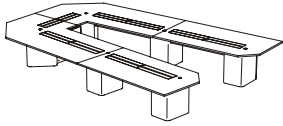

WING table seats 16.
Table is 16' - 10" long by 12' - 3" wide
Minimum room size is 25' long by 20' wide.

Power entry location is shown below.
As shown, the WING table has the following:
14 electrical duplex outlets
15 faceplate bezels

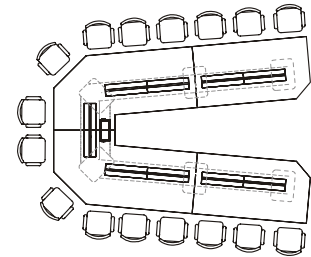
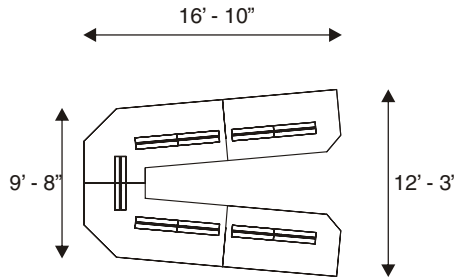
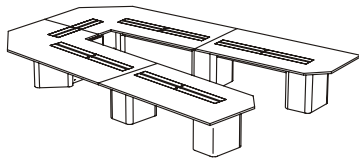

Seats 16 at table

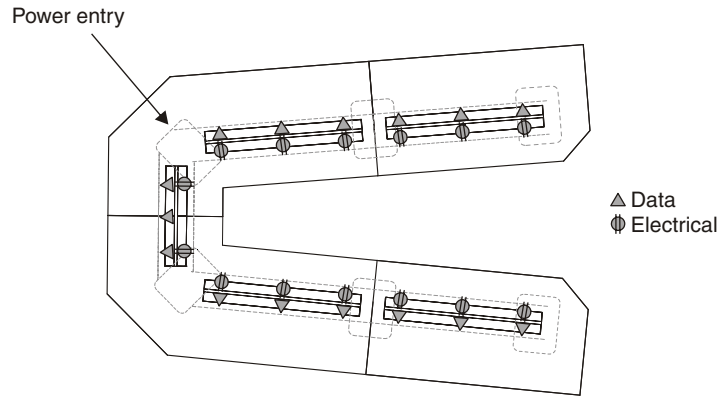

IMPORTANT: Tables are standard with wood grain running length of table.

Finish Colors

Specify ACT table Finish Colors.

For ACT tables table top doors match top finish.

For non-standard top laminates, please contact Customer Service for availability and upcharge.

Custom color wood edge on outside of table

See the end of this section for pricing on all options and accessories.

Edge Options Information

- ACT tables are available with the following edge options:
- WoodPlus 3 mm PVC edge
 - Standard 3 mm Wood Edge
 - Detailed 3/8" Wood Edge
 - 2000 Series hardwood edges
 - 3000 Series hardwood edges

WoodPlus 3 mm PVC	Standard Wood	Detailed Wood	2000 Wood	3000 Wood
Equations WPES	Equations SWES	RE	2000	1000
Modular 8 WPER	Modular 8 SWER	RA	2001	1100
WPMS	SWMS	BE	2002	1200
WPEN	SWEN	TR	2003	2200
WPMN	SWMN	CL	2004	2100
WPMP	SWMP			

7% price increase effective January 1, 2009

ACT Tables - WoodPlus²

Description Model No. Overall Dimensions
Wide Long Wgt List Prices
WoodPlus²

ACT WoodPlus² Rectangular Bow End with Radius Cube Base

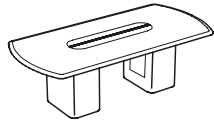

TT-BE-4696-ACE-RC

42" wide, One Piece Top	TT-BE-4272-ACE-RC-WP2	42	72	321	4854
	TT-BE-4284-ACE-RC-WP2	42	84	350	5387
	TT-BE-4296-ACE-RC-WP2	42	96	379	5760

Top: 1 piece; Base: 2 Radius Cubes. Includes MO20 ACT electrical outlets. Power Entry (one per utility bay side) and BHD Base Hinged Door included at one end.

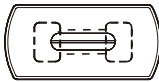

Two Piece Top	TT-BE-42120-ACE-RC-WP2	42	120	467	6918
----------------------	------------------------	----	-----	-----	-------------

Top: 2 piece; Base: 2 Radius Cubes. Includes MO20 ACT electrical outlets. Power Entry (one per utility bay side) and BHD Base Hinged Door included at one end.

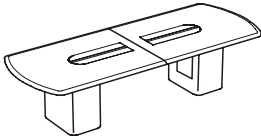

TT-BE-46120-ACE-RC

	TT-BE-42144-ACE-RC-WP2	42	144	577	8315
	TT-BE-42150-ACE-RC-WP2	42	150	592	9145
	TT-BE-42168-ACE-RC-WP2	42	168	630	10954

Top: 2 piece; Base: 3 Radius Cubes. Includes MO20 ACT electrical outlets. Power Entry (one per utility bay side) and BHD Base Hinged Door included at one end.

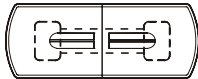

46" wide, One Piece Top	TT-BE-4672-ACE-RC-WP2	46	72	331	4854
	TT-BE-4684-ACE-RC-WP2	46	84	360	5387
	TT-BE-4696-ACE-RC-WP2	46	96	389	5760

Top: 1 piece; Base: 2 Radius Cubes. Includes MO20 ACT electrical outlets. Power Entry (one per utility bay side) and BHD Base Hinged Door included at one end.

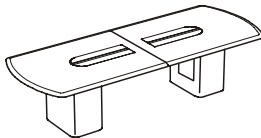

TT-BE-46120-ACE-RC

Two Piece Top	TT-BE-46120-ACE-RC-WP2	46	120	487	6918
----------------------	------------------------	----	-----	-----	-------------

Top: 2 piece; Base: 2 Radius Cubes. Includes MO20 ACT electrical outlets. BHD Base Hinged Door included at one base end component.



	TT-BE-46144-ACE-RC-WP2	46	144	597	8315
	TT-BE-46150-ACE-RC-WP2	46	150	612	9145
	TT-BE-46168-ACE-RC-WP2	46	168	655	10954

Top: 2 piece; Base: 3 Radius Cubes. Includes MO20 ACT electrical outlets. Power Entry (one per utility bay side) and BHD Base Hinged Door included at one end.

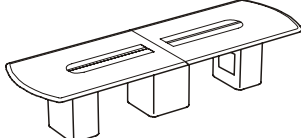

TT-BE-46144-ACE-RC

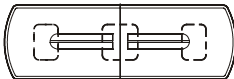

IMPORTANT: Tables are standard with wood grain running length of table.

Order information:

Qty	Model Number	Top finish	Base finish	Option
1	TR-46120-ACE-HC-WP2	WP2-31	WP2-31	
1	TB-BE-42120-ACE-RC-WP2	WP2-81	CP2-88	
2	TB-BE-46168-ACE-RC-WP2	CP2-28	WP2-71	
1	TWE-4672-ACE-RC-WP2	WP2-61	CP2-88	
2	TR-42144-ACE-HC-WP2	CP2-38	CP2-88	
1	7128	WP2-41	CP2-88	

Notes

Tables are shipped RTA (ready to assemble)

Important:

WoodPlus² Conference Tables are standard with wood grain running length of table.

Electrical Packages

ACT WoodPlus² Tables include MO20 Electrical Package appropriate for Table size. Electrician required to hardwire ACT electrical to building power.

7% price increase effective January 1, 2009

ACT Tables - WoodPlus²

Description	Model No.	Overall Dimensions		Wgt	List Prices WoodPlus ²
		Wide	Long		

ACT WoodPlus² Boat Bow End with Radius Cube Base

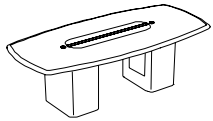

TB-BE-4296-ACE-RC

42" wide,	TB-BE-4272-ACE-RC-WP2	42	72	321	4854
One Piece Top	TB-BE-4284-ACE-RC-WP2	42	84	350	5387
	TB-BE-4296-ACE-RC-WP2	42	96	379	5760

Top: 1 piece; Base: 2 Radius Cubes. Includes MO20 ACT electrical outlets. Power Entry (one per utility bay side) and BHD Base Hinged Door included at one end.

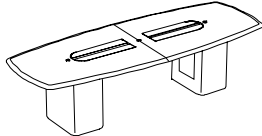
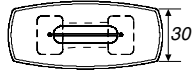

TB-BE-42120-ACE-RC

Two Piece Top	TB-BE-42120-ACE-RC-WP2	42	120	467	6918
----------------------	------------------------	----	-----	-----	-------------

Top: 2 piece; Base: 2 Radius Cubes. Includes MO20 ACT electrical outlets. Power Entry (one per utility bay side) and BHD Base Hinged Door included at one end.

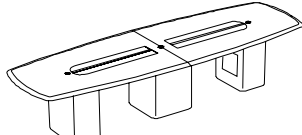

TB-BE-42144-ACE-RC

	TB-BE-42144-ACE-RC-WP2	42	144	577	8315
	TB-BE-42150-ACE-RC-WP2	42	150	592	9145
	TB-BE-42168-ACE-RC-WP2	42	168	630	10954

Top: 2 piece; Base: 3 Radius Cubes. Includes MO20 ACT electrical outlets. Power Entry (one per utility bay side) and BHD Base Hinged Door included at one end.

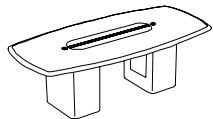

TB-BE-4696-ACE-RC

46" wide,	TB-BE-4672-ACE-RC-WP2	46	72	331	4854
One Piece Top	TB-BE-4684-ACE-RC-WP2	46	84	360	5387
	TB-BE-4696-ACE-RC-WP2	46	96	389	5760

Top: 1 piece; Base: 2 Radius Cubes. Includes MO20 ACT electrical outlets. Power Entry (one per utility bay side) and BHD Base Hinged Door included at one end.

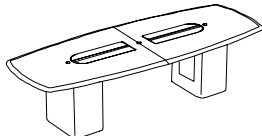

TB-BE-46120-ACE-RC

Two Piece Top	TB-BE-46120-ACE-RC-WP2	46	120	487	6918
----------------------	------------------------	----	-----	-----	-------------

Top: 2 piece; Base: 2 Radius Cubes. Includes MO20 ACT electrical outlets. BHD Base Hinged Door included at one base end component.

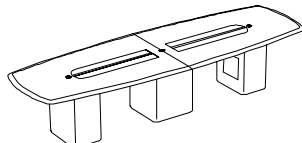

TB-BE-46144-RC

	TB-BE-46144-ACE-RC-WP2	46	144	597	8315
	TB-BE-46150-ACE-RC-WP2	46	150	612	9145
	TB-BE-46168-ACE-RC-WP2	46	168	655	10954

Top: 2 piece; Base: 3 Radius Cubes. Includes MO20 ACT electrical outlets. Power Entry (one per utility bay side) and BHD Base Hinged Door included at one end.

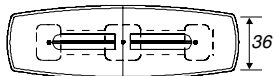

IMPORTANT: Tables are standard with wood grain running length of table.

WoodPlus² ACT Table Top Finishes

- WP2-41 Natural Maple
- WP2-81 Fusion Maple
- WP2-45 Anigre
- WP2-61 Pear
- WP2-31 Medium Cherry
- WP2-71 Dark Cherry
- CP2-28 Medium Grey Speckle
- CP2-38 Beige Speckle

WoodPlus² XTRA tops only (see upcharges)

- WP2-18 Shadow Oak
- WP2-65 Beech
- WP2-75 Port
- CP2-72 Shark Gray
- CP2-78 Bronze
- CP2-80 Cashmere Fiber

WoodPlus² ACT Table base Finishes

- WP2-41 Natural Maple
- WP2-81 Fusion Maple
- WP2-45 Anigre
- WP2-61 Pear
- WP2-31 Medium Cherry
- WP2-71 Dark Cherry
- CP2-88 Black
- CP2-98 Slate
- CP2-76 Espresso

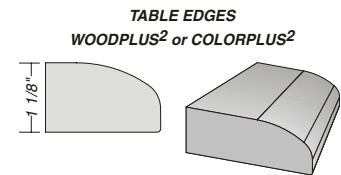

7% price increase effective January 1, 2009

ACT Tables - WoodPlus²

Description Model No. Overall Dimensions Wgt List Prices
Wide Long WoodPlus²

ACT WoodPlus² Racetrack with Half Cylinder Base

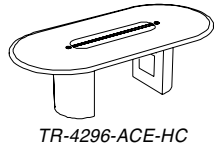

42" wide, One Piece Top	TR-4272-ACE-HC-WP2	42	72	321	4026
	TR-4284-ACE-HC-WP2	42	84	350	4590
	TR-4296-ACE-HC-WP2	42	96	379	4933

Top: 1 piece; Base: 2 Half Cylinders. Includes MO20 ACT electrical outlets. Power Entry (one per utility bay side) and BHD Base Hinged Door included at one end.

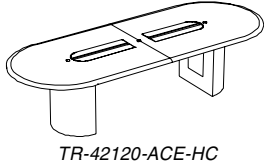

Two Piece Top	TR-42120-ACE-HC-WP2	42	120	467	6090
----------------------	---------------------	----	-----	-----	-------------

Top: 2 piece; Base: 2 Half Cylinders. Includes MO20 ACT electrical outlets. Power Entry (one per utility bay side) and BHD Base Hinged Door included at one end.

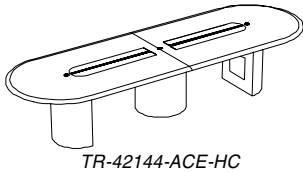

	TR-42144-ACE-HC-WP2	42	144	577	6725
	TR-42150-ACE-HC-WP2	42	150	592	8208
	TR-42168-ACE-HC-WP2	42	168	630	10019

Top: 2 piece; Base: 2 Half Cylinders, 1 Full Cylinder. Includes MO20 ACT electrical outlets. Power Entry (one per utility bay side) and BHD Base Hinged Door included at one end.

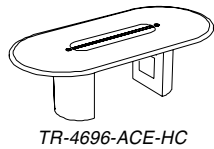

46" wide, One Piece Top	TR-4672-ACE-HC-WP2	46	72	311	4026
	TR-4684-ACE-HC-WP2	46	84	340	4590
	TR-4696-ACE-HC-WP2	46	96	369	4933

Top: 1 piece; Base: 2 Half Cylinders. Includes MO20 ACT electrical outlets. Power Entry (one per utility bay side) and BHD Base Hinged Door included at one end. Note: RHC base option not available on TR-4672-ACE-HC-WP2 table.

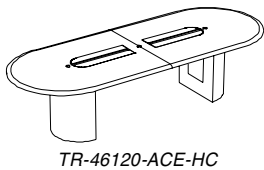

Two Piece Top	TR-46120-ACE-HC-WP2	46	120	467	5746
----------------------	---------------------	----	-----	-----	-------------

Top: 2 piece; Base: 2 Half Cylinders. Includes MO20 ACT electrical outlets. Power Entry (one per utility bay side) and BHD Base Hinged Door included at one end.

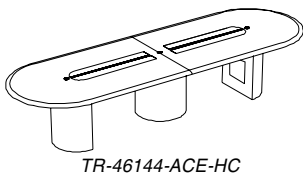

	TR-46144-ACE-HC-WP2	46	144	567	7128
	TR-46150-ACE-HC-WP2	46	150	582	8208
	TR-46168-ACE-HC-WP2	46	168	625	10019

Top: 2 piece; Base: 2 Half Cylinders, 1 Full Cylinder. Includes MO20 ACT electrical outlets. Power Entry (one per utility bay side) and BHD Base Hinged Door included at one end.

ACT WoodPlus² 'Egg' with Radius Half Cylinder Base

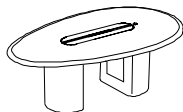

46" wide, One Piece Top	TEG-4676-ACE-RHC-WP2	46	76	462	4356
------------------------------------	----------------------	----	----	-----	-------------

Top: 1 piece; Base: 2 Radius Half Cylinders. Includes MO20 ACT electrical outlets. Power Entry (one per utility bay side) and BHD Base Hinged Door included at 'large' end.

IMPORTANT: Tables are standard with wood grain running length of table.

Order information:

Qty	Model Number	Top finish	Base finish	Option
1	TR-46120-ACE-HC-WP2	WP2-31	WP2-31	
1	TB-BE-42120-ACE-RC-WP2	WP2-81	CP2-88	
2	TB-BE-46168-ACE-RC-WP2	CP2-28	WP2-71	
1	TWE-4672-ACE-RC-WP2	WP2-61	CP2-88	
2	TR-42144-ACE-HC-WP2	CP2-38	CP2-88	
1	7128	WP2-41	CP2-88	

Notes

Tables are shipped RTA (ready to assemble)

Important:

WoodPlus² Conference Tables are standard with wood grain running length of table.

Electrical Packages

ACT WoodPlus² Tables include MO20 Electrical Package appropriate for Table size. Electrician required to hardwire ACT electrical to building power.

7% price increase effective January 1, 2009

ACT Table Options - WoodPlus and WoodPlus²

Description	Model No.	Overall Dimensions		Wgt	List Prices
		Long	Deep		

ACT Inlay Options - only available on WoodPlus table tops

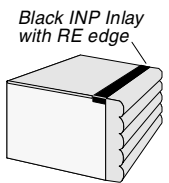

Black, Rectangular	CMR-INLAY-RECT-ALL-BLACK				413
---------------------------	--------------------------	--	--	--	------------

Black, Shaped	CMR-INLAY-SHAPE-ALL-BLACK				712
----------------------	---------------------------	--	--	--	------------

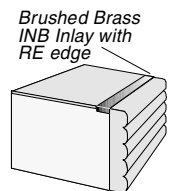

Brass, Rectangular	CMR-INLAY-RECT-ALL-BRASS				826
---------------------------	--------------------------	--	--	--	------------

Brass, Shaped	CMR-INLAY-SHAPE-ALL-BRASS				1409
----------------------	---------------------------	--	--	--	-------------



Chrome, Rectangular	CMR-INLAY-RECT-ALL-CHROME				826
----------------------------	---------------------------	--	--	--	------------

Chrome, Shaped	CMR-INLAY-SHAPE-ALL-CHROME				1409
-----------------------	----------------------------	--	--	--	-------------

Radius Corners added to a Table top - only available on WoodPlus table tops

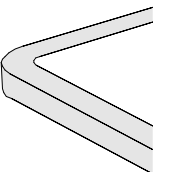

Add Radius	Top-C3R-WPE	412
Corners	Top-C3R-STD	412
	Top-C3R-DET	594
	Top-C3R-2000	840
	Top-C3R-3000	840

3" radius on the inside of the edge. To order add '-C3R' to the end of the table model. Rectangular top with Radius corners uses the the Shaped top INLAY upcharge. Not available on the 3400 Reverse Knifecut Edge.

Adding Bow Ends to a Rectangular or Boat Shaped Table - only available on WoodPlus table tops

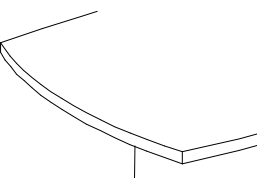

Add Bow Ends	Top-BE-WPE	283
	Top-BE-STD	283
	Top-BE-DET	283
	Top-BE-2000	283
	Top-BE-3000	283

To order add '-BE' to the end of the table model number. Rectangular top with Bow End uses the Shaped top INLAY charge.

Flat Screen storage in base - available on tables 48" or wider

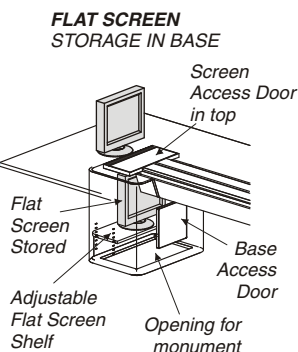

Storage for flatscreen	ACT-FLATSCR-STORAGE	401
-------------------------------	---------------------	------------

Use of this option requires a 48" minimum table width. Adds a door in the top and a shelf in the base below to store a flatscreen monitor when not in use. Please specify actual dimensions of flatscreen to be stored.

For example, on 48" wide table with the full RC Radius Cube base, the door in the table top is 11" long (the length of the table) and 21" wide (width of the table). Maximum height is 26".

7% price increase effective January 1, 2009

ACT Table Options - WoodPlus and WoodPlus²

Description	Model No.	Overall Dimensions		Wgt	List Prices
		Long	Deep		

Base Options - available on all tables using these bases

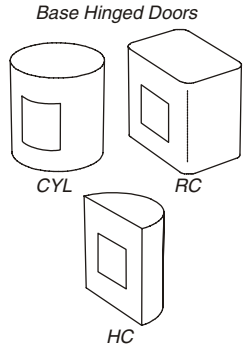

Base Hinged Door	BHD-RC	145
	BHD-HC	145
	BHD-RHC	145
	BHD-CYL	308

To order Base Hinged Doors add to end of the model number
 BHD-RC on Radius Cube, BHD-HC on Half Cylinder, BHD-RHC on Radius Half Cylinder,
 BHD-CYL on full Cylinder (used in CYL bases or as the center base on TR...HC tables).

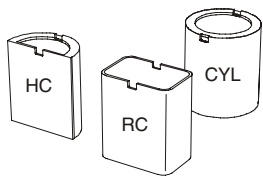

Base wire notch	NU-BASE-NOTCH-UPPER	97
------------------------	---------------------	-----------

Notches in both sides of the top edge of the all bases.

NU Base Notch option for wire pass through (includes each base of table)

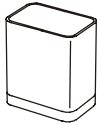

Base Silver Accent	BASE-SILVER-ACCENT-1	164
	BASE-SILVER-ACCENT-2	328
	BASE-SILVER-ACCENT-3	492
	BASE-SILVER-ACCENT-4	657

Add the 3" silver accent strip to the bottom of each table base: HC, CYL, RC.

Base Black Accent	BASE-BLACK-ACCENT-1	111
	BASE-BLACK-ACCENT-2	222
	BASE-BLACK-ACCENT-3	333
	BASE-BLACK-ACCENT-4	445

Add the 3" black accent strip to the bottom of each table base: HC, CYL, RC.

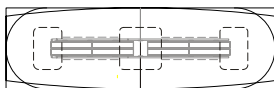

Power entry is supplied at one end of the table. To locate the power entry below the center base use the PEC option

Power Entry in center base	ACT-POWER-ENTRY-CENTER	316
-----------------------------------	------------------------	------------

Move the power entry to the center base.
 Power entry is supplied at one end of the table. To locate the power entry below the center base, use this option and add the suffix PEC to the model number.

PLUG END power option on ACT tables	In the ACT TABLE OVERVIEW section of this pricelist, immediately after the ACT TABLE MO20 ELECTRICAL PACKAGE pages, the OPTIONAL PLUG END ELECTRICAL FOR ACT TABLES is priced.
--	--

This option replaces the powerstrips that require hardwiring by an electrician to the building's power supply with powerstrips that have a PLUG END and can be plugged directly into a standard three prong outlet.
 These PLUG END powerstrips are UL Labeled.
 The MO20 hardwired powerstrips are 20 amp circuits with 15 amp outlets.
 The PLUG END powerstrips are 15 amp circuits with 15 amp outlets.

7% price increase effective January 1, 2009

ACT Table Options - WoodPlus and WoodPlus²

Description	Model No.	Overall Dimensions		Wgt	List Prices
		Long	Deep		

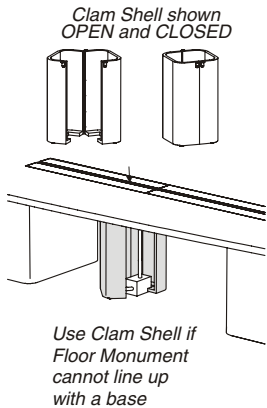

Clam shell base	BASE-CLAM-ACT				645
<p>Size is 12 by 12 and fits between the floor and the bottom of the ACT table utility bay. This is not a structural unit. Use the clam shell base to protect and hide wiring when the power / wiring access is not located at a table base</p>					

Add equipment rack to RC base

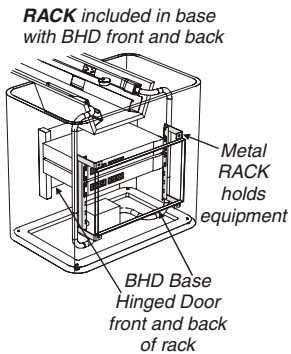

Equipment Rack	BASE-RACK-RAILS				736
<p>Use of this option requires a 48" minimum table width. Includes pair of Rack Rails mounted to the table base locking doors on both sides of the base, vents on both sides of the base. Rack Rails are 10 space 17.5 high, mounted on the inside of the base. Will fit in a RC Radius Cube base on a 58" wide table such as TT Rectangle, TB Boat shaped, TDE Delta (large end only). The end base has 18.5" clear inside front to back, center base has 28.5" clear front to back. Note that the CENTER location includes a cord access opening in the utility bay. Please contact Customer Service for requirements to install on other bases.</p>					

Add CPU storage to RC or CYL base

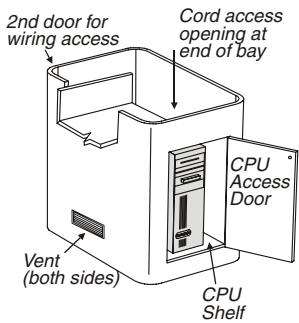

CPU storage in RC base	BASE-CPU-STORAGE-RC				623
<p>For an RC base used on TT, TB, TDE tables. Adds a fixed shelf, two doors (one for CPU and one for wiring access), doors locks, vents. Specify location of the CPU STORAGE as END or CENTER. Note that the CENTER location includes a cord access opening in the utility bay.</p>					

Table width	base location	door opening	depth	
42 wide table	center RC	18 by 18	10 by 19	16.5 including connections
46 wide table	end RC	14 by 20	6 by 19	18.5 including connections
	center RC	20 by 20	12 by 19	18.5 including connections
48 wide table	end RC	16 by 24	8 by 19	22.5 including connections
	center RC	24 by 24	12 by 19	22.5 including connections
58 wide table	end RC	20 by 30	12 by 19	28.5 including connections
	center RC	30 by 30	12 by 19	28.5 including connections

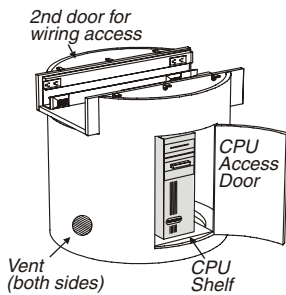

CPU storage in CYL base	BASE-CPU-STORAGE-CYL				950
<p>For a CYL Cylinder base used on TR tables. Adds a fixed shelf, two doors (one for CPU and one for wiring access), doors locks, vents. Specify location of the CPU STORAGE as CENTER. Note that the CENTER location includes a cord access opening in the utility bay.</p>					

Table width	base location	door	opening	depth
42 wide table	center CYL	18 by 18	8.5 by 17.5	16.5 including connections
46 wide table	center CYL	20 by 20	9.4 by 17.5	18.5 including connections
48 wide table	center CYL	24 by 24	11.3 by 19	22.5 including connections
58 wide table	center CYL	30 by 30	11.5 by 19	28.5 including connections

7% price increase effective January 1, 2009

ACT Table Options - WoodPlus and WoodPlus²

Description	Model No.	Overall Dimensions		Wgt	List Prices
		Long	Deep		

Add polycom storage to ACT table

Storage for polycom	ACT-POLYCOM-STORAGE				350
	Adds a storage slot in the bottom of the utility bay to hold a polycom. Please specify the overall size and shape of the polycom unit.				

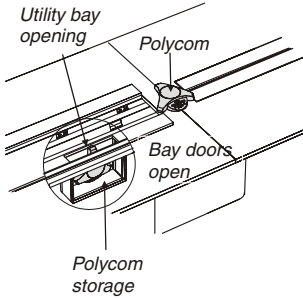

INSERTS for Bezels with connector for ACT and KAIZEN tables

Category 6	INSERT-2A-145-CC6-BK	27
	INSERT-2A-245-CC6-BK	54
Category 5e	INSERT-2A-145-C5EU-BK	17
	INSERT-2A-245-C5EU-BK	30
Phone Jack	INSERT-2A112-U2-BK	15
USOC wiring	INSERT-2A212-U2-BK	23
Audio	INSERT-2A-1RCA-BK	18
Video	INSERT-2A-1SVHS-BK	36

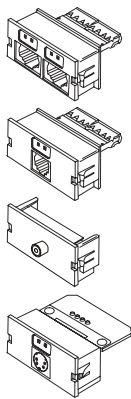

Bezels	BEZEL-CUTOUT	38
---------------	--------------	-----------

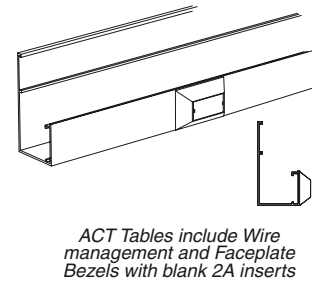
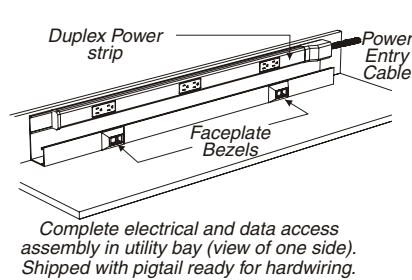
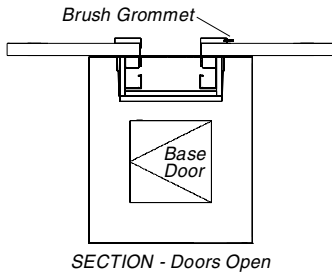

ACT and **TKZ KAIZEN** tables are shipped with blank inserts in all of the bezels.

The above INSERTS with the connector already installed in it, may be ordered separately and shipped with your table.

The number of bezels varies by the size and type of table, please refer to the beginning of the ACT table section or the TKZ Kaizen table section.

Other INSERTS are available from Pass & Seymour on the web at <http://passandseymour.com>.

More INSERT links are available on our website at <http://www.magnadesign.com/inserts.html>

MINI-ACT Tables

Comparison of MINI-ACT flexibility and ACT table capacity, example 1:

In this example, we compare a Boat shaped conference table at 58 deep and 192 long (4' 10" by 16').

In Specification 1 we install two of the MINI-ACT-3-4-JPLUG units that plug into floor outlets, two Base Hinged Doors, with a total of six outlets and eight data openings.

In Specification 2 we install three MINI-ACT-3-4, one STARTER and two ADDER, that are hardwired to the building power, one Base Hinged Door and the wiremanager V-BAY (two sections, one between each pair of bases) with a total of nine outlets and twelve data openings.

In Specification 3 we use an ACT table which includes the MO20 power that is hardwired to the building power, the Utility bay for wiremanager and storage, one Base Hinged Door, and a total of twenty-four outlets and twelve data openings.

Specification 1: J-Plug Mini-Act units

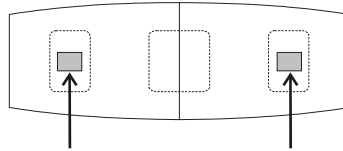
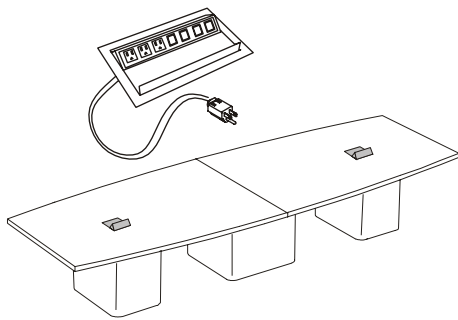

SPECIFICATIONS:

Table shape	Boat top conference table
Table base	Radius Cube bases
Power / data info	Base Hinged Doors (2) Mini-Act 3-4-JPLUG (2)
Electrical	J-Plug
Outlets	six
Data openings	eight

Specification 2: Hardwired Mini-Act units with V-Bay

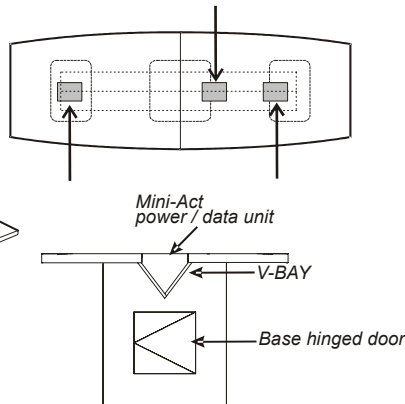
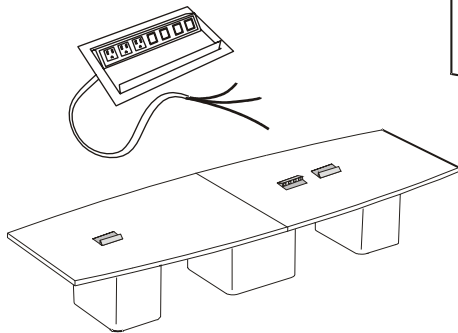

SPECIFICATIONS:

Table shape	Boat top conference table
Table base	Radius Cube bases
Power / data info	Base Hinged Doors (1) Mini-Act 3-4-Starter (1) Mini-Act 3-4-Adder (2)
Wire management:	V-Bay in two sections
Electrical	Hardwired
Outlets	nine
Data openings	twelve

Specification 3: ACT table with hardwired power and Utility Bay

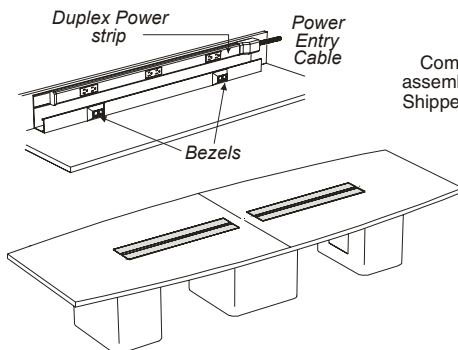

Complete electrical and data access assembly in utility bay (view of one side). Shipped with pigtail ready for hardwiring.

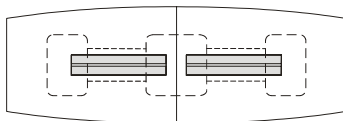

SPECIFICATIONS:

Table shape	Boat top ACT table
Table base	Radius Cube bases
Power / data info	Base Hinged Doors (1) MO20 power ACT table data
Wire management:	ACT U-Bay included and storage area
Electrical	Hardwired
Outlets	twenty-four
Data openings	twelve

MINI-ACT Tables

Comparison of MINI-ACT flexibility and ACT table capacity, example 2:

In this example, we compare a Delta shaped conference table at 58 deep and 120 long (4' 10" by 10').

In Specification 1 we install one of the MINI-ACT-3-4-JPLUG units that plug into floor outlets, one Base Hinged Door, with a total of three outlets and four data openings.

In Specification 2 we install two MINI-ACT-3-4, one STARTER and one ADDER, that are hardwired to the building power, one Base Hinged Door and the wiremanager V-BAY (one sections, one between each pair of bases) with a total of six outlets and eight data openings.

In Specification 3 we use an ACT table which includes the MO20 power that is hardwired to the building power, the Utility bay for wiremanager and storage, one Base Hinged Door, and a total of sixteen outlets and eight data openings.

Specification 1: J-Plug Mini-Act units

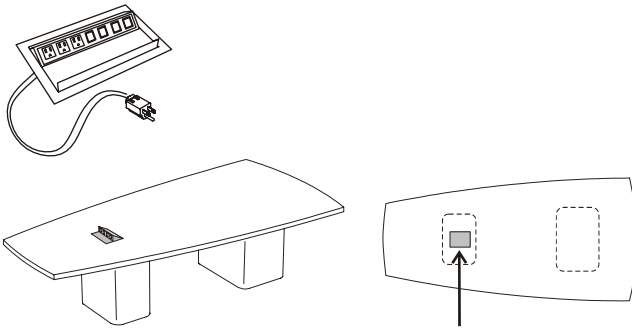

SPECIFICATIONS:

Table shape	Delta top conference table
Table base	Radius Cube bases
Power / data info	Base Hinged Doors (1) Mini-Act 3-4-JPLUG (1)
Electrical	J-Plug
Outlets	three
Data openings	four

**Specification 2:
Hardwired Mini-Act units with V-Bay**

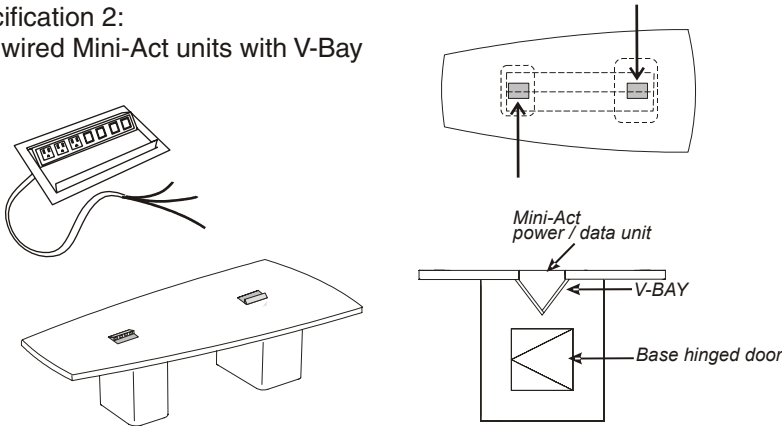

SPECIFICATIONS:

Table shape	Delta top conference table
Table base	Radius Cube bases
Power / data info	Base Hinged Doors (1) Mini-Act 3-4-Starter (1) Mini-Act 3-4-Adder (1)
Wire management:	V-Bay included
Electrical	Hardwired
Outlets	six
Data openings	eight

**Specification 3:
ACT table with hardwired power and Utility Bay**

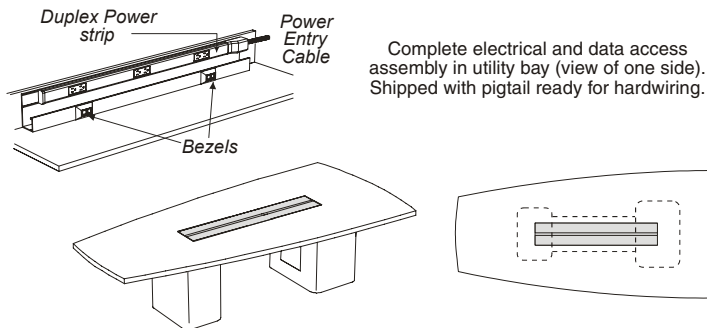

SPECIFICATIONS:

Table shape	Delta top ACT table
Table base	Radius Cube bases
Power / data info	Base Hinged Doors (1) MO20 power ACT table data
Wire management:	ACT U-Bay included and storage area
Electrical	Hardwired
Outlets	sixteen
Data openings	eight

MINI-ACT Tables

Example: setting up the MINI-ACT table:

- 1) Choose the table and accessories to fit your space. Pages 9 through 13 have seating capacity and layout guidelines.
- 2) Determine your table top power and data requirements, then choose and locate the power / data units to be included

MINI-ACT-2-2.... Power - data unit includes two outlets and two data connection ports with adapters



MINI-ACT-3-4.... Power - data unit includes three outlets and four data connection ports with adapters



- 3) For easy access to a floor monument, include the optional BHD Base Hinged Door on the base located over the monument.
- 4) If the power / data unit is not located over a table base with floor monument, you may keep all of the wiring off of the floor by using either the V-BAY wiremanager or two facing MJT wiremanagers and notches in the tops of the table bases.
- 5) Determine your data connection requirements and either provide your own inserts and connectors or include from those shown here. Use the inserts that begin with INSERT-MA....
For example INSERT-MA-S68-RJ45-AL is a Category 6 RJ45 jack.

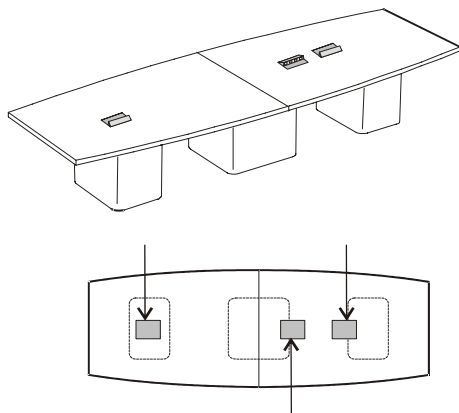

EXAMPLE: adding three MINI-ACT-3-4-JPLUG to TB58168-RC table.

One MINI-ACT power - data units is specified directly above an end base. Two are between the center and other end base. Optional Base Hinged Doors may be added to any or all of the table bases.

For the J-PLUG models, the units must be within 10' of the floor monument. For the hardwired STARTER and ADDER units, the floor monument / power connection may be located at any of the table bases.

The V-BAY wiremanager is a good option for running the wiring between power - data units and manages the wiring when the power - data units are not directly over a table base. Each V-Bay section connects two of the table bases. Please specify the floor monument locations.

Typical section view of table top, table base and V-BAY wiremanager.

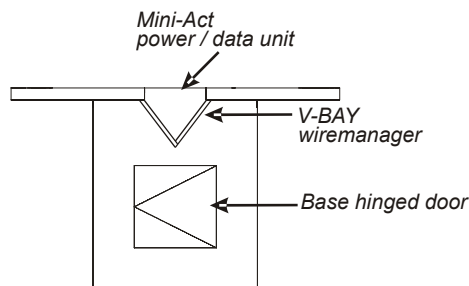

7% price increase effective January 1, 2009

MINI-ACT Tables

MINI-ACT Power - Data units, V-BAY wiremanager, Data Connectors

Description	Model Number	List
MINI-ACT 3-4 double doors	MINI-ACT-3-4-120-JPLUG 120" plugin cord	494
	MINI-ACT-3-4-72-STARTER 72" power entry cable, hardwired	530
	MINI-ACT-3-4-48-ADDER up to 48" between units, hardwired	386
	MINI-ACT-3-4-72-ADDER up to 72" between units, hardwired	429
	MINI-ACT-3-4-120-ADDER up to 120" between units, hardwired	479

May be used either open (outlets and data ports visible) or closed (outlets and data ports not visible). Available in black or silver.

MINI-ACT 2-2 single door	MINI-ACT-2-2-120-JPLUG 120" plugin cord	396
	MINI-ACT-2-2-72-STARTER 72" power entry cable, hardwired	434
8.25" x 4.5"	MINI-ACT-2-2-48-ADDER up to 48" between units, hardwired	292
	MINI-ACT-2-2-72-ADDER up to 72" between units, hardwired	324
	MINI-ACT-2-2-120-ADDER up to 120" between units, hardwired	383

Must be used open (outlets and data ports visible). Available in black or silver.

The STARTER and ADDER MINI-ACT-3-4... models and MINI-ACT-2-2... models may NOT be combined on the same circuit.

fit over bases When a MINI-ACT unit is located directly over a table base, any cutouts in the table base required for the unit to open and close are automatically included.

Orientation When placed in a table, orientation is to the **SIDE** of the table.

Location MINI-ACT Power - Data units use the same locations as grommets, over the bases at the end of the table use E1, E2, over the bases in between the end bases or for the center of the table use C1, C2 (288" only)

V-BAY sections V-BAY-SECTION-1 cutouts in the table bases are included **301**

Bases use V-BAY-SECTIONS

2	-	1	42" or 48" deep to 120" long; 58" deep to 150" long; Egg
3	-	2	48" deep over 120" long; 58" deep from 168" to 240" long
4	-	3	58" deep at 288" long

Base Hinged Doors	BHD-RC Add base hinged door to Radius Cube base	145
	BHD-HC Add base hinged door to the flat side of half cyl	145
	BHD-RHC Add base hinged door to the flat side of RHC	145
	BHD-CYL Add base hinged door to a fullcylinder	308

MINI-ACT INSERTS	INSERT-MA-CAT6-RJ45-S68	28
	INSERT-MA-CAT5-RJ45-S58	17
	INSERT-MA-PHONE-RJ25-S6U-BK	14
	INSERT-MA-AUDIO-RCA	15
	INSERT-MA-VIDEO-1SVHS	18

TOP ACCENT	TOP-ACCENT-WP-SECTION any standard WoodPlus or WoodPlus XTRA	711
	TOP-ACCENT-LAM-SECTION any standard HPL pattern	711
	TOP-ACCENT-METAL-SECTION uses the metal sheet with phenolic backer	833
	One Top Accent when 42" or 48" deep to 120" long; 58" deep to 150" long; Egg	
	Two Top Accents when 48" deep over 120" long; 58" deep from 168" to 240" long	
	Three Top Accents when 58" deep at 288" long	

Accent 'fits between' two MINI-ACT power - data units on the table top. It is also available as option without power-data units on the table top.

METRO ACCENT	METRO-ACCENT-WP-EA any standard WoodPlus or WoodPlus XTRA	268
	METRO-ACCENT-HPL-EA any standard HPL pattern	268
	METRO-ACCENT-METAL-EA uses the solid metal sheet material	390

Accent is inset between the METRO base ends. Price per table base.

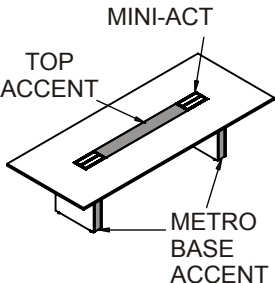
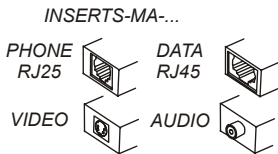
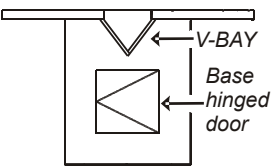
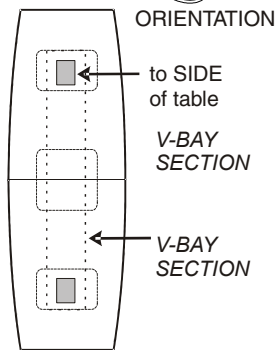
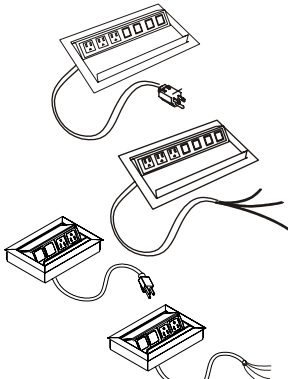

7% price increase effective January 1, 2009

MINI-ACT Tables

Conference tables: typical distance between bases

You may use the dimensions, typically from the center of one table base to the center of the adjacent one, to gauge the length of the plugin power cord or the length of the hardwired adder connection when ordering the MINI-ACT units.

TB48120-RC

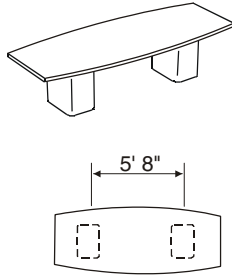

TDE58120-RC

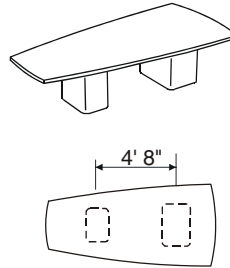

TR48144-HC

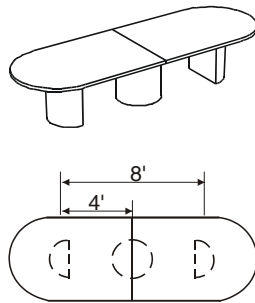

TT58168-RC

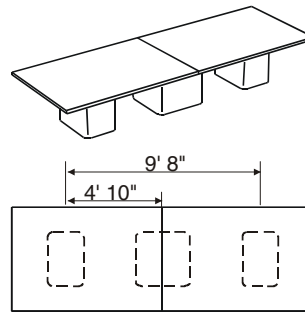

TR58168-CYL

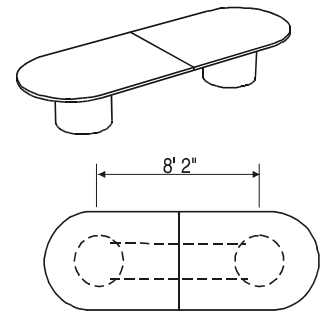

TB58192-RC

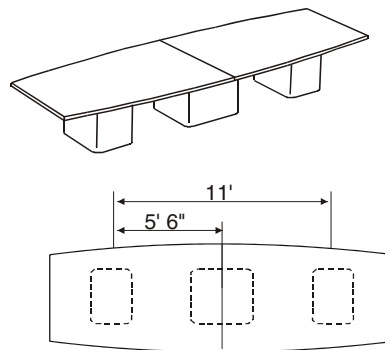

TR58192-CYL

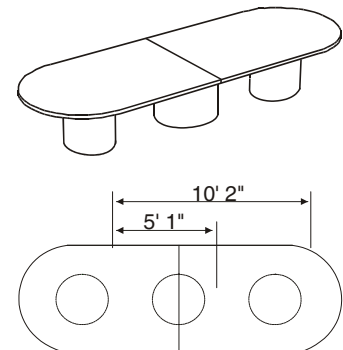

Conference Tables

Overview - Conference Tables

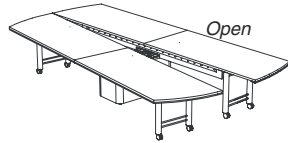
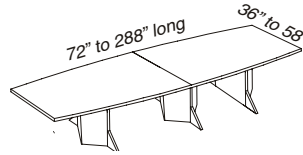
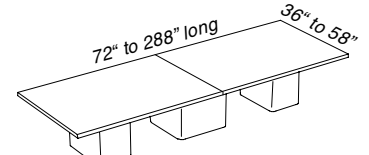

Figure , "Conference Kaizen articulating table," on page 67



Arrow - Triangle Base, Pg 70



Rectangular - Radius Cube Base, Pg 71

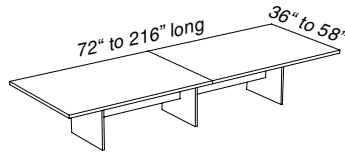

Rectangular - Panel End Base, Pg 73

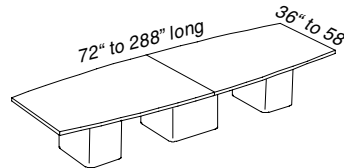

Boat Shape - Radius Cube Base, Pg 74

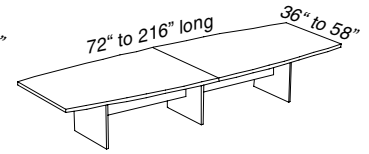

Boat Shape - Panel End Base, Pg 76

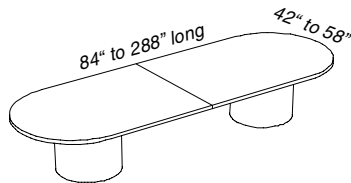

Racetrack - Full Cylinder Base, Pg 77

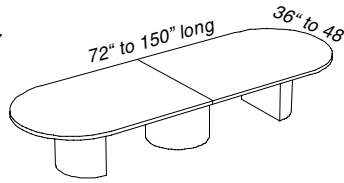

Racetrack - Half Cylinder Base, Pg 78

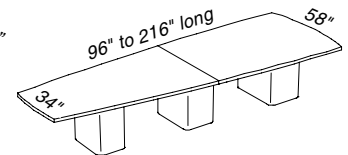

Delta - Radius Cube Base, Pg 79

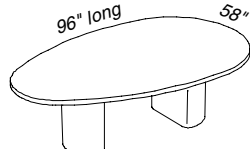

Egg Shape - Radius Half Cylinder Base, Pg 79

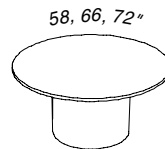

Round - Full Cylinder Base, Pg 80

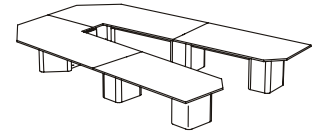

Wing Conference table - Radius Cube base, Pg 80

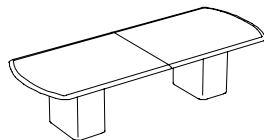

TT-BE-46120-RC

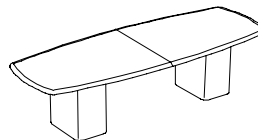

TB-BE-46120-RC

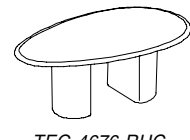

TEG-4676-RHC

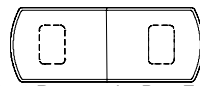

WoodPlus2 Rectangular Bow End Tables with Radius Cube Base, Pg 81

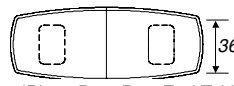

WoodPlus2 Boat Bow End Table with Radius Cube Base, Pg 82



WoodPlus2 'Egg' Table with Radius Half Cylinder Base, Pg 85

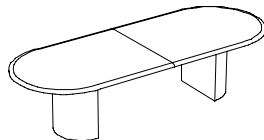

TR-46120-HC

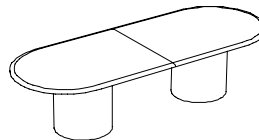

TR-46120-CYL



TD-46-COLX

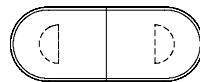

WoodPlus2 Racetrack Table with Half Cylinder Base, Pg 83

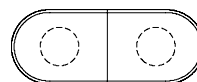

WoodPlus2 Racetrack Table with Full Cylinder Base, Pg 84



WoodPlus2 Round Tables, Pg 85

Conference Tables

Boat TB shaped top table base information

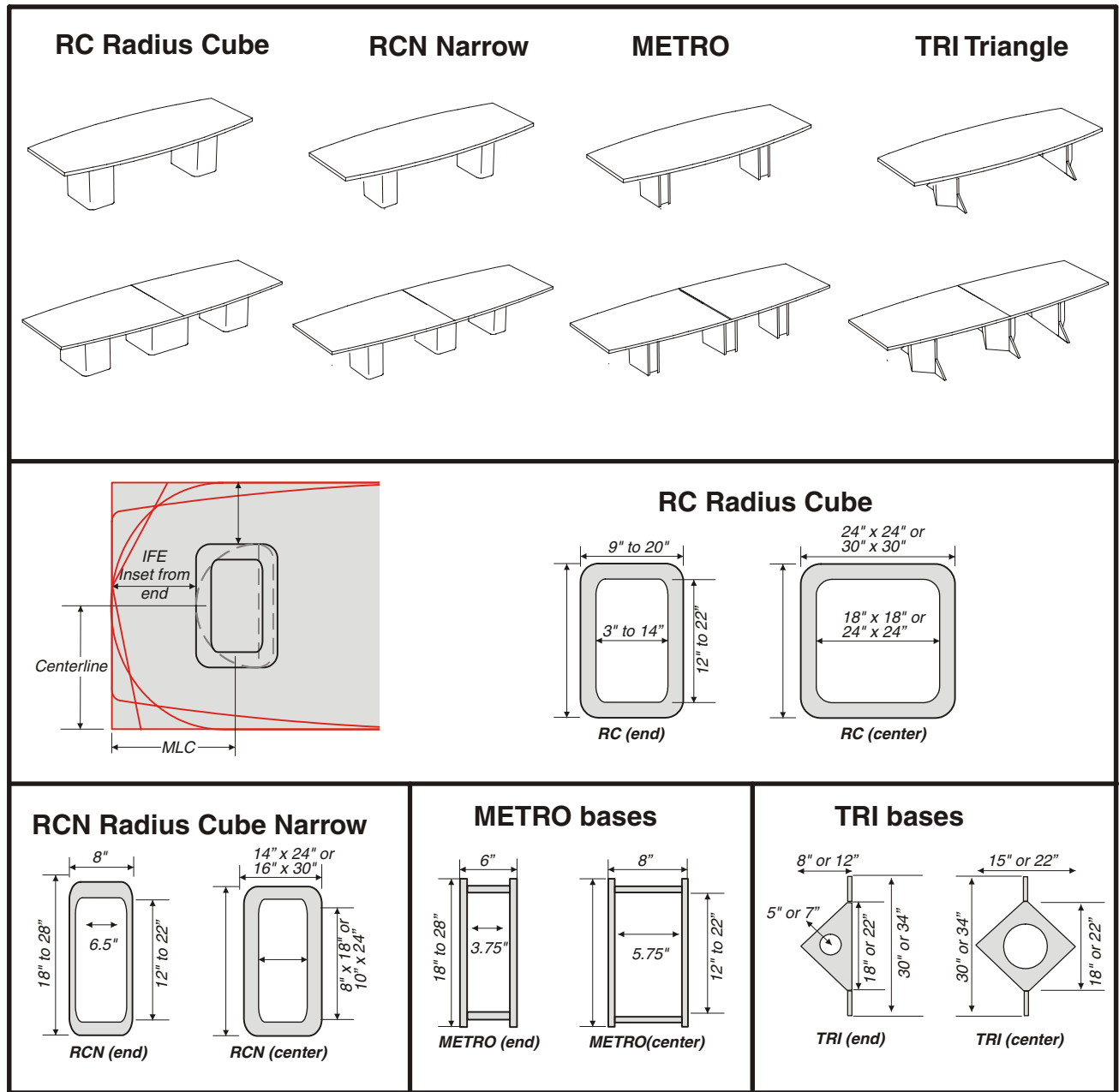

7% price increase effective January 1, 2009

Conference Tables

Boat TB shaped top table base information

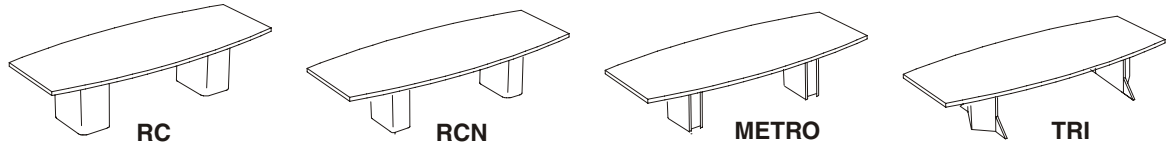

Wide	Long	(A) MLC	RC base (C)				RCN base (C)				METRO base (C)				TRI base (C)			
			Qty	End	Center	IFE	Qty	End	Center	IFE	Qty	End	Center	IFE	Qty	End	Center	IFE
36	72		2	9x18		14	2	8x18		15	2	6x18		16	2	8x30		14
42	72	20	2	9x18		14	2	8x18		15	2	6x18		16	2	8x30		14
42	84	24	2	9x18		18	2	8x18		20	2	6x18		18	2	8x30		18
42	96	24	2	12x18		18	2	8x18		20	2	6x18		18	2	8x30		20
42	120	24	2	12x18		18	2	8x18		20	2	6x18		18	2	8x30		20
42	144	24	3	12x16	18x18	18	3	8x16	12x18	20	3	6x16	8x18	18	3	8x30	15x30	20
42	150	24	3	12x16	18x18	18	3	8x16	12x18	20	3	6x16	8x18	18	3	8x30	15x30	20
42	168	24	3	12x16	18x18	18	3	8x16	12x18	20	3	6x16	8x18	18	3	8x30	15x30	20
46	72	25	2	14x20		18	2	8x20		21	2	6x20		22	2	8x30		21
46	84	25	2	14x20		18	2	8x20		21	2	6x20		22	2	8x30		21
46	96	25	2	14x20		18	2	8x20		21	2	6x20		22	2	8x30		21
46	120	25	2	14x20		18	2	8x20		21	2	6x20		22	2	8x30		21
46	144	25	3	14x18	20x20	18	3	8x18	14x20	21	3	6x20	8x20	22	3	8x30	15x30	21
46	150	25	3	14x18	20x20	18	3	8x18	14x20	21	3	6x20	8x20	22	3	8x30	15x30	21
46	168	25	3	14x18	20x20	18	3	8x18	14x20	21	3	6x20	8x20	22	3	8x30	15x30	21
48	72	20	2	12x22		14	2	8x22		15	2	6x22		16	2	8x30		18
48	84	24	2	12x22		18	2	8x22		20	2	6x22		18	2	8x30		18
48	96	24	2	12x22		18	2	8x22		20	2	6x22		18	2	8x30		18
48	120	24	2	16x22		18	2	8x22		20	2	6x22		18	2	8x30		18
48	144	24	3	14x20	24x24	18	3	8x20	14x24	20	3	6x20	8x24	18	3	8x30	15x30	18
48	150	24	3	14x20	24x24	18	3	8x20	14x24	20	3	6x20	8x24	18	3	8x30	15x30	18
48	168	24	3	14x20	24x24	18	3	8x20	14x24	20	3	6x20	8x24	18	3	8x30	15x30	18
58	120	26	2	20x28		20	2	8x28		22	2	6x28		20	2	12x34		24
58	144	26	2	20x28		20	3	8x24	16x30	22	3	6x24	8x30	20	2	12x34		24
58	150	26	2	20x28		20	3	8x24	16x30	22	3	6x24	8x30	20	2	12x34		24
58	168	26	3	16x24	30x30	20	3	8x24	16x30	22	3	6x24	8x30	20	3	12x34	22x34	24
58	180	26	3	16x24	30x30	20	3	8x24	16x30	22	3	6x24	8x30	20	3	12x34	22x34	24
58	192	26	3	16x24	30x30	20	3	8x24	16x30	22	3	6x24	8x30	20	3	12x34	22x34	24
58	216	28	3	16x24	30x30	20	3	8x24	16x30	24	3	6x24	8x30	24	3	12x34	22x34	24
58	240	28	3	16x24	30x30	20	3	8x24	16x30	24	3	6x24	8x30	24	3	12x34	22x34	24
58	288	28(B)	4	16x24	30x30	20	4	8x24	16x30	24	4	6x24	8x30	24	4	12x34	22x34	24

(A) - MLC - center of the monument location is this distance from the end of the table

(B) - MLC - center base monument location is 104" or 8' 8" from the end of the table

(C) - IFE - Inset From End - how far is the base from the end of the table

Monument cutout for

RC Radius Cube and RCN Radius Cube Narrow bases is 6" less in each dimension. Exception for RC or RCN bases 8" or 9" long.

METRO bases at 6" wide is 3.75", at 8" wide is 5.75". For length, deduct 4" from the length of the base.

TRI end bases at 28 long, opening is 5" diameter, TRI center bases at 28" long, opening is 7".

TRI end bases at 34 long, opening is 7" diameter, TRI center bases at 34" long, opening is 7".

7% price increase effective January 1, 2009

Conference Tables

Rectangle TT and Arrow TAR table base information

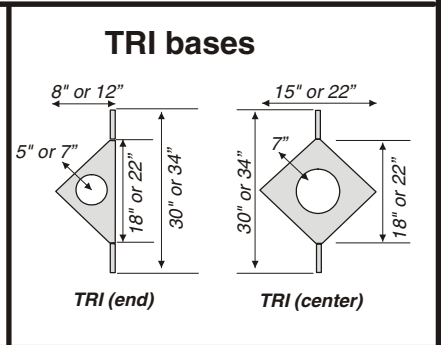
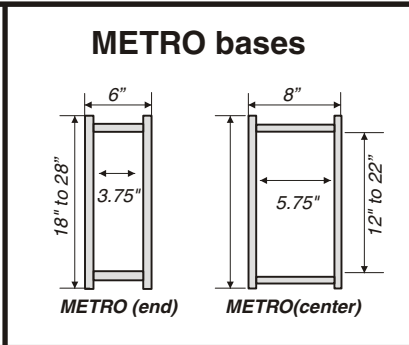
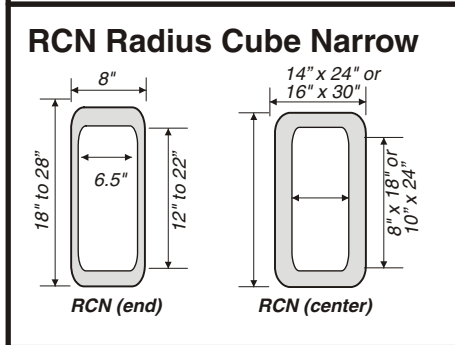
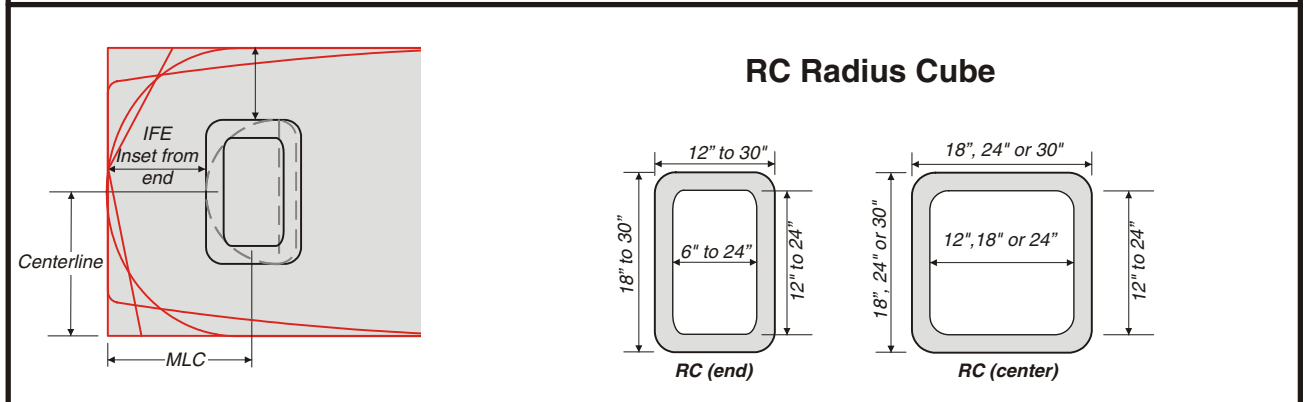
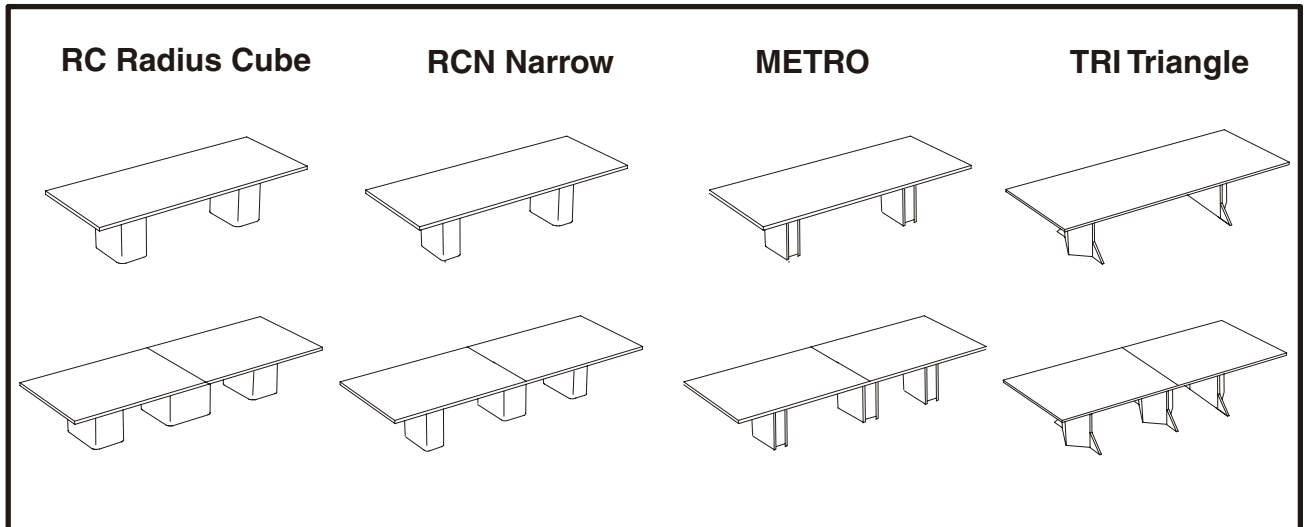

7% price increase effective January 1, 2009

Conference Tables

Rectangle TT and Arrow TAR table base information

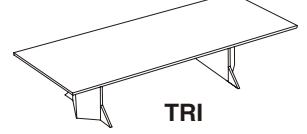
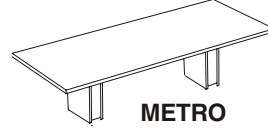
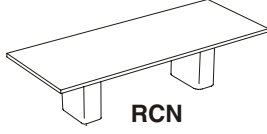
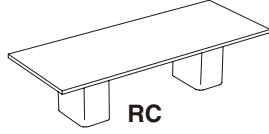

Wide	Long	(A) MLC	RC base (C)				RCN base (C)				METRO base (C)				TRI base (C)			
			Qty	End	Center	IFE	Qty	End	Center	IFE	Qty	End	Center	IFE	Qty	End	Center	IFE
36	72	24	2	12x18		18	2	8x18		20	2	6x18		21	2	8x30		18
42	72	24	2	12x18		18	2	8x18		20	2	6x18		21	2	8x30		18
42	84	24	2	12x18		18	2	8x18		20	2	6x18		21	2	8x30		18
42	96	24	2	12x18		18	2	8x18		20	2	6x18		21	2	8x30		18
42	120	24	2	12x18		18	2	8x18		20	2	6x18		21	2	8x30		18
42	144	24	3	12x18	18x18	18	3	8x18	12x18	20	3	6x18	8x18	21	3	8x30	15x30	18
42	150	24	3	12x18	18x18	18	3	8x18	12x18	20	3	6x18	8x18	21	3	8x30	15x30	18
42	168	24	3	12x18	18x18	18	3	8x18	12x18	20	3	6x18	8x18	21	3	8x30	15x30	18
46	72	25	2	14x20		18	2	8x20		21	2	6x20		22	2	8x30		21
46	84	25	2	14x20		18	2	8x20		21	2	6x20		22	2	8x30		21
46	96	25	2	14x20		18	2	8x20		21	2	6x20		22	2	8x30		21
46	120	25	2	14x20		18	2	8x20		21	2	6x20		22	2	8x30		21
46	144	25	3	14x20	20x20	18	3	8x20	14x20	21	3	6x20	8x20	22	3	8x30	15x30	21
46	150	25	3	14x20	20x20	18	3	8x20	14x20	21	3	6x20	8x20	22	3	8x30	15x30	21
46	168	25	3	14x20	20x20	18	3	8x20	14x20	21	3	6x20	8x20	22	3	8x30	15x30	21
48	72	24	2	16x24		18	2	8x24		22	2	6x24		23	2	8x30		18
48	84	24	2	16x24		18	2	8x24		22	2	6x24		23	2	8x30		18
48	96	24	2	16x24		18	2	8x24		22	2	6x24		23	2	8x30		18
48	120	24	2	16x24		18	2	8x24		22	2	6x24		23	2	8x30		18
48	144	24	3	16x24	24x24	18	3	8x24	14x24	22	3	6x24	8x24	23	3	8x30	15x30	18
48	150	24	3	16x24	24x24	18	3	8x24	14x24	22	3	6x24	8x24	23	3	8x30	15x30	18
48	168	24	3	16x24	24x24	18	3	8x24	14x24	22	3	6x24	8x24	23	3	8x30	15x30	18
58	120	30	2	20x30		20	2	8x30		26	2	6x30		26	2	12x34		24
58	144	30	2	20x30		20	2	8x30		26	2	6x30		26	2	12x34		24
58	150	30	2	20x30		20	2	8x30		26	2	6x30		26	2	12x34		24
58	168	30	3	20x30	30x30	20	3	8x30	16x30	26	3	6x30	8x30	26	3	12x34	22x34	24
58	180	30	3	20x30	30x30	20	3	8x30	16x30	26	3	6x30	8x30	26	3	12x34	22x34	24
58	192	30	3	20x30	30x30	20	3	8x30	16x30	26	3	6x30	8x30	26	3	12x34	22x34	24
58	216	30	3	20x30	30x30	20	3	8x30	16x30	26	3	6x30	8x30	26	3	12x34	22x34	24
58	240	30	3	20x30	30x30	20	3	8x30	16x30	26	3	6x30	8x30	26	3	12x34	22x34	24
58	288	30(B)	4	20x30	30x30	20	4	8x30	16x30	26	4	6x30	8x30	26	4	12x34	22x34	24

(A) - MLC - center of the monument locaton is this distance from the end of the table

(B) - MLC - center base monument locaton is 104" or 8' 8" from the end of the table

(C) - IFE - Inset From End - how far is the base from the end of the table

Monument cutout for

RC Radius Cube and RCN Radius Cube Narrow bases is 6" less in each dimension. Exception for RC or RCN bases 8" or 9" long.

METRO bases at 6" wide is 3.75", at 8" wide is 5.75". For length, deduct 4" from the length of the base.

TRI end bases at 28 long, opening is 5" diameter, TRI center bases at 28" long, opening is 7".

TRI end bases at 34 long, opening is 7" diameter, TRI center bases at 34" long, opening is 7".

7% price increase effective January 1, 2009

Conference Tables

Racetrack TR table base information

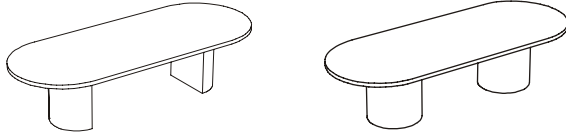

Wide	Long	(A) MLC	HC base (C)			CYL base (C)			
			Qty	End	Center	IFE	Qty	Diameter	IFE
36	72	24	2	10x18		18			
42	72	24	2	10x18		18	2	18x18	18
42	84	24	2	10x18		18	2	18x18	18
42	96	24	2	10x18		18	2	18x18	18
42	120	24	2	10x18		18	2	18x18	18
42	144	24	3	10x18	18x18	18	2	18x18	18
42	150	24	3	10x18	18x18	18	2	18x18	18
42	168	24	3	10x18	18x18	18	3	18x18	18
46	72	25	2	11x20		18			
46	84	25	2	11x20		18			
46	96	25	2	11x20		18	2	20x20	18
46	120	25	2	11x20		18	2	20x20	18
46	144	25	3	11x20	20x20	18	2	20x20	18
46	150	25	3	11x20	20x20	18	2	20x20	18
46	168	25	3	11x20	20x20	18	3	20x20	18
48	72	24	2	13x24		18			
48	84	24	2	13x24		18			
48	96	24	2	13x24		18	2	24x24	18
48	120	24	2	13x24		18	2	24x24	18
48	144	24	3	13x24	24x24	18	2	24x24	18
48	150	24	3	13x24	24x24	18	2	24x24	18
48	168	24	3	13x24	24x24	18	3	24x24	18
58	120	30	2	16x30		20	2	30x30	20
58	144	30	2	16x30		20	2	30x30	20
58	150	30	2	16x30		20	2	30x30	20
58	168	30	3	16x30	30x30	20	2	30x30	20
58	180	30	3	16x30	30x30	20	3	30x30	20
58	192	30	3	16x30	30x30	20	3	30x30	20
58	216	30	3	16x30	30x30	20	3	30x30	20
58	240	30	3	16x30	30x30	20	3	30x30	20
58	288	30(B)	4	16x30	30x30	20	4	30x30	20

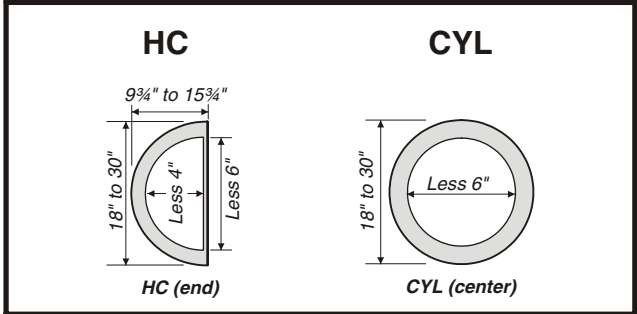
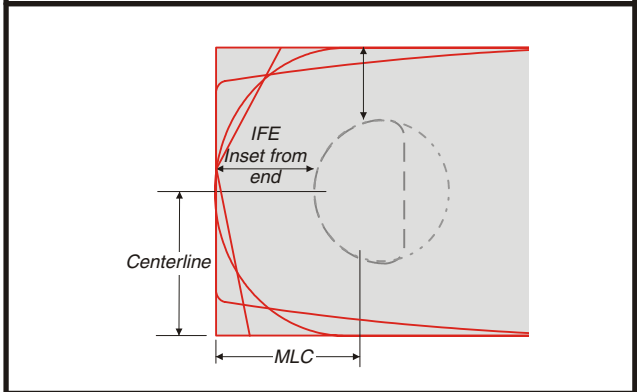
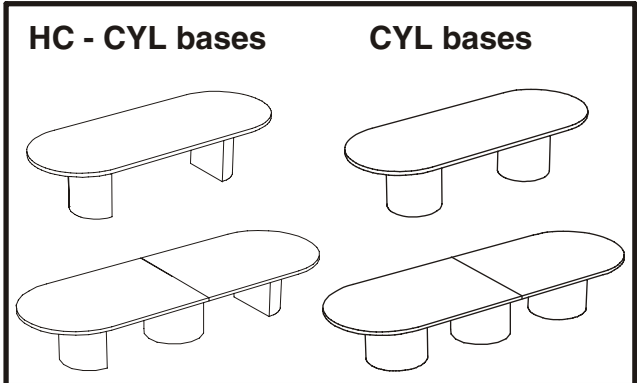

- (A) - MLC - center of the monument locaton is this distance from the end of the table
- (B) - MLC - center base monument locaton is 104" or 8' 8" from the end of the table
- (C) - IFE - Inset From End - how far is the base from the end of the table

Monument cutout for

HC Half Cylinder bases are 4" less in length and 6" less in width.

CYL Full Cylinder bases are 6" less in each dimension

7% price increase effective January 1, 2009

Conference Tables

Delta TDE table base information

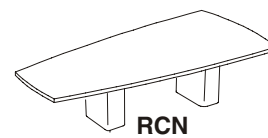
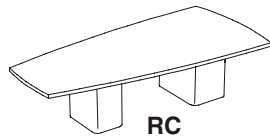
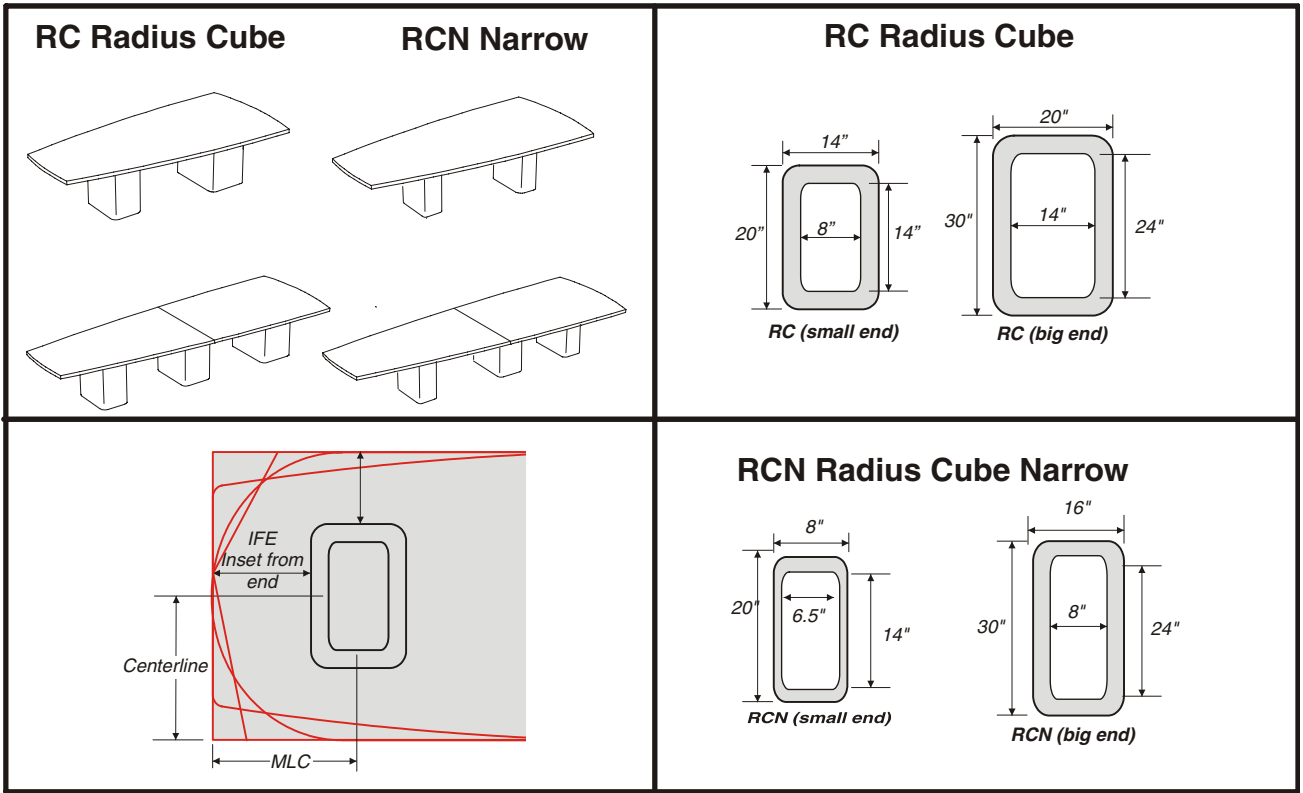

Wide	Long	MLC (A)		Qty	RC base (C)				Center	Qty	RCN base (C)				Center
		Small	Big		Small	IFE	Big	IFE			Small	IFE	Big	IFE	
58	96	35	28	2	14x20	28	20x30	18		2	8x20	31	16x30	20	
58	120	35	28	2	14x20	28	20x30	18		2	8x20	31	16x30	20	
58	144	35	28	2	14x20	28	20x30	18		2	8x20	31	16x30	20	
58	150	35	28	2	14x20	28	20x30	18		2	8x20	31	16x30	20	
58	168	35	28	3	14x20	28	20x30	18	30x30	3	8x20	31	16x30	20	16x30
58	180	35	28	3	14x20	28	20x30	18	30x30	3	8x20	31	16x30	20	16x30
58	192	35	28	3	14x20	28	20x30	18	30x30	3	8x20	31	16x30	20	16x30
58	216	35	28	3	14x20	28	20x30	18	30x30	3	8x20	31	16x30	20	16x30

(A) - MLC - center of the monument location from the end of the table - SMALL is the small end of the table, BIG is the big end of the table.

(C) - IFE - Inset From End - how far is the base from the end of the table

Monument cutout for

RC Radius Cube and RCN Radius Cube Narrow bases is 6" less in each dimension. Exception for RC or RCN bases 8" or 9" long.

7% price increase effective January 1, 2009

Conference Tables

Round TD table base information

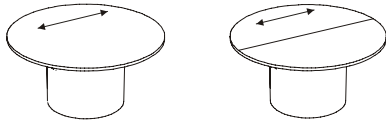

Diameter	(A)		CYL base		(C)
	MLC	Qty	Diameter	IFE	
58	29	1	30	14	
66	33	1	36	15	
72	36	1	36	18	

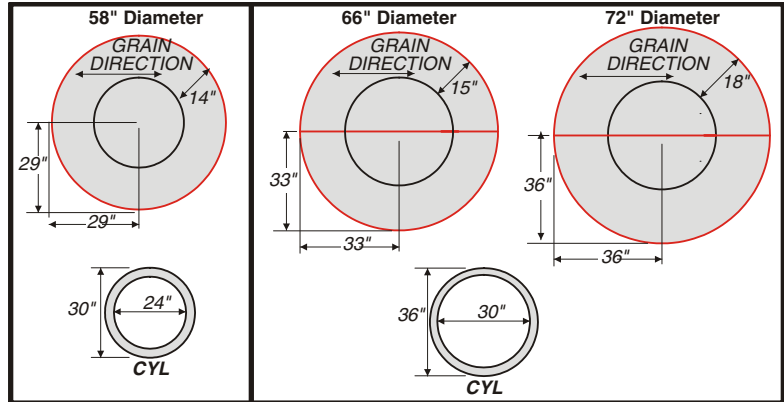

(A) - MLC - center of the monument location is this distance from the edge of the table

(C) - IFE - Inset From End - how far is the base from the edge of the table

Monument cutout for

CYL Full Cylinder bases are 6" less in each dimension

Egg shaped TEG table base information

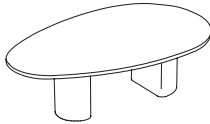

	(A)		RHC base		(C)
	MLC	Qty	Small	Big	
46	76		2	12x18	15x24
58	96		2	12x16	17x28

(A) - MLC - center of monument location shown in drawing to the right.

(C) - IFE - Inset From End - shown in drawing to the right

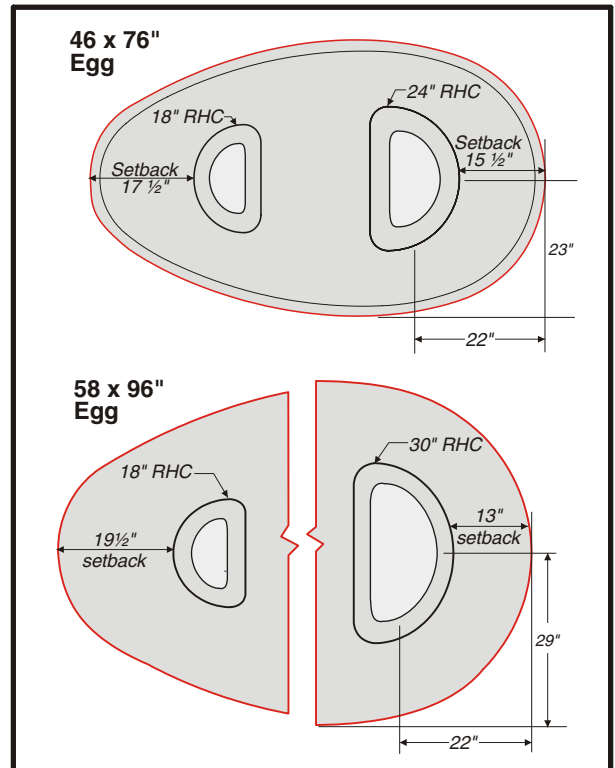

Monument cutout for

RHC Radius Half Cylinder bases are 6" less in each dimension

7% price increase effective January 1, 2009

KAIZEN Conference Articulating Tables

Conference Kaizen articulating table

Description	Model Number	Wgt	List Prices				
			WoodPlus	Standard	Detailed	2000	3000
KAIZEN table	TKZ-72144--RC	990	28569	28881	29348	30669	31577
	TKZ-72168-RC	1080	29844	30311	30734	32150	33122
	TKZ-72192-RC	1170	30047	30514	31160	32517	33663

KAIZEN table opens at either or both ends

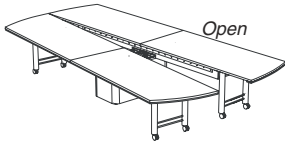

Open

Closed

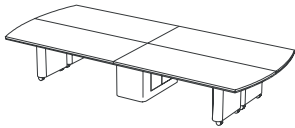

Top: 2 sides. Bases: center of table includes BHD Base Hinged Door. Includes the MINI-COVERS at the top of the HLEGS.

H-Leg standard finish is Black or Silver. Black will be provided unless otherwise specified.

Description	Model Number	Wgt	WoodPlus	Standard	Detailed	2000	3000
H-Leg Covers	TKZ-RC-COVERS	32	1264	1264	1264	1264	1264

Four RC covers included, one for each HLEG on the table. RC covers match the center base finish color.

Table shown with the four RC-COVERS in place

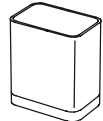

Center Base Silver Accent

Description	Model Number	Wgt	WoodPlus	Standard	Detailed	2000	3000
Silver Accent Center Base	BASE-SILVER-ACCENT-KAIZEN	0	328	328	328	328	328

Silver Accent strip for center base - 3" high.

Seating capacity and room size	for the 144" (12') long table	seats 10 to 12	minimum room size 14' 6" by 20'
	for the 168" (14') long table	seats 14 to 16	minimum room size 16' 6" by 22'
	for the 192" (16') long table	seats 16 to 18	minimum room size 18' 6" by 24'

144, 168, 192
168" long table shown above

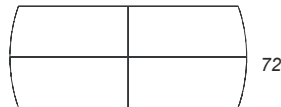

Model Numbers:
Shape 72 long RC
e.g. TKZ-72 168-RC

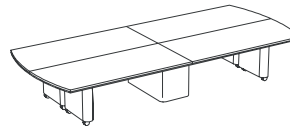

Table is closed

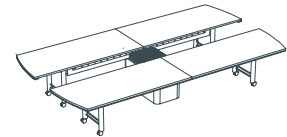

Table open at both ends

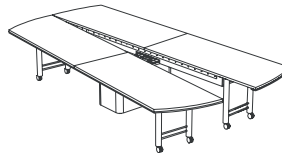

Table open end is to the right

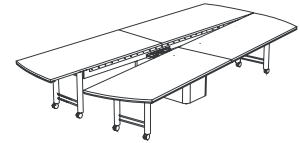

Table open end is to the left

IMPORTANT: Tables are standard with wood grain running length of table.

Finish Colors

Specify table Finish Colors.

For non-standard top laminates, please contact Customer Service for availability and upcharge.

Custom color wood edge

Notes:

- Tables are shipped RTA (ready to assemble)

Options

Options are built-in at factory

INLAY -available ONLY with Detailed or larger edge

INP Black 3mm (1/8") Inlay:

INB Brushed Brass 3mm Inlay or

INC Satin Chrome 3mm Inlay:

See the end of this section for pricing on all options and accessories.

7% price increase effective January 1, 2009

KAIZEN Conference Articulating Tables

Mobile Utility Tables

Description	Model Number	Wgt	List Prices				
			WoodPlus	Standard	Detailed	2000	3000
with Casters	MUT-2419-CA	35	907	956	1141		

The MUT table base is available in black or silver.
The top adjusts from 29" to 39".

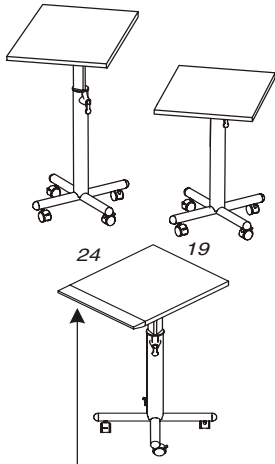

3400 edge shown along the 19" front edge of top

Match table edge	CREDENZA-2000-1LONG	356	
	CREDENZA-3000-1LONG		485
Match the tables 2000 series or 3000 series edge on one of the 19" long MUT table edges			

Add inlay	CREDENZA-INLAY-BLACK	96	96
	CREDENZA-INLAY-BRASS	137	137
	CREDENZA-INLAY-CHROME	137	137
Add an inlay along the 2000 series or 3000 series edge			

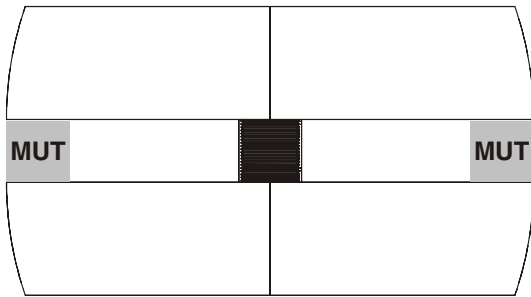

Two Mobile Utility Tables are used to expand the Kaizen table seating capacity

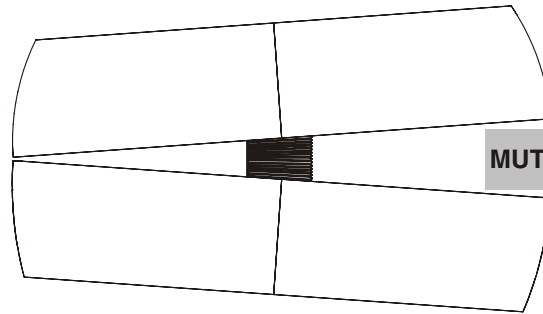

A Mobile Utility Table is used to hold the video projector or as a speaker's mini-lectern

IMPORTANT: Tables are standard with wood grain running length of table.

Finish Colors

Specify table Finish Colors.

For non-standard top laminates, please contact Customer Service for availability and upcharge.

Custom color wood edge on outside of table

See the end of this section for pricing on all options and accessories.

Edge Options Information

- Tables are available with the following edge options:
- WoodPlus 3 mm PVC edge
 - Standard 3 mm Wood Edge
 - Detailed 3/8" Wood Edge
 - 2000 Series hardwood edges
 - 3000 Series hardwood edges

WoodPlus 3 mm PVC	Standard Wood	Detailed Wood	2000 Wood	3000 Wood
Equations WPES	Equations SWES	RE	2000	1000
Modular 8 WPER	Modular 8 SWER	RA	2001	1100
WPMS	WPEN	SWMS	SWEN	BE
WPMN	SWMN	TR	2003	2200
WPMP	SWMP	CL	2004	2100

7% price increase effective January 1, 2009

Conference Tables

Arrow - Pyramid Base

Description	Model Number	Wgt	List Prices				
			WoodPlus WPE	STD	Wood Edges		3000
					DET	2000	
48" Wide	TAR4884-PYR	324	5974	6174	6642	7523	7968
	TAR4896-PYR	344	6232	6432	6900	7781	8226
	TAR48120-PYR	424	6847	7081	7515	8778	9449
Top: 1 piece. Base: 2 PYR. 120" long may be specified as 2 piece top.							
48" Wide	TAR48144-PYR	516	8425	8721	9204	10525	11433
	TAR48150-PYR	526	9585	9881	10364	11685	12593
	TAR48168-PYR	556	9705	10063	10595	12011	12983
Top: 2 piece. Base: 3 PYR.							
58" Wide	TAR58120-PYR	466	6869	7103	7537	8800	9471
Top: 1 piece. Base: 2 PYR. 120" long may be specified as 2 piece top.							
58" Wide	TAR58144-PYR	554	7507	7803	8286	9607	10515
	TAR58150-PYR	566	8774	9070	9553	10874	11782
Top: 2 piece. Base: 2 PYR.							
58" Wide	TAR58168-PYR	674	9932	10290	10822	12238	13210
	TAR58180-PYR	699	10029	10387	10919	12335	13307
	TAR58192-PYR	723	10221	10683	11223	12691	13837
	TAR58216-PYR	851	11255	11717	12257	13725	14871
	TAR58240-PYR	899	11544	12011	12657	14457	15818
Top: 2 piece. Base: 3 PYR.							
58" Wide	TAR58288-PYR	1148	15692	16088	17250	19109	20813
Top: 3 piece. Base: 4 PYR.							

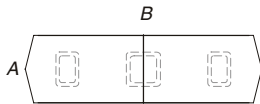
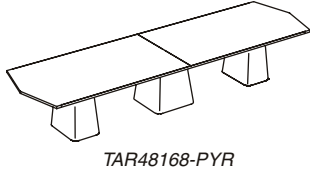
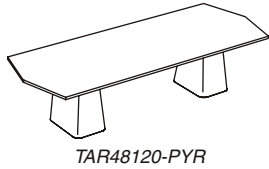

Model Numbers:
Shape A B Base
e.g. TAR 48 168 PYR

IMPORTANT: Tables are standard with wood grain running length of table.

Notes:

- Conference tables are shipped RTA (ready to assemble)

Options

Options are built-in at factory

Grommets see page at end of this section

Options

Options are built-in at factory

INLAY -available ONLY with Detailed or larger edge

- INP Black 3mm (1/8") Inlay
- INB Brushed Brass 3mm Inlay or
- INC Satin Chrome 3mm Inlay

Rectangle top with Bow End or C3R options uses the 'shape inlay' price.

When a Rectangular table top is ordered with 2000 Series edge and an inlay, please add the optional Bow End (BE) or the Corners with 3" Radius (C3R).

7% price increase effective January 1, 2009

Conference Tables

Arrow - Triangle Base

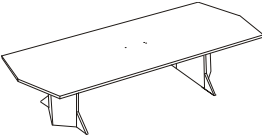
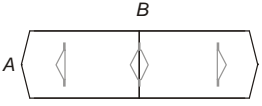
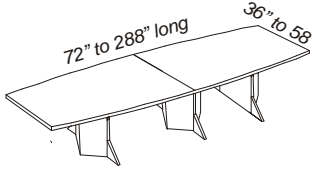
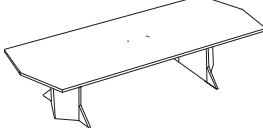
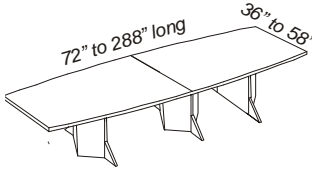
Description	Model Number	Wgt	List Prices				
			WoodPlus WPE	STD	Wood Edges DET		2000
 <p>36" wide,</p>	TAR3672-TRI	246	2671	2866	3239	3915	4437
	Top: 1 piece; Base: 2 TRI						
	TAR4272-TRI	261	2864	3059	3432	4108	4630
	TAR4284-TRI	279	3010	3210	3678	4559	5004
	TAR4296-TRI	296	3157	3357	3825	4706	5151
Top: 1 piece; Base: 2 TRI							
 <p>48" wide</p>	TAR4872-TRI	304	2912	3107	3480	4156	4678
	Top: 1 piece; Base: 2 TRI						
	TAR4884-TRI	324	3059	3259	3727	4608	5053
	TAR4896-TRI	344	3205	3405	3873	4754	5199
	TAR48120-TRI	424	3500	3734	4168	5431	6102
Top: 1 piece; Base: 2 TRI. 120" long may be specified as 2 piece top.							
 <p>36" to 58"</p>	TAR48144-TRI	516	3866	4162	4645	5966	6874
	TAR48150-TRI	526	4004	4300	4783	6104	7012
	TAR48168-TRI	556	4086	4444	4976	6392	7364
	Top: 2 piece; Base: 3 TRI.						
	 <p>4976</p>	TAR58120-TRI	466	4740	4974	5408	6671
Top: 1 piece; Base: 2 TRI. 120" long may be specified as 2 piece top.							
TAR58144-TRI		554	5076	5372	5855	7176	8084
TAR58150-TRI		566	5359	5655	6138	7459	8367
Top: 2 piece; Base: 2 TRI.							
 <p>36" to 58"</p>	TAR58168-TRI	674	5359	5717	6249	7665	8637
	TAR58180-TRI	699	6790	7148	7680	9096	10068
	TAR58192-TRI	723	7019	7481	8021	9489	10635
	TAR58216-TRI	851	7250	7712	8252	9720	10866
	TAR58240-TRI	899	7480	7947	8593	10393	11754
	Top: 2 piece; Base: 3 TRI						
TAR58288-TRI	1148	9458	9854	11016	12875	14579	
Top: 3 piece; Base: 4 TRI							

Model Numbers:
Shape A B Base
e.g. TAR 48 168 TRI

IMPORTANT: Tables are standard with wood grain running length of table.

Edge Options Information

Tables are available with the following edge options:

- WoodPlus 3 mm PVC edge
- Standard 3 mm Wood Edge
- Detailed 3/8" Wood Edge
- 2000 Series hardwood edges
- 3000 Series hardwood edges

WoodPlus 3 mm PVC	Standard Wood	Detailed Wood	2000 Wood	3000 Wood
Equations WPES	Equations SWES	RE	2000	1000
Modular 8 WPER	Modular 8 SWER	RA	2001	1100
Modular 8 WPMN	Modular 8 SWMN	BE	2002	1200
Modular 8 WPMR	Modular 8 SWMR	TR	2003	2200
		CL	2004	2100
				3200
				3400

7% price increase effective January 1, 2009

Conference Tables

Rectangular - Radius Cube Base

Description	Model Number	Wgt	List Prices				
			WoodPlus	Standard	Wood Edges		
					Detailed	2000	3000
36" wide, 18" wide base	TT3672-RC	246	2849	3013	3181	3871	4392
	Top: 1 piece; Base: 2 RC						
	TT4272-RC	261	3050	3214	3382	4072	4593
	TT4284-RC	279	3474	3674	3939	4800	5245
	TT4296-RC	296	3541	3741	4006	4867	5312
Top: 1 piece; Base: 2 RC							
48" wide 24" wide base	TT4872-RC	304	3050	3214	3382	4072	4593
	Top: 1 piece; Base: 2 RC						
	TT4884-RC	324	3474	3674	3939	4800	5245
	TT4896-RC	344	3541	3741	4006	4867	5312
	TT48120-RC	424	4005	4239	4562	5673	6385
	Top: 1 piece; Base: 2 RC. 120" long may be specified as 2 piece top.						
	TT48144-RC	516	4590	4894	5258	6343	7264
	TT48150-RC	526	5512	5816	6180	7265	8186
	TT48168-RC	556	5520	5876	6299	7312	8464
	Top: 2 piece; Base: 3 RC.						
58" wide 30" wide base	TT58120-RC	466	4122	4356	4679	5790	6502
	Top: 1 piece; Base: 2 RC. 120" long may be specified as 2 piece top.						
	TT58144-RC	554	4611	4915	5279	6364	7285
	TT58150-RC	566	5628	5932	6296	7381	8302
	Top: 2 piece; Base: 2 RC.						
	TT58168-RC	674	5960	6316	6739	7752	8904
	TT58180-RC	699	6056	6412	6835	7848	9000
	TT58192-RC	723	6153	6546	7043	8121	9435
	TT58216-RC	851	6820	7213	7710	8788	10102
	TT58240-RC	899	6932	7377	7934	9128	10872
	Top: 2 piece; Base: 3 RC						
	TT58288-RC	1148	9958	10354	11294	12154	14745
	Top: 3 piece; Base: 4 RC						

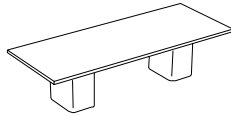

TT48120-RC

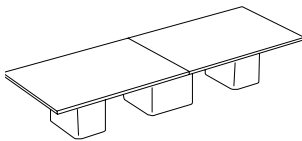

TT58168-RC

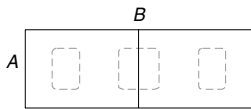

Model Numbers:
Shape A B Base
e.g. TT 58 168 RC

IMPORTANT: Tables are standard with wood grain running length of table.

Notes:

- Conference tables are shipped RTA (ready to assemble)

Options

Options are built-in at factory

Grommets see page at end of this section

Options

Options are built-in at factory

INLAY -available ONLY with Detailed or larger edge

- INP Black 3mm (1/8") Inlay
- INB Brushed Brass 3mm Inlay or
- INC Satin Chrome 3mm Inlay

Rectangle top with Bow End or C3R options uses the 'shape inlay' price.

When a Rectangular table top is ordered with 2000 Series edge and an inlay, please add the optional Bow End (BE) or the Corners with 3" Radius (C3R).

7% price increase effective January 1, 2009

Conference Tables

Rectangular - Triangle Base

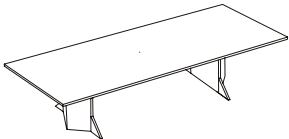
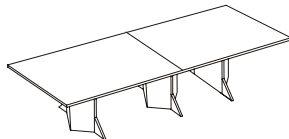
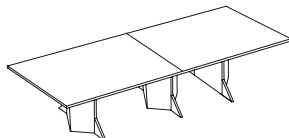
Description	Model Number	Wgt	List Prices					
			WoodPlus	Standard	Wood Edges			
					Detailed	2000	3000	
36" wide, 18" wide base 	TT3672-TRI	246	2849	3013	3181	3871	4392	
	Top: 1 piece; Base: 2 TRI							
	TT4272-TRI	261	3050	3214	3382	4072	4593	
	TT4284-TRI	279	3474	3674	3939	4800	5245	
	TT4296-TRI	296	3541	3741	4006	4867	5312	
Top: 1 piece; Base: 2 TRI								
48" wide 24" wide base 	TT4872-TRI	304	3050	3214	3382	4072	4593	
	Top: 1 piece; Base: 2 TRI							
	TT4884-TRI	324	3474	3674	3939	4800	5245	
	TT4896-TRI	344	3541	3741	4006	4867	5312	
	TT48120-TRI	424	4005	4239	4562	5673	6385	
	Top: 1 piece; Base: 2 TRI. 120" long may be specified as 2 piece top.							
	TT48144-TRI	516	4590	4894	5258	6343	7264	
	TT48150-TRI	526	5512	5816	6180	7265	8186	
	TT48168-TRI	556	5520	5876	6299	7312	8464	
	Top: 2 piece; Base: 3 TRI.							
58" wide 30" wide base 	TT58120-TRI	466	4122	4356	4679	5790	6502	
	Top: 1 piece; Base: 2 TRI. 120" long may be specified as 2 piece top.							
	TT58144-TRI	554	4611	4915	5279	6364	7285	
	TT58150-TRI	566	5628	5932	6296	7381	8302	
	Top: 2 piece; Base: 2 TRI.							
	TT58168-TRI	674	5960	6316	6739	7752	8904	
	TT58180-TRI	699	6056	6412	6835	7848	9000	
	TT58192-TRI	723	6153	6546	7043	8121	9435	
	TT58216-TRI	851	6820	7213	7710	8788	10102	
	TT58240-TRI	899	6932	7377	7934	9128	10872	
Top: 2 piece; Base: 3 TRI								
TT58288-TRI	1148	9958	10354	11294	12154	14745		
Top: 3 piece; Base: 4 TRI								

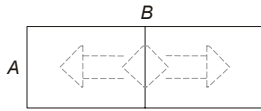

ACT Model Numbers:
Shape A B Base
e.g. TT 58 168 RC

IMPORTANT: Tables are standard with wood grain running length of table.

Edge Options Information

Tables are available with the following edge options:

- WoodPlus 3 mm PVC edge
- Standard 3 mm Wood Edge
- Detailed 3/8" Wood Edge
- 2000 Series hardwood edges
- 3000 Series hardwood edges

WoodPlus 3 mm PVC	Standard Wood	Detailed Wood	2000 Wood	3000 Wood
Equations WPES	Equations SWES	RE	2000	1000
Modular 8 WPER	Modular 8 SWER	RA	2001	1100
Modular 8 WPMS	Modular 8 SWMS	BE	2002	1200
WPEN	SWEN	TR	2003	2200
WPMN	SWMN	CL	2004	2100
WPMR	SWMR			

7% price increase effective January 1, 2009

Conference Tables

Rectangular - Panel End Base

Description	Model Number	Wgt	List Prices					
			WoodPlus	Standard	Wood Edges			
					Detailed	2000	3000	
36" wide, 18" wide base	TT3672-PEB	130	1125	1181	1348	1782	2043	
	Top: 1 piece; Base: 2 PEB							
42" wide 20" wide base	TT4272-PEB	145	1283	1339	1506	1940	2201	
	TT4284-PEB	166	1442	1553	1810	2434	2866	
	TT4296-PEB	186	1758	1869	2126	2750	3182	
Top: 1 piece; Base: 2 PEB								
48" wide 24" wide base	TT4872-PEB	160	1447	1503	1670	2104	2365	
	TT4884-PEB	183	1533	1644	1901	2525	2957	
24" wide base	TT4896-PEB	206	1878	1989	2246	2870	3302	
	TT48120-PEB	250	2286	2467	2843	3883	4598	
	Top: 1 piece; Base: 2 PEB. 120" long may be specified as 2 piece top.							
	TT48144-PEB	312	2598	2807	3266	4465	5247	
	TT48150-PEB	323	2841	3050	3509	4708	5490	
	TT48168-PEB	355	3048	3288	3822	5131	5992	
Top: 2 piece; Base: 3 PEB.								
58" wide 30" wide base	TT58120-PEB	310	2432	2613	2989	4029	4744	
	Top: 1 piece; Base: 2 PEB. 120" long may be specified as 2 piece top.							
30" wide base	TT58144-PEB	389	2760	2969	3428	4627	5409	
	TT58150-PEB	402	2999	3208	3667	4866	5648	
	TT58168-PEB	440	3240	3480	4014	5323	6184	
	TT58180-PEB	468	3562	3802	4336	5645	6506	
	TT58192-PEB	495	3919	4203	4777	6166	7201	
	TT58216-PEB	549	4311	4595	5169	6558	7593	
Top: 2 piece; Base: 3 PEB.								
Grommets in PEB base	GR-PEB-END		48	48	48	48	48	
	A GROMMET which is centered 'side to side' and located near the end panel at the end of the table, will be placed on the 'outside' of the end panel, to avoid any interference from the stretcher placed between end panels.							
	GR-PEB-CENTER		216	216	216	216	216	
To place a GROMMET in the center of the table (both 'side to side' and 'end to end') the single stretcher between end panels will be changed to two stretchers between end panels. This second stretcher is included in the GR-PEB-CENTER price.								

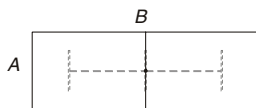
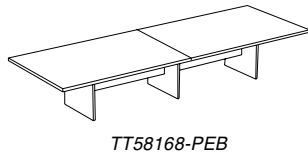
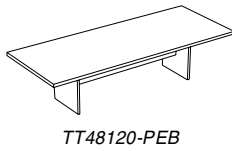

Model Numbers:
Shape A B Base
e.g. TT 58 168 PEB

IMPORTANT: Tables are standard with wood grain running length of table.

Notes:

- Conference tables are shipped RTA (ready to assemble)

Options

Options are built-in at factory

Grommets see page at end of this section

Options

Options are built-in at factory

INLAY -available ONLY with Detailed or larger edge

- INP Black 3mm (1/8") Inlay
- INB Brushed Brass 3mm Inlay or
- INC Satin Chrome 3mm Inlay

Rectangle top with Bow End or C3R options uses the 'shape inlay' price.

When a Rectangular table top is ordered with 2000 Series edge and an inlay, please add the optional Bow End (BE) or the Corners with 3" Radius (C3R).

7% price increase effective January 1, 2009

Conference Tables

Boat Shape - Radius Cube Base

Description	Model Number	Wgt	List Prices				
			WoodPlus	Standard	Detailed	2000	3000
36" wide, 18" wide base	TB3672-RC	246	3081	3276	3649	4325	4847
	Top: 1 piece; Base: 2 RC						
42" wide 18" wide base	TB4272-RC	261	3251	3446	3819	4495	5017
	TB4284-RC	279	3539	3739	4207	5088	5533
	TB4296-RC	296	3829	4029	4497	5378	5823
Top: 1 piece; Base: 2 RC							
48" wide 24" wide base	TB4872-RC	304	3421	3616	3989	4665	5187
	Top: 1 piece; Base: 2 RC						
	TB4884-RC	324	3725	3925	4393	5274	5719
	TB4896-RC	344	4030	4230	4698	5579	6024
	TB48120-RC	424	4336	4570	5004	6267	6938
	Top: 1 piece; Base: 2 RC. 120" long may be specified as 2 piece top.						
	TB48144-RC	516	4672	4968	5451	6772	7680
	TB48150-RC	526	5646	5942	6425	7746	8654
	TB48168-RC	556	5656	6014	6546	7962	8934
	Top: 2 piece; Base: 3 RC.						
58" wide 30" wide base	TB58120-RC	466	4740	4974	5408	6671	7342
	Top: 1 piece; Base: 2 RC. 120" long may be specified as 2 piece top.						
	TB58144-RC	554	5076	5372	5855	7176	8084
	TB58150-RC	566	5763	6059	6542	7863	8771
Top: 2 piece; Base: 2 RC.							
	TB58168-RC	674	6096	6454	6986	8402	9374
	TB58180-RC	699	6790	7148	7680	9096	10068
	TB58192-RC	723	7019	7481	8021	9489	10635
	TB58216-RC	851	7250	7712	8252	9720	10866
	TB58240-RC	899	7480	7947	8593	10393	11754
Top: 2 piece; Base: 3 RC							
	TB58288-RC	1148	9972	10368	11530	13389	15093
Top: 3 piece; Base: 4 RC							

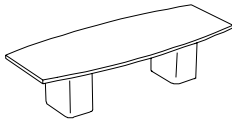

TB48120-RC

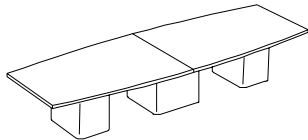

TB58168-RC

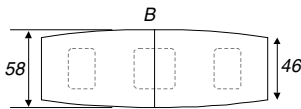

Model Numbers:
Shape 58 B Base
e.g. TB 58 168 RC

IMPORTANT: Tables are standard with wood grain running length of table.

Edge Options Information	WoodPlus 3 mm PVC	Standard Wood	Detailed Wood	2000 Wood	3000 Wood
Tables are available with the following edge options:					
• WoodPlus 3 mm PVC edge	Equations WPES	Equations SWES	RE	2000	1000
• Standard 3 mm Wood Edge	Modular 8 WPER	Modular 8 SWER	RA	2001	1100
• Detailed 3/8" Wood Edge	WPMS	SWMS	BE	2002	1200
• 2000 Series hardwood edges	WPMN	SWMN	TR	2003	2200
• 3000 Series hardwood edges	WPMR	SWMR	CL	2004	2100

7% price increase effective January 1, 2009

Conference Tables

Boat Shape - Triangle Base

Description	Model Number	Wgt	List Prices					
			WoodPlus	Standard	Wood Edges			
					Detailed	2000	3000	
36" wide, 18" wide base	TB3672-TRI Top: 1 piece; Base: 2 TRI	246	3081	3276	3649	4325	4847	
42" wide 18" wide base	TB4272-TRI TB4284-TRI TB4296-TRI Top: 1 piece; Base: 2 TRI	261 279 296	3251 3539 3829	3446 3739 4029	3819 4207 4497	4495 5088 5378	5017 5533 5823	
48" wide 24" wide base	TB4872-TRI Top: 1 piece; Base: 2 TRI	304	3421	3616	3989	4665	5187	
	TB4884-TRI TB4896-TRI TB48120-TRI Top: 1 piece; Base: 2 TRI. 120" long may be specified as 2 piece top.	324 344 424	3725 4030 4336	3925 4230 4570	4393 4698 5004	5274 5579 6267	5719 6024 6938	
	TB48144-TRI TB48150-TRI TB48168-TRI Top: 2 piece; Base: 3 TRI.	516 526 556	4672 5646 5656	4968 5942 6014	5451 6425 6546	6772 7746 7962	7680 8654 8934	
	58" wide 30" wide base	TB58120-TRI Top: 1 piece; Base: 2 TRI. 120" long may be specified as 2 piece top.	466	4740	4974	5408	6671	7342
	TB58144-TRI TB58150-TRI Top: 2 piece; Base: 2 TRI.	554 566	5076 5763	5372 6059	5855 6542	7176 7863	8084 8771	
	TB58168-TRI TB58180-TRI TB58192-TRI TB58216-TRI TB58240-TRI Top: 2 piece; Base: 3 TRI	674 699 723 851 899	6096 6790 7019 7250 7480	6454 7148 7481 7712 7947	6986 7680 8021 8252 8593	8402 9096 9489 9720 10393	9374 10068 10635 10866 11754	
	TB58288-TRI Top: 3 piece; Base: 4 TRI	1148	9972	10368	11530	13389	15093	

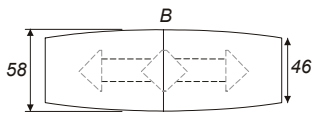
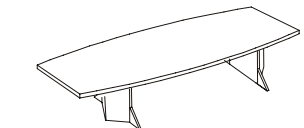

Model Numbers:
Shape width B Base
e.g. TB 58 168 TRI

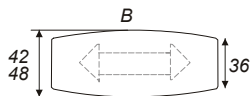

Model Numbers:
Shape width B Base
e.g. TB 48 120 TRI

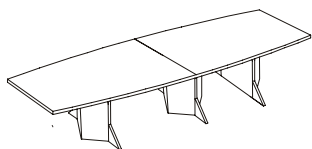

IMPORTANT: Tables are standard with wood grain running length of table.

Notes:

- Conference tables are shipped RTA (ready to assemble)

Options

Options are built-in at factory

Grommets see page at end of this section

Options

Options are built-in at factory

INLAY -available ONLY with Detailed or larger edge

- INP Black 3mm (1/8") Inlay
- INB Brushed Brass 3mm Inlay or
- INC Satin Chrome 3mm Inlay

Rectangle top with Bow End or C3R options uses the 'shape inlay' price.

When a Rectangular table top is ordered with 2000 Series edge and an inlay, please add the optional Bow End (BE) or the Corners with 3" Radius (C3R).

7% price increase effective January 1, 2009

Conference Tables

Boat Shape - Panel End Base

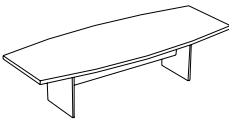
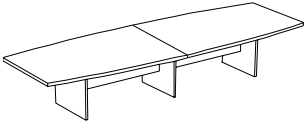
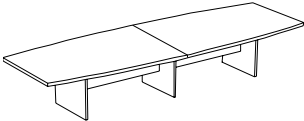
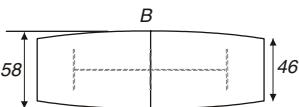
Description	Model Number	Wgt	List Prices					
			WoodPlus	Standard	Detailed	2000	3000	
 TB48120-PEB	36" wide, 18" wide base	TB3672-PEB	130	1785	1938	2309	3029	3551
	Top: 1 piece; Base: 2 PEB							
	42" wide 18" wide base	TB4272-PEB	145	1846	1999	2370	3090	3612
	TB4284-PEB	166	1909	2076	2546	3458	3903	
	TB4296-PEB	186	2159	2326	2796	3708	4153	
Top: 1 piece; Base: 2 PEB								
 TB58168-PEB	48" wide 24" wide base	TB4872-PEB	160	1941	2094	2465	3185	3707
	TB4884-PEB	183	2008	2175	2645	3557	4002	
	TB4896-PEB	206	2273	2440	2910	3822	4267	
	TB48120-PEB	250	2804	3038	3472	4735	5406	
Top: 1 piece; Base: 2 PEB. 120" long may be specified as 2 piece top.								
	TB48144-PEB	312	2991	3244	3770	5091	5999	
	TB48150-PEB	323	3273	3526	4052	5373	6281	
	TB48168-PEB	355	3273	3552	4163	5579	6551	
Top: 2 piece; Base: 3 PEB.								
 TB58168-PEB 	58" wide 30" wide base	TB58120-PEB	310	3067	3301	3735	4998	5669
	Top: 1 piece; Base: 2 PEB. 120" long may be specified as 2 piece top.							
		TB58144-PEB	389	3249	3502	4028	5349	6257
		TB58150-PEB	402	3405	3658	4184	5505	6413
		TB58168-PEB	440	3558	3837	4448	5864	6836
		TB58180-PEB	468	3919	4198	4809	6225	7197
		TB58192-PEB	495	4311	4645	5313	6781	7927
	TB58216-PEB	549	4741	5075	5743	7211	8357	
Top: 2 piece; Base: 3 PEB.								
Grommets in PEB base	GR-PEB-END		48	48	48	48	48	
	A GROMMET which is centered 'side to side' and located near the end panel at the end of the table, will be placed on the 'outside' of the end panel, to avoid any interference from the stretcher placed between end panels.							
	GR-PEB-CENTER		216	216	216	216	216	
To place a GROMMET in the center of the table (both 'side to side' and 'end to end') the single stretcher between end panels will be changed to two stretchers between end panels. This second stretcher is included in the GR-PEB-CENTER price.								
Double or Twin	TWIN-PEB-2BASES		168	196	196	196	196	
Modesty Panels	TWIN-PEB-3BASES		336	364	364	392	392	

Model Numbers:
Shape 58 B Base
e.g. TT 58 168 PEB

PEB-TWIN-MP-2 option

Grommet locations shown

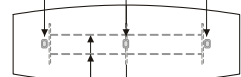

Adding a second MP creates a 10" wide wire channel

IMPORTANT: Tables are standard with wood grain running length of table.

Edge Options Information

Tables are available with the following edge options:

- WoodPlus 3 mm PVC edge
- Standard 3 mm Wood Edge
- Detailed 3/8" Wood Edge
- 2000 Series hardwood edges
- 3000 Series hardwood edges

	WoodPlus 3 mm PVC	Standard Wood	Detailed Wood	2000 Wood	3000 Wood
Equations	WPES	SWES	RE	2000	1000
Modular 8	WPER	SWER	RA	2001	1100
	WPEN	SWEN	BE	2002	1200
	WPMN	SWMN	TR	2003	2200
	WPMR	SWMR	CL	2004	2100

7% price increase effective January 1, 2009

Conference Tables

Racetrack - Full Cylinder Base

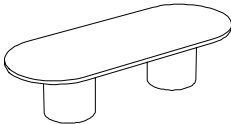
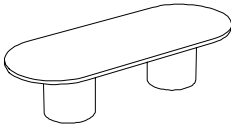
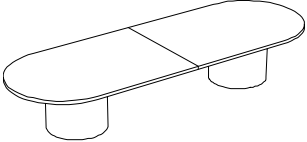
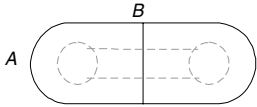
Description	Model Number	Wgt	List Prices					
			WoodPlus	Standard	Wood Edges			
					Detailed	2000	3000	
 TR48120-CYL	42" wide	TR4284-CYL	279	3539	3739	4207	5088	5533
	18" wide base	TR4296-CYL	296	3829	4029	4497	5378	5823
Top: 1 piece; Base: 2 CYL								
 TR48120-CYL	48" wide	TR4896-CYL	316	4030	4230	4698	5579	6024
	24" wide base	TR48120-CYL	396	4336	4570	5004	6267	6938
Top: 1 piece; Base: 2 CYL. 120" long may be specified as 2 piece top.								
		TR48144-CYL	474	4672	4968	5451	6772	7680
		TR48150-CYL	484	4932	5228	5711	7032	7940
Top: 2 piece; Base: 2 CYL								
		TR48168-CYL	514	4932	5290	5822	7238	8210
Top: 2 piece; Base: 3 CYL								
 TR58168-CYL	58" wide	TR58120-CYL	426	4740	4974	5408	6671	7342
	30" wide base		Top: 1 piece; Base: 2 CYL. 120" long may be specified as 2 piece top.					
		TR58144-CYL	514	5076	5372	5855	7176	8084
		TR58150-CYL	526	5359	5655	6138	7459	8367
		TR58168-CYL	614	5359	5717	6249	7665	8637
Top: 2 piece; Base: 2 CYL								
		TR58180-CYL	639	6790	7148	7680	9096	10068
		TR58192-CYL	663	7019	7481	8021	9489	10635
		TR58216-CYL	791	7250	7712	8252	9720	10866
		TR58240-CYL	839	7480	7947	8593	10393	11754
Top: 2 piece; Base: 3 CYL								
 Model Numbers: Shape A B Base e.g. TR 58 168 CYL		TR58288-CYL	1068	9458	9854	11016	12875	14579
	Top: 3 piece; Base: 4 CYL							

IMPORTANT: Tables are standard with wood grain running length of table.

Notes:

- Conference tables are shipped RTA (ready to assemble)

Options

Options are built-in at factory

Grommets see page at end of this section

Options

Options are built-in at factory

INLAY -available ONLY with Detailed or larger edge

- INP Black 3mm (1/8") Inlay
- INB Brushed Brass 3mm Inlay or
- INC Satin Chrome 3mm Inlay

Rectangle top with Bow End or C3R options uses the 'shape inlay' price.

When a Rectangular table top is ordered with 2000 Series edge and an inlay, please add the optional Bow End (BE) or the Corners with 3" Radius (C3R).

7% price increase effective January 1, 2009

Conference Tables

Description	Model Number	Wgt	List Prices				
			WoodPlus	Standard	Detailed	2000	3000
Racetrack - Half Cylinder Base							
36" or 42" wide, 18" wide base	TR3672-HC	246	2671	2866	3239	3915	4437
	TR4272-HC	261	2864	3059	3432	4108	4630
	TR4284-HC	279	3010	3210	3678	4559	5004
	TR4296-HC	296	3157	3357	3825	4706	5151
48" wide 24" wide base	TR4872-HC	276	2912	3107	3480	4156	4678
	TR4884-HC	296	3059	3259	3727	4608	5053
	TR4896-HC	316	3205	3405	3873	4754	5199
	TR48120-HC	424	3500	3734	4168	5431	6102
Top: 1 piece; Base: 2 HC							
	TR48144-HC	516	3866	4162	4645	5966	6874
	TR48150-HC	526	4004	4300	4783	6104	7012
	TR48168-HC	514	4932	5290	5822	7238	8210
Top: 2 piece; Base: 2 HC, 1 CYL							
58" wide 30" wide base	TR58120-HC	446	4740	4974	5408	6671	7342
Top: 1 piece; Base: 2 HC. 120" long may be specified as 2 piece top.							
	TR58144-HC	514	5076	5372	5855	7176	8084
	TR58150-HC	526	5359	5655	6138	7459	8367
	TR58168-HC	614	5359	5717	6249	7665	8637
Top: 2 piece; Base: 2 HC, 1 CYL							
	TR58180-HC	639	6790	7148	7680	9096	10068
	TR58192-HC	663	7019	7481	8021	9489	10635
	TR58216-HC	791	7250	7712	8252	9720	10866
	TR58240-HC	839	7480	7947	8593	10393	11754
Top: 2 piece; Base: 2 HC, 1 CYL							
	TR58288-HC	1068	9458	9854	11016	12875	14579
Top: 3 piece; Base: 2 HC, 2 CYL							

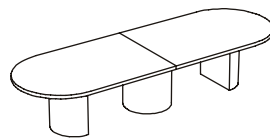
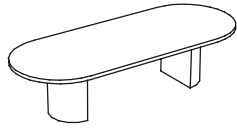
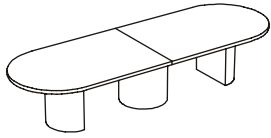
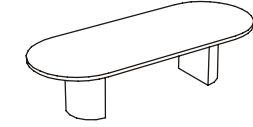

IMPORTANT: Tables are standard with wood grain running length of table.

Edge Options Information

- Tables are available with the following edge options:
- WoodPlus 3 mm PVC edge
 - Standard 3 mm Wood Edge
 - Detailed 3/8" Wood Edge
 - 2000 Series hardwood edges
 - 3000 Series hardwood edges

Edge Options Information	WoodPlus 3 mm PVC	Standard Wood	Detailed Wood	2000 Wood	3000 Wood
	Equations WPES	Equations SWES	RE	2000	1000
	Modular 8 WPER	Modular 8 SWER	RA	2001	1100
	WPMS	SWMS	BE	2002	1200
	WPMN	SWMN	TR	2003	2200
	WPMR	SWMR	CL	2004	2100
					3200
					3400

7% price increase effective January 1, 2009

Conference Tables

Delta - Radius Cube Base

Description	Model Number	Wgt	List Prices				
			WoodPlus	Standard	Wood Edges		
					Detailed	2000	3000
58" wide	TDE5896-RC	417	5155	5389	5823	7086	7757
One piece top	TDE58120-RC	466	5523	5757	6191	7454	8125
Top: 1 piece; Base: 2 RC. 120 long may be specified as 2 piece top.							
Two piece top	TDE58144-RC	554	5894	6190	6673	7994	8902
	TDE58150-RC	566	6207	6503	6986	8307	9215
Top: 2 piece; Base: 2 RC							
	TDE58168-RC	674	6207	6565	7097	8513	9485
	TDE58180-RC	699	7778	8136	8668	10084	11056
	TDE58192-RC	723	8032	8494	9034	10502	11648

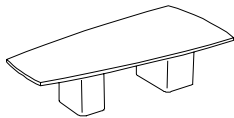

TDE58120-RC

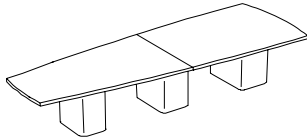

TDE58168-RC

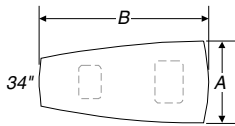

Model Numbers:
Shape A B Base
e.g. TDE 58 120 RC

Egg Shape - Radius Half Cylinder Base

58" wide	TEG5896-RHC	417	5413	5647	6081	7344	8015
Top: 1 piece; Base: 2 RHC							

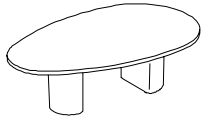

TEG5896-RHC

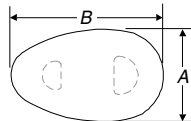

Model Numbers:
Shape A B Base
e.g. TEG 58 96 RHC

IMPORTANT: Tables are standard with wood grain running length of table.

Notes:

- Conference tables are shipped RTA (ready to assemble)

Options

Options are built-in at factory

Grommets see page at end of this section

Options

Options are built-in at factory

INLAY -available ONLY with Detailed or larger edge

- INP Black 3mm (1/8") Inlay
- INB Brushed Brass 3mm Inlay or
- INC Satin Chrome 3mm Inlay

Rectangle top with Bow End or C3R options uses the 'shape inlay' price.

When a Rectangular table top is ordered with 2000 Series edge and an inlay, please add the optional Bow End (BE) or the Corners with 3" Radius (C3R).

7% price increase effective January 1, 2009

Conference Tables

Round - Full Cylinder Base

Description	Model Number	Wgt	List Prices				
			WoodPlus	Standard	Wood Edges		
					Detailed	2000	3000
58" diameter	TD58-CYL	204	2015	2215	2683	3564	4009

Single piece top; 30" diameter base
 Note: Table requires counterweight for stability. Bags provided for sand (sand not included)

66" diameter	TD66-CYL	241	3157	3453	3936	5257	6165
---------------------	----------	-----	-------------	------	------	------	------

2 piece top; 36" diameter base

72" diameter	TD72-CYL	292	3157	3453	3936	5257	6165
---------------------	----------	-----	-------------	------	------	------	------

2 piece top; 36" diameter base

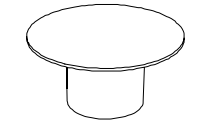

TD58-CYL

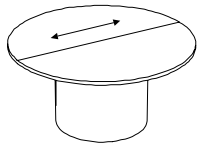

TD72-CYL

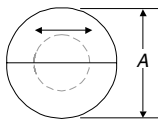

ACT Model Numbers:
 Shape A Base
 e.g. TD-72-CYL

Wing Conference table - Radius Cube base

Wing table	TW-1712-RC	1446	12251	13186	14254	17191	19483
-------------------	------------	------	--------------	-------	-------	-------	-------

WING table seats 16 to 18.
 Table is 16' - 10" long by 12' - 3" wide.
 Minimum room size is 25' long by 20' wide.

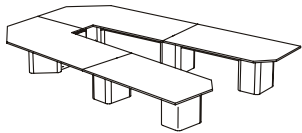

'WING' Conference table
 with RC Radius Cube bases

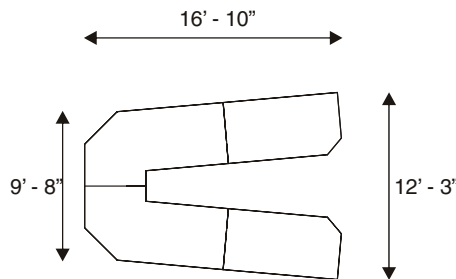
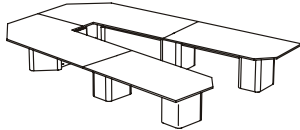

Overall table space :
 25' long by 20' minimum

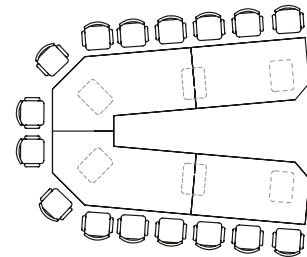

Seats 16 at table

IMPORTANT: Tables are standard with wood grain running length of table.

Edge Options Information

Tables are available with the following edge options:

- WoodPlus 3 mm PVC edge
- Standard 3 mm Wood Edge
- Detailed 3/8" Wood Edge
- 2000 Series hardwood edges
- 3000 Series hardwood edges

Edge Options Information	WoodPlus 3 mm PVC	Standard Wood	Detailed Wood	2000 Wood	3000 Wood
	Equations WPES	Equations SWES	RE	2000	1000
	Modular 8 WPER	Modular 8 SWER	RA	2001	1100
	WPMS	SWMS	BE	2002	1200
	WPEN	SWEN	TR	2003	2200
	WPMN	SWMN	CL	2004	2100
	WPMR	SWMR			

7% price increase effective January 1, 2009

Conference Tables - WoodPlus²

Description Model No. Overall Dimensions
Deep Long Wgt List Prices
WoodPlus²

WoodPlus² 'Egg' Table with Radius Half Cylinder Base

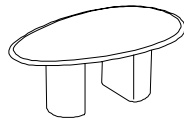

TEG-4676-RHC

46" wide	TEG-4676-RHC-WP2	46	76	286	2496
Top: 1 piece; Base: 2 Radius Half Cylinders					

WoodPlus² Round Tables



TD-46-COLX

Round,	TD-42D-COLX-WP2	42	42	76	1010
Column X Base	TD-46D-COLX-WP2	46	46	96	1120

Base finish is Black or Silver powdercoat.
(No Grommet option available)

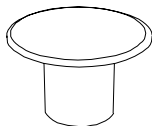

TD-46-CYL

Round,	TD-42D-CYL-WP2	42	42	140	1298
Cylinder Base	TD-46D-CYL-WP2	46	46	164	1384

42" uses 18" diameter Cylinder; 46" uses 20" diameter Cylinder.
Note: Table requires counterweight for stability. Bags provided for sand (sand not included).

Order information:

Qty	Model Number	Top finish	Base finish	Options
1	TR-46120-TA-WP2	WP2-81	CG1	
1	TT-BE-42120-RC-WP2	WP2-81	WP2-81	
2	TB-BE-46168-RC-WP2	CP2-38	CP2-88	
1	TD-42D-TA-WP2	CP2-38	CG1	
2	TR-42144-HC-WP2	CP2-38	CP2-88	
1	TEG-4676-RHC-WP2	WP2-81	WP2-81	

Notes

Tables are shipped
RTA (ready to assemble)

Important:

WoodPlus² Conference Tables are standard with wood grain running length of table.

7% price increase effective January 1, 2009

Options for Conference WoodPlus and WoodPlus2 Tables

Description	Model Number	Dimensions			Wgt	List Price
		Wide	Deep	High		

WoodPlus table top INLAYS

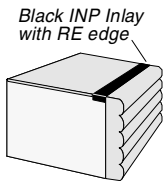

Black, Rectangular	INLAY-RECT-ALL-BLACK					413
---------------------------	----------------------	--	--	--	--	------------

Black, Shaped	INLAY-SHAPE-ALL-BLACK					712
----------------------	-----------------------	--	--	--	--	------------

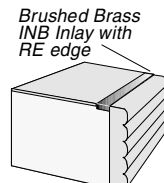

Brass, Rectangular	INLAY-RECT-ALL-BRASS					826
---------------------------	----------------------	--	--	--	--	------------

Brass, Shaped	INLAY-SHAPE-ALL-BRASS					1409
----------------------	-----------------------	--	--	--	--	-------------

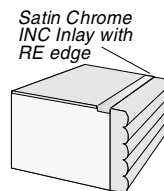

Chrome, Rectangular	INLAY-RECT-ALL-CHROME					826
----------------------------	-----------------------	--	--	--	--	------------

Chrome, Shaped	INLAY-SHAPE-ALL-CHROME					1409
-----------------------	------------------------	--	--	--	--	-------------

WoodPlus table top 3" radius corners

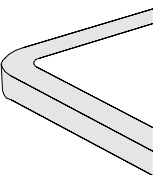

Add Radius	Top-C3R-WPE					412
-------------------	-------------	--	--	--	--	------------

Corners	Top-C3R-STD					412
----------------	-------------	--	--	--	--	------------

	Top-C3R-DET					594
--	-------------	--	--	--	--	------------

	Top-C3R-2000					840
--	--------------	--	--	--	--	------------

	Top-C3R-3000					840
--	--------------	--	--	--	--	------------

3" radius on the inside of the edge. To order add '-C3R' to the end of the table model.
 Rectangular top with Radius corners uses the the Shaped top INLAY upcharge.
 Not available on the 3400 Reverse Knifecut Edge.

WoodPlus table top Bow Ends

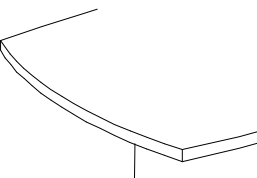

Add Bow Ends	Top-BE-WPE					283
---------------------	------------	--	--	--	--	------------

	Top-BE-STD					283
--	------------	--	--	--	--	------------

	Top-BE-DET					283
--	------------	--	--	--	--	------------

	Top-BE-2000					283
--	-------------	--	--	--	--	------------

	Top-BE-3000					283
--	-------------	--	--	--	--	------------

To order add '-BE' to the end of the table model number.
 Rectangular top with Bow End uses the Shaped top INLAY charge.

7% price increase effective January 1, 2009

Options for Conference WoodPlus and WoodPlus2 Tables

Description	Model Number	Dimensions			Wgt	List Price
		Wide	Deep	High		

Grommets and Inserts



Grommets	GR	4.25	2.75	0		48
-----------------	----	------	------	---	--	-----------

GR = Grommet with cover. Opening: 2 x 3.5

Specify location of grommets, see following page.

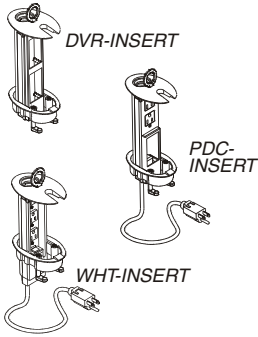

Inserts for above grommets	DVR-INSERT	4.25	2.75	5	1	66
	PDC-INSERT	4.25	2.75	5	1	138
	WHT-INSERT	4.25	2.75	5	1	148

WHT = Work Height Triplex. 6' cord.
WHT pull up size: 2 x 3.5 x 5-1/8 high when extended.

DVR = Data / Voice Receptacle.
DVR pull up size: 2 x 3.5 x 5-1/8 high when extended. DVR is a work surface Pop-up that accepts various receptacle plates to be supplied by your electrical contractor or installer.
DVR does NOT INCLUDE any receptacles or receptacle plates.

PDC = Power / Data Combination.
PDC pull up size: 2 x 3.5 x 5-1/8 high when extended. PDC is a work surface pop-up that accepts a combination of Power, Data and Voice (telephone) outlets (up to 2 each).
PDC does NOT INCLUDE any receptacles or receptacle plates.

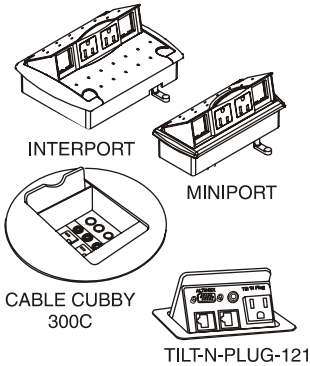

Recessed electrical, data access	MINIPLUG-120	7	3	2	2	197
	MINIPLUG-STARTER-72	7	3	2	2	440
	MINIPLUG-ADDER-48	7	3	2	2	246
	MINIPLUG-ADDER-72	7	3	2	2	246
	MINIPLUG-ADDER-120	7	3	2	2	246
	INTERPORT-PLUG-120	7	5	2	2	236
	INTERPORT-STARTER-72	7	5	2	2	470
	INTERPORT-ADDER-48	7	5	2	2	262
	INTERPORT-ADDER-72	7	5	2	2	262
	INTERPORT-ADDER-120	7	5	2	2	262
	CABLE-CUBBY-300C	6.5	6.5	0	1	1322
	TILT-N-PLUG-121	5	5	0	1	1322
	TILT-N-PLUG-121-UL	5	5	0	1	1502

MINIPLUG-PLUG and INTERPORT-PLUG both house two electrical outlets with 6' cord and two data locations. The receptacle plates for most connectors are included. Electrical outlets with plug ends. **Data connectors are NOT included.**

MINIPLUG and INTERPORT may be setup 'daisy-chained' and hardwired to the building power supply, please contact Customer Service with your requirements.

CABLE-CUBBY-300C has a round faceplate and houses two AC outlets, one video and two audio jacks, up to three sizes of pass through cable openings (using AAP Architectural Adapter Plates). Electrical outlets with plug ends. **Data connectors are NOT included.**

TILT-N-PLUG-121 houses single input plate with Computer Video (15-pin HD), Computer Audio (Stereo Mini), Modem (RJ11), and Network (RJ45) input connections. One electrical outlet with plug end. **Data connectors are NOT included.**

TILT-N-PLUG-121-UL is a UL labeled product with the same configuration as the TILT-N-PLUG-121

Specify location, see following page. When a power - data unit is located directly over a table base, any cutouts in the table base required for the unit to open and close are automatically included.

INTERPORT-PLUG, MINIPLUG-PLUG and TILT-N-PLUG-121 are orientated to the 'side' of the table.

MINI-ACT options For MINI-ACT models, layout and options please see the MINI-ACT section between the ACT tables and the CONFERENCE tables

7% price increase effective January 1, 2009

Options for Conference WoodPlus and WoodPlus2 Tables

Description	Model Number	Dimensions			Wgt	List Price
		Wide	Deep	High		
Table top power and data units						
Recessed electrical, data access	MINIPOINT-PLUG-120	7	3	2	2	197
	MINIPOINT-STARTER-72	7	3	2	2	440
	MINIPOINT-ADDER-48	7	3	2	2	246
	MINIPOINT-ADDER-72	7	3	2	2	246
	MINIPOINT-ADDER-120	7	3	2	2	246
	INTERPORT-PLUG-120	7	5	2	2	236
	INTERPORT-STARTER-72	7	5	2	2	470
	INTERPORT-ADDER-48	7	5	2	2	262
	INTERPORT-ADDER-72	7	5	2	2	262
	INTERPORT-ADDER-120	7	5	2	2	262
	CABLE-CUBBY-300C	6.5	6.5	0	1	1322
	CABLE-CUBBY-300C-A	6.5	6.5		1	1322
	TILT-N-PLUG-121	5	5	0	1	1322
	TILT-N-PLUG-121-UL	5	5	0	1	1502

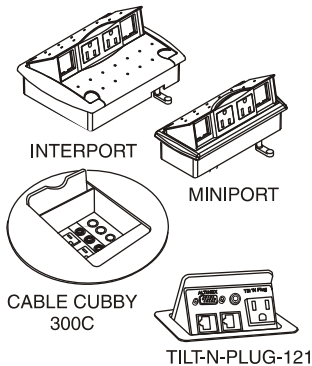

MINIPOINT-PLUG and INTERPORT-PLUG both house two electrical outlets with 10' cord and two data locations. The receptacle plates for most connectors are included. Electrical outlets with plug ends. **Data connectors are NOT included.**

MINIPOINT and INTERPORT may be setup 'daisy-chained' and hardwired to the building power supply, please contact Customer Service with your requirements.

CABLE-CUBBY-300C has a round faceplate and houses two AC outlets, one video and two audio jacks, up to three sizes of pass through cable openings (using AAP Architectural Adapter Plates). Electrical outlets with plug ends. **Data connectors are NOT included.**

CABLE-CUBBY-300C-A has a round faceplate and houses two AC outlets, one each of the following: RJ45, RJ25, HD15, 3.5MM audio jack.

TILT-N-PLUG-121 houses single input plate with Computer Video (15-pin HD), Computer Audio (Stereo Mini), Modem (RJ11), and Network (RJ45) input connections. One electrical outlet with plug end. **Data connectors are NOT included.** TILT-N-PLUG-121-UL is a UL labeled product with the same configuration as the TILT-N-PLUG-121

Specify location, see following page. When a power - data unit is located directly over a table base, any cutouts in the table base required for the unit to open and close are automatically included.

INTERPORT-PLUG, MINIPOINT-PLUG and TILT-N-PLUG-121 are orientated to the 'side' of the table.

INSERTS for INTERPORTS and MINIPOINTS

MINI-ACT	INSERT-MA-CAT6-RJ45-S68	28
INSERTS	INSERT-MA-CAT5-RJ45-S58	17
	INSERT-MA-PHONE-RJ25-S6U	14
	INSERT-MA-AUDIO-RCA	15
	INSERT-MA-VIDEO-1SVHS	18
	INSERT-MA-AUDIO-35MM with solder back connections	38
	INSERT-MA-VIDEO-HD15 with solder back connections	90

MINIPOINT models have one door. Door does not close when the 3.5mm audio jack or HD15 video connector are installed



Options for Conference WoodPlus and WoodPlus2 Tables

CONFERENCE TABLES - GROMMET and BASE HINGED DOOR LOCATIONS

RADIUS CUBE BASE

TT48120-RC

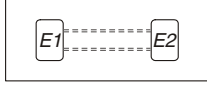

TT48150-RC

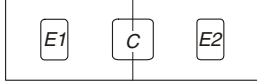

PANEL END BASE

TB48120-PEB



TB48168-PEB



NOTE: see GR-PEB-END and GR-PEB-CENTER for details

CYLINDER BASE

TR48150-CYL



TR48168-CYL

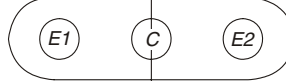

HALF CYLINDER BASE

TR48120-HC

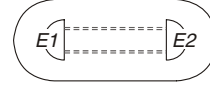

TR48150-HC

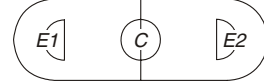

TT58216-RC

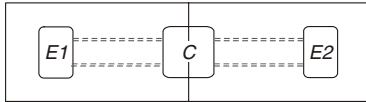

TT58240-RC

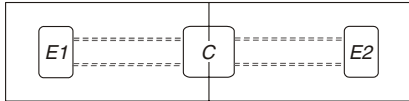

TT58288-RC*

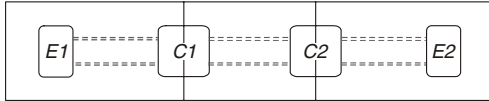

TR58168-CYL

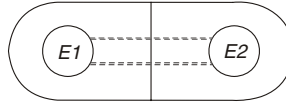

TR58240-CYL

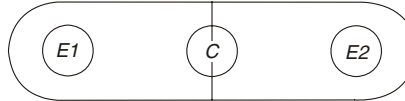

TT58288-CYL*



RADIUS HALF CYLINDER

TEG5896-RHC

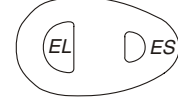

Specify Small or Large End

TDE58144-RC

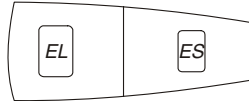

TDE58150-RC

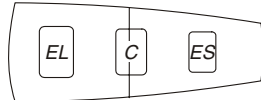

TDE58216-RC

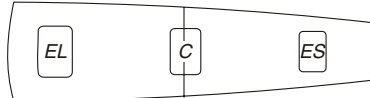

Specify End Large, Center or End Small as shown

TD60-CYL

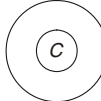

TD66-CYL

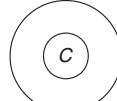

TD72-CYL

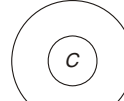

*E1 and E2 locations interchangeable except when table requires four bases.

BHD - Base Hinged Door option
When placing a grommet over an RC, HC, CYL or RHC base, we recommend an optional BHD Base Hinged Door in the base for access to floor monument.

TW Wing table

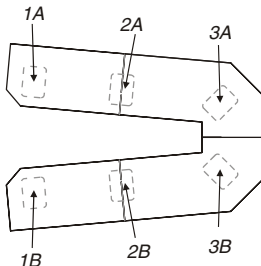

TKZ Kaizen table

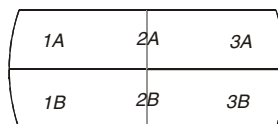

7% price increase effective January 1, 2009

Options for Conference WoodPlus and WoodPlus2 Tables

Base Options: Hinged Doors, Notches, Silver or Black Accent

Description	Model Number	Dimensions			Wgt	List Price
		Wide	Deep	High		
Base Hinged Door	BHD-RC	12		12		145
	BHD-HC	12		12		145
	BHD-CYL	12		12		308

To order Base Hinged Doors add to end of the model number
 BHD-RC on Radius Cube, BHD-HC on Half Cylinder, BHD-RHC on Radius Half Cylinder,
 BHD-CYL on full Cylinder (used in CYL bases or as the center base on TR...HC tables).

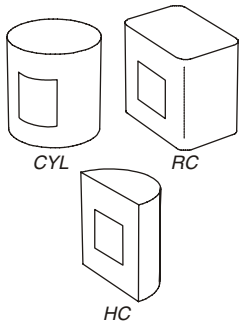

Base wire notch	NU-BASE-NOTCH-UPPER					97
------------------------	---------------------	--	--	--	--	-----------

Notches in both sides of the top edge of the all bases.

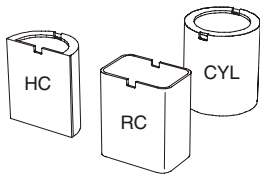

NU Base Notch option for

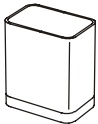

Base Silver Accent	BASE-SILVER-ACCENT-1	add accent to a table with one base				164
	BASE-SILVER-ACCENT-2	add accent to a table with two bases				328
	BASE-SILVER-ACCENT-3	add accent to a table with three bases				492
	BASE-SILVER-ACCENT-4	add accent to a table with four bases				657

Add the 3" accent strip to the bottom of each table base: HC, CYL, RC.

Base Black Accent	BASE-BLACK-ACCENT-1	add accent to a table with one base				111
	BASE-BLACK-ACCENT-2	add accent to a table with two bases				222
	BASE-BLACK-ACCENT-3	add accent to a table with three bases				333
	BASE-BLACK-ACCENT-4	add accent to a table with four bases				445

Add the 3" black accent strip to the bottom of each table base: HC, CYL, RC.

Clam shell base	BASE-CLAM-CONF			48		645
------------------------	----------------	--	--	----	--	------------

Use the clam shell base to protect and hide wiring when the power / wiring access is not located at a table base

Clam Shell shown OPEN and CLOSED

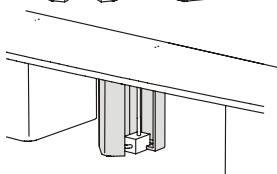

Self-stick Wiremanager	RMN-22	22		1		18
	RMN-96	96		4		49

Extruded PVC with 'double-sided' tape included for installation.

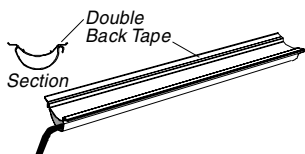

7% price increase effective January 1, 2009

Modular Conference Tables

Overview - Modular Conference Tables

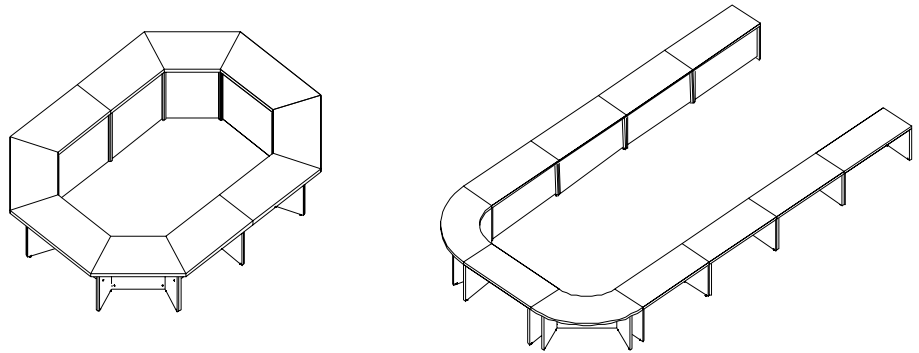

Above configurations are shown in detail on the following pages

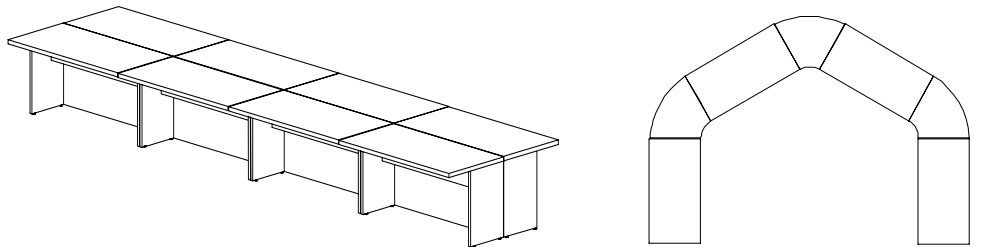

Above configurations are shown in detail on the following pages

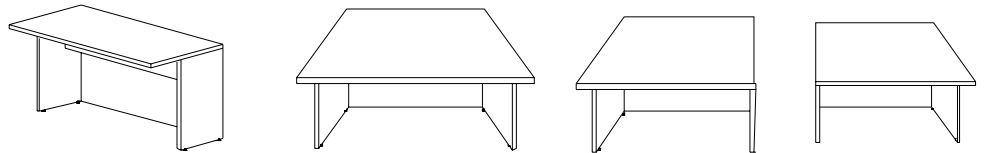

Modular Conference Table SECTIONS, freestanding, see Pg 97

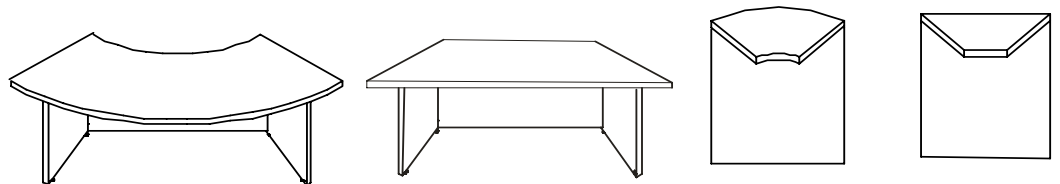

Modular Conference Table FILLERS, requiring support at both ends, see Pg 98

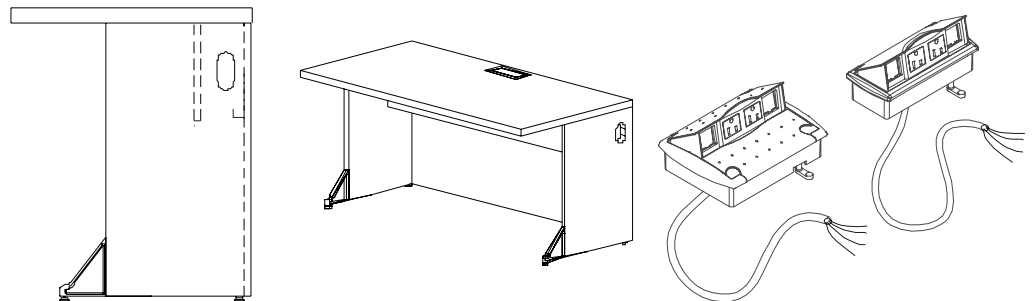

Options and Accessories, see Pg 99

7% price increase effective January 1, 2009

Modular Conference Tables

Modular Conference Tables configuration MT-101

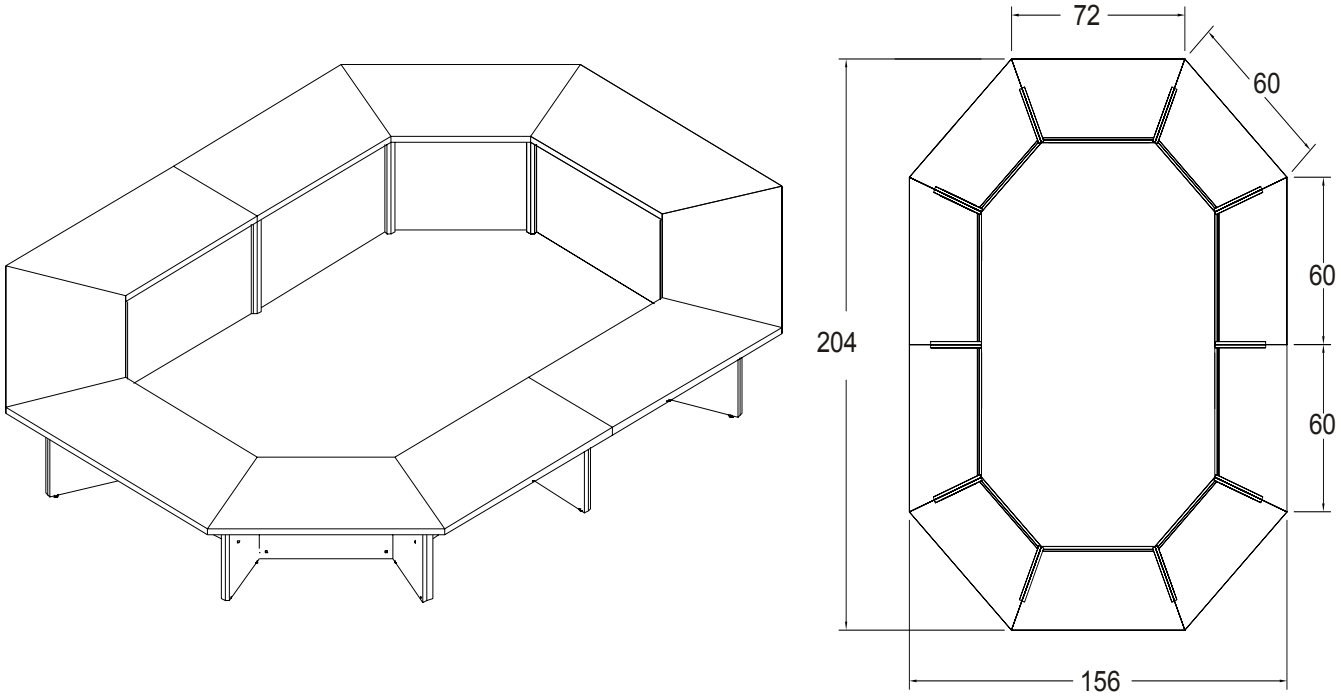

**Overall footprint is 156" wide by 204" long (13' by 17')
using Trapezoid and Half-trapezoid top shapes
Seating for 16 to 20 people.**

Description	Model Number	Dimensions			Qty	List Prices		
		Deep	Long	High		WoodPlus	Standard	Wood Edges Detailed
Trapezoid section 72 long	MT-SS-TZ-307229	30	72	29	2	1555	1733	1939
Trapezoid section 60 long	MT-SS-TZ-306029	30	60	29	4	1517	1695	1901
Half-trapezoid section 60 long - LEFT	MT-SS-THL-306029	30	60	29	2	1454	1632	1838
Half-trapezoid section 60 long - RIGHT	MT-SS-THR-306029	30	60	29	2	1454	1632	1838
MT-101						14994	16774	18834

All connecting hardware is included.
Options and Accessories are available at the end of this section.

Edge Options Information

Modular tables are available with the following edge options:

- WoodPlus 3 mm PVC edge Laminate Table Tops only
- Standard 3 mm Wood Edge
- Detailed 3/8" Wood Edge

WoodPlus 3 mm PVC	Standard Wood	Detailed Wood
Equations WPES	Equations SWES	RE
Modular 8 WPER	Modular 8 SWER	RA
WPMS	SWMS	BE
WPMN	SWMN	TR
WPMR	SWMR	CL

7% price increase effective January 1, 2009

Modular Conference Tables

Modular Conference Tables configuration MT-102

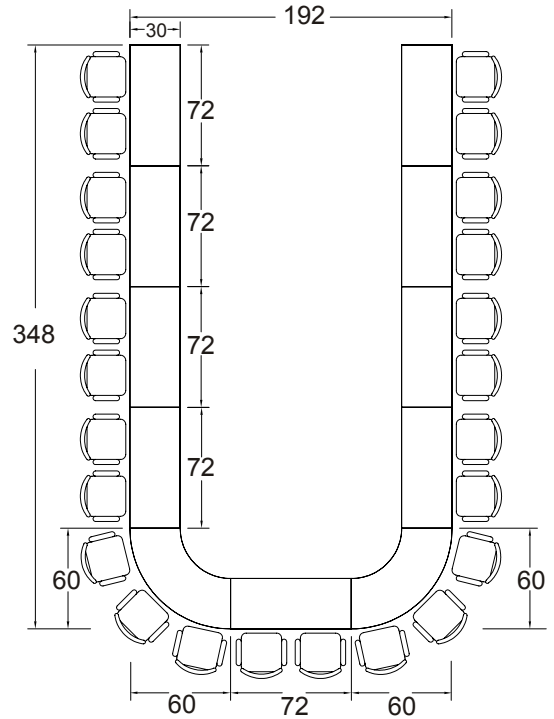
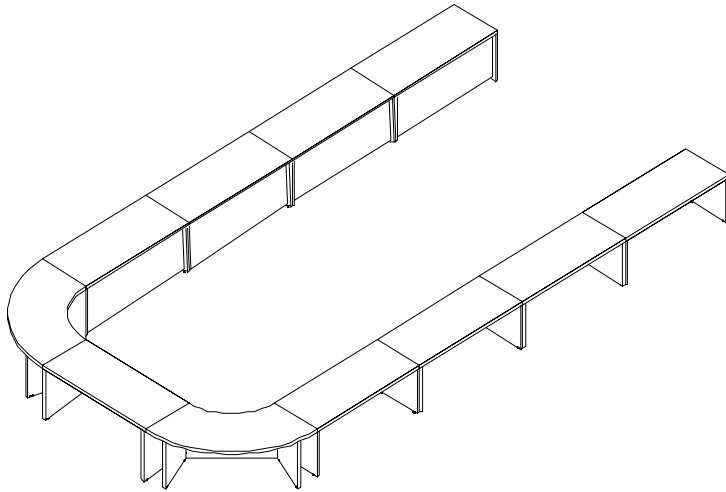

Overall footprint is 192" wide by 348" long (16' by 29')
Seating for 24 people

Description	Model Number	Dimensions			Qty	List Prices		
		Deep	Long	High		WoodPlus	Standard	Wood Edges Detailed
Rectangle section - 72 long	MT-SS-TT-307229	30	72	29	9	1345	1526	1711
Curved Corner section	MT-SC-90-606029	60	60	29	2	2449	2594	2780
MT-102					17003	18922	20959	

All connecting hardware is included.
 Options and Accessories are available at the end of this section.

Notes:

- Modular tables are shipped
 RTA (ready to assemble)

Options

Options are built-in at factory

Grommets and Inserts
 see page at end of this section

INLAY

-available ONLY with Detailed edge

INP Black 3mm (1/8") Inlay:
 Modular Shaped tops

INB Brushed Brass 3mm Inlay or
 INC Satin Chrome 3mm Inlay:
 Modular Shaped tops

Options

Options are built-in at factory

See the end of this section for
 pricing on all options and
 accessories.

7% price increase effective January 1, 2009

Modular Conference Tables

Modular Conference Tables configuration MT-103

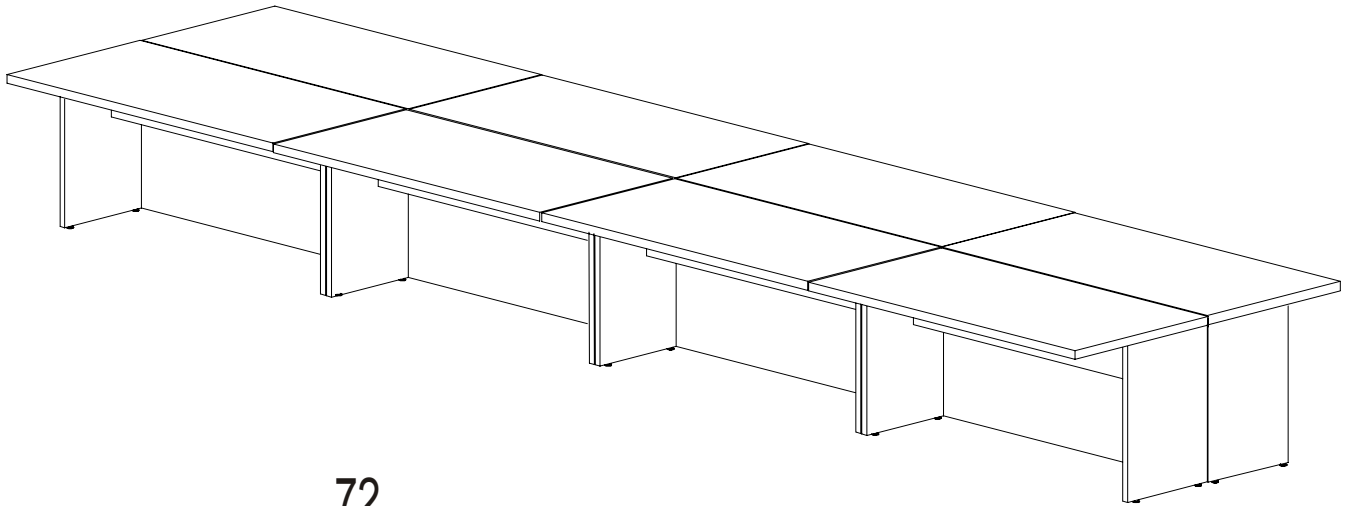

72

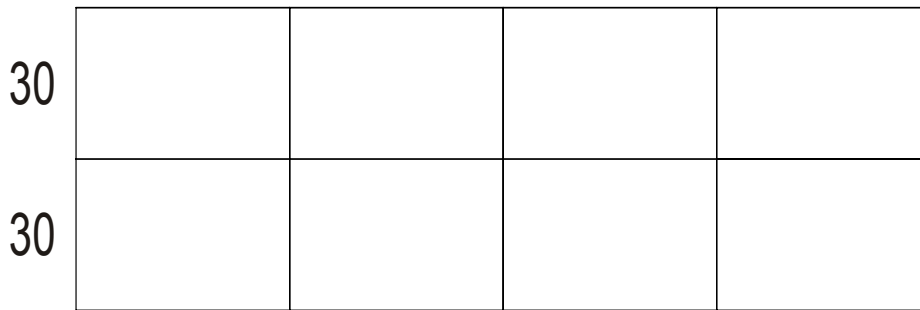

Overall footprint is 60" by 288" (5' by 24')

Desk top size is 30" x 72"

Seating for 20 people.

Description	Model Number	Dimensions			Qty	List Prices		
		Deep	Long	High		WoodPlus	Standard	Wood Edges Detailed
Rectangle section - 72 long	MT-SS-TT-307229	30	72	29	8	1345	1523	1729
	MT-103					10760	12184	13832

All connecting hardware is included.
Options and Accessories are available at the end of this section.

Edge Options Information

Modular tables are available with the following edge options:

- WoodPlus 3 mm PVC edge Laminate Table Tops only
- Standard 3 mm Wood Edge
- Detailed 3/8" Wood Edge

WoodPlus 3 mm PVC	Standard Wood	Detailed Wood
Equations WPES	Equations SWES	RE
Modular 8 WPER	Modular 8 SWER	RA
WPMS	SWMS	BE
WPMN	SWMN	TR
WPMR	SWMR	CL

7% price increase effective January 1, 2009

Modular Conference Tables

Modular Conference Tables configuration MT-104

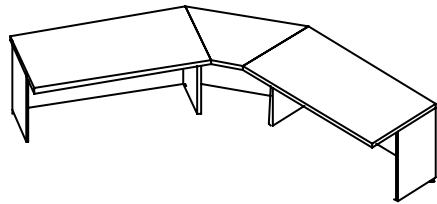

Seating on inside of table.

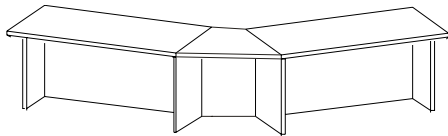

Seating on outside of table.

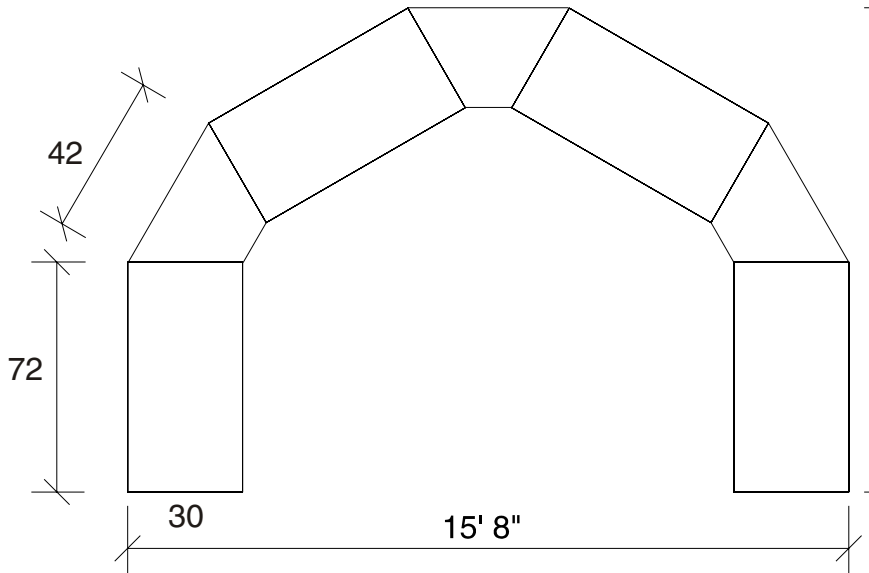

This configuration may be setup to provide either 'inside' or 'outside' seating. Please specify either 'inside' or 'outside' seating when ordering.

MT-104 footprint is 126" deep by 188" long (10' 6" by 15' 8")

Rectangle section is 30" deep by 60" long.

Filler Angled is 60 degree angle at 30" deep by 42" long

On outside, seating for 11 people.

On inside, seating for 8 people.

Description	Model Number	Dimensions			Qty	List Prices		
		Deep	Long	High		WoodPlus	Standard	Detailed
Rectangle section - 72 long	MT-SS-TT-306029	30	60	29	4	1307	1485	1691
Angled Corner filler - 60 degrees	MT-FA-60-304229	30	42	29	3	720	862	1006
MT-104						7388	8526	9782

All connecting hardware is included.
Options and Accessories are available at the end of this section.

Notes:

- Modular tables are shipped RTA (ready to assemble)

Options

Options are built-in at factory

Grommets and Inserts see page at end of this section

INLAY

-available ONLY with Detailed edge

INP Black 3mm (1/8") Inlay:
Modular Shaped tops

INB Brushed Brass 3mm Inlay or
INC Satin Chrome 3mm Inlay:
Modular Shaped tops

Options

Options are built-in at factory

See the end of this section for pricing on all options and accessories.

7% price increase effective January 1, 2009

Modular Conference Tables

Modular Conference Tables configuration MT-105

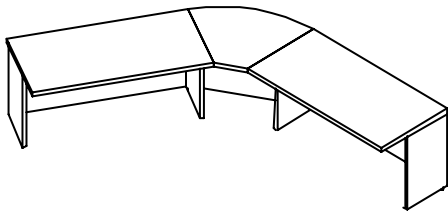

Seating on inside of table.

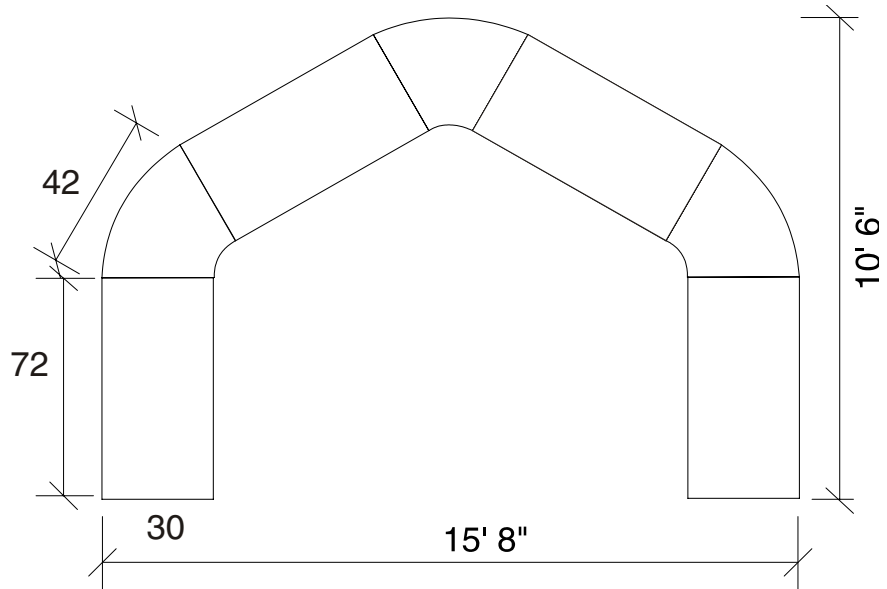

This configuration may be setup to provide either 'inside' or 'outside' seating. Please specify either 'inside' or 'outside' seating when ordering.

MT-105 footprint is 126" deep by 188" long (10' 6" by 15' 8")

Rectangle section is 30" deep by 60" long.

Filler Curved is 60 degree angle at 30" deep by 42" long

On outside, seating for 11 people.

On inside, seating for 8 people.

Description	Model Number	Dimensions			Qty	List Prices		
		Deep	Long	High		WoodPlus	Standard	Wood Edges Detailed
Rectangle section - 72 long	MT-SS-TT-306029	30	60	29	4	1307	1485	1691
Curved Corner filler - 60 degrees	MT-FC-60-304229	30	42	29	3	747	889	1033
MT-105						7469	8607	9863

All connecting hardware is included.
Options and Accessories are available at the end of this section.

Edge Options Information

Modular tables are available with the following edge options:

- WoodPlus 3 mm PVC edge Laminate Table Tops only
- Standard 3 mm Wood Edge
- Detailed 3/8" Wood Edge

WoodPlus 3 mm PVC	Standard Wood	Detailed Wood
Equations WPES	Equations SWES	RE
Modular 8 WPER	Modular 8 SWER	RA
WPMS	SWMS	BE
WPMN	SWMN	TR
WPMR	SWMR	CL

7% price increase effective January 1, 2009

Modular Conference Tables

Modular Conference Table SECTIONS, freestanding

Description	Model Number	Dimensions			Wgt	List Prices		
		Deep	Long	High		Wood Edges		
					WoodPlus	Standard	Detailed	
Rectangular Sections	MT-SS-TT-306029	30	60	29	1307	1485	1695	
	MT-SS-TT-306629	30	66	29	1327	1505	1711	
	MT-SS-TT-307229	30	72	29	1345	1539	1729	

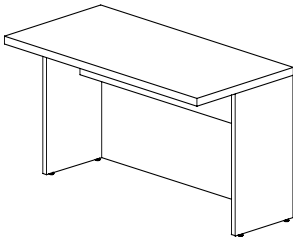

Full trapezoid	MT-SS-TZ-306029	30	60	29	1517	1695	1901
	MT-SS-TZ-306629	30	66	29	1537	1715	1929
	MT-SS-TZ-307229	30	72	29	1555	1733	1939

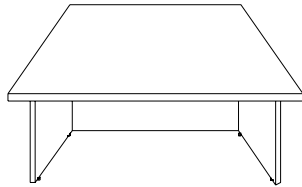

Drawing shows 'back' panel location when seating is on the 'outside' of the layout.

Half trapezoid, angle to LEFT	MT-SS-THL-306029	30	60	29	1454	1632	1858
	MT-SS-THL-306629	30	66	29	1474	1652	1868
	MT-SS-THL-307229	30	72	29	1492	1670	1876

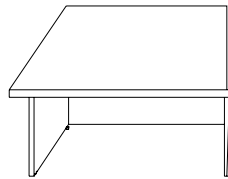

from the 'long' side the angle end is to the LEFT

Drawing shows 'back' panel location when seating is on the 'outside' of the layout.

Half trapezoid, angle to RIGHT	MT-SS-THR-306029	30	60	29	1454	1632	1858
	MT-SS-THR-306629	30	66	29	1474	1652	1868
	MT-SS-THR-307229	30	72	29	1492	1670	1876

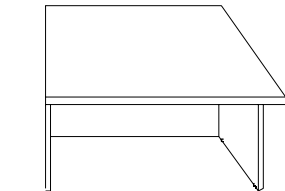

from the 'long' side the angle end is to the RIGHT

Drawing shows 'back' panel location when seating is on the 'outside' of the layout.

Description	Model Number	Deep	Long	High	Angle	Wgt	WoodPlus	Standard	Detailed
Curved Corner Section	MT-SC-90-606029	60	60	29	90	2449	2594	2780	
	MT-SC-60-606029			29	60	2549	2694	2880	
	MT-SC-45-606029			29	45	2649	2794	2980	

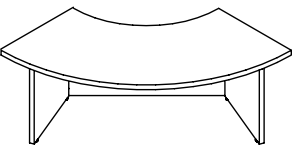

Drawing shows 'back' panel location when seating is on the 'outside' of the layout.

Description	Model Number	Deep	Long	High	Angle	Wgt	WoodPlus	Standard	Detailed
Angled Corner Section	MT-SA-90-606029	60	60	29	90	1811	1956	2142	
	MT-SA-60-606029			29	60	1861	2006	2192	
	MT-SA-45-606029			29	45	1911	2056	2242	

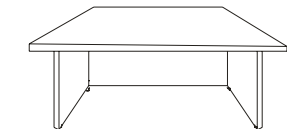

Drawing shows 'back' panel location when seating is on the 'outside' of the layout.

Notes:

- Modular tables are shipped RTA (ready to assemble)

Options

Options are built-in at factory

Grommets and Inserts see page at end of this section

INLAY

-available ONLY with Detailed edge

INP Black 3mm (1/8") Inlay:
Modular Shaped tops

INB Brushed Brass 3mm Inlay or
INC Satin Chrome 3mm Inlay:
Modular Shaped tops

Options

Options are built-in at factory

See the end of this section for pricing on all options and accessories.

7% price increase effective January 1, 2009

Modular Conference Tables

Modular Conference Table *FILLERS*, requiring support at both ends

Description	Model Number	Dimensions				List Prices		
		Deep	Long	High	Angle	WoodPlus	Standard	Detailed
Filler Curved	MT-FC-90-304229	30	42	29	90	747	889	1033
	MT-FC-60-304229				29 60	747	889	1033
	MT-FC-30-304229				29 45	747	889	1033

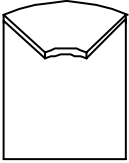

Drawing shows 'back' panel location when seating is on the 'inside' of the layout. Fillers are NOT freestanding and require support at both ends.

Description	Model Number	Deep	Long	High	Angle	List Prices		
					Angle	WoodPlus	Standard	Detailed
Filler Angle	MT-FA-90-304229	30	42	29	90	720	862	1006
	MT-FA-60-304229				29 60	720	862	1006
	MT-FA-30-304229				29 45	720	862	1006

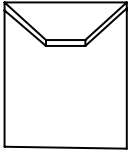

Drawing shows 'back' panel location when seating is on the 'inside' of the layout. Fillers are NOT freestanding and require support at both ends.

In these layouts either the 90 degree freestanding SECTIONS or the 90 degree fillers (requiring support at both ends) may be used.

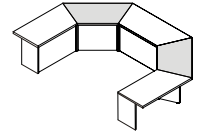
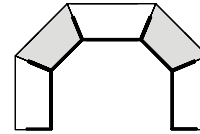
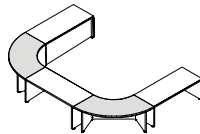
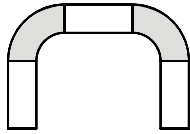

In these layouts either the 60 degree freestanding SECTIONS or the 60 degree fillers (requiring support at both ends) may be used.

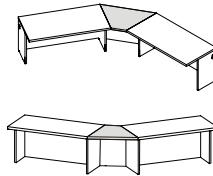
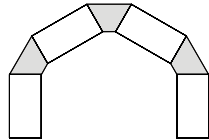

Edge Options Information

Modular tables are available with the following edge options:

- WoodPlus 3 mm PVC edge Laminate Table Tops only
- Standard 3 mm Wood Edge
- Detailed 3/8" Wood Edge

WoodPlus 3 mm PVC	Equations	Standard Wood	Equations	Detailed Wood
	WPES		SWES	RE
Modular 8	WPER	Modular 8	SWER	RA
	WPEN		SWEN	BE
	WPMS		SWMS	TR
	WPMN		SWMN	CL
	WPMR		SWMR	

7% price increase effective January 1, 2009

Modular Conference Tables

Options and Accessories

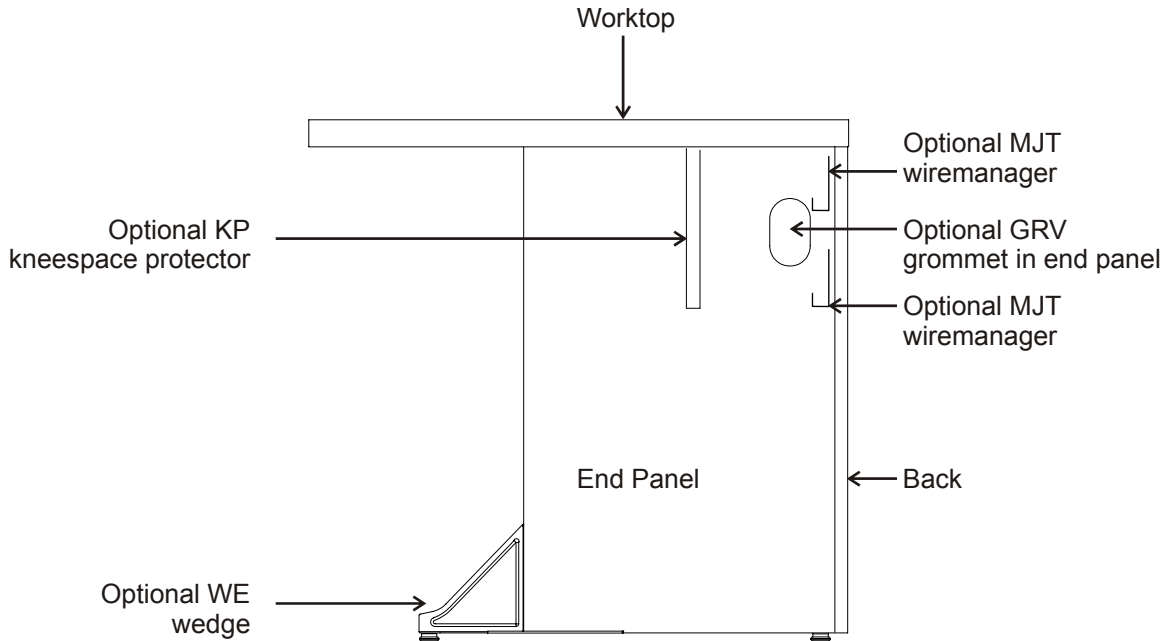

Description	Model Number	Dimensions			Wgt	List Prices		
		Deep	Long	High		Wood Edges		
					WoodPlus	Standard	Detailed	
Kneespace Protectors	MT-KP-60	1	58	28	168	189	189	
	MT-KP-66	1	64	28	168	189	189	
	MT-KP-72	1	70	28	168	189	189	
MJT wiremanager	MJT-48		45		50	50	50	
	MJT-54		51		54	54	54	
	MJT-60		57		58	58	58	
	MJT-66		63		66	66	66	
	MJT-72		69		66	66	66	
		mounts to the inside of the back						
	RMN-22				18	18	18	
	Wiremanager mounted on end panel							
Grommet in end panel	GRV-L				48	48	48	
	GRV-R				48	48	48	

Notes:

- Modular tables are shipped RTA (ready to assemble)

Options

Options are built-in at factory

Grommets and Inserts see page at end of this section

INLAY

-available ONLY with Detailed edge

INP Black 3mm (1/8") Inlay:
Modular Shaped tops

INB Brushed Brass 3mm Inlay or
INC Satin Chrome 3mm Inlay:
Modular Shaped tops

Options

Options are built-in at factory

See the end of this section for pricing on all options and accessories.

7% price increase effective January 1, 2009

Modular Conference Tables

Options and Accessories

Description	Model Number	Dimensions			Wgt	List Prices		
		Deep	Long	High		WoodPlus	Standard	Detailed
Wedge on end panel	WEDGE-SILVER-EACH					26	26	26
	WEDGE-BLACK-EACH					26	26	26

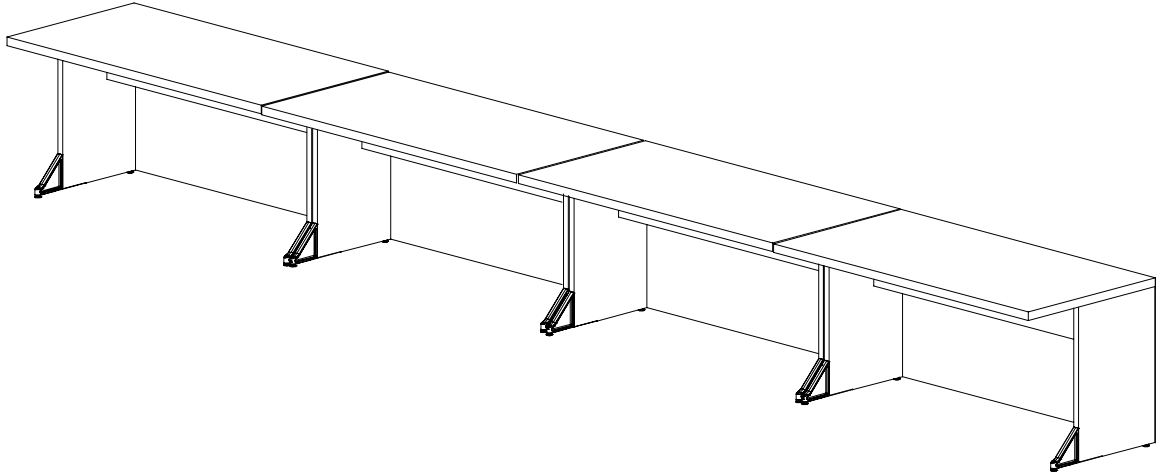

Edge Options Information

Modular tables are available with the following edge options:

- WoodPlus 3 mm PVC edge
Laminate Table Tops only
- Standard 3 mm Wood Edge
- Detailed 3/8" Wood Edge

	WoodPlus 3 mm PVC	Standard Wood	Detailed Wood
	Equations WPES	Equations SWES	RE
Modular 8	WPER	Modular 8 SWER	RA
	WPMS WPEN	SWMS SWEN	BE
	WPMN	SWMN	TR
	WPMR	SWMR	CL

7% price increase effective January 1, 2009

Modular Tables

Overview - Modular Tables

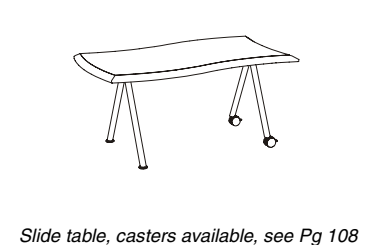
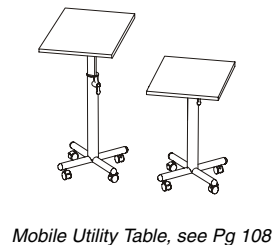
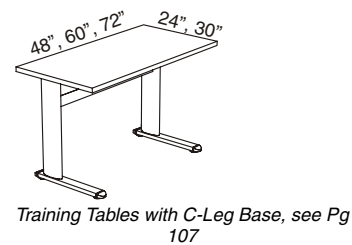
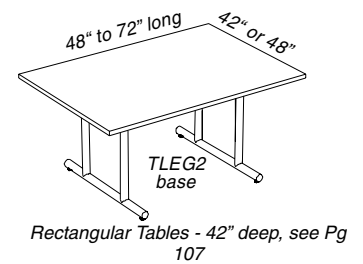
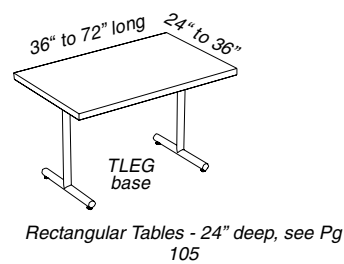
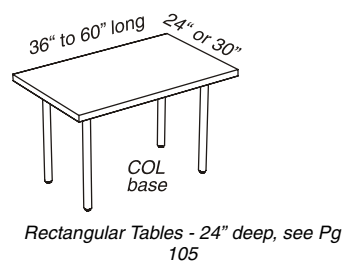
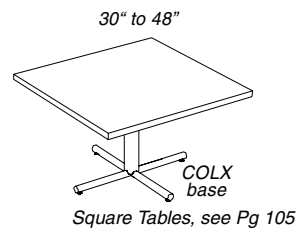
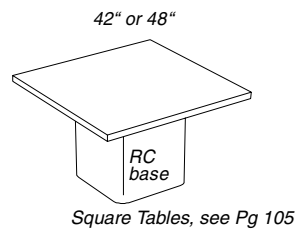
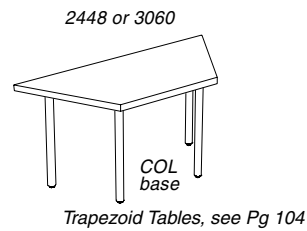
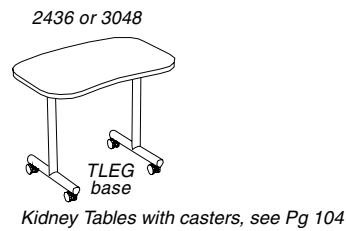
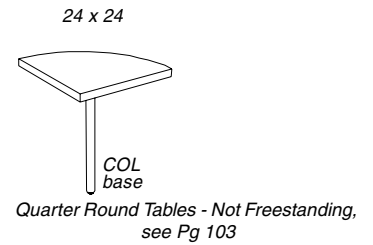
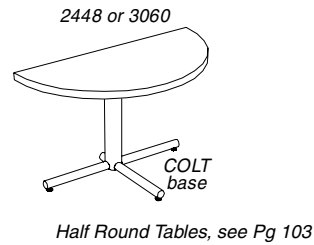
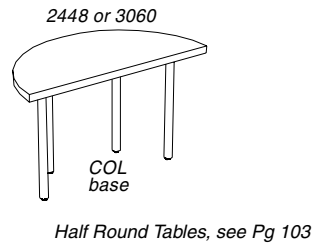
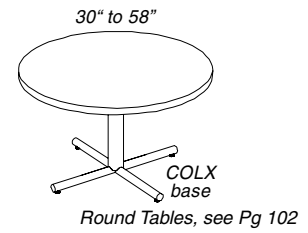
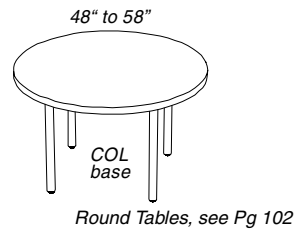
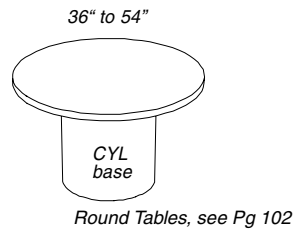

7% price increase effective January 1, 2009

Modular Tables

Round Tables

Description	Model Number	Dimensions			Wgt	List Prices		
						WoodPlus	Standard	Detailed
Cylinder Base	TD36-CYL	36	36	29	113	1351	1434	1515
	TD42-CYL	42	42	29	140	1488	1584	1704
	TD48-CYL	48	48	29	155	1535	1631	1751
	TD54-CYL	54	54	29	172	1736	1878	2022
	TD58-CYL	58	58	29	204	2015	2215	2683

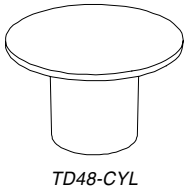

TD36-CYL and TD42-CYL include a sandbag (sand not included), counterweight required for added stability.

2" column legs	TD48-COL	48	48	29	91	1222	1318	1438
	TD54-COL	54	54	29	108	1335	1477	1621
	TD58-COL	58	58	29	126	1487	1629	1773

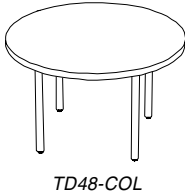

Please specify base finish as black or silver.

with casters	TD48-COL-CA	48	48	29	91	1276	1372	1492
	TD54-COL-CA	54	54	29	108	1428	1570	1714
	TD58-COL-CA	58	58	29	126	1540	1682	1826

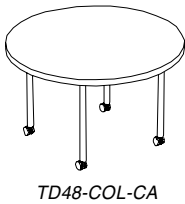

Please specify base finish as black or silver.

X on floor, center column	TD30-COLX	30	30	29	46	994	1077	1158
	TD36-COLX	36	36	29	56	1040	1123	1204
	TD42-COLX	42	42	29	75	1176	1272	1392
	TD48-COLX	48	48	29	93	1245	1341	1461
	TD54-COLX	54	54	29	110	1416	1558	1702
	TD58-COLX	58	58	29	128	1525	1667	1811



Please specify base finish as black or silver.

with casters	TD48-COLX-CA	48	48	29	93	1276	1372	1492
	TD54-COLX-CA	54	54	29	110	1428	1570	1714
	TD58-COLX-CA	58	58	29	128	1540	1682	1826



Please specify base finish as black or silver.

Edge Options Information

Modular tables are available with the following edge options:

- WoodPlus 3 mm PVC edge Laminate Table Tops only
- Standard 3 mm Wood Edge
- Detailed 3/8" Wood Edge

	WoodPlus 3 mm PVC	Standard Wood	Detailed Wood
	Equations WPES	Equations SWES	RE
Modular 8	WPER	Modular 8 SWER	RA
	WPMS WPEN	SWMS SWEN	BE
	WPMN	SWMN	TR
	WPMR	SWMR	CL

7% price increase effective January 1, 2009

Modular Tables

Half Round Tables

Description	Model Number	Dimensions			Wgt	List Prices		
		Wide	Deep	High		WoodPlus	Standard	Detailed
2" column legs	THR2448-COL	48	24	29	68	1008	1040	1224
	THR3060-COL	60	30	29	91	1215	1276	1593

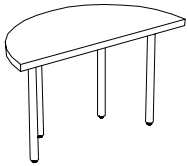

Please specify base finish as black or silver.

with casters	THR2448-COL-CA	48	24	29	68	1102	1134	1318
	THR3060-COL-CA	60	30	29	91	1308	1369	1686

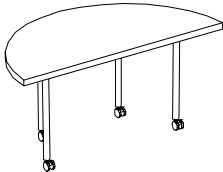

Please specify base finish as black or silver.

T on floor, center column	THR2448-COLT	48	24	29	65	1008	1040	1224
	THR3060-COLT	60	30	29	88	1215	1276	1593
	TC-THR					40	40	40



NOT freestanding; use in an assembly only. Please specify base finish as black or silver.

with casters	THR2448-COLT-CA	48	24	29	65	1102	1134	1318
	THR3060-COLT-CA	60	30	29	88	1308	1369	1686
	TC-THR					40	40	40



NOT freestanding; use in an assembly only. Please specify base finish as black or silver.

Quarter Round Tables - Not Freestanding

2" column leg	TQR2424-COL	24	24	29	27	598	643	884
	TQR3030-COL	30	30	29	38	774	819	1060
	TC-TQR					40	40	40



TQR-2424-COL

Must be ordered with Table Connectors Please specify base finish as black or silver.

with caster	TQR2424-COL-CA	24	24	29	27	622	667	908
	TQR3030-COL-CA	30	30	29	38	797	842	1083
	TC-TQR					40	40	40



TQR-2424-COL-CA

Must be ordered with Table Connectors Please specify base finish as black or silver.

Notes:

- Modular tables are shipped RTA (ready to assemble)

Options

Options are built-in at factory

Grommets

INLAY

-available ONLY with Detailed edge

INP Black 3mm (1/8") Inlay:
Modular Rectangular tops
Modular Shaped tops

INB Brushed Brass 3mm Inlay or
INC Satin Chrome 3mm Inlay:
Modular Rectangular tops
Modular Shaped tops

Accessories

Order separately

TC Table Connectors are available for Modular Tables.

See end of this section for pricing and details.

7% price increase effective January 1, 2009

Modular Tables

Kidney Tables with casters

Description	Model Number	Dimensions			Wgt	List Prices		
		Wide	Deep	High		Wood Edges		
						WoodPlus	Standard	Detailed
inverted 'T' legs with casters	TK2436-TLEG-CA	36	24	29	52	999	1044	1285
	TK2436-MH-TLEG-CA	36	24	26	52	999	1044	1285

Please specify base finish as black or silver.
MH model is 26" high overall and will fit below a worktop.

2" column legs with casters	TK3042-COL-CA	42	30	29	72	1060	1105	1346
	TK3042-MH-COL-CA	42	30	26	72	1060	1105	1346

Please specify base finish as black or silver.
MH model is 26" high overall and will fit below a worktop.

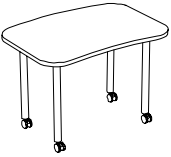

Trapezoid Tables

2" column leg	TRAP2448-COL	48	24	29	68	1008	1055	1382
	TRAP3060-COL	60	30	29	91	1215	1262	1600

Please specify base finish as black or silver.

with caster	TRAP2448-COL-CA	48	24	29	68	1102	1149	1476
	TRAP3060-COL-CA	60	30	29	91	1308	1355	1693

Please specify base finish as black or silver.

inverted 'T' legs	TRAP2448-TLEG	48	24	29	62	1008	1055	1382
	TRAP3060-TLEG	60	30	29	85	1215	1262	1600

Please specify base finish as black or silver.

with casters	TRAP2448-TLEG-CA	48	24	29	62	1102	1149	1476
	TRAP3060-TLEG-CA	60	30	29	85	1308	1355	1693

Please specify base finish as black or silver.

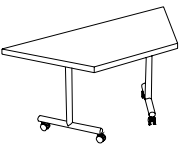
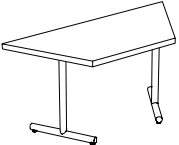
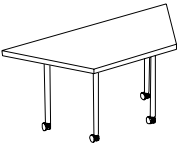
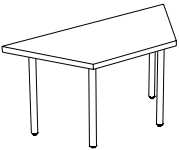

Edge Options Information

Modular tables are available with the following edge options:

- WoodPlus 3 mm PVC edge Laminate Table Tops only
- Standard 3 mm Wood Edge
- Detailed 3/8" Wood Edge

	WoodPlus 3 mm PVC	Standard Wood	Detailed Wood
	Equations	Equations	
	WPES	SWES	RE
Modular 8	WPER	SWER	RA
	WPMS	SWMS	BE
	WPEN	SWEN	TR
	WPMN	SWMN	CL
	WPMR	SWMR	

7% price increase effective January 1, 2009

Modular Tables

Square Tables

Description	Model Number	Dimensions			Wgt	List Prices		
		Wide	Deep	High		Wood Edges		
						WoodPlus	Standard	Detailed
Radius cube	TS4242-RC	42	42	29	61	1199	1270	1340
	TS4848-RC	48	48	29	80	1250	1321	1391

Please specify base finish as black or silver.

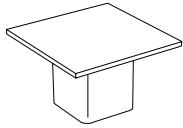

TS4848-RC



TS4848-COLX

X on floor, center column	TS3030-COLX	30	30	29	52	783	834	885
	TS3636-COLX	36	36	29	66	832	883	934
	TS4242-COLX	42	42	29	88	921	992	1062
	TS4848-COLX	48	48	29	110	994	1065	1135

Please specify base finish as black or silver.

Rectangular Tables - 24" deep

2" column leg	TT2436-COL	36	24	29	58	683	730	1046
	TT2442-COL	42	24	29	63	686	733	1060
	TT2448-COL	48	24	29	68	686	733	1060
	TT2454-COL	54	24	29	73	796	843	1181
	TT2460-COL	60	24	29	78	796	843	1192

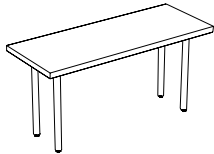

with caster	TT2436-COL-CA	36	24	29	58	776	823	1139
	TT2442-COL-CA	42	24	29	63	780	827	1154
	TT2448-COL-CA	48	24	29	68	780	827	1154
	TT2454-COL-CA	54	24	29	73	889	936	1274
	TT2460-COL-CA	60	24	29	78	889	936	1285

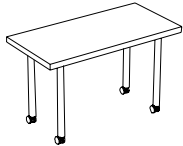

inverted 'T' legs	TT2436-TLEG	36	24	29	52	683	730	1046
	TT2442-TLEG	42	24	29	57	686	733	1060
	TT2448-TLEG	48	24	29	62	686	733	1060
	TT2454-TLEG	54	24	29	67	796	843	1181
	TT2460-TLEG	60	24	29	72	796	843	1192
	TT2472-TLEG	72	24	29	82	874	921	1270

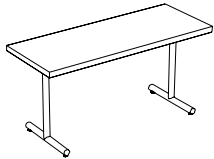

with casters	TT2436-TLEG-CA	36	24	29	52	776	823	1139
	TT2442-TLEG-CA	42	24	29	57	780	827	1154
	TT2448-TLEG-CA	48	24	29	62	780	827	1154
	TT2454-TLEG-CA	54	24	29	67	889	936	1274
	TT2460-TLEG-CA	60	24	29	72	889	936	1285

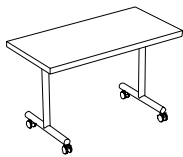

Please specify base finish as black or silver.

Notes:

- Modular tables are shipped RTA (ready to assemble)

Options

Options are built-in at factory

Grommets

INLAY

-available ONLY with Detailed edge

INP Black 3mm (1/8") Inlay:
Modular Rectangular tops
Modular Shaped tops

INB Brushed Brass 3mm Inlay or
INC Satin Chrome 3mm Inlay:
Modular Rectangular tops
Modular Shaped tops

Accessories

Order separately

TC Table Connectors are available for Modular Tables.

See end of this section for pricing and details.

7% price increase effective January 1, 2009

Modular Tables

Rectangular Tables - 30" deep

Description	Model Number	Dimensions			Wgt	List Prices		
		Wide	Deep	High		WoodPlus	Standard	Detailed
2" column leg	TT3036-COL	36	30	29	66	769	816	1132
	TT3042-COL	42	30	29	72	797	844	1171
	TT3048-COL	48	30	29	78	816	863	1190
	TT3054-COL	54	30	29	84	839	886	1224
	TT3060-COL	60	30	29	91	861	908	1246
with caster	TT3036-COL-CA	36	30	29	66	862	909	1225
	TT3042-COL-CA	42	30	29	72	890	937	1264
	TT3048-COL-CA	48	30	29	78	909	956	1283
	TT3054-COL-CA	54	30	29	84	932	979	1317
	TT3060-COL-CA	60	30	29	91	955	1002	1340
inverted 'T' legs	TT3036-TLEG	36	30	29	60	769	816	1132
	TT3042-TLEG	42	30	29	66	797	844	1171
	TT3048-TLEG	48	30	29	72	816	863	1190
	TT3054-TLEG	54	30	29	78	839	886	1224
	TT3060-TLEG	60	30	29	85	861	908	1246
	TT3072-TLEG	72	30	29	97	930	977	1326
with casters	TT3036-TLEG-CA	36	30	29	60	862	909	1225
	TT3042-TLEG-CA	42	30	29	66	890	937	1264
	TT3048-TLEG-CA	48	30	29	72	909	956	1283
	TT3054-TLEG-CA	54	30	29	78	932	979	1317
	TT3060-TLEG-CA	60	30	29	85	955	1002	1340

Please specify base finish as black or silver.

Rectangular Tables - 36" deep

inverted 'T' legs	TT3642-TLEG	42	36	29	77	887	934	1261
	TT3648-TLEG	48	36	29	84	926	973	1300
	TT3660-TLEG	60	36	29	99	943	990	1328
	TT3672-TLEG	72	36	29	114	984	1031	1380

Please specify base finish as black or silver.

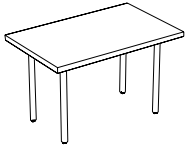

TT3048-COL

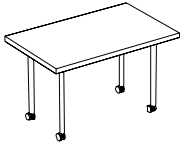

TT3048-COL-CA

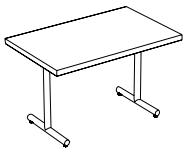

TT3048-TLEG

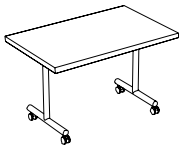

TT3048-TLEG-CA

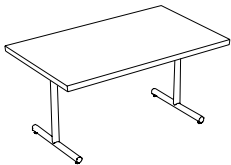

TT3660-TLEG

Edge Options Information

Modular tables are available with the following edge options:

- WoodPlus 3 mm PVC edge Laminate Table Tops only
- Standard 3 mm Wood Edge
- Detailed 3/8" Wood Edge

	WoodPlus 3 mm PVC	Standard Wood	Detailed Wood
	Equations	Equations	
	WPES	SWES	RE
Modular 8	WPER	SWER	RA
	WPMS	SWMS	BE
	WPMN	SWMN	TR
	WPMR	SWMR	CL

7% price increase effective January 1, 2009

Modular Tables

Rectangular Tables - 42" deep

Description	Model Number	Dimensions			Wgt	List Prices		
		Wide	Deep	High		Wood Edges		
					WoodPlus	Standard	Detailed	
double column	TT4248-TLEG2	48	42	29	116	1050	1097	1424
inverted ' T' leg	TT4260-TLEG2	60	42	29	134	1088	1135	1473
	TT4272-TLEG2	72	42	29	151	1137	1184	1533

Please specify base finish as black or silver.

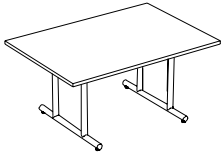

TT4260-TLEG2

Rectangular Tables - 48" deep

double column	TT4860-TLEG2	60	48	29	146	1184	1348	1516
inverted ' T' leg	TT4872-TLEG2	72	48	29	166	1238	1402	1570

Please specify base finish as black or silver.

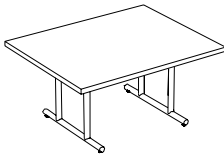

TT4860-TLEG2

Training Tables with C-Leg Base

Oval C leg, 24" deep	TT2448-CLEG-WM	48	24	29	62	1053	1100	1427
	TT2460-CLEG-WM	60	24	29	72	1207	1254	1603
	TT2472-CLEG-WM	72	24	29	82	1284	1331	1680

Includes black metal modesty panel with built in wiremanager. Base finish is Black powder coat.

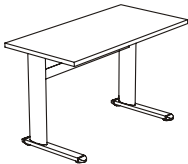

with casters	TT2448-CLEG-WM-CA	48	24	29	62	1131	1178	1505
	TT2460-CLEG-WM-CA	60	24	29	72	1284	1331	1680
	TT2472-CLEG-WM-CA	72	24	29	62	1361	1408	1757

Includes black metal modesty panel with built in wiremanager. Base finish is Black powder coat.

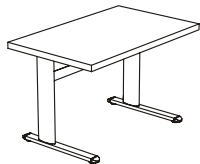

Oval C leg, 30" deep	TT3048-CLEG-WM	48	30	29	72	1228	1275	1602
	TT3060-CLEG-WM	60	30	29	85	1225	1272	1621
	TT3072-CLEG-WM	72	30	29	97	1308	1355	1704

Includes black metal modesty panel with built in wiremanager. Base finish is Black powder coat.

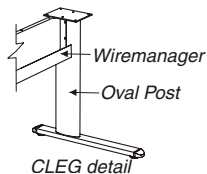

CLEG detail

with casters	TT3048-CLEG-WM-CA	48	30	29	72	1305	1352	1679
	TT3060-CLEG-WM-CA	60	30	29	85	1303	1350	1699
	TT3072-CLEG-WM-CA	72	30	29	97	1384	1431	1780

Includes black metal modesty panel with built in wiremanager. Base finish is Black powder coat.

Option	WoodPlus modesty panel is available with MJT	151	151	151
---------------	--	------------	-----	-----

Notes:

- Modular tables are shipped RTA (ready to assemble)

Options

Options are built-in at factory

Grommets

INLAY

-available ONLY with Detailed edge

INP Black 3mm (1/8") Inlay:
Modular Rectangular tops
Modular Shaped tops

INB Brushed Brass 3mm Inlay or
INC Satin Chrome 3mm Inlay:
Modular Rectangular tops
Modular Shaped tops

Accessories

Order separately

TC Table Connectors are available for Modular Tables.

See end of this section for pricing and details.

7% price increase effective January 1, 2009

Modular Table

Mobile Utility Table

Description	Model Number	Dimensions			Wgt	List Prices		
		Wide	Deep	High		Wood Edges		
						WoodPlus	Standard	Detailed
with Casters	MUT-2419-CA	19	24	0	35	907	956	1141

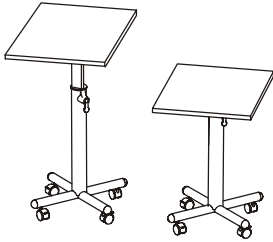

Slide table, casters available

Description	Model Number	Dimensions			Wgt	WP	WP2
		Wide	Deep	High			
with levelers	SLIDE-3260-EC0	32	60	29	85	1688	1601



with one set of casters	SLIDE-3260-EC2 Casters are locking.	32	60	29	85	1764	1677
-------------------------	--	----	----	----	----	-------------	------



with two sets of casters	SLIDE-3260-EC4 Casters are locking.	32	60	29	85	1841	1746
--------------------------	--	----	----	----	----	-------------	------

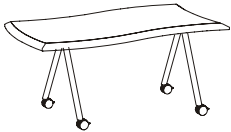
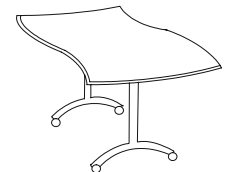
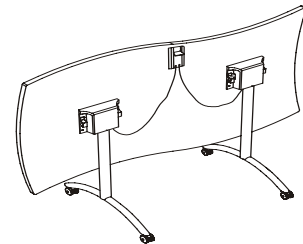
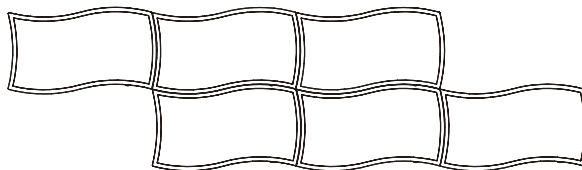
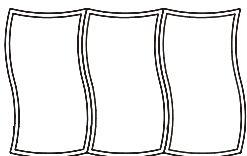
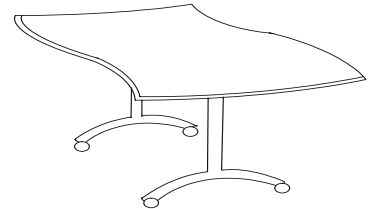
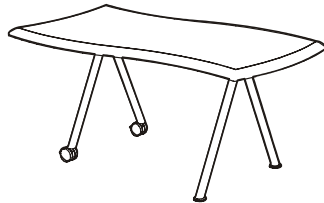
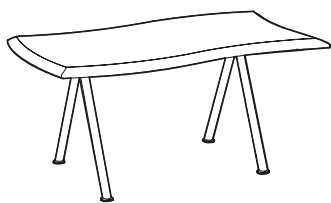

Table - flip top, casters, single release handle	SLIDE-FLIP-3260-ARCHT-CA Casters are locking.	32	60	29	85	2090	2047
--	--	----	----	----	----	-------------	------



Slide tables may be self-locked together and easily re-configured



7% price increase effective January 1, 2009

Modular Tables

Modular Table Inlay Options

Description Model Number List Price

Black INP Inlay with RE edge

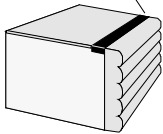

Black Inlay	CMR-INLAY-RECT-MOD TABLE-BLACK	275
	CMR-INLAY-SHAPE-MOD TABLE-BLACK	520

These inlay prices are for the CONFERENCE MODULAR tables and the MODULAR TABLES only. Price is per table top.

Brushed Brass INB Inlay with RE edge

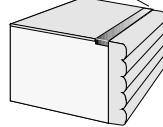

Brushed Brass Inlay	CMR-INLAY-RECT-MOD TABLE-BRASS	413
	CMR-INLAY-SHAPE-MOD TABLE-BRASS	826

These inlay prices are for the CONFERENCE MODULAR tables and the MODULAR TABLES only. Price is per table top.

Satin Chrome INC Inlay with RE edge

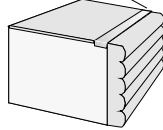

Satin Chrome Inlay	CMR-INLAY-RECT-MOD TABLE-CHROME	413
	CMR-INLAY-SHAPE-MOD TABLE-CHROME	826

These inlay prices are for the CONFERENCE MODULAR tables and the MODULAR TABLES only. Price is per table top.

Grommet Options

Description Model Number Dimensions Wgt List Price

Wide Deep High

Grommets	GR	4.25	2.75			48
-----------------	----	------	------	--	--	-----------

GR = Grommet with cover. Opening: 1-3/4 x 3-1/2. Specify location of grommets, see following page.



Inserts for above grommets	DVR-INSERT	4.25	2.75	5	1	66
	PDC-INSERT	4.25	2.75	5	1	138
	WHT-INSERT	4.25	2.75	5	1	148

WHT = Work Height Triplex. 6' cord.

WHT pull up size: 2 x 3.5 x 5-1/8 high when extended.

DVR = Data / Voice Receptacle.

DVR pull up size: 2 x 3.5 x 5-1/8 high when extended. DVR is a work surface Pop-up that accepts various receptacle plates to be supplied by your electrical contractor or installer.

DVR does NOT INCLUDE any receptacles or receptacle plates.

PDC = Power / Data Combination.

PDC pull up size: 2 x 3.5 x 5-1/8 high when extended. PDC is a work surface pop-up that accepts a combination of Power, Data and Voice (telephone) outlets (up to 2 each).

PDC does NOT INCLUDE any receptacles or receptacle plates.

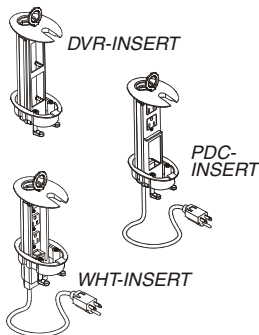

7% price increase effective January 1, 2009

Modular Tables

Grommet Options

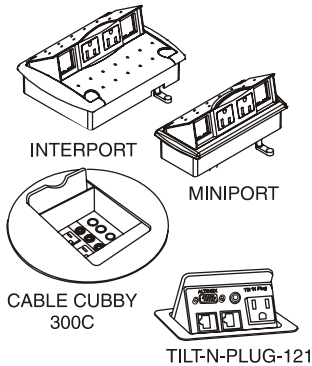

Description	Model Number	Dimensions			Wgt	List Price
		Wide	Deep	High		
Recessed electrical, data access	MINI PORT-PLUG-120	7	3	2	2	197
	MINI PORT-STARTER-72	7	3	2	2	440
	MINI PORT-ADDER-48	7	3	2	2	246
	MINI PORT-ADDER-72	7	3	2	2	246
	MINI PORT-ADDER-120	7	3	2	2	246
	INTERPORT-PLUG-120	7	5	2	2	236
	INTERPORT-STARTER-72	7	5	2	2	470
	INTERPORT-ADDER-48	7	5	2	2	262
	INTERPORT-ADDER-72	7	5	2	2	262
	INTERPORT-ADDER-120	7	5	2	2	262
	CABLE-CUBBY-300C	6	6	1	2	1322
	TILT-N-PLUG-121	5	5	0	1	1322
TILT-N-PLUG-121-UL	5	5	0	1	1502	

MINI PORT-PLUG and INTERPORT-PLUG both house two electrical outlets with 6' cord and two data locations. The receptacle plates for most connectors are included. Electrical outlets with plug ends.

MINI PORT and INTERPORT may be setup 'daisy-chained' and hardwired to the building power supply, please contact Customer Service with your requirements.

CABLE-CUBBY-300C has a round faceplate and houses two AC outlets, one video and two audio jacks, up to three sizes of pass through cable openings (using AAP Architectural Adapter Plates). Electrical outlets with plug ends.

TILT-N-PLUG-121 houses single input plate with Computer Video (15-pin HD), Computer Audio (Stereo Mini), Modem (RJ11), and Network (RJ45) input connections. One electrical outlet with plug end. **Data connectors are NOT included.**

TILT-N-PLUG-121-UL is a UL labeled product with the same configuration as the TILT-N-PLUG-121

Modular Table Connectors

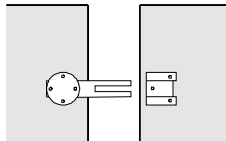

Top Connector

Top Connectors	Model Number	Wgt	List Price
TC-THR		4	40
TC-TQR		2	40
TC-TRAP		4	40
TC-TS		6	60
TC-TT		6	79

To order add -TC to the end of the model number, e.g. TT-2448-Col-TC.

NOTE: TC connectors are for use with small Modular Tables; NOT for use with ACT or Conference tables.

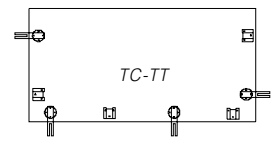
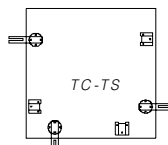
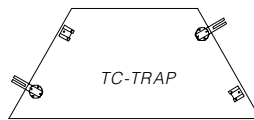
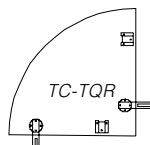
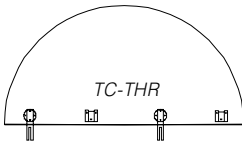

Radius Corners added to a Table top

Description	Model Number	Dimensions			Wgt	List Price
		Wide	Deep	High		
Add Radius Corners	Top-C3R-WPE					412
	Top-C3R-STD					412
	Top-C3R-DET					594

3 radius on the inside of the edge. To order add ' -C3R' to the end of the table model number. Rectangular top with Radius corners uses the the Shaped top INLAY upcharge.

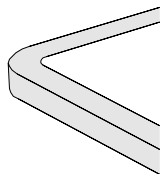

7% price increase effective January 1, 2009

Modular Table Assemblies

Overview - Modular Table Assemblies

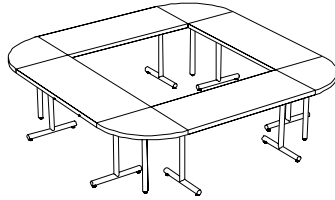

Assembly Sizes include:
9' x 9', 9' x 14', 10' x 10' and 10' x 15'

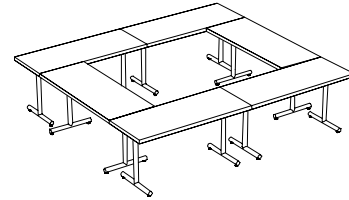

Assembly sizes include:
9' x 10', 14' x 10', 10' x 10' and 10' x 15'

Round Corner 'O' shape - Modular Table Assembly, see Pg 112

Square Corner 'O' shape - Modular Table Assembly, see Pg 112

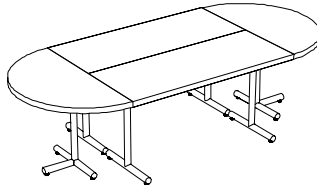

Assembly sizes include:
4' x 9', 4' x 14', 5' x 10' and 5' x 15'

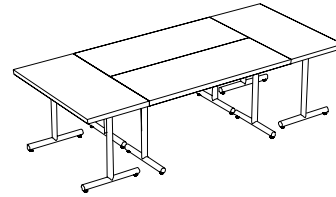

Assembly sizes include:
4' x 9', 4' x 14', 5' x 10' and 5' x 15'

Racetrack shape - Modular Table Assembly, see Pg 113

Rectangular shape - Modular Table Assembly, see Pg 113

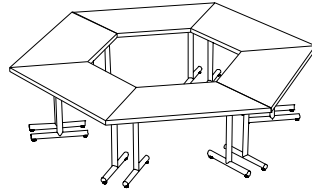

Assembly sizes include:
7' x 8' and 9' x 10'

Trapezoid Hexagonal shape - Modular Table Assembly, see Pg 113

7% price increase effective January 1, 2009

Modular Table Assemblies

Round Corner 'O' shape - Modular Table Assembly

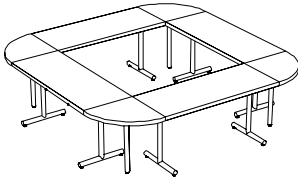

TMOR-909-TLEG

Description	Model Number	Dimensions			Wgt	List Prices		
		Wide	Deep	High		Wood Edges		
						WoodPlus	Standard	Detailed
24" deep tops	TMOR-909-TLEG	108	108	29	428	6052	6420	8780
	TMOR-914-TLEG	108	168	29	584	7802	8264	11322
with casters	TMOR-909-TLEG-CA	108	108	29	428	6520	6888	9248
	TMOR-914-TLEG-CA	108	168	29	584	8456	8918	11976
30" deep tops	TMOR-1010-TLEG	120	120	29	524	7016	7384	9700
	TMOR-1015-TLEG	120	180	29	706	8896	9358	12350
with casters	TMOR-1010-TLEG-CA	120	120	29	524	7484	7852	10168
	TMOR-1015-TLEG-CA	120	180	29	706	9552	10014	13006

Square Corner 'O' shape - Modular Table Assembly

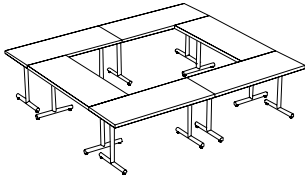

TMOS-910-TLEG

24" deep tops	TMOS-910-TLEG	108	120	29	468	5250	5532	7626
	TMOS-1410-TLEG	168	120	29	624	7000	7376	10168
with casters	TMOS-910-TLEG-CA	108	120	29	468	5808	6090	8184
	TMOS-1410-TLEG-CA	168	120	29	624	7744	8120	10912
30" deep tops	TMOS-1010-TLEG	120	120	29	546	5640	5922	7950
	TMOS-1015-TLEG	120	180	29	728	7520	7896	10600
with casters	TMOS-1010-TLEG-CA	120	120	29	546	6204	6486	8514
	TMOS-1015-TLEG-CA	120	180	29	728	8272	8648	11352

Edge Options Information

Modular tables are available with the following edge options:

- WoodPlus 3 mm PVC edge
- Standard 3 mm Wood Edge
- Detailed 3/8" Wood Edge

	WoodPlus 3 mm PVC	Standard Wood	Detailed Wood
Equations	WPES	SWES	RE
Modular 8	WPER	SWER	RA
	WPMS	SWMS	BE
	WPEN	SWEN	TR
	WPMN	SWMN	
	WPMR	SWMR	CL

7% price increase effective January 1, 2009

Modular Table Assemblies

Racetrack shape - Modular Table Assembly



Description	Model Number	Dimensions			Wgt	List Prices		
		Wide	Deep	High		Wood Edges		
						WoodPlus	Standard	Detailed
24" deep tops	TMR-409-TLEG	48	108	29	294	3846	4004	5070
	TMR-414-TLEG	48	168	29	450	5596	5848	7612
with casters	TMR-409-TLEG-CA	48	108	29	294	4220	4378	5444
	TMR-414-TLEG-CA	48	168	29	450	6156	6408	8172
30" deep tops	TMR-510-TLEG	60	120	29	366	4390	4606	5916
	TMR-515-TLEG	60	180	29	548	6270	6580	8566
with casters	TMR-510-TLEG-CA	60	120	29	366	4764	4980	6290
	TMR-515-TLEG-CA	60	180	29	548	6832	7142	9128

Rectangular shape - Modular Table Assembly

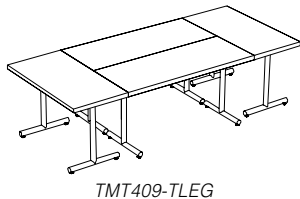

24" deep tops	TMT-409-TLEG	48	108	29	312	3500	3688	5084
	TMT-414-TLEG	48	168	29	468	5250	5532	7626
with casters	TMT-409-TLEG-CA	48	108	29	312	3872	4060	5456
	TMT-414-TLEG-CA	48	168	29	468	5808	6090	8184
30" deep tops	TMT-510-TLEG	60	120	29	364	3760	3948	5300
	TMT-515-TLEG	60	180	29	546	5640	5922	7950
with casters	TMT-510-TLEG-CA	60	120	29	364	4136	4324	5676
	TMT-515-TLEG-CA	60	180	29	546	6204	6486	8514

Trapezoid Hexagonal shape - Modular Table Assembly

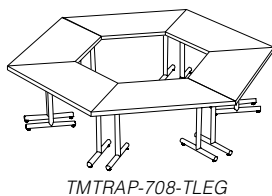

24" deep tops	TMTRAP-708-TLEG	84	96	29	396	6288	6570	8532
with casters	TMTRAP-708-TLEG-CA	84	96	29	396	6852	7134	9096
30" deep tops	TMTRAP-910-TLEG	108	120	29	534	7530	7812	9840
with casters	TMTRAP-910-TLEG-CA	108	120	29	534	8088	8370	10398

Notes:

- Modular tables are shipped RTA (ready to assemble)

Options

Options are built-in at factory

Single and Double Grommets see page at end of this section

INLAY -available ONLY with Detailed or Larger edge.

See Modular Table Assembly Options for Inlay pricing per assembly.

Accessories







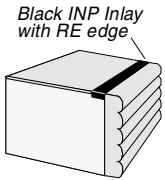
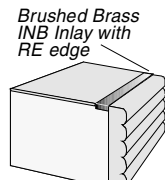
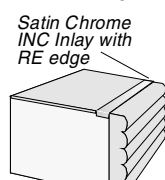

Order separately

TC Table Connectors are included with Modular Table Assemblies.

7% price increase effective January 1, 2009

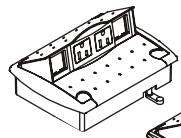
Modular Table Assemblies

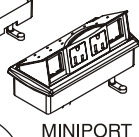
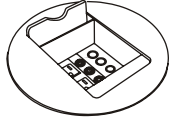
Modular Table Assembly Options

Description	Model Number	Dimensions			Wgt	List Price	
		Wide	Deep	High			
 <p>Black INP Inlay with RE edge</p>	Black Inlay	INLAY-TMOR-BLACK				2923	
		INLAY-TMOS-BLACK				2273	
		INLAY-TMR-BLACK				1624	
		INLAY-TMT-BLACK				1624	
		INLAY-TMTRAP-BLACK				1949	
 <p>Brushed Brass INB Inlay with RE edge</p>	Brushed Brass Inlay	INLAY-TMOR-BRASS				5848	
		INLAY-TMOS-BRASS				4548	
		INLAY-TMR-BRASS				3248	
		INLAY-TMT-BRASS				3248	
		INLAY-TMTRAP-BRASS				3898	
 <p>Satin Chrome INC Inlay with RE edge</p>	Satin Chrome Inlay	INLAY-TMOR-CHROME				5848	
		INLAY-TMOS-CHROME				4548	
		INLAY-TMR-CHROME				3248	
		INLAY-TMT-CHROME				3248	
		INLAY-TMTRAP-CHROME				3898	
	Grommets	GR	4.25	2.75		48	
		GR = Grommet with cover. Opening: 2 x 3.5 Specify location of grommets, see following page.					
 <p>DVR-INSERT</p>  <p>PDC-INSERT</p>  <p>WHT-INSERT</p>	Inserts for above grommets	DVR-INSERT	4.25	2.75	5	1	66
		PDC-INSERT	4.25	2.75	5	1	138
		WHT-INSERT	4.25	2.75	5	1	148
		WHT = Work Height Triplex. 6' cord. WHT pull up size: 2 x 3.5 x 5-1/8 high when extended. DVR = Data / Voice Receptacle. DVR pull up size: 2 x 3.5 x 5-1/8 high when extended. DVR is a work surface Pop-up that accepts various receptacle plates to be supplied by your electrical contractor or installer. DVR does NOT INCLUDE any receptacles or receptacle plates. PDC = Power / Data Combination. PDC pull up size: 2 x 3.5 x 5-1/8 high when extended. PDC is a work surface pop-up that accepts a combination of Power, Data and Voice (telephone) outlets (up to 2 each). PDC does NOT INCLUDE any receptacles or receptacle plates.					
 <p>MINIPLUG</p>  <p>INTERPORT</p>  <p>MINIPLUG</p>  <p>CABLE CUBBY 300C</p>  <p>TILT-N-PLUG-121</p>	Recessed electrical, data access	MINIPLUG-PLUG-120	7	3	2	2	197
		MINIPLUG-STARTER-72	7	3	2	2	440
		MINIPLUG-ADDER-48	7	3	2	2	246
		MINIPLUG-ADDER-72	7	3	2	2	246
		MINIPLUG-ADDER-120	7	3	2	2	246
		INTERPORT-PLUG-120	7	5	2	2	236
		INTERPORT-STARTER-72	7	5	2	2	470
		INTERPORT-ADDER-48	7	5	2	2	262
		INTERPORT-ADDER-72	7	5	2	2	262
		INTERPORT-ADDER-120	7	5	2	2	262
		CABLE-CUBBY-300C	6	6	0	1	1322
		TILT-N-PLUG-121	5	5	0	1	1322
		TILT-N-PLUG-121-UL	5	5	0	1	1502

MINIPLUG-PLUG and INTERPORT-PLUG both house two electrical outlets with 6' cord and two data locations. The receptacle plates for most connectors are included. Electrical outlets with plug ends.

MINIPLUG and INTERPORT may be setup 'daisy-chained' and hardwired to the building power supply, please contact Customer Service with your requirements.

CABLE-CUBBY-300C has a round faceplate and houses two AC outlets, one video and two audio jacks, up to three sizes of pass through cable openings (using AAP Architectural Adapter Plates). Electrical outlets with plug ends.

TILT-N-PLUG-121 houses single input plate with Computer Video (15-pin HD), Computer Audio (Stereo Mini), Modem (RJ11), and Network (RJ45) input connections. One electrical outlet with plug end.

TILT-N-PLUG-121-UL is a UL labeled product with the same configuration as the TILT-N-PLUG-121.

Presentation Units

Overview - Presentation Units

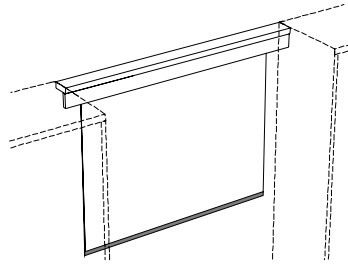

Projection Valance and Projection Screen, see Pg 115

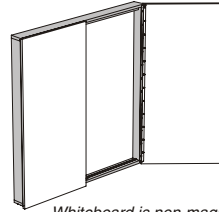

Whiteboard is non-magnetic
Door finish is the same on the both faces

Presentation Display Boards - Non-magnetic, see Pg 116

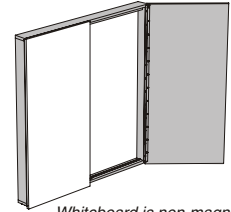

Whiteboard is non-magnetic
Inside of door is black and matches the case finish

Presentation Display Boards - Non-magnetic - WoodPlus2, see Pg 117

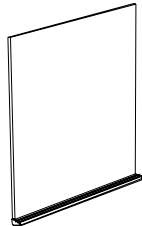

Marker Boards, see Pg 118

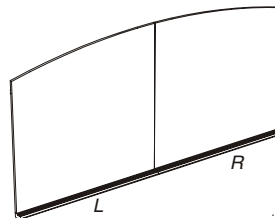

Marker Boards, see Pg 118

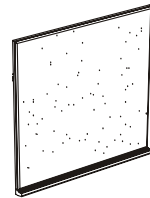

Marker Boards, see Pg 118

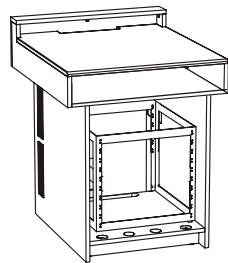

Multimedia lecterns with flat tops, see Pg 120

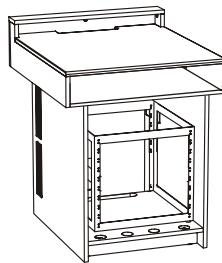

Multimedia lecterns with flat tops, see Pg 120

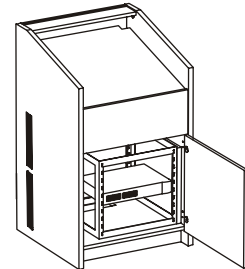

Multimedia lecterns with sloped tops, see Pg 122

Projection Valance and Projection Screen

Description	Model Number	Dimensions			Wgt	List Prices		
		Wide	Deep	High		Wood Edges		
						WoodPlus	Standard	Detailed
Valance	PSV-60	60	5	6	30	545	594	792
	PSV-72	72	5	6	36	593	642	840
with Projection Screen	PSV-60-PS	60	5	6	53	879	928	1126
	PSV-72-PS	72	5	6	61	927	976	1174

On the PSV-60-PS, the projection screen is 42" wide and 50" tall
On the PSV-72-PS, the projection screen is 60" wide and 50" tall.

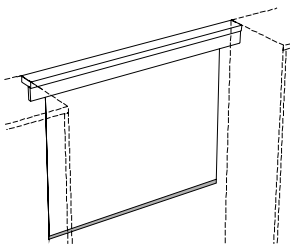

PSV-72-PS

7% price increase effective January 1, 2009

Presentation Units

Presentation Display Boards - Non-magnetic

Description	Model Number	Dimensions			Wgt	List Price WPE edge
		Wide	Deep	High		
WoodPlus Edge	PDB-4848-WPE	48	4	48	140	1188
Doors	PDB-4872-WPE	72	4	48	175	1614
	STD WOOD EDGE	optional 3mm hardwood edge on PDB doors, add				186

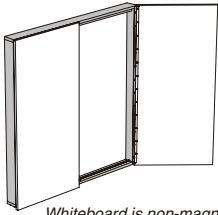

Whiteboard is non-magnetic
Door finish is the same
on the both faces

Case is standard in Black laminate; doors are WoodPlus with Woodplus edge.
Includes non-magnetic whiteboard and a Dry Erase marker and eraser.
Wall mount bracket included.

Presentation Display Boards - Magnetic

WoodPlus Edge	PDBM-4848-WPE	48	4	48	140	1339
Doors	PDBM-4872-WPE	72	4	48	175	1836
	STD WOOD EDGE	optional 3mm hardwood edge on PDB doors, add				186

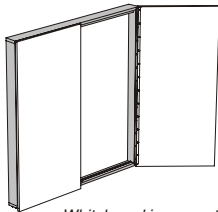

Whiteboard is magnetic
Door finish is the same
on the both faces

Case is standard in Black laminate; doors are WoodPlus with Woodplus edge.
Includes magnetic whiteboard and a Dry Erase marker and eraser.
Wall mount bracket included.

Presentation Display Board Accessories

Projection	PDB-PROJECTION-SCREEN-42	42	50	18	251
Screen	PDB-PROJECTION-SCREEN-60	60	50	24	251

Projection Screen includes Valance to match case.
PDB-PROJECTION-SCREEN-42 is 42" wide and 50" high, use on 48" wide PDB or PDMB.
PDB-PROJECTION-SCREEN-60 is 60" wide and 50" high, use on 72" wide PDB or PDMB.

Laminate Trim Kit	PDB-TRIM-KIT				58
--------------------------	--------------	--	--	--	-----------

Trim kit includes two side pieces that match doors.

Door fabric panels	PD-FP-1	fabric tackboard for one door			156
	PD-FP-2	fabric tackboard for both doors			245

Pricing shown is for Magna Design fabric grades A, B, or C

Flip charts	FLIP-CHART-1	Flip chart mounted on one door			46
--------------------	--------------	--------------------------------	--	--	-----------

Marker board for doors	PDB-MB-DOOR-PANEL-1				147
	PDB-MB-DOOR-PANEL-2				245

Option for Presentation Display Boards

Door Locks	PDB-Door-Lock				87
-------------------	---------------	--	--	--	-----------

Edge Options Information

Presentation Units are available with the following edge options:

- WoodPlus 3 mm PVC edge on sides and top
- MB bottom wood rail is finished to match the WoodPlus edge finish on the sides and top.

Marker Board Edge finishes:

- WP-04 Solar Oak
- WP-23Cordovan
- WP-31Medium Cherry
- WP-33Blossom Cherry
- WP-41Natural Maple
- WP-45Anigre (color match only)
- WP-61Pear
- WP-71Dark Cherry
- WP-73Cognac
- WP-75Chestnut
- WP-81Fusion Maple (color match only)
- CP-76Espresso
- CP-88Black
- CP-98Slate

WoodPlus
Edge



7% price increase effective January 1, 2009

Presentation Units

Presentation Display Boards - Non-magnetic - WoodPlus2

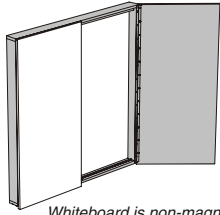

Whiteboard is non-magnetic
Inside of door is black and matches the case finish

Description	Model Number	Dimensions			Wgt	List Price WPE edge
		Wide	Deep	High		
	PDB-TECH-4846-WP2	46	4	48	140	1665

Projection Screen	PDB-PROJECTION-SCREEN-42	42		50	18	251
	Projection Screen and Valance accessory for PDB.					
Trim Kit	PDB-TRIM KIT	Matches door finish				58
	Trim kit includes two side pieces that match doors.					
Fabric panel	PD-FP-1	fabric tackboard for one door				156
	PD-FP-2	fabric tackboard for both doors				245
	Pricing shown is for Magna Design fabric grades A, B, or C					
Flip Chart	FLIP-CHART-1	Flip chart mounted on one door				46

Mobile White Board

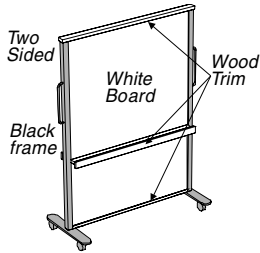

MWB-4260

Mobile White Board	MWB-3660	36	4	60	120	1707
	MWB-4260	42	4	60	134	1889

Specify wood trim (top cap and tray) finish, choose from any table top wood edge finish.
Frame finish is Black.
White board is NON magnetic.

Display Rails, Wall Mounted

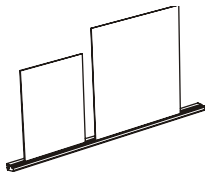

Display Rail profile

Wall Mounted	DRW-48	48	3	2	5	527
	DRW-60	60	3	2	7	563
	DRW-72	72	3	2	9	599

Specify wood finish, choose from any table top wood edge finish.

Notes:

Presentation Units are shipped assembled.

7% price increase effective January 1, 2009

Presentation Units

Marker Boards

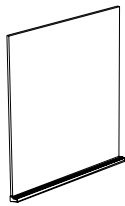

MB-4848

Description	Model Number	Dimensions			Wgt	List Price WPE edge
		Wide	Deep	High		
WoodPlus PVC	MB-2436-WPE	36	1.75	24	30	569
Edge,	MB-3636-WPE	36	1.75	36	45	659
Hardwood rail	MB-4242-WPE	42	1.75	42	74	662
	MB-4248-WPE	48	1.75	42	77	673
	MB-4848-WPE	48	1.75	48	80	673
	MB-4860-WPE	60	1.75	48	100	732
	MB-4872-WPE	72	1.75	48	120	833
	MB-4896-WPE	96	1.75	48	160	904
STD WOOD EDGE	optional 3mm hardwood edge on PDB doors, add					186

Non-magnetic white Marker Board; includes Marker pen and eraser.
Specify edge finish for the lower pen holder and edge trim on top and sides.

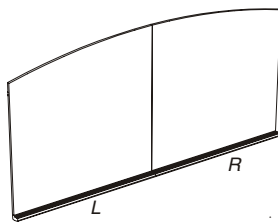

MB-ARCH-4848-L-WPE
MB-ARCH-4848-R-WPE

Archiving White Board,	MB-ARCH-4848-L-WPE	48	1.75	48	66	784
	MB-ARCH-4848-R-WPE	48	1.75	48	66	784
Woodplus	MB-ARCH-4860-L-WPE	60	1.75	48	80	843
edges,	MB-ARCH-4860-R-WPE	60	1.75	48	80	843
Hardwood rail	MB-ARCH-4872-L-WPE	72	1.75	48	96	944
	MB-ARCH-4872-R-WPE	72	1.75	48	96	944
STD WOOD EDGE	optional 3mm hardwood edge on PDB doors, add					186

Non-magnetic White Board, Arched Top, has hardwood rail to hold markers and eraser Marker pen and eraser included.
For 'full' arch please order one Left and one Right.
Specify edge finish for the lower pen holder and edge trim on top and sides..

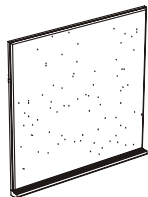

MB-FP-4848-WPE

Tackboards,	MB-FP-4242-WPE	42	1.75	42	63	747
WoodPlus edge,	MB-FP-4248-WPE	48	1.75	42	66	747
Hardwood rail	MB-FP-4848-WPE	48	1.75	48	66	747
	MB-FP-4860-WPE	60	1.75	48	80	802
	MB-FP-4872-WPE	72	1.75	48	96	907
STD WOOD EDGE	optional 3mm hardwood edge on PDB doors, add					186

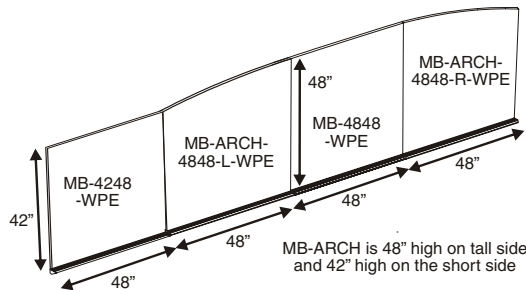

Edge Options Information

Presentation Units are available with the following edge options:

- WoodPlus 3 mm PVC edge on sides and top
- MB bottom wood rail is finished to match the WoodPlus edge finish on the sides and top.

Marker Board Edge finishes:

- WP-04 Solar Oak
- WP-23Cordovan
- WP-31Medium Cherry
- WP-33Blossom Cherry
- WP-41Natural Maple
- WP-45Anigre (color match only)
- WP-61Pear
- WP-71Dark Cherry
- WP-73Cognac
- WP-75Chestnut
- WP-81Fusion Maple (color match only)
- CP-76Espresso
- CP-88Black
- CP-98Slate



WoodPlus Edge



7% price increase effective January 1, 2009

Lecterns

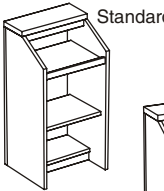
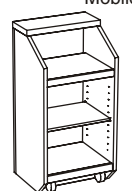
Lecterns

Description	Model Number	Dimensions			Wgt	List Prices			
		Wide	Deep	High		WoodPlus	Standard	Detailed	
 Standard  Mobile  Table top	Standard Lectern	CRL-STANDARD	24	21	48	120	1805	1852	2059
	Lecterns include a cord gap to allow optional Light or Electrical Strip cords to reach the floor.								
Mobile Lectern	CRL-MOBILE	24	21	48	126	1997	2044	2251	
Table Top Lectern	CRL-TABLE-TOP	24	21	18	44	983	1030	1237	

Lecterns - options and accessories

Grommets	GR	4.25	2.75		48	48	48	48
GR = Grommet with cover. Opening: 1-3/4" x 3-1/2". Specify location: Left or Right.								
Inserts for grommets	DVR-INSERT	4.25	2.75	5		66	66	66
	PDC-INSERT	4.25	2.75	5		138	138	138
	WHT-INSERT	4.25	2.75	5		148	148	148

WHT = Work Height Triplex. 6' cord with plug.

WHT pull up size: 2 x 3.5 x 5-1/8" high when extended.

DVR = Data / Voice Receptacle.

DVR pull up size: 2 x 3.5 x 5-1/8" high when extended. DVR is a work surface Pop-up that accepts various receptacle plates to be supplied by your electrical contractor or installer. **DVR does NOT INCLUDE any receptacles or receptacle plates.**

PDC = Power / Data Combination.

PDC pull up size: 2 x 3.5 x 5-1/8" high when extended. PDC is a work surface pop-up that accepts a combination of Power, Data and Voice (telephone) outlets (up to 2 each). **PDC does NOT INCLUDE any receptacles or receptacle plates.**

Power Strip	CRL-DATA-ELECTRICAL				3	125	125	125
Includes 6 grounded outlets, on/off switch and 6' cord with plug.								

CRL Light	CRL-LIGHT	9	2	1	3	256	256	256
Specially sized Halogen Light includes 6' cord with plug.								

Edge Options Information

Lecterns are available with the following edge options:

- WoodPlus 3 mm PVC edge
- . . . Standard 3 mm Wood Edge
- Detailed 3/8" Wood Edge

Notes:

Lecterns include a cord gap to allow optional Light or Electrical Strip cords to reach the floor.

WoodPlus 3 mm PVC	Standard Wood	Detailed Wood
Equations WPES	Equations SWES	RE
Modular 8 WPER	Modular 8 SWER	RA
WPMS	SWMS	BE
WPMN	SWMN	TR
WPMR	SWMR	CL

7% price increase effective January 1, 2009

Multimedia Lecterns

Multimedia lecterns with flat tops

Description	Model Number	Dimensions			Wgt	List Price
		Wide	Deep	High		
Adjustable shelf	CRL-MF-2830-38-SHELF	30	28	38	176	1866
	CRL-MF-3430-38-SHELF	30	34	38	188	1866

Includes adjustable shelf and finished panel on audience side

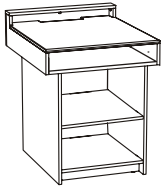

Equipment Rack	CRL-MF-2830-38-RACK	30	28	38	176	2775
	CRL-MF-3430-38-RACK	30	34	38	188	2775

Includes equipment rack, side and bottom vents and audience side door.

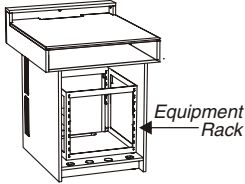

Option: Drop leaves	OPTION-DL	33	32		30	704
	OPTION-DLL	33	16		15	352
	OPTION-DLR	33	16		15	352

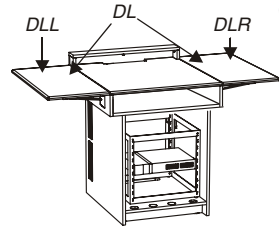

Add DL to model number for drop leaves on both sides, DLL for left side only, DLR for the right side only.
Shown on CRL-MF-3430-RACK model.

Option: User side door	OPTION-UD				27	254
-------------------------------	-----------	--	--	--	----	------------

Add UD to model number for user side door with touch latch.
Shown on CRL-MF-3430-SHELF model.

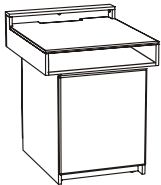

Option: Pullout keyboard tray	OPTION-MKT	12			15	119
--------------------------------------	------------	----	--	--	----	------------

Add MKT to model number for molded pullout keyboard tray.
Shown on CRL-MF-3430-RACK model.

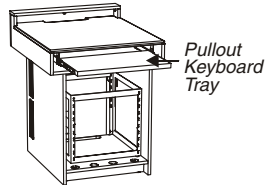

Option: Casters, Vents, Cutouts	OPTION-LECTERN-MM-CA					703
	OPTION-VENTS					175
	OPTION-CUTOUTS					117

Add CA to model number for four 2-1/2" casters, two locking. Shown on CRL-MF-3430-RACK model.
Add VENTS to SHELF model number for side and bottom vents. Side and bottom vents are included with the RACK model.
Add CUTOUT to model number for cutouts for other options such as microphones, etc. and provide a template for the required cutout. Price is for cutout only, does not include equipment.

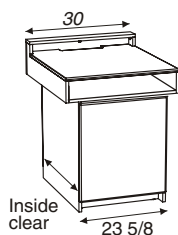
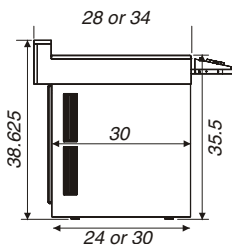
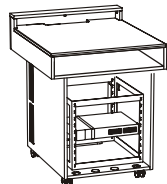

Inside Clear dimension
For 34" deep units the lower section has 30" clear on the inside front to back
For 28" deep units the lower section has 24" clear on the inside front to back

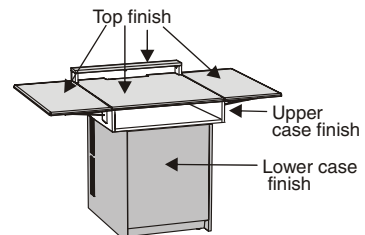

7% price increase effective January 1, 2009

Multimedia Lecterns

WP2 Multimedia lecterns with flat tops

Description	Model Number	Dimensions			Wgt	List Price
		Wide	Deep	High		
Adjustable shelf	CRL-MF-2830-38-SHELF-WP2	30	28	38	176	2140
	CRL-MF-3430-38-SHELF-WP2	30	34	38	188	2140

Includes adjustable shelf and finished panel on audience side.

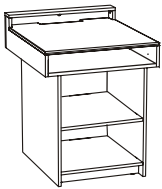

Equipment Rack	CRL-MF-2830-38-RACK-WP2	30	28	38	176	3048
Rack	CRL-MF-3430-38-RACK-WP2	30	34	38	188	3048

Includes equipment rack, side and bottom vents and audience side door.

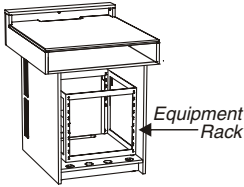

Option:	OPTION-DL-WP2	33	33		30	704
Drop leaves	OPTION-DLL-WP2	33	33		15	352
	OPTION-DLR-WP2	33	33		15	352

Add DL to model number for drop leaves on both sides, DLL for left side only, DLR for the right side only.

Shown on CRL-MF-3430-RACK model.

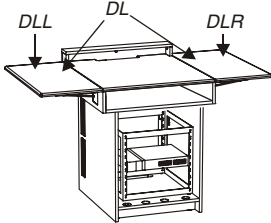

Option:	OPTION-UD-WP2				27	254
----------------	---------------	--	--	--	----	------------

User side door Add UD to model number for user side door with touch latch. Shown on CRL-MF-3430-SHELF model.



Option:	OPTION-MKT		12		15	119
----------------	------------	--	----	--	----	------------

Pullout keyboard tray Add MKT to model number for molded pullout keyboard tray. Shown on CRL-MF-3430-RACK-WP2 model.

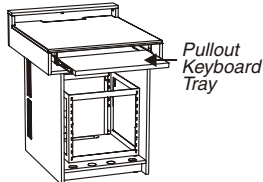

Option:	OPTION-LECTERN-MM-CA					703
----------------	----------------------	--	--	--	--	------------

Casters	OPTION-VENTS					175
----------------	--------------	--	--	--	--	------------

	OPTION-CUTOUTS					117
--	----------------	--	--	--	--	------------

Add CA to model number for four 2-1/2" casters, two locking. Shown on CRL-MF-3430-RACK model.

Add VENTS to model number for side and bottom vents. Shown on CRL-MF-3430-SHELF model.

Side and bottom vents are included with the RACK model.

Add CUTOUT to model number for cutouts for other options such as microphones, etc. and provide template for the required cutout. Price is for cutout only, does not include equipment.

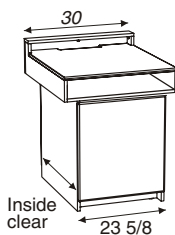
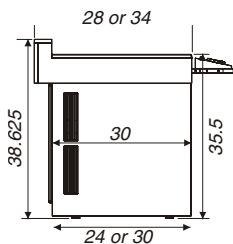

Inside Clear dimension
 For 34" deep units the lower section has 30" clear on the inside front to back
 For 28" deep units the lower section has 24" clear on the inside front to back

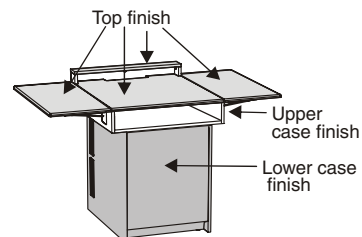

7% price increase effective January 1, 2009

Multimedia Lecterns

Multimedia lecterns with sloped tops

Description	Model Number	Dimensions			Wgt	List Price
		Wide	Deep	High		
Adjustable shelf	CRL-MS-2828-48-SHELF	28	28	48	168	2264
	CRL-MS-2842-48-SHELF	28	42	48	198	2668

Includes door(s) on user side, adjustable shelf and finished panel on audience side.

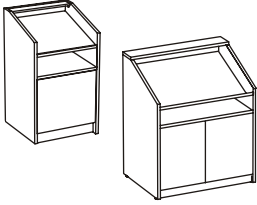

Equipment Rack	CRL-MS-2828-48-RACK	28	28	48	168	3267
	CRL-MS-2842-48-RACK	28	42	48	198	3733

Includes door(s) on user side, one equipment rack, side and bottom vents and audience side door(s).

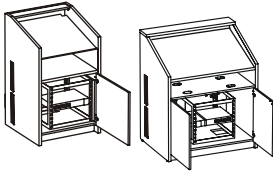

Option:	CRL-MS-TOP-CUTOUT					391
----------------	-------------------	--	--	--	--	------------

Top Cutout Add CUTOUT to model number for cutout in top along with monitor shelf. Shown on CRL-MS-2842-SHELF model.

Please provide clearance required for monitor.

Cannot be ordered with the KT Pullout Keyboard Tray option.

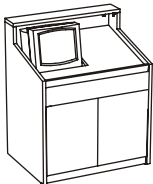

Option:	CRL-MS-KT	12			15	364
----------------	-----------	----	--	--	----	------------

Pullout keyboard tray Add KT to model number for pullout keyboard tray. Shown on CRL-MS-2842-SHELF model. Cannot be ordered with the TOP CUTOUT option

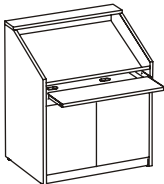

Option:	OPTION-LECTERN-MM-CA					703
----------------	----------------------	--	--	--	--	------------

Casters Add CA to model number for four 2-1/2" casters, two locking. Shown on CRL-MS-2828-SHELF model.

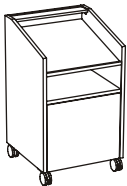

Option:	OPTION-VENTS					175
----------------	--------------	--	--	--	--	------------

Vents Add VENTS to Model number for side and bottom vents. Shown on CRL-MS-2828-SHELF model.

Side and bottom vents are included with the RACK model.

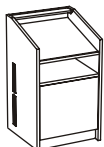

Option:	OPTION-CUTOUTS					117
----------------	----------------	--	--	--	--	------------

Cutouts Add cutout for other options such as microphones, etc. Price is for cutout only, does not include the equipment. Must provide a template for the required cutout.

7% price increase effective January 1, 2009

Credenzas - Overview

Credenza with lower storage

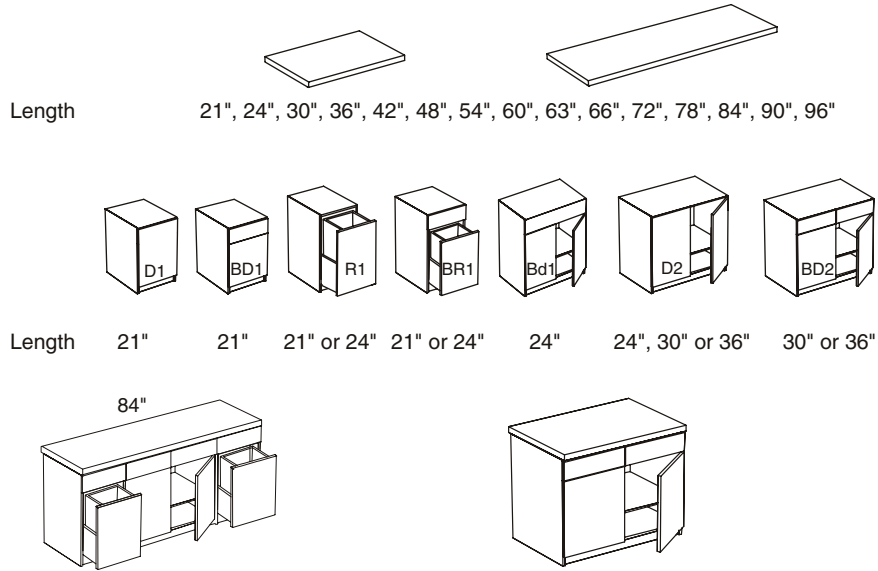

Credenza with TRI Triangle base and box drawers

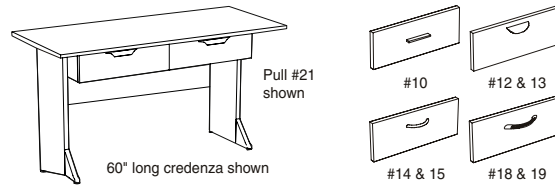

Credenza between storage towers

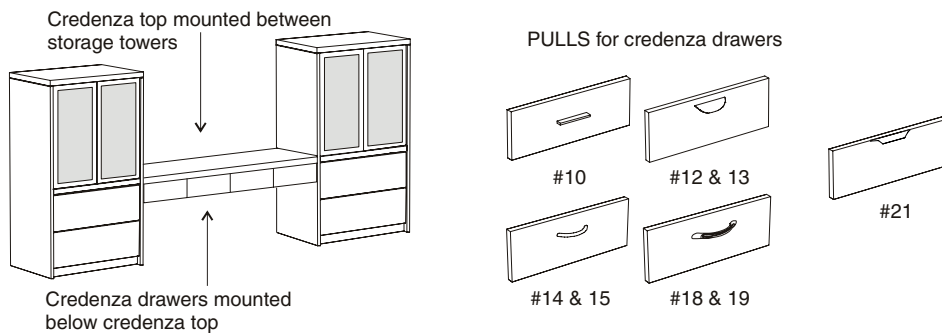

7% price increase effective January 1, 2009

Modular 8 style Credenza tops

Description	Model Number	Dimensions			Wgt	List Prices		
		Long	Deep	High		Wood Edges		
						WoodPlus	Standard	Detailed

Modular 8 style credenza tops

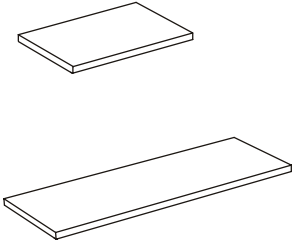

CRC-TOP-M8-2416	16	24	1.75	14	179	228	413
CRC-TOP-M8-2421	21	24	1.75	17	199	248	433
CRC-TOP-M8-2424	24	24	1.75	19	199	248	433
CRC-TOP-M8-2430	30	24	1.75	24	235	284	469
CRC-TOP-M8-2436	36	24	1.75	29	261	310	495
CRC-TOP-M8-2442	42	24	1.75	33	265	314	499
CRC-TOP-M8-2448	48	24	1.75	38	265	314	499
CRC-TOP-M8-2454	54	24	1.75	43	378	427	612
CRC-TOP-M8-2460	60	24	1.75	48	378	427	625
CRC-TOP-M8-2463	63	24	1.75	50	413	462	660
CRC-TOP-M8-2466	66	24	1.75	52	413	462	660
CRC-TOP-M8-2472	72	24	1.75	57	413	462	660
CRC-TOP-M8-2478	78	24	1.75	62	417	466	682
CRC-TOP-M8-2484	84	24	1.75	67	417	466	682
CRC-TOP-M8-2490	90	24	1.75	72	513	562	778
CRC-TOP-M8-2496	96	24	1.75	76	513	562	778
CRC-TOP-M8-24102	102	24	1.75	81	643	692	920
CRC-TOP-M8-24108	108	24	1.75	86	643	692	920
CRC-TOP-M8-24114	114	24	1.75	91	643	692	920
CRC-TOP-M8-24120	120	24	1.75	95	643	692	920

How to specify your credenza

Choose the credenza top to determine the overall length of the credenza 72 with DET detailed wood edge
 Add 2000 Series wood edge along the front of the top
 Add Brushed Brass inlay along the front of the top

Choose the lower units to fill in the credenza

Lower unit style	length		notes
BD1 Box drawer, single door	24	long	door hinges on left
R1 Recycle bin	24	long	
BD1 Box drawer, single door	24	long	door hinges on right

Total list for credenza:

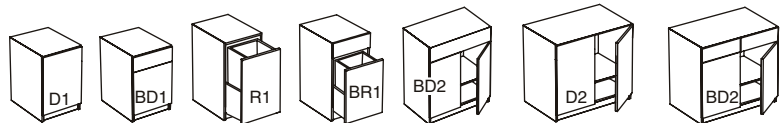

Length	21"	21"	21" or 24"	21" or 24"	24"	24", 30" or 36"	30" or 36"
--------	-----	-----	------------	------------	-----	-----------------	------------

7% price increase effective January 1, 2009

Modular 8 style credenza lower units

Description	Model Number	Dimensions			Wgt	List Prices		
		Long	Deep	High		Wood Edges		
						WoodPlus	Standard	Detailed

Lower units for 29" high credenzas

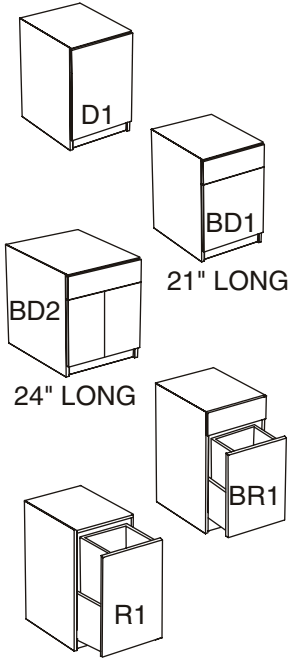

16" wide, 29" high	CRC-CAB-M8-241629-D1-L	16	24	29	82	814	814	814
	CRC-CAB-M8-241629-D1-R	16	24	29	82	814	814	814
	CRC-CAB-M8-241629-BD1-L	16	24	29	82	859	859	859
	CRC-CAB-M8-241629-BD1-R	16	24	29	82	859	859	859
Specify whether the door hinges on the LEFT or RIGHT - when facing the unit.								
21" wide, 29" high	CRC-CAB-M8-242129-D1-L	21	24	29	92	814	814	814
	CRC-CAB-M8-242129-D1-R	21	24	29	92	814	814	814
	CRC-CAB-M8-242129-BD1-L	21	24	29	92	954	954	954
	CRC-CAB-M8-242129-BD1-R	21	24	29	92	954	954	954
	CRC-CAB-M8-242129-R1	21	24	29	92	859	859	859
	CRC-CAB-M8-242129-BR1	21	24	29	92	999	999	999
Specify whether the door hinges on the LEFT or RIGHT - when facing the unit.								
24" wide, 29" high	CRC-CAB-M8-242429-D2	24	24	29	98	814	814	814
	CRC-CAB-M8-242429-BD2	24	24	29	98	954	954	954
	CRC-CAB-M8-242429-R1	24	24	29	98	859	859	859
	CRC-CAB-M8-242429-BR1	24	24	29	98	999	999	999
BD2 cabinet at 24" long has one drawer and one pair of doors.								
30" wide, 29" high	CRC-CAB-M8-243029-D2	30	24	29	118	826	826	826
	CRC-CAB-M8-243029-BD2	30	24	29	118	1106	1106	1106
36" wide, 29" high	CRC-CAB-M8-243629-D2	36	24	29	138	826	826	826
	CRC-CAB-M8-243629-BD2	36	24	29	138	1106	1106	1106

Specify Pull for drawers, doors or recycle bins

Lower units for 36" high credenzas

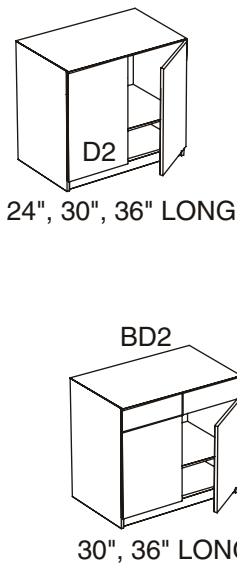

16" wide, 36" high	CRC-CAB-M8-241636-D1-L	16	24	36	82	895	895	895
	CRC-CAB-M8-241636-D1-R	16	24	36	82	895	895	895
	CRC-CAB-M8-241636-BD1-L	16	24	36	82	945	945	945
	CRC-CAB-M8-241636-BD1-R	16	24	36	82	945	945	945
Specify whether the door hinges on the LEFT or RIGHT - when facing the unit.								
21" wide, 36" high	CRC-CAB-M8-242136-D1-L	21	24	36	92	895	895	895
	CRC-CAB-M8-242136-D1-R	21	24	36	92	895	895	895
	CRC-CAB-M8-242136-BD1-L	21	24	36	92	1035	1035	1035
	CRC-CAB-M8-242136-BD1-R	21	24	36	92	1035	1035	1035
	CRC-CAB-M8-242136-R1	21	24	36	92	945	945	945
	CRC-CAB-M8-242136-BR1	21	24	36	92	1085	1085	1085
Specify whether the door hinges on the LEFT or RIGHT - when facing the unit.								
24" wide, 36" high	CRC-CAB-M8-242436-D1	24	24	36	98	895	895	895
	CRC-CAB-M8-242436-BD1	24	24	36	98	1035	1035	1035
	CRC-CAB-M8-242436-R1	24	24	36	98	945	945	945
	CRC-CAB-M8-242436-BR1	24	24	36	98	1085	1085	1085
BD2 cabinet at 24" long has one drawer and one pair of doors.								
30" wide, 36" high	CRC-CAB-M8-243036-D2	30	24	36	118	909	909	909
	CRC-CAB-M8-243036-BD2	30	24	36	118	1189	1189	1189
36" wide, 36" high	CRC-CAB-M8-243636-D2	36	24	36	138	909	909	909
	CRC-CAB-M8-243636-BD2	36	24	36	138	1189	1189	1189

Pair of doors and two drawers on all credenza cabinets 24" or longer.

7% price increase effective January 1, 2009

Equations Standard style Credenza tops

Description	Model Number	Dimensions			Wgt	List Prices		
		Long	Deep	High		Wood Edges		
						WoodPlus	Standard	Detailed

Equations Standard style credenza tops

CRC-TOP-EQ-2416	16	24	1.125	14	179	228	413
CRC-TOP-EQ-2421	21	24	1.125	17	199	248	433
CRC-TOP-EQ-2424	24	24	1.125	19	199	248	433
CRC-TOP-EQ-2430	30	24	1.125	24	235	284	469
CRC-TOP-EQ-2436	36	24	1.125	29	261	310	495
CRC-TOP-EQ-2442	42	24	1.125	33	265	314	499
CRC-TOP-EQ-2448	48	24	1.125	38	265	314	499
CRC-TOP-EQ-2454	54	24	1.125	43	378	427	612
CRC-TOP-EQ-2460	60	24	1.125	48	378	427	625
CRC-TOP-EQ-2463	63	24	1.125	50	413	462	660
CRC-TOP-EQ-2466	66	24	1.125	52	413	462	660
CRC-TOP-EQ-2472	72	24	1.125	57	413	462	660
CRC-TOP-EQ-2478	78	24	1.125	62	417	466	682
CRC-TOP-EQ-2484	84	24	1.125	67	417	466	682
CRC-TOP-EQ-2490	90	24	1.125	72	513	562	778
CRC-TOP-EQ-2496	96	24	1.125	76	513	562	778
CRC-TOP-EQ-24102	102	24	1.125	81	643	692	920
CRC-TOP-EQ-24108	108	24	1.125	86	643	692	920
CRC-TOP-EQ-24114	114	24	1.125	91	643	692	920
CRC-TOP-EQ-24120	120	24	1.125	95	643	692	920

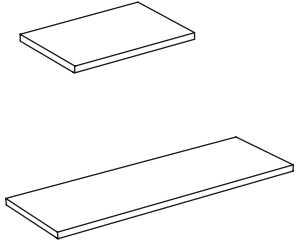

How to specify your credenza

Choose the credenza top to determine the overall length of the credenza 72 with DET detailed wood edge

Add 2000 Series wood edge along the front of the top

Add Brushed Brass inlay along the front of the top

Choose the lower units to fill in the credenza

Lower unit style	length		notes
BD1 Box drawer, single door	24	long	door hinges on left
R1 Recycle bin	24	long	
BD1 Box drawer, single door	24	long	door hinges on right

Total list for credenza:

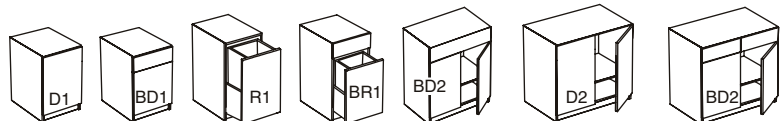

Length 21" 21" 21" or 24" 21" or 24" 24" 24", 30" or 36" 30" or 36"

7% price increase effective January 1, 2009

Equations Standard style credenza lower units

Description	Model Number	Dimensions			Wgt	List Prices		
		Long	Deep	High		Wood Edges		
						WoodPlus	Standard	Detailed

Lower units for 29" high credenzas

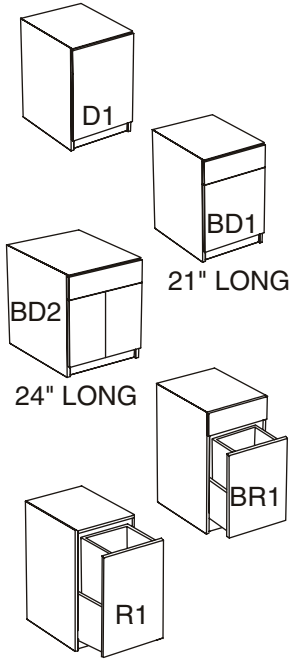

16" wide, 29" high	CRC-CAB-EQ-241629-D1-L	16	24	29	82	814	814	814
	CRC-CAB-EQ-241629-D1-R	16	24	29	82	814	814	814
	CRC-CAB-EQ-241629-BD1-L	16	24	29	82	859	859	859
	CRC-CAB-EQ-241629-BD1-R	16	24	29	82	859	859	859
Specify whether the door hinges on the LEFT or RIGHT - when facing the unit.								
21" wide, 29" high	CRC-CAB-EQ-242129-D1-L	21	24	29	92	814	814	814
	CRC-CAB-EQ-242129-D1-R	21	24	29	92	814	814	814
	CRC-CAB-EQ-242129-BD1-L	21	24	29	92	954	954	954
	CRC-CAB-EQ-242129-BD1-R	21	24	29	92	954	954	954
	CRC-CAB-EQ-242129-R1	21	24	29	92	859	859	859
	CRC-CAB-EQ-242129-BR1	21	24	29	92	999	999	999
Specify whether the door hinges on the LEFT or RIGHT - when facing the unit.								
24" wide, 29" high	CRC-CAB-EQ-242429-D1	24	24	29	98	814	814	814
	CRC-CAB-EQ-242429-BD1	24	24	29	98	954	954	954
	CRC-CAB-EQ-242429-R1	24	24	29	98	859	859	859
	CRC-CAB-EQ-242429-BR1	24	24	29	98	999	999	999
BD2 cabinet at 24" long has one drawer and one pair of doors.								
30" wide, 29" high	CRC-CAB-EQ-243029-D2	30	24	29	118	826	826	826
	CRC-CAB-EQ-243029-BD2	30	24	29	118	1106	1106	1106
36" wide, 29" high	CRC-CAB-EQ-243629-D2	36	24	29	138	826	826	826
	CRC-CAB-EQ-243629-BD2	36	24	29	138	1106	1106	1106

Pair of doors and two drawers on all credenza cabinets 24" or longer.

Specify Pull for drawers, doors or recycle bins

Lower units for 36" high credenzas

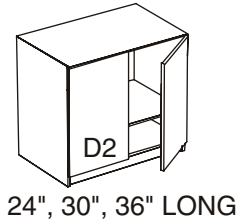

24", 30", 36" LONG

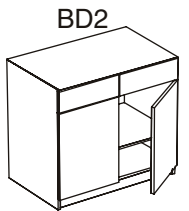

30", 36" LONG

16" wide, 36" high	CRC-CAB-EQ-241636-D1-L	16	24	36	82	895	895	895
	CRC-CAB-EQ-241636-D1-R	16	24	36	82	895	895	895
	CRC-CAB-EQ-241636-BD1-L	16	24	36	82	945	945	945
	CRC-CAB-EQ-241636-BD1-R	16	24	36	82	945	945	945
Specify whether the door hinges on the LEFT or RIGHT - when facing the unit.								
21" wide, 36" high	CRC-CAB-EQ-242136-D1-L	21	24	36	92	895	895	895
	CRC-CAB-EQ-242136-D1-R	21	24	36	92	895	895	895
	CRC-CAB-EQ-242136-BD1-L	21	24	36	92	1035	1035	1035
	CRC-CAB-EQ-242136-BD1-R	21	24	36	92	1035	1035	1035
	CRC-CAB-EQ-242136-R1	21	24	36	92	945	945	945
	CRC-CAB-EQ-242136-BR1	21	24	36	92	1085	1085	1085
Specify whether the door hinges on the LEFT or RIGHT - when facing the unit.								
24" wide, 36" high	CRC-CAB-EQ-242436-D1	24	24	36	98	895	895	895
	CRC-CAB-EQ-242436-BD1	24	24	36	98	1035	1035	1035
	CRC-CAB-EQ-242436-R1	24	24	36	98	945	945	945
	CRC-CAB-EQ-242436-BR1	24	24	36	98	1085	1085	1085
BD2 cabinet at 24" long has one drawer and one pair of doors.								
30" wide, 36" high	CRC-CAB-EQ-243036-D2	30	24	36	118	909	909	909
	CRC-CAB-EQ-243036-BD2	30	24	36	118	1189	1189	1189
36" wide, 36" high	CRC-CAB-EQ-243636-D2	36	24	36	138	909	909	909
	CRC-CAB-EQ-243636-BD2	36	24	36	138	1189	1189	1189

Pair of doors and two drawers on all credenza cabinets 24" or longer.

7% price increase effective January 1, 2009

Series 50 style Credenza tops

Description	Model Number	Dimensions			Wgt	List Prices		
		Long	Deep	High		Wood Edges		
						WoodPlus	Standard	Detailed

Series 50 style credenza tops

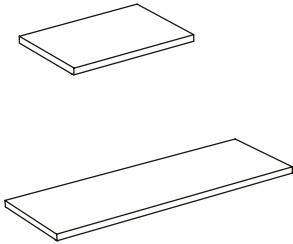

CRC-TOP-S50-2416	16	24	1.5	14	179	228	413
CRC-TOP-S50-2421	21	24	1.5	17	199	248	433
CRC-TOP-S50-2424	24	24	1.5	19	199	248	433
CRC-TOP-S50-2430	30	24	1.5	24	235	284	469
CRC-TOP-S50-2436	36	24	1.5	29	261	310	495
CRC-TOP-S50-2442	42	24	1.5	33	265	314	499
CRC-TOP-S50-2448	48	24	1.5	38	265	314	499
CRC-TOP-S50-2454	54	24	1.5	43	378	427	612
CRC-TOP-S50-2460	60	24	1.5	48	378	427	625
CRC-TOP-S50-2463	63	24	1.5	50	413	462	660
CRC-TOP-S50-2466	66	24	1.5	52	413	462	660
CRC-TOP-S50-2472	72	24	1.5	57	413	462	660
CRC-TOP-S50-2478	78	24	1.5	62	417	466	682
CRC-TOP-S50-2484	84	24	1.5	67	417	466	682
CRC-TOP-S50-2490	90	24	1.5	72	513	562	778
CRC-TOP-S50-2496	96	24	1.5	76	513	562	778
CRC-TOP-S50-24102	102	24	1.5	81	643	692	920
CRC-TOP-S50-24108	108	24	1.5	86	643	692	920
CRC-TOP-S50-24114	114	24	1.5	91	643	692	920
CRC-TOP-S50-24120	120	24	1.5	95	643	692	920

How to specify your credenza

Choose the credenza top to determine the overall length of the credenza 72 with DET detailed wood edge
 Add 2000 Series wood edge along the front of the top
 Add Brushed Brass inlay along the front of the top

Choose the lower units to fill in the credenza

Lower unit style	length		notes
BD1 Box drawer, single door	24	long	door hinges on left
R1 Recycle bin	24	long	
BD1 Box drawer, single door	24	long	door hinges on right

Total list for credenza:

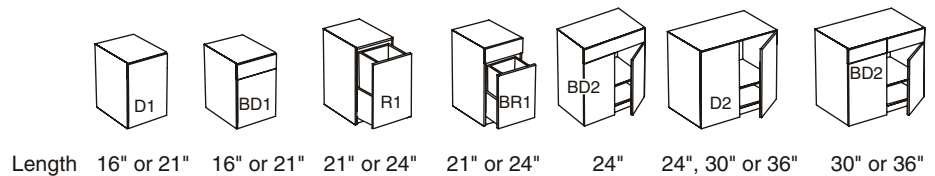

7% price increase effective January 1, 2009

Series 50 style credenza lower units

Description	Model Number	Dimensions			Wgt	List Prices		
		Long	Deep	High		Wood Edges		
						WoodPlus	Standard	Detailed

Lower units for 29" high credenzas

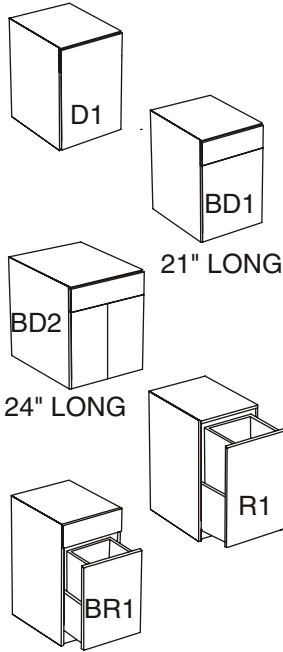

16" wide, 29" high	CRC-CAB-S50-241629-D1-L	16	24	29	82	814	814	814
	CRC-CAB-S50-241629-D1-R	16	24	29	82	814	814	814
	CRC-CAB-S50-241629-BD1-L	16	24	29	82	859	859	859
	CRC-CAB-S50-241629-BD1-R	16	24	29	82	859	859	859
Specify whether the door hinges on the LEFT or RIGHT - when facing the unit.								
21" wide, 29" high	CRC-CAB-S50-242129-D1-L	21	24	29	92	814	814	814
	CRC-CAB-S50-242129-D1-R	21	24	29	92	814	814	814
	CRC-CAB-S50-242129-BD1-L	21	24	29	92	954	954	954
	CRC-CAB-S50-242129-BD1-R	21	24	29	92	954	954	954
	CRC-CAB-S50-242129-R1	21	24	29	92	859	859	859
	CRC-CAB-S50-242129-BR1	21	24	29	92	999	999	999
Specify whether the door hinges on the LEFT or RIGHT - when facing the unit.								
24" wide, 29" high	CRC-CAB-S50-242429-D1	24	24	29	98	814	814	814
	CRC-CAB-S50-242429-BD1	24	24	29	98	954	954	954
	CRC-CAB-S50-242429-R1	24	24	29	98	859	859	859
	CRC-CAB-S50-242429-BR1	24	24	29	98	999	999	999
BD2 cabinet at 24" long has one drawer and one pair of doors.								
30" wide, 29" high	CRC-CAB-S50-243029-D2	30	24	29	118	826	826	826
	CRC-CAB-S50-243029-BD2	30	24	29	118	1106	1106	1106
36" wide, 29" high	CRC-CAB-S50-243629-D2	36	24	29	138	826	826	826
	CRC-CAB-S50-243629-BD2	36	24	29	138	1106	1106	1106

Pair of doors and two drawers on all credenza cabinets 24" or longer.

Specify Pull for drawers, doors or recycle bins

Lower units for 36" high credenzas

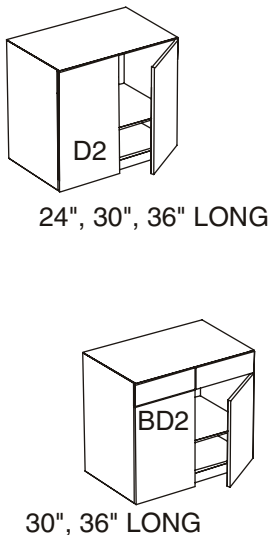

16" wide, 36" high	CRC-CAB-S50-241636-D1-L	16	24	36	82	895	895	895
	CRC-CAB-S50-241636-D1-R	16	24	36	82	895	895	895
	CRC-CAB-S50-241636-BD1-L	16	24	36	82	945	945	945
	CRC-CAB-S50-241636-BD1-R	16	24	36	82	945	945	945
Specify whether the door hinges on the LEFT or RIGHT - when facing the unit.								
21" wide, 36" high	CRC-CAB-S50-242136-D1-L	21	24	36	92	895	895	895
	CRC-CAB-S50-242136-D1-R	21	24	36	92	895	895	895
	CRC-CAB-S50-242136-BD1-L	21	24	36	92	1035	1035	1035
	CRC-CAB-S50-242136-BD1-R	21	24	36	92	1035	1035	1035
	CRC-CAB-S50-242136-R1	21	24	36	92	945	945	945
	CRC-CAB-S50-242136-BR1	21	24	36	92	1085	1085	1085
Specify whether the door hinges on the LEFT or RIGHT - when facing the unit.								
24" wide, 36" high	CRC-CAB-S50-242436-D1	24	24	36	98	895	895	895
	CRC-CAB-S50-242436-BD1	24	24	36	98	1035	1035	1035
	CRC-CAB-S50-242436-R1	24	24	36	98	945	945	945
	CRC-CAB-S50-242436-BR1	24	24	36	98	1085	1085	1085
BD2 cabinet at 24" long has one drawer and one pair of doors.								
30" wide, 36" high	CRC-CAB-S50-243036-D2	30	24	36	118	909	909	909
	CRC-CAB-S50-243036-BD2	30	24	36	118	1189	1189	1189
36" wide, 36" high	CRC-CAB-S50-243636-D2	36	24	36	138	909	909	909
	CRC-CAB-S50-243636-BD2	36	24	36	138	1189	1189	1189

Pair of doors and two drawers on all credenza cabinets 24" or longer.

7% price increase effective January 1, 2009

Equations2 WoodPlus2 style credenza lower units

Description Model Number Dimensions Wgt List Prices
 Long Deep High WoodPlus2

Lower units for 29" high credenzas

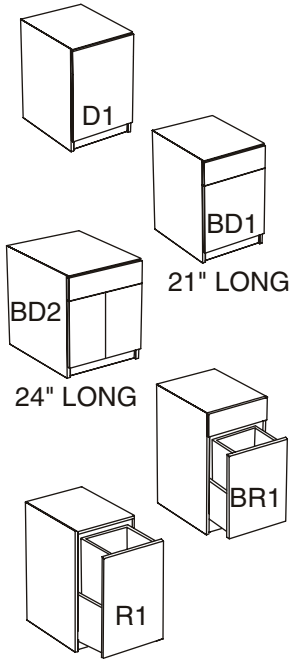

16" wide, 29" high	CRC-CAB-WP2-241629-D1-L	16	24	29	82	814
	CRC-CAB-WP2-241629-D1-R	16	24	29	82	814
	CRC-CAB-WP2-241629-BD1-L	16	24	29	82	859
	CRC-CAB-WP2-241629-BD1-R	16	24	29	82	859
Specify whether the door hinges on the LEFT or RIGHT - when facing the unit.						
21" wide, 29" high	CRC-CAB-WP2-242129-D1-L	21	24	29	92	814
	CRC-CAB-WP2-242129-D1-R	21	24	29	92	814
	CRC-CAB-WP2-242129-BD1-L	21	24	29	92	954
	CRC-CAB-WP2-242129-BD1-R	21	24	29	92	954
	CRC-CAB-WP2-242129-R1	21	24	29	92	859
	CRC-CAB-WP2-242129-BR1	21	24	29	92	999
Specify whether the door hinges on the LEFT or RIGHT - when facing the unit.						
24" wide, 29" high	CRC-CAB-WP2-242429-D1	24	24	29	98	814
	CRC-CAB-WP2-242429-BD1	24	24	29	98	954
	CRC-CAB-WP2-242429-R1	24	24	29	98	859
	CRC-CAB-WP2-242429-BR1	24	24	29	98	999
BD2 cabinet at 24" long has one drawer and one pair of doors.						
30" wide, 29" high	CRC-CAB-WP2-243029-D2	30	24	29	118	826
	CRC-CAB-WP2-243029-BD2	30	24	29	118	1106
36" wide, 29" high	CRC-CAB-WP2-243629-D2	36	24	29	138	826
	CRC-CAB-WP2-243629-BD2	36	24	29	138	1106

Pair of doors and two drawers on all credenza cabinets 24" or longer.

Specify Pull for drawers,
doors or recycle bins

Lower units for 36" high credenzas

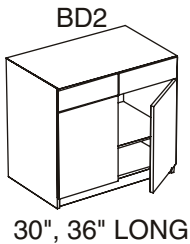
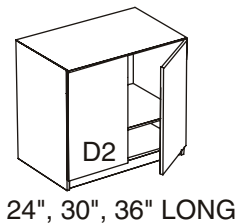

16" wide, 36" high	CRC-CAB-WP2-241636-D1-L	16	24	36	82	895
	CRC-CAB-WP2-241636-D1-R	16	24	36	82	895
	CRC-CAB-WP2-241636-BD1-L	16	24	36	82	945
	CRC-CAB-WP2-241636-BD1-R	16	24	36	82	945
Specify whether the door hinges on the LEFT or RIGHT - when facing the unit.						
21" wide, 36" high	CRC-CAB-WP2-242136-D1-L	21	24	36	92	895
	CRC-CAB-WP2-242136-D1-R	21	24	36	92	895
	CRC-CAB-WP2-242136-BD1-L	21	24	36	92	1035
	CRC-CAB-WP2-242136-BD1-R	21	24	36	92	1035
	CRC-CAB-WP2-242136-R1	21	24	36	92	945
	CRC-CAB-WP2-242136-BR1	21	24	36	92	1085
Specify whether the door hinges on the LEFT or RIGHT - when facing the unit.						
24" wide, 36" high	CRC-CAB-WP2-242436-D1	24	24	36	98	895
	CRC-CAB-WP2-242436-BD1	24	24	36	98	1035
	CRC-CAB-WP2-242436-R1	24	24	36	98	945
	CRC-CAB-WP2-242436-BR1	24	24	36	98	1085
BD2 cabinet at 24" long has one drawer and one pair of doors.						
30" wide, 36" high	CRC-CAB-WP2-243036-D2	30	24	36	118	909
	CRC-CAB-WP2-243036-BD2	30	24	36	118	1189
36" wide, 36" high	CRC-CAB-WP2-243636-D2	36	24	36	138	909
	CRC-CAB-WP2-243636-BD2	36	24	36	138	1189

Pair of doors and two drawers on all credenza cabinets 24" or longer.

7% price increase effective January 1, 2009

Credenzas with TRI Base and drawers

Description	Model Number	Dimensions			Wgt	List Prices		
		Long	Deep	High		Wood Edges		
						WoodPlus	Standard	Detailed

WoodPlus Credenza Tops with TRI Triangle base and drawers

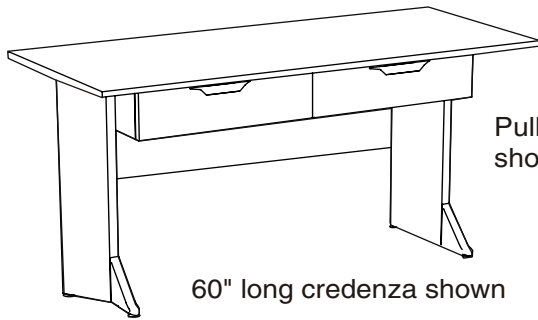

Pull #21 shown

60" long credenza shown

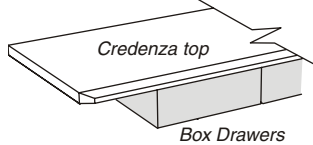
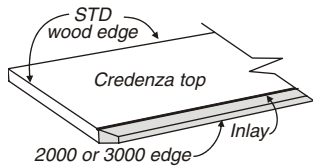
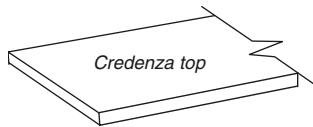
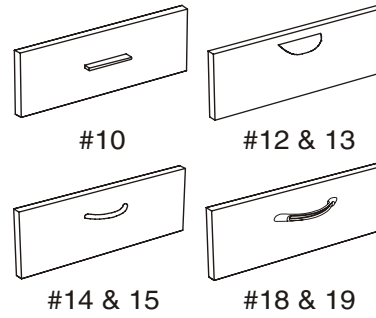

Modular 8 Credenza top	CRC-TOP-M8-2460	60	24	1.75	48	378	427	625
	CRC-TOP-M8-2466	66	24	1.75	52	413	462	660
	CRC-TOP-M8-2472	72	24	1.75	57	413	462	660
Equations Standard Credenza top	CRC-TOP-EQ-2460	60	24	1.125	48	378	427	625
	CRC-TOP-EQ-2466	66	24	1.125	52	413	462	660
	CRC-TOP-EQ-2472	72	24	1.125	57	413	462	660
Series 50 Credenza top	CRC-TOP-S50-2460	642	24	1.50	48	378	427	625
	CRC-TOP-S50-2466	66	24	1.50	52	413	462	660
	CRC-TOP-S50-2472	72	24	1.50	57	413	462	660
Pair of TRI Triangle bases	BASE-TRI-CRED-2429			29		492	492	492
	This is a pair of the TRI Triangle bases to support the credenza top and includes a half modesty panel. Please specify black or silver finish on the 'wedges'.							
Drawer units	CRC-TRI-DRAWERS-WP-60					730	730	730
	CRC-TRI-DRAWERS-WP-66					777	777	777
	CRC-TRI-DRAWERS-WP-72					777	777	777
	At 60" long, two drawers, at 66" and 72" long, three drawers.							
Front of top edge	CREDENZA-2000-1LONG					356		
	CREDENZA-3000-1LONG					514		
	For the front edge of credenza top only. Other three edges use 3mm Standard wood edge.							
Inlay along front edge of top	CREDENZA-INLAY-BLACK-1LONG							95
	CREDENZA-INLAY-BRASS-1LONG							137
	CREDENZA-INLAY-CHROME-1LONG							137
	For use with the 2000 or 3000 edge along the front of the credenza top.							
Inlay on all four sides of top	CREDENZA-INLAY-BLACK-4SIDES							275
	CREDENZA-INLAY-BRASS-4SIDES							413
	CREDENZA-INLAY-CHROME-4SIDES							413
	For use with the Detailed wood edge only							
Pulls	Pull 10, 12, 13, 14, 15, 18, 19							NC
	Pull 21					charge per pull:		21

7% price increase effective January 1, 2009

Equations2 WoodPlus2 style credenza with Triangle base

Description Model Number Dimensions Wgt List Prices
 Long Deep High WoodPlus2

WoodPlus2 Credenza Tops with TRI Triangle base and drawers

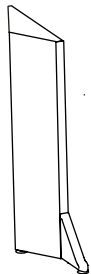
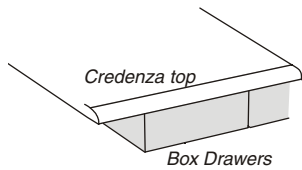
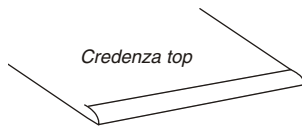
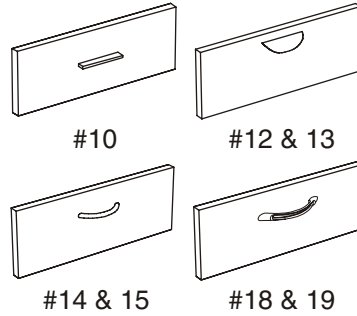
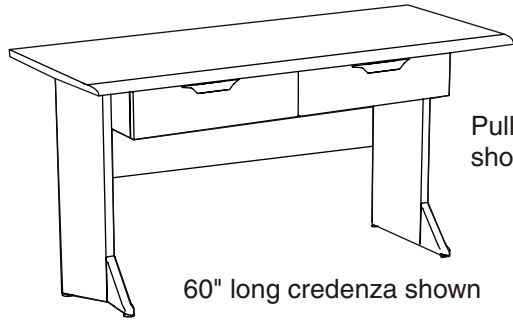

Credenza top	CRC-TOP-WP2-2460	60	24	1.125	48	541
	CRC-TOP-WP2-2466	66	24	1.125	52	597
	CRC-TOP-WP2-2472	72	24	1.125	57	597
Pair of TRI Triangle bases	BASE-TRI-CRED-2429			29		492
	This is a pair of the TRI Triangle bases to support the credenza top and includes a half modesty panel. Please specify black or silver finish on the 'wedges'.					
Drawer units	CRC-TRI-DRAWERS-WP2-60					730
	CRC-TRI-DRAWERS-WP2-66					777
	CRC-TRI-DRAWERS-WP2-72					777
	At 60" long, two drawers, at 66" and 72" long, three drawers.					
Pulls	Pull 10, 12, 13, 14, 15, 18, 19					NC
	Pull 21				charge per pull:	21

7% price increase effective January 1, 2009

WoodPlus style credenza top between Towers

Description	Model Number	Dimensions			Wgt	List Prices		
		Long	Deep	High		WoodPlus	Standard	Detailed

WoodPlus Credenza Tops mounted between towers, optional drawers

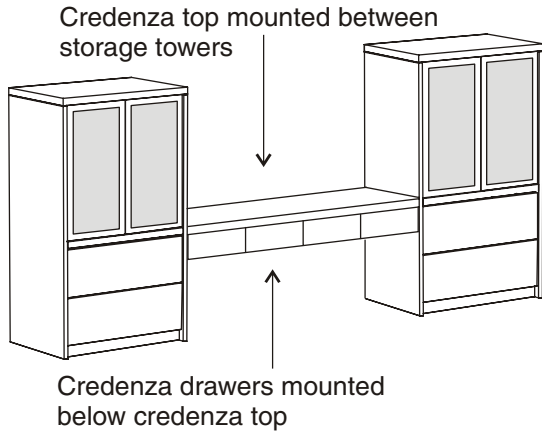

PULLS for credenza drawers

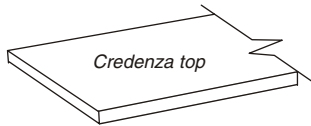
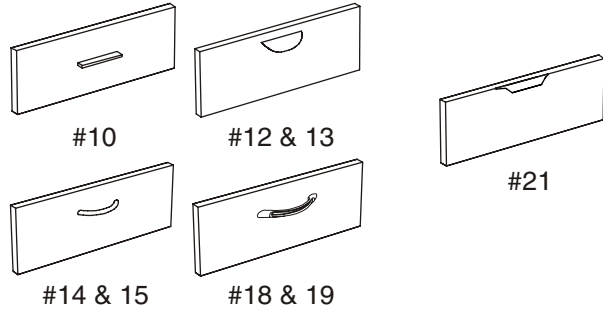

Modular 8 Credenza top	CRC-TOP-M8-2460	60	24	1.75	48	416	462	603
	CRC-TOP-M8-2466	66	24	1.75	52	455	501	642
	CRC-TOP-M8-2472	72	24	1.75	57	455	501	642

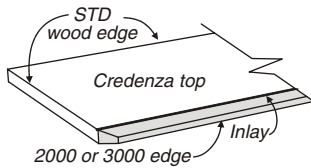

Equations Standard Credenza top	CRC-TOP-EQ-2460	60	24	1.125	48	416	462	603
	CRC-TOP-EQ-2466	66	24	1.125	52	455	501	642
	CRC-TOP-EQ-2472	72	24	1.125	57	455	501	642

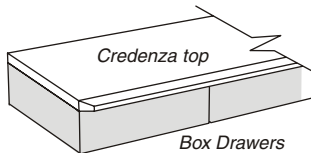

Series 50 Credenza top	CRC-TOP-S50-2460	642	24	1.50	48	416	462	603
	CRC-TOP-S50-2466	66	24	1.50	52	455	501	642
	CRC-TOP-S50-2472	72	24	1.50	57	455	501	642

Drawer units	CREDENZA-BOX-DRWRS-WP-60					665	665	665
	CREDENZA-BOX-DRWRS-WP-66					707	707	707
	CREDENZA-BOX-DRWRS-WP-72					707	707	707

At 60" long, three drawers, at 66" and 72" long, four drawers.

Front of top edge	CREDENZA-2000-1LONG					356	356	356
	CREDENZA-3000-1LONG					514	514	514

For the front edge of credenza top only. Other three edges use 3mm Standard wood edge. The 2000 or 3000 wood edge extends past the face of the adjacent towers.

Inlay along front edge of top	CREDENZA-INLAY-BLACK-1LONG					95	95	95
	CREDENZA-INLAY-BRASS-1LONG					137	137	137
	CREDENZA-INLAY-CHROME-1LONG					137	137	137

For use with the 2000 or 3000 edge along the front of the credenza top.

Inlay on all four sides of top	CREDENZA-INLAY-BLACK-4SIDES							275
	CREDENZA-INLAY-BRASS-4SIDES							413
	CREDENZA-INLAY-CHROME-4SIDES							413

For use with the Detailed wood edge only

Pulls	Pull 10, 12, 13, 14, 15, 18, 19							NC
	Pull 21						charge per pull:	21

Mounting of Credenza top	CRC-AB8-BRACKETS							NC
---------------------------------	------------------	--	--	--	--	--	--	-----------

Two each AB8 brackets to mount CRC-TOP to adjacent towers.

7% price increase effective January 1, 2009

Equations2 WoodPlus2 style credenza top between Towers

Description	Model Number	Dimensions			Wgt	List Prices WoodPlus2
		Long	Deep	High		

WoodPlus2 Credenza Tops mounted between towers, optional drawers

Credenza top mounted between storage towers

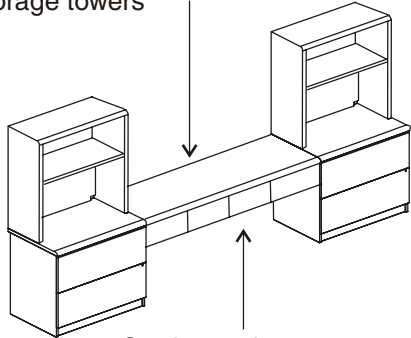

Credenza drawers mounted below credenza top

PULLS for credenza drawers

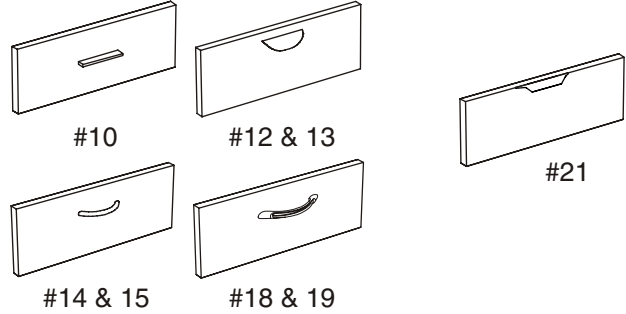

Credenza top	Model Number	Long	Deep	High	Wgt	List Prices
	CRC-TOP-WP2-2460	60	24	1.125	48	416
	CRC-TOP-WP2-2466	66	24	1.125	52	455
	CRC-TOP-WP2-2472	72	24	1.125	57	455

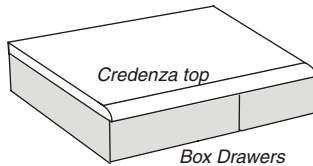

Drawer units	Model Number	List Prices
	CREDENZA-BOX-DRWRS-WP2-60	730
	CREDENZA-BOX-DRWRS-WP2-66	777
	CREDENZA-BOX-DRWRS-WP2-72	777

At 60" long, three drawers, at 66" and 72" long, four drawers.

Pulls	Model Number	List Prices
	Pull 10, 12, 13, 14, 15, 18, 19	NC
	Pull 21	charge per pull: 21

Mounting of Credenza top	Model Number	List Prices
	CRC-AB8-BRACKETS	NC
	Two each AB8 brackets to mount CRC-TOP to adjacent towers.	

7% price increase effective January 1, 2009

Occasional Tables

Cube Tables

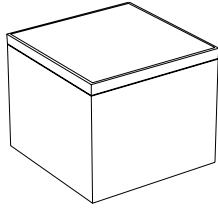

CUBE-202024-STD

Description	Model Number	Dimensions			Wgt	List Prices		
		Wide	Deep	High		Wood Edges		
						WoodPlus	Standard	Detailed
18" square	CUBE-181816	18	18	16	64	531	578	797
	CUBE-181820	18	18	20	73	620	667	886
	CUBE-181824	18	18	24	85	684	731	950
20" square	CUBE-202016	20	20	16	64	584	631	850
	CUBE-202020	20	20	20	73	683	730	949
	CUBE-202024	20	20	24	85	790	837	1056
24" square	CUBE-242416	24	24	16	86	629	676	895
	CUBE-242420	24	24	20	98	738	785	1004
	CUBE-242424	24	24	24	112	855	902	1121
30" square	CUBE-303016	30	30	16	94	783	830	1049
	CUBE-303020	30	30	20	105	838	885	1104
	CUBE-303030	30	30	30	116	955	1002	1221
36" square	CUBE-363616	36	36	16	140	899	946	1165
	CUBE-363620	36	36	20	156	950	997	1216

Drum Tables

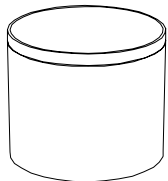

DRUM-2024-STD

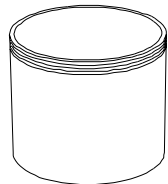

DRUM-2024-RE

20" diameter	DRUM-2018	20	18	61	575	622	841
	DRUM-2020	20	20	66	685	732	951
	DRUM-2024	20	24	80	790	837	1056
24" diameter	DRUM-2418	24	18	77	704	751	970
	DRUM-2420	24	20	83	829	876	1095
	DRUM-2424	24	24	100	951	998	1217
30" diameter	DRUM-3018	30	18	106	908	955	1174
	DRUM-3020	30	20	114	1088	1135	1354
	DRUM-3024	30	24	137	1269	1316	1535

Edge Options Information

Cube and Drum Tables are available with the following edge options:

- WoodPlus 3 mm PVC edge
- Standard 3 mm Wood Edge
- Detailed 3/8" Wood Edge

Cube table vertical corners are eased to 3 mm radius.

WoodPlus 3 mm PVC	Standard Wood	Detailed Wood
Equations WPES	Equations SWES	RE
Modular 8 WPER	Modular 8 SWER	RA
WPMS	SWMS	BE
WPMN	SWMN	TR
WPMR	SWMR	CL

7% price increase effective January 1, 2009

Storage Towers with Lateral File drawers

Overview - Storage Towers with Lateral Files

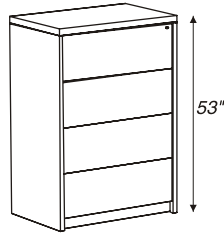

Lateral File:
30" or 36" wide, 24" deep

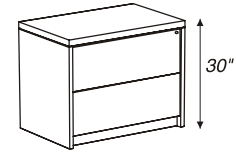
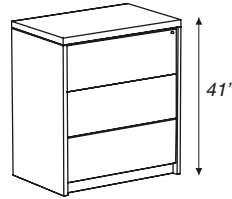

Storage Towers - Rectangular Top, 2, 3 or 4 Lateral File Drawers, see Pg 138

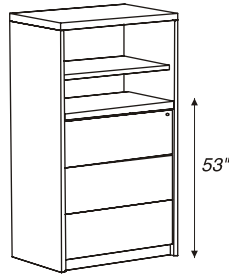

65" or 72" high with Lateral File
30" or 36" wide, 24" deep

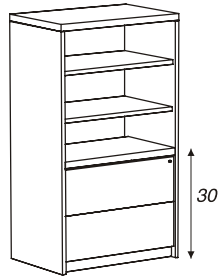

Storage Towers - Rectangular Top, 65" high, Lateral File Drawers, storage above, see Pg 138



Upper Hinged Door (UD)
Lateral File Drawers below

Figure , "Add Upper Hinged Doors," on page 144

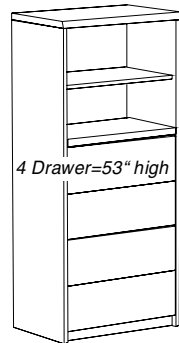

84" high Storage with Lateral File
30" or 36" wide, 84" high, 24" deep

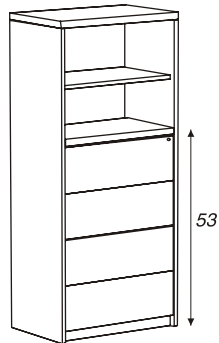

84" high Storage with Lateral File
30" or 36" wide, 84" high, 24" deep

Storage Towers - Rectangular Top, 84" high with Lateral File Drawers and storage above, see Pg 140

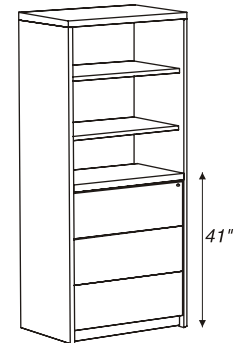

7% price increase effective January 1, 2009

Storage Towers with Lateral File drawers

Storage Towers - Rectangular Top, 2, 3 or 4 Lateral File Drawers

Description	Model Number	List Prices - Laminate			Dimensions			Wgt
		Wood Edges			Wide	Deep	High	
		WoodPlus	Standard	Detailed				
2 Lateral File Drawers	ST8-2LF-3029-24-LOCK	1645	1790	1935	30	24	29	274
	ST8-2LF-3629-24-LOCK	1645	1790	1935	36	24	29	284

Specify Pull number.

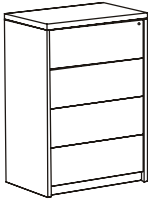
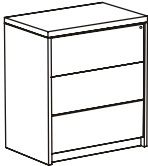
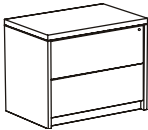

3 Lateral File Drawers	ST8-3LF-3041-24-LOCK	1989	2134	2279	30	24	41	281
	ST8-3LF-3641-24-LOCK	1989	2134	2279	36	24	41	293

Specify Pull number.

4 Lateral File Drawers	ST8-4LF-3053-24-LOCK	2321	2466	2611	30	24	53	288
	ST8-4LF-3653-24-LOCK	2321	2466	2611	36	24	53	301

Specify Pull number.

Storage Towers - Rectangular Top, 65" high, Lateral File Drawers, storage above

2 Lateral Files, 65" high	ST8-2LF-3065-24-LOCK	2196	2389	2553	30	24	65	274
	ST8-2LF-3665-24-LOCK	2253	2446	2610	36	24	65	284

Specify Pull number.

Tower shelf finish matches case finish.

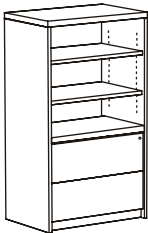

3 Lateral Files, 65" high	ST8-3LF-3065-24-LOCK	2504	2697	2861	30	24	65	281
	ST8-3LF-3665-24-LOCK	2562	2755	2919	36	24	65	293

Specify Pull number.

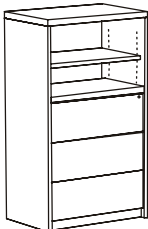

Lateral File Pull Options

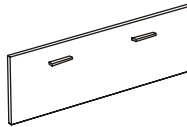

#10 Pull

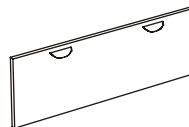

#12 or #13 Pull

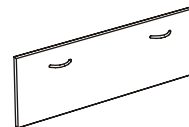

#14 or #15 Pull

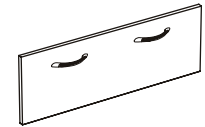

#18 or #19 Pull

Edge Options Information

Modular 8 Tops are 1 3/4" thick, available with the following edge options:

WoodPlus (PVC)



WoodPlus Smooth



WoodPlus Reeded



WoodPlus Neo Classic

WoodPlus 3 mm PVC edge:
 WPMS - 3 mm Smooth
 WPMR - 3 mm Reeded
 WPMN - 3 mm Neo Classic

Standard Wood Edges



Smooth



Reeded



NeoClassic

Standard 3 mm Wood Edge:
 SWMS - 3 mm Radius
 SWMR - 3 mm Reeded
 SWMN - 3 mm NeoClassic

Detailed Wood Edges



Radius



Beveled



Transitional



Reeded



Classic

Detailed 3/8" Wood Edge:
 RA - Radiused
 BE - Beveled
 TR - Transitional
 RE - Reeded
 CL - Classic

7% price increase effective January 1, 2009

Storage Towers with Lateral File drawers

Storage Towers - Rectangular Top, 72" high with Lateral File Drawers and storage above

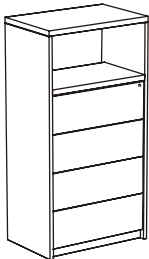
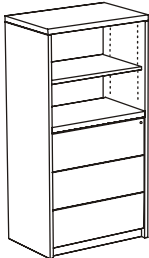
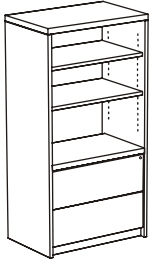

Description	Model Number	List Prices - Laminate			Dimensions			Wgt
		Wood Edges			Wide	Deep	High	
		WoodPlus	Standard	Detailed				
2 Lateral Files, 72" high	ST8-2LF-3072-24-LOCK	2244	2437	2601	30	24	72	310
	ST8-2LF-3672-24-LOCK	2300	2493	2657	36	24	72	322

Specify Pull number.

3 Lateral Files, 72" high	ST8-3LF-3072-24-LOCK	2551	2744	2908	30	24	72	317
	ST8-3LF-3672-24-LOCK	2609	2802	2966	36	24	72	331

Specify Pull number.

4 Lateral Files, 72" high	ST8-4LF-3072-24-LOCK	2934	3127	3291	30	24	72	324
	ST8-4LF-3672-24-LOCK	2997	3190	3354	36	24	72	339

Specify Pull number.

Tower shelf finish matches case finish.

Options

Options are built-in at factory

Upper Hinged Doors: UHD
Specify Door Pull number.

Upper Glass Hinged Doors,
Aluminum Frame UGDA or
WoodPlus Frame UGW

GRV End Panel Grommet

Accessories

Order Separately

ESH Extra Shelf, WoodPlus edge
ESH Extra Shelf, Wood edge

Please specify cabinet.

For information on these and other available options and accessories, please see the end of this section.

See end of this section for pricing on all Options and Accessories

7% price increase effective January 1, 2009

Storage Towers with Lateral File drawers

Storage Towers - Rectangular Top, 84" high with Lateral File Drawers and storage above

Description	Model Number	List Prices - Laminate			Dimensions			Wgt
		Wood Edges			Wide	Deep	High	
		WoodPlus	Standard	Detailed				
2 Lateral Files, 84" high	ST8-2LF-3084-24-LOCK	2362	2555	2719	30	24	84	310
	ST8-2LF-3684-24-LOCK	2427	2620	2784	36	24	84	322

Specify Pull number.

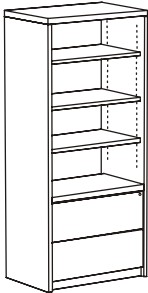

3 Lateral Files, 84" high	ST8-3LF-3084-24-LOCK	2672	2865	3029	30	24	84	317
	ST8-3LF-3684-24-LOCK	2735	2928	3092	36	24	84	331

Specify Pull number.

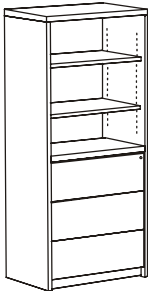

4 Lateral Files, 84" high	ST8-4LF-3084-24-LOCK	2981	3174	3338	30	24	84	324
	ST8-4LF-3684-24-LOCK	3045	3238	3402	36	24	84	339

Specify Pull number.

Tower shelf finish matches case finish.

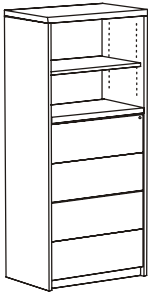

Lateral File Pull Options

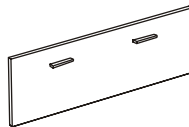

#10 Pull

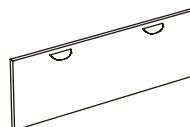

#12 or #13 Pull

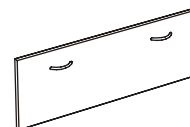

#14 or #15 Pull

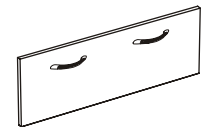

#18 or #19 Pull

Edge Options Information

Modular 8 Tops are 1 3/4" thick, available with the following edge options:

WoodPlus (PVC)



WoodPlus Smooth



WoodPlus Reeded



WoodPlus Neo Classic

WoodPlus 3 mm PVC edge:
 WPMS - 3 mm Smooth
 WPMR - 3 mm Reeded
 WPMN - 3 mm Neo Classic

Standard Wood Edges



Standard Smooth



Standard Reeded



Standard NeoClassic

Standard 3 mm Wood Edge:
 SWMS - 3 mm Radius
 SWMR - 3 mm Reeded
 SWMN - 3 mm NeoClassic

Detailed Wood Edges



Radius



Beveled



Transitional



Reeded

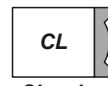

Classic

Detailed 3/8" Wood Edge:
 RA - Radius
 BE - Beveled
 TR - Transitional
 RE - Reeded
 CL - Classic

7% price increase effective January 1, 2009

Storage Towers with Lateral File drawers

Storage Towers - Bow Front Top, 2, 3 or 4 Lateral File Drawers

Description	Model Number	List Prices - Laminate			Dimensions			Wgt
		Wood Edges			Wide	Deep	High	
		WoodPlus	Standard	Detailed				
2 Lateral File Drawers	STB8-2LF-3029-24-LOCK	1677	1816	1957	30	24	29	274
	STB8-2LF-3629-24-LOCK	1677	1816	1957	36	24	29	284

Specify Pull number.

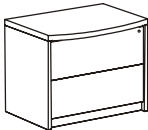
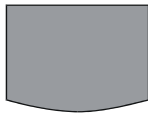

3 Lateral File Drawers	STB8-3LF-3041-24-LOCK	2094	2239	2384	30	24	41	281
	STB8-3LF-3641-24-LOCK	2094	2239	2384	36	24	41	293

Specify Pull number.

4 Lateral File Drawers	STB8-4LF-3053-24-LOCK	2426	2571	2716	30	24	53	288
	STB8-4LF-3653-24-LOCK	2426	2571	2716	36	24	53	301

Specify Pull number.

Storage Towers - Bow Front Top, 65" high, Lateral File Drawers, storage above

2 Lateral Files, 65" high	STB8-2LF-3065-24-LOCK	2408	2601	2765	30	24	65	274
	STB8-2LF-3665-24-LOCK	2466	2659	2823	36	24	65	284

Specify Pull number.

3 Lateral Files, 65" high	STB8-3LF-3065-24-LOCK	2716	2909	3073	30	24	65	281
	STB8-3LF-3665-24-LOCK	2775	2968	3132	36	24	65	293

Specify Pull number.

Tower shelf finish matches case finish.

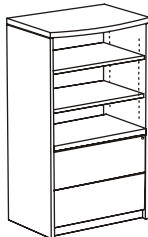

Options

Options are built-in at factory

Upper Hinged Doors: UHD
Specify Door Pull number.

Upper Glass Hinged Doors,
Aluminum Frame UGDA or
WoodPlus Frame UGW

GRV End Panel Grommet

Accessories

Order Separately

ESH Extra Shelf, WoodPlus edge
ESH Extra Shelf, Wood edge

Please specify cabinet.

For information on these and other available options and accessories, please see the end of this section.

See end of this section for pricing on all Options and Accessories

7% price increase effective January 1, 2009

Storage Towers with Lateral File drawers

Storage Towers - Bow Front Top, 72" high with Lateral File Drawers and storage above



Description	Model Number	List Prices - Laminate			Dimensions			Wgt
		Wood Edges			Wide	Deep	High	
		WoodPlus	Standard	Detailed				
2 Lateral Files, 72" high	STB8-2LF-3072-24-LOCK	2457	2650	2814	30	24	72	310
	STB8-2LF-3672-24-LOCK	2513	2706	2870	36	24	72	322

Specify Pull number.

3 Lateral Files, 72" high	STB8-3LF-3072-24-LOCK	2764	2957	3121	30	24	72	317
	STB8-3LF-3672-24-LOCK	2822	3015	3179	36	24	72	331

Specify Pull number.

4 Lateral Files, 72" high	STB8-4LF-3072-24-LOCK	3146	3339	3503	30	24	72	324
	STB8-4LF-3672-24-LOCK	3208	3401	3565	36	24	72	339

Specify Pull number.

Tower shelf finish matches case finish.

Lateral File Pull Options

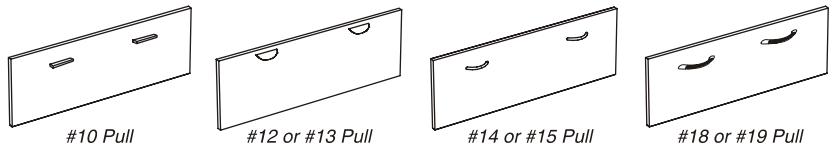

Edge Options Information

Modular 8 Tops are 1 3/4" thick, available with the following edge options:

WoodPlus (PVC)

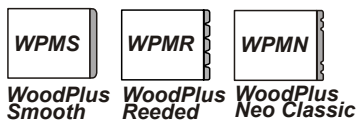

WoodPlus 3 mm PVC edge:
 WPMS - 3 mm Smooth
 WPMR - 3 mm Reeded
 WPMN - 3 mm Neo Classic

Standard Wood Edges



Standard 3 mm Wood Edge:
 SWMS - 3 mm Radius
 SWMR - 3 mm Reeded
 SWMN - 3 mm NeoClassic

Detailed Wood Edges

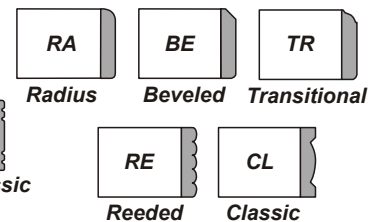

Detailed 3/8" Wood Edge:
 RA - Radiused
 BE - Beveled
 TR - Transitional
 RE - Reeded
 CL - Classic

7% price increase effective January 1, 2009

Storage Towers with Lateral File drawers

Storage Towers - Bow Front Top, 84" high with Lateral File Drawers and storage above

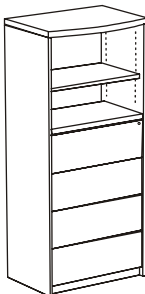
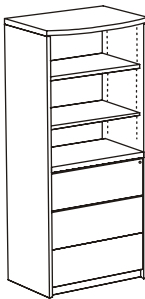
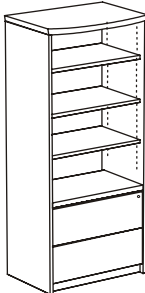
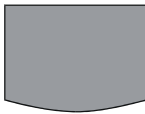

Description	Model Number	List Prices - Laminate			Dimensions			Wgt
		Wood Edges			Wide	Deep	High	
		WoodPlus	Standard	Detailed				
2 Lateral Files, 84" high	STB8-2LF-3084-24-LOCK	2574	2767	2931	30	24	84	310
	STB8-2LF-3684-24-LOCK	2639	2832	2996	36	24	84	322

Specify Pull number.

3 Lateral Files, 84" high	STB8-3LF-3084-24-LOCK	2883	3076	3240	30	24	84	317
	STB8-3LF-3684-24-LOCK	2947	3140	3304	36	24	84	331

Specify Pull number.

4 Lateral Files, 84" high	STB8-4LF-3084-24-LOCK	3193	3386	3550	30	24	84	324
	STB8-4LF-3684-24-LOCK	3256	3449	3613	36	24	84	339

Specify Pull number.

Tower shelf finish matches case finish.

Options

Options are built-in at factory

Upper Hinged Doors: UHD
Specify Door Pull number.

Upper Glass Hinged Doors,
Aluminum Frame UGDA or
WoodPlus Frame UGW

GRV End Panel Grommet

Accessories

Order Separately

ESH Extra Shelf, WoodPlus edge
ESH Extra Shelf, Wood edge

Please specify cabinet.

For information on these and other available options and accessories, please see the end of this section.

See end of this section for pricing on all Options and Accessories

7% price increase effective January 1, 2009

Storage Towers with Lateral File drawers

Options for Storage Towers with Lateral Files

Description	Model Number	List Price	Dimensions			Wgt
			Wide	Deep	High	
Add Upper Hinged Doors	OPTION-UHD Specify Door Pull number.	353				33
Lock Upper Hinged Doors	OPTION-LOCK-PAIR-DOORS	87				

DoorPull Options

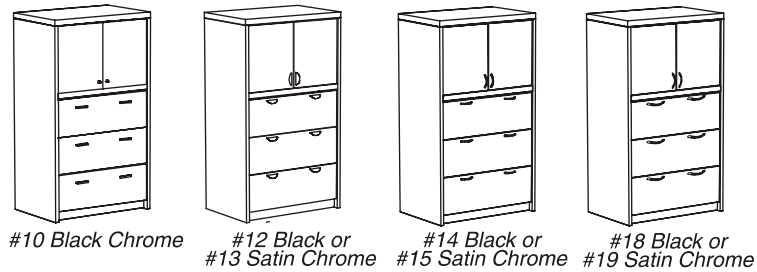

Options GDA Glass Doors with Aluminum or WoodPlus2 frames

Add Glass Doors	OPTION-UGA	791				45
	OPTION-UGW	791				45

Glass is frosted. No pulls or locks available with glass doors.
 GDA is frosted glass door with Aluminum frame.
 GDW is frosted glass door with WoodPlus2 frame.
 WoodPlus2 glass door frames are detailed to match Modular 8 details.
 Specify WP2 or XTRA WP2 finish for the door frames.
 Note that the XTRA WP2 upcharge applies when choosing an XTRA WP2 finish.
 MAGNA NOW! Glass doors NOT available on MAGNA NOW!

Glass Door illustrations

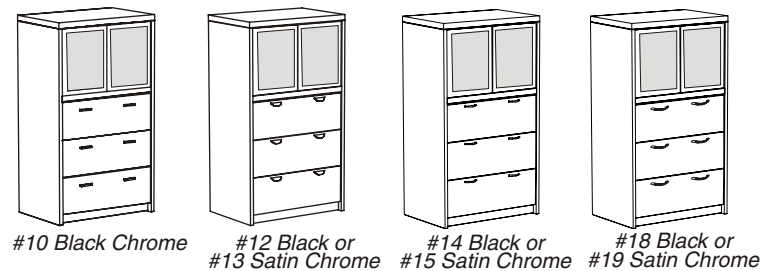

Accessories for Storage Towers

Extra adjustable shelf - any size	ESH-WPE	57				15
	ESH-STD	82				15

Tower shelves match tower vertical finish.



Tasklights	WL24	79	21	7	2	3
	WL30	86	27	7	2	3

For access to Task Light cord, please order Vertical Grommet option (GRV) in Tower.

7% price increase effective January 1, 2009

Storage Towers - Bookcases

Storage Tower Bookcases - Rectangular Top, Black Back

Description	Model Number	List Prices - Laminate			Dimensions			Wgt
		Wood Edges			Wide	Deep	High	
		WoodPlus	Standard	Detailed				
30" wide, 12" deep Black Back	ST8-BCK-3029-12	570	715	860	30	12	29	64
	ST8-BCK-3036-12	622	767	912	30	12	36	69
	ST8-BCK-3042-12	654	799	944	30	12	42	79
	ST8-BCK-3048-12	687	832	977	30	12	48	89
	ST8-BCK-3060-12	788	933	1078	30	12	60	108
	ST8-BCK-3065-12	839	984	1129	30	12	65	121
	ST8-BCK-3072-12	885	1030	1175	30	12	72	131
	ST8-BCK-3084-12	963	1108	1253	30	12	84	148
Doors NOT available; use ST8-SC cabinets. Shelf finish matches case finish.								
30" wide, 15" deep Black Back	ST8-BCK-3029-15	570	715	860	30	15	29	73
	ST8-BCK-3036-15	622	767	912	30	15	36	77
	ST8-BCK-3042-15	654	799	944	30	15	42	78
	ST8-BCK-3048-15	687	832	977	30	15	48	99
	ST8-BCK-3060-15	788	933	1078	30	15	60	151
	ST8-BCK-3065-15	839	984	1129	30	15	65	139
	ST8-BCK-3072-15	885	1030	1175	30	15	72	150
	ST8-BCK-3084-15	963	1108	1253	30	15	84	170
Doors NOT available; use ST8-SC cabinets. Shelf finish matches case finish.								
36" wide, 12" deep Black Back	ST8-BCK-3629-12	570	715	860	36	12	29	70
	ST8-BCK-3636-12	622	767	912	36	12	36	77
	ST8-BCK-3642-12	654	799	944	36	12	42	88
	ST8-BCK-3648-12	687	832	977	36	12	48	96
	ST8-BCK-3660-12	788	933	1078	36	12	60	120
	ST8-BCK-3665-12	857	1002	1147	36	12	65	134
	ST8-BCK-3672-12	903	1048	1193	36	12	72	145
	ST8-BCK-3684-12	981	1126	1271	36	12	84	164
Doors NOT available; use ST8-SC cabinets. Shelf finish matches case finish.								
36" wide, 15" deep Black Back	ST8-BCK-3629-15	570	715	860	36	15	29	81
	ST8-BCK-3636-15	622	767	912	36	15	36	86
	ST8-BCK-3642-15	654	799	944	36	15	42	99
	ST8-BCK-3648-15	687	832	977	36	15	48	110
	ST8-BCK-3660-15	788	933	1078	36	15	60	168
	ST8-BCK-3665-15	857	1002	1147	36	15	65	154
	ST8-BCK-3672-15	903	1048	1193	36	15	72	167
	ST8-BCK-3684-15	981	1126	1271	36	15	84	189
Doors NOT available; use ST8-SC cabinets. Shelf finish matches case finish.								

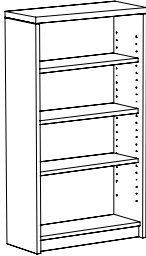

NOTES:
Shelf depth on 12" deep units is 10-1/2".
Shelf depth on 15" deep units is 13-1/2".
Weight limit is 100 lb. per shelf.
Shelves are adjustable on 2" increments.

Please Note:
29" high units will not accommodate two rows of binders.

Options
Options are built-in at factory
GRV End Panel Grommet

Accessories
Order Separately
ESHExtra Shelf, WoodPlus edge
ESHExtra Shelf, Wood edge
Please specify cabinet.

For information on these and other available options and accessories, please see the end of this section.

See end of this section for pricing on all Options and Accessories

Storage Towers

7% price increase effective January 1, 2009

Storage Towers - Bookcases

Storage Tower Bookcases - Rectangular Top, 3/4" Finished Back

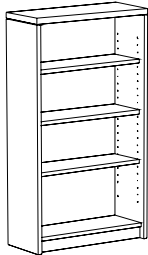

IMPORTANT:
Number of
Adjustable
shelves:
29" high = 1
36" high = 1
42" high = 2
48" high = 2
60" high = 3
65" high = 3
72" high = 4
84" high = 5

Please Note:
29" high units
will not
accommodate
two rows of
binders.

Description	Model Number	List Prices - Laminate			Dimensions			Wgt
		Wood Edges			Wide	Deep	High	
		WoodPlus	Standard	Detailed				
30" wide, 12" deep, Finished Back	ST8-BCB-3029-12	719	864	1009	30	12	29	77
	ST8-BCB-3036-12	783	928	1073	30	12	36	86
	ST8-BCB-3042-12	824	969	1114	30	12	42	94
	ST8-BCB-3048-12	868	1013	1158	30	12	48	109
	ST8-BCB-3060-12	996	1141	1286	30	12	60	135
	ST8-BCB-3065-12	1058	1203	1348	30	12	65	179
	ST8-BCB-3072-12	1104	1249	1394	30	12	72	177
	ST8-BCB-3084-12	1208	1353	1498	30	12	84	185
Doors NOT available; use ST8-SC cabinets. Shelf finish matches case finish.								
30" wide, 15" deep, Finished Back	ST8-BCB-3029-15	719	864	1009	30	15	29	89
	ST8-BCB-3036-15	783	928	1073	30	15	36	98
	ST8-BCB-3042-15	824	969	1114	30	15	42	108
	ST8-BCB-3048-15	868	1013	1158	30	15	48	125
	ST8-BCB-3060-15	996	1141	1286	30	15	60	156
	ST8-BCB-3065-15	1058	1203	1348	30	15	65	179
	ST8-BCB-3072-15	1104	1249	1394	30	15	72	203
	ST8-BCB-3084-15	1208	1353	1498	30	15	84	212
Doors NOT available; use ST8-SC cabinets. Shelf finish matches case finish.								
36" wide, 12" deep, Finished Back	ST8-BCB-3629-12	719	864	1009	36	12	29	86
	ST8-BCB-3636-12	783	928	1073	36	12	36	95
	ST8-BCB-3642-12	824	969	1114	36	12	42	104
	ST8-BCB-3648-12	868	1013	1158	36	12	48	121
	ST8-BCB-3660-12	996	1141	1286	36	12	60	150
	ST8-BCB-3665-12	1091	1236	1381	36	12	65	173
	ST8-BCB-3672-12	1137	1282	1427	36	12	72	197
	ST8-BCB-3684-12	1245	1390	1535	36	12	84	205
Doors NOT available; use ST8-SC cabinets. Shelf finish matches case finish.								
36" wide, 15" deep, Finished Back	ST8-BCB-3629-15	719	864	1009	36	15	29	99
	ST8-BCB-3636-15	783	928	1073	36	15	36	109
	ST8-BCB-3642-15	824	969	1114	36	15	42	120
	ST8-BCB-3648-15	868	1013	1158	36	15	48	139
	ST8-BCB-3660-15	996	1141	1286	36	15	60	173
	ST8-BCB-3665-15	1091	1236	1381	36	15	65	199
	ST8-BCB-3672-15	1137	1282	1427	36	15	72	226
	ST8-BCB-3684-15	1245	1390	1535	36	15	84	236
Doors NOT available; use ST8-SC cabinets. Shelf finish matches case finish.								

Edge Options Information

Modular 8 Tops are 1 3/4" thick, available with the following edge options:

WoodPlus (PVC)

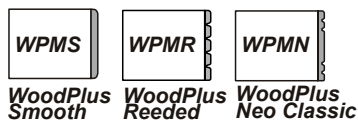

WoodPlus 3 mm PVC edge:
WPMS - 3 mm Smooth
WPMR - 3 mm Reeded
WPMN - 3 mm Neo Classic

Standard Wood Edges

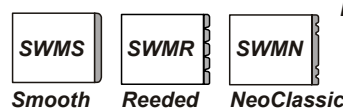

Standard 3 mm Wood Edge:
SWMS - 3 mm Radius
SWMR - 3 mm Reeded
SWMN - 3 mm NeoClassic

Detailed Wood Edges

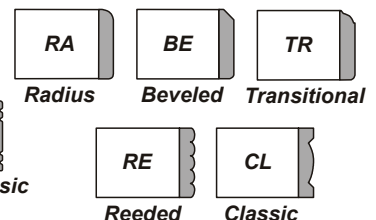

Detailed 3/8" Wood Edge:
RA - Radiused RE - Reeded
BE - Beveled CL - Classic
TR - Transitional

7% price increase effective January 1, 2009

Storage Towers - Bookcases

Storage Tower Bookcases - Bow Front Top, Black Back

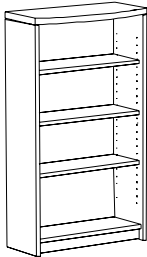

NOTES:
Shelf depth on 12" deep units is 10-1/2".
Shelf depth on 15" deep units is 13-1/2".
Weight limit is 100 lb. per shelf.
Shelves are adjustable on 2" increments.

Please Note:
29" high units will not accommodate two rows of binders.

Description	Model Number	List Prices - Laminated Wood Edges			Dimensions			Wgt
		WoodPlus	Standard	Detailed	Wide	Deep	High	
30" wide, 12" deep Black Back	STB8-BCK-3029-12	748	893	1038	30	12	29	77
	STB8-BCK-3036-12	661	806	951	30	12	36	86
	STB8-BCK-3042-12	702	847	992	30	12	42	94
	STB8-BCK-3048-12	743	888	1033	30	12	48	109
	STB8-BCK-3060-12	862	1007	1152	30	12	60	135
	STB8-BCK-3065-12	924	1069	1214	30	12	65	179
	STB8-BCK-3072-12	968	1113	1258	30	12	72	177
	STB8-BCK-3084-12	1047	1192	1337	30	12	84	185
Doors NOT available; use STB8-SC cabinets. Shelf finish matches case finish.								
30" wide, 15" deep Black Back	STB8-BCK-3029-15	748	893	1038	30	15	29	73
	STB8-BCK-3036-15	661	806	951	30	15	36	77
	STB8-BCK-3042-15	702	847	992	30	15	42	78
	STB8-BCK-3048-15	743	888	1033	30	15	48	99
	STB8-BCK-3060-15	862	1007	1152	30	15	60	121
	STB8-BCK-3065-15	924	1069	1214	30	15	65	139
	STB8-BCK-3072-15	968	1113	1258	30	15	72	150
	STB8-BCK-3084-15	1047	1192	1337	30	15	84	170
Doors NOT available; use STB8-SC cabinets. Shelf finish matches case finish.								
36" wide, 12" deep Black Back	STB8-BCK-3629-12	748	893	1038	36	12	29	86
	STB8-BCK-3636-12	661	806	951	36	12	36	95
	STB8-BCK-3642-12	702	847	992	36	12	42	104
	STB8-BCK-3648-12	743	888	1033	36	12	48	121
	STB8-BCK-3660-12	862	1007	1152	36	12	60	150
	STB8-BCK-3665-12	939	1084	1229	36	12	65	173
	STB8-BCK-3672-12	985	1130	1275	36	12	72	197
	STB8-BCK-3684-12	1065	1210	1355	36	12	84	205
Doors NOT available; use STB8-SC cabinets. Shelf finish matches case finish.								
36" wide, 15" deep Black Back	STB8-BCK-3629-15	748	893	1038	36	15	29	81
	STB8-BCK-3636-15	661	806	951	36	15	36	86
	STB8-BCK-3642-15	702	847	992	36	15	42	99
	STB8-BCK-3648-15	743	888	1033	36	15	48	110
	STB8-BCK-3660-15	862	1007	1152	36	15	60	168
	STB8-BCK-3665-15	939	1084	1229	36	15	65	154
	STB8-BCK-3672-15	985	1130	1275	36	15	72	167
	STB8-BCK-3684-15	1065	1210	1355	36	15	84	189
Doors NOT available; use STB8-SC cabinets. Shelf finish matches case finish.								

Options
Options are built-in at factory
GRV End Panel Grommet

Accessories
Order Separately
ESHExtra Shelf, WoodPlus edge
ESHExtra Shelf, Wood edge
Please specify cabinet.

For information on these and other available options and accessories, please see the end of this section.

See end of this section for pricing on all Options and Accessories

Storage Towers

7% price increase effective January 1, 2009

Storage Towers - Bookcases

Storage Tower Bookcases - Bow Front Top, 3/4" Finished Back

Description	Model Number	List Prices - Laminate			Dimensions			Wgt
		Wood Edges			Wide	Deep	High	
		WoodPlus	Standard	Detailed				
30" wide, 12" deep, Finished Back	STB8-BCB-3029-12	910	1055	1200	30	12	29	77
	STB8-BCB-3036-12	822	967	1112	30	12	36	86
	STB8-BCB-3042-12	872	1017	1162	30	12	42	94
	STB8-BCB-3048-12	921	1066	1211	30	12	48	109
	STB8-BCB-3060-12	1068	1213	1358	30	12	60	135
	STB8-BCB-3065-12	1141	1286	1431	30	12	65	179
	STB8-BCB-3072-12	1187	1332	1477	30	12	72	177
	STB8-BCB-3084-12	1291	1436	1581	30	12	84	184
Doors NOT available; use STB8-SC cabinets. Shelf finish matches case finish.								
30" wide, 15" deep, Finished Back	STB8-BCB-3029-15	910	1055	1200	30	15	29	89
	STB8-BCB-3036-15	822	967	1112	30	15	36	98
	STB8-BCB-3042-15	872	1017	1162	30	15	42	108
	STB8-BCB-3048-15	921	1066	1211	30	15	48	125
	STB8-BCB-3060-15	1068	1213	1358	30	15	60	156
	STB8-BCB-3065-15	1141	1286	1431	30	15	65	179
	STB8-BCB-3072-15	1187	1332	1477	30	15	72	203
	STB8-BCB-3084-15	1291	1436	1581	30	15	84	212
Doors NOT available; use STB8-SC cabinets. Shelf finish matches case finish.								
36" wide, 12" deep, Finished Back	STB8-BCB-3629-12	910	1055	1200	36	12	29	86
	STB8-BCB-3636-12	822	967	1112	36	12	36	95
	STB8-BCB-3642-12	872	1017	1162	36	12	42	104
	STB8-BCB-3648-12	921	1066	1211	36	12	48	121
	STB8-BCB-3660-12	1068	1213	1358	36	12	60	150
	STB8-BCB-3665-12	1173	1318	1463	36	12	65	173
	STB8-BCB-3672-12	1220	1365	1510	36	12	72	197
	STB8-BCB-3684-12	1329	1474	1619	36	12	84	205
Doors NOT available; use STB8-SC cabinets. Shelf finish matches case finish.								
36" wide, 15" deep, Finished Back	STB8-BCB-3629-15	910	1055	1200	36	15	29	99
	STB8-BCB-3636-15	822	967	1112	36	15	36	109
	STB8-BCB-3642-15	872	1017	1162	36	15	42	120
	STB8-BCB-3648-15	921	1066	1211	36	15	48	139
	STB8-BCB-3660-15	1068	1213	1358	36	15	60	173
	STB8-BCB-3665-15	1173	1318	1463	36	15	65	199
	STB8-BCB-3672-15	1220	1365	1510	36	15	72	226
	STB8-BCB-3684-15	1329	1474	1619	36	15	84	236
Doors NOT available; use STB8-SC cabinets. Shelf finish matches case finish.								

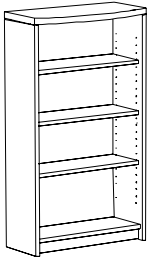

IMPORTANT:
Number of Adjustable shelves:
29" high = 1
36" high = 1
42" high = 2
48" high = 2
60" high = 3
65" high = 3
72" high = 4
84" high = 5

Please Note:
29" high units will not accommodate two rows of binders.

Storage Towers

Edge Options Information

Modular 8" Tops are 1 3/4" thick, available with the following edge options:

WoodPlus (PVC)

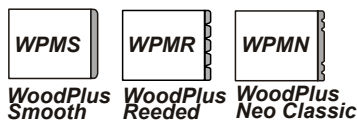

WoodPlus 3 mm PVC edge:
WPMS - 3 mm Smooth
WPMR - 3 mm Reeded
WPMN - 3 mm Neo Classic

Standard Wood Edges



Standard 3 mm Wood Edge:
SWMS - 3 mm Radius
SWMR - 3 mm Reeded
SWMN - 3 mm NeoClassic

Detailed Wood Edges

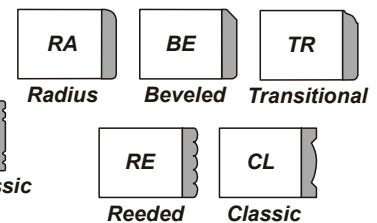

Detailed 3/8" Wood Edge:
RA - Radiused
BE - Beveled
TR - Transitional
RE - Reeded
CL - Classic

7% price increase effective January 1, 2009

Storage Towers, Audio-Video

Overview - Storage Towers - Audio-Video

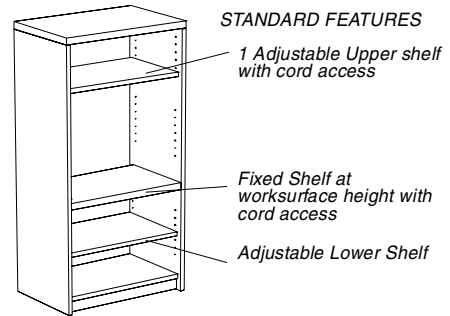
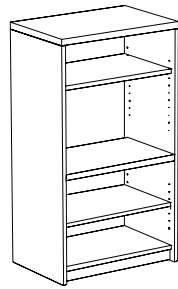

AV Storage, 72" High
30" or 36" wide, 24" deep

Storage Towers - Rectangular Top, Audio Video, see Pg 150

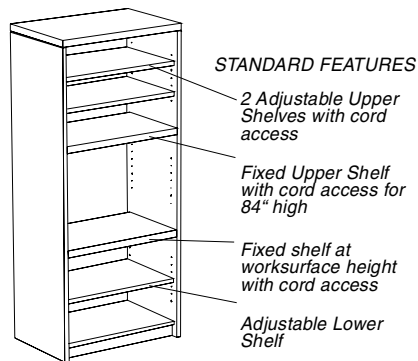

AV Storage, 84" High
30" or 36" wide, 24" deep

All Video Towers are supplied with a Vertical Grommet in back, located below the fixed work surface.

Door Options

Upper Door Options:

- UPD Upper Pocket Doors
- UHD Upper Hinged Doors
- GDW Glass with WoodPlus2 Frame
- GDA Glass with Aluminum frame

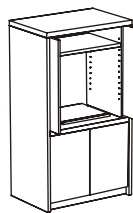

UPD

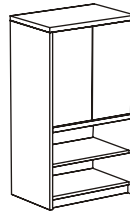

UHD
165° hinges

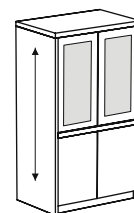

GDW
165° hinges

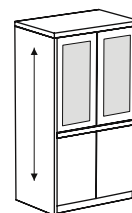

GDA
165° hinges

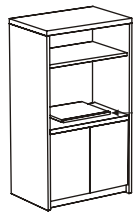

LHD

LHD
Lower Hinged Doors

TVT

7% price increase effective January 1, 2009

Storage Towers, Audio-Video

Storage Towers - Rectangular Top, Audio Video

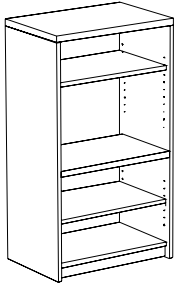

Description	Model Number	List Prices - Laminate			Dimensions			Wgt
		Wood Edges			Wide	Deep	High	
		WoodPlus	Standard	Detailed				
Audio Video Cabinet, 65" high, 24" deep	STV8-3065-24	1334	1527	1691	30	24	65	276
	STV8-3665-24	1392	1585	1749	36	24	65	301
72" high	STV8-3072-24	1383	1576	1740	30	24	72	312
	STV8-3672-24	1439	1632	1796	36	24	72	339
84" high	STV8-3084-24	1500	1693	1857	30	24	84	312
	STV8-3684-24	1565	1758	1922	36	24	84	339

Shelf finish matches case finish.

Storage Towers - Bow Front Top, Audio Video

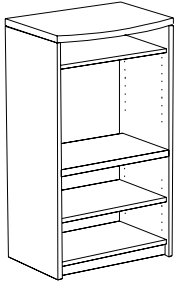
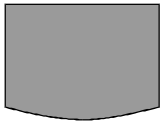

Description	Model Number	List Prices - Laminate			Dimensions			Wgt
		Wood Edges			Wide	Deep	High	
		WoodPlus	Standard	Detailed				
65" high, Audio Video Cabinet, 24" deep	STVB8-3065-24	1428	1621	1785	30	24	65	276
	STVB8-3665-24	1488	1681	1845	36	24	65	301
72" high	STVB8-3072-24	1477	1670	1834	30	24	72	312
	STVB8-3672-24	1534	1727	1891	36	24	72	339
84" high	STVB8-3084-24	1596	1789	1953	30	24	84	312
	STVB8-3684-24	1661	1854	2018	36	24	84	339

Shelf finish matches case finish.

Edge Options Information

Modular 8 Tops are 1 3/4" thick, available with the following edge options:

WoodPlus (PVC)

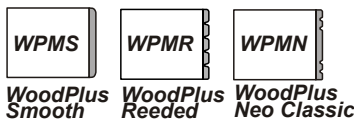

WoodPlus 3 mm PVC edge:
 WPMS - 3 mm Smooth
 WPMR - 3 mm Reeded
 WPMN - 3 mm Neo Classic

Standard Wood Edges

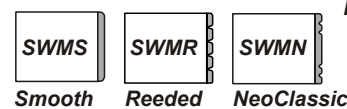

Standard 3 mm Wood Edge:
 SWMS - 3 mm Radius
 SWMR - 3 mm Reeded
 SWMN - 3 mm NeoClassic

Detailed Wood Edges

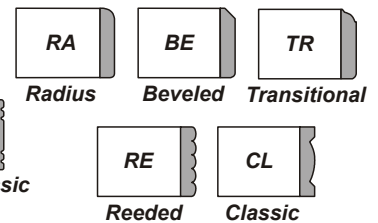

Detailed 3/8" Wood Edge:
 RA - Radius
 BE - Beveled
 TR - Transitional
 RE - Reeded
 CL - Classic

7% price increase effective January 1, 2009

Storage Towers, Audio-Video

Options for Video Towers

Description	Model Number	List Price	Dimensions			Wgt
			Wide	Deep	High	
Vertical Grommet	OPTION-GRV	48	2.75	0	4.25	
Grommet opening: 2.00" X 3.50" One Grommet is included on Video Towers - located in center back, below the fixed worksurface.						

Locks for Doors	OPTION-LOCK-PAIR-DOORS	87				
------------------------	------------------------	-----------	--	--	--	--

Upper Pocket Doors	OPTION-UPD	1001				89
Pocket Doors slide into cabinet when open, and are full height from top of fixed worksurface to top of cabinet. Specify Pull number.						

Upper Hinged Doors	OPTION-UHD	353				33
Upper Hinged Doors use 165 degree hinges and extend from top of fixed worksurface to top of cabinet. Specify Pull number.						

Glass Doors WoodPlus2 frame	OPTION-UGW	791				45
WoodPlus2 glass door frames are detailed to match Modular 8 details. Glass is frosted. No pulls or locks available with glass doors. Specify WP2 or XTRA WP2 finish for the door frames. Note that the XTRA WP2 upcharge applies when choosing an XTRA WP2 finish.						

Glass Doors Aluminum frame	OPTION-UGA	791				45
Glass Doors use 165 degree hinges and extend from top of fixed worksurface to top of cabinet. No pulls or lock available. MAGNA NOW! Glass Doors are NOT available on MAGNA NOW!						

Lower Hinged Doors	OPTION-LHD	353				25
Lower Hinged Doors use 105 degree hinges. Specify Pull number.						

Upper and Lower Door Pull Options and Locations

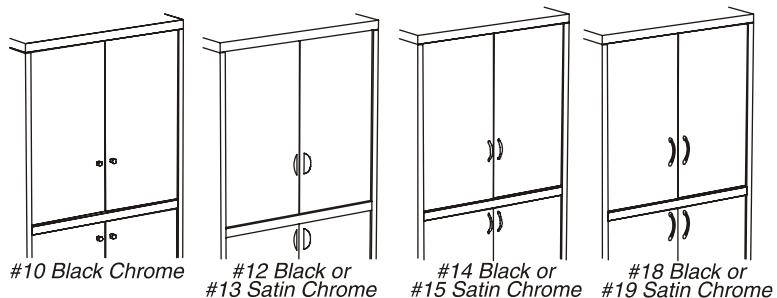

7% price increase effective January 1, 2009

Storage Towers, Audio-Video

Accessories for Video Storage Towers

Description	Model Number	List Price	Dimensions			Wgt
			Wide	Deep	High	
Extra adjustable Shelves - any size	ESH-WPE	57				15
	ESH-STD	82				15

Tower shelves match tower vertical finish.

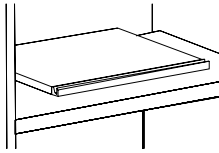

Extends 11-1/2"
Swivels 180°
Load limit: 200 lb.

TV Tray	Model Number	List Price	Wide	Deep	High	Wgt
	TVT-30-WS	592	15	18	0.75	25
	TVT-36-WS	592	20	18	0.75	35

Finish is Black.

To order as an Accessory, use model number TVT-30 for 30" wide towers and TVT-36 for 36" wide towers.

To order as an Option, specify location:

1. For worksurface location (for any height Tower) add "TVT-WS" to end of model number.
2. For upper fixed shelf location for 84" high Towers add "TVT-SH" to end of model number.

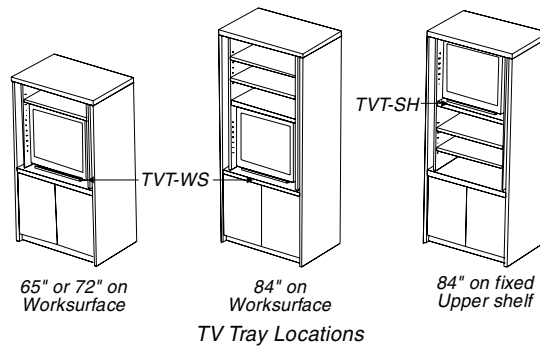

Clearance for TV

Cabinet Width	Open - No Doors			Hinged or Pocket Doors		
	W	H	D	W	H	D
30"	27-3/4	23-5/8*	22	22-1/4	23-5/8*	21-1/8
36"	33-3/4	23-5/8*	22	28-1/4	23-5/8*	21-1/8

*with TVT Tray - 25-3/8 without TVT

7% price increase effective January 1, 2009

Mobile Units

Overview - Mobile Units, Pedestals

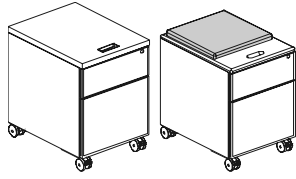

Mobile Pedestals, see Pg 154

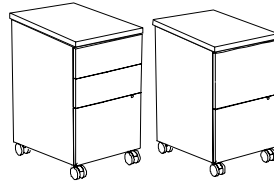

Mobile Pedestals, see Pg 154

Overview - Mobile Units, Laptop Storage

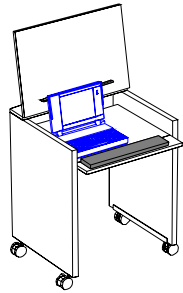

Overview - Mobile Units, Cabinets

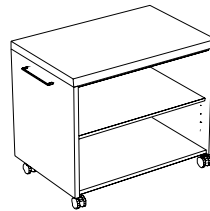
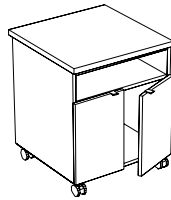

Mobile Coffee and Storage Carts, see Pg 155

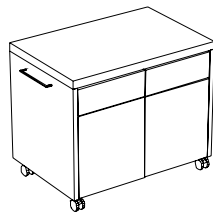
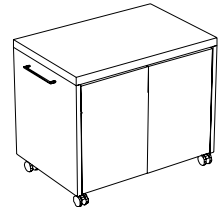

Mobile Projection Stand Carts, see Pg 155

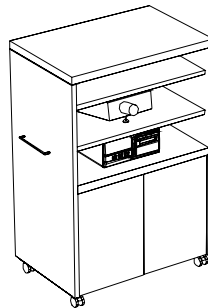

Mobile Projection Stand Carts, see Pg 155

7% price increase effective January 1, 2009

Mobile Units

Mobile Pedestals

Description	Model Number	Dimensions			Wgt	List Prices		
		Wide	Deep	High		Wood Edges		
					WoodPlus	Standard	Detailed	
Mobile 3/4 Pedestal	M8-PM-BF-LOCK	16	24	27	75	1101	1101	1101
	Option M8-PM-Cushion	24	16		5	88	88	88

M8-PM Box / File Pedestal with lock, on casters, may be stored underneath a worktop. Please specify pull number.
Optional Black vinyl cushion maybe ordered for the top of pedestal case.

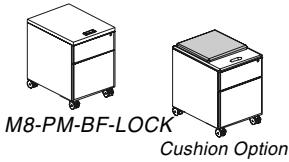

Mobile Docking Pedestals	M8-PD-DB-LOCK	16	24	29	82	1280	1280	1280
	M8-PD-DF-LOCK	16	24	29	82	1280	1280	1280

M8-PD-DB Box/Box/File pedestal with lock, on casters, includes a worktop, 16w x 24d.
M8-PD-DF File/File pedestal with lock, on casters, includes a worktop 16w x 24d. Please specify pull number.
The M8-PD pedestal can be 'docked' next to a worktop to extend the worktop surface.

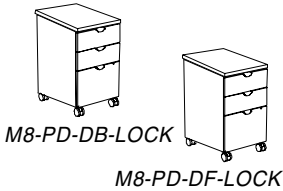

Mobile Laptop Storage	CRM-MLS	24	21	30	68	1181	1181	1181
------------------------------	---------	----	----	----	----	-------------	------	------

Includes lock.

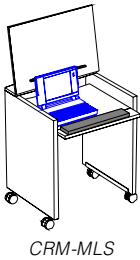

Mobile Printer Cabinet

Printer Cabinet	CRM-2424-29-PC	24	24	30	112	1463	1608	1753
------------------------	----------------	----	----	----	-----	-------------	------	------

Open shelf with hinged doors below. Specify pull number for hinged doors.

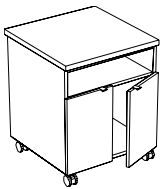

Drawer and Door Pull Options

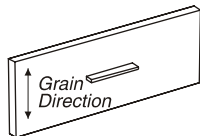

#10 Pulls are an applied metal pull: finish is Black Chrome

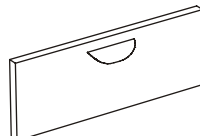

#12 and #13 Pulls are an applied metal pull: #12 finish is Black; #13 is Satin Chrome

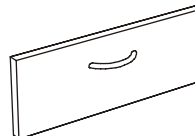

#14 and #15 Pulls are an applied metal pull: #14 finish is Black; #15 is Satin Chrome

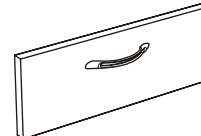

#18 and #19 Pulls are an applied metal pull: #18 finish is Black; #19 is Satin Chrome

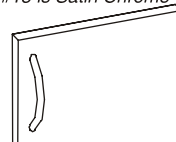
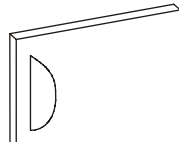
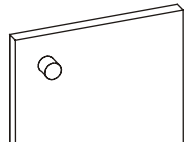

7% price increase effective January 1, 2009

Mobile Units

Mobile Coffee and Storage Carts

Description	Model Number	Dimensions			Wgt	List Prices		
		Wide	Deep	High		Wood Edges		
						WoodPlus	Standard	Detailed
30" wide, 30" high	CRM-2430-29-O	30	24	30	127	1071	1216	1361
	CRM-2430-29-D	30	24	30	127	1463	1608	1753
	CRM-2430-29-BD	30	24	30	127	1758	1903	2048

Specify side pull finish as black or silver.

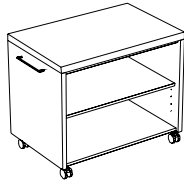

CRM-2436-30-0

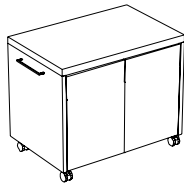

CRM-2436-30-D

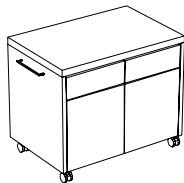

CRM-2436-30-BD

36" wide, 30" high	CRM-2436-29-O	36	24	30	142	1071	1216	1361
	CRM-2436-29-D	36	24	30	142	1463	1608	1753
	CRM-2436-29-BD	36	24	30	142	1758	1903	2048

Specify pull number for doors.

Side pull finish matches the finish on the doors.

Mobile Projection Stand Carts

54" high	CRM-2430-54-PROJ	30	24	54	134	2116	2261	2406
	CRM-2436-54-PROJ	36	24	54	149	2180	2325	2470
65" high	CRM-2430-65-PROJ	30	24	65	134	2171	2364	2528
	CRM-2436-65-PROJ	36	24	65	149	2235	2428	2592

Specify pull number lower hinged doors.

Side pull finish matches the finish on the doors

Specify pull number lower hinged doors.

Side pull finish matches the finish on the doors

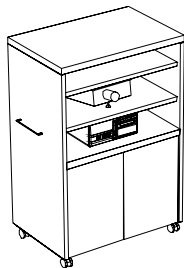

Notes:

- Mobile units are equipped with two Locking casters.

Options

Options are built-in at factory

- L Lock for Single Door
- L Lock for Pair of Doors
- L Lock for two Pair of Doors
- L Lock for Pedestal

INLAY -available ONLY with Detailed edge

INP Black 3mm (1/8") Inlay:
Rectangular tops

INB Brushed Brass 3mm Inlay or
INC Satin Chrome 3mm Inlay:
Rectangular tops

Accessories

Order Separately

- Extra Shelves
- ESH Laminate WPE
- ESH Laminate Wood edge

For information on these and other available options and accessories, as well as for pricing, please see the end of this section.

7% price increase effective January 1, 2009

Mobile Unit - Options and Accessories

Mobile Cabinet Options

Description	Model Number	Dimensions			Wgt	List Price
		Wide	Deep	High		
Grommets	GR	4.25	2.75			48



GR=Grommet with cover. Opening: 2 x 3.5

Grommet location is at left rear corner.

Inserts for grommets	WHT-INSERT	4.25	2.75	5	1	148
	DVR-INSERT	4.25	2.75	5	1	67
	PDC-INSERT	4.25	2.75	5	1	139

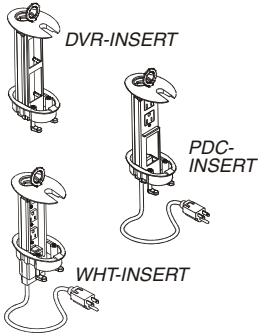

WHT fits into an existing GR grommet; GR must be ordered separately.

WHT is a work surface pop-up with three outlets and is provided with a 6 foot, 15 amp cord. Pull-up size: 2 x 3.5 x 5-1/8" high when extended.

Finish is satin Black.

DVR fits into an existing GR grommet; GR must be ordered separately.

DVR is a work surface pop-up that accepts various receptacle plates to be supplied by your electrical contractor or supplier.

DVR does not include any receptacles or receptacle plates.

Pull-up size: 2 x 3.5 x 5-1/8" high when extended.

Finish is satin Black.

PDC fits into an existing GR grommet; GR must be ordered separately.

PDC is a work surface pop-up with two outlets and it accepts one receptacle plate to be supplied by your electrical contractor or supplier.

PDC does not include any receptacles or receptacle plates.

Pull-up size: 2 x 3.5 x 5-1/8" high when extended.

Finish is satin Black.

Vertical Grommets	OPTION-GRV	2.75	0	4.25	0	48
--------------------------	------------	------	---	------	---	-----------

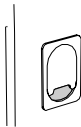

Specify Location as Left (side panel), Right (side panel) or Back.

Wiremanager with Data Bezel	CRM Data-Electrical				2	126
------------------------------------	---------------------	--	--	--	---	------------

Wiremanager supplied with bezel and blank inserts. Data and /or Voice inserts to be supplied by electrical contractor. Includes power strip with 6 grounded outlets, reset-able overload circuit breaker, and 6' cord with plug.

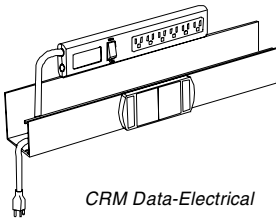

CRM Data-Electrical

Door Locks	LOCK-DOORS					87
-------------------	------------	--	--	--	--	-----------

Mobile Cabinet Accessories

Additional Shelves	ESH-WPE					57
	ESH-STD					82

7% price increase effective January 1, 2009

Conference & Meeting Products - Index

Code	Description	Page	Code	Description	Page
A					
Accent	Base accent, silver or black	51, 90			
Accent	METRO base accent	57			
Accent	Conference table top accent	57			
ACE	ACT Table overview of table shapes	20			
	ACT Table plan view of table tops	21			
	Duplex and Insert layouts	22 - 23 - 24			
	ACT table monument locations	25 to 31			
B					
Base	ACT table monument locations	25 to 31			
Base	Distance between conference table bases	58			
BHD	Base Hinged Door	51, 57, 90			
BE	Bow End option, Tables	50, 87			
BEZEL	add Bezel cutout to ACT table	53			
C					
C3R	3" radius corners on table top	50, 87, 110			
Cable Cubby 300C		88, 109, 114			
CENTER	ACT power entry moved to center base	51			
CLAM	ACT table 'CLAM'	51			
CLAM	Conference table 'CLAM'	90			
CMR	Mobile Units	153			
CPU	CPU storage in table base	52			
CRL	Lecterns	119			
CRL-MF	Multimedia lecterns, flat top	120			
CRL-MS	Multimedia lecterns, sloped top	121			
CRM	Mobile units	153			
CUBE	Cube Tables	136			
Credenzas					
Overview		123			
CRC-TOP	in M8, EQ, S50, WP2	124 to 130			
CRC-CAB	in M8, EQ, S50, WP2	125 to 131			
TRI-BASE	Credenza with TRI base	132			
	Credenza top between towers	134			
D					
DRUM	Drum Tables	136			
DRW	Display rails, wall mounted	117			
DVR	DVR-INSERT	88, 109, 114, 119			
E					
Rack	Add equipment rack to table base	52			
ESH	Extra Adjustable Shelves	144, 152, 156			
F					
Finishes		18			
Flat Screen storage in ACT table		50			
Freight surcharge		7			
Fuel surcharge		7			
G					
Grommet locations in conference tables		88			
GR	Grommet in top	88, 109, 114, 119			
GRV	Grommet, Vertical,	109, 144, 151			
I					
INLAY	Inlay for Tables	50, 87, 99, 109			
INSERT	Inserts for ACT tables	53			
INSERT	for MINI-ACTS, MINIPORTS, INTERPORTS	57			
INSERT	DVR-INSERT	88, 109, 114, 119			
INSERT	PDC-INSERT	88, 109, 114, 119			
INSERT	WHT-INSERT	88, 109, 114, 119			
INTERPORT		88, 109, 114, 119			
L					
Warranty, Lifetime		7			
Layout guide and room size		14			
L	Lock	119, 116, 144, 151			
M					
NOW!	Magna NOW! tables ship in 10 days	3			
M8-PD	Mobile Docking Pedestals	154			
M8-PM	3/4 high Mobile Pedestal	154			
MB	Marker Board	118			
METRO BASE ACCENT		57			
MJT	Wiremanager	99			
MINIACT	power and data inserts	57			
MINIPORT		88, 109, 114			
MUT	Mobile Utility table	35, 68, 108			
MWB	Mobile White Board	117			
N					
NOW!	Magna NOW! tables ship in 10 days	3			
NU	notches in table bases	51, 90			
P					
PDB	Presentation Display Board	116			
PDBM	Presentation Display, Magnetic	116			
PDC	PDC-INSERT	88, 109, 114, 119			
Polycom	Polycom storage in table base	53			
Planning Guide		9			
Pricing and Delivery		7			
PSV	Projection Valance	115			
R					
Rack	Add equipment rack to table base	52			
RC	Radius Corner option, Tables	50, 87			
RMN	Table wiremanager	90, 99			
Room size and Layout guide		14			
S					
Seating Capacity		12			
SLIDE	Slide table	86, 108			
Spec	Quick spec guide	4			
Specifications, ACT and Kaizen tables, WP		15			
Specifications, ACT tables, WP2		17			
Specifications, Conference tables, WP		15			
Specifications, Conference tables, WP2		17			
ST8...LF	Storage tower with lateral file drawers	137			
ST8...BC	Bookcases	145			
STV	Video towers	149			

7% price increase effective January 1, 2009

Conference & Meeting Products - Index

Code	Description	Page	Code	Description	Page
Storage Towers, rectangular tops			Tables, Modular Conference		
ST8-BC	Bookcases -----	145	Overview	-----	91
ST8-LF	Storage Tower, Lateral Files -----	137	MT-101 through MT-105 configurations	-----	92 to 96
Doors	-----	144	SECTIONS for modular conference tables	-----	97
Storage Towers, Bow Front tops			MT-TT, MT-TZ, MT-THL, MT-THR, MT-SC, MT-SA		
STB8-BC	Storage Tower Bookcases -----	141	FILLERS for modular conference tables	-----	98
STB8-LF	Storage Tower, Lateral Files -----	141	MT-FC, MT-FA		
Doors	-----	144	MT-KP	Kneespace protectors -----	99
Video Towers			WEDGE	added to table bases -----	99
STV8	Video Towers -----	149	Tables, Modular		
STVB8	Video Towers, Bow Front Tops -----	150	Overview	-----	101
Doors	-----	151	TD	Round Tables -----	102
T			THR	Half Round Tables -----	103
TOP ACCENT	-----	57	TK	Kidney Shape Table -----	104
Table edges	-----	10, 10	TQR	Quarter Round corner filler top -----	103
TC	Modular Table Top Connectors -----	110	TRAP	Trapezoid shaped top -----	104
Terms and Conditions	-----	7	TS	Square Table -----	105
TILT-N-PLUG	-----	88, 115, 119	TT	Rectangle Tables -----	105 to 107
TVT	TV Tray, Video Towers -----	151	TT CLEG	Rectangle Tables with C LEG base -----	107
Tables, ACT			MUT	Mobile Utility Table -----	108
Overview of table shapes	-----	12	SLIDE	Slide table -----	108
Plan view of table tops	-----	21	Tables, Modular Assemblies		
Duplex and Insert layout	-----	24	Overview	-----	111
Table base monument locations	-----		TMOR	Modular Table Assemblies 'O' Shape -----	112
RC, HC, CYL, RHC bases	-----	31	TMOS	Modular Table Assemblies, 'O' Shape -----	112
TRI bases	-----	29	TMR	Modular Table Assemblies, Racetrack -----	113
RCN, HCN, METRO bases	-----	27	TMT	Modular Table Assemblies, Rectangle -----	113
TAR	Arrow Table -----	36	TMTRAP	Modular Table Assemblies, Hexagonal -----	113
TB	Boat Shape Tables -----	40	INLAYS for Modular Table Assemblies	-----	114
TB-BE	Boat Bow End Table WP2 -----	48	U		
TD	Round Table -----	45	UHD	Upper Hinged Doors, Lateral File Towers ---	144
TDE	Delta Tables -----	44	UHD	Upper Hinged Doors, Video Towers -----	151
TEG	Egg Shape Table -----	44	UPD	Upper Pocket Doors, Video Towers -----	151
TEG	Egg Shape Table, WP2 -----	49	V		
TR	Racetrack Tables -----	42	V-BAY	Conference table V-Bay wiremanager-----	57
TR	Racetrack Table, WP2 -----	49	W		
TT	Rectangular Tables -----	38	Warranty, Lifetime -----	7	
TT-BE	Rectangular Tables, WP2 -----	47	WEDGE	added to table bases -----	99
TW	Wing Tables -----	46	WHT	WHT-INSERT-----	88, 109, 114, 119
ACT Table OPTIONS	-----	50	Wiremanagers	-----	57, 90, 99
Tables, Kaizen			WL	Work Lights -----	144
TKZ	Kaizen articulating ACT table -----	34	Tables, Conference		
Tables, Conference			TB	Boat Shape Tables -----	74
TB	Boat Shape Tables -----	74	TB-BE	Boat Shape Bow End Table, WP2 -----	82
TB-BE	Boat Shape Bow End Table, WP2 -----	82	TDE	Delta Shape Tables -----	79
TDE	Delta Shape Tables -----	79	TD	Round Table, WP2 -----	74
TD	Round Table, WP2 -----	74	TEG	Egg Shape Tables -----	79
TEG	Egg Shape Tables -----	79	TEG	Egg Shape Table, WP2 -----	85
TEG	Egg Shape Table, WP2 -----	85	TR	Racetrack Table, WP2 -----	83
TR	Racetrack Table, WP2 -----	83	TR	Racetrack Tables -----	3, 77
TR	Racetrack Tables -----	3, 77	TT	Rectangular Conference Tables -----	71
TT	Rectangular Conference Tables -----	71	TT-BE	Rectangular Bow End Table, WP2 -----	81
TT-BE	Rectangular Bow End Table, WP2 -----	81	TW	Wing table -----	80
TW	Wing table -----	80			