

**NOTE:** This PDF document includes interactive bookmarks, page numbers, and tabs for easy navigation.

**CLICK HERE** for more information on navigating within this PDF document.

**0%**  
PRICE INCREASE  
FOR 2009

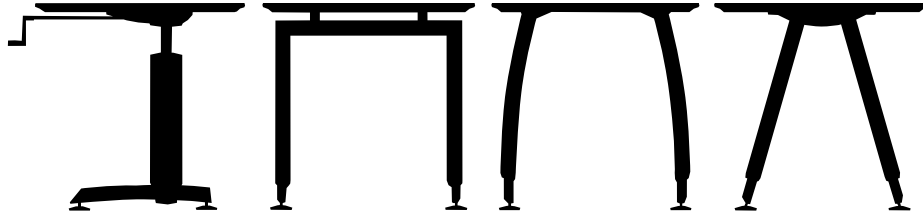

**FUSION** | THE AGILE OFFICE

**THIS PAGE INTENTIONALLY LEFT BLANK**

## CONTENTS

INTRODUCTION	130
HOW TO ORDER	132
DESKS	
Verve	134
Elliptic Group	136
Corner	138
Extension	143
Independent	145
Companion	147
Classroom	148
CONFERENCING	
Keystone	150
Elektra Series	151
Knife Series	152
STORAGE	
Moto	154
Cab	155
Sidekick	157
Cadence	161
Overdesk	169
PRIVACY	
Desk-Mounted Privacy	172
ACCESSORIES	
Seiri Screen	176
Modesty Shield	178
Cadence Floating Top	179
Storage Accessories	180
Werktools	182
Desk Accessories	183
Lighting	186
Technology Carts	187
Markerboards	188
PRODUCT INFORMATION	
Legs	190
Impulse Adjustment	192
Impulse Powerlift	193
Extension Assembly	194
Edges	195
Fusion Value	196
Keyboards	197
Grain Direction	198
Storage Products	199
Sidekick Tower	201
Keystone	202
Seiri Screen	203
Technology Carts	204
Echo Markerboard	205
MATERIALS & SPECIFICATIONS	224
TERMS & CONDITIONS	226
FINISHES	230

## THE FUSION AGILE OFFICE

*Success in any enterprise depends on the interaction of talented, energetic people. We believe office furniture should encourage this interaction by enabling the easy exchange of ideas and information. Monolithic work cells dominated by unmovable desks and hulking overhead storage can debilitate the office landscape and limit the effectiveness of the people who must work in them.*

*Our vision encompasses furniture that inspires employees and energizes the office: freestanding, user-adjustable desks; mobile storage and accessories; reconfigurable shapes and convergent surfaces united by an elegant design logic; eye-pleasing aesthetics, and always, reasonable costs.*





#### *Sidekick Towers*

*Sidekick towers free the entire work zone from overhead interference, providing leg clearance below the desk, opening new usable real estate on the primary worksurface, and dramatically improving sightlines, airflow, and lighting qualities.*

#### *Frames™*

*Watson Frames™ provide all of the advantages of traditional systems - wire and cable delivery, workspace definition, personal privacy, etc., while freeing the work environment from the burdens of panel-hung components and overhead storage. The segmented Frames™ system is best realized in collaborative heights that encourage interaction and energize the workplace. To specify Frames™ see page 209 in this document.*

#### *Freestanding Components*

*Freestanding furniture offers numerous advantages over cantilevered storage and worksurfaces, beginning with the ability to personalize fit through easy height adjustment. Rapid reconfigurability extends the value of furniture investments by anticipating evolving needs and personnel. Fusion components also offer greater stability, broader shape options, and enhanced aesthetics.*

# HOW TO ORDER

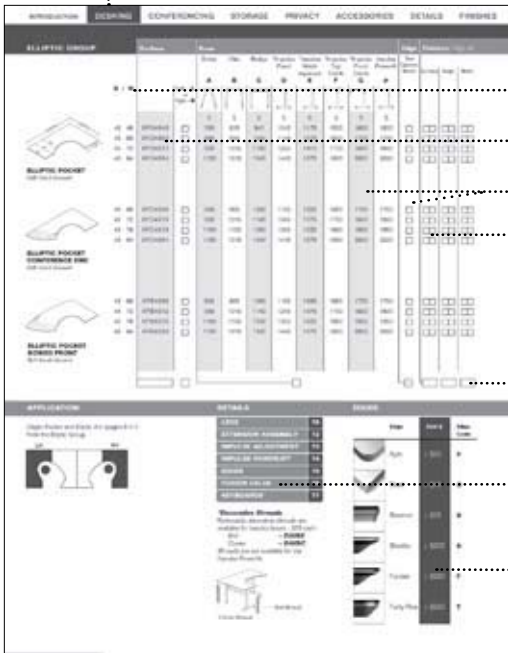

**Quick Reference Tabs**

Indicates the current section

**Product Dimensions**

**Product Code**

**Product Options**

**Finish Options**

Finish Codes found on page 230

**Product Code Indicators**

Boxes available to fill out a complete part code

**Details Tabs**

Reference pages explaining product in detail

**Part Codes and Upgrade Options**

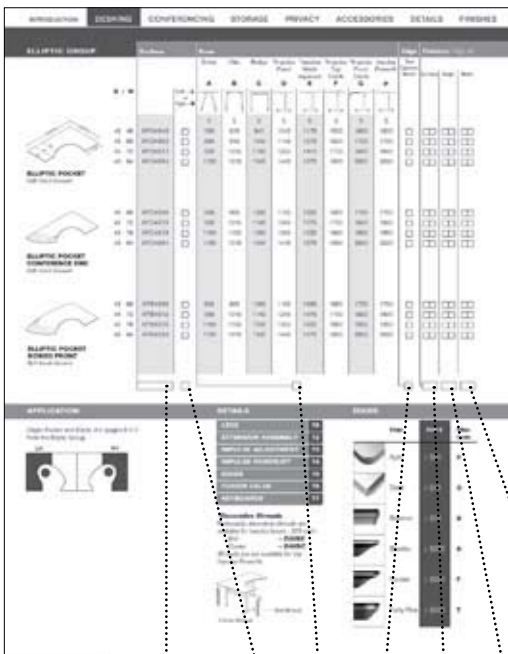

## EXAMPLES

Complete product codes are pieced together in a similar fashion throughout each section. Please note that while working from left to right across the page, additional option codes are listed on the lower half of each page, and finish codes are found on page 230.

*Note:*

Storage products are listed with three pricing options - non-contrasting (N), Contrasting (C), and Smartgrain Contrasting (A).

**Desks** XPO4872 | L | B | X | SY | CH | WA

(Elliptic Pocket)

- Surface Code
- Handedness
- Base Option
- Edge Option
- Surface Laminate
- Edge Finish
- Base Powdercoat

**Storage** CSPBF | T | J | C | GY | BK

(Single Cab)

- Product Code
- Tambour Door Option
- Pull Option
- Contrasting Finish Option
- Case Laminate
- Face Laminate

# DESKS

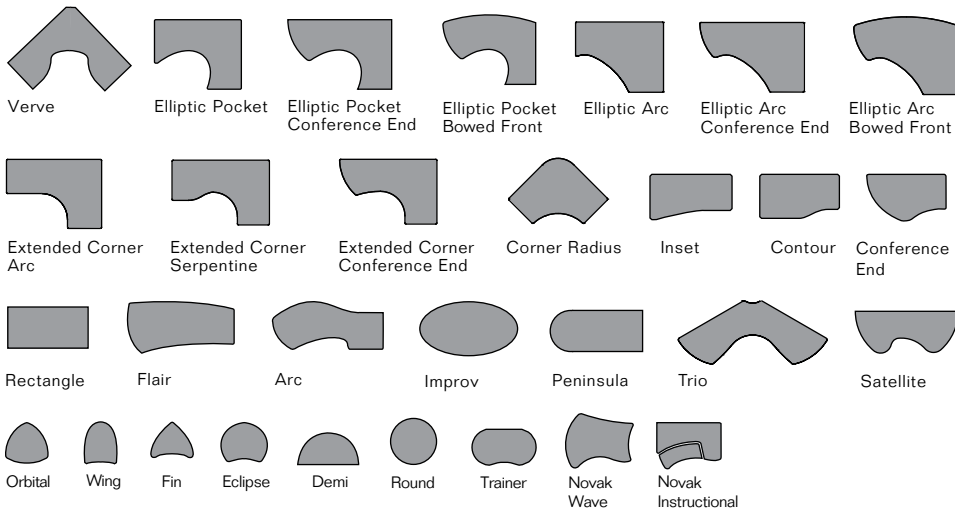

Verve	134
Elliptic Group	136
Corner	138
Extension	143
Independent	145
Companion	147
Classroom	148

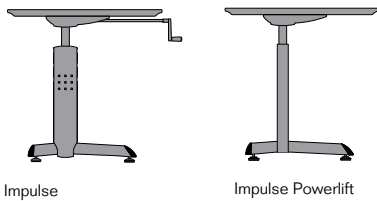
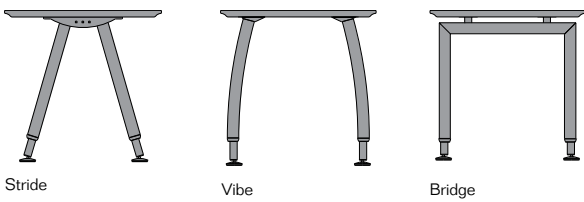

**A note on sizing: All worksurface dimensions are nominally adjusted by 1/2" to accommodate height adjustability.**

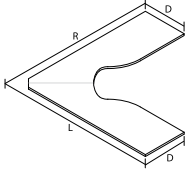
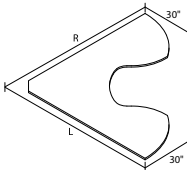
VERVE	Surface	Depth		Base							Edge	Smart-grain	Finishes					
		Left Hand Depth	Right Hand Depth	Stride	Vibe	Bridge	*Impulse Fixed	*Impulse Notch Adjust	*Impulse Top Crank	*Impulse Front Crank			Impulse Powerlift	See Options Below	Smart-grain (+ \$100) Yes = A No = -	Surface	Edge	Base
				A	B	C	D	E	F	G			P					
Width Left / Right		24 = 24" 30 = 30"	24 = 24" 30 = 30"	\$	\$	\$	\$	\$	\$	\$	\$							
 <p><b>VERVE</b> 24 Deep</p>	VER6060	60	60	<input type="checkbox"/>	<input type="checkbox"/>	1740	1820	1970	1830	2045	2485	2570	3695	<input type="checkbox"/>	<input type="checkbox"/>	<input type="checkbox"/>	<input type="checkbox"/>	<input type="checkbox"/>
	VER6066	60	66	<input type="checkbox"/>	<input type="checkbox"/>	1745	1825	1975	1835	2050	2490	2575	3700	<input type="checkbox"/>	<input type="checkbox"/>	<input type="checkbox"/>	<input type="checkbox"/>	<input type="checkbox"/>
	VER6072	60	72	<input type="checkbox"/>	<input type="checkbox"/>	1800	1880	2030	1890	2105	2545	2630	3755	<input type="checkbox"/>	<input type="checkbox"/>	<input type="checkbox"/>	<input type="checkbox"/>	<input type="checkbox"/>
	VER6078	60	78	<input type="checkbox"/>	<input type="checkbox"/>	1985	2065	2215	2075	2290	2730	2815	3940	<input type="checkbox"/>	<input type="checkbox"/>	<input type="checkbox"/>	<input type="checkbox"/>	<input type="checkbox"/>
	VER6660	66	60	<input type="checkbox"/>	<input type="checkbox"/>	1745	1825	1975	1835	2050	2490	2575	3700	<input type="checkbox"/>	<input type="checkbox"/>	<input type="checkbox"/>	<input type="checkbox"/>	<input type="checkbox"/>
	VER6666	66	66	<input type="checkbox"/>	<input type="checkbox"/>	1750	1830	1980	1840	2055	2495	2580	3705	<input type="checkbox"/>	<input type="checkbox"/>	<input type="checkbox"/>	<input type="checkbox"/>	<input type="checkbox"/>
	VER6672	66	72	<input type="checkbox"/>	<input type="checkbox"/>	1805	1885	2035	1895	2110	2550	2635	3760	<input type="checkbox"/>	<input type="checkbox"/>	<input type="checkbox"/>	<input type="checkbox"/>	<input type="checkbox"/>
	VER6678	66	78	<input type="checkbox"/>	<input type="checkbox"/>	1990	2070	2220	2080	2295	2735	2820	3945	<input type="checkbox"/>	<input type="checkbox"/>	<input type="checkbox"/>	<input type="checkbox"/>	<input type="checkbox"/>
 <p><b>VERVE</b> <b>CONFERENCE END</b></p>	VER7260	72	60	<input type="checkbox"/>	<input type="checkbox"/>	1800	1880	2030	1890	2105	2545	2630	3755	<input type="checkbox"/>	<input type="checkbox"/>	<input type="checkbox"/>	<input type="checkbox"/>	<input type="checkbox"/>
	VER7266	72	66	<input type="checkbox"/>	<input type="checkbox"/>	1805	1885	2035	1895	2110	2550	2635	3760	<input type="checkbox"/>	<input type="checkbox"/>	<input type="checkbox"/>	<input type="checkbox"/>	<input type="checkbox"/>
	VER7272	72	72	<input type="checkbox"/>	<input type="checkbox"/>	1860	1940	2090	1950	2165	2605	2690	3815	<input type="checkbox"/>	<input type="checkbox"/>	<input type="checkbox"/>	<input type="checkbox"/>	<input type="checkbox"/>
	VER7278	72	78	<input type="checkbox"/>	<input type="checkbox"/>	2045	2125	2275	2135	2350	2790	2875	4000	<input type="checkbox"/>	<input type="checkbox"/>	<input type="checkbox"/>	<input type="checkbox"/>	<input type="checkbox"/>
	VER7860	78	60	<input type="checkbox"/>	<input type="checkbox"/>	1985	2065	2215	2075	2290	2730	2815	3940	<input type="checkbox"/>	<input type="checkbox"/>	<input type="checkbox"/>	<input type="checkbox"/>	<input type="checkbox"/>
	VER7866	78	66	<input type="checkbox"/>	<input type="checkbox"/>	1990	2070	2220	2080	2295	2735	2820	3945	<input type="checkbox"/>	<input type="checkbox"/>	<input type="checkbox"/>	<input type="checkbox"/>	<input type="checkbox"/>
	VER7872	78	72	<input type="checkbox"/>	<input type="checkbox"/>	2045	2125	2275	2135	2350	2790	2875	4000	<input type="checkbox"/>	<input type="checkbox"/>	<input type="checkbox"/>	<input type="checkbox"/>	<input type="checkbox"/>
	VER7878	78	78	<input type="checkbox"/>	<input type="checkbox"/>	2230	2310	2460	2320	2535	2975	3060	4185	<input type="checkbox"/>	<input type="checkbox"/>	<input type="checkbox"/>	<input type="checkbox"/>	<input type="checkbox"/>
	VEC6666	66	66	30	30	1750	1830	1980	1840	2055	2495	2580	3705	<input type="checkbox"/>	<input type="checkbox"/>	<input type="checkbox"/>	<input type="checkbox"/>	<input type="checkbox"/>
	VEC6672	66	72	30	30	1805	1885	2035	1895	2110	2550	2635	3760	<input type="checkbox"/>	<input type="checkbox"/>	<input type="checkbox"/>	<input type="checkbox"/>	<input type="checkbox"/>
VEC6678	66	78	30	30	1990	2070	2220	2080	2295	2735	2820	3945	<input type="checkbox"/>	<input type="checkbox"/>	<input type="checkbox"/>	<input type="checkbox"/>	<input type="checkbox"/>	
VEC7266	72	66	30	30	1805	1885	2035	1895	2110	2550	2635	3760	<input type="checkbox"/>	<input type="checkbox"/>	<input type="checkbox"/>	<input type="checkbox"/>	<input type="checkbox"/>	
VEC7272	72	72	30	30	1860	1940	2090	1950	2165	2605	2690	3815	<input type="checkbox"/>	<input type="checkbox"/>	<input type="checkbox"/>	<input type="checkbox"/>	<input type="checkbox"/>	
VEC7278	72	78	30	30	2045	2125	2275	2135	2350	2790	2875	4000	<input type="checkbox"/>	<input type="checkbox"/>	<input type="checkbox"/>	<input type="checkbox"/>	<input type="checkbox"/>	
VEC7866	78	66	30	30	1990	2070	2220	2080	2295	2735	2820	3945	<input type="checkbox"/>	<input type="checkbox"/>	<input type="checkbox"/>	<input type="checkbox"/>	<input type="checkbox"/>	
VEC7872	78	72	30	30	2045	2125	2275	2135	2350	2790	2875	4000	<input type="checkbox"/>	<input type="checkbox"/>	<input type="checkbox"/>	<input type="checkbox"/>	<input type="checkbox"/>	
VEC7878	78	78	30	30	2230	2310	2460	2320	2535	2975	3060	4185	<input type="checkbox"/>	<input type="checkbox"/>	<input type="checkbox"/>	<input type="checkbox"/>	<input type="checkbox"/>	

APPLICATION

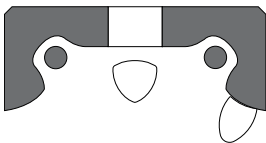

Verve's single-base design provides an effective "L" shaped station while eliminating the need for both a corner component and a return. This increases leg clearance under the desk and reduces acquisition cost.

Conference ends share a docking radius with companion tables.

Verve desks are available in 24 and 30 inch depths, and specifiers may choose either depth for both wings.

Verve tables are delivered in two pieces joined diagonally at the center using alignment tabs and tightjoint fasteners.

Verve desks with Duet edges do not have a chamfered corner for cable management.

INDEX

LEGS	190
IMPULSE ADJUSTMENT	192
EXTENSION ASSEMBLY	194
EDGES	195
FUSION VALUE	196
KEYBOARDS	197

Keyboard Option

An Extended Range Keyboard can be added that adjusts from 5 inches below the worksurface to 8 inches above, \$402 list. For additional details, see page 184.

\*Decorative Shrouds

Decorative shrouds for exposed Impulse base applications are available at \$100 each. See page 184 for details and ordering.







Grommets

To add factory installed grommets place a "G" after the edge code above and add \$75 list for all desks. For additional details, see page 185.

Smartgrain

Smartgrain laminates feature a unique finish with gloss and texture similar to real-wood laminates. See page 230 for details.

EDGES

		Add \$	Edge Code
	Xylo	+ \$00	<b>X</b>
	Bounce	+ \$200	<b>B</b>
	Duet	+ \$300	<b>D</b>
	N-45	+ \$300	<b>N</b>
	45	+ \$400	<b>T</b>
	Stretta	+ \$400	<b>S</b>
	Fender	+ \$500	<b>F</b>

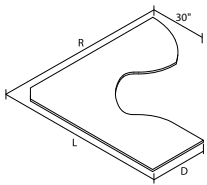
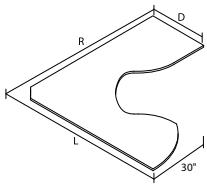
VERVE		Surface	Depth		Base										Edge	Smart-grain	Finishes		
			Left Hand Depth	Right Hand Depth	Stride	Vibe	Bridge	*Impulse Fixed	*Impulse Notch Adjust	*Impulse Top Crank	*Impulse Front Crank	Impulse Powerlift	See Options Below	Smart-grain (+\$100) Yes = A No = -			Surface	Edge	Base
Width Left / Right			24 = 24" 30 = 30"	24 = 24" 30 = 30"	A	B	C	D	E	F	G	P							
 <p><b>VERVE RIGHT HAND CONFERENCE END</b></p>	60 66	VRC6066	<input type="checkbox"/>	30	\$ 1745	\$ 1825	\$ 1975	\$ 1835	\$ 2050	\$ 2490	\$ 2575	\$ 3700	<input type="checkbox"/>	<input type="checkbox"/>	<input type="checkbox"/>	<input type="checkbox"/>	<input type="checkbox"/>		
	60 72	VRC6072	<input type="checkbox"/>	30	\$ 1800	\$ 1880	\$ 2030	\$ 1890	\$ 2105	\$ 2545	\$ 2630	\$ 3755	<input type="checkbox"/>	<input type="checkbox"/>	<input type="checkbox"/>	<input type="checkbox"/>	<input type="checkbox"/>		
	60 78	VRC6078	<input type="checkbox"/>	30	\$ 1985	\$ 2065	\$ 2215	\$ 2075	\$ 2290	\$ 2730	\$ 2815	\$ 3940	<input type="checkbox"/>	<input type="checkbox"/>	<input type="checkbox"/>	<input type="checkbox"/>	<input type="checkbox"/>		
	66 66	VRC6666	<input type="checkbox"/>	30	\$ 1750	\$ 1830	\$ 1980	\$ 1840	\$ 2055	\$ 2495	\$ 2580	\$ 3705	<input type="checkbox"/>	<input type="checkbox"/>	<input type="checkbox"/>	<input type="checkbox"/>	<input type="checkbox"/>		
	66 72	VRC6672	<input type="checkbox"/>	30	\$ 1805	\$ 1885	\$ 2035	\$ 1895	\$ 2110	\$ 2550	\$ 2635	\$ 3760	<input type="checkbox"/>	<input type="checkbox"/>	<input type="checkbox"/>	<input type="checkbox"/>	<input type="checkbox"/>		
	66 78	VRC6678	<input type="checkbox"/>	30	\$ 1990	\$ 2070	\$ 2220	\$ 2080	\$ 2295	\$ 2735	\$ 2820	\$ 3945	<input type="checkbox"/>	<input type="checkbox"/>	<input type="checkbox"/>	<input type="checkbox"/>	<input type="checkbox"/>		
	72 66	VRC7266	<input type="checkbox"/>	30	\$ 1805	\$ 1885	\$ 2035	\$ 1895	\$ 2110	\$ 2550	\$ 2635	\$ 3760	<input type="checkbox"/>	<input type="checkbox"/>	<input type="checkbox"/>	<input type="checkbox"/>	<input type="checkbox"/>		
	72 72	VRC7272	<input type="checkbox"/>	30	\$ 1860	\$ 1940	\$ 2090	\$ 1950	\$ 2165	\$ 2605	\$ 2690	\$ 3815	<input type="checkbox"/>	<input type="checkbox"/>	<input type="checkbox"/>	<input type="checkbox"/>	<input type="checkbox"/>		
	72 78	VRC7278	<input type="checkbox"/>	30	\$ 2045	\$ 2125	\$ 2275	\$ 2135	\$ 2350	\$ 2790	\$ 2875	\$ 4000	<input type="checkbox"/>	<input type="checkbox"/>	<input type="checkbox"/>	<input type="checkbox"/>	<input type="checkbox"/>		
	78 66	VRC7866	<input type="checkbox"/>	30	\$ 1990	\$ 2070	\$ 2220	\$ 2080	\$ 2295	\$ 2735	\$ 2820	\$ 3945	<input type="checkbox"/>	<input type="checkbox"/>	<input type="checkbox"/>	<input type="checkbox"/>	<input type="checkbox"/>		
	78 72	VRC7872	<input type="checkbox"/>	30	\$ 2045	\$ 2125	\$ 2275	\$ 2135	\$ 2350	\$ 2790	\$ 2875	\$ 4000	<input type="checkbox"/>	<input type="checkbox"/>	<input type="checkbox"/>	<input type="checkbox"/>	<input type="checkbox"/>		
	78 78	VRC7878	<input type="checkbox"/>	30	\$ 2230	\$ 2310	\$ 2460	\$ 2320	\$ 2535	\$ 2975	\$ 3060	\$ 4185	<input type="checkbox"/>	<input type="checkbox"/>	<input type="checkbox"/>	<input type="checkbox"/>	<input type="checkbox"/>		
 <p><b>VERVE LEFT HAND CONFERENCE END</b></p>	66 60	VCR6660	<input type="checkbox"/>	30	\$ 1745	\$ 1825	\$ 1975	\$ 1835	\$ 2050	\$ 2490	\$ 2575	\$ 3700	<input type="checkbox"/>	<input type="checkbox"/>	<input type="checkbox"/>	<input type="checkbox"/>	<input type="checkbox"/>		
	66 66	VCR6666	<input type="checkbox"/>	30	\$ 1750	\$ 1830	\$ 1980	\$ 1840	\$ 2055	\$ 2495	\$ 2580	\$ 3705	<input type="checkbox"/>	<input type="checkbox"/>	<input type="checkbox"/>	<input type="checkbox"/>	<input type="checkbox"/>		
	66 72	VCR6672	<input type="checkbox"/>	30	\$ 1805	\$ 1885	\$ 2035	\$ 1895	\$ 2110	\$ 2550	\$ 2635	\$ 3760	<input type="checkbox"/>	<input type="checkbox"/>	<input type="checkbox"/>	<input type="checkbox"/>	<input type="checkbox"/>		
	66 78	VCR6678	<input type="checkbox"/>	30	\$ 1990	\$ 2070	\$ 2220	\$ 2080	\$ 2295	\$ 2735	\$ 2820	\$ 3945	<input type="checkbox"/>	<input type="checkbox"/>	<input type="checkbox"/>	<input type="checkbox"/>	<input type="checkbox"/>		
	72 60	VCR7260	<input type="checkbox"/>	30	\$ 1800	\$ 1880	\$ 2030	\$ 1890	\$ 2105	\$ 2545	\$ 2630	\$ 3755	<input type="checkbox"/>	<input type="checkbox"/>	<input type="checkbox"/>	<input type="checkbox"/>	<input type="checkbox"/>		
	72 66	VCR7266	<input type="checkbox"/>	30	\$ 1805	\$ 1885	\$ 2035	\$ 1895	\$ 2110	\$ 2550	\$ 2635	\$ 3760	<input type="checkbox"/>	<input type="checkbox"/>	<input type="checkbox"/>	<input type="checkbox"/>	<input type="checkbox"/>		
	72 72	VCR7272	<input type="checkbox"/>	30	\$ 1860	\$ 1940	\$ 2090	\$ 1950	\$ 2165	\$ 2605	\$ 2690	\$ 3815	<input type="checkbox"/>	<input type="checkbox"/>	<input type="checkbox"/>	<input type="checkbox"/>	<input type="checkbox"/>		
	72 78	VCR7278	<input type="checkbox"/>	30	\$ 2045	\$ 2125	\$ 2275	\$ 2135	\$ 2350	\$ 2790	\$ 2875	\$ 4000	<input type="checkbox"/>	<input type="checkbox"/>	<input type="checkbox"/>	<input type="checkbox"/>	<input type="checkbox"/>		
	78 60	VCR7860	<input type="checkbox"/>	30	\$ 1985	\$ 2065	\$ 2215	\$ 2075	\$ 2290	\$ 2730	\$ 2815	\$ 3940	<input type="checkbox"/>	<input type="checkbox"/>	<input type="checkbox"/>	<input type="checkbox"/>	<input type="checkbox"/>		
	78 66	VCR7866	<input type="checkbox"/>	30	\$ 1990	\$ 2070	\$ 2220	\$ 2080	\$ 2295	\$ 2735	\$ 2820	\$ 3945	<input type="checkbox"/>	<input type="checkbox"/>	<input type="checkbox"/>	<input type="checkbox"/>	<input type="checkbox"/>		
	78 72	VCR7872	<input type="checkbox"/>	30	\$ 2045	\$ 2125	\$ 2275	\$ 2135	\$ 2350	\$ 2790	\$ 2875	\$ 4000	<input type="checkbox"/>	<input type="checkbox"/>	<input type="checkbox"/>	<input type="checkbox"/>	<input type="checkbox"/>		
	78 78	VCR7878	<input type="checkbox"/>	30	\$ 2230	\$ 2310	\$ 2460	\$ 2320	\$ 2535	\$ 2975	\$ 3060	\$ 4185	<input type="checkbox"/>	<input type="checkbox"/>	<input type="checkbox"/>	<input type="checkbox"/>	<input type="checkbox"/>		

APPLICATION

Verve's single-base design provides an effective "L" shaped station while eliminating the need for both a corner component and a return. This increases leg clearance under the desk and reduces acquisition cost.

Conference ends share a docking radius with companion tables.

Verve desks are available in 24 and 30 inch depths, and specifiers may choose either depth for both wings.

Verve tables are delivered in two pieces joined diagonally at the center using alignment tabs and tightjoint fasteners.

Verve desks with Duet edges do not have a chamfered corner for cable management.

INDEX

LEGS	190
IMPULSE ADJUSTMENT	192
EXTENSION ASSEMBLY	194
EDGES	195
FUSION VALUE	196
KEYBOARDS	197

Keyboard Option

An Extended Range Keyboard can be added that adjusts from 5 inches below the worksurface to 8 inches above, \$402 list. For additional details, see page 184.

\*Decorative Shrouds

Decorative shrouds for exposed Impulse base applications are available at \$100 each. See page 184 for details and ordering.







Grommets

To add factory installed grommets place a "G" after the edge code above and add \$75 list for all desks. For additional details, see page 185.

Smartgrain

Smartgrain laminates feature a unique finish with gloss and texture similar to real-wood laminates. See page 230 for details.

EDGES

		Add \$	Edge Code
	Xylo	+ \$00	<b>X</b>
	Bounce	+ \$200	<b>B</b>
	Duet	+ \$300	<b>D</b>
	N-45	+ \$300	<b>N</b>
	45	+ \$400	<b>T</b>
	Stretta	+ \$400	<b>S</b>
	Fender	+ \$500	<b>F</b>

ELLIPTIC GROUP

D / W	Surface	Base	Edge	Smart-grain	Finishes									
					See Options Below	Smart-grain (+ \$100) Yes = A No = -	Surface	Edge	Base					
										Stride	Vibe	Bridge	*Impulse Fixed	*Impulse Notch Adjust
Left = L or Right = R	A	B	C	D	E	F	G	P						
48 48	XPO4848	<input type="checkbox"/>	<input type="checkbox"/>	<input type="checkbox"/>	<input type="checkbox"/>	<input type="checkbox"/>	<input type="checkbox"/>	<input type="checkbox"/>	<input type="checkbox"/>	<input type="checkbox"/>	<input type="checkbox"/>	<input type="checkbox"/>	<input type="checkbox"/>	<input type="checkbox"/>
48 60	XPO4860	<input type="checkbox"/>	<input type="checkbox"/>	<input type="checkbox"/>	<input type="checkbox"/>	<input type="checkbox"/>	<input type="checkbox"/>	<input type="checkbox"/>	<input type="checkbox"/>	<input type="checkbox"/>	<input type="checkbox"/>	<input type="checkbox"/>	<input type="checkbox"/>	<input type="checkbox"/>
48 72	XPO4872	<input type="checkbox"/>	<input type="checkbox"/>	<input type="checkbox"/>	<input type="checkbox"/>	<input type="checkbox"/>	<input type="checkbox"/>	<input type="checkbox"/>	<input type="checkbox"/>	<input type="checkbox"/>	<input type="checkbox"/>	<input type="checkbox"/>	<input type="checkbox"/>	<input type="checkbox"/>
48 84	XPO4884	<input type="checkbox"/>	<input type="checkbox"/>	<input type="checkbox"/>	<input type="checkbox"/>	<input type="checkbox"/>	<input type="checkbox"/>	<input type="checkbox"/>	<input type="checkbox"/>	<input type="checkbox"/>	<input type="checkbox"/>	<input type="checkbox"/>	<input type="checkbox"/>	<input type="checkbox"/>
48 66	XPC4866	<input type="checkbox"/>	<input type="checkbox"/>	<input type="checkbox"/>	<input type="checkbox"/>	<input type="checkbox"/>	<input type="checkbox"/>	<input type="checkbox"/>	<input type="checkbox"/>	<input type="checkbox"/>	<input type="checkbox"/>	<input type="checkbox"/>	<input type="checkbox"/>	<input type="checkbox"/>
48 72	XPC4872	<input type="checkbox"/>	<input type="checkbox"/>	<input type="checkbox"/>	<input type="checkbox"/>	<input type="checkbox"/>	<input type="checkbox"/>	<input type="checkbox"/>	<input type="checkbox"/>	<input type="checkbox"/>	<input type="checkbox"/>	<input type="checkbox"/>	<input type="checkbox"/>	<input type="checkbox"/>
48 78	XPC4878	<input type="checkbox"/>	<input type="checkbox"/>	<input type="checkbox"/>	<input type="checkbox"/>	<input type="checkbox"/>	<input type="checkbox"/>	<input type="checkbox"/>	<input type="checkbox"/>	<input type="checkbox"/>	<input type="checkbox"/>	<input type="checkbox"/>	<input type="checkbox"/>	<input type="checkbox"/>
48 84	XPC4884	<input type="checkbox"/>	<input type="checkbox"/>	<input type="checkbox"/>	<input type="checkbox"/>	<input type="checkbox"/>	<input type="checkbox"/>	<input type="checkbox"/>	<input type="checkbox"/>	<input type="checkbox"/>	<input type="checkbox"/>	<input type="checkbox"/>	<input type="checkbox"/>	<input type="checkbox"/>
48 66	XPB4866	<input type="checkbox"/>	<input type="checkbox"/>	<input type="checkbox"/>	<input type="checkbox"/>	<input type="checkbox"/>	<input type="checkbox"/>	<input type="checkbox"/>	<input type="checkbox"/>	<input type="checkbox"/>	<input type="checkbox"/>	<input type="checkbox"/>	<input type="checkbox"/>	<input type="checkbox"/>
48 72	XPB4872	<input type="checkbox"/>	<input type="checkbox"/>	<input type="checkbox"/>	<input type="checkbox"/>	<input type="checkbox"/>	<input type="checkbox"/>	<input type="checkbox"/>	<input type="checkbox"/>	<input type="checkbox"/>	<input type="checkbox"/>	<input type="checkbox"/>	<input type="checkbox"/>	<input type="checkbox"/>
48 78	XPB4878	<input type="checkbox"/>	<input type="checkbox"/>	<input type="checkbox"/>	<input type="checkbox"/>	<input type="checkbox"/>	<input type="checkbox"/>	<input type="checkbox"/>	<input type="checkbox"/>	<input type="checkbox"/>	<input type="checkbox"/>	<input type="checkbox"/>	<input type="checkbox"/>	<input type="checkbox"/>
48 84	XPB4884	<input type="checkbox"/>	<input type="checkbox"/>	<input type="checkbox"/>	<input type="checkbox"/>	<input type="checkbox"/>	<input type="checkbox"/>	<input type="checkbox"/>	<input type="checkbox"/>	<input type="checkbox"/>	<input type="checkbox"/>	<input type="checkbox"/>	<input type="checkbox"/>	<input type="checkbox"/>

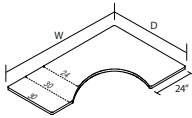

ELLIPTIC POCKET  
(left hand shown)



ELLIPTIC POCKET CONFERENCE END  
(left hand shown)



ELLIPTIC POCKET BOWED FRONT  
(left hand shown)

APPLICATION

Elliptic Pocket and Elliptic Arc form the Elliptic Group.

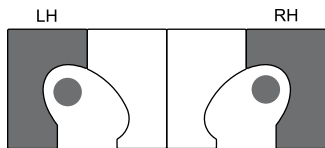

Conference ends share a docking radius with companion tables.

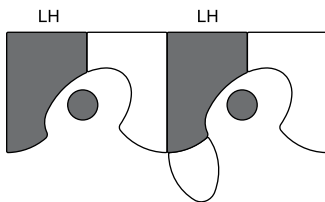

INDEX

LEGS	190
IMPULSE ADJUSTMENT	192
EXTENSION ASSEMBLY	194
EDGES	195
FUSION VALUE	196
KEYBOARDS	197

**\*Decorative Shrouts**

Decorative shrouts for exposed Impulse base applications are available at \$100 each. See page 184 for details and ordering.

**Grommets**

To add factory installed grommets place a "G" after the edge code above and add \$75 list for all desks. For additional details, see page 185.

**Smartgrain**

Smartgrain laminates feature a unique finish with gloss and texture similar to real-wood laminates. See page 230 for details.

EDGES

		Add \$	Edge Code
	Xylo	+ \$00	<b>X</b>
	Bounce	+ \$100	<b>B</b>
	Duet	+ \$150	<b>D</b>
	N-45	+ \$150	<b>N</b>
	45	+ \$200	<b>T</b>
	Stretta	+ \$200	<b>S</b>
	Fender	+ \$250	<b>F</b>



CORNER

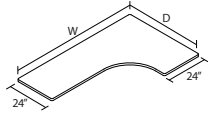

**EXTENDED CORNER ARC**  
(left hand shown)

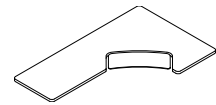

**EXTENDED CORNER ARC BI-LEVEL**  
(left hand shown)

D / W	Surface	Base	Edge	Smart-grain	Finishes										
					See Options Below										
					Surface	Edge	Base								
		Stride	Vibe	Bridge	*Impulse Fixed	*Impulse Notch Adjust	*Impulse Top Crank	*Impulse Front Crank	Impulse Powerlift						
		Left = L or Right = R	<b>A</b>	<b>B</b>	<b>C</b>	<b>D</b>	<b>E</b>	<b>F</b>	<b>G</b>	<b>P</b>					
			\$	\$	\$	\$	\$	\$	\$	\$					
48 54	XCA4854	<input type="checkbox"/>	1295	1250	1400	1260	1475	1915	2000	3125	<input type="checkbox"/>	<input type="checkbox"/>	<input type="checkbox"/>	<input type="checkbox"/>	<input type="checkbox"/>
48 60	XCA4860	<input type="checkbox"/>	1295	1250	1400	1260	1475	1915	2000	3125	<input type="checkbox"/>	<input type="checkbox"/>	<input type="checkbox"/>	<input type="checkbox"/>	<input type="checkbox"/>
48 66	XCA4866	<input type="checkbox"/>	1350	1305	1455	1315	1530	1970	2055	3180	<input type="checkbox"/>	<input type="checkbox"/>	<input type="checkbox"/>	<input type="checkbox"/>	<input type="checkbox"/>
48 72	XCA4872	<input type="checkbox"/>	1355	1310	1460	1320	1535	1975	2060	3185	<input type="checkbox"/>	<input type="checkbox"/>	<input type="checkbox"/>	<input type="checkbox"/>	<input type="checkbox"/>
48 78	XCA4878	<input type="checkbox"/>	1730	1685	1835	1695	1910	2350	2435	3560	<input type="checkbox"/>	<input type="checkbox"/>	<input type="checkbox"/>	<input type="checkbox"/>	<input type="checkbox"/>
48 84	XCA4884	<input type="checkbox"/>	1735	1690	1840	1700	1915	2355	2440	3565	<input type="checkbox"/>	<input type="checkbox"/>	<input type="checkbox"/>	<input type="checkbox"/>	<input type="checkbox"/>
54 54	XCA5454	<input type="checkbox"/>	1295	1250	1400	1260	1475	1915	2000	3125	<input type="checkbox"/>	<input type="checkbox"/>	<input type="checkbox"/>	<input type="checkbox"/>	<input type="checkbox"/>
54 60	XCA5460	<input type="checkbox"/>	1295	1250	1400	1260	1475	1915	2000	3125	<input type="checkbox"/>	<input type="checkbox"/>	<input type="checkbox"/>	<input type="checkbox"/>	<input type="checkbox"/>
54 66	XCA5466	<input type="checkbox"/>	1350	1305	1455	1315	1530	1970	2055	3180	<input type="checkbox"/>	<input type="checkbox"/>	<input type="checkbox"/>	<input type="checkbox"/>	<input type="checkbox"/>
54 72	XCA5472	<input type="checkbox"/>	1355	1310	1460	1320	1535	1975	2060	3185	<input type="checkbox"/>	<input type="checkbox"/>	<input type="checkbox"/>	<input type="checkbox"/>	<input type="checkbox"/>
54 78	XCA5478	<input type="checkbox"/>	1730	1685	1835	1695	1910	2350	2435	3560	<input type="checkbox"/>	<input type="checkbox"/>	<input type="checkbox"/>	<input type="checkbox"/>	<input type="checkbox"/>
54 84	XCA5484	<input type="checkbox"/>	1735	1690	1840	1700	1915	2355	2440	3565	<input type="checkbox"/>	<input type="checkbox"/>	<input type="checkbox"/>	<input type="checkbox"/>	<input type="checkbox"/>
48 54	YCA4854	<input type="checkbox"/>	1600	1555	1705	1565	1780	2220	2305	3430	<input type="checkbox"/>	<input type="checkbox"/>	<input type="checkbox"/>	<input type="checkbox"/>	<input type="checkbox"/>
48 60	YCA4860	<input type="checkbox"/>	1600	1555	1705	1565	1780	2220	2305	3430	<input type="checkbox"/>	<input type="checkbox"/>	<input type="checkbox"/>	<input type="checkbox"/>	<input type="checkbox"/>
48 66	YCA4866	<input type="checkbox"/>	1655	1610	1760	1620	1835	2275	2360	3485	<input type="checkbox"/>	<input type="checkbox"/>	<input type="checkbox"/>	<input type="checkbox"/>	<input type="checkbox"/>
48 72	YCA4872	<input type="checkbox"/>	1660	1615	1765	1625	1840	2280	2365	3490	<input type="checkbox"/>	<input type="checkbox"/>	<input type="checkbox"/>	<input type="checkbox"/>	<input type="checkbox"/>
48 78	YCA4878	<input type="checkbox"/>	2035	1990	2140	2000	2215	2655	2740	3865	<input type="checkbox"/>	<input type="checkbox"/>	<input type="checkbox"/>	<input type="checkbox"/>	<input type="checkbox"/>
48 84	YCA4884	<input type="checkbox"/>	2040	1995	2145	2005	2220	2660	2745	3870	<input type="checkbox"/>	<input type="checkbox"/>	<input type="checkbox"/>	<input type="checkbox"/>	<input type="checkbox"/>
54 54	YCA5454	<input type="checkbox"/>	1600	1555	1705	1565	1780	2220	2305	3430	<input type="checkbox"/>	<input type="checkbox"/>	<input type="checkbox"/>	<input type="checkbox"/>	<input type="checkbox"/>
54 60	YCA5460	<input type="checkbox"/>	1600	1555	1705	1565	1780	2220	2305	3430	<input type="checkbox"/>	<input type="checkbox"/>	<input type="checkbox"/>	<input type="checkbox"/>	<input type="checkbox"/>
54 66	YCA5466	<input type="checkbox"/>	1655	1610	1760	1620	1835	2275	2360	3485	<input type="checkbox"/>	<input type="checkbox"/>	<input type="checkbox"/>	<input type="checkbox"/>	<input type="checkbox"/>
54 72	YCA5472	<input type="checkbox"/>	1660	1615	1765	1625	1840	2280	2365	3490	<input type="checkbox"/>	<input type="checkbox"/>	<input type="checkbox"/>	<input type="checkbox"/>	<input type="checkbox"/>
54 78	YCA5478	<input type="checkbox"/>	2035	1990	2140	2000	2215	2655	2740	3865	<input type="checkbox"/>	<input type="checkbox"/>	<input type="checkbox"/>	<input type="checkbox"/>	<input type="checkbox"/>
54 84	YCA5484	<input type="checkbox"/>	2040	1995	2145	2005	2220	2660	2745	3870	<input type="checkbox"/>	<input type="checkbox"/>	<input type="checkbox"/>	<input type="checkbox"/>	<input type="checkbox"/>

APPLICATION

Both docking ends on Extended Corner Arcs are 24 inches.

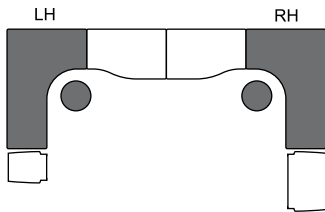

INDEX

LEGS	190
IMPULSE ADJUSTMENT	192
EXTENSION ASSEMBLY	194
EDGES	195
FUSION VALUE	196
KEYBOARDS	197

**\*Decorative Shrouds**

Decorative shrouds for exposed Impulse base applications are available at \$100 each. See page 184 for details and ordering.

**Grommets**

To add factory installed grommets place a "G" after the edge code above and add \$75 list for all desks. For additional details, see page 185.

**Smartgrain**

Smartgrain laminates feature a unique finish with gloss and texture similar to real-wood laminates. See page 230 for details.

EDGES

		Add \$	Edge Code
	Xylo	+ \$00	<b>X</b>
	Bounce	+ \$100	<b>B</b>
	Duet	+ \$150	<b>D</b>
	N-45	+ \$150	<b>N</b>
	45	+ \$200	<b>T</b>
	Stretta	+ \$200	<b>S</b>
	Fender	+ \$250	<b>F</b>

CORNER

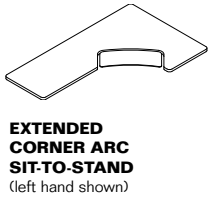

**EXTENDED CORNER ARC SIT-TO-STAND**  
(left hand shown)

CORNER	D / W	Surface	Left = L or Right = R	Base							Edge	See Options Below	Smart- grain (+ \$100) Yes = A No = -	Finishes			
				Stride	Vibe	Bridge	*Impulse Fixed	*Impulse Notch Adjust	*Impulse Top Crank	*Impulse Front Crank				Impulse Powerlift	Surface	Edge	Base
				A	B	C	D	E	F	G				P			
				\$	\$	\$	\$	\$	\$	\$	\$						
	48 54	ZCA4854	<input type="checkbox"/>	1715	1670	1820	1680	1895	2335	2420	3545	<input type="checkbox"/>	<input type="checkbox"/>	<input type="checkbox"/>	<input type="checkbox"/>	<input type="checkbox"/>	
	48 60	ZCA4860	<input type="checkbox"/>	1715	1670	1820	1680	1895	2335	2420	3545	<input type="checkbox"/>	<input type="checkbox"/>	<input type="checkbox"/>	<input type="checkbox"/>	<input type="checkbox"/>	
	48 66	ZCA4866	<input type="checkbox"/>	1770	1725	1875	1735	1950	2390	2475	3600	<input type="checkbox"/>	<input type="checkbox"/>	<input type="checkbox"/>	<input type="checkbox"/>	<input type="checkbox"/>	
	48 72	ZCA4872	<input type="checkbox"/>	1775	1730	1880	1740	1955	2395	2480	3605	<input type="checkbox"/>	<input type="checkbox"/>	<input type="checkbox"/>	<input type="checkbox"/>	<input type="checkbox"/>	
	48 78	ZCA4878	<input type="checkbox"/>	2150	2105	2255	2115	2330	2770	2855	3980	<input type="checkbox"/>	<input type="checkbox"/>	<input type="checkbox"/>	<input type="checkbox"/>	<input type="checkbox"/>	
	48 84	ZCA4884	<input type="checkbox"/>	2155	2110	2260	2120	2335	2775	2860	3985	<input type="checkbox"/>	<input type="checkbox"/>	<input type="checkbox"/>	<input type="checkbox"/>	<input type="checkbox"/>	
	54 54	ZCA5454	<input type="checkbox"/>	1715	1670	1820	1680	1895	2335	2420	3545	<input type="checkbox"/>	<input type="checkbox"/>	<input type="checkbox"/>	<input type="checkbox"/>	<input type="checkbox"/>	
	54 60	ZCA5460	<input type="checkbox"/>	1715	1670	1820	1680	1895	2335	2420	3545	<input type="checkbox"/>	<input type="checkbox"/>	<input type="checkbox"/>	<input type="checkbox"/>	<input type="checkbox"/>	
	54 66	ZCA5466	<input type="checkbox"/>	1770	1725	1875	1735	1950	2390	2475	3600	<input type="checkbox"/>	<input type="checkbox"/>	<input type="checkbox"/>	<input type="checkbox"/>	<input type="checkbox"/>	
	54 72	ZCA5472	<input type="checkbox"/>	1775	1730	1880	1740	1955	2395	2480	3605	<input type="checkbox"/>	<input type="checkbox"/>	<input type="checkbox"/>	<input type="checkbox"/>	<input type="checkbox"/>	
	54 78	ZCA5478	<input type="checkbox"/>	2150	2105	2255	2115	2330	2770	2855	3980	<input type="checkbox"/>	<input type="checkbox"/>	<input type="checkbox"/>	<input type="checkbox"/>	<input type="checkbox"/>	
	54 84	ZCA5484	<input type="checkbox"/>	2155	2110	2260	2120	2335	2775	2860	3985	<input type="checkbox"/>	<input type="checkbox"/>	<input type="checkbox"/>	<input type="checkbox"/>	<input type="checkbox"/>	

APPLICATION

Both docking ends on Extended Corner Arcs are 24 inches.

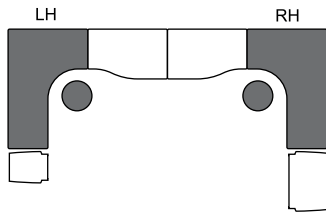

Sit-to-Stand keyboard allows 12.5 inches of articulation (5.25 inches up, 5.5 inches down and infinite adjustment within the range) and a separate tilt adjustment (+10° / -20°). See page 199 for details.

INDEX

LEGS	190
IMPULSE ADJUSTMENT	192
EXTENSION ASSEMBLY	194
EDGES	195
FUSION VALUE	196
KEYBOARDS	197

**\*Decorative Shrouds**  
Decorative shrouds for exposed Impulse base applications are available at \$100 each. See page 184 for details and ordering.

**Grommets**  
To add factory installed grommets place a "G" after the edge code above and add \$75 list for all desks. For additional details, see page 185.

**Smartgrain**  
Smartgrain laminates feature a unique finish with gloss and texture similar to real-wood laminates. See page 230 for details.

EDGES

		Add \$	Edge Code
	Xylo	+ \$00	<b>X</b>
	Bounce	+ \$100	<b>B</b>
	Duet	+ \$150	<b>D</b>
	N-45	+ \$150	<b>N</b>
	45	+ \$200	<b>T</b>
	Stretta	+ \$200	<b>S</b>
	Fender	+ \$250	<b>F</b>

CORNER

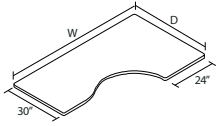

**EXTENDED CORNER SERPENTINE**  
(left hand shown)

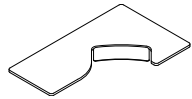

**EXTENDED CORNER SERPENTINE BI-LEVEL**  
(left hand shown)

D / W	Surface	Base	Edge	Smart-grain	Finishes													
					Left = L or Right = R	Stride	Vibe	Bridge	*Impulse Fixed	*Impulse Notch Adjust	*Impulse Top Crank	*Impulse Front Crank	Impulse Powerlift	See Options Below	Smart-grain (+\$100) Yes = A No = -	Surface	Edge	Base
						A	B	C	D	E	F	G	P					
48 60	XCS4860	<input type="checkbox"/>	\$	\$	\$	\$	\$	\$	\$	\$	<input type="checkbox"/>	<input type="checkbox"/>	<input type="checkbox"/>	<input type="checkbox"/>	<input type="checkbox"/>			
48 66	XCS4866	<input type="checkbox"/>	1295	1250	1400	1260	1475	1915	2000	3125	<input type="checkbox"/>	<input type="checkbox"/>	<input type="checkbox"/>	<input type="checkbox"/>	<input type="checkbox"/>			
48 72	XCS4872	<input type="checkbox"/>	1350	1305	1455	1315	1530	1970	2055	3180	<input type="checkbox"/>	<input type="checkbox"/>	<input type="checkbox"/>	<input type="checkbox"/>	<input type="checkbox"/>			
48 78	XCS4878	<input type="checkbox"/>	1355	1310	1460	1320	1535	1975	2060	3185	<input type="checkbox"/>	<input type="checkbox"/>	<input type="checkbox"/>	<input type="checkbox"/>	<input type="checkbox"/>			
48 84	XCS4884	<input type="checkbox"/>	1730	1685	1835	1695	1910	2350	2435	3560	<input type="checkbox"/>	<input type="checkbox"/>	<input type="checkbox"/>	<input type="checkbox"/>	<input type="checkbox"/>			
48 84	XCS4884	<input type="checkbox"/>	1735	1690	1840	1700	1915	2355	2440	3565	<input type="checkbox"/>	<input type="checkbox"/>	<input type="checkbox"/>	<input type="checkbox"/>	<input type="checkbox"/>			
54 60	XCS5460	<input type="checkbox"/>	1295	1250	1400	1260	1475	1915	2000	3125	<input type="checkbox"/>	<input type="checkbox"/>	<input type="checkbox"/>	<input type="checkbox"/>	<input type="checkbox"/>			
54 66	XCS5466	<input type="checkbox"/>	1350	1305	1455	1315	1530	1970	2055	3180	<input type="checkbox"/>	<input type="checkbox"/>	<input type="checkbox"/>	<input type="checkbox"/>	<input type="checkbox"/>			
54 72	XCS5472	<input type="checkbox"/>	1355	1310	1460	1320	1535	1975	2060	3185	<input type="checkbox"/>	<input type="checkbox"/>	<input type="checkbox"/>	<input type="checkbox"/>	<input type="checkbox"/>			
54 78	XCS5478	<input type="checkbox"/>	1730	1685	1835	1695	1910	2350	2435	3560	<input type="checkbox"/>	<input type="checkbox"/>	<input type="checkbox"/>	<input type="checkbox"/>	<input type="checkbox"/>			
54 84	XCS5484	<input type="checkbox"/>	1735	1690	1840	1700	1915	2355	2440	3565	<input type="checkbox"/>	<input type="checkbox"/>	<input type="checkbox"/>	<input type="checkbox"/>	<input type="checkbox"/>			
48 60	YCS4860	<input type="checkbox"/>	1600	1555	1705	1565	1780	2220	2305	3430	<input type="checkbox"/>	<input type="checkbox"/>	<input type="checkbox"/>	<input type="checkbox"/>	<input type="checkbox"/>			
48 66	YCS4866	<input type="checkbox"/>	1655	1610	1760	1620	1835	2275	2360	3485	<input type="checkbox"/>	<input type="checkbox"/>	<input type="checkbox"/>	<input type="checkbox"/>	<input type="checkbox"/>			
48 72	YCS4872	<input type="checkbox"/>	1660	1615	1765	1625	1840	2280	2365	3490	<input type="checkbox"/>	<input type="checkbox"/>	<input type="checkbox"/>	<input type="checkbox"/>	<input type="checkbox"/>			
48 78	YCS4878	<input type="checkbox"/>	2035	1990	2140	2000	2215	2655	2740	3865	<input type="checkbox"/>	<input type="checkbox"/>	<input type="checkbox"/>	<input type="checkbox"/>	<input type="checkbox"/>			
48 84	YCS4884	<input type="checkbox"/>	2040	1995	2145	2005	2220	2660	2745	3870	<input type="checkbox"/>	<input type="checkbox"/>	<input type="checkbox"/>	<input type="checkbox"/>	<input type="checkbox"/>			
54 60	YCS5460	<input type="checkbox"/>	1600	1555	1705	1565	1780	2220	2305	3430	<input type="checkbox"/>	<input type="checkbox"/>	<input type="checkbox"/>	<input type="checkbox"/>	<input type="checkbox"/>			
54 66	YCS5466	<input type="checkbox"/>	1655	1610	1760	1620	1835	2275	2360	3485	<input type="checkbox"/>	<input type="checkbox"/>	<input type="checkbox"/>	<input type="checkbox"/>	<input type="checkbox"/>			
54 72	YCS5472	<input type="checkbox"/>	1660	1615	1765	1625	1840	2280	2365	3490	<input type="checkbox"/>	<input type="checkbox"/>	<input type="checkbox"/>	<input type="checkbox"/>	<input type="checkbox"/>			
54 78	YCS5478	<input type="checkbox"/>	2035	1990	2140	2000	2215	2655	2740	3865	<input type="checkbox"/>	<input type="checkbox"/>	<input type="checkbox"/>	<input type="checkbox"/>	<input type="checkbox"/>			
54 84	YCS5484	<input type="checkbox"/>	2040	1995	2145	2005	2220	2660	2745	3870	<input type="checkbox"/>	<input type="checkbox"/>	<input type="checkbox"/>	<input type="checkbox"/>	<input type="checkbox"/>			

APPLICATION

Extended Corner Serpentes have a 30 inch docking end on the return portion of the worksurface.

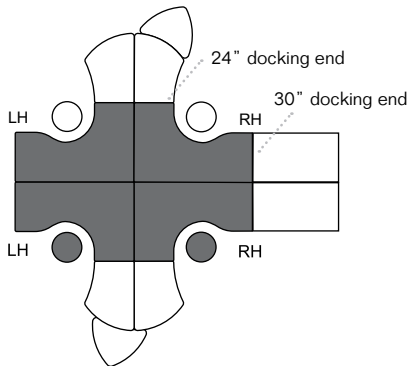

INDEX

LEGS	190
IMPULSE ADJUSTMENT	192
EXTENSION ASSEMBLY	194
EDGES	195
FUSION VALUE	196
KEYBOARDS	197

**\*Decorative Shrouds**

Decorative shrouds for exposed Impulse base applications are available at \$100 each. See page 184 for details and ordering.

**Grommets**

To add factory installed grommets place a "G" after the edge code above and add \$75 list for all desks. For additional details, see page 185.

**Smartgrain**

Smartgrain laminates feature a unique finish with gloss and texture similar to real-wood laminates. See page 230 for details.

EDGES

		Add \$	Edge Code
	Xylo	+ \$00	<b>X</b>
	Bounce	+ \$100	<b>B</b>
	Duet	+ \$150	<b>D</b>
	N-45	+ \$150	<b>N</b>
	45	+ \$200	<b>T</b>
	Stretta	+ \$200	<b>S</b>
	Fender	+ \$250	<b>F</b>

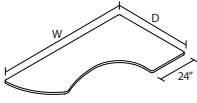
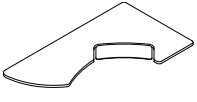
CORNER	D / W	Surface	Left = L or Right = R	Base									Edge	Smart-grain (+ \$100) Yes = A No = -	Finishes		
				Stride	Vibe	Bridge	*Impulse Fixed	*Impulse Notch Adjust	*Impulse Top Crank	*Impulse Front Crank	Impulse Powerlift	See Options Below			Surface	Edge	Base
				A	B	C	D	E	F	G	P						
	48 66	XCC4866	<input type="checkbox"/>	\$ 1350	\$ 1305	\$ 1455	\$ 1315	\$ 1530	\$ 1970	\$ 2055	\$ 3180	<input type="checkbox"/>	<input type="checkbox"/>	<input type="checkbox"/>	<input type="checkbox"/>	<input type="checkbox"/>	
	48 72	XCC4872	<input type="checkbox"/>	1355	1310	1460	1320	1535	1975	2060	3185	<input type="checkbox"/>	<input type="checkbox"/>	<input type="checkbox"/>	<input type="checkbox"/>	<input type="checkbox"/>	
	48 78	XCC4878	<input type="checkbox"/>	1730	1685	1835	1695	1910	2350	2435	3560	<input type="checkbox"/>	<input type="checkbox"/>	<input type="checkbox"/>	<input type="checkbox"/>	<input type="checkbox"/>	
	48 84	XCC4884	<input type="checkbox"/>	1735	1690	1840	1700	1915	2355	2440	3565	<input type="checkbox"/>	<input type="checkbox"/>	<input type="checkbox"/>	<input type="checkbox"/>	<input type="checkbox"/>	
	54 66	XCC5466	<input type="checkbox"/>	1350	1305	1455	1315	1530	1970	2055	3180	<input type="checkbox"/>	<input type="checkbox"/>	<input type="checkbox"/>	<input type="checkbox"/>	<input type="checkbox"/>	
<b>EXTENDED CORNER CONFERENCE END</b> (left hand shown)	54 72	XCC5472	<input type="checkbox"/>	1355	1310	1460	1320	1535	1975	2060	3185	<input type="checkbox"/>	<input type="checkbox"/>	<input type="checkbox"/>	<input type="checkbox"/>	<input type="checkbox"/>	
	54 78	XCC5478	<input type="checkbox"/>	1730	1685	1835	1695	1910	2350	2435	3560	<input type="checkbox"/>	<input type="checkbox"/>	<input type="checkbox"/>	<input type="checkbox"/>	<input type="checkbox"/>	
	54 84	XCC5484	<input type="checkbox"/>	1735	1690	1840	1700	1915	2355	2440	3565	<input type="checkbox"/>	<input type="checkbox"/>	<input type="checkbox"/>	<input type="checkbox"/>	<input type="checkbox"/>	
	48 66	YCC4866	<input type="checkbox"/>	1655	1610	1760	1620	1835	2275	2360	3485	<input type="checkbox"/>	<input type="checkbox"/>	<input type="checkbox"/>	<input type="checkbox"/>	<input type="checkbox"/>	
	48 72	YCC4872	<input type="checkbox"/>	1660	1615	1765	1625	1840	2280	2365	3490	<input type="checkbox"/>	<input type="checkbox"/>	<input type="checkbox"/>	<input type="checkbox"/>	<input type="checkbox"/>	
	48 78	YCC4878	<input type="checkbox"/>	2035	1990	2140	2000	2215	2655	2740	3865	<input type="checkbox"/>	<input type="checkbox"/>	<input type="checkbox"/>	<input type="checkbox"/>	<input type="checkbox"/>	
	48 84	YCC4884	<input type="checkbox"/>	2040	1995	2145	2005	2220	2660	2745	3870	<input type="checkbox"/>	<input type="checkbox"/>	<input type="checkbox"/>	<input type="checkbox"/>	<input type="checkbox"/>	
	54 66	YCC5466	<input type="checkbox"/>	1655	1610	1760	1620	1835	2275	2360	3485	<input type="checkbox"/>	<input type="checkbox"/>	<input type="checkbox"/>	<input type="checkbox"/>	<input type="checkbox"/>	
	54 72	YCC5472	<input type="checkbox"/>	1660	1615	1765	1625	1840	2280	2365	3490	<input type="checkbox"/>	<input type="checkbox"/>	<input type="checkbox"/>	<input type="checkbox"/>	<input type="checkbox"/>	
	54 78	YCC5478	<input type="checkbox"/>	2035	1990	2140	2000	2215	2655	2740	3865	<input type="checkbox"/>	<input type="checkbox"/>	<input type="checkbox"/>	<input type="checkbox"/>	<input type="checkbox"/>	
54 84	YCC5484	<input type="checkbox"/>	2040	1995	2145	2005	2220	2660	2745	3870	<input type="checkbox"/>	<input type="checkbox"/>	<input type="checkbox"/>	<input type="checkbox"/>	<input type="checkbox"/>		
				<input type="checkbox"/>	<input type="checkbox"/>	<input type="checkbox"/>	<input type="checkbox"/>	<input type="checkbox"/>	<input type="checkbox"/>	<input type="checkbox"/>	<input type="checkbox"/>	<input type="checkbox"/>	<input type="checkbox"/>	<input type="checkbox"/>	<input type="checkbox"/>		

APPLICATION

Conference Ends share a docking radius with Companion Tables (page 147).

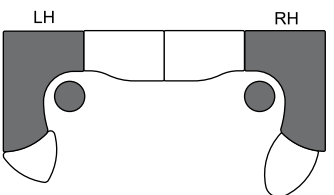
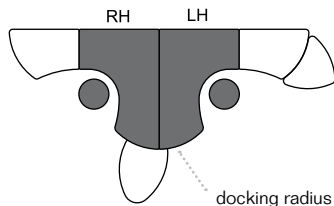

INDEX







LEGS	192
IMPULSE ADJUSTMENT	194
EXTENSION ASSEMBLY	196
EDGES	197
FUSION VALUE	198
KEYBOARDS	199

**\*Decorative Shrouds**  
Decorative shrouds for exposed Impulse base applications are available at \$100 each. See page 186 for details and ordering.

**Grommets**  
To add factory installed grommets place a "G" after the edge code above and add \$75 list for all desks. For additional details, see page 187.

**Smartgrain**  
Smartgrain laminates feature a unique finish with gloss and texture similar to real-wood laminates. See page 231 for details.

EDGES

	Add \$	Edge Code
 Xylo	+ \$00	<b>X</b>
 Bounce	+ \$100	<b>B</b>
 Duet	+ \$150	<b>D</b>
 N-45	+ \$150	<b>N</b>
 45	+ \$200	<b>T</b>
 Stretta	+ \$200	<b>S</b>
 Fender	+ \$250	<b>F</b>

CORNER

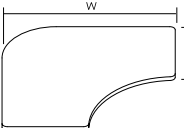
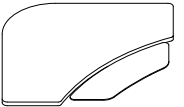
CORNER	Surface	Base				Edge	Smart-grain See Options Below	Smart-grain (+ \$100) Yes = A No = -	Finishes		
		*Impulse Fixed D	*Impulse Notch Adjust E	*Impulse Top Crank F	Impulse Powerlift P				Surface	Edge	Base
 <p><b>CORNER RADIUS</b></p>	D / W	\$	\$	\$	\$						
	24 42	XCR2442	747	893	1211	2333	<input type="checkbox"/>	<input type="checkbox"/>	<input type="checkbox"/>	<input type="checkbox"/>	<input type="checkbox"/>
	24 48	XCR2448	772	917	1236	2358	<input type="checkbox"/>	<input type="checkbox"/>	<input type="checkbox"/>	<input type="checkbox"/>	<input type="checkbox"/>
	30 48	XCR3048	796	942	1260	2384	<input type="checkbox"/>	<input type="checkbox"/>	<input type="checkbox"/>	<input type="checkbox"/>	<input type="checkbox"/>
 <p><b>CORNER RADIUS BI-LEVEL</b></p>	30 48	YCR3048	1100	1254	1572	2696	<input type="checkbox"/>	<input type="checkbox"/>	<input type="checkbox"/>	<input type="checkbox"/>	<input type="checkbox"/>

APPLICATION

Corner Radius desks accommodate 24 or 30 inch Extensions (page 143).

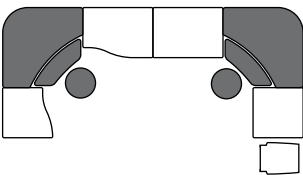

INDEX







LEGS	190
IMPULSE ADJUSTMENT	192
EXTENSION ASSEMBLY	194
EDGES	195
FUSION VALUE	196
KEYBOARDS	197

**\*Decorative Shrouds**  
Decorative shrouds for exposed Impulse base applications are available at \$100 each. See page 184 for details and ordering.

**Grommets**  
To add factory installed grommets place a "G" after the edge code above and add \$75 list for all desks. For additional details, see page 185.

**Smartgrain**  
Smartgrain laminates feature a unique finish with gloss and texture similar to real-wood laminates. See page 230 for details.

EDGES

		Add \$	Edge Code
	Xylo	+ \$00	<b>X</b>
	Bounce	+ \$100	<b>B</b>
	Duet	+ \$150	<b>D</b>
	N-45	+ \$150	<b>N</b>
	45	+ \$200	<b>T</b>
	Stretta	+ \$200	<b>S</b>
	Fender	+ \$250	<b>F</b>

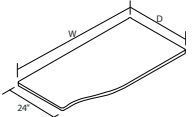
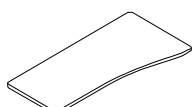
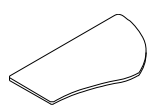
EXTENSION	D / W	Surface	Base	Edge	Smart-grain	Finishes											
						See Options Below											
						Stride	Vibe	Bridge	*Impulse Fixed	*Impulse Notch Adjust	*Impulse Top Crank	*Impulse Front Crank	Impulse Powerlift	Smart-grain (+ \$100)	Surface	Edge	Base
A	B	C	D	E	F	G	P	Yes = A No = -									
 <p><b>CONTOUR</b> (right hand shown)</p>	30 30	XCO3030	<input type="checkbox"/>	\$	\$	\$	\$	\$	\$	\$	\$	\$	<input type="checkbox"/>	<input type="checkbox"/>	<input type="checkbox"/>	<input type="checkbox"/>	<input type="checkbox"/>
	30 36	XCO3036	<input type="checkbox"/>	595	675	825	605	750	1065	1180	2275	2310	<input type="checkbox"/>	<input type="checkbox"/>	<input type="checkbox"/>	<input type="checkbox"/>	<input type="checkbox"/>
	30 42	XCO3042	<input type="checkbox"/>	630	710	860	640	785	1100	1215	2310	2315	<input type="checkbox"/>	<input type="checkbox"/>	<input type="checkbox"/>	<input type="checkbox"/>	<input type="checkbox"/>
	30 48	XCO3048	<input type="checkbox"/>	635	715	865	645	790	1105	1220	2315	2315	<input type="checkbox"/>	<input type="checkbox"/>	<input type="checkbox"/>	<input type="checkbox"/>	<input type="checkbox"/>
	30 54	XCO3054	<input type="checkbox"/>	825	905	1055	835	980	1295	1410	2505	2510	<input type="checkbox"/>	<input type="checkbox"/>	<input type="checkbox"/>	<input type="checkbox"/>	<input type="checkbox"/>
	30 60	XCO3060	<input type="checkbox"/>	830	910	1060	840	985	1300	1415	2510	2515	<input type="checkbox"/>	<input type="checkbox"/>	<input type="checkbox"/>	<input type="checkbox"/>	<input type="checkbox"/>
	30 72	XCO3072	<input type="checkbox"/>	890	970	1120	900	1045	1360	1475	2570	2570	<input type="checkbox"/>	<input type="checkbox"/>	<input type="checkbox"/>	<input type="checkbox"/>	<input type="checkbox"/>
 <p><b>INSET</b> (right hand shown)</p>	30 30	XIN3030	<input type="checkbox"/>	590	670	820	600	745	1060	1175	2270	2275	<input type="checkbox"/>	<input type="checkbox"/>	<input type="checkbox"/>	<input type="checkbox"/>	<input type="checkbox"/>
	30 36	XIN3036	<input type="checkbox"/>	595	675	825	605	750	1065	1180	2275	2310	<input type="checkbox"/>	<input type="checkbox"/>	<input type="checkbox"/>	<input type="checkbox"/>	<input type="checkbox"/>
	30 42	XIN3042	<input type="checkbox"/>	630	710	860	640	785	1100	1215	2310	2315	<input type="checkbox"/>	<input type="checkbox"/>	<input type="checkbox"/>	<input type="checkbox"/>	<input type="checkbox"/>
	30 48	XIN3048	<input type="checkbox"/>	635	715	865	645	790	1105	1220	2315	2315	<input type="checkbox"/>	<input type="checkbox"/>	<input type="checkbox"/>	<input type="checkbox"/>	<input type="checkbox"/>
	30 54	XIN3054	<input type="checkbox"/>	825	905	1055	835	980	1295	1410	2505	2510	<input type="checkbox"/>	<input type="checkbox"/>	<input type="checkbox"/>	<input type="checkbox"/>	<input type="checkbox"/>
	30 60	XIN3060	<input type="checkbox"/>	830	910	1060	840	985	1300	1415	2510	2515	<input type="checkbox"/>	<input type="checkbox"/>	<input type="checkbox"/>	<input type="checkbox"/>	<input type="checkbox"/>
	30 72	XIN3072	<input type="checkbox"/>	890	970	1120	900	1045	1360	1475	2570	2570	<input type="checkbox"/>	<input type="checkbox"/>	<input type="checkbox"/>	<input type="checkbox"/>	<input type="checkbox"/>
 <p><b>CONFERENCE END</b> (right hand shown)</p>	30 42	XCE3042	<input type="checkbox"/>	630	710	860	640	785	1100	1215	2310	2315	<input type="checkbox"/>	<input type="checkbox"/>	<input type="checkbox"/>	<input type="checkbox"/>	<input type="checkbox"/>
	30 48	XCE3248	<input type="checkbox"/>	635	715	865	645	790	1105	1220	2315	2315	<input type="checkbox"/>	<input type="checkbox"/>	<input type="checkbox"/>	<input type="checkbox"/>	<input type="checkbox"/>
	30 54	XCE3354	<input type="checkbox"/>	825	905	1055	835	980	1295	1410	2505	2510	<input type="checkbox"/>	<input type="checkbox"/>	<input type="checkbox"/>	<input type="checkbox"/>	<input type="checkbox"/>
	30 60	XCE3460	<input type="checkbox"/>	830	910	1060	840	985	1300	1415	2510	2510	<input type="checkbox"/>	<input type="checkbox"/>	<input type="checkbox"/>	<input type="checkbox"/>	<input type="checkbox"/>

APPLICATION

Contour, Inset and Conference End desks provide a 30 inch docking return to 24 inch deep Corners or Extended Corner desks. Two inset worksurfaces may be aligned to form a docking radius for Companion Tables.

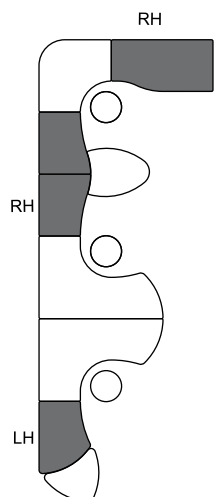

INDEX







LEGS	190
IMPULSE ADJUSTMENT	192
EXTENSION ASSEMBLY	194
EDGES	195
FUSION VALUE	196
KEYBOARDS	197

**\*Decorative Shrouds**  
Decorative shrouds for exposed Impulse base applications are available at \$100 each. See page 184 for details and ordering.

**Grommets**  
To add factory installed grommets place a "G" after the edge code above and add \$75 list for all desks. For additional details, see page 185.

**Smartgrain**  
Smartgrain laminates feature a unique finish with gloss and texture similar to real-wood laminates. See page 230 for details.

EDGES

	Add \$	Edge Code
 Xylo	+ \$00	<b>X</b>
 Bounce	+ \$100	<b>B</b>
 Duet	+ \$150	<b>D</b>
 N-45	+ \$150	<b>N</b>
 45	+ \$200	<b>T</b>
 Stretta	+ \$200	<b>S</b>
 Fender	+ \$250	<b>F</b>

EXTENSION

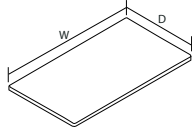

RECTANGULAR

*D / W	Surface	Base								Edge	Smart-grain See Options Below	Finishes		
		Stride A	Vibe B	Bridge C	*Impulse Fixed D	*Impulse Notch Adjust E	*Impulse Top Crank F	*Impulse Front Crank G	Impulse Powerlift P			Smart-grain (+ \$100) Yes = A No = -	Surface	Edge
24 30	XRE2430	\$ 590	\$ 670	\$ 820	\$ 600	\$ 745	\$ 1060	\$ 1175	\$ -	<input type="checkbox"/>	<input type="checkbox"/>	<input type="checkbox"/>	<input type="checkbox"/>	<input type="checkbox"/>
24 36	XRE2436	595	675	825	605	750	1065	1180	-	<input type="checkbox"/>	<input type="checkbox"/>	<input type="checkbox"/>	<input type="checkbox"/>	<input type="checkbox"/>
24 42	XRE2442	630	710	860	640	785	1100	1215	-	<input type="checkbox"/>	<input type="checkbox"/>	<input type="checkbox"/>	<input type="checkbox"/>	<input type="checkbox"/>
24 48	XRE2448	635	715	865	645	790	1105	1220	-	<input type="checkbox"/>	<input type="checkbox"/>	<input type="checkbox"/>	<input type="checkbox"/>	<input type="checkbox"/>
24 54	XRE2454	825	905	1055	835	980	1295	1410	-	<input type="checkbox"/>	<input type="checkbox"/>	<input type="checkbox"/>	<input type="checkbox"/>	<input type="checkbox"/>
24 60	XRE2460	830	910	1060	840	985	1300	1415	-	<input type="checkbox"/>	<input type="checkbox"/>	<input type="checkbox"/>	<input type="checkbox"/>	<input type="checkbox"/>
24 66	XRE2466	835	915	1065	845	990	1305	1420	-	<input type="checkbox"/>	<input type="checkbox"/>	<input type="checkbox"/>	<input type="checkbox"/>	<input type="checkbox"/>
24 72	XRE2472	890	970	1120	900	1045	1360	1475	-	<input type="checkbox"/>	<input type="checkbox"/>	<input type="checkbox"/>	<input type="checkbox"/>	<input type="checkbox"/>
24 78	XRE2478	1075	1155	1305	1085	1230	1545	1660	-	<input type="checkbox"/>	<input type="checkbox"/>	<input type="checkbox"/>	<input type="checkbox"/>	<input type="checkbox"/>
24 84	XRE2484	1080	1160	1310	1090	1235	1550	1665	-	<input type="checkbox"/>	<input type="checkbox"/>	<input type="checkbox"/>	<input type="checkbox"/>	<input type="checkbox"/>
30 30	XRE3030	590	670	820	600	745	1060	1175	2270	<input type="checkbox"/>	<input type="checkbox"/>	<input type="checkbox"/>	<input type="checkbox"/>	<input type="checkbox"/>
30 36	XRE3036	595	675	825	605	750	1065	1180	2275	<input type="checkbox"/>	<input type="checkbox"/>	<input type="checkbox"/>	<input type="checkbox"/>	<input type="checkbox"/>
30 42	XRE3042	630	710	860	640	785	1100	1215	2310	<input type="checkbox"/>	<input type="checkbox"/>	<input type="checkbox"/>	<input type="checkbox"/>	<input type="checkbox"/>
30 48	XRE3048	635	715	865	645	790	1105	1220	2315	<input type="checkbox"/>	<input type="checkbox"/>	<input type="checkbox"/>	<input type="checkbox"/>	<input type="checkbox"/>
30 54	XRE3054	825	905	1055	835	980	1295	1410	2505	<input type="checkbox"/>	<input type="checkbox"/>	<input type="checkbox"/>	<input type="checkbox"/>	<input type="checkbox"/>
30 60	XRE3060	830	910	1060	840	985	1300	1415	2510	<input type="checkbox"/>	<input type="checkbox"/>	<input type="checkbox"/>	<input type="checkbox"/>	<input type="checkbox"/>
30 66	XRE3066	835	915	1065	845	990	1305	1420	2515	<input type="checkbox"/>	<input type="checkbox"/>	<input type="checkbox"/>	<input type="checkbox"/>	<input type="checkbox"/>
30 72	XRE3072	890	970	1120	900	1045	1360	1475	2570	<input type="checkbox"/>	<input type="checkbox"/>	<input type="checkbox"/>	<input type="checkbox"/>	<input type="checkbox"/>
30 78	XRE3078	1075	1155	1305	1085	1230	1545	1660	2755	<input type="checkbox"/>	<input type="checkbox"/>	<input type="checkbox"/>	<input type="checkbox"/>	<input type="checkbox"/>
30 84	XRE3084	1080	1160	1310	1090	1235	1550	1665	2760	<input type="checkbox"/>	<input type="checkbox"/>	<input type="checkbox"/>	<input type="checkbox"/>	<input type="checkbox"/>

\*36" depths also available; please contact Customer Service for pricing.

APPLICATION

INDEX

EDGES

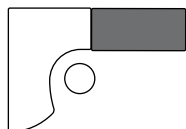
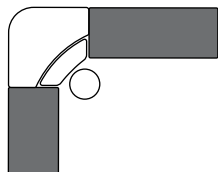

LEGS	190
IMPULSE ADJUSTMENT	192
EXTENSION ASSEMBLY	194
EDGES	195
FUSION VALUE	196
KEYBOARDS	197

**\*Decorative Shrouds**

Decorative shrouds for exposed Impulse base applications are available at \$100 each. See page 184 for details and ordering.

**Grommets**

To add factory installed grommets place a "G" after the edge code above and add \$75 list for all desks. For additional details, see page 185.

**Smartgrain**

Smartgrain laminates feature a unique finish with gloss and texture similar to real-wood laminates. See page 230 for details.

		Add \$	Edge Code
	Xylo	+ \$00	<b>X</b>
	Bounce	+ \$100	<b>B</b>
	Duet	+ \$150	<b>D</b>
	N-45	+ \$150	<b>N</b>
	45	+ \$200	<b>T</b>
	Stretta	+ \$200	<b>S</b>
	Fender	+ \$250	<b>F</b>

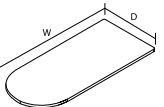
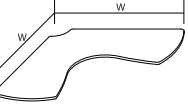

INDEPENDENT	D / W	Surface	Base			Edge	Smart-grain See Options Below	Smart-grain (+ \$100) Yes = A No = -	Finishes		
			Stride A	Vibe B	Bridge C				Surface	Edge	Base
 <p><b>PENINSULA</b></p>	24 48	XPN2448	-	715	-	<input type="checkbox"/>	<input type="checkbox"/>	<input type="checkbox"/>	<input type="checkbox"/>	<input type="checkbox"/>	
	24 54	XPN2454	-	830	-	<input type="checkbox"/>	<input type="checkbox"/>	<input type="checkbox"/>	<input type="checkbox"/>	<input type="checkbox"/>	
	24 60	XPN2460	-	835	-	<input type="checkbox"/>	<input type="checkbox"/>	<input type="checkbox"/>	<input type="checkbox"/>	<input type="checkbox"/>	
	24 66	XPN2466	-	915	-	<input type="checkbox"/>	<input type="checkbox"/>	<input type="checkbox"/>	<input type="checkbox"/>	<input type="checkbox"/>	
	24 72	XPN2472	-	970	-	<input type="checkbox"/>	<input type="checkbox"/>	<input type="checkbox"/>	<input type="checkbox"/>	<input type="checkbox"/>	
	30 48	XPN3048	-	715	-	<input type="checkbox"/>	<input type="checkbox"/>	<input type="checkbox"/>	<input type="checkbox"/>	<input type="checkbox"/>	
	30 54	XPN3054	-	830	-	<input type="checkbox"/>	<input type="checkbox"/>	<input type="checkbox"/>	<input type="checkbox"/>	<input type="checkbox"/>	
	30 60	XPN3060	-	835	-	<input type="checkbox"/>	<input type="checkbox"/>	<input type="checkbox"/>	<input type="checkbox"/>	<input type="checkbox"/>	
	30 66	XPN3066	-	915	-	<input type="checkbox"/>	<input type="checkbox"/>	<input type="checkbox"/>	<input type="checkbox"/>	<input type="checkbox"/>	
	30 72	XPN3072	-	970	-	<input type="checkbox"/>	<input type="checkbox"/>	<input type="checkbox"/>	<input type="checkbox"/>	<input type="checkbox"/>	
 <p><b>TRIO</b></p>	48 48	XTR4848	1450	1530	1680	<input type="checkbox"/>	<input type="checkbox"/>	<input type="checkbox"/>	<input type="checkbox"/>	<input type="checkbox"/>	
	60 60	XTR6060	1745	1825	1975	<input type="checkbox"/>	<input type="checkbox"/>	<input type="checkbox"/>	<input type="checkbox"/>	<input type="checkbox"/>	

APPLICATION INDEX EDGES

Peninsula Table is not docking radius compatible.

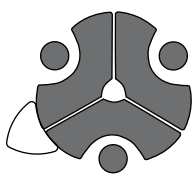





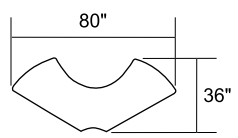

LEGS	190
IMPULSE ADJUSTMENT	192
EXTENSION ASSEMBLY	194
EDGES	195
FUSION VALUE	196
KEYBOARDS	197

**Smartgrain**  
Smartgrain laminates feature a unique finish with gloss and texture similar to real-wood laminates. See page 230 for details.

Additional Dimensioning

XTR4848



		Add \$	Edge Code
	Xylo	+ \$00	<b>X</b>
	Bounce	+ \$100	<b>B</b>
	N-45	+ \$150	<b>N</b>
	45	+ \$200	<b>T</b>
	Stretta	+ \$200	<b>S</b>
	Fender	+ \$250	<b>F</b>

COMPANION		Surface	Base	Edge	Smart-grain	Finishes		
A / B			Vibe See Options Below		Smart-grain (+ \$100) Yes = A No = -	Surface	Edge	Base
	<b>ORBITAL</b> 42 42	XOR4242	\$ 770	<input type="checkbox"/>	<input type="checkbox"/>	<input type="checkbox"/>	<input type="checkbox"/>	<input type="checkbox"/>
	<b>WING</b> 28 36	XWI2836	550	<input type="checkbox"/>	<input type="checkbox"/>	<input type="checkbox"/>	<input type="checkbox"/>	<input type="checkbox"/>
	<b>FIN</b> 34 26	XFI3426	640	<input type="checkbox"/>	<input type="checkbox"/>	<input type="checkbox"/>	<input type="checkbox"/>	<input type="checkbox"/>
	<b>ECLIPSE</b> 36 30	XEL3630	640	<input type="checkbox"/>	<input type="checkbox"/>	<input type="checkbox"/>	<input type="checkbox"/>	<input type="checkbox"/>
	24 48	XMO2448	590	<input type="checkbox"/>	<input type="checkbox"/>	<input type="checkbox"/>	<input type="checkbox"/>	<input type="checkbox"/>
	25 50	XMO2550	705	<input type="checkbox"/>	<input type="checkbox"/>	<input type="checkbox"/>	<input type="checkbox"/>	<input type="checkbox"/>
	30 60	XMO3060	710	<input type="checkbox"/>	<input type="checkbox"/>	<input type="checkbox"/>	<input type="checkbox"/>	<input type="checkbox"/>
	31 62	XMO3162	950	<input type="checkbox"/>	<input type="checkbox"/>	<input type="checkbox"/>	<input type="checkbox"/>	<input type="checkbox"/>
	<b>ROUND</b> 36 36	XRO3636	770	<input type="checkbox"/>	<input type="checkbox"/>	<input type="checkbox"/>	<input type="checkbox"/>	<input type="checkbox"/>
	42 42	XRO4242	895	<input type="checkbox"/>	<input type="checkbox"/>	<input type="checkbox"/>	<input type="checkbox"/>	<input type="checkbox"/>
	48 48	XRO4848	950	<input type="checkbox"/>	<input type="checkbox"/>	<input type="checkbox"/>	<input type="checkbox"/>	<input type="checkbox"/>
	60 60	XRO6060	1290	<input type="checkbox"/>	<input type="checkbox"/>	<input type="checkbox"/>	<input type="checkbox"/>	<input type="checkbox"/>
	<b>TRAINER</b> 24 48	XTN2448	715	<input type="checkbox"/>	<input type="checkbox"/>	<input type="checkbox"/>	<input type="checkbox"/>	<input type="checkbox"/>
	30 54	XTN3054	830	<input type="checkbox"/>	<input type="checkbox"/>	<input type="checkbox"/>	<input type="checkbox"/>	<input type="checkbox"/>

APPLICATION

Companion Tables have casters on two of their legs.  
36 inch Round tables have three legs, 42- 60 inch Round tables have four legs.

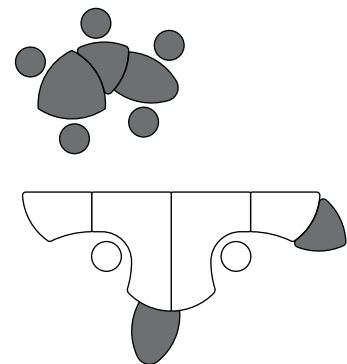

INDEX

LEGS	190
IMPULSE ADJUSTMENT	192
EXTENSION ASSEMBLY	194
EDGES	195
FUSION VALUE	196
KEYBOARDS	197

**Smartgrain**

Smartgrain laminates feature a unique finish with gloss and texture similar to real-wood laminates. See page 230 for details.

EDGES

	Add \$	Edge Code
	+ \$00	<b>X</b>
	+ \$100	<b>B</b>
	+ \$150	<b>D</b>
	+ \$150	<b>N</b>
	+ \$200	<b>T</b>
	+ \$200	<b>S</b>
	+ \$250	<b>F</b>

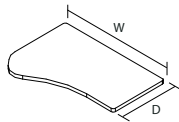
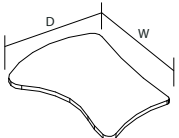
CLASSROOM	D / W	Surface	Base		Edge	Smart-grain See Options Below	Smart-grain (+ \$100) Yes = A No = -	Finishes		
			Stride	Vibe				Surface	Edge	Base
			A	B						
 <p><b>NOVAK INSTRUCTIONAL</b> (right hand shown)</p>	22 42	XNI2242	<input type="checkbox"/>	<input type="checkbox"/>	<input type="checkbox"/>	<input type="checkbox"/>	<input type="checkbox"/>	<input type="checkbox"/>	<input type="checkbox"/>	<input type="checkbox"/>
 <p><b>NOVAK WAVE</b> (right hand shown) complete dimensions shown below</p>	32 41	XNW3241	<input type="checkbox"/>	<input type="checkbox"/>	<input type="checkbox"/>	<input type="checkbox"/>	<input type="checkbox"/>	<input type="checkbox"/>	<input type="checkbox"/>	<input type="checkbox"/>

APPLICATION

Novak desks are designed for learning environments. Their unique shape facilitates superior line of sight to the instructor and increased row density by rotating the angle of the user.

Novak desks are sized for laptops and flat screen monitors.

Novak Instructional

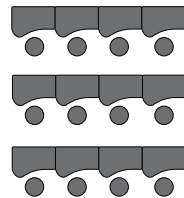

Novak Wave

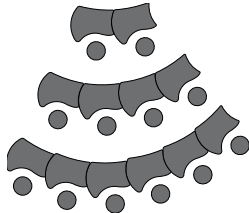

Novak Wave Dimensions

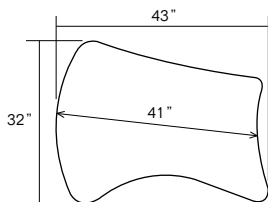

INDEX

LEGS	190
IMPULSE ADJUSTMENT	192
EXTENSION ASSEMBLY	194
EDGES	195
FUSION VALUE	196
KEYBOARDS	197

**\*Decorative Shrouds**

Decorative shrouds for exposed Impulse base applications are available at \$100 each. See page 184 for details and ordering.



**Grommets**

To add factory installed grommets place a "G" after the edge code above and add \$75 list for all desks. For additional details, see page 185.

**Smartgrain**

Smartgrain laminates feature a unique finish with gloss and texture similar to real-wood laminates. See page 230 for details.

EDGES

	Add \$	Edge Code
	+ \$00	<b>X</b>
	+ \$100	<b>B</b>

# CONFERENCING

Keystone	150
Elektra Series	151
Knife Series	152

KEYSTONE

		Surface	Base	Edge	Smart-grain	Finishes			
			Vibe <b>B</b>	See Options Below	Smart-grain (+ \$100) Yes = A No = -	Primary Surface	Keystone Surface	Edge	Base
<b>D / W</b>									
			\$						
	60 84	XKT084	4135	<input type="checkbox"/>	<input type="checkbox"/>	<input type="checkbox"/>	<input type="checkbox"/>	<input type="checkbox"/>	<input type="checkbox"/>
	60 114	XKT114	4440	<input type="checkbox"/>	<input type="checkbox"/>	<input type="checkbox"/>	<input type="checkbox"/>	<input type="checkbox"/>	<input type="checkbox"/>
	60 144	XKT144	4740	<input type="checkbox"/>	<input type="checkbox"/>	<input type="checkbox"/>	<input type="checkbox"/>	<input type="checkbox"/>	<input type="checkbox"/>
	60 42	XKE042	1085	<input type="checkbox"/>	<input type="checkbox"/>	<input type="checkbox"/>	-	<input type="checkbox"/>	<input type="checkbox"/>
	60 72	XKE072	1350	<input type="checkbox"/>	<input type="checkbox"/>	<input type="checkbox"/>	-	<input type="checkbox"/>	<input type="checkbox"/>
	60 102	XKE102	1860	<input type="checkbox"/>	<input type="checkbox"/>	<input type="checkbox"/>	-	<input type="checkbox"/>	<input type="checkbox"/>

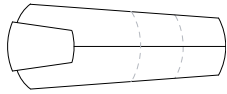

KEYSTONE

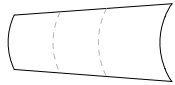

KEYSTONE EXTENSION

APPLICATION

Seating capacity ranges from 6 to 10 in basic Keystone tables and an additional 2 to 6 with extensions.

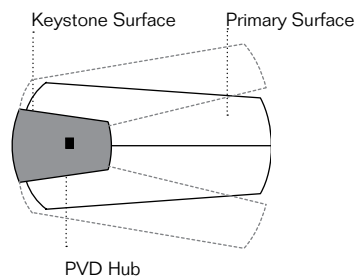
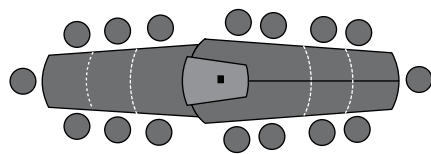

INDEX







MARKERBOARDS	188
LEGS	190
EXTENSION ASSEMBLY	194
EDGES	195
FUSION VALUE	196
KEYSTONE	202

Keystones are delivered with a 30 inch Vertebrae for cable routing and a power, voice, & data interconnect that provides two grounded AC outlets and installer-selectable phone/data network ports

**Smartgrain**

Smartgrain laminates feature a unique finish with gloss and texture similar to real-wood laminates. See page 230 for details.

EDGES

Edge	Add \$ Extension	Add \$ Keystone	Edge Code
 Xylo	+ \$00	+ \$00	<b>X</b>
 Bounce	+ \$100	+ \$200	<b>B</b>
 N-45	+ \$150	+ \$300	<b>N</b>
 45	+ \$200	+ \$400	<b>T</b>
 Stretta	+ \$200	+ \$400	<b>S</b>
 Fender	+ \$250	+ \$500	<b>F</b>

ELEKTRA SERIES

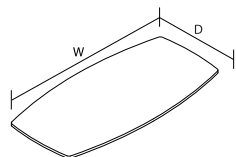

FULL

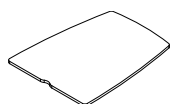

END

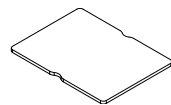

CENTER

D / W	Surface	Base		Edge	Smart-grain See Options Below	Finishes		
		Vibe B	Bridge C			Smart-grain (+ \$100) Yes = A No = -	Surface	Edge
		\$	\$					
36 66	XEF3666	1150	1300	<input type="checkbox"/>	<input type="checkbox"/>	<input type="checkbox"/>	<input type="checkbox"/>	<input type="checkbox"/>
36 96	XEF3696	1720	1870	<input type="checkbox"/>	<input type="checkbox"/>	<input type="checkbox"/>	<input type="checkbox"/>	<input type="checkbox"/>
48 66	XEF4866	1210	1360	<input type="checkbox"/>	<input type="checkbox"/>	<input type="checkbox"/>	<input type="checkbox"/>	<input type="checkbox"/>
48 96	XEF4896	1775	1925	<input type="checkbox"/>	<input type="checkbox"/>	<input type="checkbox"/>	<input type="checkbox"/>	<input type="checkbox"/>
48 66	XEE4866	1210	1360	<input type="checkbox"/>	<input type="checkbox"/>	<input type="checkbox"/>	<input type="checkbox"/>	<input type="checkbox"/>
60 66	XEE6066	1290	1440	<input type="checkbox"/>	<input type="checkbox"/>	<input type="checkbox"/>	<input type="checkbox"/>	<input type="checkbox"/>
48 36	XEC4836	950	1100	<input type="checkbox"/>	<input type="checkbox"/>	<input type="checkbox"/>	<input type="checkbox"/>	<input type="checkbox"/>
48 66	XEC4866	1210	1360	<input type="checkbox"/>	<input type="checkbox"/>	<input type="checkbox"/>	<input type="checkbox"/>	<input type="checkbox"/>
48 96	XEC4896	1775	1925	<input type="checkbox"/>	<input type="checkbox"/>	<input type="checkbox"/>	<input type="checkbox"/>	<input type="checkbox"/>
60 36	XEC6036	1085	1235	<input type="checkbox"/>	<input type="checkbox"/>	<input type="checkbox"/>	<input type="checkbox"/>	<input type="checkbox"/>
60 66	XEC6066	1350	1500	<input type="checkbox"/>	<input type="checkbox"/>	<input type="checkbox"/>	<input type="checkbox"/>	<input type="checkbox"/>
60 96	XEC6096	1860	2010	<input type="checkbox"/>	<input type="checkbox"/>	<input type="checkbox"/>	<input type="checkbox"/>	<input type="checkbox"/>

APPLICATION

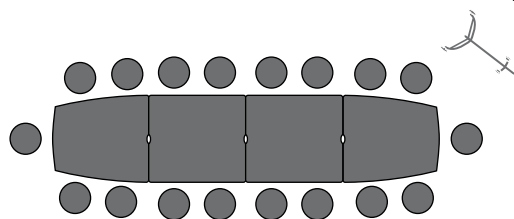
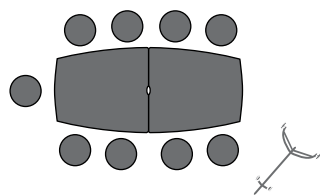

INDEX

MARKERBOARDS	188
LEGS	190
EXTENSION ASSEMBLY	194
EDGES	195
FUSION VALUE	196

Smartgrain

Smartgrain laminates feature a unique finish with gloss and texture similar to real-wood laminates. See page 230 for details.

EDGES

	Add \$	Edge Code
Xylo	+ \$00	<b>X</b>
Bounce	+ \$100	<b>B</b>
N-45	+ \$150	<b>N</b>
45	+ \$200	<b>T</b>
Stretta	+ \$200	<b>S</b>
Fender	+ \$250	<b>F</b>

KNIFE SERIES

D / W	Surface	Base	Edge	Smart-grain	Finishes		
					Surface	Edge	Base
		Vibe <b>B</b>	See Options Below	Smart-grain (+ \$100) Yes = A No = -			
		Left = <b>L</b> or Right = <b>R</b>					
		\$					
30 60	XKN3060	<input type="checkbox"/>	910	<input type="checkbox"/>	<input type="checkbox"/>	<input type="checkbox"/>	<input type="checkbox"/>
30 72	XKN3072	<input type="checkbox"/>	970	<input type="checkbox"/>	<input type="checkbox"/>	<input type="checkbox"/>	<input type="checkbox"/>
36 84	XKN3684	<input type="checkbox"/>	1585	<input type="checkbox"/>	<input type="checkbox"/>	<input type="checkbox"/>	<input type="checkbox"/>
36 96	XKN3696	<input type="checkbox"/>	1720	<input type="checkbox"/>	<input type="checkbox"/>	<input type="checkbox"/>	<input type="checkbox"/>

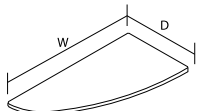

**KNIFE**  
(left hand shown)

APPLICATION





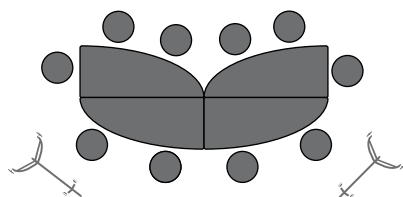
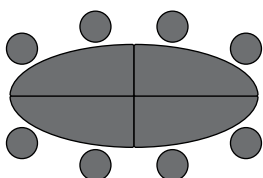
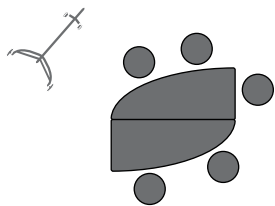

INDEX

EDGES



MARKERBOARDS	188
LEGS	190
EXTENSION ASSEMBLY	194
EDGES	195
FUSION VALUE	196

**Smartgrain**  
Smartgrain laminates feature a unique finish with gloss and texture similar to real-wood laminates. See page 230 for details.

	Add \$	Edge Code
	+ \$00	<b>X</b>
	+ \$100	<b>B</b>
	+ \$150	<b>N</b>
	+ \$200	<b>T</b>
	+ \$200	<b>S</b>
	+ \$250	<b>F</b>

# STORAGE



Moto



Cab (single)

Cab (double)



Sidekick Pedestal

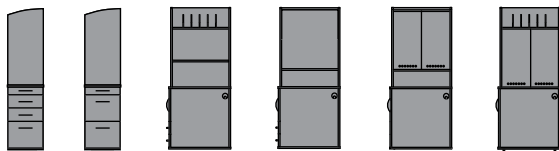

Sidekick Tower

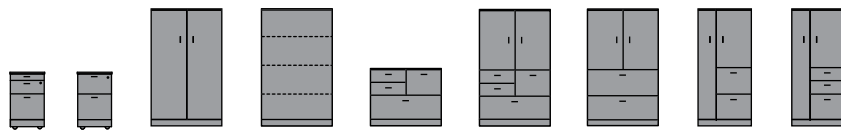

Cadence Private Office



Cadence Central Storage

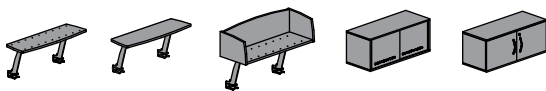

Overdesk Storage

<b>Moto</b>	<b>154</b>
<b>Cab (single)</b>	<b>155</b>
<b>Cab (double)</b>	<b>156</b>

<i>SIDEKICK</i>	
<b>Pedestal</b>	<b>157</b>
<b>Tower</b>	<b>159</b>

<i>CADENCE</i>	
<b>Private Office</b>	<b>161</b>
<b>Central Storage</b>	<b>167</b>

<b>Overdesk Storage</b>	<b>169</b>
-------------------------	------------

MOTO

D / W / H	Product	Price	Pull	See Options Below	Contrast / Smartgrain	Finishes	
						Case	Door/Drawer Face
		\$			<b>N</b> = No <b>C</b> = Contrasting <b>A</b> = Smartgrain		
22 17 24	MBF-22	875	<input type="checkbox"/>		N	<input type="checkbox"/>	-
22 17 24	MBF-22	966	<input type="checkbox"/>		C	<input type="checkbox"/>	<input type="checkbox"/>
22 17 24	MBF-22	1066	<input type="checkbox"/>		A	<input type="checkbox"/>	<input type="checkbox"/>
30 17 24	MBF-30	985	<input type="checkbox"/>		N	<input type="checkbox"/>	-
30 17 24	MBF-30	1076	<input type="checkbox"/>		C	<input type="checkbox"/>	<input type="checkbox"/>
30 17 24	MBF-30	1176	<input type="checkbox"/>		A	<input type="checkbox"/>	<input type="checkbox"/>
22 17 26	MPBF-22	961	<input type="checkbox"/>		N	<input type="checkbox"/>	-
22 17 26	MPBF-30	1052	<input type="checkbox"/>		C	<input type="checkbox"/>	<input type="checkbox"/>
22 17 26	MPBF-22	1152	<input type="checkbox"/>		A	<input type="checkbox"/>	<input type="checkbox"/>
30 17 26	MPBF-30	1070	<input type="checkbox"/>		N	<input type="checkbox"/>	-
30 17 26	MPBF-30	1161	<input type="checkbox"/>		C	<input type="checkbox"/>	<input type="checkbox"/>
30 17 26	MPBF-30	1261	<input type="checkbox"/>		A	<input type="checkbox"/>	<input type="checkbox"/>
23 32 19	TPR	839	<input type="checkbox"/>		N	<input type="checkbox"/>	-
23 32 19	TPR	930	<input type="checkbox"/>		C	<input type="checkbox"/>	<input type="checkbox"/>
23 32 19	TPR	1030	<input type="checkbox"/>		A	<input type="checkbox"/>	<input type="checkbox"/>



BOX, FILE



PENCIL, BOX, FILE



PRINTER TROLLEY

PRODUCT NOTES

Motos are independent mobile storage products. Mobile bases incorporate two pivoting locking and two fixed-direction non-locking casters. The Printer Trolley uses four pivoting locking casters.

Specified dimensions refer to footprint sizing.

File drawers include rails for letter (width) or legal (depth) suspended file folders. Counterbalances are standard on all file drawer Motos.

Randomly keyed locks are standard on all storage products except slider and tambour doors.

Storage locks can be specified "keyed alike" if required. Contact Customer Service for information.

INDEX

STORAGE ACCESSORIES	180
FINISHES	230

Storage functionality can be extended with the addition of Werkwalls (page 180) and Werktools (page 182).

PULLS

Pull	Pull Color	Pull Code
Jota	Silver Black	<b>J</b> <b>K</b>
Alto	Silver	<b>A</b>

CAB (SINGLE)

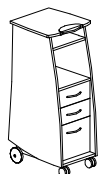

TWO BOX, FILE



PENCIL, BOX, FILE



HINGED DOOR

D / W / H

24 19 47  
24 19 47  
24 19 47

24 19 47  
24 19 47  
24 19 47

24 19 47  
24 19 47  
24 19 47

Product	Tambour Doors		Pull	Contrast / Smartgrain	Finishes	
	N = No	T = Yes			Case	Drawer Face
	Price	Price				
	\$	\$				
CS2BF	1180	1331	<input type="checkbox"/>	N	<input type="checkbox"/> <input type="checkbox"/>	-
CS2BF	1271	1423	<input type="checkbox"/>	C	<input type="checkbox"/> <input type="checkbox"/>	<input type="checkbox"/> <input type="checkbox"/>
CS2BF	1371	1523	<input type="checkbox"/>	A	<input type="checkbox"/> <input type="checkbox"/>	<input type="checkbox"/> <input type="checkbox"/>
CSPBF	1130	1283	<input type="checkbox"/>	N	<input type="checkbox"/> <input type="checkbox"/>	-
CSPBF	1221	1373	<input type="checkbox"/>	C	<input type="checkbox"/> <input type="checkbox"/>	<input type="checkbox"/> <input type="checkbox"/>
CSPBF	1321	1473	<input type="checkbox"/>	A	<input type="checkbox"/> <input type="checkbox"/>	<input type="checkbox"/> <input type="checkbox"/>
CSD	942	1094	<input type="checkbox"/>	N	<input type="checkbox"/> <input type="checkbox"/>	-
CSD	1033	1185	<input type="checkbox"/>	C	<input type="checkbox"/> <input type="checkbox"/>	<input type="checkbox"/> <input type="checkbox"/>
CSD	1133	1285	<input type="checkbox"/>	A	<input type="checkbox"/> <input type="checkbox"/>	<input type="checkbox"/> <input type="checkbox"/>

PRODUCT NOTES

Cabs are independent mobile storage products. Mobile bases incorporate two pivoting locking and two fixed-direction non-locking casters.

Specified dimensions refer to footprint sizing.

File drawers include rails for letter (width) or legal (depth) suspended file folders.

Transport handles are standard on all Single Cabs.

Randomly keyed locks are standard on all storage products except slider and tambour doors.

Storage locks can be specified "keyed alike" if required. Contact Customer Service for information.

INDEX

STORAGE ACCESSORIES	180
FINISHES	230

Storage functionality can be extended with the addition of Werkwalls (page 180) and Werktools (page 182).

PULLS

	Pull	Pull Color	Pull Code
	Jota	Silver Black	J K
	Alto	Silver	A

CAB (DOUBLE)

D / W / H	Product	Tambour Doors		Pull	Contrast / Smartgrain	Finishes	
		N = No Price	T = Yes Price			Case	Door/Drawer Face
		\$					
24 36 47	CO2BL	1647	-	<input type="checkbox"/>	N	<input type="checkbox"/>	-
24 36 47	CO2BL	1738	-	<input type="checkbox"/>	C	<input type="checkbox"/>	<input type="checkbox"/>
24 36 47	CO2BL	1838	-	<input type="checkbox"/>	A	<input type="checkbox"/>	<input type="checkbox"/>
24 36 47	COD	1185	-	<input type="checkbox"/>	N	<input type="checkbox"/>	-
24 36 47	COD	1276	-	<input type="checkbox"/>	C	<input type="checkbox"/>	<input type="checkbox"/>
24 36 47	COD	1376	-	<input type="checkbox"/>	A	<input type="checkbox"/>	<input type="checkbox"/>
24 36 47	CD2BL	1921	2164	<input type="checkbox"/>	N	<input type="checkbox"/>	-
24 36 47	CD2BL	2012	2255	<input type="checkbox"/>	C	<input type="checkbox"/>	<input type="checkbox"/>
24 36 47	CD2BL	2112	2355	<input type="checkbox"/>	A	<input type="checkbox"/>	<input type="checkbox"/>

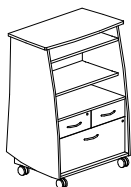

OPEN TWO BOX, LATERAL

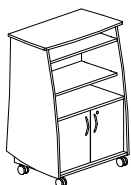

OPEN HINGED DOORS

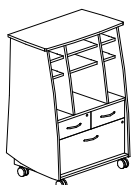

DIVIDED TWO BOX, LATERAL

PRODUCT NOTES

Cabs are independent mobile storage products. Mobile bases incorporate four pivoting non-locking casters.

Specified dimensions refer to footprint sizing.

File drawers include rails for letter (width) or legal (depth) suspended file folders.

Randomly keyed locks are standard on all storage products except slider and tambour doors.

Storage locks can be specified "keyed alike" if required. Contact Customer Service for information.







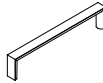



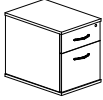





































INDEX

STORAGE ACCESSORIES	180
FINISHES	230

PULLS

Pull	Pull Color	Pull Code
 Jota	Silver Black	J K
 Alto	Silver	A

**SIDEKICK PEDESTAL**

	D / W / H	Product	Price	Base		Pull	Contrast / Smartgrain	Finishes	
				Fixed F	Mobile M			Case	Drawer Face
 <p><b>BOX, FILE</b></p>	19 16 19	SFPBF19	680	<input type="checkbox"/>	<input type="checkbox"/>		N		-
	19 16 19	SFPBF19	772	<input type="checkbox"/>	<input type="checkbox"/>		C		
	19 16 19	SFPBF19	872	<input type="checkbox"/>	<input type="checkbox"/>		A		
	23 16 19	SFPBF23	730	<input type="checkbox"/>	<input type="checkbox"/>		N		-
	23 16 19	SFPBF23	821	<input type="checkbox"/>	<input type="checkbox"/>		C		
	23 16 19	SFPBF23	921	<input type="checkbox"/>	<input type="checkbox"/>		A		
	29 16 19	SFPBF29	790	<input type="checkbox"/>	<input type="checkbox"/>		N		-
	29 16 19	SFPBF29	882	<input type="checkbox"/>	<input type="checkbox"/>		C		
	29 16 19	SFPBF29	982	<input type="checkbox"/>	<input type="checkbox"/>		A		
 <p><b>PENCIL, BOX, FILE</b></p>	19 16 23	SFPPBF19	802	<input type="checkbox"/>	<input type="checkbox"/>		N		-
	19 16 23	SFPPBF19	894	<input type="checkbox"/>	<input type="checkbox"/>		C		
	19 16 23	SFPPBF19	994	<input type="checkbox"/>	<input type="checkbox"/>		A		
	23 16 23	SFPPBF23	851	<input type="checkbox"/>	<input type="checkbox"/>		N		-
	23 16 23	SFPPBF23	942	<input type="checkbox"/>	<input type="checkbox"/>		C		
	23 16 23	SFPPBF23	1042	<input type="checkbox"/>	<input type="checkbox"/>		A		
	29 16 23	SFPPBF29	911	<input type="checkbox"/>	<input type="checkbox"/>		N		-
	29 16 23	SFPPBF29	1003	<input type="checkbox"/>	<input type="checkbox"/>		C		
	29 16 23	SFPPBF29	1103	<input type="checkbox"/>	<input type="checkbox"/>		A		
 <p><b>TWO BOX, FILE</b></p>	19 16 26	SFP2BF19	821	<input type="checkbox"/>	<input type="checkbox"/>		N		-
	19 16 26	SFP2BF19	911	<input type="checkbox"/>	<input type="checkbox"/>		C		
	19 16 26	SFP2BF19	1011	<input type="checkbox"/>	<input type="checkbox"/>		A		
	23 16 26	SFP2BF23	869	<input type="checkbox"/>	<input type="checkbox"/>		N		-
	23 16 26	SFP2BF23	961	<input type="checkbox"/>	<input type="checkbox"/>		C		
	23 16 26	SFP2BF23	1061	<input type="checkbox"/>	<input type="checkbox"/>		A		
	29 16 26	SFP2BF29	930	<input type="checkbox"/>	<input type="checkbox"/>		N		-
	29 16 26	SFP2BF29	1021	<input type="checkbox"/>	<input type="checkbox"/>		C		
	29 16 26	SFP2BF29	1121	<input type="checkbox"/>	<input type="checkbox"/>		A		

**PRODUCT NOTES**

Mobile pedestals, 23 and 29 inches deep, may interfere with structural elements of larger desks. Contact factory for assistance.

Randomly keyed locks are standard on all storage products except slider and tambour doors.

Storage locks can be specified "keyed alike" if required. Contact Customer Service for information.

Due to the height-adjustable nature of Fusion desks, please exercise care to ensure clearance when specifying pedestals for placement under desks. See page 199 for details.

**BASE**

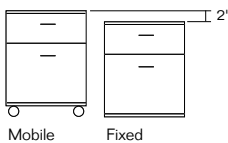

Option	Add \$	Code
Fixed	+ \$00	<b>F</b>
Mobile	+ \$25	<b>M</b>

**MOBILE PEDESTALS**



**Note:** Mobile pedestals are 2 inches taller than fixed pedestals.

**PULLS**

Pull	Pull Color	Pull Code
 Jota	Silver Black	<b>J</b> <b>K</b>
 Alto	Silver	<b>A</b>

**SIDEKICK PEDESTAL**

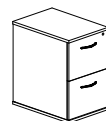

**TWO FILE**

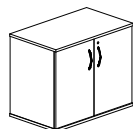

**DOORS W/ SHELF**

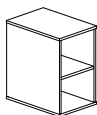

**OPEN, SINGLE**

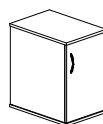

**CLOSED, SINGLE**  
Right hand only

**D / W / H**

Product	Price	Base		Pull	Contrast / Smartgrain	Finishes	
		Fixed <b>F</b>	Mobile <b>M</b>			Case	Drawer Face
	\$			See Options Below			
SFP2F19	759	<input type="checkbox"/>	<input type="checkbox"/>	<input type="checkbox"/>	N	<input type="checkbox"/>	<input type="checkbox"/>
SFP2F19	851	<input type="checkbox"/>	<input type="checkbox"/>	<input type="checkbox"/>	C	<input type="checkbox"/>	<input type="checkbox"/>
SFP2F19	951	<input type="checkbox"/>	<input type="checkbox"/>	<input type="checkbox"/>	A	<input type="checkbox"/>	<input type="checkbox"/>
SFP2F23	809	<input type="checkbox"/>	<input type="checkbox"/>	<input type="checkbox"/>	N	<input type="checkbox"/>	<input type="checkbox"/>
SFP2F23	899	<input type="checkbox"/>	<input type="checkbox"/>	<input type="checkbox"/>	C	<input type="checkbox"/>	<input type="checkbox"/>
SFP2F23	999	<input type="checkbox"/>	<input type="checkbox"/>	<input type="checkbox"/>	A	<input type="checkbox"/>	<input type="checkbox"/>
SFP2F29	869	<input type="checkbox"/>	<input type="checkbox"/>	<input type="checkbox"/>	N	<input type="checkbox"/>	<input type="checkbox"/>
SFP2F29	961	<input type="checkbox"/>	<input type="checkbox"/>	<input type="checkbox"/>	C	<input type="checkbox"/>	<input type="checkbox"/>
SFP2F29	1061	<input type="checkbox"/>	<input type="checkbox"/>	<input type="checkbox"/>	A	<input type="checkbox"/>	<input type="checkbox"/>
SFP2D19	839	-	-	<input type="checkbox"/>	N	<input type="checkbox"/>	<input type="checkbox"/>
SFP2D19	930	-	-	<input type="checkbox"/>	C	<input type="checkbox"/>	<input type="checkbox"/>
SFP2D19	1030	-	-	<input type="checkbox"/>	A	<input type="checkbox"/>	<input type="checkbox"/>
SFPOS19	532	<input type="checkbox"/>	-	-	N	<input type="checkbox"/>	<input type="checkbox"/>
SFPOS23	561	<input type="checkbox"/>	-	-	N	<input type="checkbox"/>	<input type="checkbox"/>
SFPCS19	570	<input type="checkbox"/>	<input type="checkbox"/>	<input type="checkbox"/>	N	<input type="checkbox"/>	<input type="checkbox"/>
SFPCS19	662	<input type="checkbox"/>	<input type="checkbox"/>	<input type="checkbox"/>	C	<input type="checkbox"/>	<input type="checkbox"/>
SFPCS19	762	<input type="checkbox"/>	<input type="checkbox"/>	<input type="checkbox"/>	A	<input type="checkbox"/>	<input type="checkbox"/>
SFPCS23	600	<input type="checkbox"/>	<input type="checkbox"/>	<input type="checkbox"/>	N	<input type="checkbox"/>	<input type="checkbox"/>
SFPCS23	691	<input type="checkbox"/>	<input type="checkbox"/>	<input type="checkbox"/>	C	<input type="checkbox"/>	<input type="checkbox"/>
SFPCS23	791	<input type="checkbox"/>	<input type="checkbox"/>	<input type="checkbox"/>	A	<input type="checkbox"/>	<input type="checkbox"/>

**N** = No  
**C** = Contrasting  
**A** = Smartgrain

**PRODUCT NOTES**

Mobile pedestals, 23 and 29 inches deep, may interfere with structural elements of larger desks. Contact customer service for assistance.

Randomly keyed locks are standard on all storage products except slider and tambour doors.

Storage locks can be specified "keyed alike" if required. Contact Customer Service for information.

Due to the height-adjustable nature of Fusion desks, please exercise care to ensure clearance when specifying pedestals for placement under desks. See page 199 for details.

**INDEX**

Option	Add \$	Code
Fixed	+ \$00	<b>F</b>
Mobile	+ \$25	<b>M</b>

**MOBILE PEDESTALS**

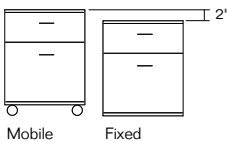

**Note:** Mobile pedestals are 2 inches taller than fixed pedestals.

**PULLS**

Pull	Pull Color	Pull Code
Jota	Silver Black	<b>J</b> <b>K</b>
Alto	Silver	<b>A</b>



**SIDEKICK TOWER**

**DOUBLE HIGH**

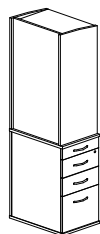

**PENCIL, TWO BOX, FILE**  
(left hand, standard top shown)

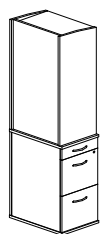

**PENCIL, TWO FILE**  
(left hand, standard top shown)

**D / W / H**

Product	Upper	Pull	Contrast / Smartgrain	Finishes	
				Case	Drawer Face
	Open <b>O</b> Slider <b>S</b> Flipper <b>F</b> Binder/ Open <b>BO</b> Binder/ Slider <b>BS</b>	See Options Below			
	Left = <b>L</b> or Right = <b>R</b>		<b>N</b> = No <b>C</b> = Contrasting <b>A</b> = Smartgrain		
	\$	\$	\$	\$	\$
SDTP2BF23	<input type="checkbox"/>	<input type="checkbox"/>	N	<input type="checkbox"/>	-
SDTP2BF23	<input type="checkbox"/>	<input type="checkbox"/>	C	<input type="checkbox"/>	<input type="checkbox"/>
SDTP2BF23	<input type="checkbox"/>	<input type="checkbox"/>	A	<input type="checkbox"/>	<input type="checkbox"/>
SDTP2BF29	<input type="checkbox"/>	<input type="checkbox"/>	N	<input type="checkbox"/>	-
SDTP2BF29	<input type="checkbox"/>	<input type="checkbox"/>	C	<input type="checkbox"/>	<input type="checkbox"/>
SDTP2BF29	<input type="checkbox"/>	<input type="checkbox"/>	A	<input type="checkbox"/>	<input type="checkbox"/>
SDTP2F23	<input type="checkbox"/>	<input type="checkbox"/>	N	<input type="checkbox"/>	-
SDTP2F23	<input type="checkbox"/>	<input type="checkbox"/>	C	<input type="checkbox"/>	<input type="checkbox"/>
SDTP2F23	<input type="checkbox"/>	<input type="checkbox"/>	A	<input type="checkbox"/>	<input type="checkbox"/>
SDTP2F29	<input type="checkbox"/>	<input type="checkbox"/>	N	<input type="checkbox"/>	-
SDTP2F29	<input type="checkbox"/>	<input type="checkbox"/>	C	<input type="checkbox"/>	<input type="checkbox"/>
SDTP2F29	<input type="checkbox"/>	<input type="checkbox"/>	A	<input type="checkbox"/>	<input type="checkbox"/>

**PRODUCT NOTES**

Sidekick Towers are available in Single High and Double High configurations. Grommets are included for passing cables from the desk height shelf to the side of the tower underneath the desk.

Binder top option includes six shelf dividers for the 29 inch deep tower and five for the 23 inch deep tower.

Active vertical surface elements such as markerboards, werkwalls, and tackable screens are available.

Randomly keyed locks are standard on all storage products except slider and tambour/sliding doors.

Storage locks can be specified "keyed alike" if required. Contact Customer Service for information.

**Ordering**

Select lower section configuration (including depth). Select Left hand or Right hand (Left hand tower positions to left of work surface, Right hand positions to right). Select Upper Configuration (Open, Slider, or Flipper, Binder/ Open, Binder/Slider). Select Pulls, Select Contrast, Non Contrast or Smartgrain and Finish colors.

**INDEX**

<b>SIDEKICK ACCESSORIES</b>	<b>181</b>
<b>SIDEKICK TOWER</b>	<b>201</b>
<b>FINISHES</b>	<b>230</b>

**TOP OPTIONS**

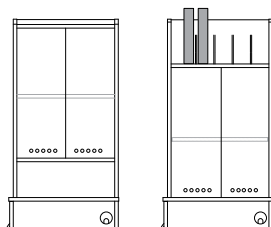

**Standard Top    Binder Top**

Non-binder-top double-high Sidekick Towers feature a 8 inch personal/CD storage shelf.

**PULLS**

Pull	Pull Color	Pull Code
Jota	Silver Black	<b>J</b> <b>K</b>
Alto	Silver	<b>A</b>

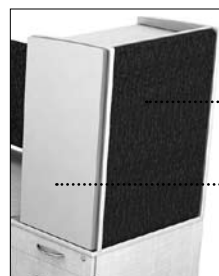

Active vertical surface elements including markerboards, werkwalls, and tackable screens are available, see page 181.



CADENCE PRIVATE OFFICE



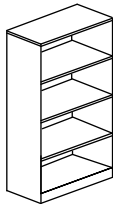















































BOOKCASE - 14 DEEP



14" OPEN BOOKCASES

D / W / H

14 32 28  
14 32 28  
14 32 28  
14 32 42  
14 32 42  
14 32 42  
14 32 54  
14 32 54  
14 32 54  
14 32 66  
14 32 66  
14 32 66

Product	Pull	Contrast / Smartgrain	Finishes
	See Options Below		Case Face
		N = No C = Contrasting A = Smartgrain	 
	Price		
	\$		
CABKO1428	628	- N	 
CABKO1428	719	- C	 
CABKO1428	819	- A	 
CABKO1442	718	- N	 
CABKO1442	809	- C	 
CABKO1442	909	- A	 
CABKO1454	809	- N	 
CABKO1454	900	- C	 
CABKO1454	1000	- A	 
CABKO1466	932	- N	 
CABKO1466	1023	- C	 
CABKO1466	1123	- A	 
CABKC1428	809	<input type="checkbox"/> N	 
CABKC1428	901	<input type="checkbox"/> C	 
CABKC1428	1001	<input type="checkbox"/> A	 
CABKC1442	932	<input type="checkbox"/> N	 
CABKC1442	1023	<input type="checkbox"/> C	 
CABKC1442	1123	<input type="checkbox"/> A	 
CABKC1454	1053	<input type="checkbox"/> N	 
CABKC1454	1144	<input type="checkbox"/> C	 
CABKC1454	1244	<input type="checkbox"/> A	 
CABKC1466	1204	<input type="checkbox"/> N	 
CABKC1466	1296	<input type="checkbox"/> C	 
CABKC1466	1396	<input type="checkbox"/> A	 

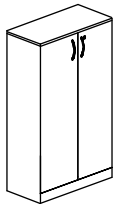

14" CLOSED BOOKCASES

PRODUCT NOTES

Cadence Private Office storage features updated styling for managers and executives.

Cadence Private Office components **do not** match Cadence Central Storage heights.

Specified dimensions refer to footprint sizing. Shelf depths for 14 inch bookcases are 12 inches and shelf depths for 19 inch bookcases are 17 inches.

Bookcases 66 inches and taller, or with doors, come with at least one fixed shelf for stability and locking purposes. All other shelves are adjustable.

Bases include leveling glides incorporated into metal corner brackets.

Randomly keyed locks are standard on all storage products except slider and tambour doors.

Storage locks can be specified "keyed alike" if required. Contact Customer Service for information.

INDEX



FLOATING STORAGE TOP	179
GRAIN DIRECTION	198
FINISHES	230

Floating Storage Top

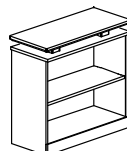
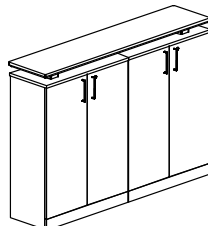
28 high and 42 high Cadence Private Office components can be used with the Cadence Floating Storage Top. Specify matching depths for Floating Storage Tops and cabinets. See page 179 for more details.



PULLS

Pull	Pull Color	Pull Code
 Jota	Silver Black	J K
 Alto	Silver	A

CADENCE PRIVATE OFFICE

BOOKCASE - 19 DEEP

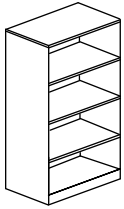



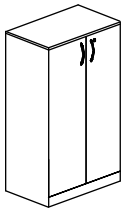



























































19" OPEN BOOKCASES



19" CLOSED BOOKCASES

D / W / H

19	32	28
19	32	28
19	32	28
19	32	42
19	32	42
19	32	42
19	32	54
19	32	54
19	32	54
19	32	66
19	32	66
19	32	66
19	32	78
19	32	78
19	32	78
19	32	28
19	32	28
19	32	28
19	32	42
19	32	42
19	32	42
19	32	54
19	32	54
19	32	54
19	32	66
19	32	66
19	32	66
19	32	78
19	32	78
19	32	78

Product	Pull	Contrast / Smartgrain	Finishes
	See Options Below		Case Face
	Price	N = No C = Contrasting A = Smartgrain	 
	\$		
CABKO1928	658	N	 
CABKO1928	749	C	 
CABKO1928	849	A	 
CABKO1942	780	N	 
CABKO1942	871	C	 
CABKO1942	971	A	 
CABKO1954	901	N	 
CABKO1954	992	C	 
CABKO1954	1092	A	 
CABKO1966	1053	N	 
CABKO1966	1144	C	 
CABKO1966	1244	A	 
CABKO1978	1228	N	 
CABKO1978	1319	C	 
CABKO1978	1419	A	 
CABKC1928	871	N	 
CABKC1928	961	C	 
CABKC1928	1061	A	 
CABKC1942	992	N	 
CABKC1942	1083	C	 
CABKC1942	1183	A	 
CABKC1954	1144	N	 
CABKC1954	1235	C	 
CABKC1954	1335	A	 
CABKC1966	1296	N	 
CABKC1966	1387	C	 
CABKC1966	1487	A	 
CABKC1978	1471	N	 
CABKC1978	1562	C	 
CABKC1978	1662	A	 

PRODUCT NOTES

Cadence Private Office storage features updated styling for managers and executives.

Cadence Private Office components **do not** match Cadence Central Storage heights.

Specified dimensions refer to footprint sizing. Shelf depths for 14 inch bookcases are 12 inches and shelf depths for 19 inch bookcases are 17 inches.

Bookcases 66 inches and taller, or with doors, come with at least one fixed shelf for stability and locking purposes. All other shelves are adjustable.

Bases include leveling glides incorporated into metal corner brackets.

Randomly keyed locks are standard on all storage products except slider and tambour doors.

Storage locks can be specified "keyed alike" if required. Contact Customer Service for information.

INDEX



FLOATING STORAGE TOP	179
GRAIN DIRECTION	198
FINISHES	230

Floating Storage Top

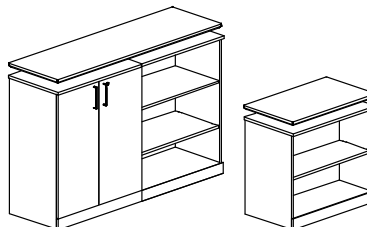
28 high and 42 high Cadence Private Office components can be used with the Cadence Floating Storage Top. Specify matching depths for Floating Storage Tops and cabinets. See page 179 for more details.



PULLS

Pull	Pull Color	Pull Code
 Jota	Silver Black	J K
 Alto	Silver	A

CADENCE PRIVATE OFFICE

COMBO STORAGE

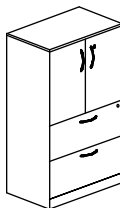

TWO LATERAL COMBO CLOSED

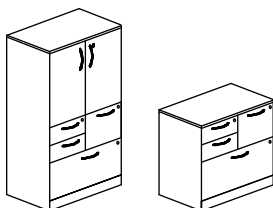

TWO BOX FILE, LATERAL COMBO, CLOSED

D / W / H

19	32	42
19	32	42
19	32	42
19	32	54
19	32	54
19	32	54
19	32	66
19	32	66
19	32	66
19	32	28
19	32	28
19	32	28
19	32	42
19	32	42
19	32	42
19	32	54
19	32	54
19	32	54
19	32	66
19	32	66
19	32	66

Product	Price	Pull	Contrast / Smartgrain	Case	Face
	\$				
CACOM2L42	1478	<input type="checkbox"/>	N	<input type="checkbox"/>	-
CACOM2L42	1570	<input type="checkbox"/>	C	<input type="checkbox"/>	<input type="checkbox"/>
CACOM2L42	1670	<input type="checkbox"/>	A	<input type="checkbox"/>	<input type="checkbox"/>
CACOM2L54	1600	<input type="checkbox"/>	N	<input type="checkbox"/>	-
CACOM2L54	1692	<input type="checkbox"/>	C	<input type="checkbox"/>	<input type="checkbox"/>
CACOM2L54	1792	<input type="checkbox"/>	A	<input type="checkbox"/>	<input type="checkbox"/>
CACOM2L66	1721	<input type="checkbox"/>	N	<input type="checkbox"/>	-
CACOM2L66	1813	<input type="checkbox"/>	C	<input type="checkbox"/>	<input type="checkbox"/>
CACOM2L66	1913	<input type="checkbox"/>	A	<input type="checkbox"/>	<input type="checkbox"/>
CACOM2BFL28	1418	<input type="checkbox"/>	N	<input type="checkbox"/>	-
CACOM2BFL28	1509	<input type="checkbox"/>	C	<input type="checkbox"/>	<input type="checkbox"/>
CACOM2BFL28	1609	<input type="checkbox"/>	A	<input type="checkbox"/>	<input type="checkbox"/>
CACOM2BFL42	1758	<input type="checkbox"/>	N	<input type="checkbox"/>	-
CACOM2BFL42	1849	<input type="checkbox"/>	C	<input type="checkbox"/>	<input type="checkbox"/>
CACOM2BFL42	1949	<input type="checkbox"/>	A	<input type="checkbox"/>	<input type="checkbox"/>
CACOM2BFL54	1940	<input type="checkbox"/>	N	<input type="checkbox"/>	-
CACOM2BFL54	2032	<input type="checkbox"/>	C	<input type="checkbox"/>	<input type="checkbox"/>
CACOM2BFL54	2132	<input type="checkbox"/>	A	<input type="checkbox"/>	<input type="checkbox"/>
CACOM2BFL66	2062	<input type="checkbox"/>	N	<input type="checkbox"/>	-
CACOM2BFL66	2154	<input type="checkbox"/>	C	<input type="checkbox"/>	<input type="checkbox"/>
CACOM2BFL66	2254	<input type="checkbox"/>	A	<input type="checkbox"/>	<input type="checkbox"/>

PRODUCT NOTES

Cadence Private Office storage features updated styling for managers and executives.

Cadence Private Office components **do not** match Cadence Central Storage heights.

File drawers include rails for letter (width) or legal (depth) suspended file folders. Counterbalances are standard on all file drawer Laterals.

Bases include leveling glides incorporated into metal corner brackets.

Shelves are 17 inches deep.

Randomly keyed locks are standard on all storage products except slider and tambour doors.

Storage locks can be specified "keyed alike" if required. Contact Customer Service for information.

INDEX

FLOATING STORAGE TOP	179
GRAIN DIRECTION	198
FINISHES	230

Floating Storage Top

28 high and 42 high Cadence Private Office components can be used with the Cadence Floating Storage Top. Specify matching depths for Floating Storage Tops and cabinets. See page 179 for more details.

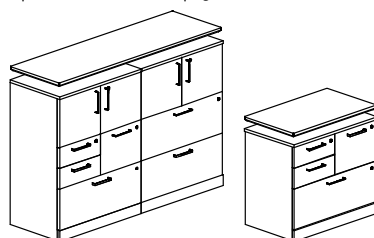

PULLS

Pull	Pull Color	Pull Code
Jota	Silver Black	J K
Alto	Silver	A



CADENCE PRIVATE OFFICE

WARDROBE - 24 DEEP



WARDROBE, CLOSED  
TWO FILE



WARDROBE, CLOSED  
TWO BOX, FILE

D / W / H

24 24 54  
24 24 54  
24 24 54  
  
24 24 66  
24 24 66  
24 24 66

Product	Price	Pull	See Options Below	Contrast / Smartgrain	Finishes
	\$			N = No C = Contrasting A = Smartgrain	Case Face
CAW2F2454	1387	<input type="checkbox"/>		N	
CAW2F2454	1478	<input type="checkbox"/>		C	
CAW2F2454	1578	<input type="checkbox"/>		A	
CAW2F2466	1509	<input type="checkbox"/>		N	
CAW2F2466	1600	<input type="checkbox"/>		C	
CAW2F2466	1700	<input type="checkbox"/>		A	
CAW2BF2454	1570	<input type="checkbox"/>		N	
CAW2BF2454	1661	<input type="checkbox"/>		C	
CAW2BF2454	1761	<input type="checkbox"/>		A	
CAW2BF2466	1692	<input type="checkbox"/>		N	
CAW2BF2466	1783	<input type="checkbox"/>		C	
CAW2BF2466	1883	<input type="checkbox"/>		A	

PRODUCT NOTES

Cadence Private Office storage features updated styling for managers and executives.

Cadence Private Office components **do not** match Cadence Central Storage heights.

Wardrobes come with one fixed shelf for stability and locking purposes. All other shelves are adjustable.

The Wardrobe section includes a rod for hanging clothes.

Bases include leveling glides incorporated into metal corner brackets.

Randomly keyed locks are standard on all storage products except slider and tambour doors.

Storage locks can be specified "keyed alike" if required. Contact Customer Service for information.

INDEX

GRAIN DIRECTION	198
FINISHES	231

PULLS

Pull	Pull Color	Pull Code
Jota	Silver Black	<b>J</b> <b>K</b>
Alto	Silver	<b>A</b>

CADENCE CENTRAL STORAGE

LATERAL FILE

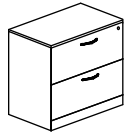

2 LATERAL





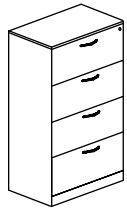

















3 LATERAL



4 LATERAL

D / W / H

Product	Pull	Contrast / Smartgrain	Finishes
	See Options Below		Case Face
	Price	N = No C = Contrasting A = Smartgrain	 
	\$		
19 32 28 CACS2L	1077 <input type="checkbox"/>	N	 
19 32 28 CACS2L	1168 <input type="checkbox"/>	C	 
19 32 28 CACS2L	1268 <input type="checkbox"/>	A	 
19 32 40 CACS3L	1394 <input type="checkbox"/>	N	 
19 32 40 CACS3L	1485 <input type="checkbox"/>	C	 
19 32 40 CACS3L	1585 <input type="checkbox"/>	A	 
19 32 52 CACS4L	1709 <input type="checkbox"/>	N	 
19 32 52 CACS4L	1801 <input type="checkbox"/>	C	 
19 32 52 CACS4L	1901 <input type="checkbox"/>	A	 

PRODUCT NOTES

Cadence Central Storage is designed for workroom and large scale storage applications

Cadence Central Storage components **do not** match Cadence Private Office heights.

File drawers include rails for letter (width) or legal (depth) suspended file folders. Counterbalances are standard on all file and lateral drawer cabinets.

Bases include leveling glides incorporated into metal corner brackets.

Randomly keyed locks are standard on all storage products except slider and tambour doors.

Storage locks can be specified "keyed alike" if required. Contact Customer Service for information.



INDEX

FLOATING STORAGE TOP	179
GRAIN DIRECTION	198
FINISHES	230

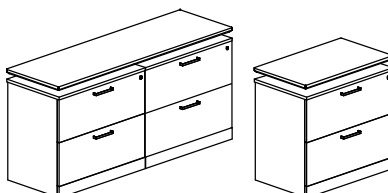
**Floating Storage Top**  
28 high and 40 high Cadence Central Storage components can be used with the Cadence Floating Storage Top. Specify matching depths for Floating Storage Tops and cabinets. See page 179 for more details.



PULLS

Pull	Pull Color	Pull Code
 Jota	Silver Black	J K
 Alto	Silver	A

CADENCE CENTRAL STORAGE

BOOKCASE

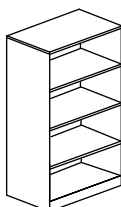

19" OPEN STORAGE

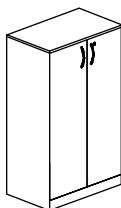

19" CLOSED STORAGE

D / W / H

19 32 40  
19 32 40  
19 32 40  
19 32 52  
19 32 52  
19 32 52

Product	Price	Pull	Contrast / Smartgrain	Case	Face
	\$				
CACSO40	756	-	N		-
CACSO40	847	-	C		
CACSO40	947	-	A		
CACSO52	877	-	N		-
CACSO52	968	-	C		
CACSO52	1068	-	A		
CACSC40	968	<input type="checkbox"/>	N		-
CACSC40	1059	<input type="checkbox"/>	C		
CACSC40	1159	<input type="checkbox"/>	A		
CACSC52	1114	<input type="checkbox"/>	N		-
CACSC52	1205	<input type="checkbox"/>	C		
CACSC52	1305	<input type="checkbox"/>	A		

See Options Below  
N = No  
C = Contrasting  
A = Smartgrain

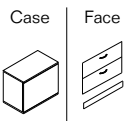

PRODUCT NOTES

Cadence Central Storage is designed for workroom and large scale storage applications

Cadence Central Storage components **do not** match Cadence Private Office heights.

Bases include leveling glides incorporated into metal corner brackets.

Randomly keyed locks are standard on all storage products except slider and tambour doors.

Storage locks can be specified "keyed alike" if required. Contact Customer Service for information.

INDEX

FLOATING STORAGE TOP	179
GRAIN DIRECTION	198
FINISHES	230

Floating Storage Top



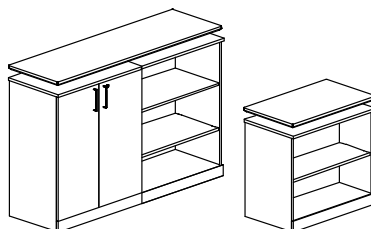







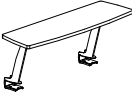







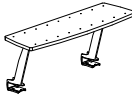





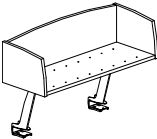







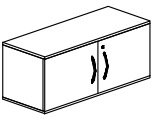















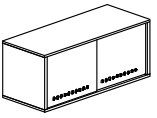







28 high and 40 high Cadence Central Storage components can be used with the Cadence Floating Storage Top. Specify matching depths for Floating Storage Tops and cabinets. See page 179 for more details.



PULLS

Pull	Pull Color	Pull Code
Jota	Silver Black	J K
Alto	Silver	A

OVERDESK

OVERDESK	D / W / H	Product	Support		Pull	Contrast / Smartgrain	Finishes		
			Wall Mounted <b>W</b>	Desk Mounted <b>B</b>			See Options Below	Case	Door
 <b>FLAT OVERDESK SHELF</b>	11 24 12	SMS24	\$	\$	-	-			
	11 30 12	SMS30	-	279	-	-		-	
	11 36 12	SMS36	-	279	-	-		-	
 <b>FLAT OVERDESK SHELF</b> with Dividers	11 24 12	SMP24	-	304	-	-		-	
	11 30 12	SMP30	-	304	-	-		-	
	11 36 12	SMP36	-	304	-	-		-	
 <b>ARCHED OVERDESK SHELF</b>	14 24 12	ODA24	340	-	-	N		-	-
	14 30 12	ODA30	347	-	-	N		-	-
	14 36 12	ODA36	352	-	-	N		-	-
	14 24 12	ODA24	-	425	-	N		-	
	14 30 12	ODA30	-	432	-	N		-	
	14 36 12	ODA36	-	437	-	N		-	
 <b>CLOSED OVERDESK W/DOORS</b>	14 24 15	ODD24	547	-		N		-	-
	14 24 15	ODD24	637	-		C			-
	14 24 15	ODD24	737	-		A			-
	14 30 15	ODD30	565	-		N		-	-
	14 30 15	ODD30	655	-		C			-
	14 30 15	ODD30	755	-		A			-
 <b>CLOSED OVERDESK W/SLIDER DOORS</b>	14 36 15	ODD36	608	-		N		-	-
	14 36 15	ODD36	698	-		C			-
	14 36 15	ODD36	798	-		A			-
	14 24 15	ODP24	547	-	-	N		-	-
	14 30 15	ODP30	565	-	-	N		-	-
	14 36 15	ODP36	608	-	-	N		-	-
 <b>CLOSED OVERDESK W/SLIDER DOORS</b>	14 24 15	ODP24	-	638	-	N		-	
	14 30 15	ODP30	-	656	-	N		-	
	14 36 15	ODP36	-	700	-	N		-	

PRODUCT NOTES

The Flat Overdesk Shelf is desk-mounted 12 inches above the worksurface. Shelf brackets are angled to support the center of the shelf and attach to the edge of the worksurface.

The Flat Overdesk Shelf with Dividers ships with five Shelf Dividers.



Arched Overdesk Shelf provides storage for books, binders and literature. Can be ordered in either wall or desk-mounted configurations. Desk-mounted 12 inch shelf height allows for storage of similar items beneath the shelf.

Desk Mounted shelf bracket is 12 inches tall and attaches to the edge of the worksurface.

Randomly keyed locks are standard on all storage products except slider and tambour/sliding doors.

Storage locks can be specified "keyed alike" if required. Contact Customer Service for information.

PULLS

Pull	Pull Color	Pull Code
 Jota	Silver Black	<b>J</b> <b>K</b>
 Alto	Silver	<b>A</b>

# NOTES

**For Customer Service Inquiries, please contact:**

**800.426.1202**

**360.394.1322** *fax*

[www.watsondesking.com](http://www.watsondesking.com)

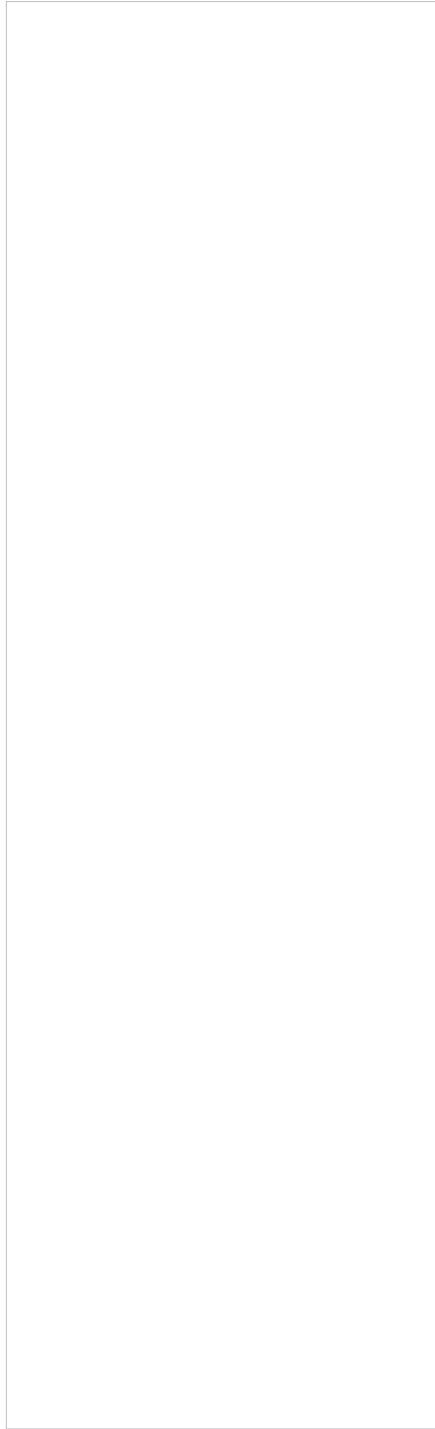
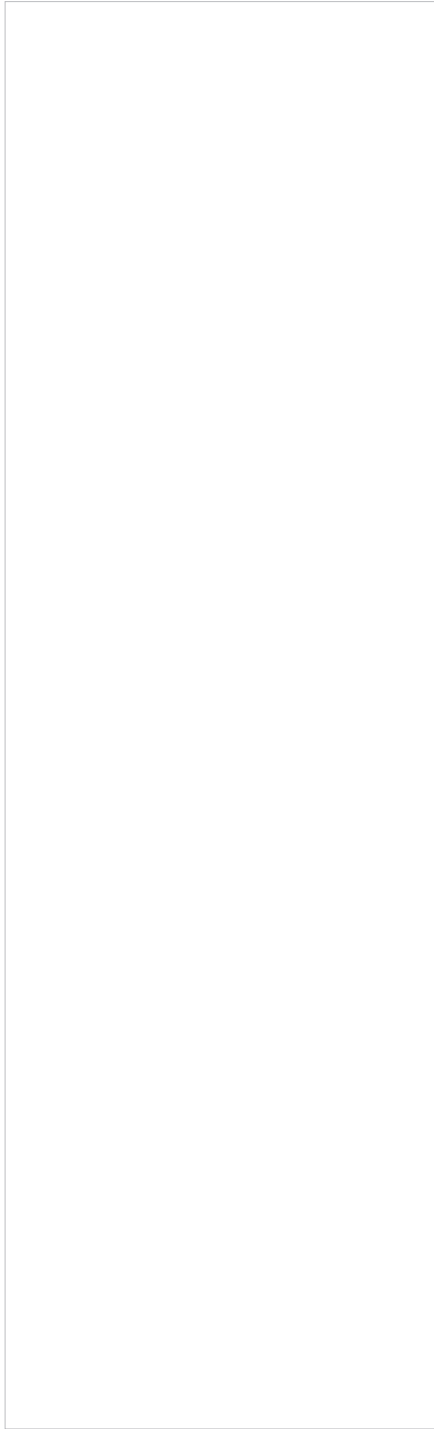
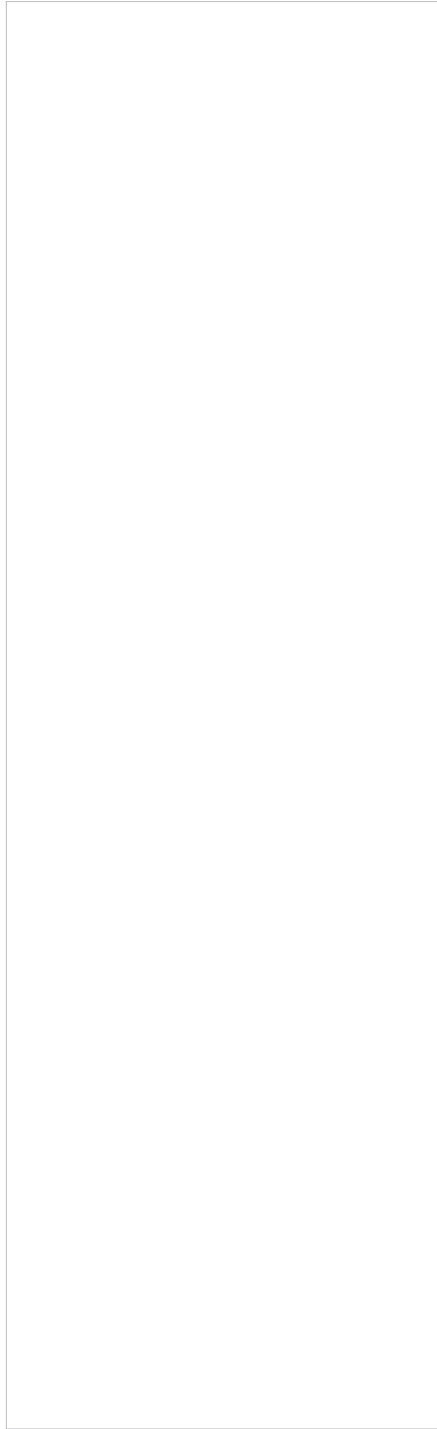

# PRIVACY

Desk-Mounted Privacy 172

DESK-MOUNTED PRIVACY

For Worksurface Widths: 24" - 60"

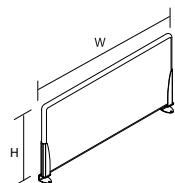

RECTANGULAR

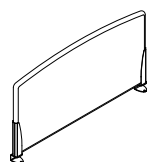

CENTER ARCH

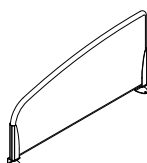

SLOPED LEFT / RIGHT  
(left shown)

W / H		Product	Price	Finishes	
			\$	Fabric	Powder (bracket)
24	12	PPR-2412	297	□□	□□
30	12	PPR-3012	310	□□	□□
36	12	PPR-3612	322	□□	□□
42	12	PPR-4212	334	□□	□□
48	12	PPR-4812	347	□□	□□
54	12	PPR-5412	359	□□	□□
60	12	PPR-6012	371	□□	□□
24	18	PPR-2418	316	□□	□□
30	18	PPR-3018	328	□□	□□
36	18	PPR-3618	340	□□	□□
42	18	PPR-4218	352	□□	□□
48	18	PPR-4818	365	□□	□□
54	18	PPR-5418	377	□□	□□
60	18	PPR-6018	389	□□	□□
24	24	PPR-2424	328	□□	□□
30	24	PPR-3024	347	□□	□□
36	24	PPR-3624	359	□□	□□
42	24	PPR-4224	371	□□	□□
48	24	PPR-4824	383	□□	□□
54	24	PPR-5424	395	□□	□□
60	24	PPR-6024	407	□□	□□
24	18	PPC-2418	352	□□	□□
30	18	PPC-3018	365	□□	□□
36	18	PPC-3618	377	□□	□□
42	18	PPC-4218	389	□□	□□
48	18	PPC-4818	401	□□	□□
54	18	PPC-5418	413	□□	□□
60	18	PPC-6018	425	□□	□□
24	24	PPC-2424	371	□□	□□
30	24	PPC-3024	383	□□	□□
36	24	PPC-3624	395	□□	□□
42	24	PPC-4224	407	□□	□□
48	24	PPC-4824	420	□□	□□
54	24	PPC-5424	432	□□	□□
60	24	PPC-6024	444	□□	□□
24	18	PPS-2418	316	□□	□□
30	18	PPS-3018	328	□□	□□
36	18	PPS-3618	340	□□	□□
42	18	PPS-4218	352	□□	□□
48	18	PPS-4818	365	□□	□□
54	18	PPS-5418	377	□□	□□
60	18	PPS-6018	389	□□	□□
24	24	PPS-2424	328	□□	□□
30	24	PPS-3024	347	□□	□□
36	24	PPS-3624	359	□□	□□
42	24	PPS-4224	371	□□	□□
48	24	PPS-4824	383	□□	□□
54	24	PPS-5424	395	□□	□□
60	24	PPS-6024	407	□□	□□

PRODUCT NOTES

When specifying panels for worksurface widths of 24 to 60 inches, order single panels from selection above. Total panel width is a uniform 4.5 inches shorter than the worksurface width to accommodate mounting bracket fit.

Desk-mounted privacy panels provide sitting height privacy, may be shared between desks, and are tackable on both sides.

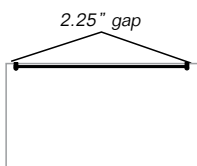

When panel is used on a single edge

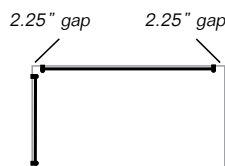

When panels meet at a corner

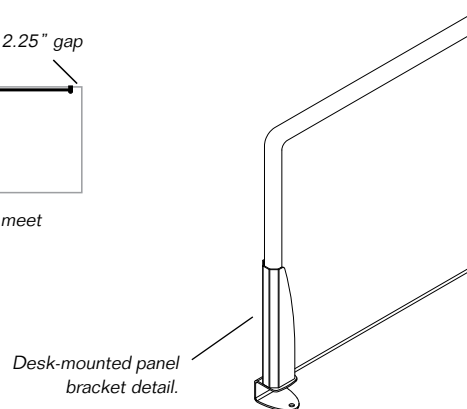

Desk-mounted panel bracket detail.

**DESK-MOUNTED PRIVACY**

For Worksurface Widths: 66" - 84"

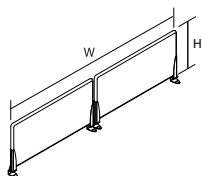

**RECTANGULAR**

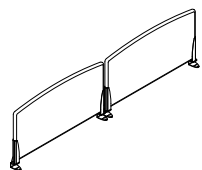

**CENTER ARCH**

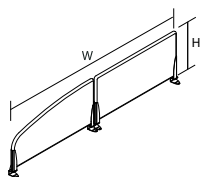

**SLOPED / RECTANGULAR**

W / H		Product	Price	Finishes	
				Fabric	Powder (bracket)
			\$		
66	12	PPRD-6612	651	<input type="checkbox"/>	<input type="checkbox"/>
72	12	PPRD-7212	663	<input type="checkbox"/>	<input type="checkbox"/>
78	12	PPRD-7812	675	<input type="checkbox"/>	<input type="checkbox"/>
84	12	PPRD-8412	687	<input type="checkbox"/>	<input type="checkbox"/>
66	18	PPRD-6618	668	<input type="checkbox"/>	<input type="checkbox"/>
72	18	PPRD-7218	680	<input type="checkbox"/>	<input type="checkbox"/>
78	18	PPRD-7818	693	<input type="checkbox"/>	<input type="checkbox"/>
84	18	PPRD-8418	706	<input type="checkbox"/>	<input type="checkbox"/>
66	24	PPRD-6624	693	<input type="checkbox"/>	<input type="checkbox"/>
72	24	PPRD-7224	718	<input type="checkbox"/>	<input type="checkbox"/>
78	24	PPRD-7824	742	<input type="checkbox"/>	<input type="checkbox"/>
84	24	PPRD-8424	766	<input type="checkbox"/>	<input type="checkbox"/>
66	18	PPCD-6618	742	<input type="checkbox"/>	<input type="checkbox"/>
72	18	PPCD-7218	754	<input type="checkbox"/>	<input type="checkbox"/>
78	18	PPCD-7818	766	<input type="checkbox"/>	<input type="checkbox"/>
84	18	PPCD-8418	778	<input type="checkbox"/>	<input type="checkbox"/>
66	24	PPCD-6624	766	<input type="checkbox"/>	<input type="checkbox"/>
72	24	PPCD-7224	790	<input type="checkbox"/>	<input type="checkbox"/>
78	24	PPCD-7824	814	<input type="checkbox"/>	<input type="checkbox"/>
84	24	PPCD-8424	839	<input type="checkbox"/>	<input type="checkbox"/>
66	18	PPSRD-6618	668	<input type="checkbox"/>	<input type="checkbox"/>
72	18	PPSRD-7218	680	<input type="checkbox"/>	<input type="checkbox"/>
78	18	PPSRD-7818	693	<input type="checkbox"/>	<input type="checkbox"/>
84	18	PPSRD-8418	706	<input type="checkbox"/>	<input type="checkbox"/>
66	24	PPSRD-6624	693	<input type="checkbox"/>	<input type="checkbox"/>
72	24	PPSRD-7224	718	<input type="checkbox"/>	<input type="checkbox"/>
78	24	PPSRD-7824	742	<input type="checkbox"/>	<input type="checkbox"/>
84	24	PPSRD-8424	766	<input type="checkbox"/>	<input type="checkbox"/>

**PRODUCT NOTES**

When specifying panels for worksurface widths of 66 to 84 inches, order from the selection above. Total panel width is a uniform 4.5 inches shorter than the worksurface width to accommodate mounting bracket fit.

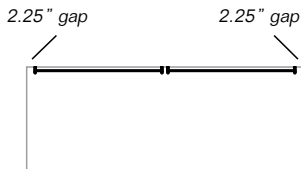

Two panels span desk widths of 66" or larger.

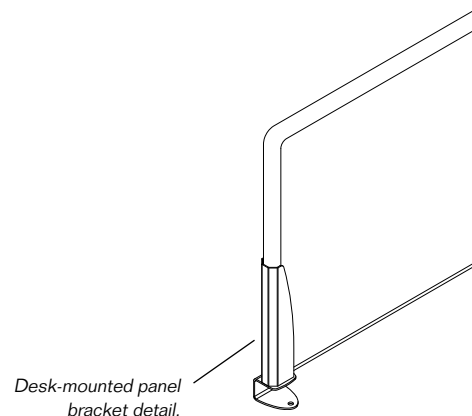

## NOTES

**For Customer Service Inquiries, please contact:**

**800.426.1202**

**360.394.1322** *fax*

[www.watsondesking.com](http://www.watsondesking.com)

## ACCESSORIES

Seiri Screen	176
Modesty Shield	178
Cadence Storage Top	179
Storage Accessories	180
Werktools	182
Desk Accessories	183
Lighting	186
Technology Carts	187
Markerboards	188

DESK-MOUNTED PRIVACY

Product

Finishes

H / W	Price	Fabric	Powder
	\$		
13 36	FAPRS1336 575	<input type="checkbox"/>	<input type="checkbox"/>
13 42	FAPRS1342 575	<input type="checkbox"/>	<input type="checkbox"/>
13 48	FAPRS1348 575	<input type="checkbox"/>	<input type="checkbox"/>
13 54	FAPRS1354 625	<input type="checkbox"/>	<input type="checkbox"/>
13 60	FAPRS1360 625	<input type="checkbox"/>	<input type="checkbox"/>
13 66	FAPRS1366 650	<input type="checkbox"/>	<input type="checkbox"/>
13 72	FAPRS1372 650	<input type="checkbox"/>	<input type="checkbox"/>
13 78	FAPRS1378 675	<input type="checkbox"/>	<input type="checkbox"/>
13 84	FAPRS1384 675	<input type="checkbox"/>	<input type="checkbox"/>
19 36	FAPRS1936 575	<input type="checkbox"/>	<input type="checkbox"/>
19 42	FAPRS1942 575	<input type="checkbox"/>	<input type="checkbox"/>
19 48	FAPRS1948 575	<input type="checkbox"/>	<input type="checkbox"/>
19 54	FAPRS1954 625	<input type="checkbox"/>	<input type="checkbox"/>
19 60	FAPRS1960 625	<input type="checkbox"/>	<input type="checkbox"/>
19 66	FAPRS1966 650	<input type="checkbox"/>	<input type="checkbox"/>
19 72	FAPRS1972 650	<input type="checkbox"/>	<input type="checkbox"/>
19 78	FAPRS1978 675	<input type="checkbox"/>	<input type="checkbox"/>
19 84	FAPRS1984 675	<input type="checkbox"/>	<input type="checkbox"/>
13 36	FAPRD1336 725	<input type="checkbox"/>	<input type="checkbox"/>
13 42	FAPRD1342 725	<input type="checkbox"/>	<input type="checkbox"/>
13 48	FAPRD1348 725	<input type="checkbox"/>	<input type="checkbox"/>
13 54	FAPRD1354 775	<input type="checkbox"/>	<input type="checkbox"/>
13 60	FAPRD1360 775	<input type="checkbox"/>	<input type="checkbox"/>
13 66	FAPRD1366 800	<input type="checkbox"/>	<input type="checkbox"/>
13 72	FAPRD1372 800	<input type="checkbox"/>	<input type="checkbox"/>
13 78	FAPRD1378 825	<input type="checkbox"/>	<input type="checkbox"/>
13 84	FAPRD1384 825	<input type="checkbox"/>	<input type="checkbox"/>
19 36	FAPRD1936 725	<input type="checkbox"/>	<input type="checkbox"/>
19 42	FAPRD1942 725	<input type="checkbox"/>	<input type="checkbox"/>
19 48	FAPRD1948 725	<input type="checkbox"/>	<input type="checkbox"/>
19 54	FAPRD1954 775	<input type="checkbox"/>	<input type="checkbox"/>
19 60	FAPRD1960 775	<input type="checkbox"/>	<input type="checkbox"/>
19 66	FAPRD1966 800	<input type="checkbox"/>	<input type="checkbox"/>
19 72	FAPRD1972 800	<input type="checkbox"/>	<input type="checkbox"/>
19 78	FAPRD1978 825	<input type="checkbox"/>	<input type="checkbox"/>
19 84	FAPRD1984 825	<input type="checkbox"/>	<input type="checkbox"/>

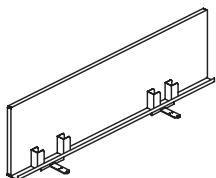

SINGLE SIDED SEIRI SCREEN

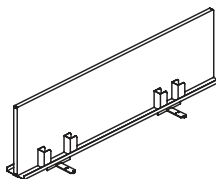

DUAL SIDED SEIRI SCREEN

PRODUCT NOTES

Seiri Screens are not compatible with Overdesk Storage or Werkrails.

Single Sided Seiri Screens ship with 4 bins. Dual sided Seiri Screens ship with 8 bins.

Seiri Bins fix magnetically to trays.

13-inch Seiri Screen matches the height of 42 high cabinets. Use the 19-inch Seiri Screen as an alternative for more privacy.

Desk Mounted Seiri Screens are fully tackable.

INDEX

SEIRI SCREEN	203
FINISHES	230

DESK-MOUNTED PRIVACY

		Product	Finishes	
H / W		Price	Fabric	Powder
		\$		
13 36	FAPRW1336	525	<input type="checkbox"/>	<input type="checkbox"/>
13 42	FAPRW1342	525	<input type="checkbox"/>	<input type="checkbox"/>
13 48	FAPRW1348	525	<input type="checkbox"/>	<input type="checkbox"/>
13 54	FAPRW1354	575	<input type="checkbox"/>	<input type="checkbox"/>
13 60	FAPRW1360	575	<input type="checkbox"/>	<input type="checkbox"/>
13 66	FAPRW1366	600	<input type="checkbox"/>	<input type="checkbox"/>
13 72	FAPRW1372	600	<input type="checkbox"/>	<input type="checkbox"/>
13 78	FAPRW1378	625	<input type="checkbox"/>	<input type="checkbox"/>
13 84	FAPRW1384	625	<input type="checkbox"/>	<input type="checkbox"/>
19 36	FAPRW1936	525	<input type="checkbox"/>	<input type="checkbox"/>
19 42	FAPRW1942	525	<input type="checkbox"/>	<input type="checkbox"/>
19 48	FAPRW1948	525	<input type="checkbox"/>	<input type="checkbox"/>
19 54	FAPRW1954	575	<input type="checkbox"/>	<input type="checkbox"/>
19 60	FAPRW1960	575	<input type="checkbox"/>	<input type="checkbox"/>
19 66	FAPRW1966	600	<input type="checkbox"/>	<input type="checkbox"/>
19 72	FAPRW1972	600	<input type="checkbox"/>	<input type="checkbox"/>
19 78	FAPRW1978	625	<input type="checkbox"/>	<input type="checkbox"/>
19 84	FAPRW1984	625	<input type="checkbox"/>	<input type="checkbox"/>
	FABIN	95	-	<input type="checkbox"/>

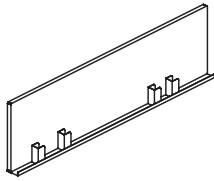

**WALL MOUNT SEIRI SCREEN**

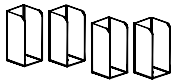

**SEIRI BIN SET**  
(set of 4)

PRODUCT NOTES

Wall Mounted Seiri Screens mount to the wall with supplied sheet metal cleats.

Wall Mounted Seiri Screen ships with 4 bins.

Seiri Bins fix magnetically to trays.

Wall Mount Seiri Screens are fully tackable.

INDEX

SEIRI SCREEN	203
FINISHES	230

MODESTY SHIELD

Product		Finishes	
H / W	Price	Powder	
	\$		
13 24	FASTL1324	248	<input type="checkbox"/> <input type="checkbox"/>
13 30	FASTL1330	252	<input type="checkbox"/> <input type="checkbox"/>
13 36	FASTL1336	257	<input type="checkbox"/> <input type="checkbox"/>
13 42	FASTL1342	262	<input type="checkbox"/> <input type="checkbox"/>
13 48	FASTL1348	267	<input type="checkbox"/> <input type="checkbox"/>
13 54	FASTL1354	272	<input type="checkbox"/> <input type="checkbox"/>
13 60	FASTL1360	277	<input type="checkbox"/> <input type="checkbox"/>
13 66	FASTL1366	282	<input type="checkbox"/> <input type="checkbox"/>
13 24	FAMOD1324	500	<input type="checkbox"/> <input type="checkbox"/>
13 30	FAMOD1330	500	<input type="checkbox"/> <input type="checkbox"/>
13 36	FAMOD1336	550	<input type="checkbox"/> <input type="checkbox"/>
13 42	FAMOD1342	550	<input type="checkbox"/> <input type="checkbox"/>
13 48	FAMOD1348	600	<input type="checkbox"/> <input type="checkbox"/>
13 54	FAMOD1354	600	<input type="checkbox"/> <input type="checkbox"/>
13 60	FAMOD1360	650	<input type="checkbox"/> <input type="checkbox"/>
13 66	FAMOD1366	650	<input type="checkbox"/> <input type="checkbox"/>

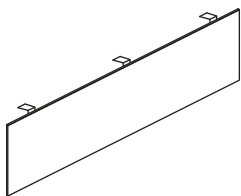

STEEL  
MODESTY SHIELD

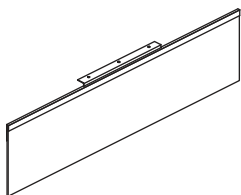

ACRYLIC  
MODESTY SHIELD

PRODUCT NOTES

Steel Modesty Shield is 16-gauge powder coat steel with fabric lining on the user side.

Acrylic Modesty Shield is frosted acrylic with powder coat steel detail and mounting bracket.

In some circumstances the placement of the Modesty Shield may interfere with pre-installed grommets. It is recommended to use field installed grommets when using a Modesty Shield.

INDEX

FINISHES	230
----------	-----

Application Specification

For tables configured with legs only, shield length should be 18 inches shorter than the length of the table (allowing 9 inches of clearance at each end).

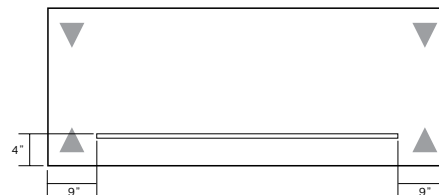
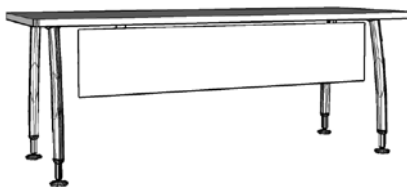

CADENCE STORAGE TOP

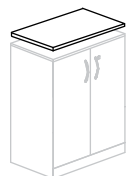

**FLOATING STORAGE TOP**  
32 Wide

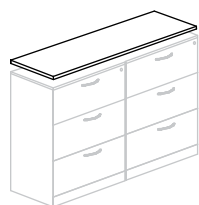

**FLOATING STORAGE TOP**  
64 Wide

D / W

14 32  
19 32

14 64  
19 64

Product	Edge	Smart-grain	Finishes		
	See Options Below				
		Smart-grain Yes = A No = -	Surface	Edge	Powder
CAFST1432	<input type="checkbox"/>	<input type="checkbox"/>	<input type="checkbox"/>	<input type="checkbox"/>	<input type="checkbox"/>
CAFST1932	<input type="checkbox"/>	<input type="checkbox"/>	<input type="checkbox"/>	<input type="checkbox"/>	<input type="checkbox"/>
CAFST1464	<input type="checkbox"/>	<input type="checkbox"/>	<input type="checkbox"/>	<input type="checkbox"/>	<input type="checkbox"/>
CAFST1964	<input type="checkbox"/>	<input type="checkbox"/>	<input type="checkbox"/>	<input type="checkbox"/>	<input type="checkbox"/>

PRODUCT NOTES

Floating Storage Tops are designed for 14 and 19 inch deep Cadence storage units in 28 and 42 inch heights.

Floating Storage Tops are field drilled to storage units.

Match Floating Storage Top depth to storage depth.

Floating Storage Top ships with two powder coat risers.

Risers are available in black or white aluminum, to match storage pull color.

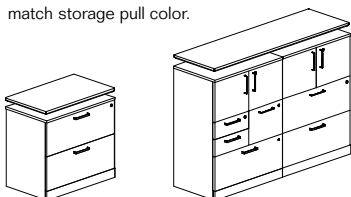

EDGES

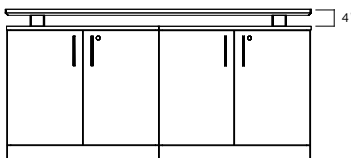

Floating Storage Top adds 4 inches of height to storage.

	Add \$	Edge Code
2mm	+ \$00	<b>H</b>
Duet	+ \$150	<b>D</b>
N-45	+ \$150	<b>N</b>
45	+ \$200	<b>T</b>
Stretta	+ \$200	<b>S</b>
Fender	+ \$250	<b>F</b>

STORAGE ACCESSORIES

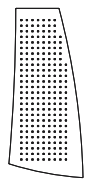

**MOTO / CAB WERKWALL**  
(choose right or left hand)

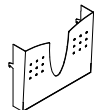

**SINGLE MAGAZINE RACK**

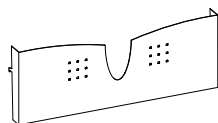

**DOUBLE MAGAZINE RACK**

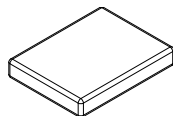

**SEAT CUSHION**



**COAT HOOK**

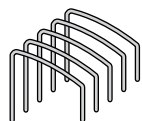

**SHELF DIVIDERS**  
(set of 5)

**D / W / H**

MOTO  
Left 14 15  
Right 14 15  
CAB  
Left 17 38  
Right 17 38

Product

WWML  
WWMR  
WWCL  
WWCR

Finishes,

Price  
Fabric  
or  
Powder

\$  
73  
73  
109  
109



3 14 11

WMRS

61



3 30 11

WMRD

91



18 14 2.5  
25 14 2.5

WSC  
WSD

182  
182



- - -

WTCH

49



- - -

ASDS

30

PRODUCT NOTES

Werkwalls attach to the sides of Motos and Cabs for hanging Werktools. For complete Werktool offering refer to page 182.

Magazine Racks have tabs that slide through slots integrated into the back panels of Motos and Cabs.

Seat cushions fit precisely into the top of Motos.

INDEX

STORAGE PRODUCTS

SEAT CUSHION

MAGAZINE RACK

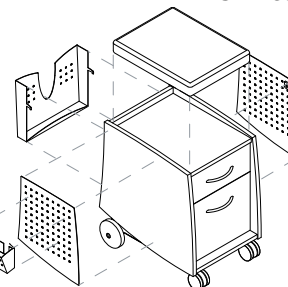

WERKWALL  
(right hand)

WERKTOOLS  
(page 182)

**SIDEKICK TOWER ACCESSORIES**

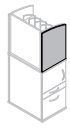

**FRONT TOWER MARKERBOARDS**  
*(Left hand, single high shown)*

SINGLE HIGH  
DOUBLE HIGH

SAFMS  
SAFMD

Price  
\$  
100  
150

Left = **L**  
or  
Right = **R**

**2** = 23"  
**3** = 29"  
**4** = 35"  
**5** = 41"

Fabric  
or  
Powder  
-  
-

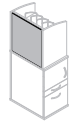

**BACK TOWER MARKERBOARDS**

SINGLE HIGH  
DOUBLE HIGH

SABMS  
SABMD

100  
150

-  
-

-  
-



**FRONT TOWER FABRIC PANEL**

SINGLE HIGH  
DOUBLE HIGH

SATPFS  
SATPFD

100  
150

-  
-



**BACK TOWER FABRIC PANEL**

SINGLE HIGH  
DOUBLE HIGH

SATPS  
SATPD

100  
150

-  
-



**FRONT TOWER WERKWALL**

SINGLE HIGH  
DOUBLE HIGH

SAWWS  
SAWWD

73  
97

-  
-

-  
-



**TOWER COAT HOOK**

SACH

25

-

-

**PRODUCT NOTES**

Erasable and tackable message boards complete team and shared environments by adding functionality to the natural space divider of the Sidekick Towers. Perfect for end of runs and shared configurations, Tower Back Markerboards and Fabric Tack Panels inset into the Sidekick Tower back. Tower Front Markerboards are perfect for quick notes and meeting agendas.

Sidekick Markerboards come standard in white.

Sidekick Werkwalls attach to the front upper portion of Sidekick Towers and accommodate Werktools (page 182).

The Tower Coat Hook attaches to the top of the Sidekick Tower and can be used with or without Markerboards or Fabric Panels.

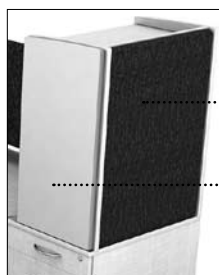

Back Tower

Front Tower

WERKTOOLS

Product	Finishes
<b>D / W / H</b>	Price Powder
	\$
- 24 8 WR24	231 <input type="checkbox"/> <input type="checkbox"/>
- 30 8 WR30	231 <input type="checkbox"/> <input type="checkbox"/>
- 36 8 WR36	231 <input type="checkbox"/> <input type="checkbox"/>
2 8 7 WTWR	42 <input type="checkbox"/> <input type="checkbox"/>
3 4 4 WTB4	49 <input type="checkbox"/> <input type="checkbox"/>
3 6 4 WTB6	54 <input type="checkbox"/> <input type="checkbox"/>
4 13 9 WTB13	79 <input type="checkbox"/> <input type="checkbox"/>
- 22 34 WM2234	121 <input type="checkbox"/> <input type="checkbox"/>

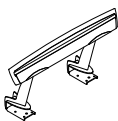

WERKRAIL



WERKRACK



4" WERKBIN



6" WERKBIN

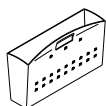

13" WERKBIN

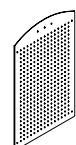

WALL MOUNTABLE WERKWALL

PRODUCT NOTES

Werkrail is desk-mounted providing a vertical structure to hang Werktools.



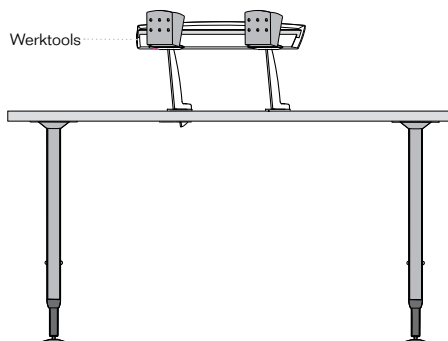

Werkrail construction consists of a high density polyethylene rail supported by .125 inch steel brackets. Maximum load capacity is 15 lbs.

Werkracks can be ganged up to three deep for folders and papers.

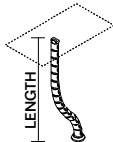
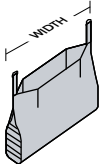

DESK ACCESSORIES

Product

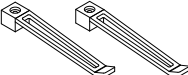
	D / W / L		Price
 <p><b>VERTICAL VERTEBRAE</b></p>	- - 30	DAV30	91
	- - 37	DAV37	109
 <p><b>CABLE KEEPER</b></p>	- 18 -	DACK	79
 <p><b>SNAPS</b> (set of five)</p>	- - -	DASN	3
 <p><b>DUAL LOCK</b> (set of three)</p>	- - -	DADL	6
 <p><b>LEG CLIPS</b> (set of three)</p>	- - -	DALC	8
 <p><b>ALLIGATOR CLIPS</b> (set of five, single shown)</p>	SINGLE	DAAS	14
	DOUBLE	DAAD	17

PRODUCT NOTES

Vertebrae may be positioned under the worksurface to allow for flexible integration of Power and Data components.

Cable Keeper cable management pouches hang under the worksurface for handling clutter of wires created by the power and data environment. Constructed of rugged 600-denier black commercial grade fabric.

Order additional Snaps to allow for extra cable management capacity under Fusion desks.

2.5 inch removable pieces of Dual-Lock are for mounting power blocks under desk surface.

Leg Clips are for routing cables down a leg.

INDEX

FUSION VALUE

196

DESK ACCESSORIES

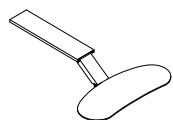

ADD-ON KEYBOARD

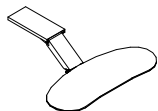

VERVE ADD-ON KEYBOARD

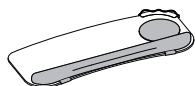

WRIST REST / MOUSE PAD



CONNECTING PLATE

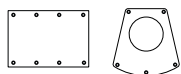

CONNECTING PLATE AND LEG

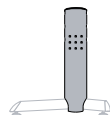

IMPULSE END SHROUD

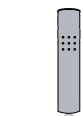

IMPULSE CORNER SHROUD

Product	Price	Finishes
DAKB	\$ 244	Powder -
DAVKB	402	-
DAWM	97	-
LSK-P	61	-
LSK-PL	182	-
DAISE	100	<input type="checkbox"/> <input type="checkbox"/>
DAISC	100	<input type="checkbox"/> <input type="checkbox"/>

PRODUCT NOTES

Add-on keyboards feature the same characteristics as the Bi-Level keyboard (page 197) but are retractable along a 24 inch track. Location of the keyboard track may be impacted by obstacles beneath the work surface and work surface depth. Please contact Watson Customer Service for details.

Shrouds

The rectilinear user-adjustable Impulse bases may be visually enhanced by the addition of magnetically fixed perforated steel shrouds that echo the curvilinear design ethic of the Fusion offering. Designed for use on exposed legs, shrouds must be specified to fit either end-base or corner-base applications. **Impulse Powerlift bases do not accept decorative shrouds.**

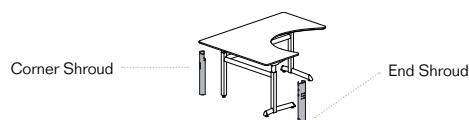

INDEX

EXTENSION ASSEMBLY	194
FUSION VALUE	196
KEYBOARDS	197

CONNECTING PLATE: Vibe base desks may need only a connecting plate. One or two Vibe legs are eliminated and replaced with the connecting plate.

CONNECTING PLATE AND LEG: Stride and Bridge base desks need a connecting plate and leg kit. Both original legs are eliminated and replaced with connecting plate and straight parabolic leg.

Connecting plate kits are available for leg clearance optimization. Field installation only.

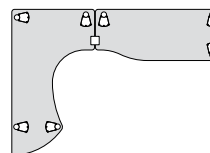

Vibe Base w / Plate

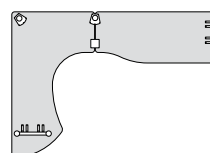

Stride Base w / Leg and Plate

DESK ACCESSORIES

		Product	Finishes		
			Price	Laminate	Powder
D / W / H					
	- - -	DACA	\$ 37	-	-
<b>DESK CASTERS</b> (pair)					
	- - -	DACS	218	-	-
<b>RETRACTABLE CPU HOLDER</b>					
	23 9 13	TCP	231	<input type="checkbox"/>	<input type="checkbox"/>
<b>CPU TROLLEY</b>					
	- - -	DADP	182	-	-
<b>SURFACE MOUNTABLE POWER MODULE</b>					
	- - -	DAUP	61	-	-
<b>UNDERSURFACE MOUNTABLE POWER MODULE</b>					
	- - -	DAGR	25	-	-
<b>FIELD INSTALLED GROMMETS</b> (set of five, w / covers)					

PRODUCT NOTES

Desk Casters are non-locking and are interchangeable with Glide Pads on the Extension Assembly.

Retractable CPU Holder incorporates a strap design that can be adjusted to fit virtually all sizes of computers. Slide track provides 5 inches of travel for ease of accessibility.

The CPU Trolley is an independent mobile unit used for housing technology.

Power Modules are UL approved for direct mounting to any vertical or horizontal surface. 10 foot power cable (Undersurface Mountable) or 6 foot power cable (Surface Mountable) and installation hardware is standard. DADP is not available for use with the Fender or Stretta edges.

**Factory Installed Grommet Guidelines**

Factory Installed grommets are available for most desks and conference tables. For corner surfaces (Verves, Elliptics, Corners, and Extended Corners), grommets are installed to the left and right of the inside corner in locations along the edges dictated by the desk understructure.

For smaller extensions and independent desks (except Improv), one grommet is installed, generally near the corner, as dictated by desk structure.

Rectangles below 66 inches receive one grommet near the center of the longest edge. 66 inch rectangles and above receive two grommets near inside corners.

To order factory-installed grommets, place a "G" after the edge code in the ordering document and add \$75 list for all desks.

PVC grommets for field installation are available as shown.

LIGHTING

Product

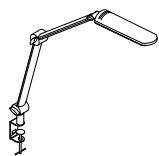

**HURON  
FLUORESCENT  
TASK LIGHT**

ARM LENGTH

30

Price

\$  
429

LPFB

PRODUCT NOTES

Task lights are mountable to the worksurface providing superior color rendering.

*HURON FLUORESCENT*

- Lamp: 18 watt CFL
- CRI: 82 (color rendering index)
- Ballast: Electronic in-line
- Lamp Life: 12,000 hrs.
- Hi / low Switching: Yes
- Head Joint: 3 Axis
- Glare Louver: Yes
- Arm Finishes: Black

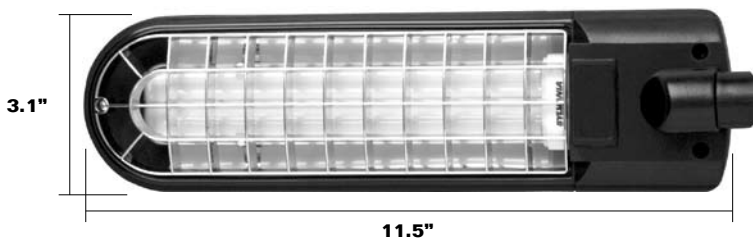

TECHNOLOGY CARTS

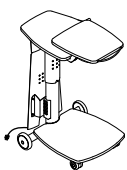
	Product			Finishes			
	D	W	H	Surface/ Edge	Powder		
 <p><b>SOLO CART</b> (keyboard platform)</p>	24	23	29-42	MSAHB	\$ 1690	<input type="checkbox"/> <input type="checkbox"/>	<input type="checkbox"/> <input type="checkbox"/>
 <p><b>BEAMER CART</b> (LCD platform)</p>	24	32	29-45	MBAHA	1690	<input type="checkbox"/> <input type="checkbox"/>	<input type="checkbox"/> <input type="checkbox"/>

APPLICATION

**SOLO**

Small Conferencing

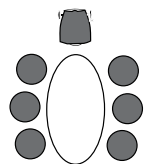

Workstation

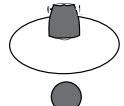

Teaming

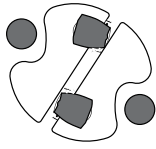

Kiosk



**BEAMER**

Large Conferencing

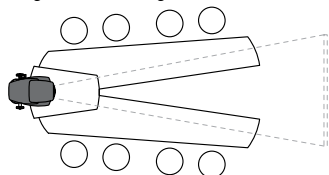

Small Conferencing

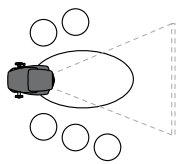

Private Office Conferencing

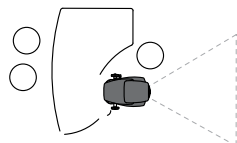

INDEX

TECHNOLOGY CARTS

204

Mobile Solo and Beamer technology carts free computer and visual devices from the worksurface.

**Solo** carts provide platforms for CPUs, laptops and monitors up to 17 inches. Larger monitors can be accommodated by reversing the upper shield.

**Beamer** carts provide a mobile, height-adjustable platform for LCD projectors and a secondary platform for laptop computers.

Load capacity is 100 lbs above the wheels and 20 lbs outside the wheels on the secondary platform.

Edge colors match laminate finish.

ECHO MARKERBOARDS

Product Finishes

W / H

Price Powder

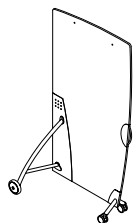

**ECHO MOBILE MARKERBOARD**

43 73

MEM-4373

\$ 1331

-

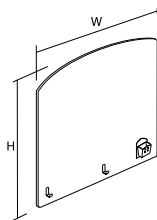

**ECHO WALL MOUNTED MARKERBOARD**

(includes metal presentation board holders)

29 46

MEW-2946

425

-

46 46

MEW-4646

547

-

92 46

MEW-9246

911

-

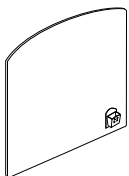

**ECHO WALL MOUNTED MARKERBOARD**

29 46

MEX-2946

389

-

46 46

MEX-4646

511

-

92 46

MEX-9246

875

-

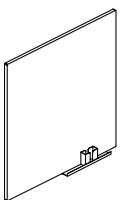

**MIRO WALL MOUNTED WHITEBOARD**

30 46

FAWBD4630

450



46 46

FAWBD4646

600



70 46

FAWBD4670

750



94 46

FAWBD4694

900



APPLICATION

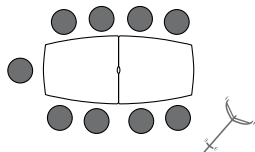
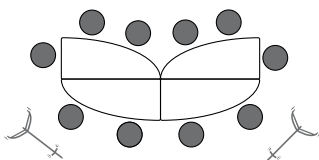

INDEX

ECHO MARKERBOARDS

205

Mobile Markerboards have white markerboard laminate on two sides and are delivered with a 4" Marker Bin and Flip Chart Fasteners on one side. Rear wheel assembly is 27 inches wide.

Echo Wall Mounted Markerboards have white markerboard laminate on one side, are delivered with a 4" Marker Bin and may be ordered with or without presentation board holders.

Wall Mounted Whiteboards mount to the wall with supplied sheet metal cleats.

Miro Whiteboard ships with attached steel tray and two magnetic Seiri Bins.

Proper care and simple weekly maintenance will prolong Markerboard life. Brand and color of marker may impact performance.

# PRODUCT INFORMATION

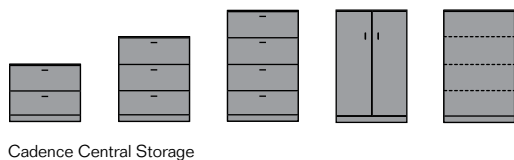
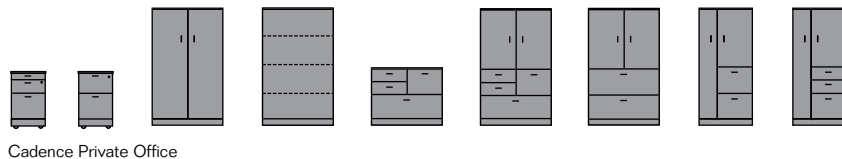
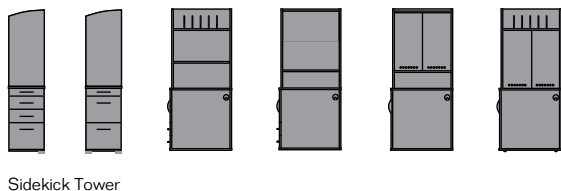
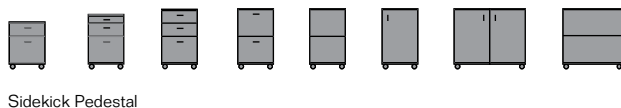
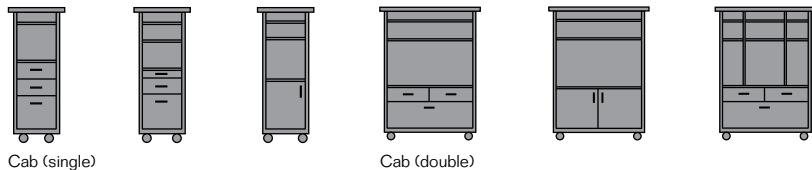
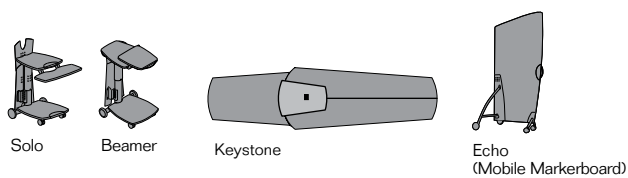

- Legs 190
- Impulse Adjustment 192
- Impulse Powerlift 193
- Extension Assembly 194
- Edges 195
- Fusion Value 196
- Keyboards 197
- Grain Direction 198
- Storage Products 199
- Sidekick Tower 201
- Keystone 202
- Seiri Screen 203
- Technology Carts 204
- Echo Markerboard 205

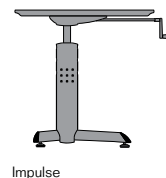
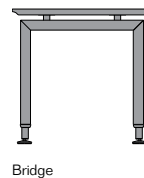
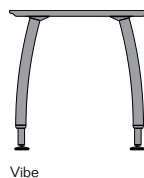
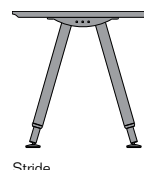

## LEGS

**STRIDE****DESIGN INTENT:**

Stride's leg angles have an architecturally pyramidal appearance while simultaneously displaying the familiar imagery of walking motion.

**VIBE****DESIGN INTENT:**

Vibe's naturally soft bend resonates with the inviting table shapes, visually insinuating flow and flexibility.

**THE PARABOLIC TUBE PROFILE**

The parabolic leg tube has the greatest impact on the desking system design. This leg shape represents a cross section of varying radii, inspired by the natural form of a parabola, the path created by the pull of gravity on a trajectory launched into the air at an acute angle.

## LEGS (CONTINUED)

**BRIDGE****DESIGN INTENT:**

Bridge's rectilinear profile emphasizes rigidity and dignity while the floating top indicates lightness and precision.

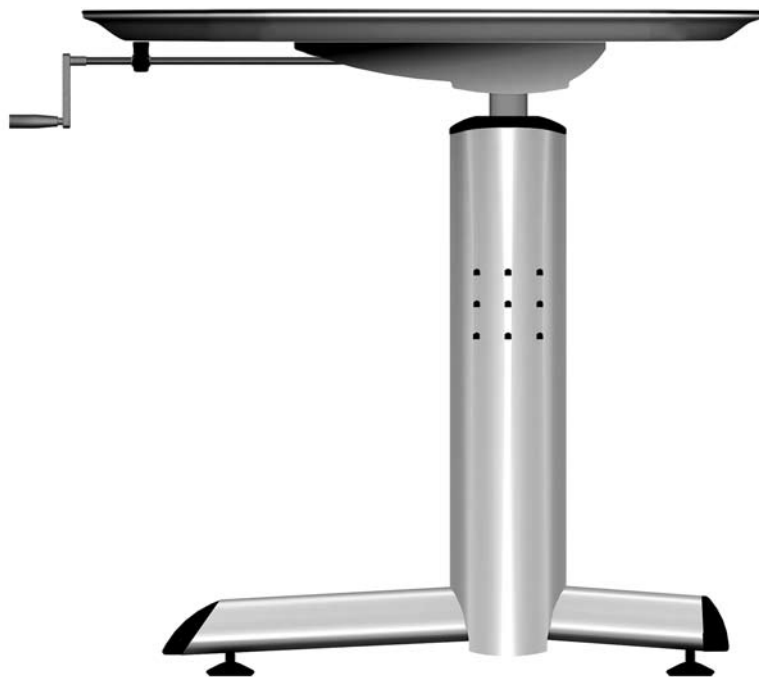
**IMPULSE****DESIGN INTENT:**

Impulse's leg geometry provides maximum knee clearance while maintaining the stability of the work-surface. The optional perforated steel decorative shroud affixes magnetically to enhance the aesthetic value of the base in applications where legs are exposed.

It takes the form language beyond the historical circular and square geometries of previous furniture designs, being proportioned for a lean and dynamic appearance while maintaining substantial structural capabilities. The tube was created to allow a family of leg bases to be developed.

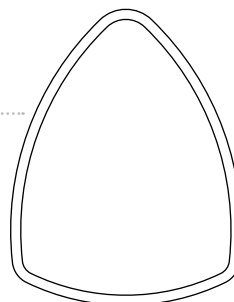

## IMPULSE ADJUSTMENT

### DESIGN INTENT:

The Impulse base is specified as either fixed or adjustable. Adjustment can either be by facilities personnel (Impulse notch) or by a user-adjustable hand crank located on the top or at the front of the worksurface. Hand cranks are removable when not in use.

A precisely machined series of beveled gears is incorporated into each user-adjustable Impulse base.

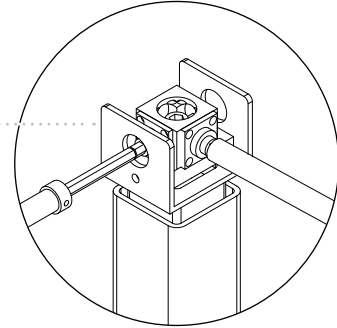

### IMPULSE CRANK ADJUSTABLE

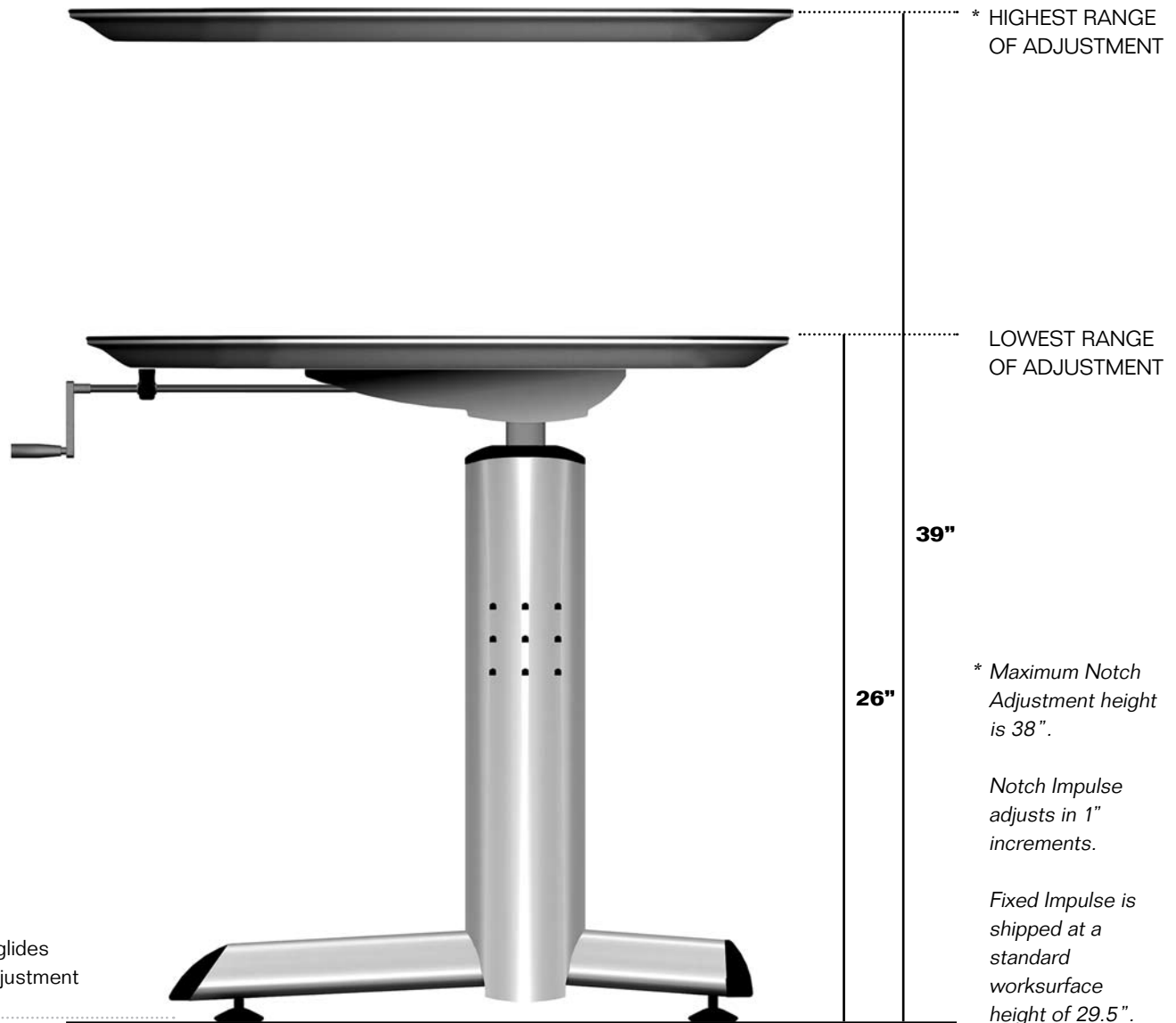

# IMPULSE POWERLIFT

## DESIGN INTENT:

Powered adjustment technology provides push-button control, 220 pounds of lifting capacity atop the worksurface, and has been cycle tested through 62,000 adjustments. This cost-effective powered base delivers 14 inches of adjustment without the maintenance and calibration requirements associated with counterbalance mechanisms.

Simple user controls are positioned within easy reach.

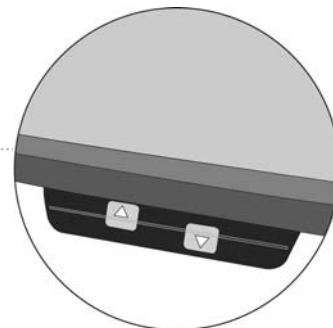

## IMPULSE POWERLIFT

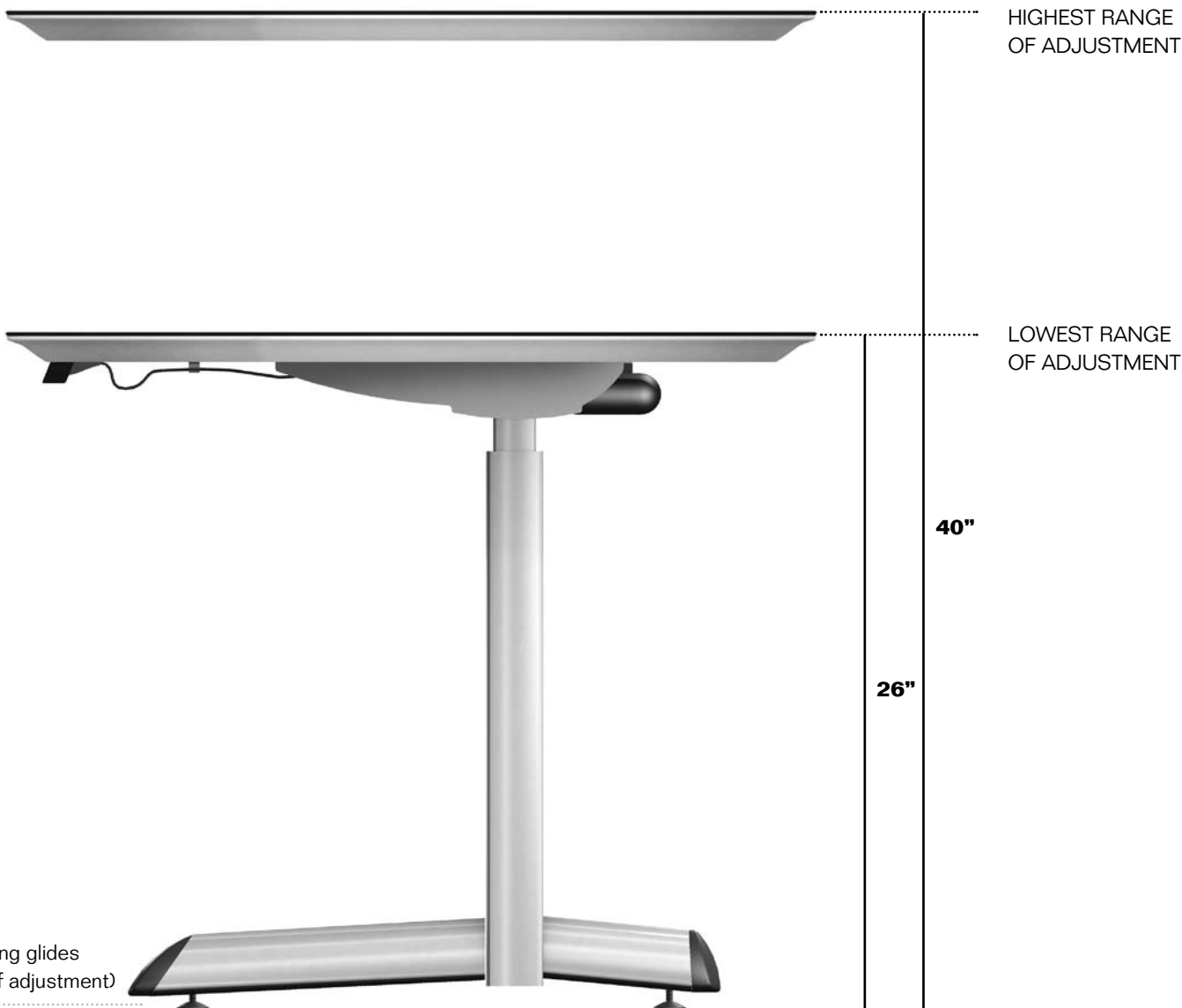

## EXTENSION ASSEMBLY

## DESIGN INTENT:

The Leg Extension Assembly brings an unprecedented level of user control to the Fusion Desking product line by providing a six inch range of height adjustability to parabolic leg tube bases. Its form speaks to the tube profile, using a telescopic mechanism derived from Watson's experience with the square tube lift assembly. Standard delivery height for Watson desks with Leg Extension Assemblies is 29.5 inches.

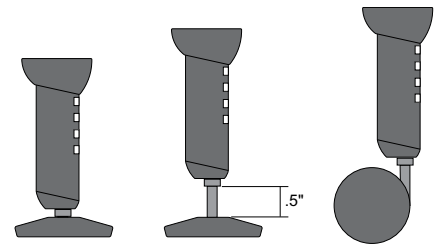
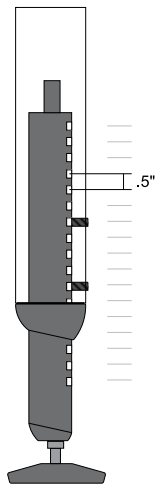
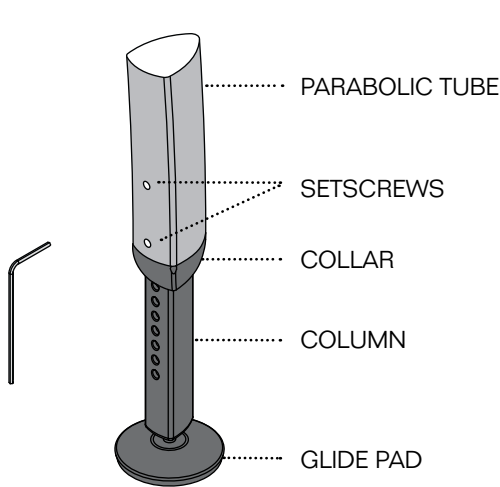
GLIDE PADS / CASTERS  
(Mobile Desks)

The Assembly contacts the floor with 3 inch diameter swivel glide pads or 2.25 inch diameter casters which are interchangeable on site. Glides have half inch maximum height adjustment, and a 25 degree orbital pivot capability. For mobile desks, two casters are included for the rear leg assemblies. See below for the adjustability differences between casters and glide pads.

## ASSEMBLY COMPONENTS

The two hex drive setscrews require only four revolutions each to release the column for adjustment. Setscrews are held within the collar's dual threaded insert plate, carrying the load of the leg and preventing insert pull-out or stripping.

## ADJUSTMENT INCREMENTS

Column has .5 inch center to center height adjustment hole spacing for the setscrews. The column has 1 inch height indicator dots, with upper and lower extension limit indicator lines. Bases with extension assemblies are delivered at 29.5 inches.

## GLIDE PAD / CASTER ADJUSTMENT COMPARISON

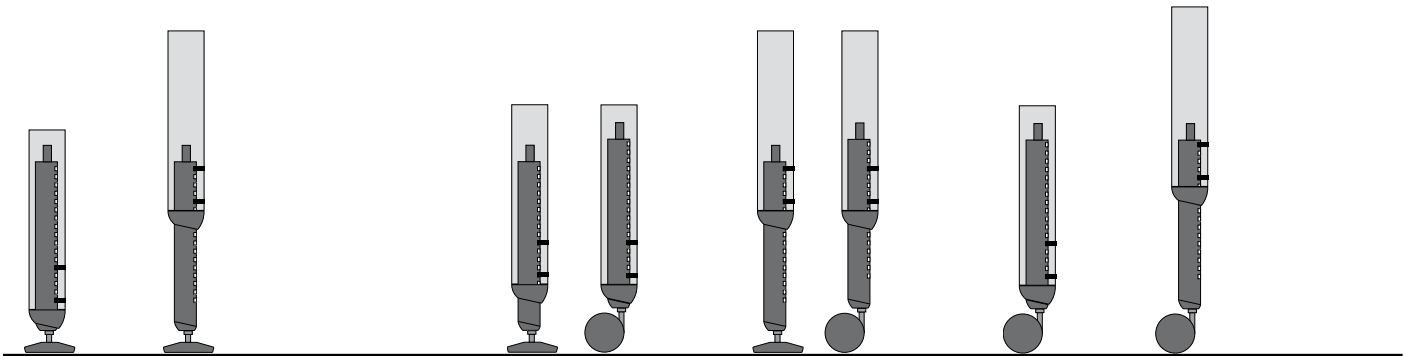

## MODULAR DESKS

Desks with glide pads only have a height range of 26.5 to 32.5 inches. Adjustment of Stride base desks differs at the highest and lowest points by .125 inch. Glide pads adjust to compensate for this difference.

## MOBILE DESKS

Desks with glide pads and casters have a height range of 28.5 to 32.5 inches because casters are taller than the glide.

## CASTER DESKS

Desks with casters only have a height range of 28.5 to 34.5 inches.

## EDGES

## XYLO

Xylo is a 3-mm extruded synthetic edge with softly radiused top and bottom edges that provide comfort, protection and economy.



## BOUNCE

Bounce is an 11-mm extruded synthetic edge with a durometer selected for its softness and durability. Its soft profile provides comfort and simplicity of design.



## DUET

Duet is a combination of a 2-mm thermally fused edgeband, applied to the docking edges for seamless desk alignment, and Bounce, applied to the user edge for comfort and durability.

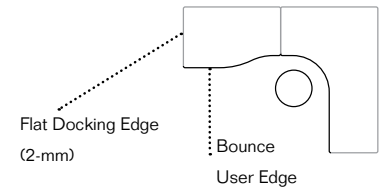
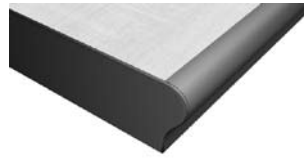

## STRETTA

Stretta is a low-profile edge that lightens the overall appearance of the worksurface while maintaining structural integrity. Worksurfaces with Stretta, Fender, 45 and N-45 edges are made of double-refined MDF and finished with either a dark or clear stain.



## FENDER

Fender is the signature edge of the Fusion desk line, providing a softer edge radius, impact protection, and an additional level of design refinement. Finished in either a charcoal or clear stain.



## 45

The 45 edge profile increases edgeline visibility and provides more traditional styling while retaining the impact-resistant bumper. Finished in either a dark or clear stain.



## N-45

The N-45 edge differs only slightly from the 45 edge option as it does not utilize the bumper.



## FUSION VALUE

### CABLE MANAGEMENT

#### DESIGN INTENT:

Managing the wires that enable desktop technologies from lights to telephones to computers is a challenge in all modern offices. We believe the best approach is to utilize the underside of worksurfaces for horizontal routing and specialty components for vertical routing between the floor and the worksurface.

Under-surface routing is accomplished simply and elegantly using strategically located machined Snap Points and flexible Snaps that easily accommodate Cat. 5 cables or combinations of power, voice, and data wiring.

Vertical routing is managed using snap-in leg clips or flexible segmented vertebrae. Optional factory- or field-installed grommets complete the journey from floor to tabletop.

Adhesive dual lock strips are used to fasten power bricks and other items to the underside, keeping them repositionable yet out of sight and out of the way.

Additional cable and power management accessories include Cable Keeper wire storage/organization devices and surface and undersurface mounted power modules.

Vertical routing is managed using snap-in leg clips or flexible segmented vertebrae. Optional factory- or field-installed grommets complete the journey from floor to tabletop.

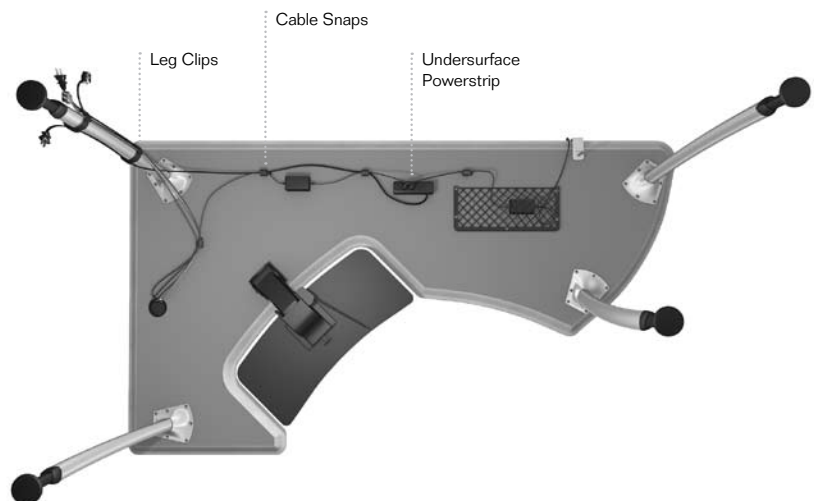
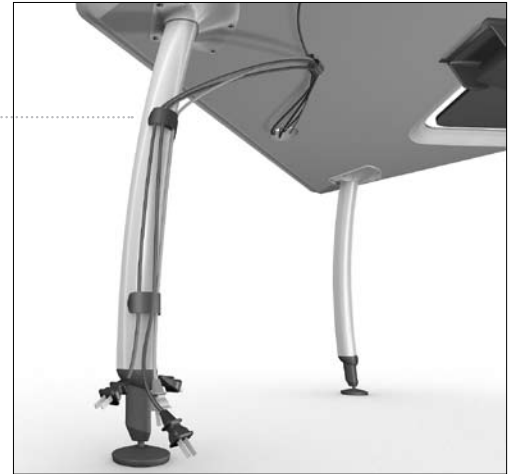

### METAL TO METAL CONNECTIONS

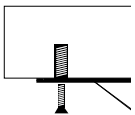

Legs are fastened to the worksurface with machine screws threaded into metal inserts to provide a better connection initially and allow for virtually unlimited teardown and reassembly in the future.

### FINGERGRIPS

Rounded, recessed channels machined into the underside of the worksurface are added as fingergrips for mobile desks.

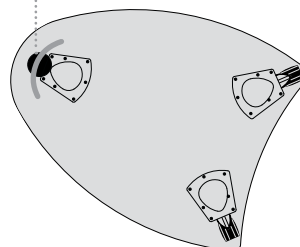

## KEYBOARDS

## BI-LEVEL

The unique Bi-level mechanism allows maximum knee space and room to maneuver with 6 inches of articulation. A separate tilt adjustment ( $\pm 15^\circ$ ) maintains the selected tilt angle throughout the travel range.

Innovative design provides smooth, quiet, and immediate counterbalanced adjustment capabilities.

360° rear swivel for optimum positioning and easy stowage.

Rugged steel construction to ensure stability and durability.

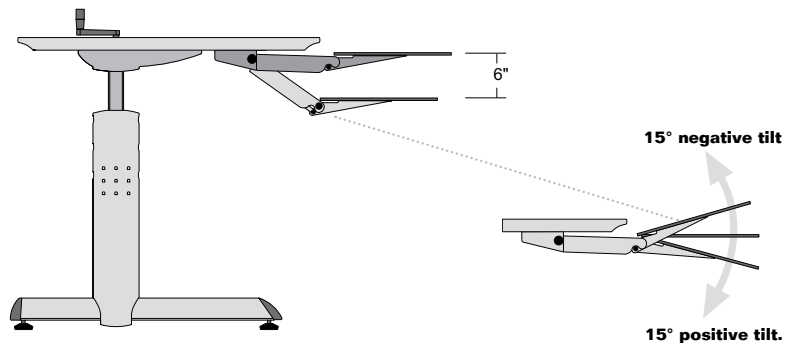

## SIT-TO-STAND

The unique Sit-to-Stand mechanism allows maximum knee space and room to maneuver with 12.5 inches of articulation (5.25 inches up, 5.5 inches down and infinite adjustment within the range) and a separate tilt adjustment ( $+10^\circ / -20^\circ$ ).

Innovative design provides smooth, quiet, and immediate counterbalanced adjustment capabilities.

360° rear swivel for optimum positioning and easy stowage.

Rugged steel construction to ensure stability and durability.

*Verve Keyboard has the same characteristics as this sit-to-stand mechanism, but is not retractable.*

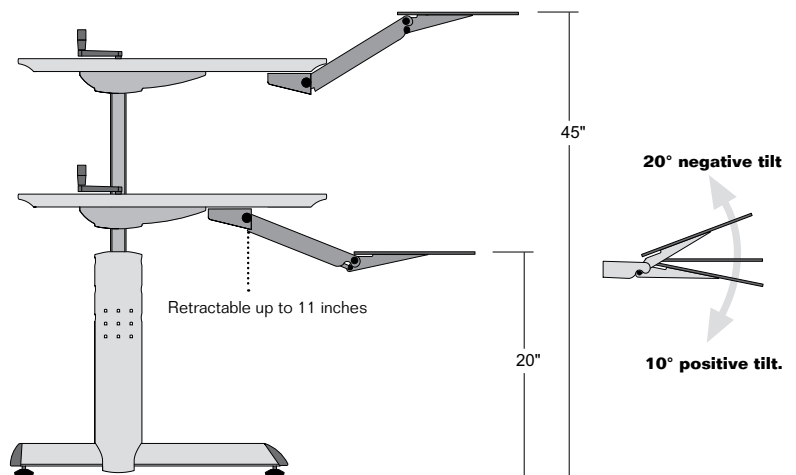

## PLATFORMS

Keyboard platforms are made of a CNC profiled .25 inch thick black core Phenolic material.

All keyboarded desks come standard with a Mouse House that attaches to the platform keeping the mouse from falling when using the negative tilt feature.

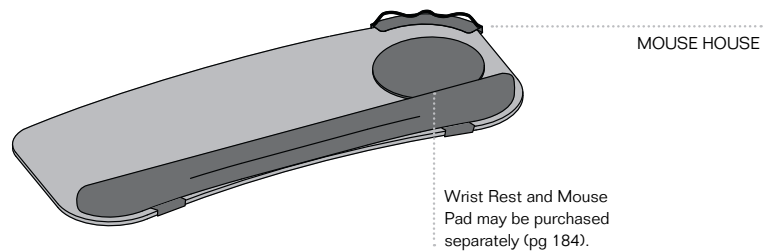

## GRAIN DIRECTION

### DESIGN INTENT:

#### Storage:

All drawer faces on Fusion storage cabinets have horizontal grain patterns. All hinged doors have vertical grain patterns. Please note that Fusion storage does not feature grain matching where doors or drawers meet. If grain matching is required, please contact a project coordinator for non-standard part pricing and lead times.

#### Worksurfaces:

Grain direction for desks and conference room surfaces run the length of the tables. For Extended Corners, grain runs in the direction of the longer of the two ends.

Verve tables are comprised of two separate wings joined at a 45 degree diagonal. Grains run along the length of both wings and are not matched at the joint.



Verve



Elliptic Pocket



Cadence Central Storage



Sidekick Tower



Cadence Private Office

## STORAGE PRODUCTS

### DESIGN INTENT:

The diverse Fusion storage offering encompasses fixed and mobile pedestals and towers, lateral files, book-cases, wardrobes, and other components. The breadth of this offering provides solutions for a variety of needs, from traditional and transitional private offices to systems and teaming applications to high-density centralized storage functions. The common themes are value, density, and aesthetic vitality.



### WHY WOOD?

Wood storage components offer numerous advantages over their metal counterparts:

#### **Dynamic profiles:**

Wood allows far greater flexibility in producing curvilinear design forms.

#### **Less noise:**

Metal storage components tend to produce and reflect more noise than wood.

#### **More choices:**

A far greater selection of finish options is available with wood laminates, including wood grains, solids, textures, and contrasting finishes.

#### **Finish durability:**

Painted metal tends to scratch and dent more easily and show wear sooner than laminated wood.

#### **Perceived quality:**

Wood furniture generally provides a higher quality feel than metal cabinetry.

### UNDER-DESK STORAGE CLEARANCE

It is important to consider the following factors when planning to place pedestals below a worksurface:

#### **Height**

All fixed-height and notch-adjustable desks are delivered at 29.5 inches to accommodate all pedestal heights. User- and notch-adjustable desks may be adjusted to heights that will interfere with under-desk storage.

#### **Depth**

All user-adjustable desks and all worksurfaces with unsupported spans greater than 48 inches include structural elements that may interfere with the placement of deeper-depth pedestals.

#### **Pedestal bays**

Full-clearance (height and depth) pedestal bays are available on larger three-leg corner tables with 24 or 30 inch docking ends as described below:

- Verve and Extended Corner Arc: 72" and larger
- Extended Corner Serpentine: 78" and larger
- Elliptic Pocket: 84" and larger

**For assistance with pedestal clearance questions, please contact Customer Service.**

## STORAGE PRODUCTS (CONTINUED)

**MOTO****DESIGN INTENT:**

The Fusion Desking design language includes the distinctive 'Motion Profile' syntax to imply lightness and motion in mobile storage products such as the Moto ped. This is a contemporary set of energetic forms that add an approachable feel to the product. Combining metal and wood in their structure, the use of the metal base pan allows the side panel to sweep upwards, reducing the overall visual mass. Base pans are powdercoated light or dark to match selected case colors. The top and faces are set noticeably inside the other panels to provide a sense of protection for the contents within.



**Werkwalls** can be added to each side of all Motos and Cabs.

**MOTO****CAB (SINGLE)****DESIGN INTENT:**

Aligning with the design characteristics of the Moto ped, the taller Cab storage units also include smooth-flowing, translucent white tambour doors to shield personal items from public view. The visual quality of the doors creates a drifting cloud impression, continuing the lightweight theme.

The form and 46 inch height of the Cab top surface was established as a comfortable standing conference area. The adjustable shelving space inside is configured to fit binders, compact disks and personal belongings.

**CAB (SINGLE)****CAB (DOUBLE)****DESIGN INTENT:**

In addition to recalling the design characteristics of Cab Single storage units, Cab Double units were specifically designed with team relationships in mind. They provide two distinct individual storage sections, and one central shared storage area between them.

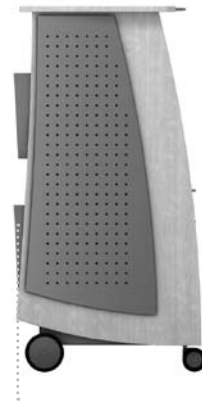

Cab's **magazine racks** are interchangeable between an upper and lower position.

**CAB (DOUBLE)**

# SIDEKICK TOWERS

## DESIGN INTENT:

Sidekick Towers open new vistas in the office landscape by freeing the work surface and vertical space above it from the tyranny of overhead storage cabinets. By moving storage to the side of a work surface, Sidekick Towers free the entire desktop for primary tasks, clear the way for ambient lighting and engineered airflow, and open sightlines for occupants.

They also represent a great value in storage and can be configured to deliver 7 lineal feet of binder storage and 4 lineal feet of file/drawer storage in a single unit. This is the storage equivalent of two overhead cabinets, an under-desk pedestal and a pencil drawer.

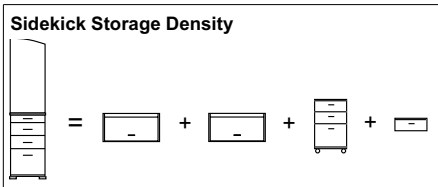

Sidekick's value is further enhanced by additional features including active vertical surface elements (Markerboards and Tackboards or Werkwalls). Sidekicks also provide visual privacy between adjacent desks.

Non-binder-top single-high Sidekick Towers feature a 6 inch personal/CD storage shelf. Non-binder-top double-high Sidekick Towers feature a 8 inch personal/CD storage shelf.

### UPPER CONFIGURATIONS (with & without binder tops)

#### Double High

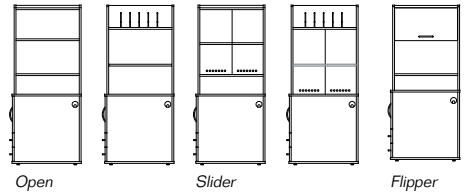

#### Single High

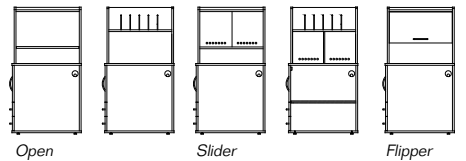

### DOOR & DRAWER CONFIGURATIONS

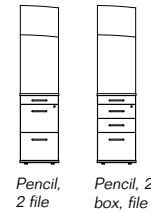

Clear acrylic **slider doors** follow the Fusion design theme.

**Binder top** facilitates storage for binders, books etc.

Active surfaces are created by attaching optional **Markerboards** or **Tack Panels** to upper front and back surfaces.

Pass through grommets above and below work-surface.

Multiple drawer configuration options are available and locks are standard.

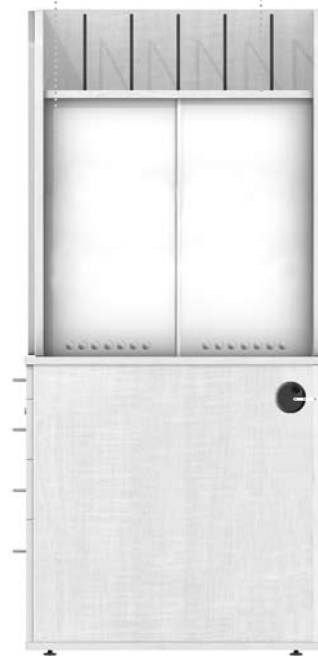

**SIDEKICK TOWER**  
SIDE VIEW

**SIDEKICK TOWER**  
FRONT VIEW

**SIDEKICK TOWER**  
BACK VIEW

## KEYSTONE

**DESIGN INTENT:**

The Keystone conferencing series is designed to address the changing dynamics of modern conference rooms. Advanced functionality and stylish lines converge to foster exceptional value in a single component that fulfills multiple needs. Anticipating the use of multiple presentation formats and technologies, Keystone tables facilitate individual presentations and group discussions.

Articulating wings shift seating postures to optimize interaction with a meeting leader, other participants, or a presentation screen. Convergent extensions accommodate up to six additional seating positions.

**Centered Adjustment**

Proprietary gear mechanism maintains a symmetrical configuration as the articulating wings are opened or closed. This mechanism keeps the table's orientation centered in the room as the wings are shifted.

Keystone Surface

Primary Surface

**Surface Colors**

Separate laminate color selections can be made for the Primary Surface, the Keystone Surface, and the Extension, if applicable.

**Technology**

Keystone provides AC power and supports direct installations of voice and Cat. 5 data.



## SEIRI SCREEN

**DESIGN INTENT:**

Named for the Japanese term for “sorting” or “arranging,” Seiri Screens provide an elegant means of space delineation and seated privacy in open plan configurations at a substantial cost savings vs. traditional panels. Seiri Screens ship with unique magnetic “bins” for arranging desktop items and removing horizontal clutter.

Seiri Screens come in two height dimensions, providing two surprisingly distinct levels of collaboration/privacy. These tackable screens are covered in 100% recycled fabric.

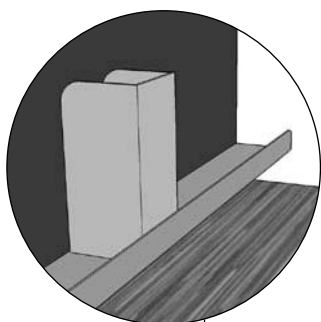

Each screen ships with 4 steel bins per side that work independently or in pairs to accommodate an unlimited array of documents and other items. Each bin fits snugly into the screen's steel tray and is held firm by a magnet.

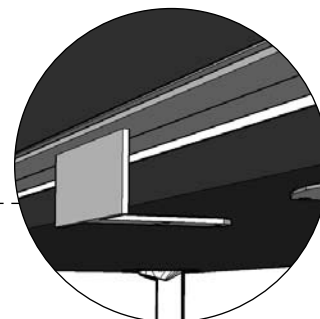
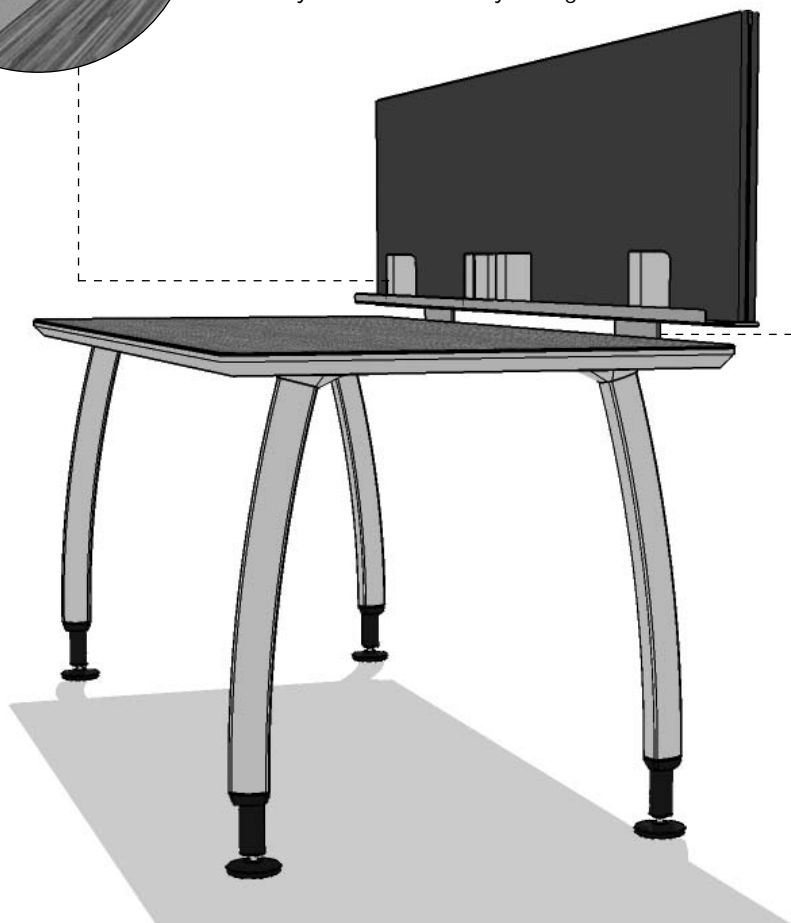

Seiri Screens are bracketed to desk edges.

## SOLO/BEAMER TECHNOLOGY CARTS

### DESIGN INTENT:

With offices changing, and technology racing along too, a structure is needed to support those transformations. **Solo technology carts** allow technology to be mobile and independent of the worksurface. This enables a user to easily and instantly reposition their desk for conferencing without moving the tethered technology. Additional applications include podium and interactive kiosk scenarios.

**Beamer carts** extend the value of LCD projection units by facilitating fast, easy movement between multiple locations. Specialized handles provide grab points for pushing or pulling the cart and ease of steering. Beamer is equipped with a strap on the upper platform to secure the projector during transport.

### SOLO



### BEAMER

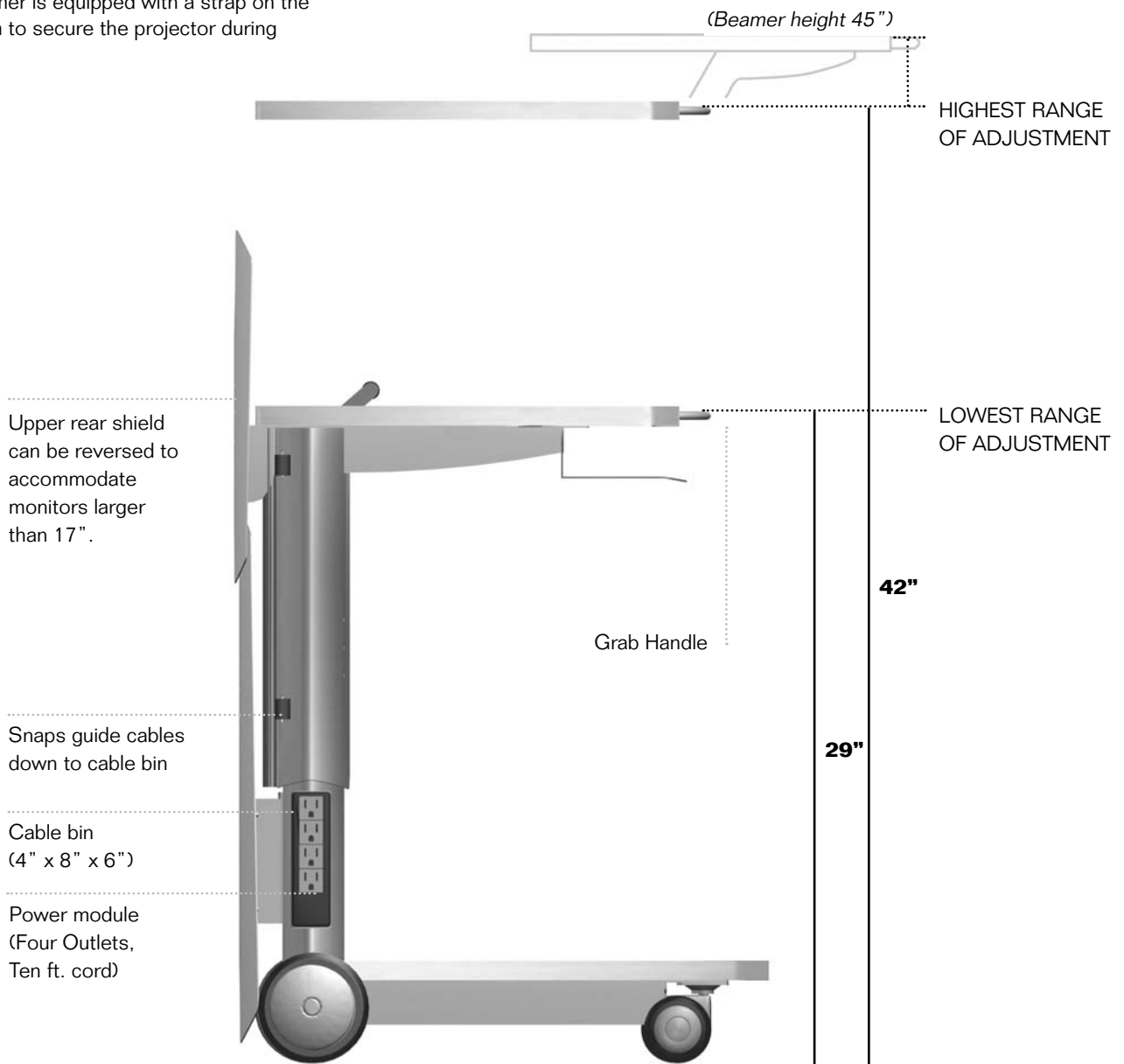

### ADJUSTABLE SOLO AND BEAMER

## ECHO MARKERBOARD

### DESIGN INTENT:

Echo was designed to be the “mobile phone of marker boards” - a mobile communication tool with personal appeal in its casual but professional appearance and intuitive simplicity. Naturally mobile, Echo rests on four wheels for stability and ease of relocation.

Echos come with full-length, dry erase marker surfaces on each side and mounting knobs for paper flip charts or other two-dimensional media.

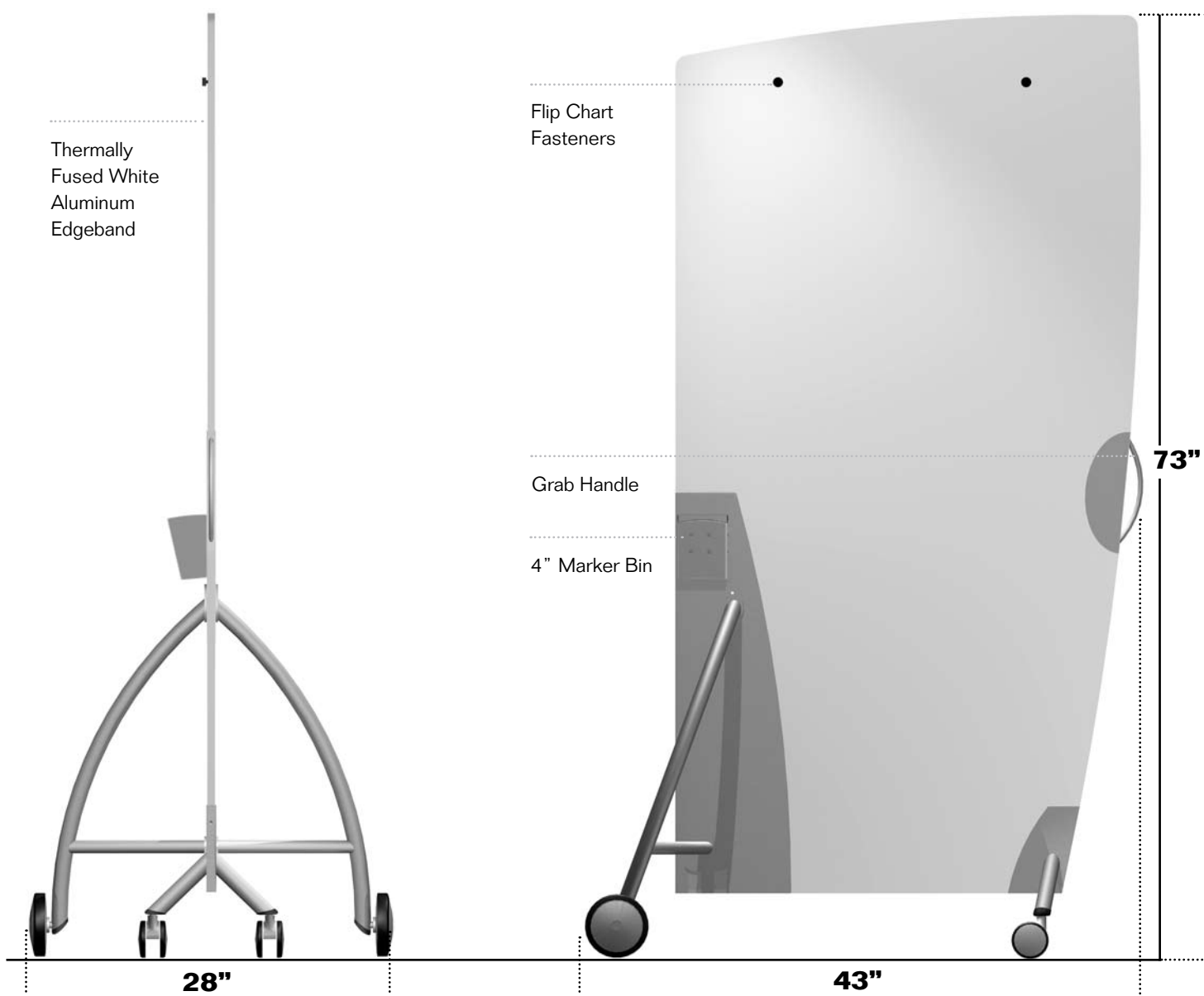

### ECHO MOBILE MARKERBOARD

# NOTES

**For Customer Service Inquiries, please contact:**

**800.426.1202**

**360.394.1322** *fax*

[www.watsondesking.com](http://www.watsondesking.com)

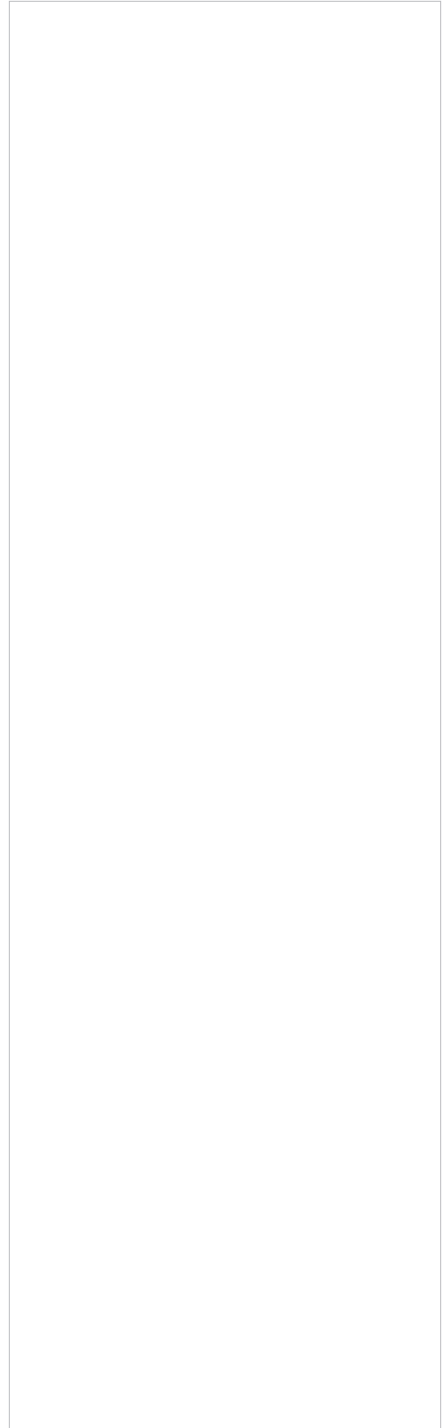
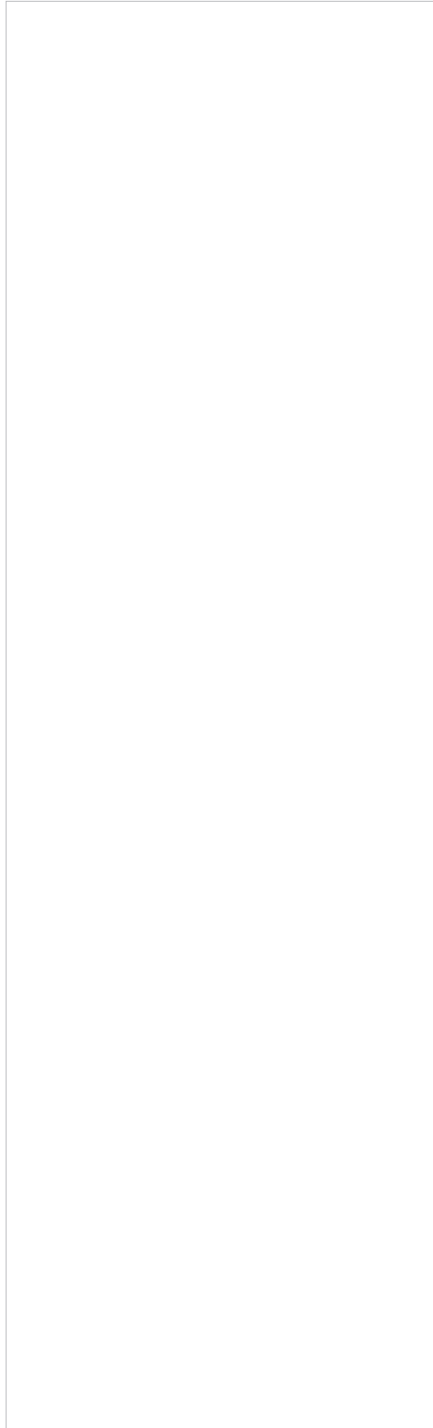
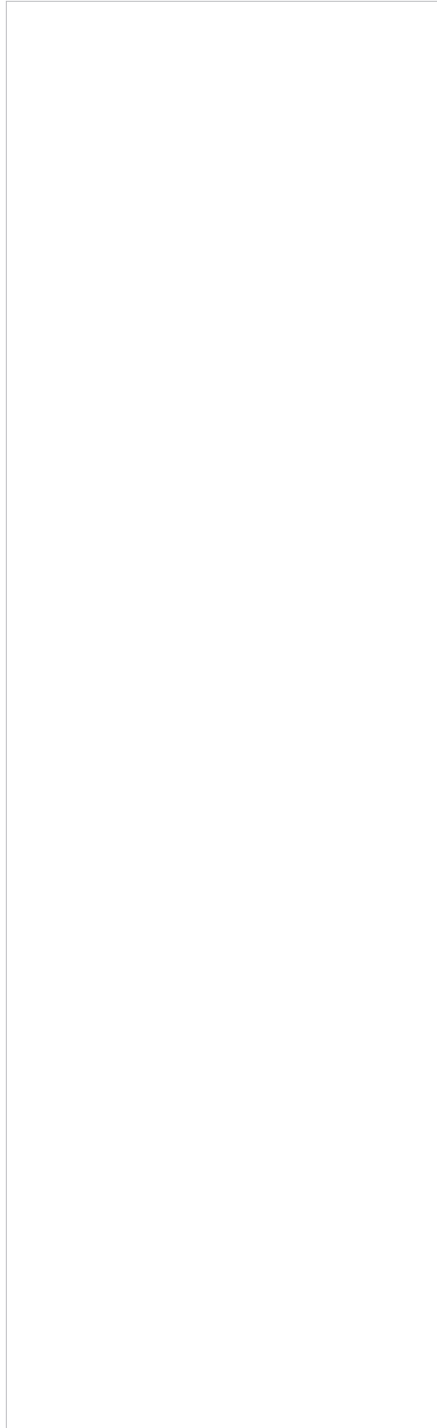

## DESK COMPONENTS

### Parabolic and Impulse Leg Tube

The tube is induction welded cold rolled steel, mill formed on a progressive die line from coiled sheet steel, roughly 12 gauge material at .084 inch thick.

### Extension Assembly

#### Components:

The adjustable assembly is made of two primary components called the Collar (sleeve that is mounted in the tube) and the Column (shaft with the adjustment hole pattern). The Column is held rigidly in place within the collar using setscrews to obtain a solid mechanical interlock. Glide Pads and Casters fasten to the bottom of the Column.

#### Materials:

Column and Collar are made of recyclable 10% glass filled Nylon thermoplastic. The Column is a solid material shaft, reinforced with a .5-inch diameter structural steel core for maximum rigidity.

#### Column:

A .5-inch center to center height adjustment hole spacing, held by 2 Allen drive 1/4-20 set screws for a stout grip into the .125 inch deep holes. The holes are chamfered to better lead the setscrews into alignment.

#### Adjustment setscrews:

The two setscrews require only 4 revolutions each to release the column for adjustment. The setscrews being just proud of the leg tube surface indicate their properly installed depth.

#### Adjustment inserts:

The two setscrews are set in the Collar's steel dual threaded insert plate to carry the load of the leg, preventing insert pull-out and stripping of the inserts within the Collar.

#### Glide Pads:

Three-inch diameter pads have .75" maximum height adjustment and 25 degree orbital pivot capability.

#### Castors:

Desk casters are load rated at 75 pounds each.

### Stride Legs

A mounting bracket of dual channel 12-gauge cold rolled sheet steel is used for all three leg widths of 24, 27 and 30 inches. The brackets use a box structure for rigidity.

### Vibe Legs

Vibe legs have an 86-inch exterior bend radius. Mounting plate is stamped from 12 gauge cold rolled sheet steel that is perimeter MIG welded from the top, hiding the weld for cleaner appearance, and resulting in a stronger seam.

### Bridge Legs

Parabolic tube is CNC miter cut and TIG welded at twin 45-degree joints. Two identical brake formed 12 gauge cold rolled sheet steel brackets use a box structure for rigidity.

### Impulse Legs

Top support brackets are 13-gauge cold rolled sheet steel. Crank handles are die cast zinc alloy and powder-coated. Toecaps are injection molded 10% glass filled Nylon. Glides are screwed into metal inserts welded into the horizontal parabolic tube to assure the glide connections are not damaged when the furniture is moved. Adjustment mechanism utilizes beveled gear lift assemblies in each leg connected by extruded aluminum shafts.

Decorative shrouds are magnetically attached to the 2" x 2" Impulse leg and are formed of 16-gauge sheet metal. An injection-molded polyethylene cap snaps into the shroud cover once in place.

### Worksurfaces

#### Materials:

Worksurfaces that are edged with a synthetic material (Xylo, Bounce and Duet) are 1.25" thick and are composed of horizontal grades of plastic laminate and backing material bonded to a 1.125" industrial grade particleboard. Watson particleboard is recovered from Douglas Fir. The longer strands of the Douglas Fir provide superior deflection characteristics.

Worksurfaces that feature a Stretta Fender, 45 or N-45 edge are 1.25" thick and are composed of horizontal grades of plastic laminate and backing material bonded to a 1.125" MDF. The MDF is double refined to assure uniformity of finish and strength of product (MDF has equal or greater screw holding strength than particleboard, and nearly equals the deflection characteristics of Douglas Fir particleboard).

Worksurfaces that have unreinforced spans in excess of 48" include steel reinforcement members to help reduce deflection.

### Metal-to-Metal Connections:

Legs are fastened to the desk surfaces with machine screws threaded into metal inserts.

### Built-in Cable Management:

Cable management is provided in all tops, using routed Snap Points that accept proprietary Snap clips. Five Snaps are included with each desk.

### Edges

#### Xylo, Bounce and Duet:

These are synthetic edges made of an extruded PVC polymer, with a durometer chosen for its flexibility, durability and self healing properties. Xylo is 3mm thick with a softly radiused top and bottom edge profile that provides comfort, protection and economy. Bounce is 11mm thick and softly profiled for comfort and appearance. Duet is a combination of a 2 mm thermofused edgeband, applied to the non-user edges to allow a more seamless desk alignment, and Bounce applied to the user edge for comfort.

#### Stretta, Fender, 45 and N-45:

Stretta, Fender, 45 and N-45 edges are shaped by custom profiled CNC cutting head which exposes an MDF substrate. Stretta is the pure MDF edge with clearcoats or colored stains, cut in a soft bevel form to lighten the desk appearance while maintaining the structural qualities of the 1.25" board material. Fender is the Stretta edge with a finer proportioned version of the durable Bounce edge around it. This covers the laminate core, adds comfort when resting against the edge, provides impact protection, and supplies an additional level of design refinement. 45 is structurally similar to the Fender edge, but features a forty-five degree chamfer detail that increases edgeline visibility. The N-45 edge differs only slightly from the 45 edge option as it does not utilize the bumper.

**Worksurface dimensions are nominally adjusted by 1/2" to allow for movement.**

**STORAGE**

**Materials**

The following materials are common to Motos, Cabs, Brios and Sidekicks:

**Cases:**

3/4" 45 lb. dense Ultrablend industrial particleboard thermally fused with low pressure laminates on each face.

**Edging:**

2mm thermofused extruded PVC polymeric edge-band.

**Drawers:**

Drawer bodies feature full extension 100 lb. (200 lb. on lateral files) ball bearing slides.

**Locks:**

Locks are standard on all drawers (except the pencil drawer) and are keyed randomly.

**Pencil Drawers:**

Moto pencil drawers are thermo formed of .125 inch thick, textured High Impact Polystyrene sheet material with three ovoid frontal compartments and four elongated central, rear compartments supported by full extension slides.

**Anti-tip:**

Motos with file drawers and Brio lateral files are counterbalanced. Lateral file drawers feature an anti-tip interlocking drawer slide which allow for opening of only one lateral drawer at a time.

**Motos and Cabs**

**Base pans:**

Sturdy 16 gauge cold rolled sheet steel, with MIG welded .5 inch solid steel plate axle blocks for the rear wheels (Motos and Single Cabs only).

**Static Load Capacity:**

Motos and Cabs can support 300 lb. static loads.

**Tambour Doors:**

.035 inch matte finish translucent Polyethylene sheet material that runs smoothly and quietly along die extruded aluminum channels.

**Casters:**

Motos and Single Cabs have fixed direction rear wheels and lockable pivoting front casters. Double Cabs have 4 non-locking pivoting casters to allow the unit to be pushed sideways with stability through narrow doorways.

**Overdesk Shelves**

**Shelf Support Brackets:**

Brackets are constructed of 12 gauge cold rolled steel 'V bend' structure. User positionable with wood and setscrews to assure a solid connection.

**SOLO & BEAMER CARTS**

**Materials**

**Platforms:**

Platforms are constructed of 3/4" 45 lb. dense Ultrablend industrial particleboard thermally fused with low pressure laminates on each face and edged with 2mm thermofused extruded PVC polymeric edge-band. The upper platforms are height adjustable 13 inches, from 29 to 42 inches with a right hand crank handle, utilizing the same proprietary beveled gear lift mechanism found in the Impulse leg base.

**Casters:**

The combination of fixed direction rear wheels with pivoting front casters allows the units to be easily steered during relocation.

**Undercarriage:**

The undercarriage is fabricated with dual 12 gauge cold rolled steel box formed channels, MIG welded to horizontal parabolic axle tubes.

**ECHO MARKERBOARDS**

**Materials**

**Marker Panels:**

White dry erase marker panels are standard marker board laminates cold fused to .5" industrial grade particle board. Panels are edged with 2 mm thermofused extruded PVC polymeric aluminum finished edge-band. Proper care for the writing surfaces is similar to a car: wash with a mild detergent when necessary and occasionally wax with an off the shelf marker-board conditioner.

**Mobile Echo Legs:**

Rear legs are of 1.25" OD round steel tubing, braze welded for precision joining to .188" through-bolted mounting plates. The offset, swept-back leg geometry restricts the board's natural vibration harmonic to ensure writing comfort and accuracy.

**WERKRAIL**

**Materials**

**Rail:**

Rail is of .75 inch thick, recyclable, textured HDPE plastic, CNC shaped with custom profile cutting heads. HDPE is the same material as the tambour doors.

**Support Brackets:**

Brackets are a combination of MIG welded 12 and 16 gauge cold rolled sheet steel components.

## Terms of Sale

This Price List and these Terms of Sale supercede all previous price lists and terms. These prices and terms are subject to change without notice.

## Prices

List prices include freight costs as specified below. No other charges are included in Watson's list prices unless otherwise specified in writing.

## Terms of Payment

Terms of payment will be established based on the credit rating and credit information provided by and for specific customers. Orders are invoiced at time of shipment. Standard payment terms are 50/50; 50% due at time of order and 50% due at time of shipment. Approved credit levels may be extended to net thirty (30).

Past due accounts will be charged the lesser of 1.5% per month or the highest rate permitted by law plus all collection costs, including reasonable attorney's fees and expenses.

## Taxes

The Customer shall pay all sales, use, excise and other taxes applicable to the sale. Resale and/or exemption certificates must be forwarded to Watson at the time of order.

## Order Acceptance

All orders must be submitted in writing. Watson does not accept an order until the order is verified complete by a Watson Project Manager, which will include price information and anticipated arrival date. The Order Confirmation is the final expression of the contract between the Customer and Watson.

## Order Changes and Cancellations

Purchase orders may not be changed or cancelled, in whole or in part, without prior written consent of Watson. Changes may effect delivery dates. Expenses incurred because of changes will be charged to Customer. In the event of cancellations, Customer will be liable for reasonable cancellation charges established by Watson. Orders for customized products, custom finishes and Customer's Own Material (COM) items, hereinafter defined, may not be cancelled.

## Returns

The return of Products without a written authorization by Watson shall not be accepted. If Watson agrees to repurchase the product pursuant to a valid authorization, the Customer must return the Product freight prepaid to Watson. The returned product shall be subject to a 25% of list restocking charge. All returned Products must be unused and in original condition.

Watson will not accept returns on orders that include COM materials.

## Landed Freight Program

### Order Minimums

Order minimums have been determined to help us accurately compensate for our freight expenses on low-volume orders. Minimum order and freight charge rates for all territories\* have been specified below by zone.

*\* Overseas and non-contiguous US shipments made to a prearranged departure port in any zone, will adhere to the defined order minimum and freight charges in that zone; carton packing charges may also apply to overseas shipments.*

### ZONE 1 (Local)

*Seattle, Bellevue, Tacoma, Kitsap County, and the surrounding Puget Sound area*

- For all orders less than \$10,000 list, a freight charge of 5% list will be applied; fuel surcharges do not apply to these orders.

### ZONE 2

*WA, OR, and CA*

- For all orders less than \$15,000 list, a freight charge of 5% list will be applied; fuel surcharges do not apply to these orders.

### ZONE 3

*Contiguous US and Canada outside of WA, OR, and CA*

- For all orders less than \$15,000 list, a freight charge of 10% list will be applied; fuel surcharges do not apply to these orders.

### Variable Fuel Surcharge

A Variable Fuel Surcharge will be applied to all orders over the established minimum order in each freight zone. The variable fuel surcharge (currently 3.6% of net) reflects fuel surcharge costs that our carriers charge, and will be applied to the order as follows: net price total of products multiplied by the variable fuel surcharge. Updated monthly, the Variable Fuel Surcharge rate is subject to change and should be confirmed at the time of quote.

To view the Variable Fuel Surcharge and zone map online, please visit [www.watsondesking.com/terms](http://www.watsondesking.com/terms).

## Shipping Program

Watson Furniture Group employs an environmentally friendly shipping program that reduces costs and helps ensure furniture is delivered in the same condition as it left the factory. This careful handling may occasionally lengthen shipping times on LTL shipments.

### Blanket wrap

This environmentally preferred process eliminates waste and reduces installation time associated with package removal and disposal.

### Air-ride

Watson utilizes carriers whose trailers are equipped with air-ride suspension to minimize vibration and avoid damage in transit.

### No cross docking

Once loaded on the truck, product will not be consolidated, moved, or off-loaded until the point of delivery.

At Watson's discretion and if it is determined in the best interest of customers, alternative shipping methods may be used. Special requests including special shipping methods, delivery outside normal hours (8 a.m. to 5 p.m. Monday through Friday), inside delivery, notification, etc. shall be subject to an additional charge to the customer.

## Claims

Risk of loss passes to Customer upon Watson's delivery of the product to the carrier. Product shortages and damage must be noted on delivery receipts at the time of receipt by the Customer or Customer's agent. If the carrier damaged the Product while in transit, the Customer has sole obligation of seeking any recourse against the appropriate carrier. Claims against Watson for shortages and errors must be made within seven (7) days of the date of delivery.

## Title

Title to the Product shall remain with Watson until the Product is fully paid for.

## Packaging

Worksurfaces and storage components are sent blanket wrapped. Frames are sent in cartons. The Customer may specify cartoning. To specify cartoning for all items add 5% of total list price

**Storage**

Watson may transfer Product to storage at the Customer's risk and expense if the Customer is unable to take delivery of product as scheduled. Upon such transfer to storage, the Customer assumes risk of loss. Watson will invoice the Customer on a monthly basis for storage fees and the Customer will make payments in accordance with Watson's standard payment terms.

**Loss, Damage or Delay**

Watson shall not be liable for any loss, damage or delay resulting from forces beyond its reasonable control including fire, flood, strike or other labor difficulty, act of God, inability to obtain necessary labor, materials, or manufacturing facilities from usual sources, failure of suppliers to meet their contractual obligations or due to any cause beyond its reasonable control.

In the event of any such delay, delivery will be postponed by such length of time as may be reasonably necessary to compensate for the delay.

**Customer's Own Material (COM)**

Customers may request fabrics, surface materials, and powdercoats that are not standard to Watson's finish offering according to the guidelines below.

Watson Customer Service will apprise customers of any possible impact on lead times resulting from the use of off-card materials and finishes.

Watson shall not be responsible for the appearance or performance of any COM material and customer shall hold Watson harmless for any damages or losses arising out of, or related to, the use of the COM on the Product.

PRODUCT REPAIR OR REPLACEMENT IS THE CUSTOMER'S EXCLUSIVE REMEDY FOR ANY AND ALL PRODUCT DEFECTS.

COM orders cannot be cancelled and Watson will not accept product returns.

**Miro, M2, Fusion**

**Fabric**

- All COM requests for special fabric must be tested and approved by Watson Furniture Group.
- A minimum sample of 3 yards must be submitted to Watson for testing.
- Watson will notify customer of test results within 5 business days and provide written approval and a COM request form.
- Upon approval, customer must provide production quantities of the approved fabric at least five

days before production begins.

- No price adjustments will be made for customer-supplied fabric.

**Laminates**

- Watson must approve all COM requests for laminates not listed on finish card.
- Non-specialty laminates from WilsonArt that are not on our finish card will be available subject to a \$500 list upcharge for recycling excess materials.
- For requests concerning all other vendors and all specialty laminates, please contact Customer Service, which will determine manufacturability, schedule, and pricing.
- Evaluation of requests will take no longer than three business days.
- Watson will contact laminate vendors directly to determine availability and lead times.
- Upon approval and order acknowledgement, Watson will purchase COM laminates and arrange delivery to facilitate the production schedule.

**Powder**

- Customer must provide powder sample for testing.
- Upon approval, customer must provide production quantity powder three days in advance of scheduled beginning of production.
- No price adjustments will be made for customer supplied powder.

**Frames**

Approval of COM orders for Frames panels will be subject to an additional two week lead time.

**Warranty**

Watson warrants to the original Customer that the Products it manufactures are free of defects in craftsmanship and materials found during normal single shift (40 hour work week) usage of the products during the warranty period. Watson shall, upon prompt written notice, repair or replace, at its option and costs, the affected part or parts. All separate component parts not manufactured by Watson (keyboard mechanisms, power and data devices, etc.) shall be covered by the original manufacturer's warranty.

This warranty does not apply to:

- Damage caused by a carrier.
- Normal wear and tear.
- Defects caused by improper installation.
- COM or other third party materials applied to the products.
- Products subjected to improper use and conditions.
- Damage resulting from misuse, negligence, accident or alterations.

**Warranty Period**

Five Years: Motors and other electrical components.  
Lifetime: All other components.

EXCEPT AS STATED ABOVE, WATSON MAKES NO EXPRESS OR IMPLIED WARRANTIES AS TO ANY PRODUCT AND IN PARTICULAR MAKES NO WARRANTY OF FITNESS FOR ANY PARTICULAR PRODUCT EXCEPT FOR USE AS STANDARD OFFICE FURNITURE. PRODUCT REPAIR OR REPLACEMENT IS THE CUSTOMER'S EXCLUSIVE REMEDY FOR ANY AND ALL PRODUCT DEFECTS.

The remedies provided above are the Customer's sole remedies for any failure of Watson to comply with its obligations regarding the workmanship of its products.

MAY 2009

Visit [www.watsondesking.com/finishes](http://www.watsondesking.com/finishes) for finish color representations or to order sample chips.

## FABRICS

### ANCHORAGE PATTERN

- 9B** Amber
- 9A** Angora
- 6D** Asteroid
- 9C** Coffee Bean
- 9U** Cumin
- 9D** Deep Water
- 6X** Fossil
- 9N** Goldenrod
- 9E** Goose
- 9R** Graphite
- 90** Green Olive
- 6H** Henna
- 9M** Midnight
- 9L** Mulberry
- 6Z** Onyx
- 6Q** Quarry Blue
- 9I** Red Delicious
- 6T** Slate
- 9S** Straw
- 9W** Willow

### CROSTOWN PATTERN

- 3U** Buff
- 3E** Cement
- 3H** Chamois
- 3F** Fieldstone
- 3Y** Mystic
- 3X** Ray
- 3I** Sterling
- 30** Stucco
- 3N** Waterfront

### MINGLE PATTERN

- 5B** Biscuit
- 50** Carbon
- 5Y** Crystal
- 5H** Green Tea
- 5K** Khaki
- 5U** Putty
- 5D** Rapids
- 5X** Straw
- 5W** Winter

## EDGE STAINS

- CH** Charcoal
- ZE** Clear

## POLYMER EDGES

- BK** Black
- CH** Charcoal
- JT** Jute
- GY** Satin Gray
- SG** Slate

## POWDERCOAT / STORAGE CASES

- BK** Black
- CH** Charcoal
- M2** Mica
- GY** Satin Gray
- SG** Slate
- WA** White Aluminum
- WL** White Linen

## FRAMES POWDERCOAT

- CH** Charcoal
- GY** Satin Gray

## SMARTGRAIN LAMINATES

Smartgrain laminates feature the polish and lux of a real wood veneer, with a subtle, narrow grain structure and higher gloss level. This gloss level (Glossometer reading of 38 compared to readings of 100 for High Gloss laminates and 10 for Matte laminates) provides a dramatic appearance but specifiers should be aware of the potential for increased fingerprinting.



## SMARTGRAIN LAMINATES (textured)

(Miro, M2, Fusion)

- A1** Asian Night\*
- A2** Asian Sand\*
- B8** Blond Echo\*
- C5** Colombian Walnut
- M0** Mambo
- DA** Madagascar\*
- RI** Rio
- W1** Williamsburg Cherry\*

*\*Also available as a Standard Laminate, non-textured.*

**STANDARD LAMINATES**

(Miro, M2, Fusion, Frames)

**AB** Alabaster  
**A4** Almond Leather  
**AZ** Amazon  
**AC** Amber Cherry  
**AN** Antique Brush  
**KQ** Antique Roca  
**WQ** Antique White  
**JN** Asian Night  
**JS** Asian Sand  
**UI** Asian Sun  
**TI** Atlantis  
**OB** Bannister Oak  
**BE** Beige  
**BN** Beige Nebula  
**EI** Beige Pampas  
**BI** Beigewood  
**YB** Beryl Brush  
**IB** Biltmore Cherry  
**BK** Black  
**BJ** Blackstar Granite  
**EH** Blond Echo  
**ZW** Brazilwood  
**BR** Brittany Blue  
**BZ** Bronze Legacy  
**BS** Brune Slate  
**BC** Burnished Chestnut  
**UE** Burnished Ember  
**EM** Café Crème  
**C6** Caldera Beige  
**ZN** Canyon Zephyr  
**GV** Carbon EV  
**EJ** Carbon Mesh  
**OQ** Castle Oak  
**LD** Cloud  
**CN** Cloud Nebula  
**ZL** Cloud Zephyr  
**VR** Copper EV  
**EX** Copper Mesh  
**KR** Coral Roca  
**ZQ** Crisp Zephyr  
**CT** Curry Tigris  
**DR** Dakota Ridge  
**DZ** Desert Zephyr  
**DH** Designer White  
**DG** Dove Grey  
**EO** English Oak  
**ET** Evening Tigris  
**FQ** Fashion Grey  
**FH** Featherstone  
**QF** Figured Mahogany  
**LN** Flame Soapstone  
**F1** Fleece  
**FP** Fonthill Pear  
**F2** Fresco  
**FJ** Frosty White  
**FM** Fusion Maple  
**VH** Galvan  
**IQ** Gilded Marquetry

*STANDARD LAMINATES (CONT)*

**OJ** Golden Oak  
**G5** Granite  
**GN** Graphite Nebula  
**RY** Green Legacy  
**G4** Green Soapstone  
**GT** Green Tigris  
**QT** Grey  
**GG** Grey Glace  
**EG** Grey Mesh  
**YN** Grey Nebula  
**GP** Grey Pampas  
**HZ** Haze  
**HG** Heather Legacy  
**HE** Hollyberry  
**H1** Hunter Green  
**HN** Hunter Nebula  
**HU** Huntington Maple  
**IN** Indigo  
**IL** Iron Legacy  
**KA** Karratha Brush  
**KM** Kensington Maple  
**KB** Khaki Brown  
**LB** Lapis Blue  
**LU** Larkspur  
**LJ** Light Beige  
**LR** Limber Maple  
**LT** Lithium EV  
**LZ** Loden Zephyr  
**LO** Lodestone  
**ZD** Madagascar  
**OM** Manitoba Maple  
**UH** Maroochy Brush  
**DD** Mission Adobe  
**DL** Mission Glaze  
**DJ** Mission Sage  
**DN** Mission Sand  
**DQ** Mission Shadow  
**XK** Mission Smoke  
**IX** Mission Stone  
**DU** Mission Stucco  
**EZ** Misted Zephyr  
**MW** Montana Walnut  
**OH** Monterey Haze  
**MR** Monterey Storm  
**MJ** Monterey Sun  
**MM** Monticello Maple  
**OZ** Morro Zephyr  
**YD** Mystique Dawn  
**YU** Mystique Dusk  
**MQ** Mystique Marine  
**YA** Mystique Marsh  
**YL** Mystique Moonlight  
**YO** Mystique Mount  
**YI** Mystique Night  
**AO** Natural Almond  
**NL** Natural Legacy  
**NN** Natural Nebula  
**NJ** Natural Pear

*STANDARD LAMINATES (CONT)*

**KX** Natural Roca  
**NT** Natural Tigris  
**LY** Navy Legacy  
**N1** Nepal Teak  
**UJ** Neutral Glace  
**NW** New Age Oak  
**NE** Nickel EV  
**VJ** Nirvana  
**NR** North Sea  
**OR** Ochre Roletta  
**OS** Oiled Soapstone  
**OL** Olive Legacy  
**OX** Oxide  
**OV** Oxygen EV  
**AP** Pampas  
**OE** Pearl Soapstone  
**PJ** Pebble  
**PR** Pepperdust  
**PE** Pewter  
**PB** Pewter Brush  
**EP** Pewter Mesh  
**PL** Platinum  
**PT** Port  
**P4** Puma  
**UY** Putty  
**R1** Radium EV  
**RV** River Cherry  
**RU** Rustic Slate  
**L3** Sable Soapstone  
**ST** Saffron Tigris  
**D1** Sand  
**L4** Sanibel Maple  
**SV** Savoy Cherry  
**DW** Shadow  
**ZA** Shadow Zephyr  
**M3** Shale Moonstone  
**EE** Sheer Mesh  
**M4** Sierra Marble  
**S3** Silicon EV  
**SG** Slate Grey  
**SO** Solar Oak  
**ZI** Spiced Zephyr  
**EK** Steel Mesh  
**JO** Stratos  
**XE** Sunstone  
**TH** Tan Echo  
**TQ** Tan Soapstone  
**QL** Tawny Legacy  
**KE** Terra Roca  
**TV** Titanium EV  
**KU** Tumbled Roca  
**TE** Tungsten EV  
**TW** Tuscan Walnut  
**IZ** Twilight Zephyr  
**VX** Verdi Oxide  
**KV** Villa Roca  
**YW** Wallaby  
**JB** Western Bronze

*STANDARD LAMINATES (CONT)*

**JI** Western Hills  
**JR** Western Iron  
**XW** Western Storm  
**JU** Western Suede  
**JQ** Western Tan  
**JW** Western White  
**W4** White  
**XL** White Leather  
**EN** White Nebula  
**JH** White Sand  
**EU** White Suede  
**WG** White Tigris  
**WC** Wild Cherry  
**UC** Williamsburg Cherry  
**MA** Windsor Mahogany  
**WI** Windswept  
**WB** Windswept Bronze  
**WP** Windswept Pewter  
**WO** Woolamai Brush

**For Customer Service Inquiries, please contact:**

**800.426.1202**

**360.394.1322** *fax*

[www.watsondesking.com](http://www.watsondesking.com)

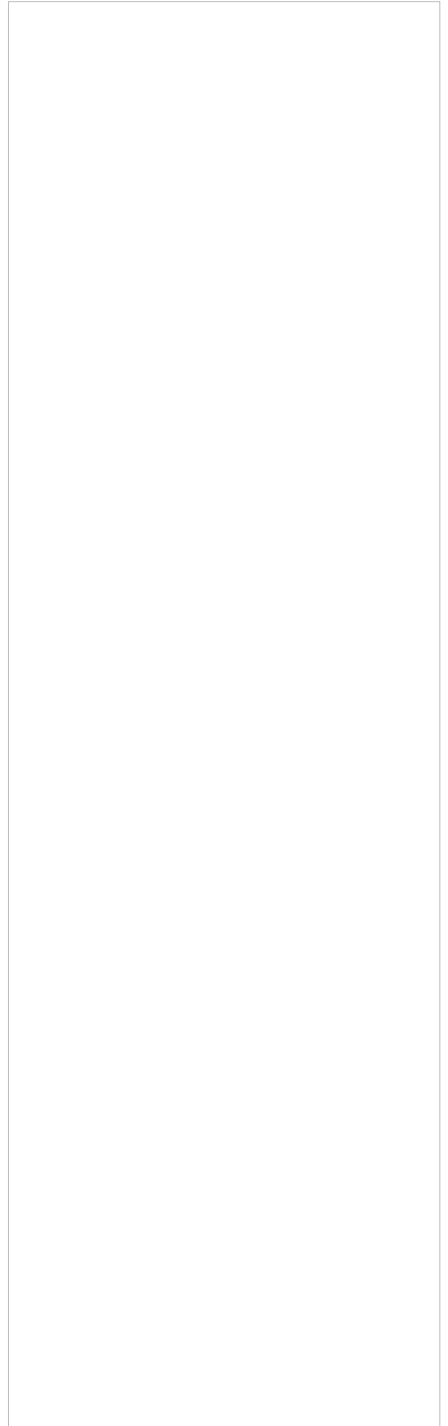
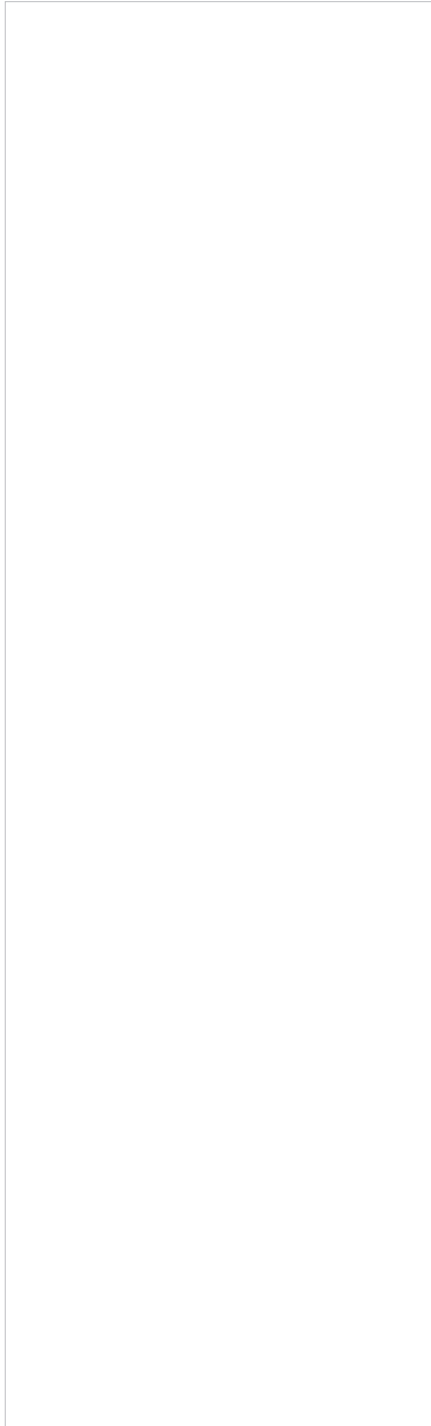
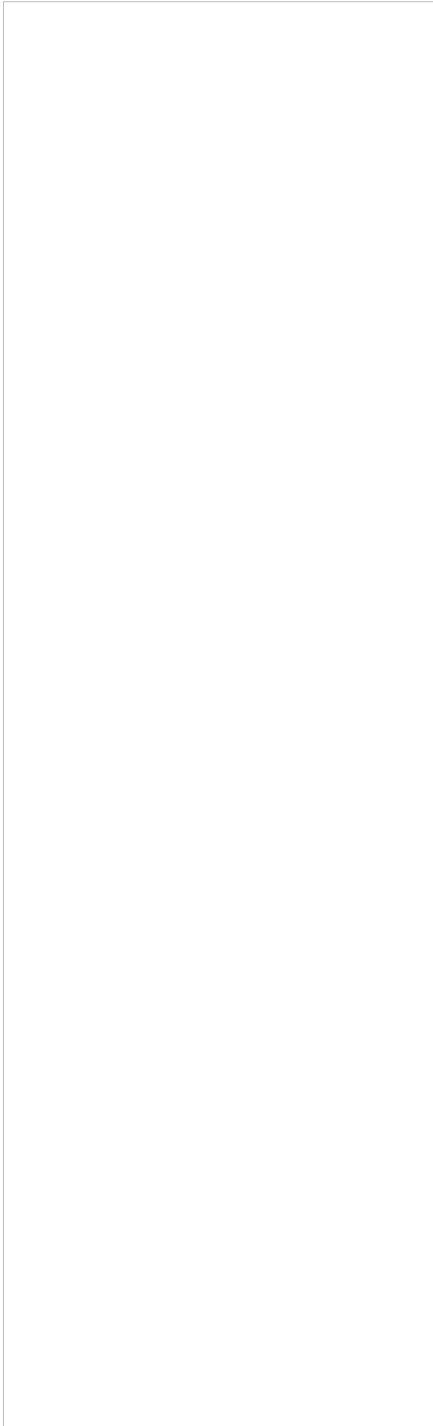

**THIS PAGE INTENTIONALLY LEFT BLANK**



WATSON DESKING

26246 Twelve Trees Lane NW  
Poulsbo, WA 98370

800.426.1202  
[www.watsondesking.com](http://www.watsondesking.com)



Watson Environmental Program  
Visit [www.watsondesking.com/stewardship](http://www.watsondesking.com/stewardship)