**Legenda - Description**

- 1 2: Poliuretani a densità e portanza differenziate  
2: Polyurethane foams at varied densities  
2: Polyurethanschaum in unterschiedlichen Raumdichtigkeiten  
2: Mousse polyuréthane à densités différenciées
- 3 Cuscino in piumino d'oca  
Cushion in goose dawn  
Kissen in Daune  
Coussin en plume d'oie
- 4 Piumino d'oca  
Goose dawn  
Daune  
Plume d'oie
- 5 Struttura in legno  
Wooden structure  
Holzstruktur  
Structure en bois
- 6 Piede in polipropilene  
Polypropylen feet  
Polypropylenfüss  
Pied en polypropylène
- 7 Cinghie elastiche da 60 mm.  
Elastic belts 60 mm.  
Elastische Gurte 60 mm.  
Sangles élastiques de 60 mm.

**Struttura**

In legno rivestito con poliuretano espanso indeformabile a densità differenziate e fibra poliesteri.  
Nella seduta è inserito un materassino in piumino d'oca.

**Imbottitura cuscini**

I cuscini di schiena sono in piumino d'oca.

**Piedi**

I piedi, avvitati alla struttura sono in polipropilene nero. Gli elementi vengono uniti tra di loro tramite un dispositivo d'aggancio in ABS color nero.

**Caratteristiche**

Il modello GLOBE è completamente sfoderabile.

**TAVOLO LINK:**

Basamento in acciaio inox satinato.

Piano in MDF laccato bianco RAL 9003 o nero opaco RAL 9005.

Sottopiedi in materiale termo plastico trasparente.

**Structure**

Wooden frame covered with stress-resistant polyurethane foam at varied densities and polyester fiber.  
The seat is covered with a goosedawn mattress.

**Padding**

Back cushions are in goose dawn.

**Feet**

Standard feet, screwed to the frame, are in black polypropylen. Elements can be linked together with a black ABS jointing device.

**Spec. Characteristics**

The model GLOBE is completely removable.

**LINK TABLE:**

Base in stainless steel.  
Tabletop in MDF white RAL 9003 or black lacquered mat RAL 9005.  
Underfeet in thermoplastic material.

**Struktur**

Aus Holz, mit unverformbarem Polyurethanschaum in unterschiedlichen Raumdichtigkeiten gepolstert und mit Polyesterwatte umhüllt.  
Der Sitz ist mit einer Matraze aus Gaensedaune ueberzogen.

**Kissen Füllung**

Rückenkissen in Daune.

**Füsse**

Fuesse aus Polypropylen schwarz am Gestell verschraubt.  
Die Elemente koennen an den Fuessen durch Verbindungselemente fixiert werden.

**Besonderheiten**

Das Modell GLOBE ist Komplett abziehbar.

**TISCH LINK:**

Untergestell in Edelstahl.  
Tischplatte in MDF weiss RAL 9003 oder schwarz matt lackiert RAL 9005.  
Unterfuesse in Thermoplast.

**Structure**

En bois recouverte de mousse polyuréthane indéformable à densités différenciées et ouatte syntétique.  
Un petit matelas en plumes d'oie est inséré sur l'assise.

**Rembourrage**

Les coussins du dossier sont en plume d'oie.

**Pieds**

Les pieds vissés à la structure sont en polypropylène noir. Les éléments peuvent être unis entre eux par un dispositif d'union en ABS couleur noir.

**Caractéristiques**

Le modèle GLOBE est complètement déhoussable

**TABLE LINK:**

Base en acier inox.  
Plateau en MDF laqué blanc RAL 9003 ou noir mat RAL 9005.  
Sous-pieds en materiau thermoplastique.

**Fodera** Cover **Tessuto** Fabric **Pelle** Leather **P. lordo** Gr. Weight **Volume** Volume  
 Ersatzbez Housse Stoff Tissu Leder Cuir Bruttogew. Poids Brut Volumen Volume

**Cod. 001**

**Poltrona**

Armchair  
Sessel  
Fauteuil

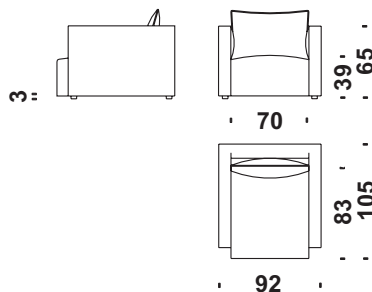

m 5,8 m² 10,6 Kg 35 m³ 0,85

**Cod. 018**

**Divano 2p major**

2 seater sofa major  
Sofa 2-Sitzig Major  
Canapé 2 places major

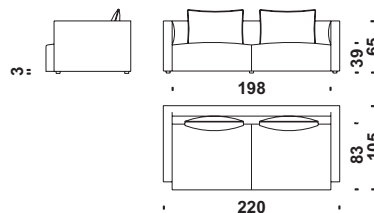

m 10,4 m² 19,1 Kg 70 m³ 1,6

**Cod. 003**

**Divano 3 posti**

3 seater sofa  
Sofa 3-Sitzig  
Canapé 3 places

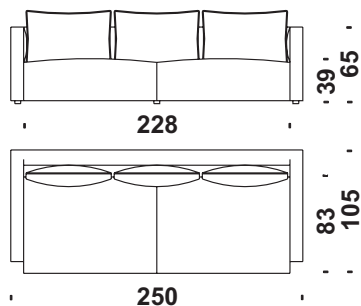

m 12,5 m² 23,2 Kg 80 m³ 1,85

**Cod. 010**

**Angolo**

Corner  
Ecke  
Angle

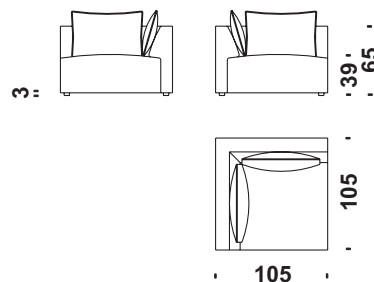

m 7,1 m² 13,2 Kg 45 m³ 0,95

**Cod. 011**

**Elem. 1 posto centrale 128**

1 seater element 128  
Zentralelement 128  
Élément central 128

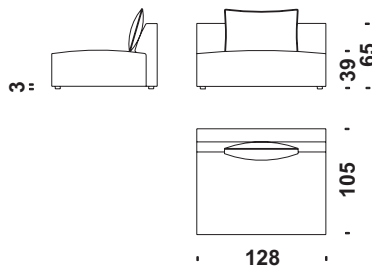

m 6,9 m² 12,6 Kg 40 m³ 1,1

**Cod. 06C**

**Elem. 1 posto centrale 95**

1 seater element 95  
Zentralelement 95  
Élément central 95

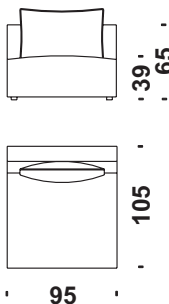

m 6 m² 11,2 Kg 35 m³ 0,85

Fodera  
Ersatzbez

Cover  
Housse

m Tessuto  
Stoff

Fabric  
Tissu

m<sup>2</sup> Pelle  
Leder

Leather  
Cuir

Kg P. lordo  
Bruttogew.

Gr. Weight  
Poids Brut

m<sup>3</sup> Volume  
Volumen

Volume  
Volume

**Cod. 022**

**Elemento 2p destro**

Lateral 2 seat unit right  
2-Sitz Element rechts  
Elément latérale droit

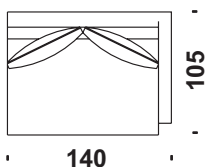
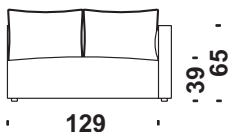

m 7

m<sup>2</sup> 13,1

Kg 55

m<sup>3</sup> 1,4

**Cod. 023**

**Elemento 2p sinistro**

Lateral 2 seat unit left  
2-Sitz Element links  
Elément latérale gauche

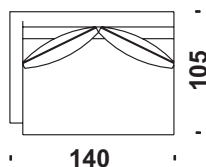
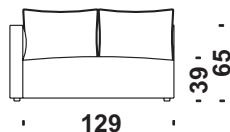

m 7

m<sup>2</sup> 13,1

Kg 55

m<sup>3</sup> 1,4

**Cod. 0D3**

**Chaise Longue destra**

Chaise Longue right  
Chaise Longue rechts  
Chaise Longue droit

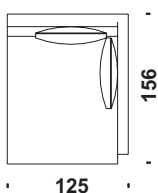
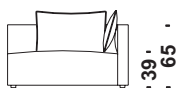

m 8,1

m<sup>2</sup> 15

Kg 65

m<sup>3</sup> 1,4

**Cod. 0D4**

**Chaise Longue sinistra**

Chaise Longue left  
Chaise Longue links  
Chaise Longue gauche

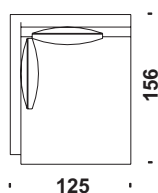
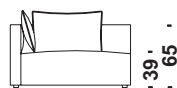

m 8,1

m<sup>2</sup> 15

Kg 65

m<sup>3</sup> 1,4

**Cod. 017**

**Globe pouf**

Globe stool  
Globe Hocker  
Globe pouf

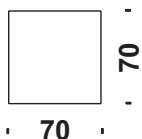

m 2,4

m<sup>2</sup> 3

Kg 18

m<sup>3</sup> 0,30

**Cod. 077**

**Globe pouf grande**

Globe large stool  
Globe Hocker gross  
Globe pouf grand

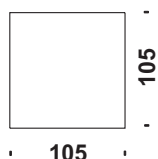
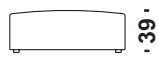

m 3,4

m<sup>2</sup> 5

Kg 24

m<sup>3</sup> 0,70

Fodera Cover Tessuto Fabric Pelle Leather P. lordo Gr. Weight Volume Volume  
Ersatzbez Housse Stoff Tissu Leder Cuir Bruttogew. Poids Brut Volumen Volume

**Cod. 080**

**Globe cuscino schiena**

Globe back cushion  
 Globe Rückenkissen  
 Globe coussin dossier



m 0,9 m² 1,2

**Composizione "A"**

Composition "A"  
 Zusammenstellung "A"  
 Composition "A"

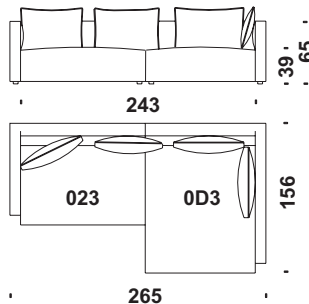

m 15,1 m² 28,1 Kg 120 m³ 2,8

**Composizione "B"**

Composition "B"  
 Zusammenstellung "B"  
 Composition "B"

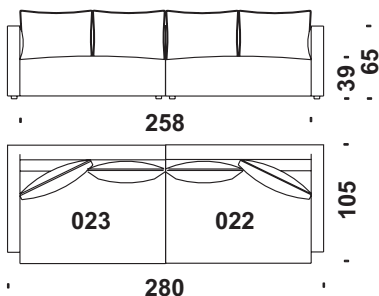

m 14 m² 26,2 Kg 110 m³ 2,8

**Cod. LI016**

**Link Tavolo**

Link Table  
 Link Tisch  
 Link Table

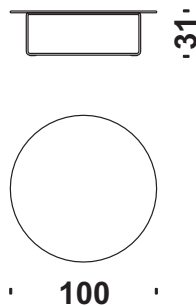

Kg 35 m³ 0,4