

# M\_COM TABLE





# THE INTELLIGENCE OF THE TABLE.

The office world is in the process of change. The technological revolution is changing work processes, organisational structures and management styles. Modern information and communication technologies make office work independent of time and place. However, that does not mean that the office is disappearing. On the contrary: in this virtual world it is becoming more important than ever to have a real point of crystallisation. What is required is a home base, in which a social network of relationships can arise. This is where employees develop a feeling of belonging to their company.

The actual framework for this communication process is created above all by the zones and areas which the respective departments and teams have at their disposal for meetings and conferences. Formal communication in interdisciplinary groups of varying sizes has today become a fixed component of everyday working life and runs through all hierarchical levels.

Bene's M\_Com Table is an intelligent table system which supports this communication process. With its wide variety of configurations, the M\_Com Table easily meets all the requirements of rooms used for meetings and conferences.











# M\_COM TABLE

A TABLE FOR ALL OCCASIONS.

Bene's M\_Com Table captivates by concentrating on essentials. A variable table system that makes a light optical impression and is designed for all levels of communication and management tasks. The slim triangular section of the table legs and the clear geometry of the table tops produce straightforward elegance. Ideal for face-to-face communication at meetings, conferences and seminars. The well-thought-out system, which comprises fixed single tables, foldable tables, suspended panels, touch-down attachments and screens, supports flexible utilisation.

Lightness, formal reduction and rapid transformability are characteristic of the M\_Com Table. The practical highlight: the table tops and foldable leg-stands can be stored quickly and easily on the transport cart and kept ready for mobile use. The M\_Com Table is an intelligent piece of system furniture, which can be used to create a variety of configurations for meetings and conferences.

Design: Christian Horner, Kai Stania





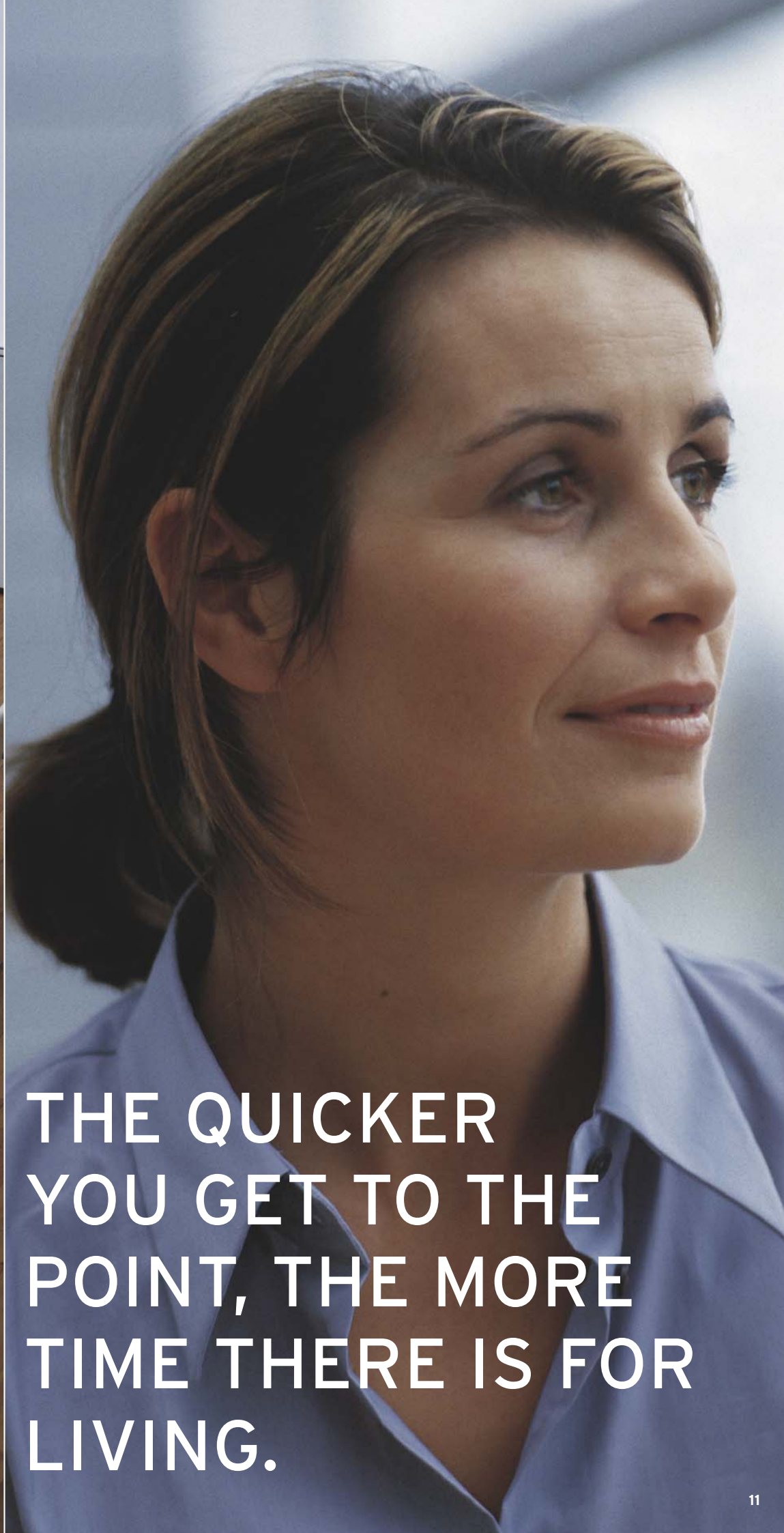

**THE QUICKER  
YOU GET TO THE  
POINT, THE MORE  
TIME THERE IS FOR  
LIVING.**



## M\_COM TABLE

Panel frames and triangular steel legs joined by means of cast-aluminium joints, powder-coated aluminium paint. 6 different panel forms made of E1 fine chipboard. Thickness 19 mm. Melamine-coated surface in various basic, decorative and bright colours or veneered. Height 72 cm, adjustable with a levelling screw.

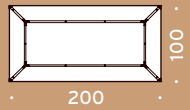
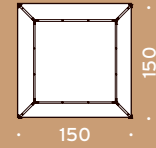
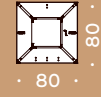
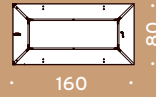
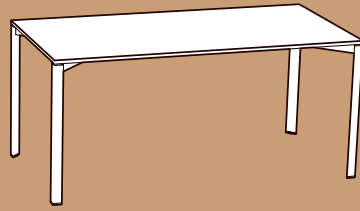

## SUSPENDED PANEL

6 different forms of panel made of E1 fine chipboard. Thickness 19 mm. Melamine-coated surface in various basic, decorative and bright colours or veneered. Panel stabilisation through 2 steel frames, powder-coated aluminium paint.

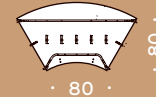
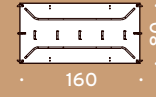

## COLLAPSIBLE TABLE

Panel frames with scissor-type mechanism and triangular steel legs, which can be combined in various configurations by means of cast-aluminium. Panel 160 x 80 cm made of E1 fine chipboard. Thickness 19 mm. Melamine-coated surface in various basic, decorative and bright colours or veneered. Panel and stand are connected by plastic clamps and can easily be taken apart. The stand can be folded together and stored with the panel on the transporter. Height 72 cm, adjustable by means of a levelling screw.

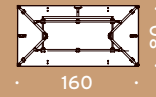
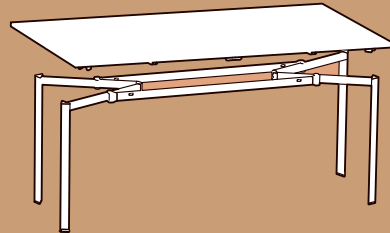

## SCREEN

Screen made of E1 fine chipboard. Thickness 12 mm. Melamine-coated surface in aluminium paint or veneered. Height 29 cm.

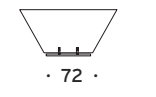
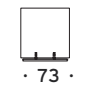
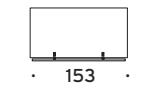

## ELECTRIFICATION

Standard, equipped with cable clamps. Optional: horizontal cable channel made of steel tubing, powder-coated aluminium, vertical plastic cable channel; various sockets above or underneath the table, with touch-down elements as desired.

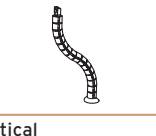
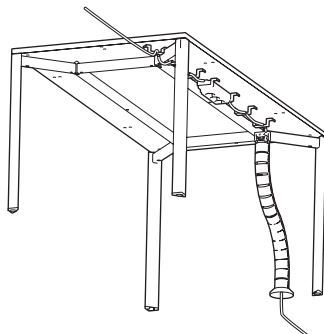

Suspended cable clamp

Screw-in cable clamps

Vertical cable channel

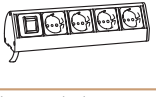
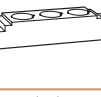

Horizontal cable channel

3-plug socket beneath the table

4-plug socket above the table

## TRANSPORTER

Stand made of steel tubing, powder-coated aluminium. Mobile with 4 double castors. Floor and rear made of E1 fine chipboard. Thickness 19 mm, melamine basalt surface. Measurements 186 x 74 cm, Height 116 cm.

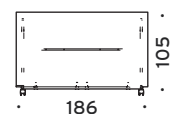
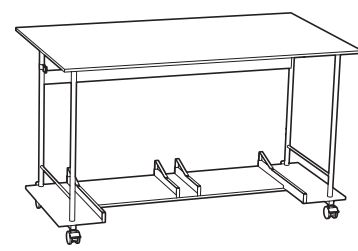
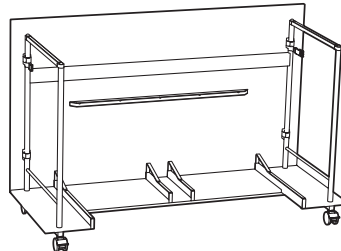

Transporter for up to 5 folding tables and 2 suspended panels

Can be re-assembled as a standing table by using the removable rear wall





FIXED  
COMBINATIONS

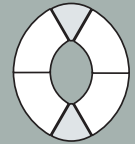
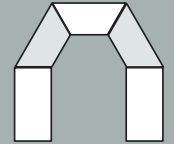
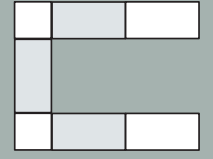
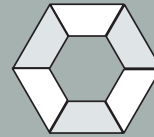
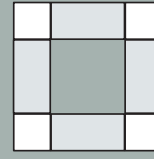
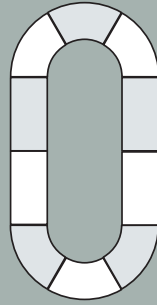
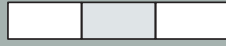
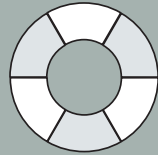
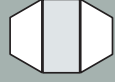
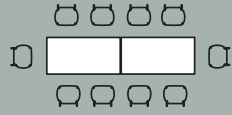

FLEXIBLE  
COMBINATIONS

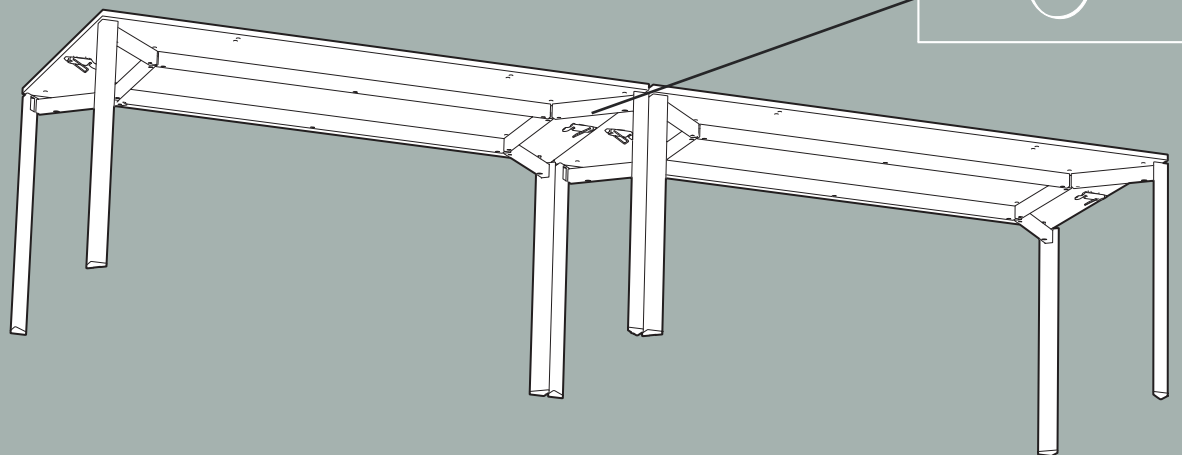
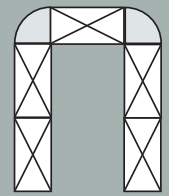
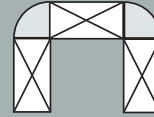
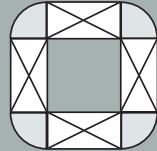
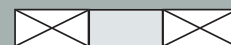

- M\_Com Table
- Suspended Panel
- ⊗ Collapsible Table







1

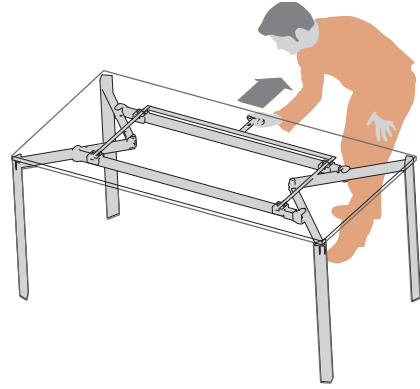

The panel can be easily detached from the frame, ...

2



... removed and stored on the space-saving transporter.

3

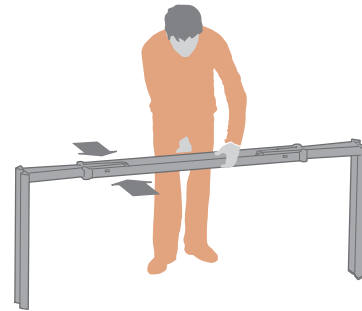

The frame is folded ...

4

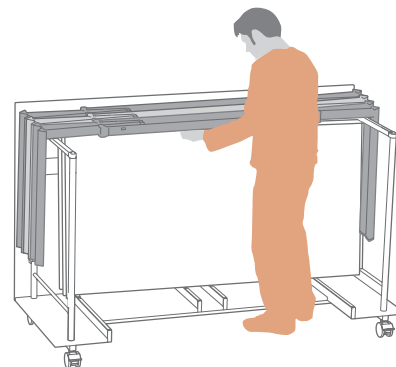

... and also stored on the transporter.









Transporter for foldable table and suspended panels



Insertable joint between M\_Com Table and suspended panel



Handle for releasing the panel brake in folding tables

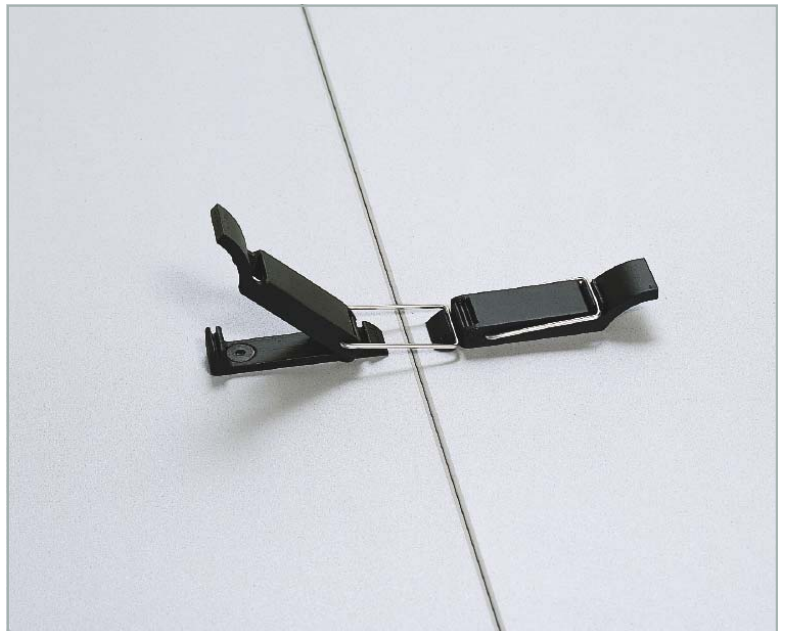

Stretching clamps for a stable connection between the M\_Com Tables



Levelling screw



M\_Com Table with vertical cable slinky and 4-plug socket with touch-down function





**HEADOFFICE:** A-3340 WAIDHOFEN/YBBS, Schwarzwiesenstraße 3, Tel. +43 (0) 7442 500-0, e-mail: office@bene.com, Internet: <http://bene.com>

**AUSTRIA:** 1010 WIEN, Rengasse 6, Tel. (01) 534 26-0. 3100 ST. PÖLTEN, Josefstraße 46a, Tel. (02742) 74 001. 4020 LINZ, Rainerstraße 14, Tel. (0732) 65 64 81. 5020 SALZBURG, Franz-Josef-Straße 35, Tel. (0662) 87 64 64. 6020 INNSBRUCK, Dr. Ferdinand-Kogler-Straße 30, Tel. (0512) 39 18 18. 6900 BREGENZ, Arlbergstraße 99-101, Tel. (05574) 753 20. 8010 GRAZ, Radetzkystraße 29, Tel. (0316) 82 12 71. 9020 KLAGENFURT, Villacher Ring 37, Tel. (0463) 541 45. **GERMANY:** 60311 FRANKFURT, Neue Mainzer Straße 31, Tel. (069) 26 95 96 0. **SWITZERLAND:** 8027 ZÜRICH, Dreikönigstraße 21, Tel. (01) 283 80 00. **GREAT BRITAIN:** LONDON, 47-53 St. John Street, EC1M 4AN, Tel. (0207) 689 12 34. **POLAND:** 00-609 WARSAW, Al. Armii Ludowej 26, Tel. (022) 579 34 80. **HUNGARY:** 1072 BUDAPEST, Rákóczi út 42., Tel. (01) 268 12 28. **CZECH REPUBLIC:** 12000 PRAGUE 2, Belgická 20, Tel. (02) 22 51 23 33. **SLOVAKIA:** 81103 BRATISLAVA, Zochova 5, Tel. (02) 5441 83 15. **SLOVENIA:** 1000 LJUBLJANA, BTC City, Smartinska 140, Tel. (01) 585 19 90. **ROMANIA:** 71289 BUCHAREST, Str. Pictor Ion Negulici nr. 13C, Etaj.2, sector 1, Tel. (01) 231 58 77. **RUSSIAN FEDERATION:** 103031 MOSCOW, Elite Business Systems, Strastnoy Blvd. 16, Tel. (095) 792 32 00.