

AYERS S38

LEUCOS®

INSTRUCTIONS FOR INSTALLATION - LEUCOS USA

AYERS S38 & CELINE S35

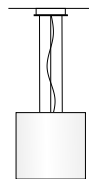

CELINE S35

A1 Enclosed



Two installers



Save instructions

Revised
21 JULY 2008

WARNING:

- DISCONNECT POWER BEFORE INSTALLATION.
- FIXTURE TO BE INSTALLED BY A CERTIFIED ELECTRICIAN.
- INSTALL IN ACCORDANCE WITH THE NATIONAL AND LOCAL ELECTRICAL CODES.
- TAKE GREAT CARE TO AVOID SCRATCHING OR CHIPPING THE GLASS WHEN, CARRYING OUT THE OPERATIONS BELOW

- Fig.1** - Remove cover "C" from the magnets of canopy "A".
- Fig.2** - Install canopy "A" to the box "J" by the four slots provided.
- Fig.4** - Uncoil the pre-installed steel cable and place from top the structure "P" inside the top glass opening, as shown. Meanwhile tighten the cone shaped cup "M", from the below, on the threaded body of the lampholder.
- Fig.2** - Make a fine adjustment of the length as well as a fine balance of the diffuser. Slightly loosen the fitting "S". Sleeve the steel cable of the fitting "S". This fitting is pressured fit. In order to unlock the steel cable push the fitting toward the top. Having determined the correct height of the fixture, secure the steel cable by screwing the fitting "S". Keep steady the diffuser and lock the steel cable by tightening the thumb screw "G" of the structure "P" (Fig.4) and the ex-screw "E" inside the canopy as shown in Fig.2. Fig.3 In order to keep more safe the cable we recommend to cut the excess cable and secure the cap inside the twice screw bushing "F".
- Fig.2** - Connect the fixture's electrical and take care to guide and lock the wire through the plastic bushing "Y".
- Fig.5** - Replace cover "C" on to the magnets of canopy "A".
- Place the recommended bulb into the socket and restore power.

AYERS S38 and CELINE S35 : max 1x100W - type A19 

CIRCUIT DIAGRAM:

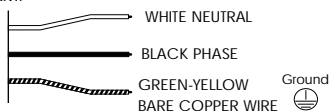

MOUNTS TO STANDARD JUNCTION BOX

For additional information please contact your local dealer or **LEUCOS USA** at: tel. (732) 225-0010 fax (732) 225-0250

Fig.1

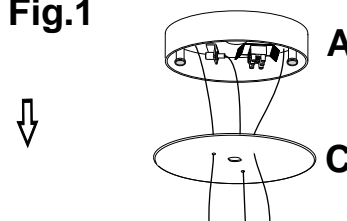

Fig.2

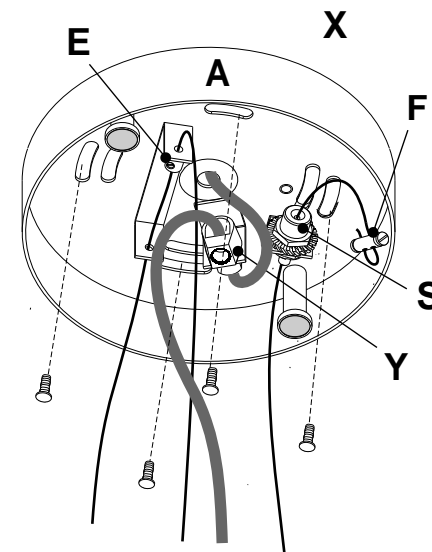

Fig.3

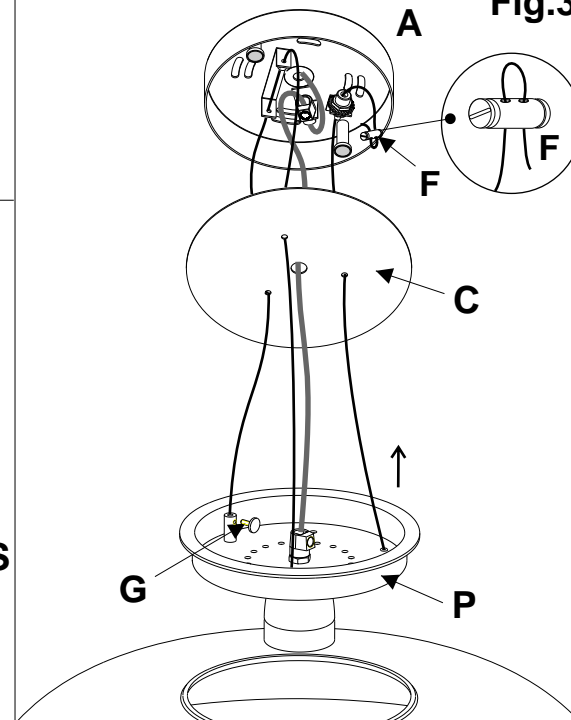

Fig. 4

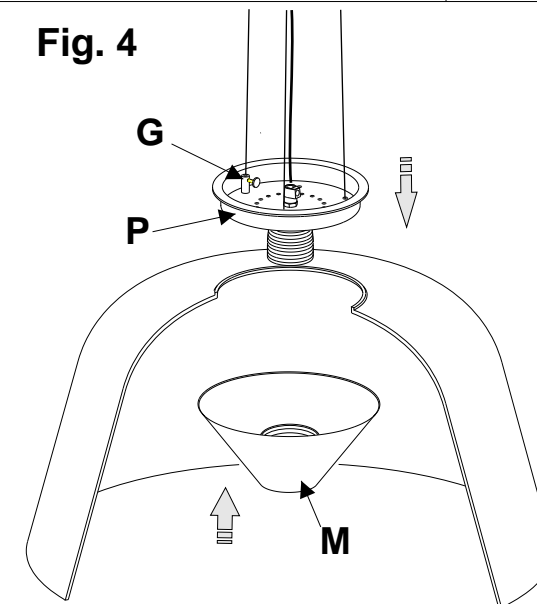

Fig. 5

