

A S H T O N
C A S E G O O D S
C O N F E R E N C E
L I S T P R I C E S E F F E C T I V E
M A R C H 1 , 2 0 0 8

A S H T O N



2 0 0 8

HBF 2008 Price List Contents

Effective Date: March 1, 2008

Mailing Address:
HBF/HBF Textiles
PO Box 8
Hickory, NC 28603-0008

Shipping Address:
HBF/HBF Textiles
900-12th Street Drive NW
Hickory, NC 28601-4763

Phone: 828.328.2064
Fax: 828.485.2690
info: info@hbf.com
www.hbf.com
www.hbftextiles.com

CONTENTS

	PAGE		PAGE
CASEGOOD SPECIFICATIONS		CONFERENCE PRODUCTS	
Access Panels, Removable	.3	Conference Table Specifications - Metal Bases	
Coping Detail	.3	Base Options	.97
Base Details	.3	Edge Detail	.97
Edge Details	.2	Electrical Access Grommets	.98
Doors	.3	Power/Data Plates	.98
Drawers	.3	Veneer	.97
Finishes	.2	Worksurfaces	.97
Grommets	.4	Conference Tables - Metal Bases	.99
Hardware	.3	Conference Table Specifications - Wood Bases	
Levelers	.3	Base Options	.92
Locks	.4	Base Placement	.93
Modesty Panels	.3	Edge Detail	.92
Pedestals	.3	Electrical Access Grommets	.92
Suspension	.3	Power/Data Plates	.92
Veneer	.2	Veneer	.92
Worksurfaces	.2	Worksurfaces	.92
CASEGOODS		Conference Tables - Wood Bases	.94
Bookcases, Double High	.85	Conference Cabinetry	
Bookcases, Single High	.84	Audio/Visual Cart, Mobile	.107
Bridges	.35	Audio/Visual Vertical Storage Cabinet	.107
Casegood Accessories		Lectern	.109
Pedestal Shelves	.91	Plasma Screen Enclosure	.108
Pedestal Dividers	.91	Wall Mounted Presentation Cabinet	.107
Stack Shelves	.91		
Worksurface Shelves	.91		
Corner Units	.36		
Credenzas	.20		
Credenza Storage Towers	.42		
Desk Extensions	.37		
Desks	.5		
File Pedestal, Mobile	.41		
Reception Desks	.87		
Lateral Files	.86		
Overhead Cabinets, Double High	.48		
Overhead Cabinets, Single High	.44		
Returns	.30		
Table Desks	.19		
Vertical Storage, Double High	.80		
Vertical Storage, Single High	.76		
Wardrobe Unit	.77		

HBF Ashton Casegood Specifications

All HBF casegood orders must be accompanied by suite layout drawings.
 Drawings are needed to confirm proper unit configuration.
 If drawings are not included, orders may be delayed to confirm specifications.

Profile Edge Details

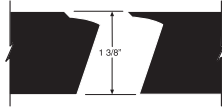

Worksurfaces

Ashton has a 1 3/8" (35mm) thick worksurface and premium grade veneer top faces, edges are bordered with veneer solids or edgebands.

Veneer

The following slip matched, plain sliced veneers are available with the finish options as shown below. Pricing for these veneers are shown by veneer grade.

Anigre: Color and grain variations are typical characteristics of anigre veneer. Color may range from light yellow to pale brown, sometimes with a pink tint. The grain pattern of anigre will also vary in frequency and size; grain pattern changes should be expected within a given product or suite of furniture.

Veneer Grade 1

Cherry
 Maple
 Ligno-Grain
 Walnut

Veneer Grade 2

Rift Oak
 Sapele

Veneer Grade 3

Anigre

Finish Availability Chart

		Cherry	Veneer Grade 1		Veneer Grade 2		Veneer Grade 3	
			Maple	Ligno-Grain	Walnut	Rift Oak	Sapele	Anigre
01	Centennial	•		•				
02	Espresso	•		•				
03	Imperial	•		•				
05	Tuscan	•		•				
06	Amber	•		•			•	
07	Chestnut	•		•				
09	Onyx	•		•				
10	Honey	•		•				
11	Amazon	•		•				
12	Wheat		•	•				
16	Caramel		•	•		•		
17	Scone						•	
18	Biscotti		M*					
19	Butterscotch							•
20	Hazelnut		M*					
21	Chai							•
22	Cider		M*					
23	Mocha					•		
24	Chocolat		M*					
25	Cocoa				•			
26	Latte		M*					
27	Honeycomb				•			
28	Nectar		M*					
29	Nutmeg				•			
30	Toffee		M*					

M* (maple): These finishes are available only on maple seating and occasional table products and allow the specifier to create a finish that is complementary to non-maple veneers available on conference and casegood products. HBF's maple seating and occasional table products can therefore be specified with HBF conference and casegoods constructed with the available non-maple veneers and create an office environment with complementary wood tones. These finishes are not available on conference or casegood products.

18 Biscotti on maple complements 17 Scone on sapele
 20 Hazelnut on maple complements 19 Butterscotch on anigre
 22 Cider on maple complements 21 Chai on anigre
 24 Chocolat on maple complements 23 Mocha on rift oak
 26 Latte on maple complements 25 Cocoa on walnut
 28 Nectar on maple complements 27 Honeycomb on walnut
 30 Toffee on maple complements 29 Nutmeg on walnut

All conference and casegood products are standard with a 30° sheen.

An upcharge of **10% Net** per unit for conference and casegood products, with a minimum upcharge of **\$375 Net** per order will apply for any custom wood finish.

HBF Ashton Casegood Specifications

Pedestals	Three depths (24", 30" and 36")
Doors	Three (3) ply veneer mounted with universal adjustment concealed hinges.
Levelers	All floor casegoods have adjustable levelers.
Modesty Panels	Desk modesty panels are available as finished, fixed panels either recessed 4" or flushed. Credenza, return and bridge modesty panels are available as finished, fixed panels or as recessed, unfinished back removable access panels.
Drawers	<p>Box and file drawers are 1/2" wood, doweled to form a four (4) sided rectangle with separate drawer front.</p> <p>Drawer bottoms are 1/4" thick and fitted in a dado groove so it is captured on four sides.</p> <p>Drawer faces are mechanically attached to allow for easy alignment.</p> <p>Each desk equipped with a box/box/file pedestal will include one maple divider and one maple pencil tray.</p> <p>Center drawers are optional and include a cherry or maple pencil and paper clip tray, see HBF Casegood Accessories.</p> <p>Center drawers are standard on all Mercer, Ashton and Fairmont table desks.</p>
Suspension	<p>All box drawers are standard with telescopic, full extension, ball-bearing slides.</p> <p>All file drawers are standard with fully progressive, full extension, ball-bearing slides.</p>
Base Details	Ashton casegoods incorporate a scored base detail on the user and guest sides of the pedestals.

Coping Detail Ashton returns, bridges and desk extensions are reverse-coped to allow for flush mounting with any Ashton desk, credenza or return.



Single pedestal desk, credenza or return without pedestal

Removable Access Panels Ashton credenzas or returns without a finished back can be specified with removable access panels in the kneespace. This panel can be easily removed to allow for complete wall access. When installed, the top of the access panel will be 3 1/4" from the underside of the worksurface to allow for wire or cable egress. The back of this panel and the back of pedestals are unfinished.

Ashton credenzas or returns specified with a finished back will be constructed with a fully finished, fixed modesty panel.

Pull Hardware Options Ashton products are standard with the Madison pull in a satin nickel finish. These products may also be specified with any of the pulls from HBF's Courant, Fairmont, Legacy or Mercer product lines. **Each order must specify pull and finish before order entry can proceed.**

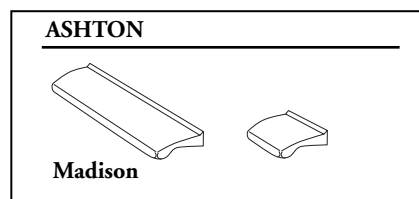

HBF Ashton Casegood Specifications

Locks

All pedestals are standard with face locks. All credenza storage towers, vertical storage cabinets, overhead cabinets and bookcases with doors are available with optional face locks. **Add \$95 List** per lock for factory installation. (Locks standard on vertical cabinet file drawers)

Each individual unit (i.e. desk, credenza, overhead storage unit, etc.) will be keyed alike. Lock finish will match pull finish unless specified otherwise. If complete offices are required to be keyed alike, this designation must appear on each order. Units will be shipped with the lock barrels and locking mechanisms in place. A separate package will contain the appropriately numbered cylinders for field installations. If no specific lock instructions accompany the order, random keying between complete units will be installed.

Grommets

Grommets are optional on all Ashton desks, credenzas, returns, bridges, table desks, corner units and desk extensions. **Add \$95 List** for each factory installed grommet. Field installed circular grommets are available, **add \$40 List**. Finishes available are satin nickel, matte black powder coat and polished brass and will match specified finish for the pull hardware, unless otherwise noted. The 2" circular grommet is used on all desks and desk extensions. The 3" circular grommet is used on all credenzas, returns, bridges, and corner units.

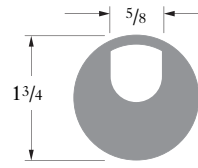
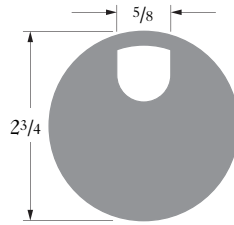

For added convenience, the drawings below should be used to define the placement of each optional grommet location. Please attach a copy to the order.

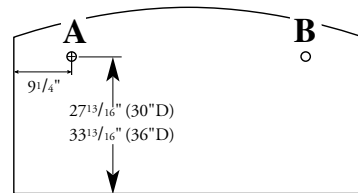

Desk- Bow Front Top

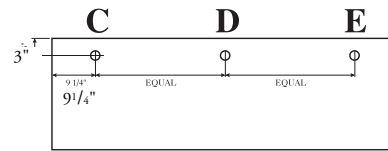

Credenza, Return, Bridge

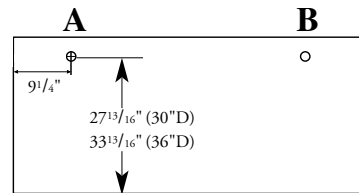

Desk - Rectangular Top

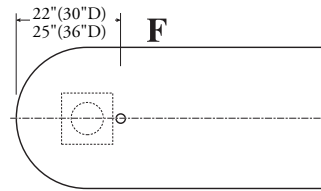

All Desk Extensions

If standard grommet placement locations do not provide suitable accessibility, a formal drawing of specified grommet location showing exact dimensions must accompany the order. No order specifying non-standard grommet placement will be entered until these drawings are received and approved by HBF.

Mobile Audio/Visual Cart Electrical Access

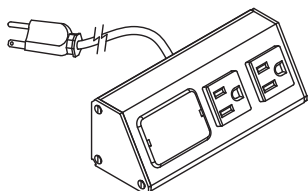
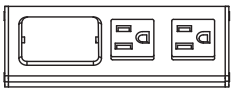

Ashton mobile audio/visual cart may be specified with a power/data unit that can be mounted to any surface on the cart. The unit is standard in a black finish and will be supplied for the end user to mount as needed to meet their specific requirements. Specify **AC96NB**, **add \$295 List**.

This power/data unit provides two 110 volt electrical outlets and two data jacks. The unit uses a soft cord with grounded plug.

The electrical components provided within this group of furniture are engineered and manufactured in compliance with NEC regulation, **however it is the responsibility of the specifier and contracted installer of the furniture to be aware of the local building and electrical restrictions**. Electrical components meet both Chicago and New York electrical codes.

HBF Ashton Casegoods - Desks

Style Number	List Price			Dimensions			Weight
	Veneer 1	Veneer 2	Veneer 3	OW	OD	OH	

Rectangular Double Pedestal Desk - Recessed Modesty Panel

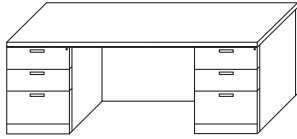

AS01A-AHA	4568	4933	5482	66	30	29	442
AS01C-AHA	4650	5022	5581	66	36	29	461
AS01D-AHA	4650	5022	5581	72	30	29	447
AS01F-AHA	4733	5111	5679	72	36	29	476
AS01G-AHA	5073	5479	6087	78	36	29	499

Veneer species must be noted on each line item

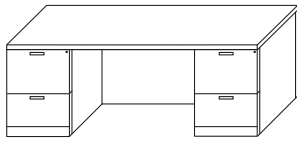

AS01A-BHB	4568	4933	5482	66	30	29	442
AS01C-BHB	4650	5022	5581	66	36	29	461
AS01D-BHB	4650	5022	5581	72	30	29	447
AS01F-BHB	4733	5111	5679	72	36	29	476
AS01G-BHB	5073	5479	6087	78	36	29	499

Veneer species must be noted on each line item

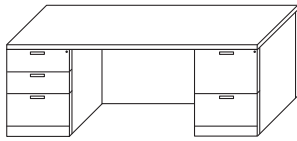

AS01A-AHB	4568	4933	5482	66	30	29	442
AS01C-AHB	4650	5022	5581	66	36	29	461
AS01D-AHB	4650	5022	5581	72	30	29	447
AS01F-AHB	4733	5111	5679	72	36	29	476
AS01G-AHB	5073	5479	6087	78	36	29	499

Veneer species must be noted on each line item

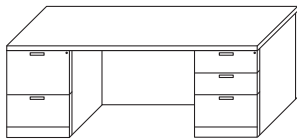

AS01A-BHA	4568	4933	5482	66	30	29	442
AS01C-BHA	4650	5022	5581	66	36	29	461
AS01D-BHA	4650	5022	5581	72	30	29	447
AS01F-BHA	4733	5111	5679	72	36	29	476
AS01G-BHA	5073	5479	6087	78	36	29	499

Veneer species must be noted on each line item

Rectangular Double Pedestal Desk - Flush Modesty Panel

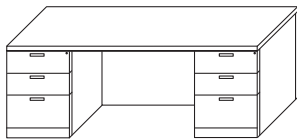

AS02A-AHA	4486	4845	5383	66	30	29	442
AS02C-AHA	4568	4933	5482	66	36	29	461
AS02D-AHA	4568	4933	5482	72	30	29	447
AS02F-AHA	4650	5022	5581	72	36	29	476
AS02G-AHA	4990	5390	5988	78	36	29	499

Veneer species must be noted on each line item

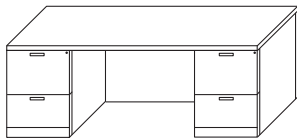

AS02A-BHB	4486	4845	5383	66	30	29	442
AS02C-BHB	4568	4933	5482	66	36	29	461
AS02D-BHB	4568	4933	5482	72	30	29	447
AS02F-BHB	4650	5022	5581	72	36	29	476
AS02G-BHB	4990	5390	5988	78	36	29	499

Veneer species must be noted on each line item

Veneer species must be noted on each line item

Veneer Grade 1	Veneer Grade 2	Veneer Grade 3
Cherry	Rift Oak	Anigre
Maple	Sapele	
Ligno-Grain		
Walnut		

HBF Ashton Casegoods - Desks

	Style Number	List Price			Dimensions			Weight
		Veneer 1	Veneer 2	Veneer 3	OW	OD	OH	

Rectangular Double Pedestal Desk - Flush Modesty Panel

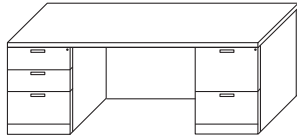

AS02A-AHB	4486	4845	5383	66	30	29	442
AS02C-AHB	4568	4933	5482	66	36	29	461
AS02D-AHB	4568	4933	5482	72	30	29	447
AS02F-AHB	4650	5022	5581	72	36	29	476
AS02G-AHB	4990	5390	5988	78	36	29	499

Veneer species must be noted on each line item

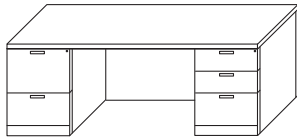

AS02A-BHA	4486	4845	5383	66	30	29	442
AS02C-BHA	4568	4933	5482	66	36	29	461
AS02D-BHA	4568	4933	5482	72	30	29	447
AS02F-BHA	4650	5022	5581	72	36	29	476
AS02G-BHA	4990	5390	5988	78	36	29	499

Veneer species must be noted on each line item

Rectangular Double Pedestal Desk - Recessed Modesty Panel, Front Overhang

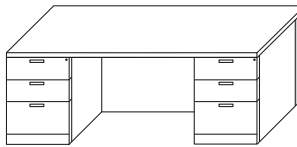

AS05C-AHA	4589	4956	5506	66	36	29	442
AS05H-AHA	4671	5045	5605	66	42	29	461
AS05F-AHA	4692	5067	5630	72	36	29	447
AS05J-AHA	4753	5134	5704	72	42	29	476
AS05K-AHA	5021	5423	6026	78	42	29	499

Veneer species must be noted on each line item

6" overhang visitor side

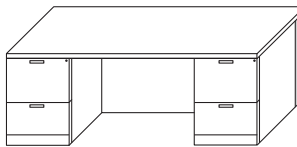

AS05C-BHB	4589	4956	5506	66	36	29	442
AS05H-BHB	4671	5045	5605	66	42	29	461
AS05F-BHB	4692	5067	5630	72	36	29	447
AS05J-BHB	4753	5134	5704	72	42	29	476
AS05K-BHB	5021	5423	6026	78	42	29	499

Veneer species must be noted on each line item

6" overhang visitor side

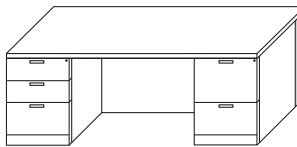

AS05C-AHB	4589	4956	5506	66	36	29	442
AS05H-AHB	4671	5045	5605	66	42	29	461
AS05F-AHB	4692	5067	5630	72	36	29	447
AS05J-AHB	4753	5134	5704	72	42	29	476
AS05K-AHB	5021	5423	6026	78	42	29	499

Veneer species must be noted on each line item

6" overhang visitor side

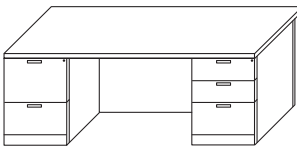

AS05C-BHA	4589	4956	5506	66	36	29	442
AS05H-BHA	4671	5045	5605	66	42	29	461
AS05F-BHA	4692	5067	5630	72	36	29	447
AS05J-BHA	4753	5134	5704	72	42	29	476
AS05K-BHA	5021	5423	6026	78	42	29	499

Veneer species must be noted on each line item

6" overhang visitor side

Veneer species must be noted on each line item

Veneer Grade 1	Veneer Grade 2	Veneer Grade 3
Cherry	Rift Oak	Anigre
Maple	Sapele	
Ligno-Grain		
Walnut		

HBF Ashton Casegoods - Desks

Style Number	List Price			Dimensions			Weight
	Veneer 1	Veneer 2	Veneer 3	OW	OD	OH	

Rectangular Double Pedestal Desk - Flush Modesty Panel, Front Overhang

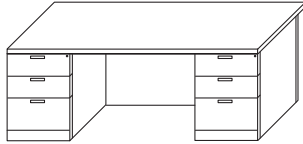

AS06C-AHA	4506	4867	5408	66	36	29	442
AS06H-AHA	4589	4956	5506	66	42	29	461
AS06F-AHA	4609	4978	5531	72	36	29	447
AS06J-AHA	4671	5045	5605	72	42	29	476
AS06K-AHA	4939	5334	5927	78	42	29	499

Veneer species must be noted on each line item

6" overhang visitor side

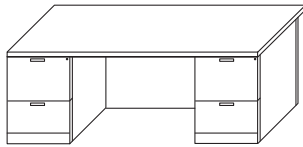

AS06C-BHB	4506	4867	5408	66	36	29	442
AS06H-BHB	4589	4956	5506	66	42	29	461
AS06F-BHB	4609	4978	5531	72	36	29	447
AS06J-BHB	4671	5045	5605	72	42	29	476
AS06K-BHB	4939	5334	5927	78	42	29	499

Veneer species must be noted on each line item

6" overhang visitor side

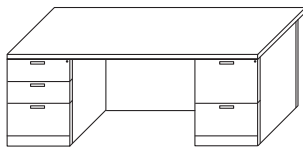

AS06C-AHB	4506	4867	5408	66	36	29	442
AS06H-AHB	4589	4956	5506	66	42	29	461
AS06F-AHB	4609	4978	5531	72	36	29	447
AS06J-AHB	4671	5045	5605	72	42	29	476
AS06K-AHB	4939	5334	5927	78	42	29	499

Veneer species must be noted on each line item

6" overhang visitor side

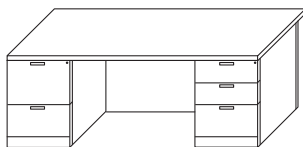

AS06C-BHA	4506	4867	5408	66	36	29	442
AS06H-BHA	4589	4956	5506	66	42	29	461
AS06F-BHA	4609	4978	5531	72	36	29	447
AS06J-BHA	4671	5045	5605	72	42	29	476
AS06K-BHA	4939	5334	5927	78	42	29	499

Veneer species must be noted on each line item

6" overhang visitor side

Bow Front Double Pedestal Desk - Recessed Modesty Panel

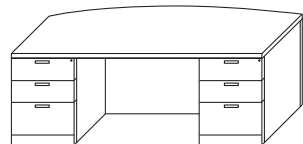

AS03A-AHA	5753	6213	6903	66	30/36	29	464
AS03C-AHA	5845	6313	7014	66	36/42	29	484
AS03D-AHA	5845	6313	7014	72	30/36	29	487
AS03F-AHA	5938	6413	7126	72	36/42	29	508
AS03G-AHA	6309	6813	7571	78	36/42	29	532

Veneer species must be noted on each line item

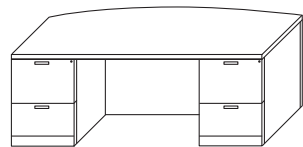

AS03A-BHB	5753	6213	6903	66	30/36	29	464
AS03C-BHB	5845	6313	7014	66	36/42	29	484
AS03D-BHB	5845	6313	7014	72	30/36	29	487
AS03F-BHB	5938	6413	7126	72	36/42	29	508
AS03G-BHB	6309	6813	7571	78	36/42	29	532

Veneer species must be noted on each line item

Veneer species must be noted on each line item

Veneer Grade 1	Veneer Grade 2	Veneer Grade 3
Cherry	Rift Oak	Anigre
Maple	Sapele	
Ligno-Grain		
Walnut		

HBF Ashton Casegoods - Desks

Style Number	List Price			Dimensions			Weight
	Veneer 1	Veneer 2	Veneer 3	OW	OD	OH	

Bow Front Double Pedestal Desk - Recessed Modesty Panel

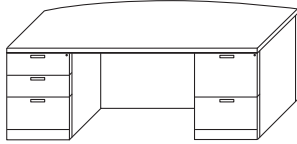

AS03A-AHB	5753	6213	6903	66	30/36	29	464
AS03C-AHB	5845	6313	7014	66	36/42	29	484
AS03D-AHB	5845	6313	7014	72	30/36	29	487
AS03F-AHB	5938	6413	7126	72	36/42	29	508
AS03G-AHB	6309	6813	7571	78	36/42	29	532

Veneer species must be noted on each line item

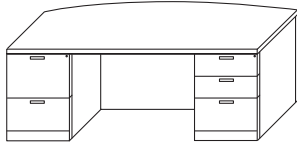

AS03A-BHA	5753	6213	6903	66	30/36	29	464
AS03C-BHA	5845	6313	7014	66	36/42	29	484
AS03D-BHA	5845	6313	7014	72	30/36	29	487
AS03F-BHA	5938	6413	7126	72	36/42	29	508
AS03G-BHA	6309	6813	7571	78	36/42	29	532

Veneer species must be noted on each line item

Bow Front Double Pedestal Desk - Flush Modesty Panel

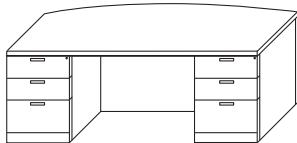

AS04A-AHA	5670	6124	6804	66	30/36	29	464
AS04C-AHA	5763	6224	6915	66	36/42	29	484
AS04D-AHA	5763	6224	6915	72	30/36	29	487
AS04F-AHA	5856	6324	7027	72	36/42	29	508
AS04G-AHA	6226	6724	7472	78	36/42	29	532

Veneer species must be noted on each line item

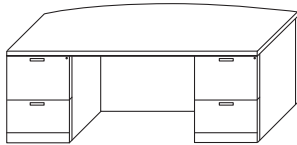

AS04A-BHB	5670	6124	6804	66	30/36	29	464
AS04C-BHB	5763	6224	6915	66	36/42	29	484
AS04D-BHB	5763	6224	6915	72	30/36	29	487
AS04F-BHB	5856	6324	7027	72	36/42	29	508
AS04G-BHB	6226	6724	7472	78	36/42	29	532

Veneer species must be noted on each line item

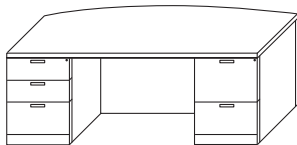

AS04A-AHB	5670	6124	6804	66	30/36	29	464
AS04C-AHB	5763	6224	6915	66	36/42	29	484
AS04D-AHB	5763	6224	6915	72	30/36	29	487
AS04F-AHB	5856	6324	7027	72	36/42	29	508
AS04G-AHB	6226	6724	7472	78	36/42	29	532

Veneer species must be noted on each line item

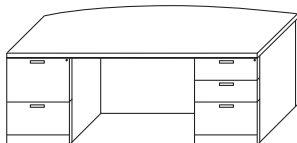

AS04A-BHA	5670	6124	6804	66	30/36	29	464
AS04C-BHA	5763	6224	6915	66	36/42	29	484
AS04D-BHA	5763	6224	6915	72	30/36	29	487
AS04F-BHA	5856	6324	7027	72	36/42	29	508
AS04G-BHA	6226	6724	7472	78	36/42	29	532

Veneer species must be noted on each line item

Veneer species must be noted on each line item

<u>Veneer Grade 1</u>	<u>Veneer Grade 2</u>	<u>Veneer Grade 3</u>
Cherry	Rift Oak	Anigre
Maple	Sapele	
Ligno-Grain		
Walnut		

HBF Ashton Casegoods - Desks

Style Number	List Price			Dimensions			Weight
	Veneer 1	Veneer 2	Veneer 3	OW	OD	OH	

Rectangular Single Pedestal Desk - Recessed Modesty Panel

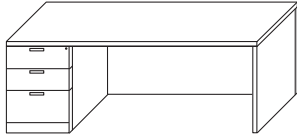

AS10A-AHK	3826	4133	4592	66	30	29	419
AS10C-AHK	3899	4210	4678	66	36	29	439
AS10D-AHK	3899	4210	4678	72	30	29	425
AS10F-AHK	3981	4299	4777	72	36	29	455
AS10G-AHK	4321	4667	5185	78	36	29	479

Veneer species must be noted on each line item

Flush, finished end panels, used with finished back returns and bridges.

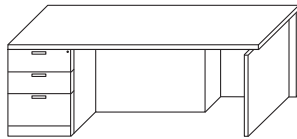

AS10A-AHL	3723	4021	4468	66	30	29	419
AS10C-AHL	3796	4099	4555	66	36	29	439
AS10D-AHL	3796	4099	4555	72	30	29	425
AS10F-AHL	3878	4188	4654	72	36	29	455
AS10G-AHL	4218	4555	5061	78	36	29	479

Veneer species must be noted on each line item

Recessed end panels, used with returns and bridges with removable backs. Standard black outside finish to allow placement against wall.

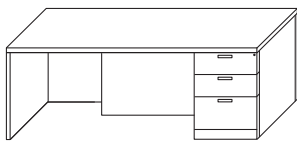

AS10A-KHA	3826	4133	4592	66	30	29	419
AS10C-KHA	3899	4210	4678	66	36	29	439
AS10D-KHA	3899	4210	4678	72	30	29	425
AS10F-KHA	3981	4299	4777	72	36	29	455
AS10G-KHA	4321	4667	5185	78	36	29	479

Veneer species must be noted on each line item

Flush, finished end panels, used with finished back returns and bridges.

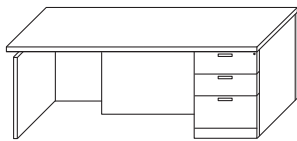

AS10A-LHA	3723	4021	4468	66	30	29	419
AS10C-LHA	3796	4099	4555	66	36	29	439
AS10D-LHA	3796	4099	4555	72	30	29	425
AS10F-LHA	3878	4188	4654	72	36	29	455
AS10G-LHA	4218	4555	5061	78	36	29	479

Veneer species must be noted on each line item

Recessed end panels, used with returns and bridges with removable backs. Standard black outside finish to allow placement against wall.

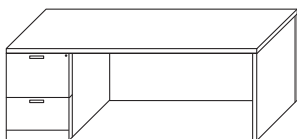

AS10A-BHK	3826	4133	4592	66	30	29	419
AS10C-BHK	3899	4210	4678	66	36	29	439
AS10D-BHK	3899	4210	4678	72	30	29	425
AS10F-BHK	3981	4299	4777	72	36	29	455
AS10G-BHK	4321	4667	5185	78	36	29	479

Veneer species must be noted on each line item

Flush, finished end panels, used with finished back returns and bridges.

Veneer species must be noted on each line item

Veneer Grade 1	Veneer Grade 2	Veneer Grade 3
Cherry	Rift Oak	Anigre
Maple	Sapele	
Ligno-Grain		
Walnut		

HBF Ashton Casegoods - Desks

Style Number	List Price			Dimensions			Weight
	Veneer 1	Veneer 2	Veneer 3	OW	OD	OH	

Rectangular Single Pedestal Desk - Recessed Modesty Panel

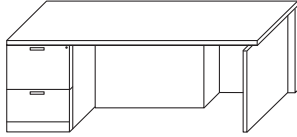

AS10A-BHL	3723	4021	4468	66	30	29	419
AS10C-BHL	3796	4099	4555	66	36	29	439
AS10D-BHL	3796	4099	4555	72	30	29	425
AS10F-BHL	3878	4188	4654	72	36	29	455
AS10G-BHL	4218	4555	5061	78	36	29	479

Veneer species must be noted on each line item

Recessed end panels, used with returns and bridges with removable backs. Standard black outside finish to allow placement against wall.

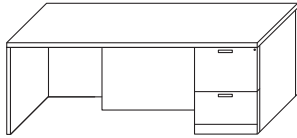

AS10A-KHB	3826	4133	4592	66	30	29	419
AS10C-KHB	3899	4210	4678	66	36	29	439
AS10D-KHB	3899	4210	4678	72	30	29	425
AS10F-KHB	3981	4299	4777	72	36	29	455
AS10G-KHB	4321	4667	5185	78	36	29	479

Veneer species must be noted on each line item

Flush, finished end panels, used with finished back returns and bridges.

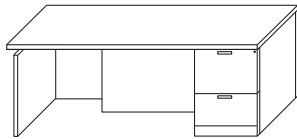

AS10A-LHB	3723	4021	4468	66	30	29	419
AS10C-LHB	3796	4099	4555	66	36	29	439
AS10D-LHB	3796	4099	4555	72	30	29	425
AS10F-LHB	3878	4188	4654	72	36	29	455
AS10G-LHB	4218	4555	5061	78	36	29	479

Veneer species must be noted on each line item

Recessed end panels, used with returns and bridges with removable backs. Standard black outside finish to allow placement against wall.

Rectangular Single Pedestal Desk - Flush Modesty Panel

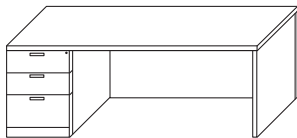

AS11A-AHK	3744	4044	4493	66	30	29	419
AS11C-AHK	3816	4121	4579	66	36	29	439
AS11D-AHK	3816	4121	4579	72	30	29	425
AS11F-AHK	3899	4210	4678	72	36	29	455
AS11G-AHK	4238	4578	5086	78	36	29	479

Veneer species must be noted on each line item

Flush, finished end panels, used with finished back returns and bridges.

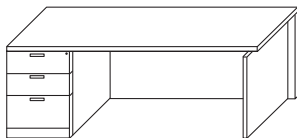

AS11A-AHL	3641	3932	4369	66	30	29	419
AS11C-AHL	3713	4010	4456	66	36	29	439
AS11D-AHL	3713	4010	4456	72	30	29	425
AS11F-AHL	3796	4099	4555	72	36	29	455
AS11G-AHL	4135	4466	4963	78	36	29	479

Veneer species must be noted on each line item

Recessed end panels, used with returns and bridges with removable backs. Standard black outside finish to allow placement against wall.

Veneer species must be noted on each line item

Veneer Grade 1	Veneer Grade 2	Veneer Grade 3
Cherry	Rift Oak	Anigre
Maple	Sapele	
Ligno-Grain		
Walnut		

HBF Ashton Casegoods - Desks

Style Number	List Price			Dimensions			Weight
	Veneer 1	Veneer 2	Veneer 3	OW	OD	OH	

Rectangular Single Pedestal Desk - Flush Modesty Panel

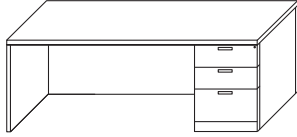

AS11A-KHA	3744	4044	4493	66	30	29	419
AS11C-KHA	3816	4121	4579	66	36	29	439
AS11D-KHA	3816	4121	4579	72	30	29	425
AS11F-KHA	3899	4210	4678	72	36	29	455
AS11G-KHA	4238	4578	5086	78	36	29	479

Veneer species must be noted on each line item

Flush, finished end panels, used with finished back returns and bridges.

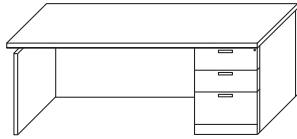

AS11A-LHA	3641	3932	4369	66	30	29	419
AS11C-LHA	3713	4010	4456	66	36	29	439
AS11D-LHA	3713	4010	4456	72	30	29	425
AS11F-LHA	3796	4099	4555	72	36	29	455
AS11G-LHA	4135	4466	4963	78	36	29	479

Veneer species must be noted on each line item

Recessed end panels, used with returns and bridges with removable backs. Standard black outside finish to allow placement against wall.

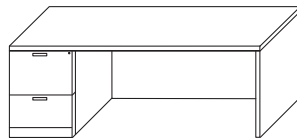

AS11A-BHK	3744	4044	4493	66	30	29	419
AS11C-BHK	3816	4121	4579	66	36	29	439
AS11D-BHK	3816	4121	4579	72	30	29	425
AS11F-BHK	3899	4210	4678	72	36	29	455
AS11G-BHK	4238	4578	5086	78	36	29	479

Veneer species must be noted on each line item

Flush, finished end panels, used with finished back returns and bridges.

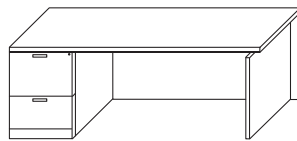

AS11A-BHL	3641	3932	4369	66	30	29	419
AS11C-BHL	3713	4010	4456	66	36	29	439
AS11D-BHL	3713	4010	4456	72	30	29	425
AS11F-BHL	3796	4099	4555	72	36	29	455
AS11G-BHL	4135	4466	4963	78	36	29	479

Veneer species must be noted on each line item

Recessed end panels, used with returns and bridges with removable backs. Standard black outside finish to allow placement against wall.

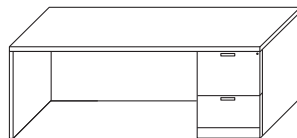

AS11A-KHB	3744	4044	4493	66	30	29	419
AS11C-KHB	3816	4121	4579	66	36	29	439
AS11D-KHB	3816	4121	4579	72	30	29	425
AS11F-KHB	3899	4210	4678	72	36	29	455
AS11G-KHB	4238	4578	5086	78	36	29	479

Veneer species must be noted on each line item

Flush, finished end panels, used with finished back returns and bridges.

Veneer species must be noted on each line item

Veneer Grade 1	Veneer Grade 2	Veneer Grade 3
Cherry	Rift Oak	Anigre
Maple	Sapele	
Ligno-Grain		
Walnut		

HBF Ashton Casegoods - Desks

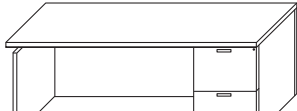
	Style Number	List Price			Dimensions			Weight
		Veneer 1	Veneer 2	Veneer 3	OW	OD	OH	
Rectangular Single Pedestal Desk - Flush Modesty Panel								
	AS11A-LHB	3641	3932	4369	66	30	29	419
	AS11C-LHB	3713	4010	4456	66	36	29	439
	AS11D-LHB	3713	4010	4456	72	30	29	425
	AS11F-LHB	3796	4099	4555	72	36	29	455
	AS11G-LHB	4135	4466	4963	78	36	29	479

Veneer species must be noted on each line item

Recessed end panels, used with returns and bridges with removable backs. Standard black outside finish to allow placement against wall.

Rectangular Single Pedestal Desk - Recessed Modesty Panel, Front Overhang

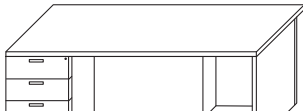
	AS08C-AHK	3847	4155	4616	66	36	29	419
	AS08H-AHK	3919	4233	4703	66	42	29	439
	AS08F-AHK	3919	4233	4703	72	36	29	425
	AS08J-AHK	4002	4322	4802	72	42	29	455
	AS08K-AHK	4341	4689	5210	78	42	29	479

Veneer species must be noted on each line item

Flush, finished end panels, used with finished back returns and bridges. 6" overhang visitor side.

	AS08C-AHL	3744	4044	4493	66	36	29	419
	AS08H-AHL	3816	4121	4579	66	42	29	439
	AS08F-AHL	3816	4121	4579	72	36	29	425
	AS08J-AHL	3899	4210	4678	72	42	29	455
	AS08K-AHL	4238	4578	5086	78	42	29	479

Veneer species must be noted on each line item

Recessed end panels, used with returns and bridges with removable backs. Standard black outside finish to allow placement against wall. 6" overhang visitor side.

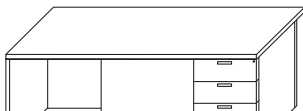
	AS08C-KHA	3847	4155	4616	66	36	29	419
	AS08H-KHA	3919	4233	4703	66	42	29	439
	AS08F-KHA	3919	4233	4703	72	36	29	425
	AS08J-KHA	4002	4322	4802	72	42	29	455
	AS08K-KHA	4341	4689	5210	78	42	29	479

Veneer species must be noted on each line item

Flush, finished end panels, used with finished back returns and bridges. 6" overhang visitor side.

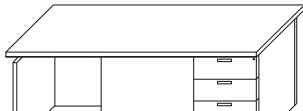
	AS08C-LHA	3744	4044	4493	66	36	29	419
	AS08H-LHA	3816	4121	4579	66	42	29	439
	AS08F-LHA	3816	4121	4579	72	36	29	425
	AS08J-LHA	3899	4210	4678	72	42	29	455
	AS08K-LHA	4238	4578	5086	78	42	29	479

Veneer species must be noted on each line item

Recessed end panels, used with returns and bridges with removable backs. Standard black outside finish to allow placement against wall. 6" overhang visitor side.

Veneer species must be noted on each line item

Veneer Grade 1	Veneer Grade 2	Veneer Grade 3
Cherry	Rift Oak	Anigre
Maple	Sapele	
Ligno-Grain		
Walnut		

HBF Ashton Casegoods - Desks

Style Number	List Price			Dimensions			Weight
	Veneer 1	Veneer 2	Veneer 3	OW	OD	OH	

Rectangular Single Pedestal Desk - Recessed Modesty Panel, Front Overhang

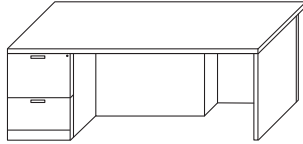

AS08C-BHK	3847	4155	4616	66	36	29	419
AS08H-BHK	3919	4233	4703	66	42	29	439
AS08F-BHK	3919	4233	4703	72	36	29	425
AS08J-BHK	4002	4322	4802	72	42	29	455
AS08K-BHK	4341	4689	5210	78	42	29	479

Veneer species must be noted on each line item

Flush, finished end panels, used with finished back returns and bridges. 6" overhang visitor side.

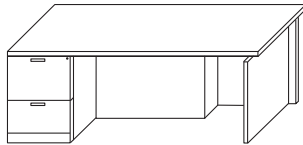

AS08C-BHL	3744	4044	4493	66	36	29	419
AS08H-BHL	3816	4121	4579	66	42	29	439
AS08F-BHL	3816	4121	4579	72	36	29	425
AS08J-BHL	3899	4210	4678	72	42	29	455
AS08K-BHL	4238	4578	5086	78	42	29	479

Veneer species must be noted on each line item

Recessed end panels, used with returns and bridges with removable backs. Standard black outside finish to allow placement against wall. 6" overhang visitor side.

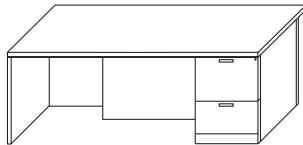

AS08C-KHB	3847	4155	4616	66	36	29	419
AS08H-KHB	3919	4233	4703	66	42	29	439
AS08F-KHB	3919	4233	4703	72	36	29	425
AS08J-KHB	4002	4322	4802	72	42	29	455
AS08K-KHB	4341	4689	5210	78	42	29	479

Veneer species must be noted on each line item

Flush, finished end panels, used with finished back returns and bridges. 6" overhang visitor side.

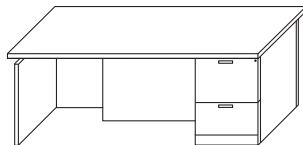

AS08C-LHB	3744	4044	4493	66	36	29	419
AS08H-LHB	3816	4121	4579	66	42	29	439
AS08F-LHB	3816	4121	4579	72	36	29	425
AS08J-LHB	3899	4210	4678	72	42	29	455
AS08K-LHB	4238	4578	5086	78	42	29	479

Veneer species must be noted on each line item

Recessed end panels, used with returns and bridges with removable backs. Standard black outside finish to allow placement against wall. 6" overhang visitor side.

Rectangular Single Pedestal Desk - Flush Modesty Panel, Front Overhang

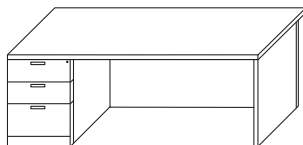

AS09C-AHK	3765	4066	4518	66	36	29	419
AS09H-AHK	3837	4144	4604	66	42	29	439
AS09F-AHK	3837	4144	4604	72	36	29	425
AS09J-AHK	3919	4233	4703	72	42	29	455
AS09K-AHK	4259	4600	5111	78	42	29	479

Veneer species must be noted on each line item

Flush, finished end panels, used with finished back returns and bridges. 6" overhang visitor side.

Veneer species must be noted on each line item

Veneer Grade 1	Veneer Grade 2	Veneer Grade 3
Cherry	Rift Oak	Anigre
Maple	Sapele	
Ligno-Grain		
Walnut		

HBF Ashton Casegoods - Desks

Style Number	List Price			Dimensions			Weight
	Veneer 1	Veneer 2	Veneer 3	OW	OD	OH	

Rectangular Single Pedestal Desk - Flush Modesty Panel, Front Overhang

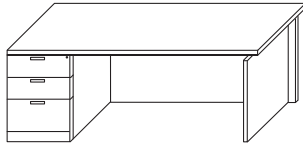

AS09C-AHL	3662	3955	4394	66	36	29	419
AS09H-AHL	3734	4032	4481	66	42	29	439
AS09F-AHL	3734	4032	4481	72	36	29	425
AS09J-AHL	3816	4121	4579	72	42	29	455
AS09K-AHL	4156	4489	4987	78	42	29	479

Veneer species must be noted on each line item

Recessed end panels, used with returns and bridges with removable backs. Standard black outside finish to allow placement against wall. 6" overhang visitor side.

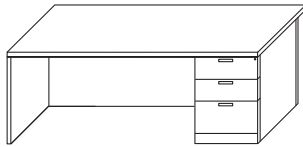

AS09C-KHA	3765	4066	4518	66	36	29	419
AS09H-KHA	3837	4144	4604	66	42	29	439
AS09F-KHA	3837	4144	4604	72	36	29	425
AS09J-KHA	3919	4233	4703	72	42	29	455
AS09K-KHA	4259	4600	5111	78	42	29	479

Veneer species must be noted on each line item

Flush, finished end panels, used with finished back returns and bridges. 6" overhang visitor side.

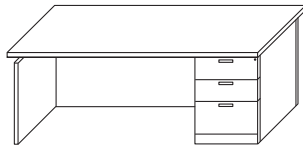

AS09C-LHA	3662	3955	4394	66	36	29	419
AS09H-LHA	3734	4032	4481	66	42	29	439
AS09F-LHA	3734	4032	4481	72	36	29	425
AS09J-LHA	3816	4121	4579	72	42	29	455
AS09K-LHA	4156	4489	4987	78	42	29	479

Veneer species must be noted on each line item

Recessed end panels, used with returns and bridges with removable backs. Standard black outside finish to allow placement against wall. 6" overhang visitor side.

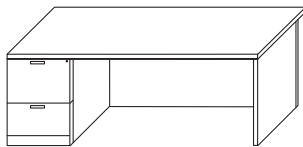

AS09C-BHK	3765	4066	4518	66	36	29	419
AS09H-BHK	3837	4144	4604	66	42	29	439
AS09F-BHK	3837	4144	4604	72	36	29	425
AS09J-BHK	3919	4233	4703	72	42	29	455
AS09K-BHK	4259	4600	5111	78	42	29	479

Veneer species must be noted on each line item

Flush, finished end panels, used with finished back returns and bridges. 6" overhang visitor side.

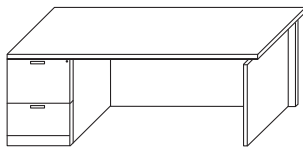

AS09C-BHL	3662	3955	4394	66	36	29	419
AS09H-BHL	3734	4032	4481	66	42	29	439
AS09F-BHL	3734	4032	4481	72	36	29	425
AS09J-BHL	3816	4121	4579	72	42	29	455
AS09K-BHL	4156	4489	4987	78	42	29	479

Veneer species must be noted on each line item

Recessed end panels, used with returns and bridges with removable backs. Standard black outside finish to allow placement against wall. 6" overhang visitor side.

Veneer species must be noted on each line item

<u>Veneer Grade 1</u>	<u>Veneer Grade 2</u>	<u>Veneer Grade 3</u>
Cherry	Rift Oak	Anigre
Maple	Sapele	
Ligno-Grain		
Walnut		

HBF Ashton Casegoods - Desks

Style Number	List Price			Dimensions			Weight
	Veneer 1	Veneer 2	Veneer 3	OW	OD	OH	

Rectangular Single Pedestal Desk - Flush Modesty Panel, Front Overhang

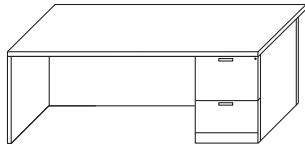

AS09C-KHB	3765	4066	4518	66	36	29	419
AS09H-KHB	3837	4144	4604	66	42	29	439
AS09F-KHB	3837	4144	4604	72	36	29	425
AS09J-KHB	3919	4233	4703	72	42	29	455
AS09K-KHB	4259	4600	5111	78	42	29	479

Veneer species must be noted on each line item

Flush, finished end panels, used with finished back returns and bridges. 6" overhang visitor side.

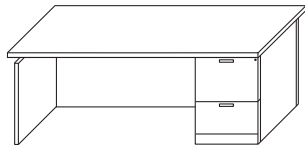

AS09C-LHB	3662	3955	4394	66	36	29	419
AS09H-LHB	3734	4032	4481	66	42	29	439
AS09F-LHB	3734	4032	4481	72	36	29	425
AS09J-LHB	3816	4121	4579	72	42	29	455
AS09K-LHB	4156	4489	4987	78	42	29	479

Veneer species must be noted on each line item

Recessed end panels, used with returns and bridges with removable backs. Standard black outside finish to allow placement against wall. 6" overhang visitor side.

Bow Front Single Pedestal Desk - Recessed Modesty Panel

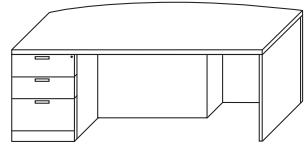

AS12A-AHK	5011	5412	6013	66	30/36	29	443
AS12C-AHK	5083	5490	6100	66	36/42	29	464
AS12D-AHK	5083	5490	6100	72	30/36	29	466
AS12F-AHK	5165	5579	6199	72	36/42	29	488
AS12G-AHK	5505	5946	6606	78	36/42	29	514

Veneer species must be noted on each line item

Flush, finished end panels, used with finished back returns and bridges.

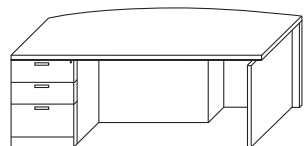

AS12A-AHL	4908	5301	5890	66	30/36	29	443
AS12C-AHL	4980	5378	5976	66	36/42	29	464
AS12D-AHL	4980	5378	5976	72	30/36	29	466
AS12F-AHL	5062	5467	6075	72	36/42	29	488
AS12G-AHL	5402	5835	6483	78	36/42	29	514

Veneer species must be noted on each line item

Recessed end panels, used with returns and bridges with removable backs. Standard black outside finish to allow placement against wall.

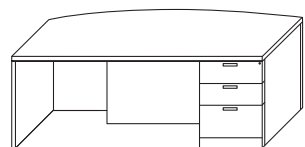

AS12A-KHA	5011	5412	6013	66	30/36	29	443
AS12C-KHA	5083	5490	6100	66	36/42	29	464
AS12D-KHA	5083	5490	6100	72	30/36	29	466
AS12F-KHA	5165	5579	6199	72	36/42	29	488
AS12G-KHA	5505	5946	6606	78	36/42	29	514

Veneer species must be noted on each line item

Flush, finished end panels, used with finished back returns and bridges.

Veneer species must be noted on each line item

Veneer Grade 1	Veneer Grade 2	Veneer Grade 3
Cherry	Rift Oak	Anigre
Maple	Sapele	
Ligno-Grain		
Walnut		

HBF Ashton Casegoods - Desks

Style Number	List Price			Dimensions			Weight
	Veneer 1	Veneer 2	Veneer 3	OW	OD	OH	

Bow Front Single Pedestal Desk - Recessed Modesty Panel

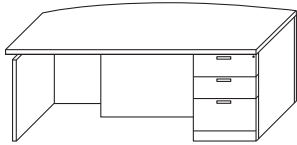

AS12A-LHA	4908	5301	5890	66	30/36	29	443
AS12C-LHA	4980	5378	5976	66	36/42	29	464
AS12D-LHA	4980	5378	5976	72	30/36	29	466
AS12F-LHA	5062	5467	6075	72	36/42	29	488
AS12G-LHA	5402	5835	6483	78	36/42	29	514

Veneer species must be noted on each line item

Recessed end panels, used with returns and bridges with removable backs. Standard black outside finish to allow placement against wall.

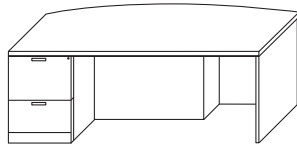

AS12A-BHK	5011	5412	6013	66	30/36	29	443
AS12C-BHK	5083	5490	6100	66	36/42	29	464
AS12D-BHK	5083	5490	6100	72	30/36	29	466
AS12F-BHK	5165	5579	6199	72	36/42	29	488
AS12G-BHK	5505	5946	6606	78	36/42	29	514

Veneer species must be noted on each line item

Flush, finished end panels, used with finished back returns and bridges.

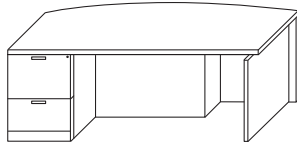

AS12A-BHL	4908	5301	5890	66	30/36	29	443
AS12C-BHL	4980	5378	5976	66	36/42	29	464
AS12D-BHL	4980	5378	5976	72	30/36	29	466
AS12F-BHL	5062	5467	6075	72	36/42	29	488
AS12G-BHL	5402	5835	6483	78	36/42	29	514

Veneer species must be noted on each line item

Recessed end panels, used with returns and bridges with removable backs. Standard black outside finish to allow placement against wall.

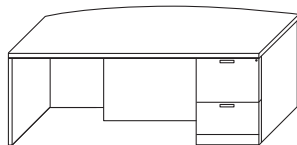

AS12A-KHB	5011	5412	6013	66	30/36	29	443
AS12C-KHB	5083	5490	6100	66	36/42	29	464
AS12D-KHB	5083	5490	6100	72	30/36	29	466
AS12F-KHB	5165	5579	6199	72	36/42	29	488
AS12G-KHB	5505	5946	6606	78	36/42	29	514

Veneer species must be noted on each line item

Flush, finished end panels, used with finished back returns and bridges.

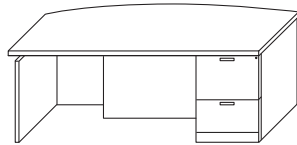

AS12A-LHB	4908	5301	5890	66	30/36	29	443
AS12C-LHB	4980	5378	5976	66	36/42	29	464
AS12D-LHB	4980	5378	5976	72	30/36	29	466
AS12F-LHB	5062	5467	6075	72	36/42	29	488
AS12G-LHB	5402	5835	6483	78	36/42	29	514

Veneer species must be noted on each line item

Recessed end panels, used with returns and bridges with removable backs. Standard black outside finish to allow placement against wall.

Veneer species must be noted on each line item

Veneer Grade 1	Veneer Grade 2	Veneer Grade 3
Cherry	Rift Oak	Anigre
Maple	Sapele	
Ligno-Grain		
Walnut		

HBF Ashton Casegoods - Desks

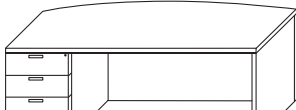
Style Number	List Price			Dimensions			Weight	
	Veneer 1	Veneer 2	Veneer 3	OW	OD	OH		
Bow Front Single Pedestal Desk - Flush Modesty Panel								
	AS13A-AHK	4929	5323	5914	66	30/36	29	443
	AS13C-AHK	5001	5401	6001	66	36/42	29	464
	AS13D-AHK	5001	5401	6001	72	30/36	29	466
	AS13F-AHK	5083	5490	6100	72	36/42	29	488
	AS13G-AHK	5423	5857	6508	78	36/42	29	514

Veneer species must be noted on each line item

Flush, finished end panels, used with finished back returns and bridges.

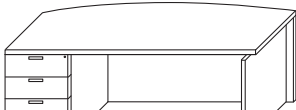
	AS13A-AHL	4826	5212	5791	66	30/36	29	443
	AS13C-AHL	4898	5289	5877	66	36/42	29	464
	AS13D-AHL	4898	5289	5877	72	30/36	29	466
	AS13F-AHL	4980	5378	5976	72	36/42	29	488
	AS13G-AHL	5320	5746	6384	78	36/42	29	514

Veneer species must be noted on each line item

Recessed end panels, used with returns and bridges with removable backs. Standard black outside finish to allow placement against wall.

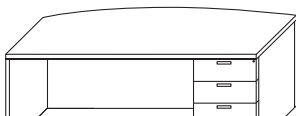
	AS13A-KHA	4929	5323	5914	66	30/36	29	443
	AS13C-KHA	5001	5401	6001	66	36/42	29	464
	AS13D-KHA	5001	5401	6001	72	30/36	29	466
	AS13F-KHA	5083	5490	6100	72	36/42	29	488
	AS13G-KHA	5423	5857	6508	78	36/42	29	514

Veneer species must be noted on each line item

Flush, finished end panels, used with finished back returns and bridges.

	AS13A-LHA	4826	5212	5791	66	30/36	29	443
	AS13C-LHA	4898	5289	5877	66	36/42	29	464
	AS13D-LHA	4898	5289	5877	72	30/36	29	466
	AS13F-LHA	4980	5378	5976	72	36/42	29	488
	AS13G-LHA	5320	5746	6384	78	36/42	29	514

Veneer species must be noted on each line item

Recessed end panels, used with returns and bridges with removable backs. Standard black outside finish to allow placement against wall.

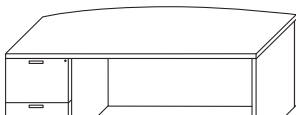
	AS13A-BHK	4929	5323	5914	66	30/36	29	443
	AS13C-BHK	5001	5401	6001	66	36/42	29	464
	AS13D-BHK	5001	5401	6001	72	30/36	29	466
	AS13F-BHK	5083	5490	6100	72	36/42	29	488
	AS13G-BHK	5423	5857	6508	78	36/42	29	514

Veneer species must be noted on each line item

Flush, finished end panels, used with finished back returns and bridges.

Veneer species must be noted on each line item

Veneer Grade 1	Veneer Grade 2	Veneer Grade 3
Cherry	Rift Oak	Anigre
Maple	Sapele	
Ligno-Grain		
Walnut		

HBF Ashton Casegoods - Desks

Style Number	List Price			Dimensions			Weight
	Veneer 1	Veneer 2	Veneer 3	OW	OD	OH	

Bow Front Single Pedestal Desk - Flush Modesty Panel

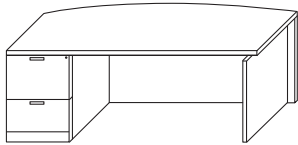

AS13A-BHL	4826	5212	5791	66	30/36	29	443
AS13C-BHL	4898	5289	5877	66	36/42	29	464
AS13D-BHL	4898	5289	5877	72	30/36	29	466
AS13F-BHL	4980	5378	5976	72	36/42	29	488
AS13G-BHL	5320	5746	6384	78	36/42	29	514

Veneer species must be noted on each line item

Recessed end panels, used with returns and bridges with removable backs. Standard black outside finish to allow placement against wall.

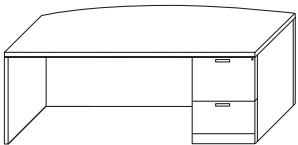

AS13A-KHB	4929	5323	5914	66	30/36	29	443
AS13C-KHB	5001	5401	6001	66	36/42	29	464
AS13D-KHB	5001	5401	6001	72	30/36	29	466
AS13F-KHB	5083	5490	6100	72	36/42	29	488
AS13G-KHB	5423	5857	6508	78	36/42	29	514

Veneer species must be noted on each line item

Flush, finished end panels, used with finished back returns and bridges.

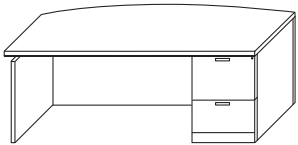

AS13A-LHB	4826	5212	5791	66	30/36	29	443
AS13C-LHB	4898	5289	5877	66	36/42	29	464
AS13D-LHB	4898	5289	5877	72	30/36	29	466
AS13F-LHB	4980	5378	5976	72	36/42	29	488
AS13G-LHB	5320	5746	6384	78	36/42	29	514

Veneer species must be noted on each line item

Recessed end panels, used with returns and bridges with removable backs. Standard black outside finish to allow placement against wall.

Veneer species must be noted on each line item

<u>Veneer Grade 1</u>	<u>Veneer Grade 2</u>	<u>Veneer Grade 3</u>
Cherry	Rift Oak	Anigre
Maple	Sapele	
Ligno-Grain		
Walnut		

HBF Ashton Casegoods - Table Desks

Style Number	List Price			Dimensions			Weight
	Veneer 1	Veneer 2	Veneer 3	OW	OD	OH	

Table Desks

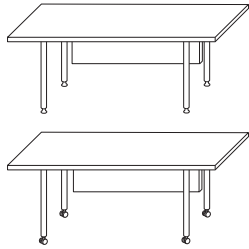

AS07A-T	3476	3754	4172	66	30	29	199
AS07D-T	3507	3788	4209	72	30	29	224
AS07F-T	3579	3866	4295	72	36	29	252

Veneer species must be noted on each line item

Center drawer, modesty panel. Metal legs available in satin nickel or black powder coat finish, please specify on order. Casters available on all table desks, please specify on order. Optional border inlay available on top surface of Fairmont only, add \$650 List.

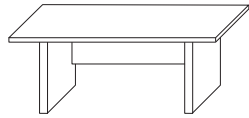

AS07A-M	4094	4422	4913	66	30	29	239
AS07D-M	4125	4455	4950	72	30	29	264
AS07F-M	4197	4533	5037	72	36	29	282

Veneer species must be noted on each line item

Center drawer, modesty panel, panel base. Optional border inlay available on top surface of Fairmont only, add \$650 List.

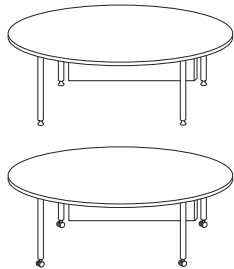

AS18K-T	4609	4978	5531	78	42	29	265
---------	------	------	------	----	----	----	-----

Veneer species must be noted on each line item

Ellipse with center drawer, modesty panel. Metal legs available in satin nickel or black powder coat finish, please specify on order. Casters available on all table desks, please specify on order.

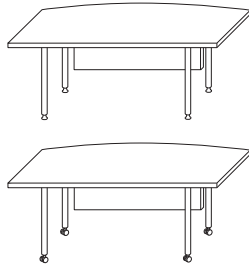

AS19A-T	4517	4878	5420	66	30/36	29	209
AS19D-T	4537	4900	5445	72	30/36	29	234
AS19F-T	4609	4978	5531	72	36/42	29	262

Veneer species must be noted on each line item

Bow front with center drawer, modesty panel. Metal legs available in satin nickel or black powder coat finish, please specify on order. Casters available on all table desks, please specify on order. Optional border inlay available on top surface of Fairmont only, add \$650 List.

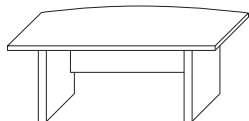

AS19A-M	5135	5545	6161	66	30/36	29	249
AS19D-M	5155	5568	6186	72	30/36	29	274
AS19F-M	5227	5645	6273	72	36/42	29	292

Veneer species must be noted on each line item

Bow front with center drawer, modesty panel and panel base. Optional border inlay available on top surface of Fairmont only, add \$850 List.

Veneer species must be noted on each line item

<u>Veneer Grade 1</u>	<u>Veneer Grade 2</u>	<u>Veneer Grade 3</u>
Cherry	Rift Oak	Anigre
Maple	Sapele	
Ligno-Grain		
Walnut		

HBF Ashton Casegoods - Credenzas

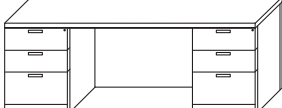
Style Number	List Price			Dimensions			Weight	
	Veneer 1	Veneer 2	Veneer 3	OW	OD	OH		
Double Pedestal Credenza								
	AS31D-AGA	3961	4279	4753	66	24	29	437
	AS31E-AGA	4069	4395	4883	72	24	29	447
	AS31F-AGA	4203	4539	5044	78	24	29	457
	AS31G-AGA	4250	4589	5099	84	24	29	465
	AS31H-AGA	4301	4645	5161	90	24	29	475
	AS31J-AGA	4342	4689	5211	96	24	29	485

Veneer species must be noted on each line item
Removable access panel with standard black unfinished back.

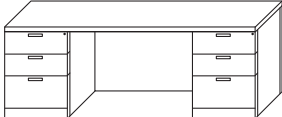
	AS32D-AGA	3961	4279	4753	66	24	29	437
	AS32E-AGA	4069	4395	4883	72	24	29	447
	AS32F-AGA	4203	4539	5044	78	24	29	457
	AS32G-AGA	4250	4589	5099	84	24	29	465
	AS32H-AGA	4301	4645	5161	90	24	29	475
	AS32J-AGA	4342	4689	5211	96	24	29	485

Veneer species must be noted on each line item
Removable access panel with standard black unfinished back.

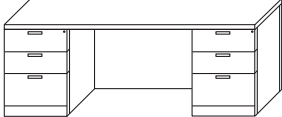
	AS33D-AGA	3961	4279	4753	66	24	29	437
	AS33E-AGA	4069	4395	4883	72	24	29	447
	AS33F-AGA	4203	4539	5044	78	24	29	457
	AS33G-AGA	4250	4589	5099	84	24	29	465
	AS33H-AGA	4301	4645	5161	90	24	29	475
	AS33J-AGA	4342	4689	5211	96	24	29	485

Veneer species must be noted on each line item
Removable access panel with standard black unfinished back.

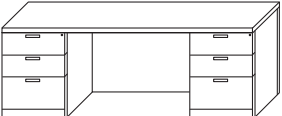
	AS34D-AHA	4280	4623	5136	66	25	29	488
	AS34E-AHA	4316	4662	5180	72	25	29	501
	AS34F-AHA	4640	5012	5569	78	25	29	515
	AS34G-AHA	4687	5062	5625	84	25	29	527
	AS34H-AHA	4831	5218	5798	90	25	29	541
	AS34J-AHA	4872	5263	5847	96	25	29	555

Veneer species must be noted on each line item
Finished, fixed back panel.

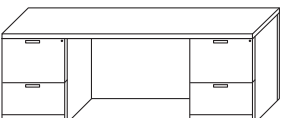
	AS31D-BGB	3961	4279	4753	66	24	29	437
	AS31E-BGB	4069	4395	4883	72	24	29	447
	AS31F-BGB	4203	4539	5044	78	24	29	457
	AS31G-BGB	4250	4589	5099	84	24	29	465
	AS31H-BGB	4301	4645	5161	90	24	29	475
	AS31J-BGB	4342	4689	5211	96	24	29	485

Veneer species must be noted on each line item
Removable access panel with standard black unfinished back.

Veneer species must be noted on each line item

<u>Veneer Grade 1</u>	<u>Veneer Grade 2</u>	<u>Veneer Grade 3</u>
Cherry	Rift Oak	Anigre
Maple	Sapele	
Ligno-Grain		
Walnut		

HBF Ashton Casegoods - Credenzas

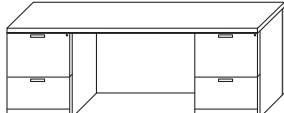
Style Number	List Price			Dimensions			Weight	
	Veneer 1	Veneer 2	Veneer 3	OW	OD	OH		
Double Pedestal Credenza								
	AS32D-BGB	3961	4279	4753	66	24	29	437
	AS32E-BGB	4069	4395	4883	72	24	29	447
	AS32F-BGB	4203	4539	5044	78	24	29	457
	AS32G-BGB	4250	4589	5099	84	24	29	465
	AS32H-BGB	4301	4645	5161	90	24	29	475
	AS32J-BGB	4342	4689	5211	96	24	29	485

Veneer species must be noted on each line item
Removable access panel with standard black unfinished back.

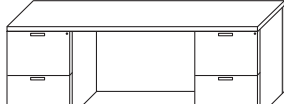
	AS33D-BGB	3961	4279	4753	66	24	29	437
	AS33E-BGB	4069	4395	4883	72	24	29	447
	AS33F-BGB	4203	4539	5044	78	24	29	457
	AS33G-BGB	4250	4589	5099	84	24	29	465
	AS33H-BGB	4301	4645	5161	90	24	29	475
	AS33J-BGB	4342	4689	5211	96	24	29	485

Veneer species must be noted on each line item
Removable access panel with standard black unfinished back.

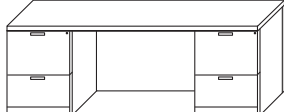
	AS34D-BHB	4280	4623	5136	66	25	29	488
	AS34E-BHB	4316	4662	5180	72	25	29	501
	AS34F-BHB	4640	5012	5569	78	25	29	515
	AS34G-BHB	4687	5062	5625	84	25	29	527
	AS34H-BHB	4831	5218	5798	90	25	29	541
	AS34J-BHB	4872	5263	5847	96	25	29	555

Veneer species must be noted on each line item
Finished, fixed back panel.

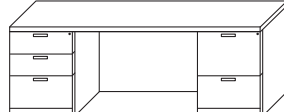
	AS31D-AGB	3961	4279	4753	66	24	29	437
	AS31E-AGB	4069	4395	4883	72	24	29	447
	AS31F-AGB	4203	4539	5044	78	24	29	457
	AS31G-AGB	4250	4589	5099	84	24	29	465
	AS31H-AGB	4301	4645	5161	90	24	29	475
	AS31J-AGB	4342	4689	5211	96	24	29	485

Veneer species must be noted on each line item
Removable access panel with standard black unfinished back.

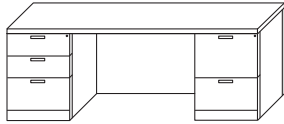
	AS32D-AGB	3961	4279	4753	66	24	29	437
	AS32E-AGB	4069	4395	4883	72	24	29	447
	AS32F-AGB	4203	4539	5044	78	24	29	457
	AS32G-AGB	4250	4589	5099	84	24	29	465
	AS32H-AGB	4301	4645	5161	90	24	29	475
	AS32J-AGB	4342	4689	5211	96	24	29	485

Veneer species must be noted on each line item
Removable access panel with standard black unfinished back.

Veneer species must be noted on each line item

<u>Veneer Grade 1</u>	<u>Veneer Grade 2</u>	<u>Veneer Grade 3</u>
Cherry	Rift Oak	Anigre
Maple	Sapele	
Ligno-Grain		
Walnut		

HBF Ashton Casegoods - Credenzas

Style Number	List Price			Dimensions			Weight
	Veneer 1	Veneer 2	Veneer 3	OW	OD	OH	

Double Pedestal Credenza

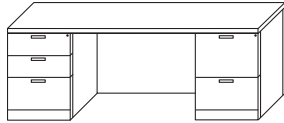

AS33D-AGB	3961	4279	4753	66	24	29	437
AS33E-AGB	4069	4395	4882	72	24	29	447
AS33F-AGB	4203	4539	5044	78	24	29	457
AS33G-AGB	4250	4589	5099	84	24	29	465
AS33H-AGB	4301	4645	5161	90	24	29	475
AS33J-AGB	4342	4689	5211	96	24	29	485

Veneer species must be noted on each line item
Removable access panel with standard black unfinished back.

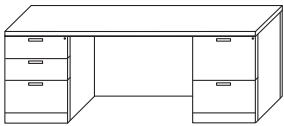

AS34D-AHB	4280	4623	5136	66	25	29	488
AS34E-AHB	4316	4662	5180	72	25	29	501
AS34F-AHB	4640	5012	5569	78	25	29	515
AS34G-AHB	4687	5062	5625	84	25	29	527
AS34H-AHB	4831	5218	5798	90	25	29	541
AS34J-AHB	4872	5263	5847	96	25	29	555

Veneer species must be noted on each line item
Finished, fixed back panel.

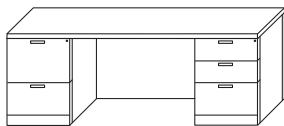

AS31D-BGA	3961	4279	4753	66	24	29	437
AS31E-BGA	4069	4395	4883	72	24	29	447
AS31F-BGA	4203	4539	5044	78	24	29	457
AS31G-BGA	4250	4589	5099	84	24	29	465
AS31H-BGA	4301	4645	5161	90	24	29	475
AS31J-BGA	4342	4689	5211	96	24	29	485

Veneer species must be noted on each line item
Removable access panel with standard black unfinished back.

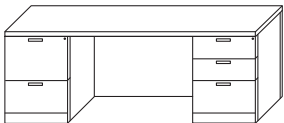

AS32D-BGA	3961	4279	4753	66	24	29	437
AS32E-BGA	4069	4395	4883	72	24	29	447
AS32F-BGA	4203	4539	5044	78	24	29	457
AS32G-BGA	4250	4589	5099	84	24	29	465
AS32H-BGA	4301	4645	5161	90	24	29	475
AS32J-BGA	4342	4689	5211	96	24	29	485

Veneer species must be noted on each line item
Removable access panel with standard black unfinished back.

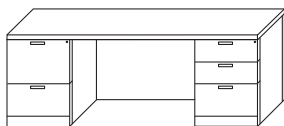

AS33D-BGA	3961	4279	4753	66	24	29	437
AS33E-BGA	4069	4395	4883	72	24	29	447
AS33F-BGA	4203	4539	5044	78	24	29	457
AS33G-BGA	4250	4589	5099	84	24	29	465
AS33H-BGA	4301	4645	5161	90	24	29	475
AS33J-BGA	4342	4689	5211	96	24	29	485

Veneer species must be noted on each line item
Removable access panel with standard black unfinished back.

Veneer species must be noted on each line item

<u>Veneer Grade 1</u>	<u>Veneer Grade 2</u>	<u>Veneer Grade 3</u>
Cherry	Rift Oak	Anigre
Maple	Sapele	
Ligno-Grain		
Walnut		

HBF Ashton Casegoods - Credenzas

	Style Number	List Price			Dimensions			Weight
		Veneer 1	Veneer 2	Veneer 3	OW	OD	OH	

Double Pedestal Credenza

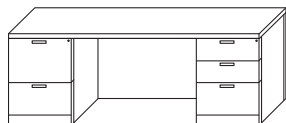

AS34D-BHA	4280	4623	5136	66	25	29	488
AS34E-BHA	4316	4662	5180	72	25	29	501
AS34F-BHA	4640	5012	5569	78	25	29	515
AS34G-BHA	4687	5062	5625	84	25	29	527
AS34H-BHA	4831	5218	5798	90	25	29	541
AS34J-BHA	4872	5263	5847	96	25	29	555

Veneer species must be noted on each line item

Finished, fixed back panel.

Single Pedestal Credenza

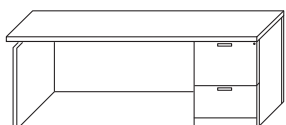

AS31D-LGB	2880	3110	3455	66	24	29	326
AS31E-LGB	2926	3160	3511	72	24	29	336
AS31F-LGB	3060	3304	3672	78	24	29	346
AS31G-LGB	3431	3705	4116	84	24	29	372
AS31H-LGB	3482	3761	4178	90	24	29	390
AS31J-LGB	3523	3805	4228	96	24	29	408

Veneer species must be noted on each line item

Removable access panel with standard black unfinished back.

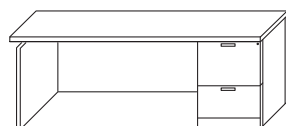

AS32D-LGB	2880	3110	3455	66	24	29	326
AS32E-LGB	2926	3160	3511	72	24	29	336
AS32F-LGB	3060	3304	3672	78	24	29	346
AS32G-LGB	3431	3705	4116	84	24	29	372
AS32H-LGB	3482	3761	4178	90	24	29	390
AS32J-LGB	3523	3805	4228	96	24	29	408

Veneer species must be noted on each line item

Removable access panel with standard black unfinished back.

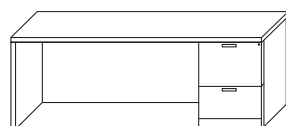

AS33D-KGB	3065	3310	3677	66	24	29	326
AS33E-KGB	3111	3360	3733	72	24	29	336
AS33F-KGB	3245	3504	3894	78	24	29	346
AS33G-KGB	3616	3905	4338	84	24	29	372
AS33H-KGB	3667	3961	4400	90	24	29	390
AS33J-KGB	3708	4005	4450	96	24	29	408

Veneer species must be noted on each line item

Removable access panel with standard black unfinished back.

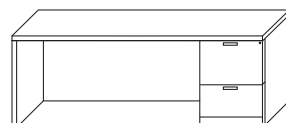

AS34D-KHB	3322	3588	3986	66	25	29	377
AS34E-KHB	3358	3627	4030	72	25	29	390
AS34F-KHB	3682	3977	4419	78	25	29	404
AS34G-KHB	3729	4027	4475	84	25	29	434
AS34H-KHB	3873	4183	4648	90	25	29	456
AS34J-KHB	3914	4228	4697	96	25	29	478

Veneer species must be noted on each line item

Finished, fixed back panel.

Veneer species must be noted on each line item

Veneer Grade 1	Veneer Grade 2	Veneer Grade 3
Cherry	Rift Oak	Anigre
Maple	Sapele	
Ligno-Grain		
Walnut		

HBF Ashton Casegoods - Credenzas

Style Number	List Price			Dimensions			Weight
	Veneer 1	Veneer 2	Veneer 3	OW	OD	OH	

Single Pedestal Credenza

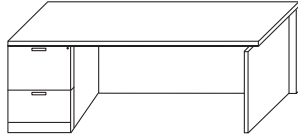

AS31D-BGL	2880	3110	3455	66	24	29	326
AS31E-BGL	2926	3160	3511	72	24	29	336
AS31F-BGL	3060	3304	3672	78	24	29	346
AS31G-BGL	3431	3705	4116	84	24	29	372
AS31H-BGL	3482	3761	4178	90	24	29	390
AS31J-BGL	3523	3805	4228	96	24	29	408

Veneer species must be noted on each line item
Removable access panel with standard black unfinished back.

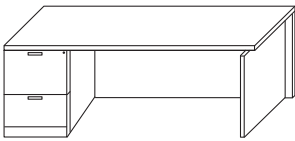

AS32D-BGL	2880	3110	3455	66	24	29	326
AS32E-BGL	2926	3160	3511	72	24	29	336
AS32F-BGL	3060	3304	3672	78	24	29	346
AS32G-BGL	3431	3705	4116	84	24	29	372
AS32H-BGL	3482	3761	4178	90	24	29	390
AS32J-BGL	3523	3805	4228	96	24	29	408

Veneer species must be noted on each line item
Removable access panel with standard black unfinished back.

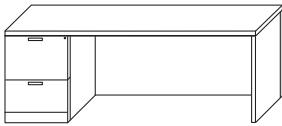

AS33D-BGK	3065	3310	3677	66	24	29	326
AS33E-BGK	3111	3360	3733	72	24	29	336
AS33F-BGK	3245	3504	3894	78	24	29	346
AS33G-BGK	3616	3905	4338	84	24	29	372
AS33H-BGK	3667	3961	4400	90	24	29	390
AS33J-BGK	3708	4005	4450	96	24	29	408

Veneer species must be noted on each line item
Removable access panel with standard black unfinished back.

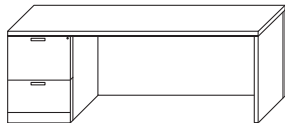

AS34D-BHK	3322	3588	3986	66	25	29	377
AS34E-BHK	3358	3627	4030	72	25	29	390
AS34F-BHK	3682	3977	4419	78	25	29	404
AS34G-BHK	3729	4027	4475	84	25	29	434
AS34H-BHK	3873	4183	4648	90	25	29	456
AS34J-BHK	3914	4228	4697	96	25	29	478

Veneer species must be noted on each line item
Finished, fixed back panel.

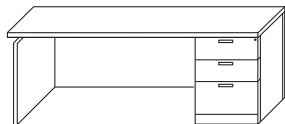

AS31D-LGA	2880	3110	3455	66	24	29	326
AS31E-LGA	2926	3160	3511	72	24	29	336
AS31F-LGA	3060	3304	3672	78	24	29	346
AS31G-LGA	3431	3705	4116	84	24	29	372
AS31H-LGA	3482	3761	4178	90	24	29	390
AS31J-LGA	3523	3805	4228	96	24	29	408

Veneer species must be noted on each line item
Removable access panel with standard black unfinished back.

Veneer species must be noted on each line item

Veneer Grade 1	Veneer Grade 2	Veneer Grade 3
Cherry	Rift Oak	Anigre
Maple	Sapele	
Ligno-Grain		
Walnut		

HBF Ashton Casegoods - Credenzas

Style Number	List Price			Dimensions			Weight
	Veneer 1	Veneer 2	Veneer 3	OW	OD	OH	

Single Pedestal Credenza

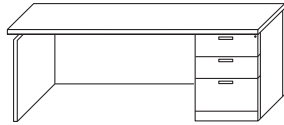

AS32D-LGA	2880	3110	3455	66	24	29	326
AS32E-LGA	2926	3160	3511	72	24	29	336
AS32F-LGA	3060	3304	3672	78	24	29	346
AS32G-LGA	3431	3705	4116	84	24	29	372
AS32H-LGA	3482	3761	4178	90	24	29	390
AS32J-LGA	3523	3805	4228	96	24	29	408

Veneer species must be noted on each line item
Removable access panel with standard black unfinished back.

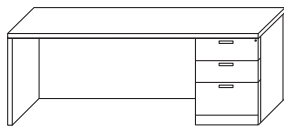

AS33D-KGA	3065	3310	3677	66	24	29	326
AS33E-KGA	3111	3360	3733	72	24	29	336
AS33F-KGA	3245	3504	3894	78	24	29	346
AS33G-KGA	3616	3905	4338	84	24	29	372
AS33H-KGA	3667	3961	4400	90	24	29	390
AS33J-KGA	3708	4005	4450	96	24	29	408

Veneer species must be noted on each line item
Removable access panel with standard black unfinished back.

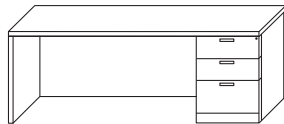

AS34D-KHA	3322	3588	3986	66	25	29	377
AS34E-KHA	3358	3627	4030	72	25	29	390
AS34F-KHA	3682	3977	4419	78	25	29	404
AS34G-KHA	3729	4027	4475	84	25	29	434
AS34H-KHA	3873	4183	4648	90	25	29	456
AS34J-KHA	3914	4228	4697	96	25	29	478

Veneer species must be noted on each line item
Finished, fixed back panel.

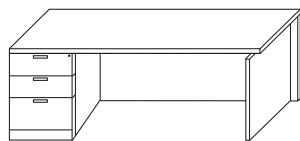

AS31D-AGL	2880	3110	3455	66	24	29	326
AS31E-AGL	2926	3160	3511	72	24	29	336
AS31F-AGL	3060	3304	3672	78	24	29	346
AS31G-AGL	3431	3705	4116	84	24	29	372
AS31H-AGL	3482	3761	4178	90	24	29	390
AS31J-AGL	3523	3805	4228	96	24	29	408

Veneer species must be noted on each line item
Removable access panel with standard black unfinished back.

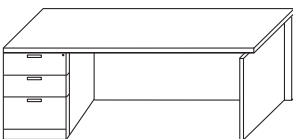

AS32D-AGL	2880	3110	3455	66	24	29	326
AS32E-AGL	2926	3160	3511	72	24	29	336
AS32F-AGL	3060	3304	3672	78	24	29	346
AS32G-AGL	3431	3705	4116	84	24	29	372
AS32H-AGL	3482	3761	4178	90	24	29	390
AS32J-AGL	3523	3805	4228	96	24	29	408

Veneer species must be noted on each line item
Removable access panel with standard black unfinished back.

Veneer species must be noted on each line item

Veneer Grade 1	Veneer Grade 2	Veneer Grade 3
Cherry	Rift Oak	Anigre
Maple	Sapele	
Ligno-Grain		
Walnut		

HBF Ashton Casegoods - Credenzas

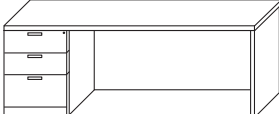
Style Number	List Price			Dimensions			Weight	
	Veneer 1	Veneer 2	Veneer 3	OW	OD	OH		
Single Pedestal Credenza								
	AS33D-AGK	3065	3310	3677	66	24	29	326
	AS33E-AGK	3111	3360	3733	72	24	29	336
	AS33F-AGK	3245	3504	3894	78	24	29	346
	AS33G-AGK	3616	3905	4338	84	24	29	372
	AS33H-AGK	3667	3961	4400	90	24	29	390
	AS33J-AGK	3708	4005	4450	96	24	29	408

Veneer species must be noted on each line item

Removable access panel with standard black unfinished back.

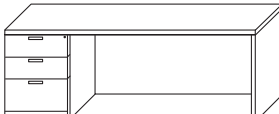
	AS34D-AHK	3322	3588	3986	66	25	29	377
	AS34E-AHK	3358	3627	4030	72	25	29	390
	AS34F-AHK	3682	3977	4419	78	25	29	404
	AS34G-AHK	3729	4027	4475	84	25	29	434
	AS34H-AHK	3873	4183	4648	90	25	29	456
	AS34J-AHK	3914	4228	4697	96	25	29	478

Veneer species must be noted on each line item

Finished, fixed back panel.

Double Pedestal Credenza, Center Doors

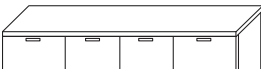
	AS31D-BEB	4986	5385	5983	66	24	29	400
	AS32D-BEB	4986	5385	5983	66	24	29	400
	AS33D-BEB	4986	5385	5983	66	24	29	400
	AS34D-BEB	5640	6091	6768	66	25	29	400

Veneer species must be noted on each line item

Two-door cabinet is 30" OW, one adjustable shelf.

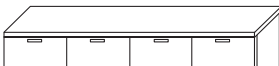
	AS31E-BFB	5057	5463	6069	72	24	29	415
	AS32E-BFB	5057	5463	6069	72	24	29	415
	AS33E-BFB	5057	5463	6069	72	24	29	415
	AS34E-BFB	5701	6158	6842	72	25	29	415

Veneer species must be noted on each line item

Two-door cabinet is 36" OW, one adjustable shelf.

Veneer species must be noted on each line item

Veneer Grade 1	Veneer Grade 2	Veneer Grade 3
Cherry	Rift Oak	Anigre
Maple	Sapele	
Ligno-Grain		
Walnut		

HBF Ashton Casegoods - Credenzas

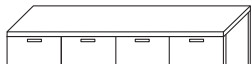
Style Number	List Price			Dimensions			Weight	
	Veneer 1	Veneer 2	Veneer 3	OW	OD	OH		
Credenza, Doors								
	AS31C-EE	3642	3932	4370	60	24	29	423
	AS32C-EE	3642	3932	4370	60	24	29	423
	AS33C-EE	3642	3932	4370	60	24	29	423
	AS34C-EE	4296	4638	5155	60	25	29	423

Veneer species must be noted on each line item

Two-door cabinet is 30" OW, one adjustable shelf per cabinet.

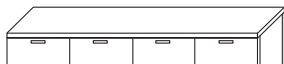
	AS31E-FF	3774	4077	4529	72	24	29	453
	AS32E-FF	3774	4077	4529	72	24	29	453
	AS33E-FF	3774	4077	4529	72	24	29	453
	AS34E-FF	4418	4772	5302	72	25	29	453

Veneer species must be noted on each line item

Two-door cabinet is 36" OW, one adjustable shelf per cabinet.

Veneer species must be noted on each line item

<u>Veneer Grade 1</u>	<u>Veneer Grade 2</u>	<u>Veneer Grade 3</u>
Cherry	Rift Oak	Anigre
Maple	Sapele	
Ligno-Grain		
Walnut		

HBF Ashton Casegoods - Credenzas

Credenzas - Other Configurations

HBF Ashton credenzas are offered in many different sizes and pedestal configurations for maximum flexibility. For ease in specification, use the style number creation system described below. This system allows you to select a variety of credenza widths and place components in any configuration. Credenza pricing is calculated by totaling the individual prices of all components and the credenza top price. *Several commonly used credenzas are listed on the previous pages for your convenience.*

Style Number Creation System

Example Credenza

<u>Product Code</u>	<u>Width Code</u>	=	<u>Component Configuration</u>
31 ↓	H ↓		ABGK ↓
31 Credenza - Front finished	M 18"		A Box/Box/File 18"
32 Credenza - Front and one end finished	N 24"		B File/File 18"
33 Credenza - Front and both ends finished	P 30"		C Lateral File 30"
34 Credenza - Front, back and both ends finished	R 36"		D Lateral File 36"
	S 42"		M Open Lateral File 30"
	A 48"		N Open Lateral File 36"
	B 54"		U Single Door 18"
	C 60"		E Double Door 30"
	D 66"		F Double Door 36"
	E 72"		G Removable Access Panel
	F 78"		H Finished Modesty Panel
	G 84"		J Open - No Modesty Panel
	H 90"		K End Panel - Finished
	J 96"		L Recessed End Panel Unfinished
	K 102"		
	L 108"		
	T 114"		
	U 120"		

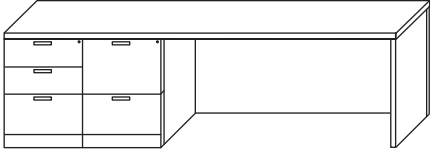

OW 90"
OD 24"
OH 29"

Style Number Descriptions

Product Code: Denotes the product as a credenza and also specifies the number of credenza finished sides.

31 - 1 Side: Only the front (user side) is finished. These units have unfinished backs.

32 - 2 Sides: Front and one end is finished. Credenza back is unfinished.

33 - 3 Sides: Front and both ends are finished. Credenza back is unfinished.

34 - 4 Sides: Front, back and both ends are finished. Credenza back is finished.

Ashton: Edge detail on front for Product codes 31, 32, and 33; 3/8" overhang on front; band on finished sides.

Edge detail on front and back for Product Code 34; 3/8" overhang front and back; band on finished sides.



Finished - 1 Side (**31**)
Actual Depth = 24 3/8"
Unfinished Back



Finished - 3 Sides (**33**)
Actual Depth = 24 3/8"
Unfinished Back



Finished - 2 Sides (**32**)
Actual Depth = 24 3/8"
Unfinished Back



Finished - 4 Sides (**34**)
Actual Depth = 25 1/2"
Note: Additional 3/4" added to depth for Product Code 34
Finished Back

Width Code: Denotes the actual width of the credenza.

Note: Credenza pedestal back recessed 4" to allow for wall access and wire management.

HBF Ashton Casegoods - Credenzas

Credenzas - Other Configurations

Credenza Tops, Descriptions and Pricing

All available sizes of Ashton credenza tops are listed below. To calculate the price of a credenza, total the individual prices of all components and the credenza top price. Individual component prices are contained in the lists below. All credenza tops with an edge detail on the front (user side) profile are Product Code 31. Credenza tops with edge details on the front (user side) and back profiles, Product Code 34, include a finished back panel. Pricing examples are calculated on the following page.

Credenza Top Width	Width Code	Credenza Top List Price			Weight	Product Code 34 Credenzas			Weight
		Product Code 31, 32, 33 Credenzas				Veneer 1	Veneer 2	Veneer 3	
18"	M	366	395	439	35	932	1007	1119	62
24"	N	402	434	482	45	968	1046	1162	75
30"	P	500	540	599	55	1066	1151	1279	88
36"	R	541	584	649	65	1112	1201	1335	101
42"	S	587	634	705	78	1154	1246	1384	114
48"	A	628	679	754	85	1200	1296	1440	127
54"	B	891	962	1069	95	1535	1657	1842	140
60"	C	922	996	1106	105	1576	1702	1891	153
66"	D	958	1035	1149	115	1612	1741	1934	166
72"	E	1004	1085	1205	125	1648	1780	1978	179
78"	F	1138	1229	1366	135	1972	2130	2367	193
84"	G	1185	1279	1421	143	2019	2180	2423	205
90"	H	1236	1335	1483	153	2163	2336	2596	219
96"	J	1277	1379	1533	163	2204	2381	2645	233
102"	K	1303	1407	1564	173	2415	2609	2898	248
108"	L	1324	1429	1588	183	2441	2636	2929	263
114"	T	1396	1507	1675	193	2575	2781	3090	278
120"	U	1416	1530	1700	203	2606	2814	3127	293

Credenza Components, Descriptions and Pricing

Component Configuration: Denotes the pedestal/component configuration when viewing the credenza from the user side and reading left to right. When selecting from the following components please ensure the width of credenza top specified will accommodate all selected components. Kneespaces will account for the difference between credenza overall width and the total width of all specified components coded A, B, C, D, U, E and F. Minimum kneespace width should be at least 24".

Casegood Components	Component Code	OW	List Price			Weight
			Veneer 1	Veneer 2	Veneer 3	
Box/box/file	A	18"	1334	1441	1601	125
File/file	B	18"	1334	1441	1601	125
Lateral file	C	30"	1602	1730	1922	140
Lateral file	D	36"	1694	1830	2033	140
Lat/Open	M	30"	1447	1563	1737	85
Lat/Open	N	36"	1540	1663	1848	95
Single door cabinet*	U	18"	1097	1185	1316	95
Double door cabinet	E	30"	1360	1468	1632	95
Double door cabinet	F	36"	1385	1496	1662	95
Removable access panel	G	6" - 30"	335	362	402	24
		31" - 60"	397	428	476	42
		61" (2 panels)	721	779	865	60

This kneespace panel is completely removable to allow for wall access. It has a standard black unfinished back and is finished inside. The width will vary based upon credenza top width selected and the width of all specified components. The removable access panel price is based on its width. Only specified for Product Code 31, 32, 33.

Finished modesty panel	H	varies	No Charge (Product Code 34)			N/A
<i>The panel is fixed and is finished on both sides. This kneespace panel is standard on all kneespace credenzas with edge details on the front and back profiles (Product Code 34). Its size will be automatically selected. There is no charge for a finished modesty panel as its cost is contained in the pricing above for credenza tops with front and back edge details. Only specified for Product Code 34.</i>						
Open back	J	varies	No Charge			N/A
<i>No removable access panel or finished modesty panel will be placed in the back of the kneespace.</i>						

Note: *1. Specify left hinge or right hinge on single door cabinets.

HBF Ashton Casegoods - Credenzas

Credenzas Pricing Examples

	Component Description	Width Code	Component Code	List Price	
AS33E-AGB 	72" Top	E		\$1205	
	Box/box/file		A	\$1601	
	36" Removable access panel - unfinished back		G	\$476	
	File/file		B	\$1601	
	Total			\$4882	Veneer Grade 3

AS33H-AGB 	90" Top	H		\$1335	
	Box/box/file		A	\$1441	
	File/file		B	\$1441	
	54" Removable access panel - unfinished back		G	\$428	
	Total			\$4645	Veneer Grade 2

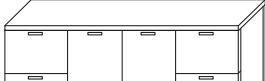
AS34D-BEB 	66" Top (finished back panel)	D		\$1612	
	File/file		B	\$1334	
	Double door cabinet - 30"		E	\$1360	
	File/file		B	\$1334	
	Total			\$5640	Veneer Grade 1

HBF Ashton Casegoods - Returns

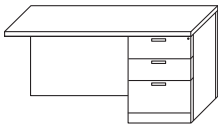
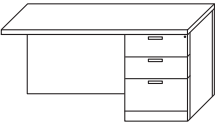
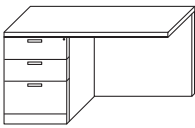
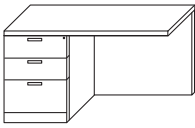
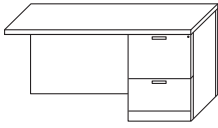
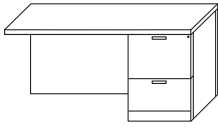
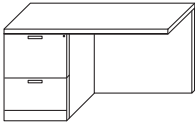
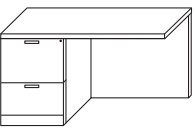
	Style Number	List Price			Dimensions			Weight
		Veneer 1	Veneer 2	Veneer 3	OW	OD	OH	
Returns with Pedestals								
	AS44S-HA	2487	2686	2985	42	24	29	254
	AS44A-HA	2534	2737	3041	48	24	29	266
	AS44B-HA	2869	3098	3442	54	24	29	278
	Veneer species must be noted on each line item Finished, fixed modesty panel.							
	AS43S-GA	2256	2436	2707	42	24	29	249
	AS43A-GA	2297	2481	2756	48	24	29	262
	AS43B-GA	2621	2831	3146	54	24	29	274
	Veneer species must be noted on each line item Removable access panel with unfinished back.							
	AS44S-AH	2487	2686	2985	42	24	29	254
	AS44A-AH	2534	2737	3041	48	24	29	266
	AS44B-AH	2869	3098	3442	54	24	29	278
	Veneer species must be noted on each line item Finished, fixed modesty panel.							
	AS43S-AG	2256	2436	2707	42	24	29	249
	AS43A-AG	2297	2481	2756	48	24	29	262
	AS43B-AG	2621	2831	3146	54	24	29	274
	Veneer species must be noted on each line item Removable access panel with unfinished back.							
	AS44S-HB	2487	2686	2985	42	24	29	254
	AS44A-HB	2534	2737	3041	48	24	29	266
	AS44B-HB	2869	3098	3442	54	24	29	278
	Veneer species must be noted on each line item Finished, fixed modesty panel.							
	AS43S-GB	2256	2436	2707	42	24	29	249
	AS43A-GB	2297	2481	2756	48	24	29	262
	AS43B-GB	2621	2831	3146	54	24	29	274
	Veneer species must be noted on each line item Removable access panel with unfinished back.							
	AS44S-BH	2487	2686	2985	42	24	29	254
	AS44A-BH	2534	2737	3041	48	24	29	266
	AS44B-BH	2869	3098	3442	54	24	29	278
	Veneer species must be noted on each line item Finished, fixed modesty panel.							
	AS (v) 43S-BG	2256	2436	2707	42	24	29	249
	AS (v) 43A-BG	2297	2481	2756	48	24	29	262
	AS (v) 43B-BG	2621	2831	3146	54	24	29	274
	Veneer species must be noted on each line item Removable access panel with unfinished back.							
Veneer species must be noted on each line item								
<u>Veneer Grade 1</u>		<u>Veneer Grade 2</u>		<u>Veneer Grade 3</u>				
Cherry		Rift Oak		Anigre				
Maple		Sapele						
Ligno-Grain								
Walnut								

HBF Ashton Casegoods - Returns

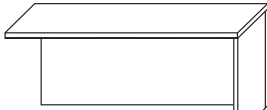
Style Number	List Price			Dimensions			Weight	
	Veneer 1	Veneer 2	Veneer 3	OW	OD	OH		
	AS44C-HK	1952	2108	2342	60	24	29	282
	AS44D-HK	1988	2147	2385	66	24	29	296
	AS44E-HK	2024	2186	2429	72	24	29	309
	AS44F-HK	2348	2536	2818	78	24	29	322
	AS44G-HK	2395	2586	2874	84	24	29	335

Veneer species must be noted on each line item

Finished, fixed modesty panel.

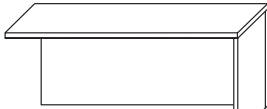
	AS43C-GK	1694	1830	2033	60	24	29	282
	AS43D-GK	2055	2219	2466	66	24	29	296
	AS43E-GK	2101	2269	2521	72	24	29	309
	AS43F-GK	2235	2414	2682	78	24	29	322
	AS43G-GK	2281	2464	2738	84	24	29	335

Veneer species must be noted on each line item

Removable access panel with unfinished back.

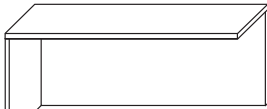
	AS44C-KH	1952	2108	2342	60	24	29	282
	AS44D-KH	1988	2147	2385	66	24	29	296
	AS44E-KH	2024	2186	2429	72	24	29	309
	AS44F-KH	2348	2536	2818	78	24	29	322
	AS44G-KH	2395	2586	2874	84	24	29	335

Veneer species must be noted on each line item

Finished, fixed modesty panel.

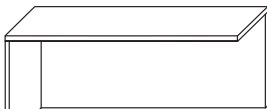
	AS43C-KG	1694	1830	2033	60	24	29	282
	AS43D-KG	2055	2219	2466	66	24	29	296
	AS43E-KG	2101	2269	2521	72	24	29	309
	AS43F-KG	2235	2414	2682	78	24	29	322
	AS43G-KG	2281	2464	2738	84	24	29	335

Veneer species must be noted on each line item

Removable access panel with unfinished back.

Veneer species must be noted on each line item

Veneer Grade 1	Veneer Grade 2	Veneer Grade 3
Cherry	Rift Oak	Anigre
Maple	Sapele	
Ligno-Grain		
Walnut		

HBF Ashton Casegoods - Returns

Returns - Other Configurations

HBF Ashton returns are offered in many different sizes and pedestal configurations for maximum flexibility. For ease in specification, use the style number creation system described below. This system allows you to select a variety of return widths and place components in any configuration. Return pricing is calculated by totaling the individual prices of all components and the return top price. *Several commonly used returns are listed on the previous pages for your convenience.*

Style Number Creation System

Example Return

Product Code	Width Code	=	Component Configuration
43 ↓	H ↓		ABG ↓
43 Return - Front and one end finished 44 Return - Front, back and one end finished	M 18" N 24" P 30" R 36" S 42" A 48" B 54" C 60" D 66" E 72" F 78" G 84" H 90" J 96" K 102" L 108" T 114" U 120"		A Box/Box/File 18" B File/File 18" C Lateral File 30" D Lateral File 36" M Open Lateral File 30" N Open Lateral File 36" U Single Door 18" E Double Door 30" F Double Door 36" G Removable Access Panel H Finished Modesty Panel J Open - No Modesty Panel K End Panel - Finished L Recessed End Panel Unfinished

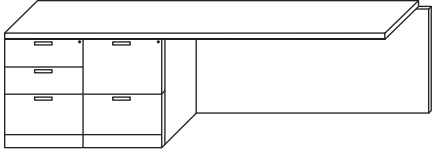

OW 90"
OD 24"
OH 29"

Style Number Descriptions

Product Code: Denotes the product as a return and also specifies the number of return finished sides.

43 - 2 Sides: Front and one end finished. Return back is unfinished.

44 - 3 Sides: Front, back and one end finished. Return back is finished.

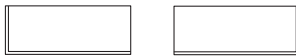

Finished - 2 Sides (**43**)
Actual Depth = 24 3/8"
Unfinished Back



Finished - 3 Sides (**44**)
Actual Depth = 25 1/8"
Finished Back

Width Code: Denotes the actual width of the return.

Note: Return pedestal back recessed 4" to allow for wall access and wire management.

HBF Ashton Casegoods - Returns

Returns - Other Configurations

Return Tops, Descriptions and Pricing

All available sizes of Ashton return tops are listed below. To calculate the price of a return, total the individual prices of all components and the return top price. Individual component prices are contained in the lists below. All return tops with Product Code 43 have an unfinished back. Return tops with a Product Code 44, *include a finished back panel.*

Return Top Width	Width Code	Return Top List Price			Weight	Product Code 44 Returns			Weight
		Product Code 43 Returns				Product Code 44 Returns			
		Veneer 1	Veneer 2	Veneer 3		Veneer 1	Veneer 2	Veneer 3	
18"	M	366	395	439	35	932	1007	1119	62
24"	N	402	434	482	45	968	1046	1162	75
30"	P	500	540	599	55	1066	1151	1279	88
36"	R	541	584	649	65	1112	1201	1335	101
42"	S	587	634	705	78	1154	1246	1384	114
48"	A	628	679	754	85	1200	1296	1440	127
54"	B	891	962	1069	95	1535	1657	1842	140
60"	C	922	996	1106	105	1576	1702	1891	153
66"	D	958	1035	1149	115	1612	1741	1934	166
72"	E	1004	1085	1205	125	1648	1780	1978	179
78"	F	1138	1229	1366	135	1972	2130	2367	193
84"	G	1185	1279	1421	143	2019	2180	2423	205
90"	H	1236	1335	1483	153	2163	2336	2596	219
96"	J	1277	1379	1533	163	2204	2381	2645	233
102"	K	1303	1407	1564	173	2415	2609	2898	248
108"	L	1324	1429	1588	183	2441	2636	2929	263
114"	T	1396	1507	1675	193	2575	2781	3090	278
120"	U	1416	1530	1700	203	2606	2814	3127	293

Return Components, Descriptions and Pricing

Component Configuration: Denotes the pedestal/component configuration when viewing the return from the user side and reading left to right. When selecting from the following components please ensure the width of return top specified will accommodate all selected components. Kneespaces will account for the difference between return overall width and the total width of all specified components coded A, B, C, D, U, E and F. Minimum kneespace width should be at least 24".

Casegood Components	Component Code	OW	List Price			Weight
			Veneer 1	Veneer 2	Veneer 3	
Box/box/file	A	18"	1334	1441	1601	125
File/file	B	18"	1334	1441	1601	125
Lateral file	C	30"	1602	1730	1922	140
Lateral file	D	36"	1694	1830	2033	140
Lat/Open	M	30"	1447	1563	1737	85
Lat/Open	N	36"	1540	1663	1848	95
Single door cabinet*	U	18"	1097	1185	1316	95
Double door cabinet	E	30"	1360	1468	1632	95
Double door cabinet	F	36"	1385	1496	1662	95
Removable access panel	G	6" - 30"	335	362	402	24
		31" - 60"	397	428	476	42
		61" (2 panels)	721	779	865	60

This kneespace panel is completely removable to allow for wall access. It has a standard black unfinished back and is finished inside. The width will vary based upon return top width selected and the width of all specified components. The removable access panel price is based on its width. Only specified for Product Code 31, 32, 33.

Finished modesty panel	H	varies	No Charge (Product Code 44)	N/A
<i>The panel is fixed and is finished on both sides. This kneespace panel is standard on all kneespace return with edge details on the front and back profiles (Product Code 44). Its size will be automatically selected. There is no charge for a finished modesty panel as its cost is contained in the pricing above for return tops with front and back edge details. Only specified for Product Code 44.</i>				
Open back	J	varies	No Charge	N/A
<i>No removable access panel or finished modesty panel will be placed in the back of the kneespace.</i>				

Note: *1. Specify left hinge or right hinge on single door cabinets.

HBF Ashton Casegoods - Bridges, Corner Units

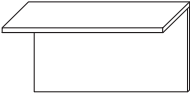
	Style Number	List Price			Dimensions			Weight
		Veneer 1	Veneer 2	Veneer 3	OW	OD	OH	
	AS52D	1159	1251	1391	24	24	29	111
	AS52E	1241	1340	1489	30	24	29	123
	AS52F	1282	1385	1539	36	24	29	135
	AS52A	1334	1441	1601	42	24	29	147
	AS52B	1365	1474	1638	48	24	29	159
	AS52C	1612	1741	1934	54	24	29	171

Veneer species must be noted on each line item

Finished, fixed modesty panel.

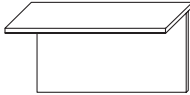
	AS51D	839	907	1007	24	24	29	101
	AS51E	912	984	1094	30	24	29	113
	AS51F	963	1040	1156	36	24	29	125
	AS51A	1015	1096	1217	42	24	29	137
	AS51B	1056	1140	1267	48	24	29	149
	AS51C	1365	1474	1638	54	24	29	161

Veneer species must be noted on each line item

Removable access panel; standard black, unfinished back.

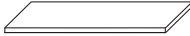
	AS50D	417	451	501	24	24		68
	AS50E	510	551	612	30	24		80
	AS50F	551	595	661	36	24		92
	AS50A	603	651	723	42	24		104
	AS50B	644	695	773	48	24		116
	AS50C	953	1029	1143	54	24		128

Veneer species must be noted on each line item

Bridge top only.

24", 30" and 36" OW bridges are to be used only with corner units. Only bridges 42" OW and greater can be used with u-shaped configurations.

Veneer species must be noted on each line item

Veneer Grade 1	Veneer Grade 2	Veneer Grade 3
Cherry	Rift Oak	Anigre
Maple	Sapele	
Ligno-Grain		
Walnut		

HBF Ashton Casegoods - Bridges, Corner Units

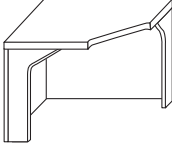
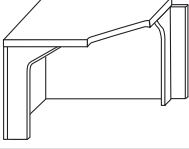
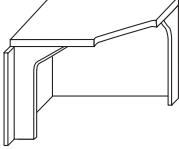
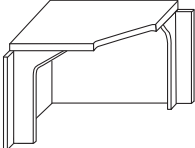
	Style Number	List Price			Dimensions			Weight
		Veneer 1	Veneer 2	Veneer 3	OW	OD	OH	
Corner Units								
	AS55A	3311	3576	3974	42	42	29	147
	AS55B	3363	3632	4036	48	48	29	159
Veneer species must be noted on each line item Finished, fixed modesty panel left and right.								
	AS56CL	2889	3120	3467	42	42	29	137
	AS56DL	2941	3176	3529	48	48	29	149
Veneer species must be noted on each line item Finished, fixed modesty panel left, removable access panel right.								
	AS56CR	2889	3120	3467	42	42	29	137
	AS56DR	2941	3176	3529	48	48	29	149
Veneer species must be noted on each line item Removable access panel left, finished fixed modesty panel right.								
	AS56A	2621	2831	3146	42	42	29	137
	AS56B	2673	2887	3207	48	48	29	149
Veneer species must be noted on each line item Removable access panels left and right.								

Corner units used with bridges or returns only.

24", 30" and 36" OW bridges are to be used only with corner units. Only bridges 42" OW and greater can be used with u-shaped configurations.

Veneer species must be noted on each line item

<u>Veneer Grade 1</u>	<u>Veneer Grade 2</u>	<u>Veneer Grade 3</u>
Cherry	Rift Oak	Anigre
Maple	Sapele	
Ligno-Grain		
Walnut		

HBF Ashton Casegoods - Desk Extensions

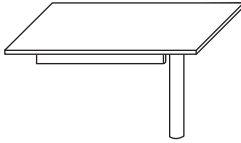
Style Number	List Price			Dimensions			Weight	
	Veneer 1	Veneer 2	Veneer 3	OW	OD	OH		
Desk Extensions								
	AS20A	1777	1919	2132	48	30	29	156
	AS20B	1880	2030	2256	48	36	29	175
	AS20C	1828	1975	2194	54	30	29	174
	AS20D	1921	2075	2305	54	36	29	196
	AS20E	1880	2030	2256	60	30	29	191
	AS20F	1972	2130	2367	60	36	29	226
	AS20G	1921	2075	2305	66	30	29	206
	AS20H	2014	2175	2416	66	36	29	254
	AS20J	1972	2130	2367	72	30	29	222
	AS20K	2055	2219	2466	72	36	29	281

Veneer species must be noted on each line item

Rectangular, end forms joint with the profile of worksurface to which it is connected. Metal base support available in satin nickel or black powder coat finish, please specify on order.

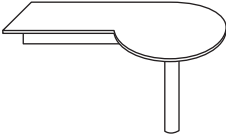
	AS22C	2848	3076	3418	54	30/36	29	196
	AS22D	2992	3232	3591	54	36/42	29	229
	AS22E	2930	3165	3516	60	30/36	29	226
	AS22F	3054	3298	3665	60	36/42	29	254
	AS22G	2992	3232	3591	66	30/36	29	254
	AS22H	3126	3376	3751	66	36/42	29	278
	AS22J	3054	3298	3665	72	30/36	29	281
	AS22K	3188	3443	3825	72	36/42	29	298

Veneer species must be noted on each line item

"P" left hand, end forms joint with the profile of worksurface to which it is connected. Metal base support available in satin nickel or black powder coat finish, please specify on order.

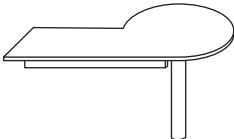
	AS23C	2848	3076	3418	54	30/36	29	196
	AS23D	2992	3232	3591	54	36/42	29	229
	AS23E	2930	3165	3516	60	30/36	29	226
	AS23F	3054	3298	3665	60	36/42	29	254
	AS23G	2992	3232	3591	66	30/36	29	254
	AS23H	3126	3376	3751	66	36/42	29	278
	AS23J	3054	3298	3665	72	30/36	29	281
	AS23K	3188	3443	3825	72	36/42	29	298

Veneer species must be noted on each line item

"P" right hand, end forms joint with the profile of worksurface to which it is connected. Metal base support available in satin nickel or black powder coat finish, please specify on order.

Veneer species must be noted on each line item

Veneer Grade 1	Veneer Grade 2	Veneer Grade 3
Cherry	Rift Oak	Anigre
Maple	Sapele	
Ligno-Grain		
Walnut		

HBF Ashton Casegoods - Desk Extensions

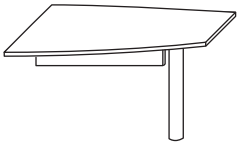
Style Number	List Price			Dimensions			Weight	
	Veneer 1	Veneer 2	Veneer 3	OW	OD	OH		
Desk Extensions								
	AS24A	2426	2620	2911	48	24/30	29	156
	AS24B	2518	2720	3022	48	30/36	29	175
	AS24C	2477	2675	2973	54	24/30	29	174
	AS24D	2570	2775	3084	54	30/36	29	196
	AS24E	2518	2720	3022	60	24/30	29	191
	AS24F	2611	2820	3133	60	30/36	29	226
	AS24G	2570	2775	3084	66	24/30	29	206
	AS24H	2663	2876	3195	66	30/36	29	254
	AS24J	2611	2820	3133	72	24/30	29	222
	AS24K	2704	2920	3245	72	30/36	29	281

Veneer species must be noted on each line item

Half boat, end forms joint with the profile of worksurface to which it is connected. Metal base support available in satin nickel or black powder coat finish, please specify on order.

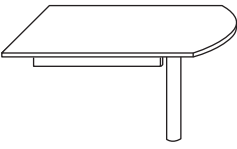
	AS25A	2034	2197	2441	48	30	29	156
	AS25B	2127	2297	2552	48	36	29	175
	AS25C	2086	2253	2503	54	30	29	174
	AS25D	2168	2342	2602	54	36	29	196
	AS25E	2127	2297	2552	60	30	29	191
	AS25F	2209	2386	2651	60	36	29	226
	AS25G	2168	2342	2602	66	30	29	206
	AS25H	2251	2431	2701	66	36	29	254
	AS25J	2209	2386	2651	72	30	29	222
	AS25K	2292	2475	2750	72	36	29	281

Veneer species must be noted on each line item

Arc'd end, end forms joint with the profile of worksurface to which it is connected. Metal base support available in satin nickel or black powder coat finish, please specify on order.

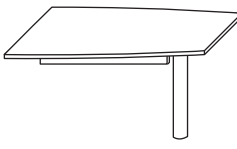
	AS26A	2230	2408	2676	48	27/30	29	156
	AS26B	2323	2508	2787	48	33/36	29	175
	AS26C	2281	2464	2738	54	27/30	29	174
	AS26D	2364	2553	2837	54	33/36	29	196
	AS26E	2323	2508	2787	60	27/30	29	191
	AS26F	2415	2609	2898	60	33/36	29	226
	AS26G	2364	2553	2837	66	27/30	29	206
	AS26H	2457	2653	2948	66	33/36	29	254
	AS26J	2405	2597	2886	72	27/30	29	222
	AS26K	2498	2698	2997	72	33/36	29	281

Veneer species must be noted on each line item

Quarter boat left hand, end forms joint with the profile of worksurface to which it is connected. Metal base support available in satin nickel or black powder coat finish, please specify on order.

Veneer species must be noted on each line item

<u>Veneer Grade 1</u>	<u>Veneer Grade 2</u>	<u>Veneer Grade 3</u>
Cherry	Rift Oak	Anigre
Maple	Sapele	
Ligno-Grain		
Walnut		

HBF Ashton Casegoods - Desk Extensions

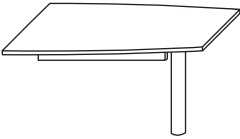
Style Number	List Price			Dimensions			Weight	
	Veneer 1	Veneer 2	Veneer 3	OW	OD	OH		
Desk Extensions								
	AS27A	2230	2408	2676	48	27/30	29	156
	AS27B	2323	2508	2787	48	33/36	29	175
	AS27C	2281	2464	2738	54	27/30	29	174
	AS27D	2364	2553	2837	54	33/36	29	196
	AS27E	2323	2508	2787	60	27/30	29	191
	AS27F	2415	2609	2898	60	33/36	29	226
	AS27G	2364	2553	2837	66	27/30	29	206
	AS27H	2457	2653	2948	66	33/36	29	254
	AS27J	2405	2597	2886	72	27/30	29	222
	AS27K	2498	2698	2997	72	33/36	29	281

Veneer species must be noted on each line item

Quarter boat right hand, end forms joint with the profile of worksurface to which it is connected. Metal base support available in satin nickel or black powder coat finish, please specify on order.

Desk Extensions with end panel

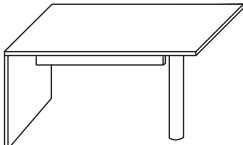
	AS20J-K	2539	2742	3047	72	30	29	251
	AS20K-K	2611	2820	3133	72	36	29	261
	AS20L-K	2580	2787	3096	84	30	29	266
	AS20M-K	2652	2864	3183	84	36	29	271
	AS20N-K	2621	2831	3146	96	30	29	276
	AS20P-K	2693	2909	3232	96	36	29	281

Veneer species must be noted on each line item

Rectangular, metal base support available in satin nickel or black powder coat finish, please specify on order.

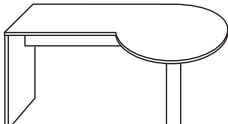
	AS22J-K	3620	3910	4345	72	30/36	29	310
	AS22K-K	3734	4032	4481	72	36/42	29	320
	AS22L-K	3682	3977	4419	84	30/36	29	325
	AS22M-K	3796	4099	4555	84	36/42	29	330
	AS22N-K	3744	4044	4493	96	30/36	29	335
	AS22P-K	3857	4166	4629	96	36/42	29	340

Veneer species must be noted on each line item

"P" left hand, metal base support available in satin nickel or black powder coat finish, please specify on order.

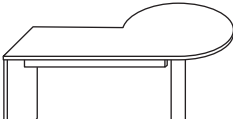
	AS23J-K	3620	3910	4345	72	30/36	29	310
	AS23K-K	3734	4032	4481	72	36/42	29	320
	AS23L-K	3682	3977	4419	84	30/36	29	325
	AS23M-K	3796	4099	4555	84	36/42	29	330
	AS23N-K	3744	4044	4493	96	30/36	29	335
	AS23P-K	3857	4166	4629	96	36/42	29	340

Veneer species must be noted on each line item

"P" right hand, metal base support available in satin nickel or black powder coat finish, please specify on order.

Veneer species must be noted on each line item

Veneer Grade 1	Veneer Grade 2	Veneer Grade 3
Cherry	Rift Oak	Anigre
Maple	Sapele	
Ligno-Grain		
Walnut		

HBF Ashton Casegoods - Returns

Style Number	List Price			Dimensions			Weight
	Veneer 1	Veneer 2	Veneer 3	OW	OD	OH	

Desk Extensions with end panel

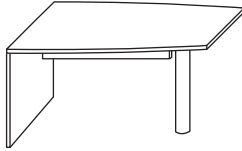

AS24J-K	3178	3432	3813	72	24/30	29	251
AS24K-K	3260	3521	3912	72	30/36	29	261
AS24L-K	3219	3476	3863	84	24/30	29	266
AS24M-K	3301	3565	3961	84	30/36	29	271
AS24N-K	3260	3521	3912	96	24/30	29	276
AS24P-K	3342	3610	4011	96	30/36	29	281

Veneer species must be noted on each line item

Half boat, metal base support available in satin nickel or black powder coat finish, please specify on order.

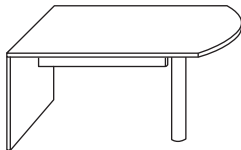

AS25J-K	2776	2998	3331	72	30	29	251
AS25K-K	2858	3087	3430	72	36	29	261
AS25L-K	2817	3042	3380	84	30	29	266
AS25M-K	2899	3131	3479	84	36	29	271
AS25N-K	2858	3087	3430	96	30	29	276
AS25P-K	2941	3176	3529	96	36	29	281

Veneer species must be noted on each line item

Half boat, metal base support available in satin nickel or black powder coat finish, please specify on order.

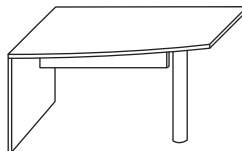

AS26J-K	2982	3220	3578	72	27/30	29	251
AS26K-K	3064	3309	3677	72	33/36	29	261
AS26L-K	3023	3265	3628	84	27/30	29	266
AS26M-K	3105	3354	3727	84	33/36	29	271
AS26N-K	3064	3309	3677	96	27/30	29	276
AS26P-K	3147	3398	3776	96	33/36	29	281

Veneer species must be noted on each line item

Quarter boat left hand, metal base support available in satin nickel or black powder coat finish, please specify on order.

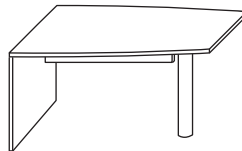

AS27J-K	2982	3220	3578	72	27/30	29	251
AS27K-K	3064	3309	3677	72	33/36	29	261
AS27L-K	3023	3265	3628	84	27/30	29	266
AS27M-K	3105	3354	3727	84	33/36	29	271
AS27N-K	3064	3309	3677	96	27/30	29	276
AS27P-K	3147	3398	3776	96	33/36	29	281

Veneer species must be noted on each line item

Quarter boat right hand, metal base support available in satin nickel or black powder coat finish, please specify on order.

Veneer species must be noted on each line item

<u>Veneer Grade 1</u>	<u>Veneer Grade 2</u>	<u>Veneer Grade 3</u>
Cherry	Rift Oak	Anigre
Maple	Sapele	
Ligno-Grain		
Walnut		

HBF Ashton Casegoods - Storage Units

Style Number	List Price			Dimensions			Weight
	Veneer 1	Veneer 2	Veneer 3	OW	OD	OH	
Mobile File Pedestal							
AS30	1746	1886	2095	18	20	24 1/2	147

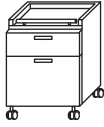

Veneer species must be noted on each line item

Casters, one box drawer and one file drawer. Metal pull on front to provide ease of movement, face lock. File pedestal will nest under any 29" OH worksurface.

Credenza Storage Towers

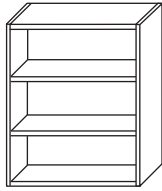
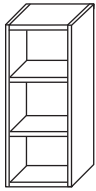

AS68F	1736	1874	2083	18	14 7/8	42 1/4	87
AS68D	2302	2486	2762	30	14 7/8	42 1/4	97
AS68E	2446	2642	2936	36	14 7/8	42 1/4	97

Veneer species must be noted on each line item

Flush top, no profile edge detail, two adjustable shelves, unfinished back, sits on credenza.

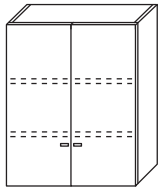
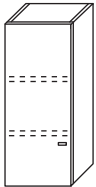

AS69F	2271	2453	2725	18	15 3/4	42 1/4	97
AS69D	2807	3031	3368	30	15 3/4	42 1/4	117
AS69E	2930	3165	3516	36	15 3/4	42 1/4	117

Veneer species must be noted on each line item

Flush top, no profile edge detail, two adjustable shelves, unfinished back, sits on credenza. 18" OW storage towers are one-door units, specify left or right hinge. 30" and 36" OW towers are two-door units.

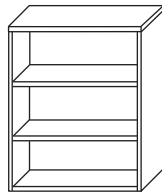
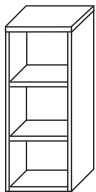

AS68C	1931	2086	2318	18	14 7/8	43 5/8	87
AS68A	2549	2753	3059	30	14 7/8	43 5/8	97
AS68B	2745	2965	3294	36	14 7/8	43 5/8	97

Veneer species must be noted on each line item

Top profile edge detail, two adjustable shelves, unfinished back, sits on credenza.

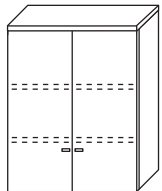
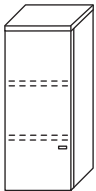

AS69C	2457	2653	2948	18	15 3/4	43 5/8	97
AS69A	3044	3287	3652	30	15 3/4	43 5/8	117
AS69B	3239	3498	3887	36	15 3/4	43 5/8	117

Veneer species must be noted on each line item

Top profile edge detail, two adjustable shelves, unfinished back, sits on credenza. 18" OW storage towers are one-door units, specify left or right hinge. 30" and 36" OW towers are two-door units.

Veneer species must be noted on each line item

Veneer Grade 1	Veneer Grade 2	Veneer Grade 3
Cherry	Rift Oak	Anigre
Maple	Sapele	
Ligno-Grain		
Walnut		

HBF Ashton Casegoods - Storage Units

Style Number	List Price			Dimensions			Weight
	Veneer 1	Veneer 2	Veneer 3	OW	OD	OH	

Credenza Storage Towers

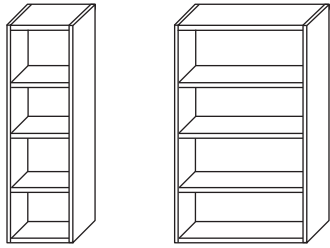

AS68F2	2354	2542	2824	18	14 7/8	56	95
AS68D2	3105	3354	3727	30	14 7/8	56	106
AS68E2	3311	3576	3974	36	14 7/8	56	106

Veneer species must be noted on each line item

Flush top, no profile edge detail, three adjustable shelves, unfinished back, sits on credenza.

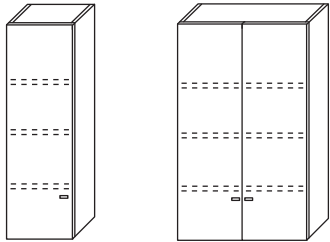

AS69F2	3064	3309	3677	18	15 3/4	56	106
AS69D2	3785	4088	4542	30	15 3/4	56	127
AS69E2	3960	4277	4752	36	15 3/4	56	127

Veneer species must be noted on each line item

Flush top, no profile edge detail, three adjustable shelves, unfinished back, sits on credenza. 18" OW storage towers are one-door units, specify left or right hinge. 30" and 36" OW towers are two-door units.

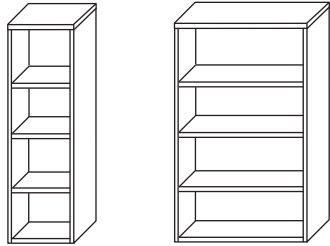

AS68C2	2611	2820	3133	18	14 7/8	57 3/8	95
AS68A2	3435	3710	4122	30	14 7/8	57 3/8	106
AS68B2	3703	3999	4443	36	14 7/8	57 3/8	106

Veneer species must be noted on each line item

Top profile edge detail, three adjustable shelves, unfinished back, sits on credenza.

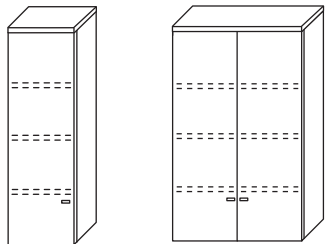

AS69C2	3322	3587	3986	18	15 3/4	57 3/8	106
AS69A2	4115	4444	4938	30	15 3/4	57 3/8	127
AS69B2	4372	4722	5247	36	15 3/4	57 3/8	127

Veneer species must be noted on each line item

Top profile edge detail, three adjustable shelves, unfinished back, sits on credenza. 18" OW storage towers are one-door units, specify left or right hinge. 30" and 36" OW towers are two-door units.

Veneer species must be noted on each line item

Veneer Grade 1	Veneer Grade 2	Veneer Grade 3
Cherry	Rift Oak	Anigre
Maple	Sapele	
Ligno-Grain		
Walnut		

HBF Mercer-Ashton Casegoods - Storage Units

Style Number	List Price			Dimensions			Weight
	Veneer 1	Veneer 2	Veneer 3	OW	OD	OH	

Credenza Storage Towers

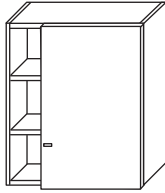

AS69D-P	3085	3332	3702	30	15 3/4	42 1/4	94
AS69E-P	3229	3487	3875	36	15 3/4	42 1/4	114

Veneer species must be noted on each line item

Flush top, no profile edge detail, two adjustable shelves, unfinished back, sits on credenza. All storage towers are one-door units, specify left or right hinge. Open storage area 7 3/4" wide.

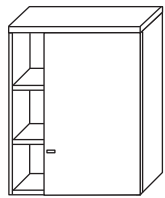

AS69A-P	3353	3621	4023	30	15 3/4	43 5/8	94
AS69B-P	3559	3843	4270	36	15 3/4	43 5/8	114

Veneer species must be noted on each line item

Top profile edge detail, two adjustable shelves, unfinished back, sits on credenza. All storage towers are one-door units, specify left or right hinge. Open storage area 7 3/4" wide.

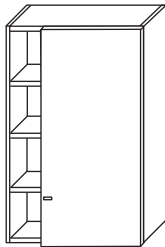

AS69D2-P	4166	4500	5000	30	15 3/4	56	103
AS69E2-P	4362	4711	5234	36	15 3/4	56	125

Veneer species must be noted on each line item

Flush top, no profile edge detail, three adjustable shelves, unfinished back, sits on credenza. All storage towers are one-door units, specify left or right hinge. Open storage area 7 3/4" wide.

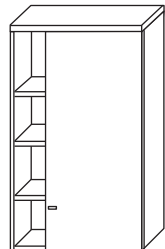

AS69A2-P	4527	4889	5432	30	15 3/4	57 3/8	103
AS69B2-P	4815	5200	5778	36	15 3/4	57 3/8	125

Veneer species must be noted on each line item

Top profile edge detail, three adjustable shelves, unfinished back, sits on credenza. All storage towers are one-door units, specify left or right hinge. Open storage area 7 3/4" wide.

Veneer species must be noted on each line item

<u>Veneer Grade 1</u>	<u>Veneer Grade 2</u>	<u>Veneer Grade 3</u>
Cherry	Rift Oak	Anigre
Maple	Sapele	
Ligno-Grain		
Walnut		

HBF Ashton Casegoods - Overhead Cabinets

Style Number	Fabric	List Price			Dimensions			Weight
		Veneer 1	Veneer 2	Veneer 3	OW	OD	OH	

Overhead Cabinets, Top without Profile Edge Detail, Wood Panel Support

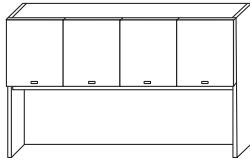

AS62M-FNP	3 yds	3384	3654	4060	72	15 3/4	42 1/4	282
------------------	-------	-------------	-------------	-------------	----	--------	--------	-----

Veneer species must be noted on each line item

Flush top without profile edge detail, fabric tack panel (fabric not included, COM must be acrylic backed), cabinet back unfinished. Optional task lights available, see HBF Casegood Accessories.

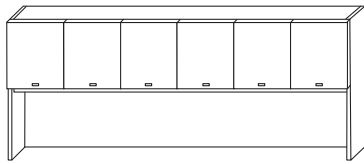

AS62N-FNP	3 yds	3857	4166	4629	78	15 3/4	42 1/4	289
AS62P-FNP	3 yds	4043	4366	4851	84	15 3/4	42 1/4	296
AS62R-FNP	3 yds	4208	4544	5049	90	15 3/4	42 1/4	339
AS62S-FNP	3 1/4 yds	4383	4733	5259	96	15 3/4	42 1/4	351
AS62T-FNP	3 1/2 yds	4568	4933	5482	102	15 3/4	42 1/4	365
AS62U-FNP	3 3/4 yds	4733	5111	5679	108	15 3/4	42 1/4	376
AS62V-FNP	4 1/4 yds	4918	5312	5902	114	15 3/4	42 1/4	391
AS62W-FNP	4 1/4 yds	5104	5512	6124	120	15 3/4	42 1/4	406

Veneer species must be noted on each line item

Flush top without profile edge detail, fabric tack panel (fabric not included, COM must be acrylic backed), cabinet back unfinished. Optional task lights available, see HBF Casegood Accessories.

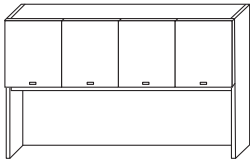

AS63M-FNP		3600	3888	4320	72	15 3/4	42 1/4	282
------------------	--	-------------	-------------	-------------	----	--------	--------	-----

Veneer species must be noted on each line item

Flush top without profile edge detail, finished wood panel, cabinet back unfinished. Optional task lights available, see HBF Casegood Accessories.

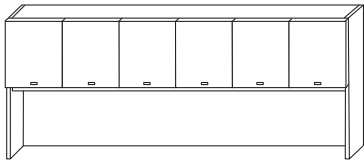

AS63N-FNP		4105	4433	4925	78	15 3/4	42 1/4	289
AS63P-FNP		4300	4644	5160	84	15 3/4	42 1/4	296
AS63R-FNP		4475	4833	5370	90	15 3/4	42 1/4	339
AS63S-FNP		4661	5034	5593	96	15 3/4	42 1/4	351
AS63T-FNP		4860	5248	5831	102	15 3/4	42 1/4	365
AS63U-FNP		5032	5434	6038	108	15 3/4	42 1/4	376
AS63V-FNP		5217	5634	6260	114	15 3/4	42 1/4	391
AS63W-FNP		5402	5835	6483	120	15 3/4	42 1/4	406

Veneer species must be noted on each line item

Flush top without profile edge detail, finished wood panel, cabinet back unfinished. Optional task lights available, see HBF Casegood Accessories.

Veneer species must be noted on each line item

<u>Veneer Grade 1</u>	<u>Veneer Grade 2</u>	<u>Veneer Grade 3</u>
Cherry	Rift Oak	Anigre
Maple	Sapele	
Ligno-Grain		
Walnut		

HBF Ashton Casegoods - Overhead Cabinets

Style Number	Fabric	List Price			Dimensions			Weight
		Veneer 1	Veneer 2	Veneer 3	OW	OD	OH	

Overhead Cabinets, Top without Profile Edge Detail, Wood Panel Support

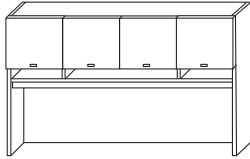

AS62M-FWP	3 yds	3723	4021	4468	72	15 3/4	42 1/4	282
-----------	-------	------	------	------	----	--------	--------	-----

Veneer species must be noted on each line item

Flush top without profile edge detail, fabric tack panel (fabric not included, COM must be acrylic backed). Open project shelf storage 3" high. Cabinet back unfinished. Optional task lights available, see HBF Casegood Accessories.

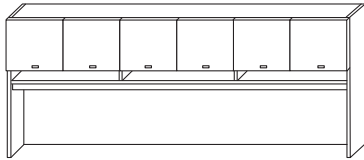

AS62N-FWP	3 yds	4249	4589	5099	78	15 3/4	42 1/4	289
AS62P-FWP	3 yds	4444	4800	5333	84	15 3/4	42 1/4	296
AS62R-FWP	3 yds	4630	5000	5556	90	15 3/4	42 1/4	339
AS62S-FWP	3 1/4 yds	4826	5212	5791	96	15 3/4	42 1/4	351
AS62T-FWP	3 1/2 yds	5021	5423	6026	102	15 3/4	42 1/4	365
AS62U-FWP	3 3/4 yds	5207	5623	6248	108	15 3/4	42 1/4	376
AS62V-FWP	4 1/4 yds	5392	5823	6470	114	15 3/4	42 1/4	391
AS62W-FWP	4 1/4 yds	5577	6024	6693	120	15 3/4	42 1/4	406

Veneer species must be noted on each line item

Flush top without profile edge detail, fabric tack panel (fabric not included, COM must be acrylic backed). Open project shelf storage 3" high. Cabinet back unfinished. Optional task lights available, see HBF Casegood Accessories.

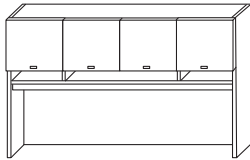

AS63M-FWP		3960	4277	4752	72	15 3/4	42 1/4	282
-----------	--	------	------	------	----	--------	--------	-----

Veneer species must be noted on each line item

Flush top without profile edge detail, finished wood panel. Open project shelf storage 3" high. Cabinet back unfinished. Optional task lights available, see HBF Casegood Accessories.

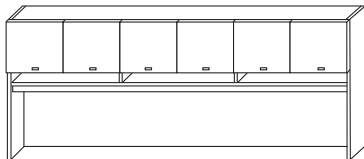

AS63N-FWP		4517	4878	5420	78	15 3/4	42 1/4	289
AS63P-FWP		4733	5111	5679	84	15 3/4	42 1/4	296
AS63R-FWP		4929	5323	5914	90	15 3/4	42 1/4	339
AS63S-FWP		5135	5545	6161	96	15 3/4	42 1/4	351
AS63T-FWP		5351	5779	6421	102	15 3/4	42 1/4	365
AS63U-FWP		5536	5979	6644	108	15 3/4	42 1/4	376
AS63V-FWP		5722	6179	6866	114	15 3/4	42 1/4	391
AS63W-FWP		5907	6380	7088	120	15 3/4	42 1/4	406

Veneer species must be noted on each line item

Flush top without profile edge detail, finished wood panel. Open project shelf storage 3" high. Cabinet back unfinished. Optional task lights available, see HBF Casegood Accessories.

Veneer species must be noted on each line item

<u>Veneer Grade 1</u>	<u>Veneer Grade 2</u>	<u>Veneer Grade 3</u>
Cherry	Rift Oak	Anigre
Maple	Sapele	
Ligno-Grain		
Walnut		

HBF Ashton Casegoods - Overhead Cabinets

Style Number	Fabric	List Price			Dimensions			Weight
		Veneer 1	Veneer 2	Veneer 3	OW	OD	OH	

Overhead Cabinets, Top without Profile Edge Detail, Wood Panel Support

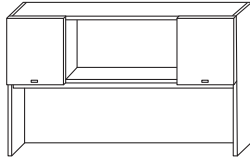

AS62M-PNP	3 yds	3208	3465	3850	72	15 3/4	42 1/4	282
-----------	-------	------	------	------	----	--------	--------	-----

Veneer species must be noted on each line item

Flush top without profile edge detail, fabric tack panel (fabric not included, COM must be acrylic backed). Open center storage. Cabinet back unfinished. Optional task lights available, see HBF Casegood Accessories.

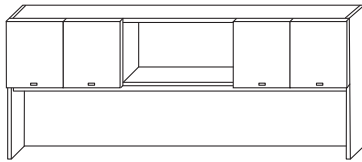

AS62N-PNP	3 yds	3672	3966	4406	78	15 3/4	42 1/4	289
AS62P-PNP	3 yds	3837	4144	4604	84	15 3/4	42 1/4	296
AS62R-PNP	3 yds	4002	4322	4802	90	15 3/4	42 1/4	339
AS62S-PNP	3 1/4 yds	4166	4500	5000	96	15 3/4	42 1/4	351
AS62T-PNP	3 1/2 yds	4331	4678	5197	102	15 3/4	42 1/4	365
AS62U-PNP	3 3/4 yds	4496	4856	5395	108	15 3/4	42 1/4	376
AS62V-PNP	4 1/4 yds	4681	5056	5618	114	15 3/4	42 1/4	391
AS62W-PNP	4 1/4 yds	4867	5256	5840	120	15 3/4	42 1/4	406

Veneer species must be noted on each line item

Flush top without profile edge detail, fabric tack panel (fabric not included, COM must be acrylic backed). Open center storage. Cabinet back unfinished. Optional task lights available, see HBF Casegood Accessories.

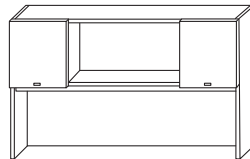

AS63M-PNP		3425	3699	4110	72	15 3/4	42 1/4	282
-----------	--	------	------	------	----	--------	--------	-----

Veneer species must be noted on each line item

Flush top without profile edge detail, finished wood panel. Open center storage. Cabinet back unfinished. Optional task lights available, see HBF Casegood Accessories.

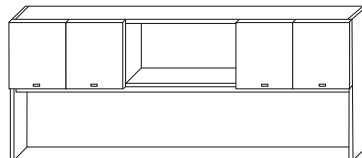

AS63N-PNP		3899	4210	4678	78	15 3/4	42 1/4	289
AS63P-PNP		4084	4411	4901	84	15 3/4	42 1/4	296
AS63R-PNP		4249	4589	5099	90	15 3/4	42 1/4	339
AS63S-PNP		4434	4789	5321	96	15 3/4	42 1/4	351
AS63T-PNP		4620	4989	5543	102	15 3/4	42 1/4	365
AS63U-PNP		4784	5167	5741	108	15 3/4	42 1/4	376
AS63V-PNP		4970	5367	5964	114	15 3/4	42 1/4	391
AS63W-PNP		5155	5568	6186	120	15 3/4	42 1/4	406

Veneer species must be noted on each line item

Flush top without profile edge detail, finished wood panel. Open center storage. Cabinet back unfinished. Optional task lights available, see HBF Casegood Accessories.

Veneer species must be noted on each line item

Veneer Grade 1	Veneer Grade 2	Veneer Grade 3
Cherry	Rift Oak	Anigre
Maple	Sapele	
Ligno-Grain		
Walnut		

HBF Ashton Casegoods - Overhead Cabinets

Style Number	Fabric	List Price			Dimensions			Weight
		Veneer 1	Veneer 2	Veneer 3	OW	OD	OH	

Overhead Cabinets, Top without Profile Edge Detail, Wood Panel Support

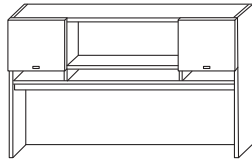

AS62M-PWP	3 yds	3548	3832	4258	72	15 3/4	42 1/4	282
-----------	-------	------	------	------	----	--------	--------	-----

Veneer species must be noted on each line item

Flush top without profile edge detail, fabric tack panel (fabric not included, COM must be acrylic backed). Open project shelf storage 3" high and open center storage. Cabinet back unfinished. Optional task lights available, see HBF Casegood Accessories.

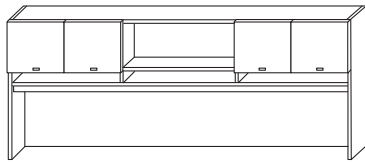

AS62N-PWP	3 yds	4053	4377	4864	78	15 3/4	42 1/4	289
AS62P-PWP	3 yds	4249	4589	5099	84	15 3/4	42 1/4	296
AS62R-PWP	3 yds	4424	4788	5309	90	15 3/4	42 1/4	339
AS62S-PWP	3 1/4 yds	4599	4967	5519	96	15 3/4	42 1/4	351
AS62T-PWP	3 1/2 yds	4795	5178	5754	102	15 3/4	42 1/4	365
AS62U-PWP	3 3/4 yds	4970	5367	5964	108	15 3/4	42 1/4	376
AS62V-PWP	4 1/4 yds	5155	5568	6186	114	15 3/4	42 1/4	391
AS62W-PWP	4 1/4 yds	5341	5768	6409	120	15 3/4	42 1/4	406

Veneer species must be noted on each line item

Flush top without profile edge detail, fabric tack panel (fabric not included, COM must be acrylic backed). Open project shelf storage 3" high and open center storage. Cabinet back unfinished. Optional task lights available, see HBF Casegood Accessories.

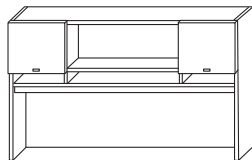

AS63M-PWP		3785	4088	4542	72	15 3/4	42 1/4	282
-----------	--	------	------	------	----	--------	--------	-----

Veneer species must be noted on each line item

Flush top without profile edge detail, finished wood panel. Open project shelf storage 3" high and open center storage. Cabinet back unfinished. Optional task lights available, see HBF Casegood Accessories.

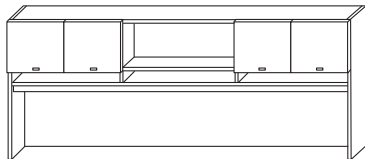

AS63N-PWP		4311	4655	5173	78	15 3/4	42 1/4	289
AS63P-PWP		4517	4878	5420	84	15 3/4	42 1/4	296
AS63R-PWP		4702	5078	5642	90	15 3/4	42 1/4	339
AS63S-PWP		4898	5289	5877	96	15 3/4	42 1/4	351
AS63T-PWP		5104	5512	6124	102	15 3/4	42 1/4	365
AS63U-PWP		5289	5712	6347	108	15 3/4	42 1/4	376
AS63V-PWP		5474	5912	6569	114	15 3/4	42 1/4	391
AS63W-PWP		5660	6113	6792	120	15 3/4	42 1/4	406

Veneer species must be noted on each line item

Flush top without profile edge detail, finished wood panel. Open project shelf storage 3" high and open center storage. Cabinet back unfinished. Optional task lights available, see HBF Casegood Accessories.

Veneer species must be noted on each line item

<u>Veneer Grade 1</u>	<u>Veneer Grade 2</u>	<u>Veneer Grade 3</u>
Cherry	Rift Oak	Anigre
Maple	Sapele	
Ligno-Grain		
Walnut		

HBF Ashton Casegoods - Overhead Cabinets

Style Number	Fabric	List Price			Dimensions			Weight
		Veneer 1	Veneer 2	Veneer 3	OW	OD	OH	

Overhead Cabinets, Top without Profile Edge Detail, Wood Panel Support (Double High)

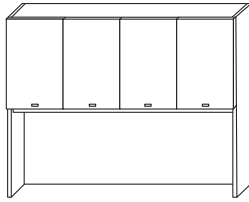

AS62M2-FNP	3 yds	4568	4933	5482	72	15 3/4	56	312
------------	-------	------	------	------	----	--------	----	-----

Veneer species must be noted on each line item

Flush top without profile edge detail, one adjustable shelf, fabric tack panel (fabric not included, COM must be acrylic backed). Cabinet back unfinished. Optional task lights available, see HBF Casegood Accessories.

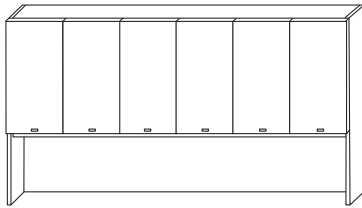

AS62N2-FNP	3 yds	5217	5634	6260	78	15 3/4	56	319
AS62P2-FNP	3 yds	5464	5901	6557	84	15 3/4	56	326
AS62R2-FNP	3 yds	5691	6146	6829	90	15 3/4	56	379
AS62S2-FNP	3 1/4 yds	5928	6402	7113	96	15 3/4	56	391
AS62T2-FNP	3 1/2 yds	6165	6658	7397	102	15 3/4	56	405
AS62U2-FNP	3 3/4 yds	6401	6914	7682	108	15 3/4	56	416
AS62V2-FNP	4 1/4 yds	6638	7169	7966	114	15 3/4	56	441
AS62W2-FNP	4 1/4 yds	6875	7425	8250	120	15 3/4	56	456

Veneer species must be noted on each line item

Flush top without profile edge detail, one adjustable shelf, fabric tack panel (fabric not included, COM must be acrylic backed). Cabinet back unfinished. Optional task lights available, see HBF Casegood Accessories.

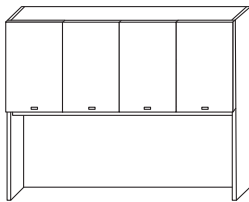

AS63M2-FNP		4867	5256	5840	72	15 3/4	56	312
------------	--	------	------	------	----	--------	----	-----

Veneer species must be noted on each line item

Flush top without profile edge detail, one adjustable shelf, finished wood panel. Cabinet back unfinished. Optional task lights available, see HBF Casegood Accessories.

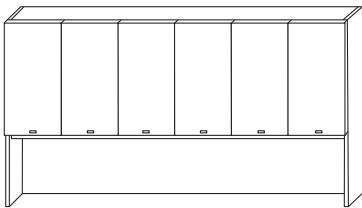

AS63N2-FNP		5547	5990	6656	78	15 3/4	56	319
AS63P2-FNP		5814	6279	6977	84	15 3/4	56	326
AS63R2-FNP		6051	6535	7262	90	15 3/4	56	379
AS63S2-FNP		6298	6802	7558	96	15 3/4	56	391
AS63T2-FNP		6566	7092	7880	102	15 3/4	56	405
AS63U2-FNP		6803	7347	8164	108	15 3/4	56	416
AS63V2-FNP		7040	7603	8448	114	15 3/4	56	441
AS63W2-FNP		7277	7859	8732	120	15 3/4	56	456

Veneer species must be noted on each line item

Flush top without profile edge detail, one adjustable shelf, finished wood panel. Cabinet back unfinished. Optional task lights available, see HBF Casegood Accessories.

Double high overhead cabinets to be used with double high vertical cabinets.

Veneer species must be noted on each line item

<u>Veneer Grade 1</u>	<u>Veneer Grade 2</u>	<u>Veneer Grade 3</u>
Cherry	Rift Oak	Anigre
Maple	Sapele	
Ligno-Grain		
Walnut		

HBF Ashton Casegoods - Overhead Cabinets

Style Number	Fabric	List Price			Dimensions			Weight
		Veneer 1	Veneer 2	Veneer 3	OW	OD	OH	

Overhead Cabinets, Top without Profile Edge Detail, Wood Panel Support (Double High)

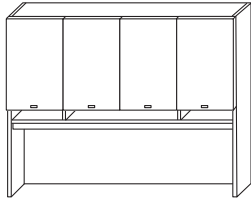

AS62M2-FWP	3 yds	5021	5423	6026	72	15 3/4	56	312
-------------------	-------	-------------	-------------	-------------	----	--------	----	-----

Veneer species must be noted on each line item

Flush top without profile edge detail, one adjustable shelf, fabric tack panel (fabric not included, COM must be acrylic backed). Open project shelf storage 3" high. Cabinet back unfinished. Optional task lights available, see HBF Casegood Accessories.

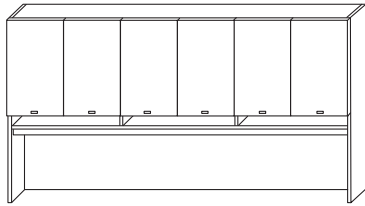

AS62N2-FWP	3 yds	5742	6202	6891	78	15 3/4	56	319
AS62P2-FWP	3 yds	6010	6491	7212	84	15 3/4	56	326
AS62R2-FWP	3 yds	6257	6758	7509	90	15 3/4	56	379
AS62S2-FWP	3 1/4 yds	6515	7036	7818	96	15 3/4	56	391
AS62T2-FWP	3 1/2 yds	6783	7325	8139	102	15 3/4	56	405
AS62U2-FWP	3 3/4 yds	7040	7603	8448	108	15 3/4	56	416
AS62V2-FWP	4 1/4 yds	7277	7859	8732	114	15 3/4	56	441
AS62W2-FWP	4 1/4 yds	7514	8115	9017	120	15 3/4	56	456

Veneer species must be noted on each line item

Flush top without profile edge detail, one adjustable shelf, fabric tack panel (fabric not included, COM must be acrylic backed). Open project shelf storage 3" high. Cabinet back unfinished. Optional task lights available, see HBF Casegood Accessories.

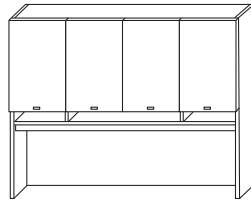

AS63M2-FWP		5351	5779	6421	72	15 3/4	56	312
-------------------	--	-------------	-------------	-------------	----	--------	----	-----

Veneer species must be noted on each line item

Flush top without profile edge detail, one adjustable shelf, finished wood panel. Open project shelf storage 3" high. Cabinet back unfinished. Optional task lights available, see HBF Casegood Accessories.

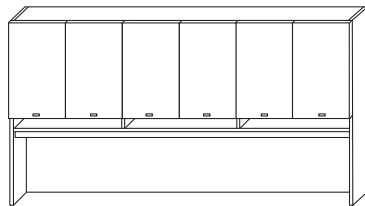

AS63N2-FWP		6103	6591	7323	78	15 3/4	56	319
AS63P2-FWP		6391	6902	7669	84	15 3/4	56	326
AS63R2-FWP		6659	7192	7991	90	15 3/4	56	379
AS63S2-FWP		6927	7481	8312	96	15 3/4	56	391
AS63T2-FWP		7225	7803	8671	102	15 3/4	56	405
AS63U2-FWP		7483	8082	8980	108	15 3/4	56	416
AS63V2-FWP		7720	8337	9264	114	15 3/4	56	441
AS63W2-FWP		7957	8593	9548	120	15 3/4	56	456

Veneer species must be noted on each line item

Flush top without profile edge detail, one adjustable shelf, finished wood panel. Open project shelf storage 3" high. Cabinet back unfinished. Optional task lights available, see HBF Casegood Accessories.

Double high overhead cabinets to be used with double high vertical cabinets.

Veneer species must be noted on each line item

<u>Veneer Grade 1</u>	<u>Veneer Grade 2</u>	<u>Veneer Grade 3</u>
Cherry	Rift Oak	Anigre
Maple	Sapele	
Ligno-Grain		
Walnut		

HBF Ashton Casegoods - Overhead Cabinets

Style Number	Fabric	List Price			Dimensions			Weight
		Veneer 1	Veneer 2	Veneer 3	OW	OD	OH	

Overhead Cabinets, Top without Profile Edge Detail, Wood Panel Support (Double High)

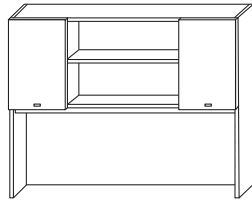

AS62M2-PNP	3 yds	4341	4689	5210	72	15 3/4	56	312
------------	-------	------	------	------	----	--------	----	-----

Veneer species must be noted on each line item

Flush top without profile edge detail, fabric tack panel (fabric not included, COM must be acrylic backed). Open center storage, one adjustable shelf. Cabinet back unfinished. Optional task lights available, see HBF Casegood Accessories.

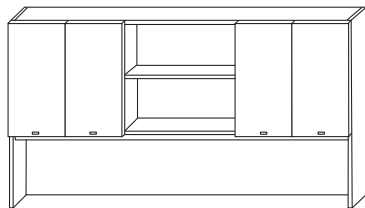

AS62N2-PNP	3 yds	4959	5356	5951	78	15 3/4	56	319
AS62P2-PNP	3 yds	5186	5601	6223	84	15 3/4	56	326
AS62R2-PNP	3 yds	5413	5846	6495	90	15 3/4	56	379
AS62S2-PNP	3 1/4 yds	5629	6079	6755	96	15 3/4	56	391
AS62T2-PNP	3 1/2 yds	5856	6324	7027	102	15 3/4	56	405
AS62U2-PNP	3 3/4 yds	6082	6569	7299	108	15 3/4	56	416
AS62V2-PNP	4 1/4 yds	6319	6825	7583	114	15 3/4	56	441
AS62W2-PNP	4 1/4 yds	6556	7080	7867	120	15 3/4	56	456

Veneer species must be noted on each line item

Flush top without profile edge detail, fabric tack panel (fabric not included, COM must be acrylic backed). Open center storage, one adjustable shelf. Cabinet back unfinished. Optional task lights available, see HBF Casegood Accessories.

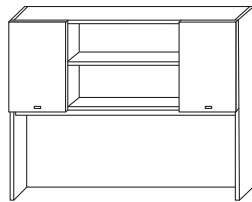

AS63M2-PNP		4620	4989	5543	72	15 3/4	56	312
------------	--	------	------	------	----	--------	----	-----

Veneer species must be noted on each line item

Flush top without profile edge detail, finished wood panel. Open center storage, one adjustable shelf. Cabinet back unfinished. Optional task lights available, see HBF Casegood Accessories.

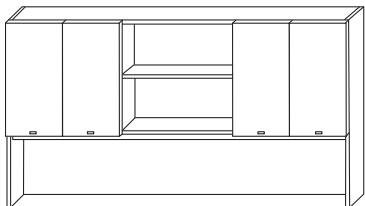

AS63N2-PNP		5268	5690	6322	78	15 3/4	56	319
AS63P2-PNP		5526	5968	6631	84	15 3/4	56	326
AS63R2-PNP		5742	6202	6891	90	15 3/4	56	379
AS63S2-PNP		5989	6469	7187	96	15 3/4	56	391
AS63T2-PNP		6237	6736	7484	102	15 3/4	56	405
AS63U2-PNP		6463	6980	7756	108	15 3/4	56	416
AS63V2-PNP		6700	7236	8040	114	15 3/4	56	441
AS63W2-PNP		6937	7492	8324	120	15 3/4	56	456

Veneer species must be noted on each line item

Flush top without profile edge detail, finished wood panel. Open center storage, one adjustable shelf. Cabinet back unfinished. Optional task lights available, see HBF Casegood Accessories.

Double high overhead cabinets to be used with double high vertical cabinets.

Veneer species must be noted on each line item

Veneer Grade 1	Veneer Grade 2	Veneer Grade 3
Cherry	Rift Oak	Anigre
Maple	Sapele	
Ligno-Grain		
Walnut		

HBF Ashton Casegoods - Overhead Cabinets

Style Number	Fabric	List Price			Dimensions			Weight
		Veneer 1	Veneer 2	Veneer 3	OW	OD	OH	

Overhead Cabinets, Top without Profile Edge Detail, Wood Panel Support (Double High)

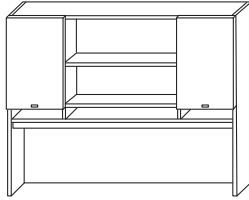

AS62M2-PWP	3 yds	4795	5178	5754	72	15 3/4	56	312
------------	-------	------	------	------	----	--------	----	-----

Veneer species must be noted on each line item

Flush top without profile edge detail, fabric tack panel (fabric not included, COM must be acrylic backed). Open center storage, one adjustable shelf, open project shelf storage 3" high. Cabinet back unfinished. Optional task lights available, see HBF Casegood Accessories.

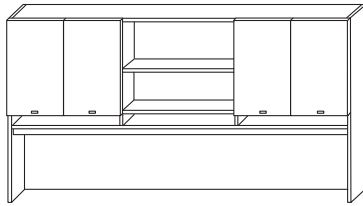

AS62N2-PWP	3 yds	5485	5924	6582	78	15 3/4	56	319
AS62P2-PWP	3 yds	5732	6191	6878	84	15 3/4	56	326
AS62R2-PWP	3 yds	5979	6457	7175	90	15 3/4	56	379
AS62S2-PWP	3 1/4 yds	6216	6713	7459	96	15 3/4	56	391
AS62T2-PWP	3 1/2 yds	6474	6991	7768	102	15 3/4	56	405
AS62U2-PWP	3 3/4 yds	6721	7258	8065	108	15 3/4	56	416
AS62V2-PWP	4 1/4 yds	6958	7514	8349	114	15 3/4	56	441
AS62W2-PWP	4 1/4 yds	7195	7770	8633	120	15 3/4	56	456

Veneer species must be noted on each line item

Flush top without profile edge detail, fabric tack panel (fabric not included, COM must be acrylic backed). Open center storage, one adjustable shelf, open project shelf storage 3" high. Cabinet back unfinished. Optional task lights available, see HBF Casegood Accessories.

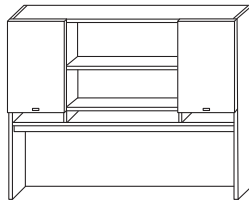

AS63M2-PWP		5104	5512	6124	72	15 3/4	56	312
------------	--	------	------	------	----	--------	----	-----

Veneer species must be noted on each line item

Flush top without profile edge detail, finished wood panel. Open center storage, one adjustable shelf, open project shelf storage 3" high. Cabinet back unfinished. Optional task lights available, see HBF Casegood Accessories.

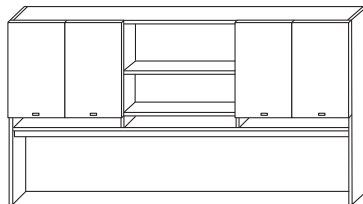

AS63N2-PWP		5825	6291	6990	78	15 3/4	56	319
AS63P2-PWP		6103	6591	7323	84	15 3/4	56	326
AS63R2-PWP		6350	6858	7620	90	15 3/4	56	379
AS63S2-PWP		6618	7147	7941	96	15 3/4	56	391
AS63T2-PWP		6896	7448	8275	102	15 3/4	56	405
AS63U2-PWP		7143	7714	8572	108	15 3/4	56	416
AS63V2-PWP		7380	7970	8856	114	15 3/4	56	441
AS63W2-PWP		7617	8226	9140	120	15 3/4	56	456

Veneer species must be noted on each line item

Flush top without profile edge detail, finished wood panel. Open center storage, one adjustable shelf, open project shelf storage 3" high. Cabinet back unfinished. Optional task lights available, see HBF Casegood Accessories.

Double high overhead cabinets to be used with double high vertical cabinets.

Veneer species must be noted on each line item

Veneer Grade 1	Veneer Grade 2	Veneer Grade 3
Cherry	Rift Oak	Anigre
Maple	Sapele	
Ligno-Grain		
Walnut		

HBF Ashton Casegoods - Overhead Cabinets

Style Number	Fabric	List Price			Dimensions			Weight
		Veneer 1	Veneer 2	Veneer 3	OW	OD	OH	

Overhead Cabinets, Top with Profile Edge Detail, Wood Panel Support

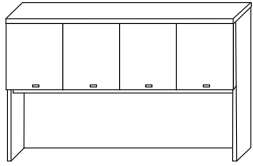

AS62A-FNP	3 yds	3651	3943	4382	72	15 3/4	43 5/8	282
-----------	-------	------	------	------	----	--------	--------	-----

Veneer species must be noted on each line item

Top with profile edge detail, fabric tack panel (fabric not included, COM must be acrylic backed), cabinet back unfinished. Optional task lights available, see HBF Casegood Accessories.

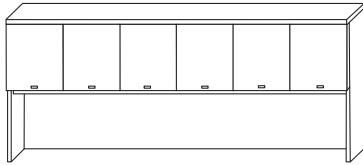

AS62F-FNP	3 yds	4166	4500	5000	78	15 3/4	43 5/8	289
AS62B-FNP	3 yds	4362	4711	5234	84	15 3/4	43 5/8	296
AS62C-FNP	3 yds	4547	4911	5457	90	15 3/4	43 5/8	339
AS62D-FNP	3 1/4 yds	4733	5111	5679	96	15 3/4	43 5/8	351
AS62G-FNP	3 1/2 yds	4929	5323	5914	102	15 3/4	43 5/8	365
AS62E-FNP	3 3/4 yds	5114	5523	6137	108	15 3/4	43 5/8	376
AS62H-FNP	4 1/4 yds	5299	5723	6359	114	15 3/4	43 5/8	391
AS62J-FNP	4 1/4 yds	5485	5924	6582	120	15 3/4	43 5/8	406

Veneer species must be noted on each line item

Top with profile edge detail, fabric tack panel (fabric not included, COM must be acrylic backed), cabinet back unfinished. Optional task lights available, see HBF Casegood Accessories.

Overhead Cabinets, Top with Profile Edge Detail, Wood Panel Support

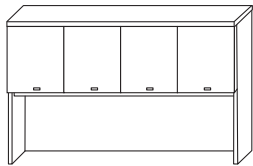

AS63A-FNP		3888	4199	4666	72	15 3/4	43 5/8	282
-----------	--	------	------	------	----	--------	--------	-----

Veneer species must be noted on each line item

Top with profile edge detail, finished wood panel, cabinet back unfinished. Optional task lights available, see HBF Casegood Accessories.

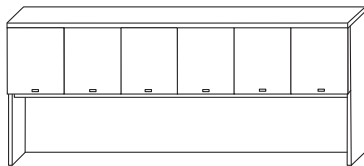

AS63F-FNP		4434	4789	5321	78	15 3/4	43 5/8	289
AS63B-FNP		4650	5022	5581	84	15 3/4	43 5/8	296
AS63C-FNP		4836	5223	5803	90	15 3/4	43 5/8	339
AS63D-FNP		5032	5434	6038	96	15 3/4	43 5/8	351
AS63G-FNP		5248	5668	6297	102	15 3/4	43 5/8	365
AS63E-FNP		5433	5868	6520	108	15 3/4	43 5/8	376
AS63H-FNP		5619	6068	6742	114	15 3/4	43 5/8	391
AS63J-FNP		5804	6268	6965	120	15 3/4	43 5/8	406

Veneer species must be noted on each line item

Top with profile edge detail, finished wood panel, cabinet back unfinished. Optional task lights available, see HBF Casegood Accessories.

Veneer species must be noted on each line item

Veneer Grade 1	Veneer Grade 2	Veneer Grade 3
Cherry	Rift Oak	Anigre
Maple	Sapele	
Ligno-Grain		
Walnut		

HBF Ashton Casegoods - Overhead Cabinets

Style Number	Fabric	List Price			Dimensions			Weight
		Veneer 1	Veneer 2	Veneer 3	OW	OD	OH	

Overhead Cabinets, Top with Profile Edge Detail, Wood Panel Support

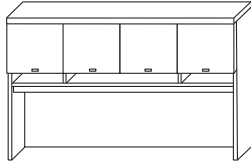

AS62A-FWP	3 yds	4012	4333	4814	72	15 3/4	43 5/8	282
-----------	-------	------	------	------	----	--------	--------	-----

Veneer species must be noted on each line item

Top with profile edge detail, fabric tack panel. Open project shelf storage 3" high. Cabinet back unfinished. Optional task lights available, see HBF Casegood Accessories.

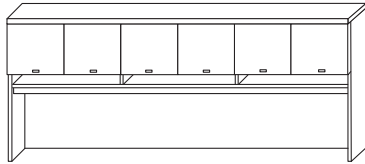

AS62F-FWP	3 yds	4589	4956	5506	78	15 3/4	43 5/8	289
AS62B-FWP	3 yds	4805	5189	5766	84	15 3/4	43 5/8	296
AS62C-FWP	3 yds	5001	5401	6001	90	15 3/4	43 5/8	339
AS62D-FWP	3 1/4 yds	5207	5623	6248	96	15 3/4	43 5/8	351
AS62G-FWP	3 1/2 yds	5423	5857	6508	102	15 3/4	43 5/8	365
AS62E-FWP	3 3/4 yds	5619	6068	6742	108	15 3/4	43 5/8	376
AS62H-FWP	4 1/4 yds	5804	6268	6965	114	15 3/4	43 5/8	391
AS62J-FWP	4 1/4 yds	5989	6469	7187	120	15 3/4	43 5/8	406

Veneer species must be noted on each line item

Top with profile edge detail, fabric tack panel. Open project shelf storage 3" high. Cabinet back unfinished. Optional task lights available, see HBF Casegood Accessories.

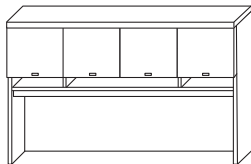

AS63A-FWP		4280	4622	5136	72	15 3/4	43 5/8	282
-----------	--	------	------	------	----	--------	--------	-----

Veneer species must be noted on each line item

Top with profile edge detail, finished wood panel. Open project shelf storage 3" high. Cabinet back unfinished. Optional task lights available, see HBF Casegood Accessories.

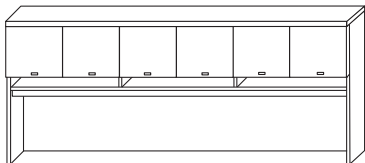

AS63F-FWP		4877	5267	5852	78	15 3/4	43 5/8	289
AS63B-FWP		4836	5223	5803	84	15 3/4	43 5/8	296
AS63C-FWP		5320	5746	6384	90	15 3/4	43 5/8	339
AS63D-FWP		5536	5979	6644	96	15 3/4	43 5/8	351
AS63G-FWP		5773	6235	6928	102	15 3/4	43 5/8	365
AS63E-FWP		5979	6457	7175	108	15 3/4	43 5/8	376
AS63H-FWP		6165	6658	7397	114	15 3/4	43 5/8	391
AS63J-FWP		6350	6858	7620	120	15 3/4	43 5/8	406

Veneer species must be noted on each line item

Top with profile edge detail, finished wood panel. Open project shelf storage 3" high. Cabinet back unfinished. Optional task lights available, see HBF Casegood Accessories.

Veneer species must be noted on each line item

Veneer Grade 1	Veneer Grade 2	Veneer Grade 3
Cherry	Rift Oak	Anigre
Maple	Sapele	
Ligno-Grain		
Walnut		

HBF Ashton Casegoods - Overhead Cabinets

Style Number	Fabric	List Price			Dimensions			Weight
		Veneer 1	Veneer 2	Veneer 3	OW	OD	OH	

Overhead Cabinets, Top with Profile Edge Detail, Wood Panel Support

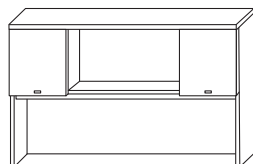

AS62A-PNP	3 yds	3466	3743	4159	72	15 3/4	43 5/8	282
-----------	-------	------	------	------	----	--------	--------	-----

Veneer species must be noted on each line item

Top with profile edge detail, fabric tack panel (fabric not included, COM must be acrylic backed). Open center storage. Cabinet back unfinished. Optional task lights available, see HBF Casegood Accessories.

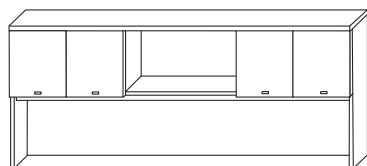

AS62F-PNP	3 yds	3960	4277	4752	78	15 3/4	43 5/8	289
AS62B-PNP	3 yds	4146	4477	4975	84	15 3/4	43 5/8	296
AS62C-PNP	3 yds	4321	4667	5185	90	15 3/4	43 5/8	339
AS62D-PNP	3 1/4 yds	4496	4856	5395	96	15 3/4	43 5/8	351
AS62G-PNP	3 1/2 yds	4681	5056	5618	102	15 3/4	43 5/8	365
AS62E-PNP	3 3/4 yds	4856	5245	5828	108	15 3/4	43 5/8	376
AS62H-PNP	4 1/4 yds	5042	5445	6050	114	15 3/4	43 5/8	391
AS62J-PNP	4 1/4 yds	5227	5645	6273	120	15 3/4	43 5/8	406

Veneer species must be noted on each line item

Top with profile edge detail, fabric tack panel (fabric not included, COM must be acrylic backed). Open center storage. Cabinet back unfinished. Optional task lights available, see HBF Casegood Accessories.

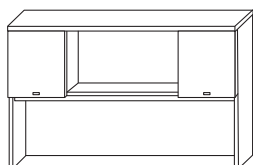

AS63A-PNP		3693	3988	4431	72	15 3/4	43 5/8	282
-----------	--	------	------	------	----	--------	--------	-----

Veneer species must be noted on each line item

Top with profile edge detail, finished wood panel. Open center storage. Cabinet back unfinished. Optional task lights available, see HBF Casegood Accessories.

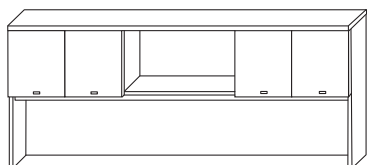

AS63F-PNP		4208	4544	5049	78	15 3/4	43 5/8	289
AS63B-PNP		4414	4767	5296	84	15 3/4	43 5/8	296
AS63C-PNP		4589	4956	5506	90	15 3/4	43 5/8	339
AS63D-PNP		4784	5167	5714	96	15 3/4	43 5/8	351
AS63G-PNP		4990	5390	5988	102	15 3/4	43 5/8	365
AS63E-PNP		5165	5579	6199	108	15 3/4	43 5/8	376
AS63H-PNP		5351	5779	6421	114	15 3/4	43 5/8	391
AS63J-PNP		5536	5979	6644	120	15 3/4	43 5/8	406

Veneer species must be noted on each line item

Top with profile edge detail, finished wood panel. Open center storage. Cabinet back unfinished. Optional task lights available, see HBF Casegood Accessories.

Veneer species must be noted on each line item

<u>Veneer Grade 1</u>	<u>Veneer Grade 2</u>	<u>Veneer Grade 3</u>
Cherry	Rift Oak	Anigre
Maple	Sapele	
Ligno-Grain		
Walnut		

HBF Ashton Casegoods - Overhead Cabinets

Style Number	Fabric	List Price			Dimensions			Weight
		Veneer 1	Veneer 2	Veneer 3	OW	OD	OH	

Overhead Cabinets, Top with Profile Edge Detail, Wood Panel Support

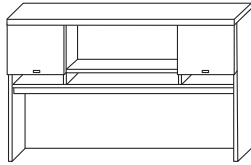

AS62A-PWP	3 yds	3826	4133	4592	72	15 3/4	43 5/8	282
------------------	-------	-------------	-------------	-------------	----	--------	--------	-----

Veneer species must be noted on each line item

Top with profile edge detail, fabric tack panel (fabric not included, COM must be acrylic backed). Open project shelf storage and open center storage 3" high. Cabinet back unfinished. Optional task lights available, see HBF Casegood Accessories.

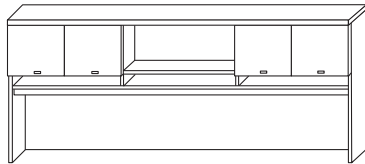

AS62F-PWP	3 yds	4383	4733	5259	78	15 3/4	43 5/8	289
AS62B-PWP	3 yds	4589	4956	5506	84	15 3/4	43 5/8	296
AS62C-PWP	3 yds	4774	5156	5729	90	15 3/4	43 5/8	339
AS62D-PWP	3 1/4 yds	4970	5367	5964	96	15 3/4	43 5/8	351
AS62G-PWP	3 1/2 yds	5176	5590	6211	102	15 3/4	43 5/8	365
AS62E-PWP	3 3/4 yds	5371	5801	6446	108	15 3/4	43 5/8	376
AS62H-PWP	4 1/4 yds	5557	6001	6668	114	15 3/4	43 5/8	391
AS62J-PWP	4 1/4 yds	5742	6202	6891	120	15 3/4	43 5/8	406

Veneer species must be noted on each line item

Top with profile edge detail, fabric tack panel (fabric not included, COM must be acrylic backed). Open project shelf storage and open center storage 3" high. Cabinet back unfinished. Optional task lights available, see HBF Casegood Accessories.

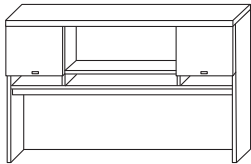

AS63A-PWP		4084	4411	4901	72	15 3/4	43 5/8	282
------------------	--	-------------	-------------	-------------	----	--------	--------	-----

Veneer species must be noted on each line item

Top with profile edge detail, finished wood panel. Open project shelf storage and open center storage 3" high. Cabinet back unfinished. Optional task lights available, see HBF Casegood Accessories.

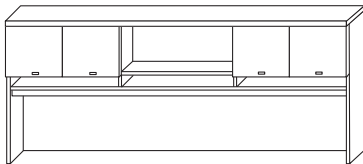

AS63F-PWP		4650	5022	5581	78	15 3/4	43 5/8	289
AS63B-PWP		4877	5267	5852	84	15 3/4	43 5/8	296
AS63C-PWP		5073	5479	6087	90	15 3/4	43 5/8	339
AS63D-PWP		5289	5712	6347	96	15 3/4	43 5/8	351
AS63G-PWP		5516	5957	6619	102	15 3/4	43 5/8	365
AS63E-PWP		5711	6168	6854	108	15 3/4	43 5/8	376
AS63H-PWP		5897	6368	7076	114	15 3/4	43 5/8	391
AS63J-PWP		6082	6569	7299	120	15 3/4	43 5/8	406

Veneer species must be noted on each line item

Top with profile edge detail, finished wood panel. Open project shelf storage and open center storage 3" high. Cabinet back unfinished. Optional task lights available, see HBF Casegood Accessories.

Veneer species must be noted on each line item

<u>Veneer Grade 1</u>	<u>Veneer Grade 2</u>	<u>Veneer Grade 3</u>
Cherry	Rift Oak	Anigre
Maple	Sapele	
Ligno-Grain		
Walnut		

HBF Ashton Casegoods - Overhead Cabinets

Style Number	Fabric	List Price			Dimensions			Weight
		Veneer 1	Veneer 2	Veneer 3	OW	OD	OH	

Overhead Cabinets, Top with Profile Edge Detail, Wood Panel Support (Double High)

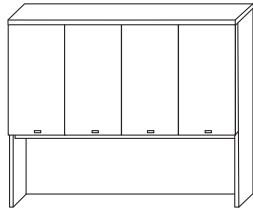

AS62A2-FNP	3 yds	4929	5323	5914	72	15 3/4	57 3/8	282
------------	-------	------	------	------	----	--------	--------	-----

Veneer species must be noted on each line item

Top with profile edge detail, one adjustable shelf, fabric tack panel (fabric not included, COM must be acrylic backed). Cabinet back unfinished. Optional task lights available, see HBF Casegood Accessories.

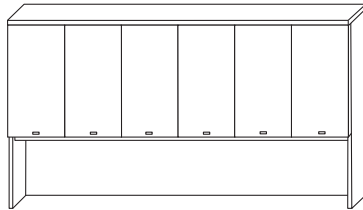

AS62F2-FNP	3 yds	5639	6090	6767	78	15 3/4	57 3/8	289
AS62B2-FNP	3 yds	5897	6368	7076	84	15 3/4	57 3/8	296
AS62C2-FNP	3 yds	6144	6635	7373	90	15 3/4	57 3/8	339
AS62D2-FNP	3 1/4 yds	6401	6914	7682	96	15 3/4	57 3/8	351
AS62G2-FNP	3 1/2 yds	6659	7192	7991	102	15 3/4	57 3/8	365
AS62E2-FNP	3 3/4 yds	6906	7459	8287	108	15 3/4	57 3/8	376
AS62H2-FNP	4 1/4 yds	7143	7714	8572	114	15 3/4	57 3/8	391
AS62J2-FNP	4 1/4 yds	7380	7970	8856	120	15 3/4	57 3/8	406

Veneer species must be noted on each line item

Top with profile edge detail, one adjustable shelf, fabric tack panel (fabric not included, COM must be acrylic backed). Cabinet back unfinished. Optional task lights available, see HBF Casegood Accessories.

Overhead Cabinets, Top with Profile Edge Detail, Wood Panel Support

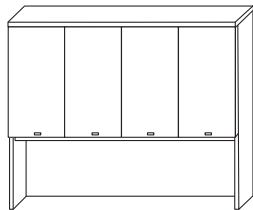

AS63A2-FNP		5258	5679	6310	72	15 3/4	57 3/8	312
------------	--	------	------	------	----	--------	--------	-----

Veneer species must be noted on each line item

Top with profile edge detail, one adjustable shelf, finished wood panel. Cabinet back unfinished. Optional task lights available, see HBF Casegood Accessories.

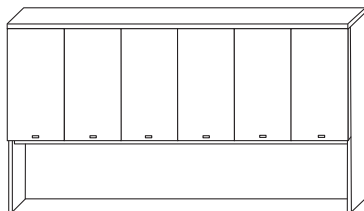

AS63F2-FNP		5989	6469	7187	78	15 3/4	57 3/8	319
AS63B2-FNP		6278	6780	7533	84	15 3/4	57 3/8	326
AS63C2-FNP		6535	7058	7842	90	15 3/4	57 3/8	379
AS63D2-FNP		6803	7347	8164	96	15 3/4	57 3/8	391
AS63G2-FNP		7092	7659	8510	102	15 3/4	57 3/8	405
AS63E2-FNP		7349	7937	8819	108	15 3/4	57 3/8	416
AS63H2-FNP		7586	8193	9103	114	15 3/4	57 3/8	441
AS63J2-FNP		7823	8449	9387	120	15 3/4	57 3/8	456

Veneer species must be noted on each line item

Top with profile edge detail, one adjustable shelf, finished wood panel, Cabinet back unfinished. Optional task lights available, see HBF Casegood Accessories.

Double high overhead cabinets to be used with double high vertical cabinets.

Veneer species must be noted on each line item

<u>Veneer Grade 1</u>	<u>Veneer Grade 2</u>	<u>Veneer Grade 3</u>
Cherry	Rift Oak	Anigre
Maple	Sapele	
Ligno-Grain		
Walnut		

HBF Ashton Casegoods - Overhead Cabinets

Style Number	Fabric	List Price			Dimensions			Weight
		Veneer 1	Veneer 2	Veneer 3	OW	OD	OH	

Overhead Cabinets, Top with Profile Edge Detail, Wood Panel Support (Double High)

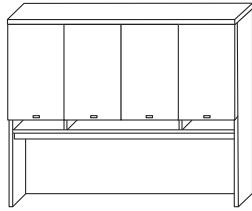

AS62A2-FWP	3 yds	5423	5857	6508	72	15 3/4	57 3/8	312
------------	-------	------	------	------	----	--------	--------	-----

Veneer species must be noted on each line item

Top with profile edge detail, one adjustable shelf, fabric tack panel, (fabric not included, COM must be acrylic backed). Open project shelf storage 3" high. Cabinet back unfinished. Optional task lights available, see HBF Casegood Accessories.

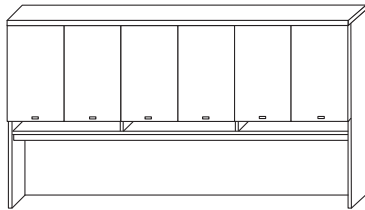

AS62F2-FWP	3 yds	6195	6691	7435	78	15 3/4	57 3/8	319
AS62B2-FWP	3 yds	6494	7014	7793	84	15 3/4	57 3/8	326
AS62C2-FWP	3 yds	6762	7303	8114	90	15 3/4	57 3/8	379
AS62D2-FWP	3 1/4 yds	7040	7603	8448	96	15 3/4	57 3/8	391
AS62G2-FWP	3 1/2 yds	7328	7915	8794	102	15 3/4	57 3/8	405
AS62E2-FWP	3 3/4 yds	7596	8204	9116	108	15 3/4	57 3/8	416
AS62H2-FWP	4 1/4 yds	7833	8460	9400	114	15 3/4	57 3/8	441
AS62J2-FWP	4 1/4 yds	8070	8716	9684	120	15 3/4	57 3/8	456

Veneer species must be noted on each line item

Top with profile edge detail, one adjustable shelf, fabric tack panel, (fabric not included, COM must be acrylic backed). Open project shelf storage 3" high. Cabinet back unfinished. Optional task lights available, see HBF Casegood Accessories.

Overhead Cabinets, Top with Profile Edge Detail, Wood Panel Support

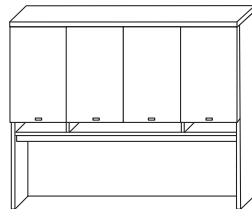

AS63A2-FWP		5783	6246	6940	72	15 3/4	57 3/8	312
------------	--	------	------	------	----	--------	--------	-----

Veneer species must be noted on each line item

Top with profile edge detail, one adjustable shelf, finished wood panel. Open project shelf storage 3" high. Cabinet back unfinished. Optional task lights available, see HBF Casegood Accessories.

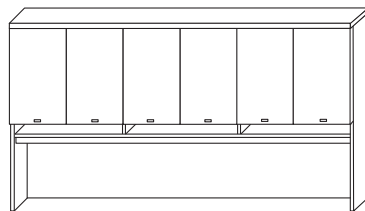

AS63F2-FWP		6587	7114	7904	78	15 3/4	57 3/8	319
AS63B2-FWP		6906	7459	8287	84	15 3/4	57 3/8	326
AS63C2-FWP		7184	7759	8621	90	15 3/4	57 3/8	379
AS63D2-FWP		7483	8082	8980	96	15 3/4	57 3/8	391
AS63G2-FWP		7802	8426	9363	102	15 3/4	57 3/8	405
AS63E2-FWP		8080	8727	9696	108	15 3/4	57 3/8	416
AS63H2-FWP		8317	8983	9981	114	15 3/4	57 3/8	441
AS63J2-FWP		8554	9238	10265	120	15 3/4	57 3/8	456

Veneer species must be noted on each line item

Top with profile edge detail, one adjustable shelf, finished wood panel. Open project shelf storage 3" high. Cabinet back unfinished. Optional task lights available, see HBF Casegood Accessories.

Double high overhead cabinets to be used with double high vertical cabinets.

Veneer species must be noted on each line item

Veneer Grade 1	Veneer Grade 2	Veneer Grade 3
Cherry	Rift Oak	Anigre
Maple	Sapele	
Ligno-Grain		
Walnut		

HBF Ashton Casegoods - Overhead Cabinets

Style Number	Fabric	List Price			Dimensions			Weight
		Veneer 1	Veneer 2	Veneer 3	OW	OD	OH	

Overhead Cabinets, Top with Profile Edge Detail, Wood Panel Support (Double High)

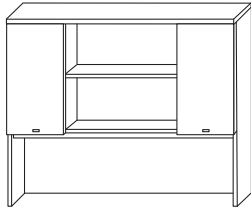

AS62A2-PNP	3 yds	4681	5056	5618	72	15 3/4	57 3/8	312
------------	-------	------	------	------	----	--------	--------	-----

Veneer species must be noted on each line item

Top with profile edge detail, fabric tack panel (fabric not included, COM must be acrylic backed). Open center storage, one adjustable shelf. Cabinet back unfinished. Optional task lights available, see HBF Casegood Accessories.

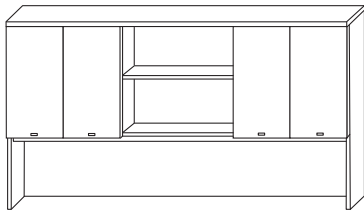

AS62F2-PNP	3 yds	5361	5790	6433	78	15 3/4	57 3/8	319
AS62B2-PNP	3 yds	5608	6057	6730	84	15 3/4	57 3/8	326
AS62C2-PNP	3 yds	5845	6313	7014	90	15 3/4	57 3/8	379
AS62D2-PNP	3 1/4 yds	6082	6569	7299	96	15 3/4	57 3/8	391
AS62G2-PNP	3 1/2 yds	6329	6836	7595	102	15 3/4	57 3/8	405
AS62E2-PNP	3 3/4 yds	6566	7092	7880	108	15 3/4	57 3/8	416
AS62H2-PNP	4 1/4 yds	6803	7347	8164	114	15 3/4	57 3/8	441
AS62J2-PNP	4 1/4 yds	7040	7603	8448	120	15 3/4	57 3/8	456

Veneer species must be noted on each line item

Top with profile edge detail, fabric tack panel (fabric not included, COM must be acrylic backed). Open center storage, one adjustable shelf. Cabinet back unfinished. Optional task lights available, see HBF Casegood Accessories.

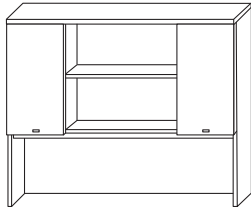

AS63A2-PNP		4990	5390	5988	72	15 3/4	57 3/8	312
------------	--	------	------	------	----	--------	--------	-----

Veneer species must be noted on each line item

Top with profile edge detail, finished wood panel. Open center storage, one adjustable shelf. Cabinet back unfinished. Optional task lights available, see HBF Casegood Accessories.

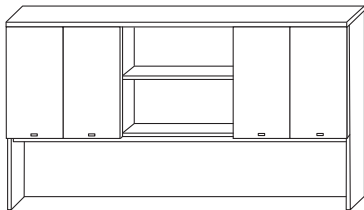

AS63F2-PNP		5691	6146	6829	78	15 3/4	57 3/8	319
AS63B2-PNP		5959	6435	7150	84	15 3/4	57 3/8	326
AS63C2-PNP		6206	6702	7447	90	15 3/4	57 3/8	379
AS63D2-PNP		6463	6980	7756	96	15 3/4	57 3/8	391
AS63G2-PNP		6741	7281	8090	102	15 3/4	57 3/8	405
AS63E2-PNP		6978	7537	8374	108	15 3/4	57 3/8	416
AS63H2-PNP		7215	7792	8658	114	15 3/4	57 3/8	441
AS63J2-PNP		7452	8048	8942	120	15 3/4	57 3/8	456

Veneer species must be noted on each line item

Top with profile edge detail, finished wood panel. Open center storage, one adjustable shelf. Cabinet back unfinished. Optional task lights available, see HBF Casegood Accessories.

Double high overhead cabinets to be used with double high vertical cabinets.

Veneer species must be noted on each line item

Veneer Grade 1	Veneer Grade 2	Veneer Grade 3
Cherry	Rift Oak	Anigre
Maple	Sapele	
Ligno-Grain		
Walnut		

HBF Ashton Casegoods - Overhead Cabinets

Style Number	Fabric	List Price			Dimensions			Weight
		Veneer 1	Veneer 2	Veneer 3	OW	OD	OH	

Overhead Cabinets, Top with Profile Edge Detail, Wood Panel Support (Double High)

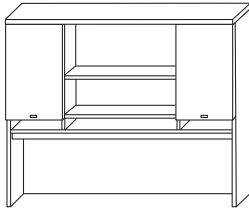

AS62A2-PWP	3 yds	5176	5590	6211	72	15 3/4	57 3/8	312
------------	-------	------	------	------	----	--------	--------	-----

Veneer species must be noted on each line item

Top with profile edge detail, fabric tack panel (fabric not included, COM must be acrylic backed). Open center storage, one adjustable shelf, open project shelf storage 3" high. Cabinet back unfinished. Optional task lights available, see HBF Casegood Accessories.

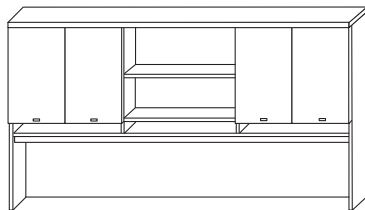

AS62F2-PWP	3 yds	5917	6391	7101	78	15 3/4	57 3/8	319
AS62B2-PWP	3 yds	6195	6691	7435	84	15 3/4	57 3/8	326
AS62C2-PWP	3 yds	6453	6969	7744	90	15 3/4	57 3/8	379
AS62D2-PWP	3 1/4 yds	6721	7258	8065	96	15 3/4	57 3/8	391
AS62G2-PWP	3 1/2 yds	6989	7548	8386	102	15 3/4	57 3/8	405
AS62E2-PWP	3 3/4 yds	7256	7837	8708	108	15 3/4	57 3/8	416
AS62H2-PWP	4 1/4 yds	7493	8093	8992	114	15 3/4	57 3/8	441
AS62J2-PWP	4 1/4 yds	7730	8349	9276	120	15 3/4	57 3/8	456

Veneer species must be noted on each line item

Top with profile edge detail, fabric tack panel (fabric not included, COM must be acrylic backed). Open center storage, one adjustable shelf, open project shelf storage 3" high. Cabinet back unfinished. Optional task lights available, see HBF Casegood Accessories.

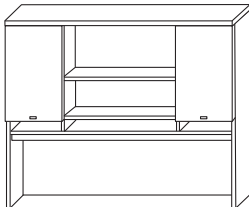

AS63A2-PWP		5516	5957	6619	72	15 3/4	57 3/8	312
------------	--	------	------	------	----	--------	--------	-----

Veneer species must be noted on each line item

Top with profile edge detail, finished wood panel. Open center storage, one adjustable shelf, open project shelf storage 3" high. Cabinet back unfinished. Optional task lights available, see HBF Casegood Accessories.

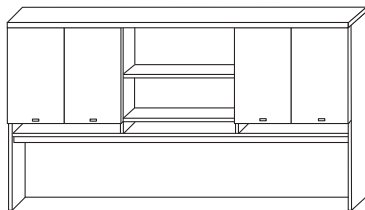

AS63F2-PWP		6288	6791	7546	78	15 3/4	57 3/8	319
AS63B2-PWP		6597	7125	7917	84	15 3/4	57 3/8	326
AS63C2-PWP		6865	7414	8238	90	15 3/4	57 3/8	379
AS63D2-PWP		7143	7714	8572	96	15 3/4	57 3/8	391
AS63G2-PWP		7452	8048	8942	102	15 3/4	57 3/8	405
AS63E2-PWP		7720	8337	9264	108	15 3/4	57 3/8	416
AS63H2-PWP		7957	8593	9548	114	15 3/4	57 3/8	441
AS63J2-PWP		8194	8849	9832	120	15 3/4	57 3/8	456

Veneer species must be noted on each line item

Top with profile edge detail, finished wood panel. Open center storage, one adjustable shelf, open project shelf storage 3" high. Cabinet back unfinished. Optional task lights available, see HBF Casegood Accessories.

Double high overhead cabinets to be used with double high vertical cabinets.

Veneer species must be noted on each line item

Veneer Grade 1	Veneer Grade 2	Veneer Grade 3
Cherry	Rift Oak	Anigre
Maple	Sapele	
Ligno-Grain		
Walnut		

HBF Ashton Casegoods - Overhead Cabinets

Style Number	Fabric	List Price			Dimensions			Weight
		Veneer 1	Veneer 2	Veneer 3	OW	OD	OH	

Overhead Cabinets, Top without Profile Edge Detail

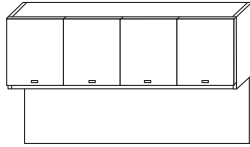

AS64M-FNP	3 yds	3178	3432	3813	72	15 3/4	42 1/4	195
-----------	-------	------	------	------	----	--------	--------	-----

Veneer species must be noted on each line item

Wall mount, flush top without profile edge detail, fabric tack panel (fabric not included, COM must be acrylic backed), cabinet back unfinished. Optional task lights available, see HBF Casegood Accessories.

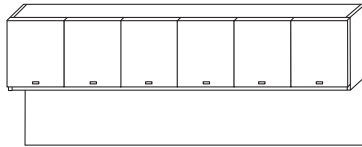

AS64N-FNP	3 yds	3651	3943	4382	78	15 3/4	42 1/4	215
AS64P-FNP	3 yds	3837	4144	4604	84	15 3/4	42 1/4	215
AS64R-FNP	3 yds	4002	4322	4802	90	15 3/4	42 1/4	225
AS64S-FNP	3 1/4 yds	4177	4511	5012	96	15 3/4	42 1/4	225
AS64T-FNP	3 1/2 yds	4362	4711	5234	102	15 3/4	42 1/4	235
AS64U-FNP	3 3/4 yds	4527	4889	5432	108	15 3/4	42 1/4	235
AS64V-FNP	4 1/4 yds	4712	5089	5655	114	15 3/4	42 1/4	245
AS64W-FNP	4 1/4 yds	4898	5289	5877	120	15 3/4	42 1/4	245

Veneer species must be noted on each line item

Wall mount, flush top without profile edge detail, fabric tack panel (fabric not included, COM must be acrylic backed), cabinet back unfinished. Optional task lights available, see HBF Casegood Accessories.

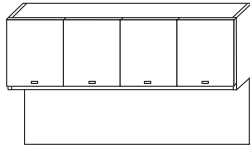

AS65M-FNP		3394	3665	4073	72	15 3/4	42 1/4	195
-----------	--	------	------	------	----	--------	--------	-----

Veneer species must be noted on each line item

Wall mount, flush top without profile edge detail, finished wood panel, cabinet back unfinished. Optional task lights available, see HBF Casegood Accessories.

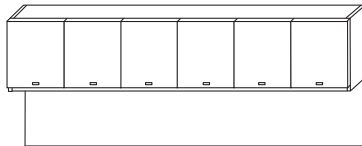

AS65N-FNP		3899	4210	4678	78	15 3/4	42 1/4	215
AS65P-FNP		4094	4422	4913	84	15 3/4	42 1/4	215
AS65R-FNP		4269	4611	5123	90	15 3/4	42 1/4	225
AS65S-FNP		4455	4811	5346	96	15 3/4	42 1/4	225
AS65T-FNP		4650	5022	5581	102	15 3/4	42 1/4	235
AS65U-FNP		4826	5212	5791	108	15 3/4	42 1/4	235
AS65V-FNP		5011	5412	6013	114	15 3/4	42 1/4	245
AS65W-FNP		5196	5612	6236	120	15 3/4	42 1/4	245

Veneer species must be noted on each line item

Wall mount, flush top without profile edge detail, finished wood panel, cabinet back unfinished. Optional task lights available, see HBF Casegood Accessories.

Installation and maintenance of wall mounted overhead cabinets are the sole responsibility of the customer. Proper installation is crucial to prevent personal injury.

HBF Ashton Casegoods - Overhead Cabinets

Style Number	Fabric	List Price			Dimensions			Weight
		Veneer 1	Veneer 2	Veneer 3	OW	OD	OH	

Overhead Cabinets, Top without Profile Edge Detail

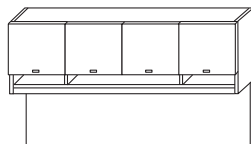

AS64M-FWP	3 yds	3517	3799	4221	72	15 3/4	42 1/4	195
-----------	-------	------	------	------	----	--------	--------	-----

Veneer species must be noted on each line item

Wall mount, flush top without profile edge detail, fabric tack panel (fabric not included, COM must be acrylic backed). Open project shelf storage 3" high. Cabinet back unfinished. Optional task lights available, see HBF Casegood Accessories.

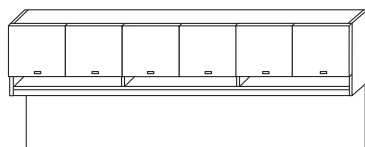

AS64N-FWP	3 yds	4043	4366	4851	78	15 3/4	42 1/4	215
AS64P-FWP	3 yds	4238	4578	5086	84	15 3/4	42 1/4	215
AS64R-FWP	3 yds	4424	4778	5309	90	15 3/4	42 1/4	225
AS64S-FWP	3 1/4 yds	4620	4989	5543	96	15 3/4	42 1/4	225
AS64T-FWP	3 1/2 yds	4815	5200	5778	102	15 3/4	42 1/4	235
AS64U-FWP	3 3/4 yds	5001	5401	6001	108	15 3/4	42 1/4	235
AS64V-FWP	4 1/4 yds	5186	5601	6223	114	15 3/4	42 1/4	245
AS64W-FWP	4 1/4 yds	5371	5801	6446	120	15 3/4	42 1/4	245

Veneer species must be noted on each line item

Wall mount, flush top without profile edge detail, fabric tack panel (fabric not included, COM must be acrylic backed). Open project shelf storage 3" high. Cabinet back unfinished. Optional task lights available, see HBF Casegood Accessories.

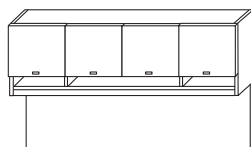

AS65M-FWP		3754	4055	4505	72	15 3/4	42 1/4	195
-----------	--	------	------	------	----	--------	--------	-----

Veneer species must be noted on each line item

Wall mount, flush top without profile edge detail, finished wood panel. Open project shelf storage 3" high. Cabinet back unfinished. Optional task lights available, see HBF Casegood Accessories.

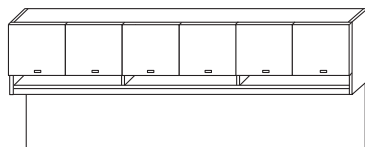

AS65N-FWP		4311	4655	5173	78	15 3/4	42 1/4	215
AS65P-FWP		4527	4889	5432	84	15 3/4	42 1/4	215
AS65R-FWP		4723	5100	5667	90	15 3/4	42 1/4	225
AS65S-FWP		4929	5323	5914	96	15 3/4	42 1/4	225
AS65T-FWP		5145	5556	6174	102	15 3/4	42 1/4	235
AS65U-FWP		5330	5757	6396	108	15 3/4	42 1/4	235
AS65V-FWP		5516	5957	6619	114	15 3/4	42 1/4	245
AS65W-FWP		5701	6157	6841	120	15 3/4	42 1/4	245

Veneer species must be noted on each line item

Wall mount, flush top without profile edge detail, finished wood panel. Open project shelf storage 3" high. Cabinet back unfinished. Optional task lights available, see HBF Casegood Accessories.

**Installation and maintenance of wall mounted overhead cabinets are the sole responsibility of the customer.
Proper installation is crucial to prevent personal injury.**

Veneer species must be noted on each line item

Veneer Grade 1	Veneer Grade 2	Veneer Grade 3
Cherry	Rift Oak	Anigre
Maple	Sapele	
Ligno-Grain		
Walnut		

HBF Ashton Casegoods - Overhead Cabinets

Style Number	Fabric	List Price			Dimensions			Weight
		Veneer 1	Veneer 2	Veneer 3	OW	OD	OH	

Overhead Cabinets, Top without Profile Edge Detail

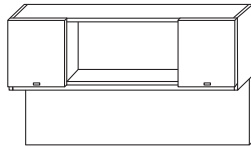

AS64M-PNP	3 yds	3002	3243	3603	72	15 3/4	42 1/4	189
-----------	-------	------	------	------	----	--------	--------	-----

Veneer species must be noted on each line item

Wall mount, flush top without profile edge detail, fabric tack panel (fabric not included, COM must be acrylic backed). Open center storage. Cabinet back unfinished. Optional task lights available, see HBF Casegood Accessories.

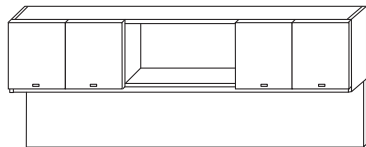

AS64N-PNP	3 yds	3466	3743	4159	78	15 3/4	42 1/4	205
AS64P-PNP	3 yds	3631	3921	4357	84	15 3/4	42 1/4	205
AS64R-PNP	3 yds	3796	4099	4555	90	15 3/4	42 1/4	215
AS64S-PNP	3 1/4 yds	3960	4277	4752	96	15 3/4	42 1/4	215
AS64T-PNP	3 1/2 yds	4125	4455	4950	102	15 3/4	42 1/4	225
AS64U-PNP	3 3/4 yds	4290	4633	5148	108	15 3/4	42 1/4	225
AS64V-PNP	4 1/4 yds	4475	4833	5370	114	15 3/4	42 1/4	235
AS64W-PNP	4 1/4 yds	4661	5034	5593	120	15 3/4	42 1/4	235

Veneer species must be noted on each line item

Wall mount, flush top without profile edge detail, fabric tack panel (fabric not included, COM must be acrylic backed). Open center storage. Cabinet back unfinished. Optional task lights available, see HBF Casegood Accessories.

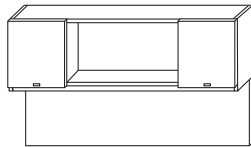

AS65M-PNP		3219	3476	3863	72	15 3/4	42 1/4	189
-----------	--	------	------	------	----	--------	--------	-----

Veneer species must be noted on each line item

Wall mount, flush top without profile edge detail, finished wood panel. Open center storage. Cabinet back unfinished. Optional task lights available, see HBF Casegood Accessories.

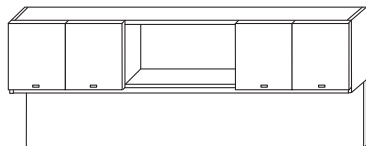

AS65N-PNP		3693	3988	4431	78	15 3/4	42 1/4	205
AS65P-PNP		3878	4188	4654	84	15 3/4	42 1/4	205
AS65R-PNP		4043	4366	4851	90	15 3/4	42 1/4	215
AS65S-PNP		4228	4566	5074	96	15 3/4	42 1/4	215
AS65T-PNP		4414	4767	5296	102	15 3/4	42 1/4	225
AS65U-PNP		4578	4945	5494	108	15 3/4	42 1/4	225
AS65V-PNP		4764	5145	5717	114	15 3/4	42 1/4	235
AS65W-PNP		4949	5345	5939	120	15 3/4	42 1/4	235

Veneer species must be noted on each line item

Wall mount, flush top without profile edge detail, finished wood panel. Open center storage. Cabinet back unfinished. Optional task lights available, see HBF Casegood Accessories.

Installation and maintenance of wall mounted overhead cabinets are the sole responsibility of the customer.

Proper installation is crucial to prevent personal injury.

Veneer species must be noted on each line item

<u>Veneer Grade 1</u>	<u>Veneer Grade 2</u>	<u>Veneer Grade 3</u>
Cherry	Rift Oak	Anigre
Maple	Sapele	
Ligno-Grain		
Walnut		

HBF Ashton Casegoods - Overhead Cabinets

Style Number	Fabric	List Price			Dimensions			Weight
		Veneer 1	Veneer 2	Veneer 3	OW	OD	OH	

Overhead Cabinets, Top without Profile Edge Detail

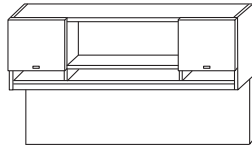

AS64M-PWP	3 yds	3342	3610	4011	72	15 3/4	42 1/4	189
------------------	-------	-------------	-------------	-------------	----	--------	--------	-----

Veneer species must be noted on each line item

Wall mount, flush top without profile edge detail, fabric tack panel (fabric not included, COM must be acrylic backed). Open project shelf storage 3" high and open center storage. Cabinet back unfinished. Optional task lights available, see HBF Casegood Accessories.

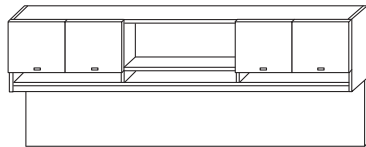

AS64N-PWP	3 yds	3847	4155	4616	78	15 3/4	42 1/4	205
AS64P-PWP	3 yds	4043	4366	4851	84	15 3/4	42 1/4	205
AS64R-PWP	3 yds	4218	4555	5061	90	15 3/4	42 1/4	215
AS64S-PWP	3 1/4 yds	4393	4744	5272	96	15 3/4	42 1/4	215
AS64T-PWP	3 1/2 yds	4589	4956	5506	102	15 3/4	42 1/4	225
AS64U-PWP	3 3/4 yds	4764	5145	5717	108	15 3/4	42 1/4	225
AS64V-PWP	4 1/4 yds	4949	5345	5939	114	15 3/4	42 1/4	235
AS64W-PWP	4 1/4 yds	5135	5545	6161	120	15 3/4	42 1/4	235

Veneer species must be noted on each line item

Wall mount, flush top without profile edge detail, fabric tack panel (fabric not included, COM must be acrylic backed). Open project shelf storage 3" high and open center storage. Cabinet back unfinished. Optional task lights available, see HBF Casegood Accessories.

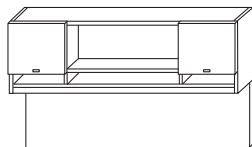

AS65M-PWP		3579	3866	4295	72	15 3/4	42 1/4	189
------------------	--	-------------	-------------	-------------	----	--------	--------	-----

Veneer species must be noted on each line item

Wall mount, flush top without profile edge detail, finished wood panel. Open project shelf storage 3" high and open center storage. Cabinet back unfinished. Optional task lights available, see HBF Casegood Accessories.

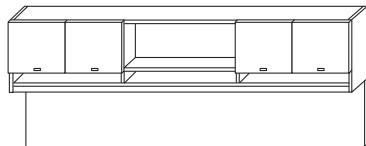

AS65N-PWP		4105	4433	4925	78	15 3/4	42 1/4	205
AS65P-PWP		4311	4655	5173	84	15 3/4	42 1/4	205
AS65R-PWP		4496	4856	5395	90	15 3/4	42 1/4	215
AS65S-PWP		4692	5067	5630	96	15 3/4	42 1/4	215
AS65T-PWP		4898	5289	5877	102	15 3/4	42 1/4	225
AS65U-PWP		5083	5490	6100	108	15 3/4	42 1/4	225
AS65V-PWP		5268	5690	6322	114	15 3/4	42 1/4	235
AS65W-PWP		5454	5890	6545	120	15 3/4	42 1/4	235

Veneer species must be noted on each line item

Wall mount, flush top without profile edge detail, finished wood panel. Open project shelf storage 3" high and open center storage. Cabinet back unfinished. Optional task lights available, see HBF Casegood Accessories.

Installation and maintenance of wall mounted overhead cabinets are the sole responsibility of the customer.

Proper installation is crucial to prevent personal injury.

Veneer species must be noted on each line item

<u>Veneer Grade 1</u>	<u>Veneer Grade 2</u>	<u>Veneer Grade 3</u>
Cherry	Rift Oak	Anigre
Maple	Sapele	
Ligno-Grain		
Walnut		

HBF Ashton Casegoods - Overhead Cabinets

Style Number	Fabric	List Price			Dimensions			Weight
		Veneer 1	Veneer 2	Veneer 3	OW	OD	OH	

Overhead Cabinets, Top without Profile Edge Detail (Double High)

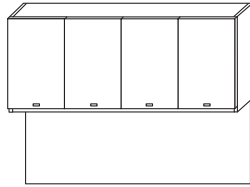

AS64M2-FNP	3 yds	4362	4711	5234	72	15 3/4	56	200
------------	-------	------	------	------	----	--------	----	-----

Veneer species must be noted on each line item

Wall mount, flush top without profile edge detail, one adjustable shelf, fabric tack panel (fabric not included, COM must be acrylic backed), cabinet back unfinished. Optional task lights available, see HBF Casegood Accessories.

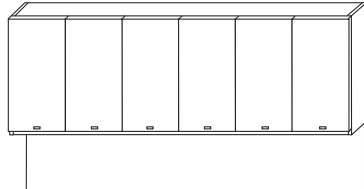

AS64N2-FNP	3 yds	5011	5412	6013	78	15 3/4	56	220
AS64P2-FNP	3 yds	5258	5679	6310	84	15 3/4	56	220
AS64R2-FNP	3 yds	5485	5924	6582	90	15 3/4	56	230
AS64S2-FNP	3 1/4 yds	5722	6179	6866	96	15 3/4	56	230
AS64T2-FNP	3 1/2 yds	5959	6435	7150	102	15 3/4	56	240
AS64U2-FNP	3 3/4 yds	6195	6691	7435	108	15 3/4	56	240
AS64V2-FNP	4 1/4 yds	6432	6947	7719	114	15 3/4	56	250
AS64W2-FNP	4 1/4 yds	6669	7203	8003	120	15 3/4	56	250

Veneer species must be noted on each line item

Wall mount, flush top without profile edge detail, one adjustable shelf, fabric tack panel (fabric not included, COM must be acrylic backed), cabinet back unfinished. Optional task lights available, see HBF Casegood Accessories.

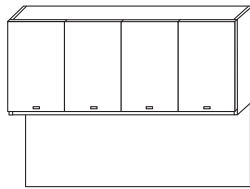

AS65M2-FNP		4661	5034	5593	72	15 3/4	56	200
------------	--	------	------	------	----	--------	----	-----

Veneer species must be noted on each line item

Wall mount, flush top without profile edge detail, one adjustable shelf, finished wood panel, cabinet back unfinished. Optional task lights available, see HBF Casegood Accessories.

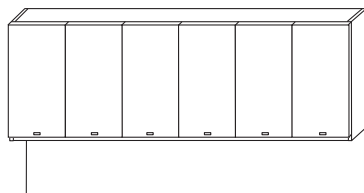

AS65N2-FNP		5341	5768	6409	78	15 3/4	56	220
AS65P2-FNP		5608	6057	6730	84	15 3/4	56	220
AS65R2-FNP		5845	6313	7014	90	15 3/4	56	230
AS65S2-FNP		6092	6580	7311	96	15 3/4	56	230
AS65T2-FNP		6360	6869	7632	102	15 3/4	56	240
AS65U2-FNP		6597	7125	7917	108	15 3/4	56	240
AS65V2-FNP		6834	7381	8201	114	15 3/4	56	250
AS65W2-FNP		7071	7637	8485	120	15 3/4	56	250

Veneer species must be noted on each line item

Wall mount, flush top without profile edge detail, one adjustable shelf, finished wood panel, cabinet back unfinished. Optional task lights available, see HBF Casegood Accessories.

**Double high overhead cabinets to be used with double high vertical cabinets.
Installation and maintenance of wall mounted overhead cabinets are the sole responsibility of the customer.
Proper installation is crucial to prevent personal injury.**

Veneer species must be noted on each line item

Veneer Grade 1	Veneer Grade 2	Veneer Grade 3
Cherry	Rift Oak	Anigre
Maple	Sapele	
Ligno-Grain		
Walnut		

HBF Ashton Casegoods - Overhead Cabinets

Style Number	Fabric	List Price			Dimensions			Weight
		Veneer 1	Veneer 2	Veneer 3	OW	OD	OH	

Overhead Cabinets, Top without Profile Edge Detail (Double High)

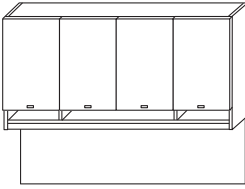

AS64M2-FWP	3 yds	4815	5200	5778	72	15 3/4	56	200
------------	-------	------	------	------	----	--------	----	-----

Veneer species must be noted on each line item

Wall mount, flush top without profile edge detail, one adjustable shelf, fabric tack panel (fabric not included, COM must be acrylic backed). Open project shelf storage 3" high. Cabinet back unfinished. Optional task lights available, see HBF Casegood Accessories.

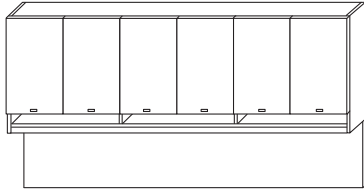

AS64N2-FWP	3 yds	5536	5979	6644	78	15 3/4	56	220
AS64P2-FWP	3 yds	5804	6268	6965	84	15 3/4	56	220
AS64R2-FWP	3 yds	6051	6535	7262	90	15 3/4	56	230
AS64S2-FWP	3 1/4 yds	6309	6813	7571	96	15 3/4	56	230
AS64T2-FWP	3 1/2 yds	6577	7103	7892	102	15 3/4	56	240
AS64U2-FWP	3 3/4 yds	6834	7381	8201	108	15 3/4	56	240
AS64V2-FWP	4 1/4 yds	7071	7637	8485	114	15 3/4	56	250
AS64W2-FWP	4 1/4 yds	7308	7892	8769	120	15 3/4	56	250

Veneer species must be noted on each line item

Wall mount, flush top without profile edge detail, one adjustable shelf, fabric tack panel (fabric not included, COM must be acrylic backed). Open project shelf storage 3" high. Cabinet back unfinished. Optional task lights available, see HBF Casegood Accessories.

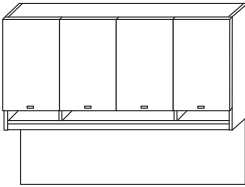

AS65M2-FWP		5145	5556	6174	72	15 3/4	56	200
------------	--	------	------	------	----	--------	----	-----

Veneer species must be noted on each line item

Wall mount, flush top without profile edge detail, one adjustable shelf, finished wood panel. Open project shelf storage 3" high. Cabinet back unfinished. Optional task lights available, see HBF Casegood Accessories.

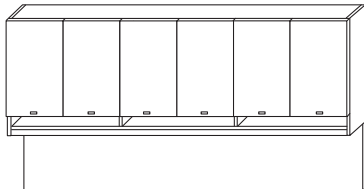

AS65N2-FWP		5897	6368	7076	78	15 3/4	56	220
AS65P2-FWP		6185	6680	7422	84	15 3/4	56	220
AS65R2-FWP		6453	6969	7744	90	15 3/4	56	230
AS65S2-FWP		6721	7258	8065	96	15 3/4	56	230
AS65T2-FWP		7019	7581	8423	102	15 3/4	56	240
AS65U2-FWP		7277	7859	8732	108	15 3/4	56	240
AS65V2-FWP		7514	8115	9017	114	15 3/4	56	250
AS65W2-FWP		7751	8371	9301	120	15 3/4	56	250

Veneer species must be noted on each line item

Wall mount, flush top without profile edge detail, one adjustable shelf, finished wood panel. Open project shelf storage 3" high. Cabinet back unfinished. Optional task lights available, see HBF Casegood Accessories.

**Double high overhead cabinets to be used with double high vertical cabinets.
Installation and maintenance of wall mounted overhead cabinets are the sole responsibility of the customer.
Proper installation is crucial to prevent personal injury.**

Veneer species must be noted on each line item

<u>Veneer Grade 1</u>	<u>Veneer Grade 2</u>	<u>Veneer Grade 3</u>
Cherry	Rift Oak	Anigre
Maple	Sapele	
Ligno-Grain		
Walnut		

HBF Ashton Casegoods - Overhead Cabinets

Style Number	Fabric	List Price			Dimensions			Weight
		Veneer 1	Veneer 2	Veneer 3	OW	OD	OH	

Overhead Cabinets, Top without Profile Edge Detail (Double High)

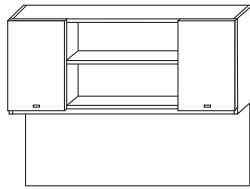

AS64M2-PNP	3 yds	4135	4466	4963	72	15 3/4	56	195
------------	-------	------	------	------	----	--------	----	-----

Veneer species must be noted on each line item

Wall mount, flush top without profile edge detail, fabric tack panel (fabric not included, COM must be acrylic backed). Open center storage, one adjustable shelf. Cabinet back unfinished. Optional task lights available, see HBF Casegood Accessories.

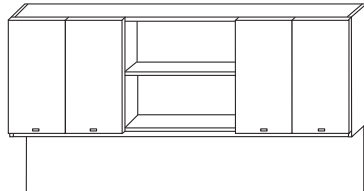

AS64N2-PNP	3 yds	4753	5134	5704	78	15 3/4	56	215
AS64P2-PNP	3 yds	4980	5378	5976	84	15 3/4	56	215
AS64R2-PNP	3 yds	5207	5623	6248	90	15 3/4	56	225
AS64S2-PNP	3 1/4 yds	5423	5857	6508	96	15 3/4	56	225
AS64T2-PNP	3 1/2 yds	5650	6102	6779	102	15 3/4	56	235
AS64U2-PNP	3 3/4 yds	5876	6346	7051	108	15 3/4	56	235
AS64V2-PNP	4 1/4 yds	6113	6602	7336	114	15 3/4	56	245
AS64W2-PNP	4 1/4 yds	6350	6858	7620	120	15 3/4	56	245

Veneer species must be noted on each line item

Wall mount, flush top without profile edge detail, fabric tack panel (fabric not included, COM must be acrylic backed). Open center storage, one adjustable shelf. Cabinet back unfinished. Optional task lights available, see HBF Casegood Accessories.

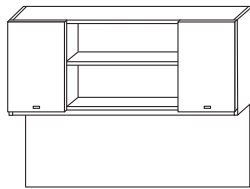

AS65M2-PNP		4414	4767	5296	72	15 3/4	56	195
------------	--	------	------	------	----	--------	----	-----

Veneer species must be noted on each line item

Wall mount, flush top without profile edge detail, finished wood panel. Open center storage, one adjustable shelf. Cabinet back unfinished. Optional task lights available, see HBF Casegood Accessories.

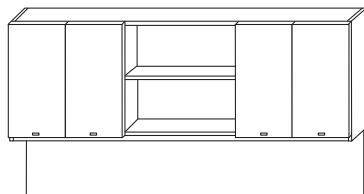

AS65N2-PNP		5062	5467	6075	78	15 3/4	56	215
AS65P2-PNP		5320	5746	6384	84	15 3/4	56	215
AS65R2-PNP		5536	5979	6644	90	15 3/4	56	225
AS65S2-PNP		5783	6246	6940	96	15 3/4	56	225
AS65T2-PNP		6031	6513	7237	102	15 3/4	56	235
AS65U2-PNP		6257	6758	7509	108	15 3/4	56	235
AS65V2-PNP		6494	7014	7793	114	15 3/4	56	245
AS65W2-PNP		6731	7270	8077	120	15 3/4	56	245

Veneer species must be noted on each line item

Wall mount, flush top without profile edge detail, finished wood panel. Open center storage, one adjustable shelf. Cabinet back unfinished. Optional task lights available, see HBF Casegood Accessories.

**Double high overhead cabinets to be used with double high vertical cabinets.
Installation and maintenance of wall mounted overhead cabinets are the sole responsibility of the customer.
Proper installation is crucial to prevent personal injury.**

Veneer species must be noted on each line item

<u>Veneer Grade 1</u>	<u>Veneer Grade 2</u>	<u>Veneer Grade 3</u>
Cherry	Rift Oak	Anigre
Maple	Sapele	
Ligno-Grain		
Walnut		

HBF Ashton Casegoods - Overhead Cabinets

Style Number	Fabric	List Price			Dimensions			Weight
		Veneer 1	Veneer 2	Veneer 3	OW	OD	OH	

Overhead Cabinets, Top without Profile Edge Detail (Double High)

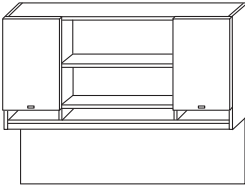

AS64M2-PWP	3 yds	4589	4956	5506	72	15 3/4	56	195
------------	-------	------	------	------	----	--------	----	-----

Veneer species must be noted on each line item

Wall mount, flush top without profile edge detail, fabric tack panel (fabric not included, COM must be acrylic backed). Open center storage, one adjustable shelf, open project shelf storage 3" high. Cabinet back unfinished. Optional task lights available, see HBF Casegood Accessories.

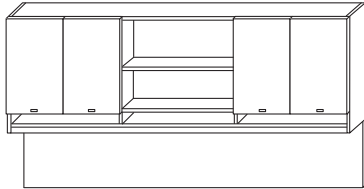

AS64N2-PWP	3 yds	5279	5701	6335	78	15 3/4	56	215
AS64P2-PWP	3 yds	5526	5968	6631	84	15 3/4	56	215
AS64R2-PWP	3 yds	5773	6235	6928	90	15 3/4	56	225
AS64S2-PWP	3 1/4 yds	6010	6491	7212	96	15 3/4	56	225
AS64T2-PWP	3 1/2 yds	6268	6769	7521	102	15 3/4	56	235
AS64U2-PWP	3 3/4 yds	6515	7036	7818	108	15 3/4	56	235
AS64V2-PWP	4 1/4 yds	6752	7292	8102	114	15 3/4	56	245
AS64W2-PWP	4 1/4 yds	6989	7548	8386	120	15 3/4	56	245

Veneer species must be noted on each line item

Wall mount, flush top without profile edge detail, fabric tack panel (fabric not included, COM must be acrylic backed). Open center storage, one adjustable shelf, open project shelf storage 3" high. Cabinet back unfinished. Optional task lights available, see HBF Casegood Accessories.

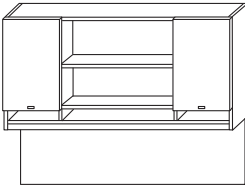

AS65M2-PWP		4898	5289	5877	72	15 3/4	56	195
------------	--	------	------	------	----	--------	----	-----

Veneer species must be noted on each line item

Wall mount, flush top without profile edge detail, finished wood panel. Open center storage, one adjustable shelf, open project shelf storage 3" high. Cabinet back unfinished. Optional task lights available, see HBF Casegood Accessories.

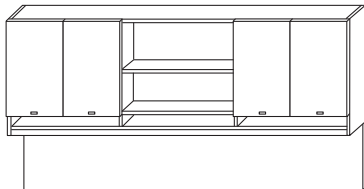

AS65N2-PWP		5619	6068	6742	78	15 3/4	56	215
AS65P2-PWP		5897	6368	7076	84	15 3/4	56	215
AS65R2-PWP		6144	6635	7373	90	15 3/4	56	225
AS65S2-PWP		6412	6925	7694	96	15 3/4	56	225
AS65T2-PWP		6690	7225	8028	102	15 3/4	56	235
AS65U2-PWP		6937	7492	8324	108	15 3/4	56	235
AS65V2-PWP		7174	7748	8609	114	15 3/4	56	245
AS65W2-PWP		7411	8004	8893	120	15 3/4	56	245

Veneer species must be noted on each line item

Wall mount, flush top without profile edge detail, finished wood panel. Open center storage, one adjustable shelf, open project shelf storage 3" high. Cabinet back unfinished. Optional task lights available, see HBF Casegood Accessories.

**Double high overhead cabinets to be used with double high vertical cabinets.
Installation and maintenance of wall mounted overhead cabinets are the sole responsibility of the customer.
Proper installation is crucial to prevent personal injury.**

Veneer species must be noted on each line item

Veneer Grade 1	Veneer Grade 2	Veneer Grade 3
Cherry	Rift Oak	Anigre
Maple	Sapele	
Ligno-Grain		
Walnut		

HBF Ashton Casegoods - Overhead Cabinets

Style Number	Fabric	List Price			Dimensions			Weight
		Veneer 1	Veneer 2	Veneer 3	OW	OD	OH	

Overhead Cabinets, Top with Profile Edge Detail

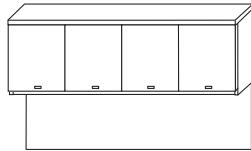

AS64A-FNP	3 yds	3445	3721	4134	72	15 3/4	43 5/8	205
-----------	-------	------	------	------	----	--------	--------	-----

Veneer species must be noted on each line item

Wall mount, top with profile edge detail, fabric tack panel (fabric not included, COM must be acrylic backed), cabinet back unfinished. Optional task lights available, see HBF Casegood Accessories.

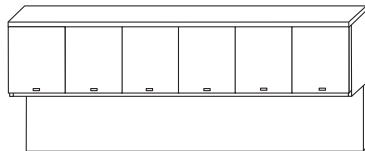

AS64F-FNP	3 yds	3960	4277	4752	78	15 3/4	43 5/8	225
AS64B-FNP	3 yds	4156	4489	4987	84	15 3/4	43 5/8	225
AS64C-FNP	3 yds	4341	4689	5210	90	15 3/4	43 5/8	235
AS64D-FNP	3 1/4 yds	4527	4889	5432	96	15 3/4	43 5/8	235
AS64G-FNP	3 1/2 yds	4723	5100	5667	102	15 3/4	43 5/8	245
AS64E-FNP	3 3/4 yds	4908	5301	5890	108	15 3/4	43 5/8	245
AS64H-FNP	4 1/4 yds	5093	5501	6112	114	15 3/4	43 5/8	255
AS64J-FNP	4 1/4 yds	5279	5701	6335	120	15 3/4	43 5/8	255

Veneer species must be noted on each line item

Wall mount, top with profile edge detail, fabric tack panel (fabric not included, COM must be acrylic backed), cabinet back unfinished. Optional task lights available, see HBF Casegood Accessories.

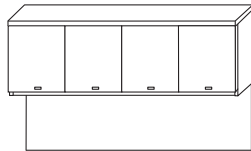

AS65A-FNP		3682	3997	4419	72	15 3/4	43 5/8	205
-----------	--	------	------	------	----	--------	--------	-----

Veneer species must be noted on each line item

Wall mount, top with profile edge detail, finished wood panel, cabinet back unfinished. Optional task lights available, see HBF Casegood Accessories.

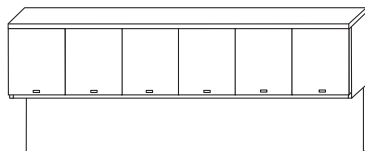

AS65F-FNP		4228	4566	5074	78	15 3/4	43 5/8	225
AS65B-FNP		4444	4800	5333	84	15 3/4	43 5/8	225
AS65C-FNP		4630	5000	5556	90	15 3/4	43 5/8	235
AS65D-FNP		4826	5212	5791	96	15 3/4	43 5/8	235
AS65G-FNP		5042	5445	6050	102	15 3/4	43 5/8	245
AS65E-FNP		5227	5645	6273	108	15 3/4	43 5/8	245
AS65H-FNP		5413	5846	6495	114	15 3/4	43 5/8	255
AS65J-FNP		5598	6046	6718	120	15 3/4	43 5/8	255

Veneer species must be noted on each line item

Wall mount, top with profile edge detail, finished wood panel, cabinet back unfinished. Optional task lights available, see HBF Casegood Accessories.

**Installation and maintenance of wall mounted overhead cabinets are the sole responsibility of the customer.
Proper installation is crucial to prevent personal injury.**

Veneer species must be noted on each line item

<u>Veneer Grade 1</u>	<u>Veneer Grade 2</u>	<u>Veneer Grade 3</u>
Cherry	Rift Oak	Anigre
Maple	Sapele	
Ligno-Grain		
Walnut		

HBF Ashton Casegoods - Overhead Cabinets

Style Number	Fabric	List Price			Dimensions			Weight
		Veneer 1	Veneer 2	Veneer 3	OW	OD	OH	

Overhead Cabinets, Top with Profile Edge Detail

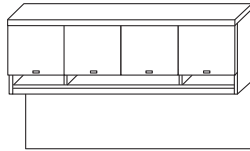

AS64A-FWP	3 yds	3806	4110	4567	72	15 3/4	43 5/8	205
-----------	-------	------	------	------	----	--------	--------	-----

Veneer species must be noted on each line item

Wall mount, top with profile edge detail, fabric tack panel (fabric not included, COM must be acrylic backed). Open project shelf storage 3" high. Cabinet back unfinished. Optional task lights available, see HBF Casegood Accessories.

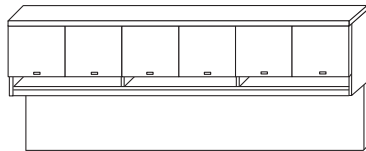

AS64F-FWP	3 yds	4383	4733	5259	78	15 3/4	43 5/8	225
AS64B-FWP	3 yds	4599	4967	5519	84	15 3/4	43 5/8	225
AS64C-FWP	3 yds	4795	5178	5754	90	15 3/4	43 5/8	235
AS64D-FWP	3 1/4 yds	5001	5401	6001	96	15 3/4	43 5/8	235
AS64G-FWP	3 1/2 yds	5217	5634	6260	102	15 3/4	43 5/8	245
AS64E-FWP	3 3/4 yds	5413	5846	6495	108	15 3/4	43 5/8	245
AS64H-FWP	4 1/4 yds	5598	6046	6718	114	15 3/4	43 5/8	255
AS64J-FWP	4 1/4 yds	5783	6246	6940	120	15 3/4	43 5/8	255

Veneer species must be noted on each line item

Wall mount, top with profile edge detail, fabric tack panel (fabric not included, COM must be acrylic backed). Open project shelf storage 3" high. Cabinet back unfinished. Optional task lights available, see HBF Casegood Accessories.

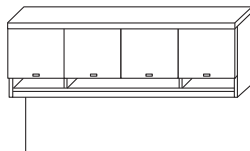

AS65A-FWP		4074	4400	4888	72	15 3/4	43 5/8	205
-----------	--	------	------	------	----	--------	--------	-----

Veneer species must be noted on each line item

Wall mount, top with profile edge detail, finished wood panel. Open project shelf storage 3" high. Cabinet back unfinished. Optional task lights available, see HBF Casegood Accessories.

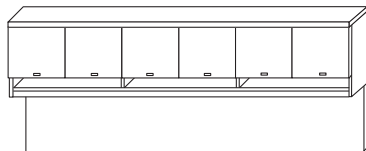

AS65F-FWP		4671	5045	5605	78	15 3/4	43 5/8	225
AS65B-FWP		4630	5000	5556	84	15 3/4	43 5/8	225
AS65C-FWP		5114	5523	6137	90	15 3/4	43 5/8	235
AS65D-FWP		5330	5757	6396	96	15 3/4	43 5/8	235
AS65G-FWP		5567	6013	6681	102	15 3/4	43 5/8	245
AS65E-FWP		5773	6235	6928	108	15 3/4	43 5/8	245
AS65H-FWP		5959	6435	7150	114	15 3/4	43 5/8	255
AS65J-FWP		6144	6635	7373	120	15 3/4	43 5/8	255

Veneer species must be noted on each line item

Wall mount, top with profile edge detail, finished wood panel. Open project shelf storage 3" high. Cabinet back unfinished. Optional task lights available, see HBF Casegood Accessories.

Installation and maintenance of wall mounted overhead cabinets are the sole responsibility of the customer. Proper installation is crucial to prevent personal injury.

Veneer species must be noted on each line item

Veneer Grade 1	Veneer Grade 2	Veneer Grade 3
Cherry	Rift Oak	Anigre
Maple	Sapele	
Ligno-Grain		
Walnut		

HBF Ashton Casegoods - Overhead Cabinets

Style Number	Fabric	List Price			Dimensions			Weight
		Veneer 1	Veneer 2	Veneer 3	OW	OD	OH	

Overhead Cabinets, Top with Profile Edge Detail

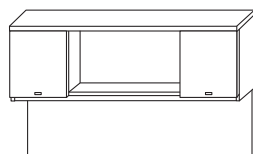

AS64A-PNP	3 yds	3260	3521	3912	72	15 3/4	43 5/8	200
-----------	-------	------	------	------	----	--------	--------	-----

Veneer species must be noted on each line item

Wall mount, top with profile edge detail, fabric tack panel (fabric not included, COM must be acrylic backed). Open center storage. Cabinet back unfinished. Optional task lights available, see HBF Casegood Accessories.

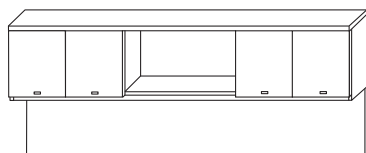

AS64F-PNP	3 yds	3754	4055	4505	78	15 3/4	43 5/8	215
AS64B-PNP	3 yds	3940	4255	4728	84	15 3/4	43 5/8	215
AS64C-PNP	3 yds	4115	4444	4938	90	15 3/4	43 5/8	225
AS64D-PNP	3 1/4 yds	4290	4633	5148	96	15 3/4	43 5/8	225
AS64G-PNP	3 1/2 yds	4475	4833	5370	102	15 3/4	43 5/8	235
AS64E-PNP	3 3/4 yds	4650	5022	5581	108	15 3/4	43 5/8	235
AS64H-PNP	4 1/4 yds	4836	5223	5803	114	15 3/4	43 5/8	245
AS64J-PNP	4 1/4 yds	5021	5423	6026	120	15 3/4	43 5/8	245

Veneer species must be noted on each line item

Wall mount, top with profile edge detail, fabric tack panel (fabric not included, COM must be acrylic backed). Open center storage. Cabinet back unfinished. Optional task lights available, see HBF Casegood Accessories.

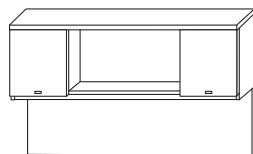

AS65A-PNP		3487	3765	4184	72	15 3/4	43 5/8	200
-----------	--	------	------	------	----	--------	--------	-----

Veneer species must be noted on each line item

Wall mount, top with profile edge detail, finished wood panel. Open center storage. Cabinet back unfinished. Optional task lights available, see HBF Casegood Accessories.

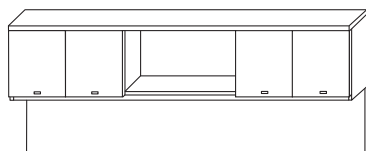

AS65F-PNP		4002	4322	4802	78	15 3/4	43 5/8	215
AS65B-PNP		4208	4544	5049	84	15 3/4	43 5/8	215
AS65C-PNP		4383	4733	5259	90	15 3/4	43 5/8	225
AS65D-PNP		4578	4945	5494	96	15 3/4	43 5/8	225
AS65G-PNP		4784	5167	5741	102	15 3/4	43 5/8	235
AS65E-PNP		4959	5356	5951	108	15 3/4	43 5/8	235
AS65H-PNP		5145	5556	6174	114	15 3/4	43 5/8	245
AS65J-PNP		5330	5757	6396	120	15 3/4	43 5/8	245

Veneer species must be noted on each line item

Wall mount, top with profile edge detail, finished wood panel. Open center storage. Cabinet back unfinished. Optional task lights available, see HBF Casegood Accessories.

**Installation and maintenance of wall mounted overhead cabinets are the sole responsibility of the customer.
Proper installation is crucial to prevent personal injury.**

Veneer species must be noted on each line item

<u>Veneer Grade 1</u>	<u>Veneer Grade 2</u>	<u>Veneer Grade 3</u>
Cherry	Rift Oak	Anigre
Maple	Sapele	
Ligno-Grain		
Walnut		

HBF Ashton Casegoods - Overhead Cabinets

Style Number	Fabric	List Price			Dimensions			Weight
		Veneer 1	Veneer 2	Veneer 3	OW	OD	OH	

Overhead Cabinets, Top with Profile Edge Detail

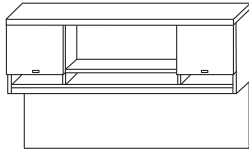

AS64A-PWP	3 yds	3620	3910	4345	72	15 3/4	43 5/8	200
-----------	-------	------	------	------	----	--------	--------	-----

Veneer species must be noted on each line item

Wall mount, top with profile edge detail, fabric tack panel (fabric not included, COM must be acrylic backed). Open project shelf storage 3" high and open center storage. Cabinet back unfinished. Optional task lights available, see HBF Casegood Accessories.

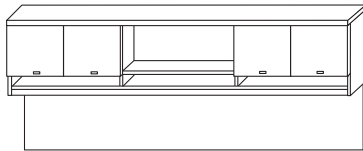

AS64F-PWP	3 yds	4177	4511	5012	78	15 3/4	43 5/8	215
AS64B-PWP	3 yds	4383	4733	5259	84	15 3/4	43 5/8	215
AS64C-PWP	3 yds	4568	4933	5482	90	15 3/4	43 5/8	225
AS64D-PWP	3 1/4 yds	4764	5145	5717	96	15 3/4	43 5/8	225
AS64G-PWP	3 1/2 yds	4970	5367	5964	102	15 3/4	43 5/8	235
AS64E-PWP	3 3/4 yds	5165	5579	6199	108	15 3/4	43 5/8	235
AS64H-PWP	4 1/4 yds	5351	5779	6421	114	15 3/4	43 5/8	245
AS64J-PWP	4 1/4 yds	5536	5979	6644	120	15 3/4	43 5/8	245

Veneer species must be noted on each line item

Wall mount, top with profile edge detail, fabric tack panel (fabric not included, COM must be acrylic backed). Open project shelf storage 3" high and open center storage. Cabinet back unfinished. Optional task lights available, see HBF Casegood Accessories.

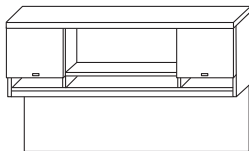

AS65A-PWP		3878	4188	4654	72	15 3/4	43 5/8	200
-----------	--	------	------	------	----	--------	--------	-----

Veneer species must be noted on each line item

Wall mount, top with profile edge detail, finished wood panel). Open project shelf storage 3" high and open center storage. Cabinet back unfinished. Optional task lights available, see HBF Casegood Accessories.

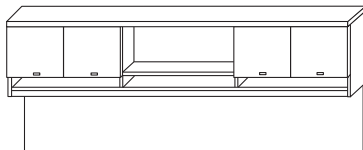

AS65F-PWP		4444	4800	5333	78	15 3/4	43 5/8	215
AS65B-PWP		4671	5045	5605	84	15 3/4	43 5/8	215
AS65C-PWP		4867	5256	5840	90	15 3/4	43 5/8	225
AS65D-PWP		5083	5490	6100	96	15 3/4	43 5/8	225
AS65G-PWP		5310	5734	6372	102	15 3/4	43 5/8	235
AS65E-PWP		5505	5946	6606	108	15 3/4	43 5/8	235
AS65H-PWP		5691	6146	6829	114	15 3/4	43 5/8	245
AS65J-PWP		5876	6346	7051	120	15 3/4	43 5/8	245

Veneer species must be noted on each line item

Wall mount, top with profile edge detail, finished wood panel). Open project shelf storage 3" high and open center storage. Cabinet back unfinished. Optional task lights available, see HBF Casegood Accessories.

Installation and maintenance of wall mounted overhead cabinets are the sole responsibility of the customer. Proper installation is crucial to prevent personal injury.

Veneer species must be noted on each line item

Veneer Grade 1	Veneer Grade 2	Veneer Grade 3
Cherry	Rift Oak	Anigre
Maple	Sapele	
Ligno-Grain		
Walnut		

HBF Ashton Casegoods - Overhead Cabinets

Style Number	Fabric	List Price			Dimensions			Weight
		Veneer 1	Veneer 2	Veneer 3	OW	OD	OH	

Overhead Cabinets, Top with Profile Edge Detail (Double High)

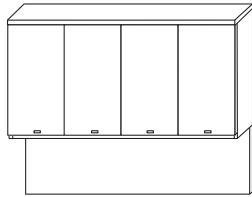

AS64A2-FNP	3 yds	4723	5100	5667	72	15 3/4	57 3/8	210
------------	-------	------	------	------	----	--------	--------	-----

Veneer species must be noted on each line item

Wall mount, top with profile edge detail, one adjustable shelf, fabric tack panel (fabric not included, COM must be acrylic backed), cabinet back unfinished. Optional task lights available, see HBF Casegood Accessories.

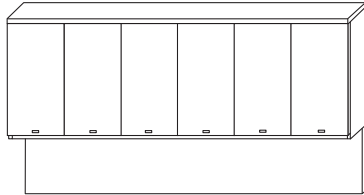

AS64F2-FNP	3 yds	5433	5868	6520	78	15 3/4	57 3/8	230
AS64B2-FNP	3 yds	5691	6146	6829	84	15 3/4	57 3/8	230
AS64C2-FNP	3 yds	5938	6413	7126	90	15 3/4	57 3/8	240
AS64D2-FNP	3 1/4 yds	6195	6691	7435	96	15 3/4	57 3/8	240
AS64G2-FNP	3 1/2 yds	6453	6969	7744	102	15 3/4	57 3/8	250
AS64E2-FNP	3 3/4 yds	6700	7236	8040	108	15 3/4	57 3/8	250
AS64H2-FNP	4 1/4 yds	6937	7492	8324	114	15 3/4	57 3/8	260
AS64J2-FNP	4 1/4 yds	7174	7748	8609	120	15 3/4	57 3/8	260

Veneer species must be noted on each line item

Wall mount, top with profile edge detail, one adjustable shelf, fabric tack panel (fabric not included, COM must be acrylic backed), cabinet back unfinished. Optional task lights available, see HBF Casegood Accessories.

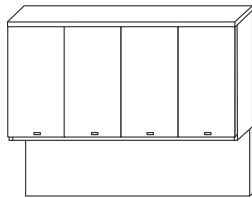

AS65A2-FNP		5052	5456	6063	72	15 3/4	57 3/8	210
------------	--	------	------	------	----	--------	--------	-----

Veneer species must be noted on each line item

Wall mount, top with profile edge detail, one adjustable shelf, finished wood panel, cabinet back unfinished. Optional task lights available, see HBF Casegood Accessories.

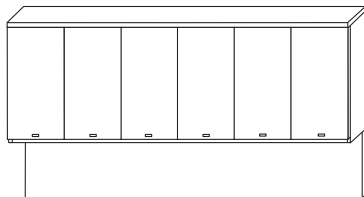

AS65F2-FNP		5783	6246	6940	78	15 3/4	57 3/8	230
AS65B2-FNP		6072	6558	7286	84	15 3/4	57 3/8	230
AS65C2-FNP		6329	6836	7595	90	15 3/4	57 3/8	240
AS65D2-FNP		6597	7125	7917	96	15 3/4	57 3/8	240
AS65G2-FNP		6886	7436	8263	102	15 3/4	57 3/8	250
AS65E2-FNP		7143	7714	8572	108	15 3/4	57 3/8	250
AS65H2-FNP		7380	7970	8856	114	15 3/4	57 3/8	260
AS65J2-FNP		7617	8226	9140	120	15 3/4	57 3/8	260

Veneer species must be noted on each line item

Wall mount, top with profile edge detail, one adjustable shelf, finished wood panel, cabinet back unfinished. Optional task lights available, see HBF Casegood Accessories.

**Double high overhead cabinets to be used with double high vertical cabinets.
Installation and maintenance of wall mounted overhead cabinets are the sole responsibility of the customer.
Proper installation is crucial to prevent personal injury.**

Veneer species must be noted on each line item

<u>Veneer Grade 1</u>	<u>Veneer Grade 2</u>	<u>Veneer Grade 3</u>
Cherry	Rift Oak	Anigre
Maple	Sapele	
Ligno-Grain		
Walnut		

HBF Ashton Casegoods - Overhead Cabinets

Style Number	Fabric	List Price			Dimensions			Weight
		Veneer 1	Veneer 2	Veneer 3	OW	OD	OH	

Overhead Cabinets, Top with Profile Edge Detail (Double High)

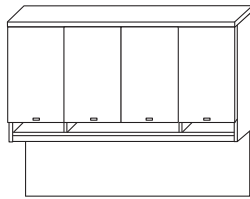

AS64A2-FWP	3 yds	5217	5634	6260	72	15 3/4	57 3/8	210
------------	-------	------	------	------	----	--------	--------	-----

Veneer species must be noted on each line item

Wall mount, top with profile edge detail, one adjustable shelf, fabric tack panel (fabric not included, COM must be acrylic backed). Open project shelf storage 3" high. Cabinet back unfinished. Optional task lights available, see HBF Casegood Accessories.

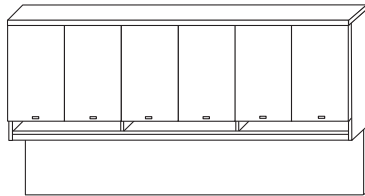

AS64F2-FWP	3 yds	5989	6469	7187	78	15 3/4	57 3/8	230
AS64B2-FWP	3 yds	6288	6791	7546	84	15 3/4	57 3/8	230
AS64C2-FWP	3 yds	6556	7080	7867	90	15 3/4	57 3/8	240
AS64D2-FWP	3 1/4 yds	6834	7381	8201	96	15 3/4	57 3/8	240
AS64G2-FWP	3 1/2 yds	7122	7692	8547	102	15 3/4	57 3/8	250
AS64E2-FWP	3 3/4 yds	7390	7981	8868	108	15 3/4	57 3/8	250
AS64H2-FWP	4 1/4 yds	7627	8237	9153	114	15 3/4	57 3/8	260
AS64J2-FWP	4 1/4 yds	7864	8493	9437	120	15 3/4	57 3/8	260

Veneer species must be noted on each line item

Wall mount, top with profile edge detail, one adjustable shelf, fabric tack panel (fabric not included, COM must be acrylic backed). Open project shelf storage 3" high. Cabinet back unfinished. Optional task lights available, see HBF Casegood Accessories.

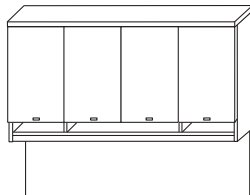

AS65A2-FWP		5577	6024	6693	72	15 3/4	57 3/8	210
------------	--	------	------	------	----	--------	--------	-----

Veneer species must be noted on each line item

Wall mount, top with profile edge detail, one adjustable shelf, finished wood panel. Open project shelf storage 3" high. Cabinet back unfinished. Optional task lights available, see HBF Casegood Accessories.

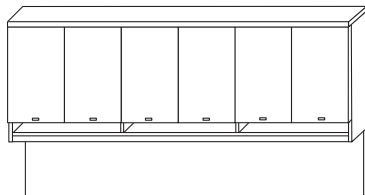

AS65F2-FWP		6381	6891	7657	78	15 3/4	57 3/8	230
AS65B2-FWP		6700	7236	8040	84	15 3/4	57 3/8	230
AS65C2-FWP		6978	7537	8374	90	15 3/4	57 3/8	240
AS65D2-FWP		7277	7859	8732	96	15 3/4	57 3/8	240
AS65G2-FWP		7596	8204	9116	102	15 3/4	57 3/8	250
AS65E2-FWP		7874	8504	9449	108	15 3/4	57 3/8	250
AS65H2-FWP		8111	8760	9734	114	15 3/4	57 3/8	260
AS65J2-FWP		8348	9016	10018	120	15 3/4	57 3/8	260

Veneer species must be noted on each line item

Wall mount, top with profile edge detail, one adjustable shelf, finished wood panel. Open project shelf storage 3" high. Cabinet back unfinished. Optional task lights available, see HBF Casegood Accessories.

**Double high overhead cabinets to be used with double high vertical cabinets.
Installation and maintenance of wall mounted overhead cabinets are the sole responsibility of the customer.
Proper installation is crucial to prevent personal injury.**

Veneer species must be noted on each line item

Veneer Grade 1	Veneer Grade 2	Veneer Grade 3
Cherry	Rift Oak	Anigre
Maple	Sapele	
Ligno-Grain		
Walnut		

HBF Ashton Casegoods - Overhead Cabinets

Style Number	Fabric	List Price			Dimensions			Weight
		Veneer 1	Veneer 2	Veneer 3	OW	OD	OH	

Overhead Cabinets, Top with Profile Edge Detail (Double High)

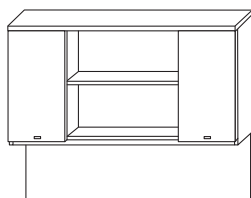

AS64A2-PNP	3 yds	4475	4833	5370	72	15 3/4	57 3/8	200
------------	-------	------	------	------	----	--------	--------	-----

Veneer species must be noted on each line item

Wall mount, top with profile edge detail, fabric tack panel (fabric not included, COM must be acrylic backed). Open center storage, one adjustable shelf. Cabinet back unfinished. Optional task lights available, see HBF Casegood Accessories.

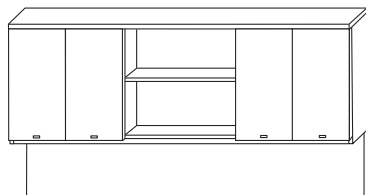

AS64F2-PNP	3 yds	5155	5568	6186	78	15 3/4	57 3/8	220
AS64B2-PNP	3 yds	5402	5835	6483	84	15 3/4	57 3/8	220
AS64C2-PNP	3 yds	5639	6090	6767	90	15 3/4	57 3/8	230
AS64D2-PNP	3 1/4 yds	5876	6346	7051	96	15 3/4	57 3/8	230
AS64G2-PNP	3 1/2 yds	6123	6613	7348	102	15 3/4	57 3/8	240
AS64E2-PNP	3 3/4 yds	6360	6869	7632	108	15 3/4	57 3/8	240
AS64H2-PNP	4 1/4 yds	6597	7125	7917	114	15 3/4	57 3/8	250
AS64J2-PNP	4 1/4 yds	6834	7381	8201	120	15 3/4	57 3/8	250

Veneer species must be noted on each line item

Wall mount, top with profile edge detail, fabric tack panel (fabric not included, COM must be acrylic backed). Open center storage, one adjustable shelf. Cabinet back unfinished. Optional task lights available, see HBF Casegood Accessories.

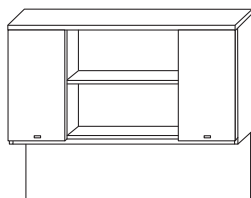

AS65A2-PNP		4784	5167	5741	72	15 3/4	57 3/8	200
------------	--	------	------	------	----	--------	--------	-----

Veneer species must be noted on each line item

Wall mount, top with profile edge detail, finished wood panel. Open center storage, one adjustable shelf. Cabinet back unfinished. Optional task lights available, see HBF Casegood Accessories.

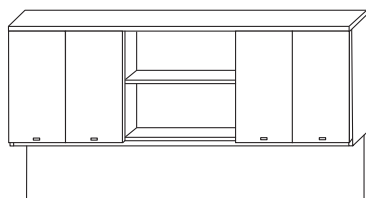

AS65F2-PNP		5485	5924	6582	78	15 3/4	57 3/8	220
AS65B2-PNP		5753	6213	6903	84	15 3/4	57 3/8	220
AS65C2-PNP		6000	6480	7200	90	15 3/4	57 3/8	230
AS65D2-PNP		6257	6758	7509	96	15 3/4	57 3/8	230
AS65G2-PNP		6535	7058	7842	102	15 3/4	57 3/8	240
AS65E2-PNP		6772	7314	8127	108	15 3/4	57 3/8	240
AS65H2-PNP		7009	7570	8411	114	15 3/4	57 3/8	250
AS65J2-PNP		7246	7826	8695	120	15 3/4	57 3/8	250

Veneer species must be noted on each line item

Wall mount, top with profile edge detail, finished wood panel. Open center storage, one adjustable shelf. Cabinet back unfinished. Optional task lights available, see HBF Casegood Accessories.

**Double high overhead cabinets to be used with double high vertical cabinets.
Installation and maintenance of wall mounted overhead cabinets are the sole responsibility of the customer.
Proper installation is crucial to prevent personal injury.**

Veneer species must be noted on each line item

Veneer Grade 1	Veneer Grade 2	Veneer Grade 3
Cherry	Rift Oak	Anigre
Maple	Sapele	
Ligno-Grain		
Walnut		

HBF Ashton Casegoods - Overhead Cabinets

Style Number	Fabric	List Price			Dimensions			Weight
		Veneer 1	Veneer 2	Veneer 3	OW	OD	OH	

Overhead Cabinets, Top with Profile Edge Detail, (Double High)

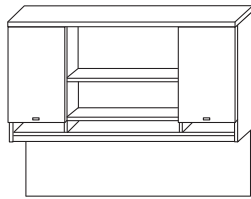

AS64A2-PWP	3 yds	4970	5367	5964	72	15 3/4	57 3/8	200
------------	-------	------	------	------	----	--------	--------	-----

Veneer species must be noted on each line item

Wall mount, top with profile edge detail, fabric tack panel (fabric not included, COM must be acrylic backed). Open center storage, one adjustable shelf, open project shelf storage 3" high. Cabinet back unfinished. Optional task lights available, see HBF Casegood Accessories.

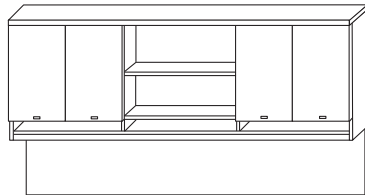

AS64F2-PWP	3 yds	5711	6168	6854	78	15 3/4	57 3/8	220
AS64B2-PWP	3 yds	5989	6469	7187	84	15 3/4	57 3/8	220
AS64C2-PWP	3 yds	6247	6747	7496	90	15 3/4	57 3/8	230
AS64D2-PWP	3 1/4 yds	6515	7036	7818	96	15 3/4	57 3/8	230
AS64G2-PWP	3 1/2 yds	6783	7325	8139	102	15 3/4	57 3/8	240
AS64E2-PWP	3 3/4 yds	7050	7614	8460	108	15 3/4	57 3/8	240
AS64H2-PWP	4 1/4 yds	7287	7870	8745	114	15 3/4	57 3/8	250
AS64J2-PWP	4 1/4 yds	7524	8126	9029	120	15 3/4	57 3/8	250

Veneer species must be noted on each line item

Wall mount, top with profile edge detail, fabric tack panel (fabric not included, COM must be acrylic backed). Open center storage, one adjustable shelf, open project shelf storage 3" high. Cabinet back unfinished. Optional task lights available, see HBF Casegood Accessories.

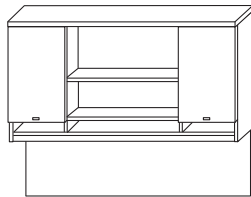

AS65A2-PWP		5310	5734	6372	72	15 3/4	57 3/8	200
------------	--	------	------	------	----	--------	--------	-----

Veneer species must be noted on each line item

Wall mount, top with profile edge detail, finished wood panel. Open center storage, one adjustable shelf, open project shelf storage 3" high. Cabinet back unfinished. Optional task lights available, see HBF Casegood Accessories.

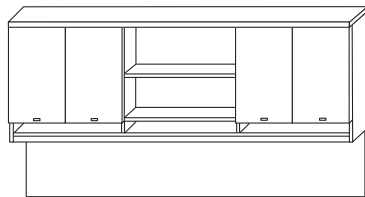

AS65F2-PWP		6082	6569	7299	78	15 3/4	57 3/8	220
AS65B2-PWP		6391	6902	7669	84	15 3/4	57 3/8	220
AS65C2-PWP		6659	7192	7991	90	15 3/4	57 3/8	230
AS65D2-PWP		6937	7492	8324	96	15 3/4	57 3/8	230
AS65G2-PWP		7246	7826	8695	102	15 3/4	57 3/8	240
AS65E2-PWP		7514	8115	9017	108	15 3/4	57 3/8	240
AS65H2-PWP		7751	8371	9301	114	15 3/4	57 3/8	250
AS65J2-PWP		7988	8627	9585	120	15 3/4	57 3/8	250

Veneer species must be noted on each line item

Wall mount, top with profile edge detail, finished wood panel. Open center storage, one adjustable shelf, open project shelf storage 3" high. Cabinet back unfinished. Optional task lights available, see HBF Casegood Accessories.

**Double high overhead cabinets to be used with double high vertical cabinets.
Installation and maintenance of wall mounted overhead cabinets are the sole responsibility of the customer.
Proper installation is crucial to prevent personal injury.**

Veneer species must be noted on each line item

Veneer Grade 1	Veneer Grade 2	Veneer Grade 3
Cherry	Rift Oak	Anigre
Maple	Sapele	
Ligno-Grain		
Walnut		

HBF Ashton Casegoods - Vertical Storage

Style Number	Fabric	List Price			Dimensions			Weight
		Veneer 1	Veneer 2	Veneer 3	OW	OD	OH	

Vertical Storage Cabinets, Top without Profile Edge Detail

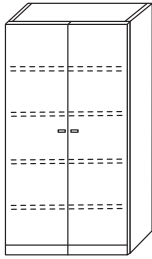

AS70M		3291	3554	3949	30	24 3/4	71 1/2	71	205
AS70N		3435	3710	4122	36	24 3/4	71 1/2	71	237

Veneer species must be noted on each line item

Storage unit, four adjustable shelves, flush top without profile edge detail, cabinet back unfinished.

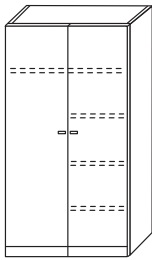

AS71M		3517	3799	4221	30	24 3/4	71 1/2	71	205
AS71N		3651	3943	4382	36	24 3/4	71 1/2	71	237

Veneer species must be noted on each line item

Storage/wardrobe unit, four adjustable shelves and a hat shelf with wardrobe rod, shelves are field changeable from left to right, flush top without profile edge detail, cabinet back unfinished.

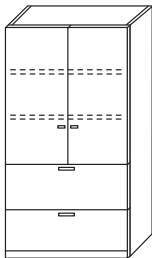

AS72M		4032	4355	4839	30	24 3/4	71 1/2	71	205
AS72N		4156	4489	4987	36	24 3/4	71 1/2	71	237

Veneer species must be noted on each line item

Storage unit, two adjustable shelves above and two locking lateral file drawers below. Flush top without profile edge detail, cabinet back unfinished.

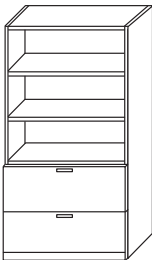

AS73M		3723	4021	4468	30	24 3/4	71 1/2	71	205
AS73N		3868	4177	4641	36	24 3/4	71 1/2	71	237

Veneer species must be noted on each line item

Storage unit, two open adjustable shelves above and two locking lateral file drawers below. Flush top without profile edge detail, cabinet back unfinished.

Veneer species must be noted on each line item

Veneer Grade 1	Veneer Grade 2	Veneer Grade 3
Cherry	Rift Oak	Anigre
Maple	Sapele	
Ligno-Grain		
Walnut		

HBF Ashton Casegoods - Vertical Storage

Style Number	Fabric	List Price			Dimensions			Weight
		Veneer 1	Veneer 2	Veneer 3	OW	OD	OH	

Vertical Storage Cabinets, Top without Profile Edge Detail

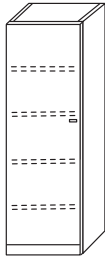

ASLH70P	(left hinge)	2724	2942	3269	18	24 3/4	71 1/2	71	176
ASRH70P	(right hinge)	2724	2942	3269	18	24 3/4	71 1/2	71	176

Veneer species must be noted on each line item

Storage unit, four adjustable shelves. Flush top without profile edge detail, cabinet back unfinished.

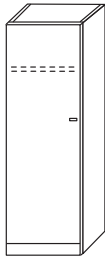

ASLH71P	(left hinge)	2518	2720	3022	18	24 3/4	71 1/2	71	176
ASRH71P	(right hinge)	2518	2720	3022	18	24 3/4	71 1/2	71	176

Veneer species must be noted on each line item

Wardrobe unit, hat shelf and wardrobe rod. Flush top without profile edge detail, cabinet back unfinished.

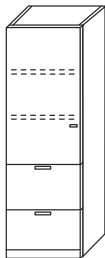

ASLH72P	(left hinge)	3342	3610	4011	18	24 3/4	71 1/2	71	176
ASRH72P	(right hinge)	3342	3610	4011	18	24 3/4	71 1/2	71	176

Veneer species must be noted on each line item

Storage unit, two adjustable shelves above and two locking file drawers below. Flush top without profile edge detail, cabinet back unfinished.



AS73P		2879	3109	3455	18	24 3/4	71 1/2	71	176
--------------	--	-------------	-------------	-------------	----	--------	--------	----	-----

Veneer species must be noted on each line item

Storage unit, two open adjustable shelves above and two locking file drawers below. Flush top without profile edge detail, cabinet back unfinished.

Veneer species must be noted on each line item

<u>Veneer Grade 1</u>	<u>Veneer Grade 2</u>	<u>Veneer Grade 3</u>
Cherry	Rift Oak	Anigre
Maple	Sapele	
Ligno-Grain		
Walnut		

HBF Ashton Casegoods - Vertical Storage

Style Number	List Price			Dimensions				Weight
	Veneer 1	Veneer 2	Veneer 3	OW	OD	OH:M	OH:A/F	

Vertical Storage Cabinets, Top with Profile Edge Detail

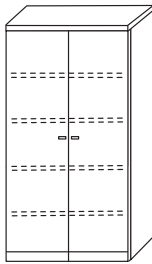

AS70A	3620	3910	4345	30	24 3/4	73	72 1/4	205
AS70B	3806	4110	4567	36	24 3/4	73	72 1/4	237

Veneer species must be noted on each line item

Storage unit, four adjustable shelves. Top with profile edge detail, cabinet back unfinished.

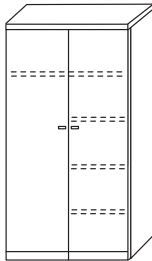

AS71A	3837	4144	4604	30	24 3/4	73	72 1/4	205
AS71B	4032	4355	4839	36	24 3/4	73	72 1/4	237

Veneer species must be noted on each line item

Storage/Wardrobe unit, four adjustable shelves and a hat shelf with wardrobe rod, shelves are field changeable left to right. Top with profile edge detail, cabinet back unfinished.

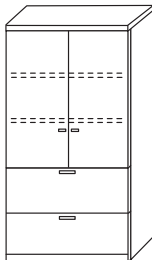

AS72A	4403	4756	5284	30	24 3/4	73	72 1/4	205
AS72B	4527	4889	5432	36	24 3/4	73	72 1/4	237

Veneer species must be noted on each line item

Storage unit, two adjustable shelves above and two locking lateral file drawers below. Top with profile edge detail, cabinet back unfinished.

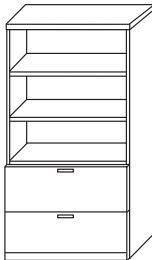

AS73A	4053	4377	4864	30	24 3/4	73	72 1/4	205
AS73B	4238	4578	5086	36	24 3/4	73	72 1/4	237

Veneer species must be noted on each line item

Storage unit, two open adjustable shelves above and two locking lateral file drawers below. Top with profile edge detail, cabinet back unfinished.

Veneer species must be noted on each line item

<u>Veneer Grade 1</u>	<u>Veneer Grade 2</u>	<u>Veneer Grade 3</u>
Cherry	Rift Oak	Anigre
Maple	Sapele	
Ligno-Grain		
Walnut		

HBF Ashton Casegoods - Vertical Storage

Style Number		List Price			Dimensions				
		Veneer 1	Veneer 2	Veneer 3	OW	OD	OH:M	OH:A/F	Weight

Vertical Storage Cabinets, Top with Profile Edge Detail

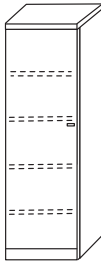

ASLH70C	(left hinge)	3002	3243	3603	18	24 3/4	73	72 1/4	176
ASRH70C	(right hinge)	3002	3243	3603	18	24 3/4	73	72 1/4	176

Veneer species must be noted on each line item

Storage unit, four adjustable shelves. Top with profile edge detail, cabinet back unfinished.

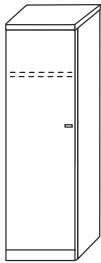

ASLH71C	(left hinge)	2796	3020	3356	18	24 3/4	73	72 1/4	176
ASRH71C	(right hinge)	2796	3020	3356	18	24 3/4	73	72 1/4	176

Veneer species must be noted on each line item

Wardrobe unit, hat shelf and wardrobe rod. Top with profile edge detail, cabinet back unfinished.

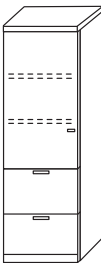

ASLH72C	(left hinge)	3620	3910	4345	18	24 3/4	73	72 1/4	176
ASRH72C	(right hinge)	3620	3910	4345	18	24 3/4	73	72 1/4	176

Veneer species must be noted on each line item

Storage unit, two adjustable shelves above and two locking file drawers below. Top with profile edge detail, cabinet back unfinished.



AS73C		3147	3398	3776	18	24 3/4	73	72 1/4	176
-------	--	------	------	------	----	--------	----	--------	-----

Veneer species must be noted on each line item

Storage unit, two open adjustable shelves above and two locking file drawers below. Top with profile edge detail, cabinet back unfinished.

Veneer species must be noted on each line item

<u>Veneer Grade 1</u>	<u>Veneer Grade 2</u>	<u>Veneer Grade 3</u>
Cherry	Rift Oak	Anigre
Maple	Sapele	
Ligno-Grain		
Walnut		

HBF Ashton Casegoods - Vertical Storage

Style Number	List Price			Dimensions				Weight
	Veneer 1	Veneer 2	Veneer 3	OW	OD	OH:M	OH:A/F	

Vertical Storage Cabinets, Top without Profile Edge Detail (Double High)

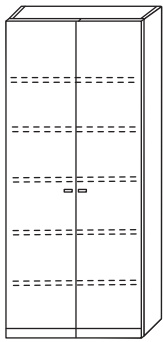

AS70M2	4455	4811	5346	30	24 3/4	85 5/16	84 11/16	277
AS70N2	4650	5022	5581	36	24 3/4	85 5/16	84 11/16	320

Veneer species must be noted on each line item

Storage unit, five adjustable shelves, flush top without profile edge detail, cabinet back unfinished.

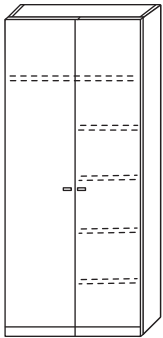

AS71M2	(left hinge)	4753	5134	5704	30	24 3/4	85 5/16	84 11/16	277
AS71N2	(right hinge)	4939	5334	5927	36	24 3/4	85 5/16	84 11/16	320

Veneer species must be noted on each line item

Storage/wardrobe unit, five adjustable shelves and a hat shelf with wardrobe rod, shelves are field changeable from left to right, flush top without profile edge detail, cabinet back unfinished.

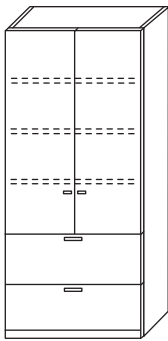

AS72M2	5444	5879	6532	30	24 3/4	85 5/16	84 11/16	277
AS72N2	5619	6068	6742	36	24 3/4	85 5/16	84 11/16	320

Veneer species must be noted on each line item

Storage unit, three adjustable shelves above and two locking lateral file drawers below. Flush top without profile edge detail, cabinet back unfinished.



AS73M2	5032	5434	6038	30	24 3/4	85 5/16	84 11/16	277
AS73N2	5227	5645	6273	36	24 3/4	85 5/16	84 11/16	320

Veneer species must be noted on each line item

Storage unit, three open adjustable shelves above and two locking lateral file drawers below. Flush top without profile edge detail, cabinet back unfinished.

Veneer species must be noted on each line item

<u>Veneer Grade 1</u>	<u>Veneer Grade 2</u>	<u>Veneer Grade 3</u>
Cherry	Rift Oak	Anigre
Maple	Sapele	
Ligno-Grain		
Walnut		

HBF Ashton Casegoods - Vertical Storage

Style Number	List Price			Dimensions					Weight
	Veneer 1	Veneer 2	Veneer 3	OW	OD	OH:M	OH:A/F		

Vertical Storage Cabinets, Top without Profile Edge Detail (Double High)

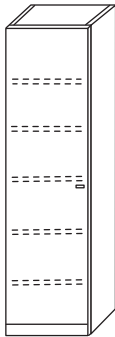

ASLH70P2	(left hinge)	3672	3966	4406	18	24 3/4	85 5/16	84 11/16	237
ASRH70P2	(right hinge)	3672	3966	4406	18	24 3/4	85 5/16	84 11/16	237

Veneer species must be noted on each line item

Storage unit, five adjustable shelves. Flush top without profile edge detail, cabinet back unfinished.

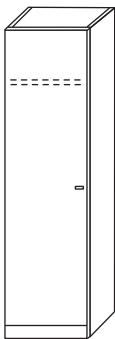

ASLH71P2	(left hinge)	3414	3688	4097	18	24 3/4	85 5/16	84 11/16	237
ASRH71P2	(right hinge)	3414	3688	4097	18	24 3/4	85 5/16	84 11/16	237

Veneer species must be noted on each line item

Wardrobe unit, hat shelf and wardrobe rod. Flush top without profile edge detail, cabinet back unfinished.

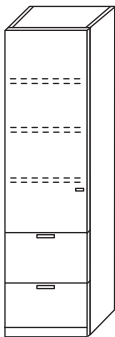

ASLH72P2	(left hinge)	4517	4878	5420	18	24 3/4	85 5/16	84 11/16	237
ASRH72P2	(right hinge)	4517	4878	5420	18	24 3/4	85 5/16	84 11/16	237

Veneer species must be noted on each line item

Storage unit, three adjustable shelves above and two locking file drawers below. Flush top without profile edge detail, cabinet back unfinished.

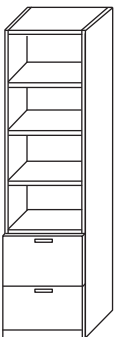

AS73P2		3868	4177	4641	18	24 3/4	85 5/16	84 11/16	237
--------	--	------	------	------	----	--------	---------	----------	-----

Veneer species must be noted on each line item

Storage unit, three open adjustable shelves above and two locking file drawers below. Flush top without profile edge detail, cabinet back unfinished.

Veneer species must be noted on each line item

<u>Veneer Grade 1</u>	<u>Veneer Grade 2</u>	<u>Veneer Grade 3</u>
Cherry	Rift Oak	Anigre
Maple	Sapele	
Ligno-Grain		
Walnut		

HBF Ashton Casegoods - Vertical Storage

Style Number	List Price			Dimensions				Weight
	Veneer 1	Veneer 2	Veneer 3	OW	OD	OH:M	OH:A/F	

Vertical Storage Cabinets, Top with Profile Edge Detail (Double High)

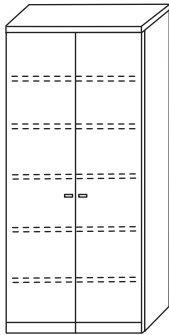

AS70A2	4887	5278	5865	30	24 3/4	86 11/16	86 1/16	277
AS70B2	5145	5556	6174	36	24 3/4	86 11/16	86 1/16	320

Veneer species must be noted on each line item

Storage unit, five adjustable shelves. Top with profile edge detail, cabinet back unfinished.

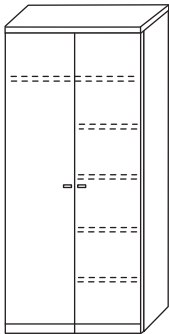

AS71A2	5186	5601	6223	30	24 3/4	86 11/16	86 1/16	277
AS71B2	5444	5879	6532	36	24 3/4	86 11/16	86 1/16	320

Veneer species must be noted on each line item

Storage/Wardrobe unit, five adjustable shelves and a hat shelf with wardrobe rod, shelves are field changeable left to right. Top with profile edge detail, cabinet back unfinished.

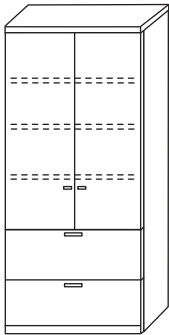

AS72A2	5866	6335	7039	30	24 3/4	86 11/16	86 1/16	277
AS72B2	6113	6602	7336	36	24 3/4	86 11/16	86 1/16	320

Veneer species must be noted on each line item

Storage unit, three adjustable shelves above and two locking lateral file drawers below. Top with profile edge detail, cabinet back unfinished.



AS73A2	5474	5912	6569	30	24 3/4	86 11/16	86 1/16	277
AS73B2	5722	6179	6866	36	24 3/4	86 11/16	86 1/16	320

Veneer species must be noted on each line item

Storage unit, three open adjustable shelves above and two locking lateral file drawers below. Top with profile edge detail, cabinet back unfinished.

Veneer species must be noted on each line item

<u>Veneer Grade 1</u>	<u>Veneer Grade 2</u>	<u>Veneer Grade 3</u>
Cherry	Rift Oak	Anigre
Maple	Sapele	
Ligno-Grain		
Walnut		

HBF Ashton Casegoods - Vertical Storage

Style Number	List Price			Dimensions				Weight
	Veneer 1	Veneer 2	Veneer 3	OW	OD	OH:M	OH:A/F	

Vertical Storage Cabinets, Top with Profile Edge Detail (Double High)

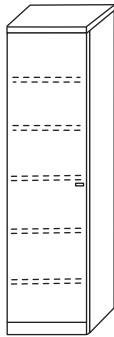

ASLH70C2	(left hinge)	4053	4377	4864	18	24 3/4	86 11/16	86 1/16	237
ASRH70C2	(right hinge)	4053	4377	4864	18	24 3/4	86 11/16	86 1/16	237

Veneer species must be noted on each line item

Storage unit, five adjustable shelves. Top with profile edge detail, cabinet back unfinished.

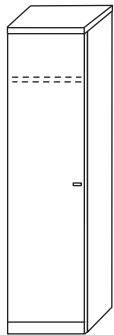

ASLH71C2	(left hinge)	3775	4077	4530	18	24 3/4	86 11/16	86 1/16	237
ASRH71C2	(right hinge)	3775	4077	4530	18	24 3/4	86 11/16	86 1/16	237

Veneer species must be noted on each line item

Wardrobe unit, hat shelf and wardrobe rod. Top with profile edge detail, cabinet back unfinished.

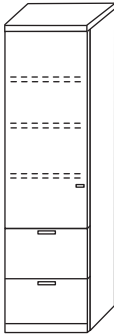

ASLH72C2	(left hinge)	4877	5267	5852	18	24 3/4	86 11/16	86 1/16	237
ASRH72C2	(right hinge)	4877	5267	5852	18	24 3/4	86 11/16	86 1/16	237

Veneer species must be noted on each line item

Storage unit, three adjustable shelves above and two locking file drawers below. Top with profile edge detail, cabinet back unfinished.

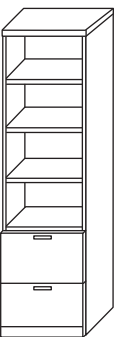

AS73C2		4238	4578	5086	18	24 3/4	86 11/16	86 1/16	237
--------	--	------	------	------	----	--------	----------	---------	-----

Veneer species must be noted on each line item

Storage unit, three open adjustable shelves above and two locking file drawers below. Top with profile edge detail, cabinet back unfinished.

Veneer species must be noted on each line item

<u>Veneer Grade 1</u>	<u>Veneer Grade 2</u>	<u>Veneer Grade 3</u>
Cherry	Rift Oak	Anigre
Maple	Sapele	
Ligno-Grain		
Walnut		

HBF Ashton Casegoods - Bookcases

Style Number	List Price			Dimensions					
	Veneer 1	Veneer 2	Veneer 3	OW	OD	OH:M	OH:A/F	Weight	

Bookcases

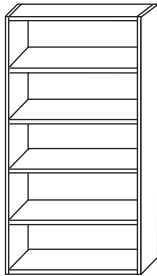

AS75MB	2941	3176	3529	30	14 7/8	71 1/2	71	195
AS75NB	3002	3243	3603	36	14 7/8	71 1/2	71	227

Veneer species must be noted on each line item

Flush top without profile edge detail, four adjustable shelves, standard black unfinished back panel.

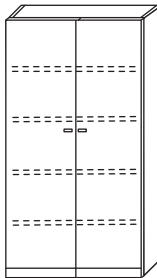

AS76MB	3167	3421	3801	30	15 3/4	71 1/2	71	205
AS76NB	3291	3554	3949	36	15 3/4	71 1/2	71	237

Veneer species must be noted on each line item

Flush top without profile edge detail, four adjustable shelves, standard black unfinished back panel.

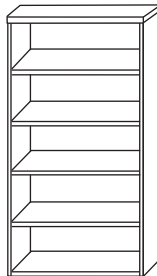

AS75AB	3167	3421	3801	30	14 7/8	73	72 1/4	195
AS75BB	3291	3554	3949	36	14 7/8	73	72 1/4	227

Veneer species must be noted on each line item

Top with profile edge detail, four adjustable shelves, standard black unfinished back panel.

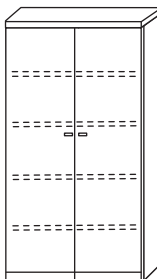

AS76AB	3404	3676	4085	30	15 3/4	73	72 1/4	205
AS76BB	3559	3843	4270	36	15 3/4	73	72 1/4	237

Veneer species must be noted on each line item

Top with profile edge detail, four adjustable shelves, standard black unfinished back panel.

Veneer species must be noted on each line item

Veneer Grade 1	Veneer Grade 2	Veneer Grade 3
Cherry	Rift Oak	Anigre
Maple	Sapele	
Ligno-Grain		
Walnut		

HBF Ashton Casegoods - Bookcases

Style Number	List Price			Dimensions				
	Veneer 1	Veneer 2	Veneer 3	OW	OD	OH:M	OH:A/F	Weight

Bookcases (Double High)

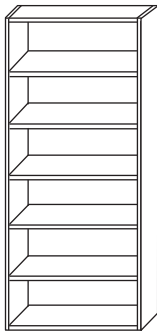

AS75MB2	3981	4299	4777	30	14 7/8	85 5/16	84 11/16	264
AS75NB2	4053	4377	4864	36	14 7/8	85 5/16	84 11/16	307

Veneer species must be noted on each line item

Flush top without profile edge detail, five adjustable shelves, standard black unfinished back panel.

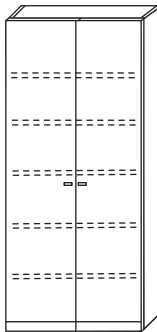

AS76MB2	4280	4622	5136	30	15 3/4	85 5/16	84 11/16	277
AS76NB2	4455	4811	5346	36	15 3/4	85 5/16	84 11/16	320

Veneer species must be noted on each line item

Flush top without profile edge detail, five adjustable shelves, standard black unfinished back panel.

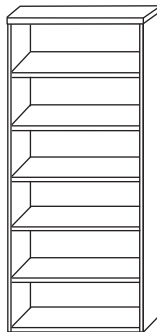

AS75AB2	4280	4622	5136	30	14 7/8	86 11/16	86 1/16	264
AS75BB2	4414	4767	5296	36	14 7/8	86 11/16	86 1/16	307

Veneer species must be noted on each line item

Top with profile edge detail, five adjustable shelves, standard black unfinished back panel.

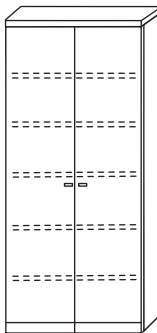

AS76AB2	4599	4967	5519	30	15 3/4	86 11/16	86 1/16	277
AS76BB2	4815	5200	5778	36	15 3/4	86 11/16	86 1/16	320

Veneer species must be noted on each line item

Top with profile edge detail, five adjustable shelves, standard black unfinished back panel.

Veneer species must be noted on each line item

Veneer Grade 1	Veneer Grade 2	Veneer Grade 3
Cherry	Rift Oak	Anigre
Maple	Sapele	
Ligno-Grain		
Walnut		

HBF Ashton Casegoods - Bookcases

Style Number	List Price			Dimensions				Weight
	Veneer 1	Veneer 2	Veneer 3	OW	OD	OH:M	OH:A/F	

Bookcases

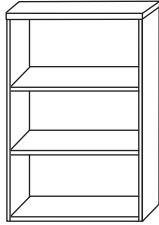

AS75A	2539	2742	3047	30	14 7/8	44	43 3/8	109
AS75B	2693	2909	3232	36	14 7/8	44	43 3/8	131

Veneer species must be noted on each line item

Top profile edge detail, two adjustable shelves, standard black unfinished back.

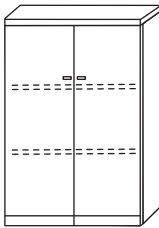

AS76A	3033	3276	3640	30	15 3/4	44	43 3/8	109
AS76B	3188	3443	3825	36	15 3/4	44	43 3/8	131

Veneer species must be noted on each line item

Top profile edge detail, two adjustable shelves, standard black unfinished back.

Lateral Files

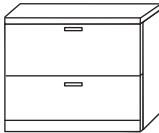

AS37A	2199	2375	2639	30	24	29	29	180
AS37B	2292	2475	2750	36	24	29	29	192
AS37B3	3538	3821	4246	36	24	42 1/4	42 1/4	205
AS37B4	3981	4299	4777	36	24	55 3/4	55 3/4	230
AS38A	2776	2998	3331	30	24 3/4	29	29	182
AS38B	2858	3087	3430	36	24 3/4	29	29	192
AS38B3	4115	4444	4938	36	24 3/4	42 1/4	42 1/4	207
AS38B4	4547	4911	5457	36	24 3/4	55 3/4	55 3/4	232

Veneer species must be noted on each line item

37 lateral files have a standard black unfinished back panel.

38 lateral files have a finished back panel.

37B3 and 38B3 are three high lateral files.

37B4 and 38B4 are four high lateral files.

Veneer species must be noted on each line item

Veneer Grade 1	Veneer Grade 2	Veneer Grade 3
Cherry	Rift Oak	Anigre
Maple	Sapele	
Ligno-Grain		
Walnut		

HBF Ashton Casegoods - Reception Desks

Style Number	List Price			Dimensions			Weight
	Veneer 1	Veneer 2	Veneer 3	OW	OD	OH	

Rectangular Reception Desks, Recessed Modesty Panel

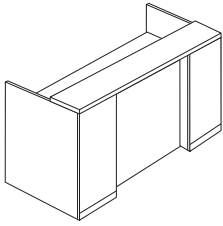

AS81A	8801	9505	10562	72	35	41 3/8	569
AS81B	9667	10440	11600	84	35	41 3/8	589

Veneer species must be noted on each line item

Transaction shelf. 11" OH from bottom of transaction shelf to top of worksurface. Worksurface recessed 1 1/4" from modesty panel to provide access for wire management, grommets not required in desk. One desk pedestal and location (right or left) must be specified. Pedestals must be 18" box/box/file or 18" file/file.

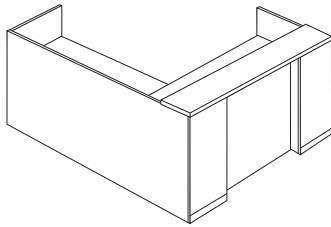

AS82A	10120	10929	12144	72	84 3/8	41 3/8	869
AS82B	10985	11864	13182	84	84 3/8	41 3/8	890

Veneer species must be noted on each line item

Transaction shelf, desk only. 11" OH from bottom of transaction shelf to top of worksurface. Worksurface recessed 1 1/4" from modesty panel to provide access for wire management, grommets not required in desk. One desk pedestal and one return pedestal, along with hand of return, must be specified. Pedestals must be 18" box/box/file or 18" file/file.

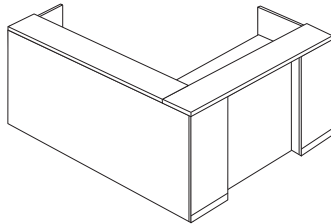

AS83A	10460	11296	12552	72	84 3/8	41 3/8	915
AS83B	11356	12264	13627	84	84 3/8	41 3/8	935

Veneer species must be noted on each line item

Transaction shelf, desk and return. 11" OH from bottom of transaction shelf to top of worksurface. Worksurface recessed 1 1/4" from modesty panel to provide access for wire management, grommets not required in desk. One desk pedestal and one return pedestal, along with hand of return, must be specified. Pedestals must be 18" box/box/file or 18" file/file.

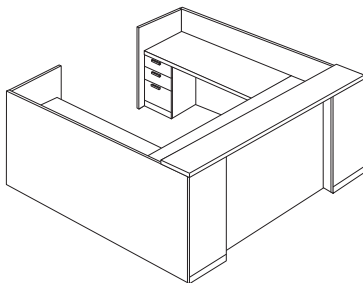

AS87C	12798	13822	15357	90	84 3/8	41 3/8	910
-------	-------	-------	-------	----	--------	--------	-----

Veneer species must be noted on each line item

Transaction shelf, desk only. 11" OH from bottom of transaction shelf to top of worksurface. Worksurface recessed 1 1/4" from modesty panel to provide access for wire management, grommets not required in desk. Both left and right return pedestals must be specified. Pedestals must be 18" box/box/file or 18" file/file.

Veneer species must be noted on each line item

Veneer Grade 1	Veneer Grade 2	Veneer Grade 3
Cherry	Rift Oak	Anigre
Maple	Sapele	
Ligno-Grain		
Walnut		

HBF Ashton Casegoods - Reception Desks

Style Number	List Price			Dimensions			Weight
	Veneer 1	Veneer 2	Veneer 3	OW	OD	OH	

Rectangular Reception Desks, Recessed Modesty Panel

AS88C	13550	14634	16260	90	84 3/8	41 3/8	955
-------	-------	-------	-------	----	--------	--------	-----

Veneer species must be noted on each line item

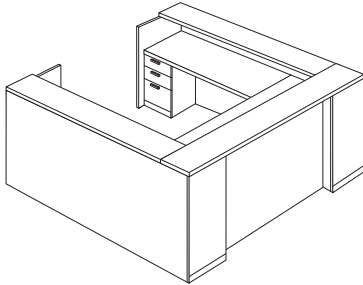

Transaction shelf, desk and both returns. 11" OH from bottom of transaction shelf to top of worksurface. Worksurface recessed 1 1/4" from modesty panel to provide access for wire management, grommets not required in desk. Both left and right return pedestals must be specified. Pedestals must be 18" box/box/file or 18" file/file.

AS87AR	13436	14511	16124	72	107	41 3/8	1289
AS87BR	14209	15346	17051	84	107	41 3/8	1319

Veneer species must be noted on each line item

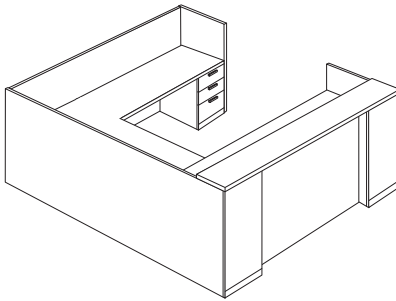

Transaction shelf, desk only. 11" OH from bottom of transaction shelf to top of worksurface. Worksurface recessed 1 1/4" from modesty panel to provide access for wire management, grommets not required in desk. Desk and credenza pedestal along with hand of bridge must be specified. Pedestals must be 18" box/box/file or 18" file/file.

AS88AR	13797	14901	16556	72	107	41 5/8	1335
AS88BR	14569	15735	17483	84	107	41 5/8	1385

Veneer species must be noted on each line item

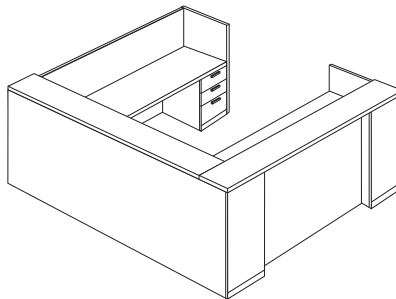

Transaction shelf, desk and return. 11" OH from bottom of transaction shelf to top of worksurface. Worksurface recessed 1 1/4" from modesty panel to provide access for wire management, grommets not required in desk. Desk and credenza pedestal along with hand of bridge must be specified. Pedestals must be 18" box/box/file or 18" file/file.

Bow Front Reception Desks, Recessed Modesty Panel

AS84A	10037	10840	12045	72	39	41 3/8	569
AS84B	10944	11819	13133	84	39	41 3/8	589

Veneer species must be noted on each line item

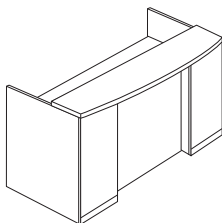

Transaction shelf. 11" OH from bottom of transaction shelf to top of worksurface. Worksurface recessed 1 1/4" from modesty panel to provide access for wire management, grommets not required in desk. Desk pedestal and location (left or right) must be specified. Pedestals must be 18" box/box/file or 18" file/file.

Veneer species must be noted on each line item

Veneer Grade 1	Veneer Grade 2	Veneer Grade 3
Cherry	Rift Oak	Anigre
Maple	Sapele	
Ligno-Grain		
Walnut		

HBF Ashton Casegoods - Reception Desks

Style Number	List Price			Dimensions			Weight
	Veneer 1	Veneer 2	Veneer 3	OW	OD	OH	

Bow Front Reception Desks, Recessed Modesty Panel

AS85A	11356	12264	13627	72	88 3/8	41 3/8	869
AS85B	12231	13210	14678	84	88 3/8	41 3/8	890

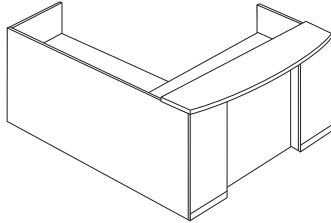

Veneer species must be noted on each line item

Transaction shelf, desk only. 11" OH from bottom of transaction shelf to top of worksurface. Worksurface recessed 1 1/4" from modesty panel to provide access for wire management, grommets not required in desk. One desk pedestal and one return pedestal, along with hand of return, must be specified. Pedestals must be 18" box/box/file or 18" file/file.

AS86A	11737	12676	14084	72	88 3/8	41 3/8	915
AS86B	12602	13610	15122	84	88 3/8	41 3/8	935

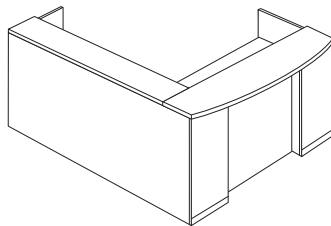

Veneer species must be noted on each line item

Transaction shelf, desk and return. 11" OH from bottom of transaction shelf to top of worksurface. Worksurface recessed 1 1/4" from modesty panel to provide access for wire management, grommets not required in desk. One desk pedestal and one return pedestal, along with hand of return, must be specified. Pedestals must be 18" box/box/file or 18" file/file.

Rectangular Reception Desks, Recessed Modesty Panel

AS89C	14034	15156	16841	90	88 3/8	41 3/8	910
--------------	--------------	--------------	--------------	----	--------	--------	-----

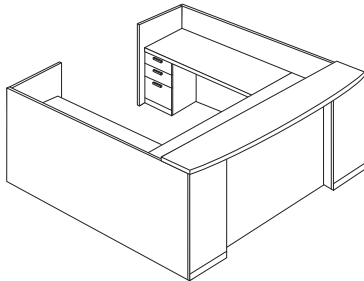

Veneer species must be noted on each line item

Transaction shelf, desk only. 11" OH from bottom of transaction shelf to top of worksurface. Worksurface recessed 1 1/4" from modesty panel to provide access for wire management, grommets not required in desk. Both left and right return pedestals must be specified. Pedestals must be 18" box/box/file or 18" file/file.

AS90C	14806	15991	17768	90	88 3/8	41 3/8	955
--------------	--------------	--------------	--------------	----	--------	--------	-----

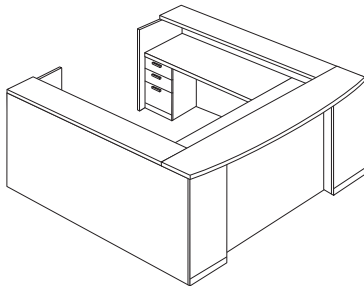

Veneer species must be noted on each line item

Transaction shelf, desk and both returns. 11" OH from bottom of transaction shelf to top of worksurface. Worksurface recessed 1 1/4" from modesty panel to provide access for wire management, grommets not required in desk. Both left and right return pedestals must be specified. Pedestals must be 18" box/box/file or 18" file/file.

Veneer species must be noted on each line item

<u>Veneer Grade 1</u>	<u>Veneer Grade 2</u>	<u>Veneer Grade 3</u>
Cherry	Rift Oak	Anigre
Maple	Sapele	
Ligno-Grain		
Walnut		

HBF Ashton Casegoods - Reception Desks

Style Number	List Price			Dimensions			Weight
	Veneer 1	Veneer 2	Veneer 3	OW	OD	OH	

Rectangular Reception Desks, Recessed Modesty Panel

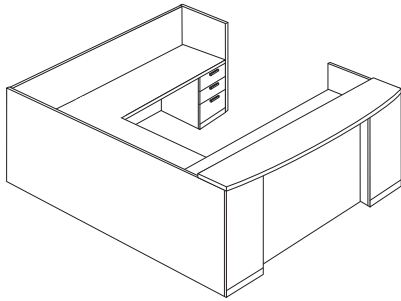

AS (v) 90AR	14724	15902	17669	72	111	41 3/8	1289
AS (v) 90BR	15538	16781	18645	84	111	41 3/8	1319

Veneer species must be noted on each line item

Transaction shelf, desk only. 11" OH from bottom of transaction shelf to top of worksurface. Worksurface recessed 1 1/4" from modesty panel to provide access for wire management, grommets not required in desk. Desk and credenza pedestal, along with hand of bridge, must be specified. Pedestals must be 18" box/box/file or 18" file/file.

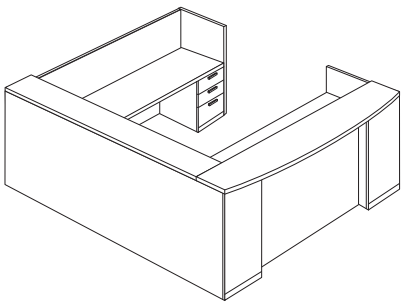

AS (v) 91AR	15084	16291	18101	72	111	41 3/8	1335
AS (v) 91BR	15898	17170	19078	84	111	41 3/8	1385

Veneer species must be noted on each line item

Transaction shelf, desk and return. 11" OH from bottom of transaction shelf to top of worksurface. Worksurface recessed 1 1/4" from modesty panel to provide access for wire management, grommets not required in desk. Desk and credenza pedestal, along with hand of bridge, must be specified. Pedestals must be 18" box/box/file or 18" file/file.

Veneer species must be noted on each line item

<u>Veneer Grade 1</u>	<u>Veneer Grade 2</u>	<u>Veneer Grade 3</u>
Cherry	Rift Oak	Anigre
Maple	Sapele	
Ligno-Grain		
Walnut		

HBF Ashton Accessories

	Style Number	List Price	Dimensions			Weight
			OW	OD	OH	

Stack Shelves

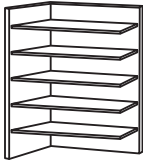

AC97A (S or B)	510	17 1/4	11 1/4	22	10
AC97B (S or B)	561	18	11 1/4	22	12

Indicate S for Satin Pewter powder coat shelves, B for Gloss Black powder coat shelves. Inside back and end are wood veneer panels and will be finished to match the casegood unit; outside back and end panels are standard black unfinished. AC97A is intended to be used with overhead cabinets with wood panel support; AC97B is used with wall mount overhead cabinets.

Worksurface Shelves



AC97C (S or B)-36	438	36	9 1/4	3 1/4	24
AC97C (S or B)-42	438	42	9 1/4	3 1/4	25
AC97C (S or B)-48	438	48	9 1/4	3 1/4	26
AC97C (S or B)-54	438	54	9 1/4	3 1/4	28
AC97C (S or B)-60	489	60	9 1/4	3 1/4	30
AC97C (S or B)-66	489	66	9 1/4	3 1/4	31
AC97C (S or B)-72	489	72	9 1/4	3 1/4	32
AC97C (S or B)-78	561	78	9 1/4	3 1/4	34
AC97C (S or B)-84	561	84	9 1/4	3 1/4	36
AC97C (S or B)-90	561	90	9 1/4	3 1/4	38
AC97C (S or B)-96	561	96	9 1/4	3 1/4	40
AC97C (S or B)-102	613	102	9 1/4	3 1/4	42
AC97C (S or B)-108	613	108	9 1/4	3 1/4	44
AC97C (S or B)-114	613	114	9 1/4	3 1/4	46
AC97C (S or B)-120	613	120	9 1/4	3 1/4	48

Indicate S for Satin Pewter powder coat shelves, B for Gloss Black powder coat shelves. Shelf supports are Gloss Black powder coat.

Pedestal Shelves (Set of Four)

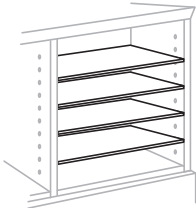

AC97D (S or B)-18	149	16 1/2	11 1/8		
AC97D (S or B)-30	149	13 7/8	11 1/8		
AC97D (S or B)-36	149	16 7/8	11 1/8		

Indicate S for Satin Pewter powder coat shelves, B for Gloss Black powder coat shelves.

Pedestal Dividers (Set of Three)

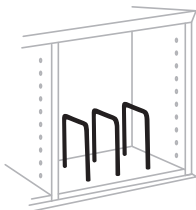

AC97E	36			6 1/4	
-------	----	--	--	-------	--

Metal wire dividers are Satin Nickel finish.

HBF Ashton Conference Table Specifications

Tables with Wood Bases

Veneer Premium grade flat cut veneer tops. Edges are bordered with veneer solids or edgebands.

Top Edge Detail

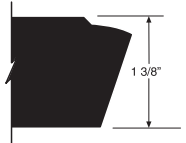

Ashton

Worksurfaces Ashton has a 1 3/8" (35mm) thick top.

Base Options

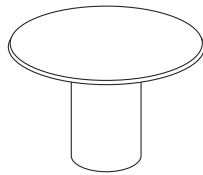

**Wood Column Base
Round**

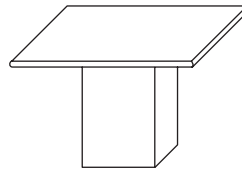

**Wood Column Base
Square**

Round and Square Tables with Single Wood Base

Round Metal Grommet Power/Data Plate

Ashton Conference Tables with single wood bases are available with a compact power/data unit with a removable grommet cover. The round grommet is standard in HBF Satin Pewter powder coat finish. Grommet mounts flush with the top surface.

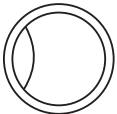

Tables specifying power/data capabilities will be equipped with a power/data unit that provides two (2) 110 volt electrical outlets and two (2) Cat.5E data jacks. This unit is hardwired and must be installed by a licensed electrician. Bases for tables with power/data access incorporate a hinged wood door on the side of the base to allow access to floor connections.



The electrical components provided within this group of furniture are engineered and manufactured in compliance with NEC regulation, however ***it is the responsibility of the specifier and contracted installer of the furniture to be aware of the local building and electrical restrictions.*** Electrical components meet both Chicago and New York electrical codes.

Additional voice/data inserts are available to replace the standard data jacks. These inserts can be ordered from Doug Mockett & Company (www.mockett.com) and installed as required by the end user's data specialist to accommodate specific requirements.

HBF Ashton Conference Table Specifications

Rectangular, Boat and Elliptical Tables with Multiple Wood Bases

Round Metal Grommet Power/Data Plate

Ashton Conference Tables with multiple wood bases are available with either a round or oval grommet and power/data access units. Bases for tables with power/data access incorporate a hinged wood door on the side of the base to allow access to floor connections.

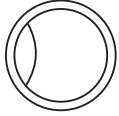

The removable round grommet is standard in HBF Satin Pewter powder coat finish and mounts flush with the top surface. The power/data unit provides two (2) 110 volt electrical outlets and two (2) Cat.5E data jacks. This unit is hardwired and must be installed by a licensed electrician.



The hinged oval grommet is standard in HBF Satin Pewter powder coat finish and mounts flush with the top surface. The power/data unit provides four (4) 110 volt electrical outlets and six (6) Cat.5E data jacks. This unit is hardwired and must be installed by a licensed electrician.

The electrical components provided within this group of furniture are engineered and manufactured in compliance with NEC regulation, however **it is the responsibility of the specifier and contracted installer of the furniture to be aware of the local building and electrical restrictions.** Electrical components meet both Chicago and New York electrical codes.

Oval Metal Grommet Power/Data Plate

Additional voice/data inserts are available to replace the standard data jacks. These inserts can be ordered from Doug Mockett & Company (www.mockett.com) and installed as required by the end user's data specialist to accommodate specific requirements.

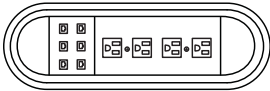
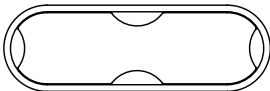

Pedestal Bases

Round and square pedestal bases for tables specifying power/data access incorporate a hinged wood door to provide easy access to the inside of the base.

Wood Column Base Placement

Note: In style numbers "Y" equals a round base, "I" equals a square base.

Wood Column Base Placement Locations						
Table Dimension	Top Size Designation		A	B	C	D
	Non-electrical	Electrical				
48" x 96"	E	S	15"	30"	(2) 18"	15"
48" x 108"	F	G	15"	42"	(2) 18"	15"
48" x 120"	G	V	15"	54"	(2) 18"	15"
54" x 120" ellipse	G	V	15"	(2) 25"	(2) 18"	18"
54" x 144"	H	W	17"	(2) 25"	(2) 18" / (1) 24"	15" / 18"
54" / 60" x 168"	J	X	18"	(2) 27"	(2) 24" / (1) 30"	12" / 15"
54" / 60" x 192"	K	Y	21"	(2) 36"	(2) 24" / (1) 30"	12" / 15"
60" x 216"	L	Z	27"	(2) 42"	(2) 24" / (1) 30"	15" / 18"

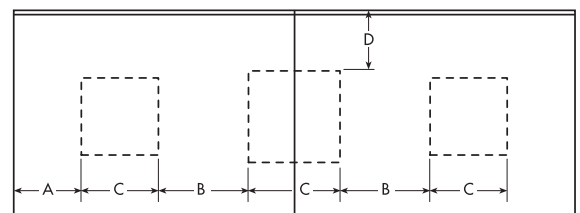
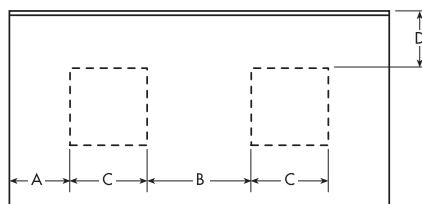

HBF Ashton Conference Tables

Style Number	List Price			Dimensions			DIA	Weight
	Veneer 1	Veneer 2	Veneer 3	OW	OD	OH		

Wood Bases

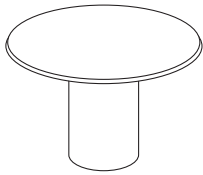

AS74A-Y	3570	3856	4284			29	42	120
AS74B-Y	3810	4115	4572			29	48	133
AS74C-Y	4100	4428	4920			29	54	149
AS74D-Y	4425	4779	5310			29	60	165

Veneer species must be noted on each line item
Wood column base.

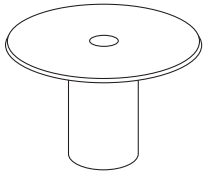

AS74A-YRH1	4305	4649	5166			29	42	130
AS74B-YRH1	4545	4909	5454			29	48	143
AS74C-YRH1	4835	5222	5802			29	54	159
AS74D-YRH1	5160	5573	6192			29	60	175

Veneer species must be noted on each line item
Wood column base, round electrical access grommet.

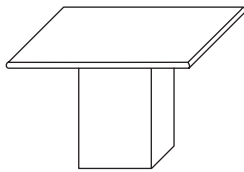

AS77A-I	3260	3521	3912	42	42	29		132
AS77B-I	3500	3780	4200	48	48	29		148
AS77C-I	3785	4088	4542	54	54	29		168
AS77D-I	4100	4428	4920	60	60	29		182

Veneer species must be noted on each line item
Wood column base.

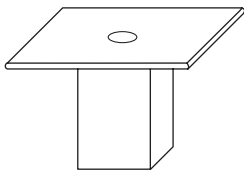

AS77A-IRH1	3995	4315	4794	42	42	29		142
AS77B-IRH1	4235	4574	5082	48	48	29		158
AS77C-IRH1	4520	4882	5424	54	54	29		178
AS77D-IRH1	4835	5222	5802	60	60	29		192

Veneer species must be noted on each line item
Wood column base, round electrical access grommet.

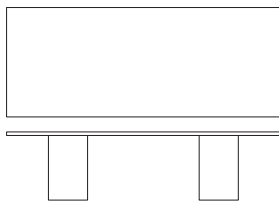

AS78E-I	5855	6323	7026	96	48	29		320
AS78F-I	6875	7425	8250	108	48	29		335
AS78G-I	7520	8122	9024	120	48	29		353

Veneer species must be noted on each line item
Wood column base.

Veneer species must be noted on each line item

Veneer Grade 1	Veneer Grade 2	Veneer Grade 3
Cherry	Rift Oak	Anigre
Maple	Sapele	
Ligno-Grain		
Walnut		

HBF Ashton Conference Tables

Style Number	List Price			Dimensions			Weight
	Veneer 1	Veneer 2	Veneer 3	OW	OD	OH	

Wood Bases

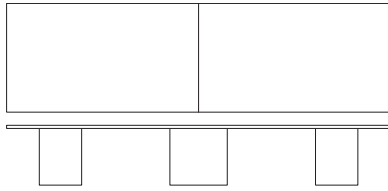

AS78H-I	9485	10244	11382	144	54	29	581
AS78J-I	10455	11291	12546	168	54	29	622
AS78K-I	12080	13046	14496	192	54	29	662
AS78L-I	12725	13743	15270	216	60	29	743

Veneer species must be noted on each line item

Two-piece top, wood column base.

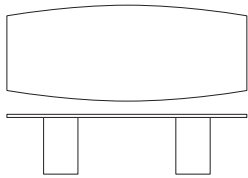

AS80E-Y	7035	7598	8442	96	48	29	298
AS80F-Y	8090	8737	9708	108	48	29	321
AS80G-Y	8775	9477	10530	120	48	29	339

Veneer species must be noted on each line item

Boat top, wood column bases.

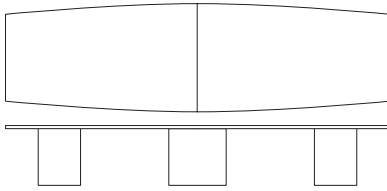

AS80H-Y	10345	11173	12414	144	54	29	545
AS80J-Y	11325	12231	13590	168	54	29	586
AS80K-Y	12940	13975	15528	192	60	29	626
AS80L-Y	13585	14672	16302	216	60	29	707

Veneer species must be noted on each line item

Boat two-piece top, wood column bases.

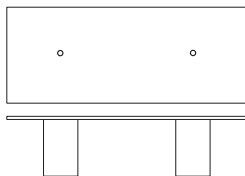

AS78E-IRH2	7325	7911	8790	96	48	29	320
AS78F-IRH2	8345	9013	10014	108	48	29	335
AS78G-IRH2	8990	9709	10788	120	48	29	353

Veneer species must be noted on each line item

Wood column bases, round electrical access grommets.

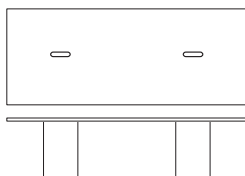

AS78E-IOH2	7745	8365	9294	96	48	29	320
AS78F-IOH2	8765	9466	10518	108	48	29	335
AS78G-IOH2	9410	10163	11292	120	48	29	353

Veneer species must be noted on each line item

Wood column bases, oval electrical access grommets.

Veneer species must be noted on each line item

Veneer Grade 1	Veneer Grade 2	Veneer Grade 3
Cherry	Rift Oak	Anigre
Maple	Sapele	
Ligno-Grain		
Walnut		

HBF Ashton Conference Tables

Style Number	List Price			Dimensions			Weight
	Veneer 1	Veneer 2	Veneer 3	OW	OD	OH	

Wood Bases

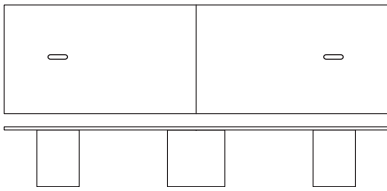

AS78H-IOH2	11375	12285	13650	144	54	29	581
AS78J-IOH2	12345	13333	14814	168	54	29	622
AS78K-IOH2	13970	15088	16764	192	60	29	662
AS78L-IOH2	14615	15784	17538	216	60	29	743

Veneer species must be noted on each line item

Two-piece top, wood column bases, oval electrical access grommets.

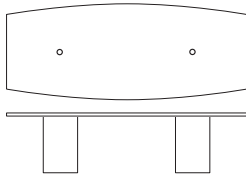

AS80E-YRH2	8505	9185	10206	96	48	29	298
AS80F-YRH2	9560	10325	11472	108	48	29	321
AS80G-YRH2	10245	11065	12294	120	48	29	339

Veneer species must be noted on each line item

Boat top, wood column bases, round electrical access grommets.

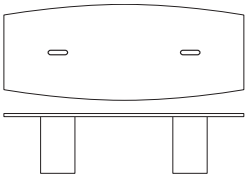

AS80E-YOH2	8925	9639	10710	96	48	29	298
AS80F-YOH2	9980	10778	11976	108	48	29	321
AS80G-YOH2	10665	11518	12798	120	48	29	339

Veneer species must be noted on each line item

Boat top, wood column bases, oval electrical access grommets.

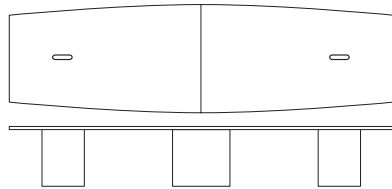

AS80H-YOH2	12235	13214	14682	144	54	29	545
AS80J-YOH2	13215	14272	15858	168	54	29	586
AS80K-YOH2	14830	16016	17796	192	60	29	626
AS80L-YOH2	15475	16713	18570	216	60	29	707

Veneer species must be noted on each line item

Boat two-piece top, wood column bases, oval electrical access grommets.

Veneer species must be noted on each line item

Veneer Grade 1	Veneer Grade 2	Veneer Grade 3
Cherry	Rift Oak	Anigre
Maple	Sapele	
Ligno-Grain		
Walnut		

HBF Ashton Conference Table Specifications

Tables with Metal Bases

Veneer Premium grade flat cut veneer tops. Edges are bordered with solids.

Top Edge Detail

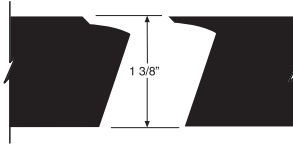

Ashton

Worksurfaces Ashton has a 1 3/8"(35mm) thick top.

Base Options

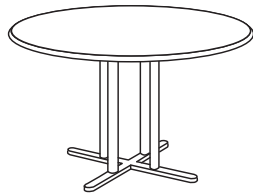

**Metal X-Base
for Round Tables**

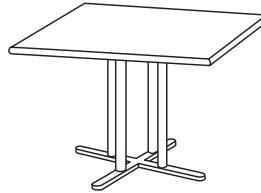

**Metal X-Base
for Square Tables**

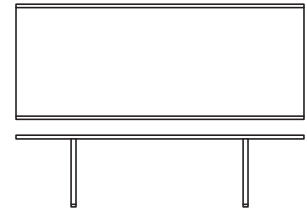

**Metal I-Bases
for Rectangular Tables**

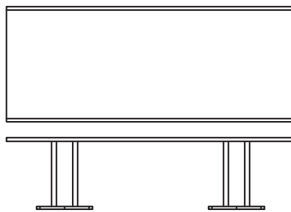

**Metal X-Bases
for Rectangular Tables**

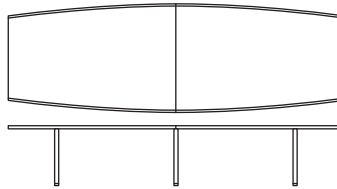

**Metal I-Bases
for Boat Shape Tables**

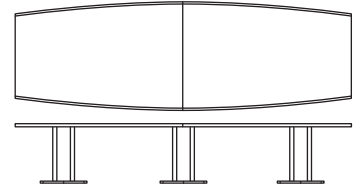

**Metal X-Bases
for Boat Shape Tables**

Metal Bases

Metal bases are available in an I-Base or an X-Base. These bases are standard in HBF Satin Pewter powder coat finish. Refer to individual styles to determine base shape available on particular conference tables. Metal bases for tables specifying power/data capabilities incorporate wire management channels.

HBF Ashton Conference Table Specifications

Tables with Metal Bases

Round Metal Grommet Power Data Plate

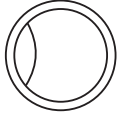

Ashton Conference Tables with metal bases are available with either a round or oval grommet and power/data access units. Bases for tables with power/data access incorporate wire management channels.

The removable round grommet is standard in HBF Satin Pewter powder coat finish and mounts flush with the top surface. The power/data unit provides two (2) 110 volt electrical outlets and two (2) Cat.5E data jacks. This unit uses a six foot soft cord with a grounded plug.



The hinged oval grommet is standard in HBF Satin Pewter powder coat finish and mounts flush with the top surface. The power/data unit provides four (4) 110 volt electrical outlets and six (6) Cat.5E data jacks. This unit uses a six foot soft cord with a grounded plug.

Oval Metal Grommet Power Data Plate

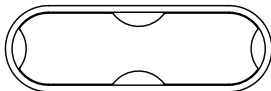

The electrical components provided within this group of furniture are engineered and manufactured in compliance with NEC regulation, however ***it is the responsibility of the specifier and contracted installer of the furniture to be aware of the local building and electrical restrictions.*** Electrical components meet both Chicago and New York electrical codes.

Additional voice/data inserts are available to replace the standard data jacks. These inserts can be ordered from Doug Mockett & Company (www.mockett.com) and installed as required by the end user's data specialist to accommodate specific requirements.

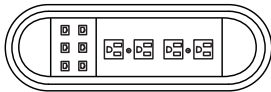

HBF Ashton Conference Tables

Style Number	List Price			Dimensions			DIA	Weight
	Veneer 1	Veneer 2	Veneer 3	OW	OD	OH		

Metal Bases

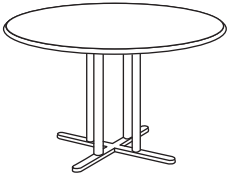

AS74A-E	2800	3024	3360			29	42	125
AS74B-E	3090	3337	3708			29	48	140
AS74C-E	3570	3856	4284			29	54	155
AS74D-E	4055	4379	4866			29	60	170

Veneer species must be noted on each line item

Metal X-Base.



AS74A-ERS1	3535	3818	4242			29	42	125
AS74B-ERS1	3825	4131	4590			29	48	140
AS74C-ERS1	4305	4649	5166			29	54	155
AS74D-ERS1	4790	5173	5748			29	60	170

Veneer species must be noted on each line item

Metal X-Base, round electrical access grommet.

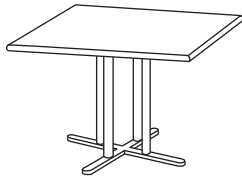

AS77A-E	2700	2916	3240	42	42	29		140
AS77B-E	2990	3229	3588	48	48	29		155
AS77C-E	3380	3650	4056	54	54	29		175

Veneer species must be noted on each line item

Metal X-Base.

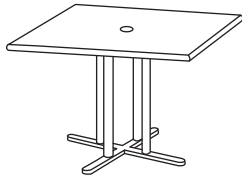

AS77A-ERS1	3380	3650	4056	42	42	29		145
AS77B-ERS1	3670	3964	4404	48	48	29		160
AS77C-ERS1	4055	4379	4866	54	54	29		180

Veneer species must be noted on each line item

Metal X-Base, round electrical access grommet.

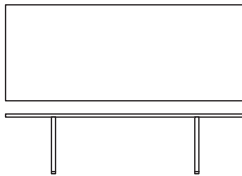

AS78C-S	3560	3845	4272	72	36	29		190
AS78D-S	4095	4423	4914	84	42	29		220
AS78E-S	4675	5049	5610	96	48	29		260
AS78F-S	5545	5989	6654	108	48	29		280
AS78G-S	6605	7133	7926	120	48	29		300

Veneer species must be noted on each line item

Metal I-Bases.

Veneer species must be noted on each line item

Veneer Grade 1	Veneer Grade 2	Veneer Grade 3
Cherry	Rift Oak	Anigre
Maple	Sapele	
Ligno-Grain		
Walnut		

HBF Ashton Conference Tables

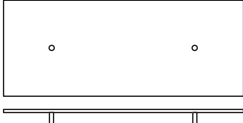
Style Number	List Price			Dimensions			Weight	
	Veneer 1	Veneer 2	Veneer 3	OW	OD	OH		
Metal Bases								
	AS78C-SRS2	5030	5432	6036	72	36	29	190
	AS78D-SRS2	5565	6010	6678	84	42	29	220
	AS78E-SRS2	6145	6637	7374	96	48	29	260
	AS78F-SRS2	7015	7576	8418	108	48	29	280
	AS78G-SRS2	8075	8721	9690	120	48	29	300

Veneer species must be noted on each line item

Metal I-Bases, two round electrical access grommets.

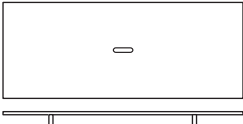
	AS78C-SOS1	4505	4865	5406	72	36	29	195
	AS78D-SOS1	5040	5443	6048	84	42	29	225
	AS78E-SOS1	5620	6070	6744	96	48	29	265
	AS78F-SOS1	6490	7009	7788	108	48	29	285
	AS78G-SOS1	7550	8154	9060	120	48	29	305

Veneer species must be noted on each line item

Metal I-Bases, oval electrical access grommet.

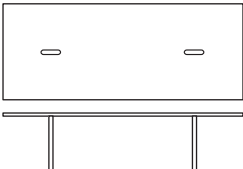
	AS78G-SOS2	8495	9175	10194	120	48	29	310
--	------------	------	------	-------	-----	----	----	-----

Veneer species must be noted on each line item

Metal I-Bases, two oval electrical access grommets.

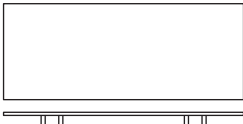
	AS78C-E	4400	4752	5280	72	36	29	230
	AS78D-E	4935	5330	5922	84	42	29	260
	AS78E-E	5515	5956	6618	96	48	29	295
	AS78F-E	6385	6896	7662	108	48	29	320
	AS78G-E	7445	8041	8934	120	48	29	335

Veneer species must be noted on each line item

Metal X-Bases.

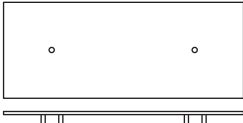
	AS78C-ERS2	5870	6340	7044	72	36	29	230
	AS78D-ERS2	6405	6917	7686	84	42	29	260
	AS78E-ERS2	6985	7544	8382	96	48	29	295
	AS78F-ERS2	7855	8483	9426	108	48	29	320
	AS78G-ERS2	8915	9628	10698	120	48	29	335

Veneer species must be noted on each line item

Metal X-Bases, two round electrical access grommets.

Veneer species must be noted on each line item

<u>Veneer Grade 1</u>	<u>Veneer Grade 2</u>	<u>Veneer Grade 3</u>
Cherry	Rift Oak	Anigre
Maple	Sapele	
Ligno-Grain		
Walnut		

HBF Ashton Conference Tables

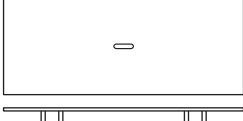
Style Number	List Price			Dimensions			Weight	
	Veneer 1	Veneer 2	Veneer 3	OW	OD	OH		
	AS78C-EOS1	5345	5773	6414	72	36	29	195
	AS78D-EOS1	5880	6350	7056	84	42	29	225
	AS78E-EOS1	6460	6977	7752	96	48	29	265
	AS78F-EOS1	7330	7916	8796	108	48	29	285
	AS78G-EOS1	8390	9061	10068	120	48	29	305

Veneer species must be noted on each line item

Metal X-Bases, oval electrical access grommet.

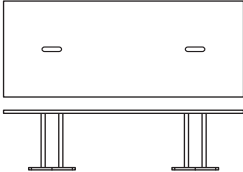
	AS78G-EOS2	9335	10082	11202	120	48	29	310
---	------------	------	-------	-------	-----	----	----	-----

Veneer species must be noted on each line item

Metal X-Bases, two oval electrical access grommets.

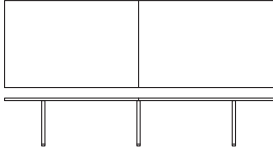
	AS78H-S	9020	9742	10824	144	54	29	420
	AS78J-S	9890	10681	11868	168	54	29	460

Veneer species must be noted on each line item

Two-piece top, metal I-Bases.

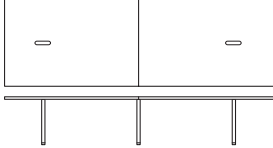
	AS78H-SOS2	10910	11783	13092	144	54	29	430
	AS78J-SOS2	11780	12722	14136	168	54	29	470

Veneer species must be noted on each line item

Two-piece top, metal I-Bases, two oval electrical access grommets.

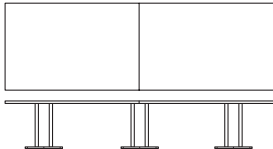
	AS78H-E	10280	11102	12336	144	54	29	475
	AS78J-E	11150	12042	13380	168	54	29	520

Veneer species must be noted on each line item

Two-piece top, metal X-Bases.

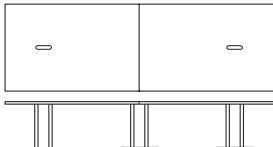
	AS78H-EOS2	12170	13144	14604	144	54	29	485
	AS78J-EOS2	13040	14083	15648	168	54	29	530

Veneer species must be noted on each line item

Two-piece top, metal X-Bases, two oval electrical access grommets.

Veneer species must be noted on each line item

Veneer Grade 1	Veneer Grade 2	Veneer Grade 3
Cherry	Rift Oak	Anigre
Maple	Sapele	
Ligno-Grain		
Walnut		

HBF Ashton Conference Tables

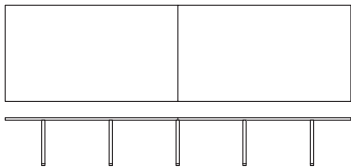
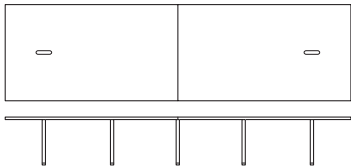
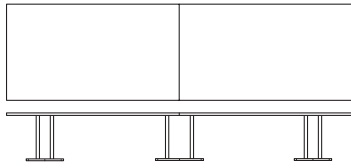
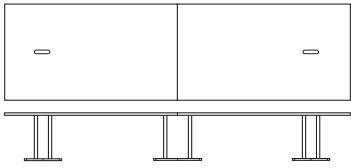
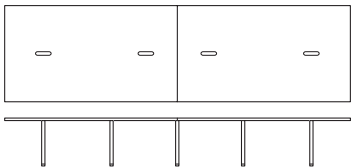
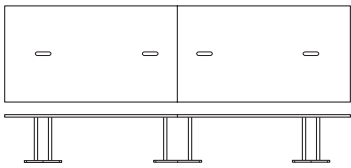
Style Number	List Price			Dimensions			Weight															
	Veneer 1	Veneer 2	Veneer 3	OW	OD	OH																
Metal Bases																						
	AS78K-S	10855	11723	13026	192	54	29	585														
	AS78L-S	12505	13505	15006	216	60	29	670														
<p>Veneer species must be noted on each line item</p> <p>Two-piece top, metal I-Bases.</p>																						
	AS78K-SOS2	12745	13765	15294	192	54	29	595														
	AS78L-SOS2	14395	15547	17274	216	60	29	680														
<p>Veneer species must be noted on each line item</p> <p>Two-piece top, metal I-Bases, two oval electrical access grommets.</p>																						
	AS78K-E	11275	12177	13530	192	54	29	560														
	AS78L-E	12925	13959	15510	216	60	29	640														
<p>Veneer species must be noted on each line item</p> <p>Two-piece top, metal X-Bases.</p>																						
	AS78K-EOS2	13165	14218	15798	192	54	29	570														
	AS78L-EOS2	14815	16000	17778	216	60	29	650														
<p>Veneer species must be noted on each line item</p> <p>Two-piece top, metal X-Bases, two oval electrical access grommets.</p>																						
	AS78K-SOS4	14635	15806	17562	192	54	29	605														
	AS78L-SOS4	16285	17588	19542	216	60	29	690														
<p>Veneer species must be noted on each line item</p> <p>Two-piece top, metal I-Bases, four oval electrical access grommets.</p>																						
	AS78K-EOS4	15055	16259	18066	192	54	29	580														
	AS78L-EOS4	16705	18041	20046	216	60	29	660														
<p>Veneer species must be noted on each line item</p> <p>Two-piece top, metal X-Bases, four oval electrical access grommets.</p>																						
<p>Veneer species must be noted on each line item</p> <table border="0"> <tr> <td><u>Veneer Grade 1</u></td> <td><u>Veneer Grade 2</u></td> <td><u>Veneer Grade 3</u></td> </tr> <tr> <td>Cherry</td> <td>Rift Oak</td> <td>Anigre</td> </tr> <tr> <td>Maple</td> <td>Sapele</td> <td></td> </tr> <tr> <td>Ligno-Grain</td> <td></td> <td></td> </tr> <tr> <td>Walnut</td> <td></td> <td></td> </tr> </table>								<u>Veneer Grade 1</u>	<u>Veneer Grade 2</u>	<u>Veneer Grade 3</u>	Cherry	Rift Oak	Anigre	Maple	Sapele		Ligno-Grain			Walnut		
<u>Veneer Grade 1</u>	<u>Veneer Grade 2</u>	<u>Veneer Grade 3</u>																				
Cherry	Rift Oak	Anigre																				
Maple	Sapele																					
Ligno-Grain																						
Walnut																						

HBF Ashton Conference Tables

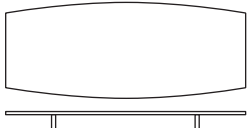
Style Number	List Price			Dimensions			Weight	
	Veneer 1	Veneer 2	Veneer 3	OW	OD	OH		
Metal Bases								
	AS80C-S	4240	4579	5088	72	36	29	190
	AS80D-S	4770	5152	5724	84	42	29	220
	AS80E-S	5350	5778	6420	96	48	29	260
	AS80F-S	6220	6718	7464	108	48	29	280
	AS80G-S	6895	7447	8274	120	48	29	300

Veneer species must be noted on each line item

Boat top, metal I-Bases.

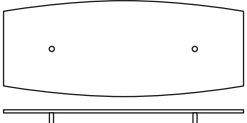
	AS80C-SRS2	5710	6167	6852	72	36	29	200
	AS80D-SRS2	6240	6739	7488	84	42	29	230
	AS80E-SRS2	6820	7366	8184	96	48	29	270
	AS80F-SRS2	7690	8305	9226	108	48	29	290
	AS80G-SRS2	8365	9034	10038	120	48	29	310

Veneer species must be noted on each line item

Boat top, metal I-Bases, two round electrical access grommets.

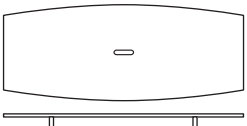
	AS80C-SOS1	5185	5600	6222	72	36	29	200
	AS80D-SOS1	5715	6172	6858	84	42	29	230
	AS80E-SOS1	6295	6799	7554	96	48	29	270
	AS80F-SOS1	7165	7738	8598	108	48	29	290
	AS80G-SOS1	7840	8467	9408	120	48	29	310

Veneer species must be noted on each line item

Boat top, metal I-Bases, one oval electrical access grommet.

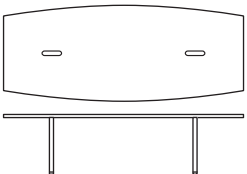
	AS80G-SOS2	8785	9488	10542	120	48	29	310
---	------------	------	------	-------	-----	----	----	-----

Veneer species must be noted on each line item

Boat top, metal I-Bases, two oval electrical access grommets.

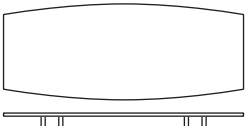
	AS80C-E	5080	5486	6096	72	36	29	230
	AS80D-E	5610	6059	6732	84	42	29	260
	AS80E-E	6190	6685	7428	96	48	29	295
	AS80F-E	7060	7625	8472	108	48	29	320
	AS80G-E	7735	8354	9282	120	48	29	335

Veneer species must be noted on each line item

Boat top, metal X-Bases.

Veneer species must be noted on each line item

Veneer Grade 1	Veneer Grade 2	Veneer Grade 3
Cherry	Rift Oak	Anigre
Maple	Sapele	
Ligno-Grain		
Walnut		

HBF Ashton Conference Tables

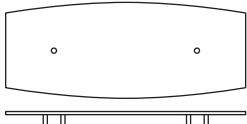
Style Number	List Price			Dimensions			Weight	
	Veneer 1	Veneer 2	Veneer 3	OW	OD	OH		
Metal Bases								
	AS80C-ERS2	6550	7074	7860	72	36	29	190
	AS80D-ERS2	7080	7646	8496	84	42	29	220
	AS80E-ERS2	7660	8273	9192	96	48	29	260
	AS80F-ERS2	8530	9212	10236	108	48	29	280
	AS80G-ERS2	9205	9941	11046	120	48	29	300

Veneer species must be noted on each line item

Boat top, metal X-Bases, two round electrical access grommets.

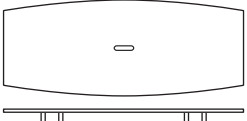
	AS80C-EOS1	6025	6507	7230	72	36	29	235
	AS80D-EOS1	6555	7079	7866	84	42	29	265
	AS80E-EOS1	7135	7706	8562	96	48	29	300
	AS80F-EOS1	8005	8645	9606	108	48	29	325
	AS80G-EOS1	8680	9374	10416	120	48	29	340

Veneer species must be noted on each line item

Boat top, metal X-Bases, one oval electrical access grommet.

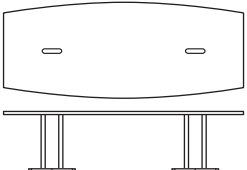
	AS80G-EOS2	9625	10395	11550	120	48	29	345
	Veneer species must be noted on each line item							
Boat top, metal X-Bases, two oval electrical access grommets.								

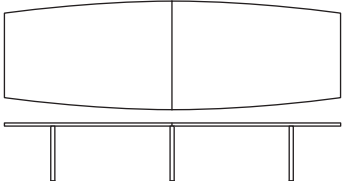
	AS80H-S	9310	10055	11172	144	54	29	420
	AS80J-S	10180	10994	12216	168	54	29	460
Veneer species must be noted on each line item								
Boat two-piece top, metal I-Bases.								

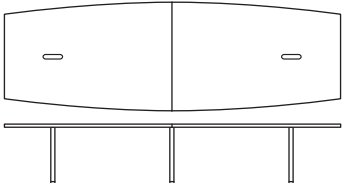
	AS80H-SOS2	11200	12096	13440	144	54	29	430
	AS80J-SOS2	12070	13036	14484	168	54	29	470
Veneer species must be noted on each line item								
Boat two-piece top, metal I-Bases, two oval electrical access grommets.								

Veneer species must be noted on each line item

Veneer Grade 1	Veneer Grade 2	Veneer Grade 3
Cherry	Rift Oak	Anigre
Maple	Sapele	
Ligno-Grain		
Walnut		

HBF Ashton Conference Tables

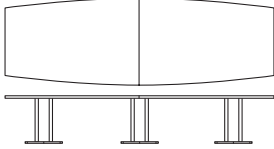
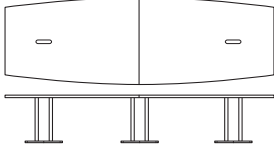
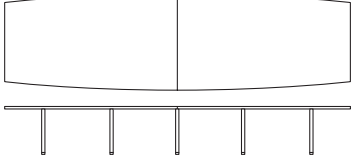
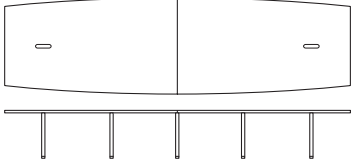
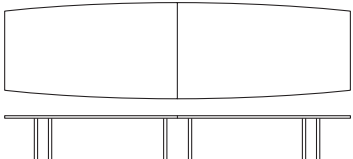
Style Number	List Price			Dimensions			DIA	Weight
	Veneer 1	Veneer 2	Veneer 3	OW	OD	OH		
Metal Bases								
	AS80H-E	10570	11416	12684	144	54	29	475
	AS80J-E	11440	12355	13728	168	54	29	520
<p>Veneer species must be noted on each line item</p> <p>Boat two-piece top, metal X-Bases.</p>								
	AS80H-EOS2	12460	13457	14952	144	54	29	485
	AS80J-EOS2	13330	14396	15996	168	54	29	530
<p>Veneer species must be noted on each line item</p> <p>Boat two-piece top, metal X-Bases, two oval electrical access grommets.</p>								
	AS80K-S	11145	12037	13374	144	60	29	485
	AS80L-S	12795	13819	15354	168	60	29	530
<p>Veneer species must be noted on each line item</p> <p>Boat two-piece top, metal I-Bases.</p>								
	AS80K-SOS2	13035	14078	15642	192	60	29	570
	AS80L-SOS2	14685	15860	17622	216	60	29	650
<p>Veneer species must be noted on each line item</p> <p>Boat two-piece top, metal I-Bases, two oval electrical access grommets.</p>								
	AS80K-E	11565	12490	13878	192	60	29	585
	AS80L-E	13215	14272	15858	216	60	29	670
<p>Veneer species must be noted on each line item</p> <p>Boat two-piece top, metal X-Bases.</p>								

Veneer species must be noted on each line item

<u>Veneer Grade 1</u>	<u>Veneer Grade 2</u>	<u>Veneer Grade 3</u>
Cherry	Rift Oak	Anigre
Maple	Sapele	
Ligno-Grain		
Walnut		

HBF Ashton Conference Tables

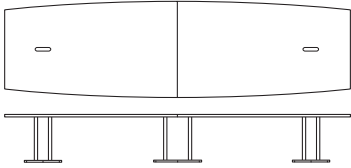
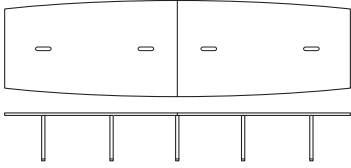
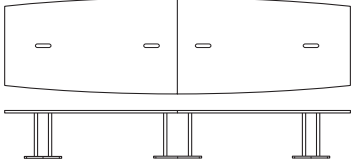
Style Number	List Price			Dimensions			DIA	Weight
	Veneer 1	Veneer 2	Veneer 3	OW	OD	OH		
Metal Bases								
	AS80K-EOS2	13455	14531	16146	192	54	29	595
	AS80L-EOS2	15105	16313	18126	216	60	29	680
Veneer species must be noted on each line item								
Boat two-piece top, metal X-Bases, two oval electrical access grommets.								
	AS80K-SOS4	14925	16119	17910	192	60	29	580
	AS80L-SOS4	16575	17901	19890	216	60	29	660
Veneer species must be noted on each line item								
Boat two-piece top, metal I-Bases, four oval electrical access grommets.								
	AS80K-EOS4	15345	16573	18414	192	60	29	580
	AS80L-EOS4	16995	18355	20394	216	60	29	660
Veneer species must be noted on each line item								
Boat two-piece top, metal X-Bases, four oval electrical access grommets.								

Veneer species must be noted on each line item

<u>Veneer Grade 1</u>	<u>Veneer Grade 2</u>	<u>Veneer Grade 3</u>
Cherry	Rift Oak	Anigre
Maple	Sapele	
Ligno-Grain		
Walnut		

HBF Ashton Conference Cabinetry

Style Number	List Price			Dimensions				Weight
	Veneer 1	Veneer 2	Veneer 3	OW	OD	OH	DIA	

Audio Visual Cart

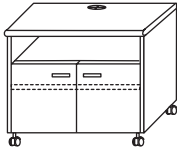

AS53A	2855	3083	3426	36	24	29	192
-------	------	------	------	----	----	----	-----

Veneer species must be noted on each line item

Cart with open shelf. Lower storage compartment has one adjustable shelf, back is fully finished, casters. Power/communication strip mounted in back of cabinet, includes four electrical outlets and one cable line. Optional black power/data unit can be supplied to mount on any surface of cart. Softwired unit provides two 110 volt electrical outlets and two data jacks. Specify AC96NB, add \$295 List.

Audio Visual Storage Cabinet, Top without Profile Edge Detail

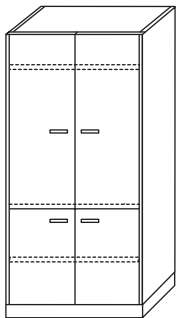

AS53D	6800	7344	8160	38	30	71	271
-------	------	------	------	----	----	----	-----

Veneer species must be noted on each line item

Standard black unfinished back. Power/communication strip mounted in back of cabinet and includes four electrical outlets and one cable line. Upper storage area accessed through pocket doors. The extendable turntable supports up to 200 lbs., interior dimensions of upper storage area are 31" OW x 29" OD x 40 1/4 OH.

Audio Visual Storage Cabinet, Top with Profile Edge Detail

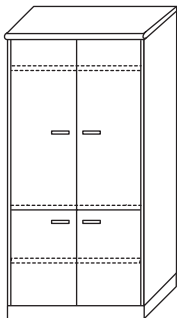

AS53D-C	7200	7776	8640	38	30	72 1/2	286
---------	------	------	------	----	----	--------	-----

Veneer species must be noted on each line item

Standard black unfinished back. Power/communication strip mounted in back of cabinet and includes four electrical outlets and one cable line. Upper storage area accessed through pocket doors. The extendable turntable supports up to 200 lbs., interior dimensions of upper storage area are 31" OW x 29" OD x 40 1/4 OH.

Wall Mounted Presentation Cabinet, Top without Profile Edge Detail

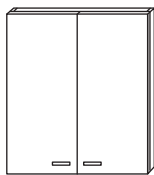

AS37M	2225	2403	2670	48	7	48	210
-------	------	------	------	----	---	----	-----

AS37N	2880	3110	3456	60	7	48	210
-------	------	------	------	----	---	----	-----

Veneer species must be noted on each line item

Presentation cabinet, white marker board (markers and eraser included), pull down projection screen, wood pencil/marker tray. Fabric covered tackboards on inside of each door, fabric requirement is 3 yards per unit. List price includes application of COM, COM must be acrylic backed prior to shipment to HBF. For specification of any HBF Textiles product, add 5% List.

Veneer species must be noted on each line item

Veneer Grade 1	Veneer Grade 2	Veneer Grade 3
Cherry	Rift Oak	Anigre
Maple	Sapele	
Ligno-Grain		
Walnut		

HBF Ashton Conference Cabinetry

Style Number	List Price			Dimensions				Weight
	Veneer 1	Veneer 2	Veneer 3	OW	OD	OH	DIA	

Wall Mounted Presentation Cabinet, Top with Profile Edge Detail

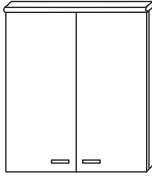

AS37M-C	2525	2727	3030	48	7	49 1/2	210
AS37N-C	3180	3434	3816	60	7	49 1/2	210

Veneer species must be noted on each line item

Presentation cabinet, white marker board (markers and eraser included), pull down projection screen, wood pencil/marker tray. Fabric covered tackboards on inside of each door, fabric requirement is 3 yards per unit. List price includes application of COM, COM must be acrylic backed prior to shipment to HBF. For specification of any HBF Textiles product, add 5% List.

Plasma Screen Enclosure, Top without Profile Edge Detail

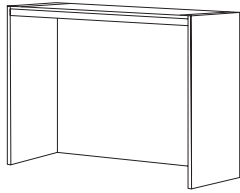

AS54M	2020	2182	2424	48	15	42 1/4	145
AS54A	2685	2900	3222	72	15	42 1/4	165
AS54B	3170	3424	3804	84	15	42 1/4	185

Veneer species must be noted on each line item

Plasma Screen Enclosure, Top with Profile Edge Detail

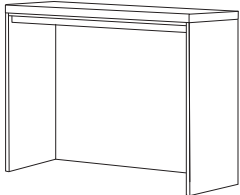

AS54M-C	2320	2506	2784	48	15	43 5/8	150
AS54A-C	2985	3224	3582	72	15	43 5/8	170
AS54B-C	3470	3748	4164	84	15	43 5/8	190

Veneer species must be noted on each line item

Plasma Screen Enclosure, Top without Profile Edge Detail (Double High)

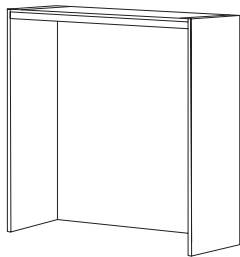

AS54M2	2720	2938	3264	48	15	56	167
AS54A2	3385	3656	4062	72	15	56	187
AS54B2	3870	4180	4644	84	15	56	207

Veneer species must be noted on each line item

Plasma Screen Enclosure, Top with Profile Edge Detail (Double High)

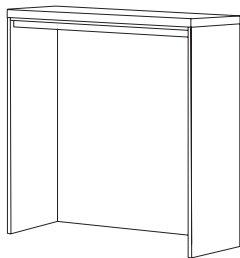

AS54M2-C	3020	3262	3624	48	15	57 3/8	172
AS54A2-C	3685	3980	4422	72	15	57 3/8	192
AS54B2-C	4170	4504	5004	84	15	57 3/8	212

Veneer species must be noted on each line item

Veneer species must be noted on each line item

<u>Veneer Grade 1</u>	<u>Veneer Grade 2</u>	<u>Veneer Grade 3</u>
Cherry	Rift Oak	Anigre
Maple	Sapele	
Ligno-Grain		
Walnut		

HBF Ashton Conference Cabinetry

Style Number	List Price			Dimensions				Weight
	Veneer 1	Veneer 2	Veneer 3	OW	OD	OH	DIA	
Lectern								
AS53P	4435	4790	5322	31 1/4	27 1/2	48		105

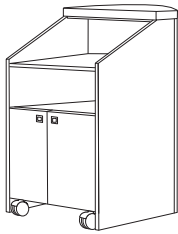

Veneer species must be noted on each line item

Veneer species must be noted on each line item

<u>Veneer Grade 1</u>	<u>Veneer Grade 2</u>	<u>Veneer Grade 3</u>
Cherry	Rift Oak	Anigre
Maple	Sapele	
Ligno-Grain		
Walnut		