

tayco.
work well.™

metropolis
pricebook

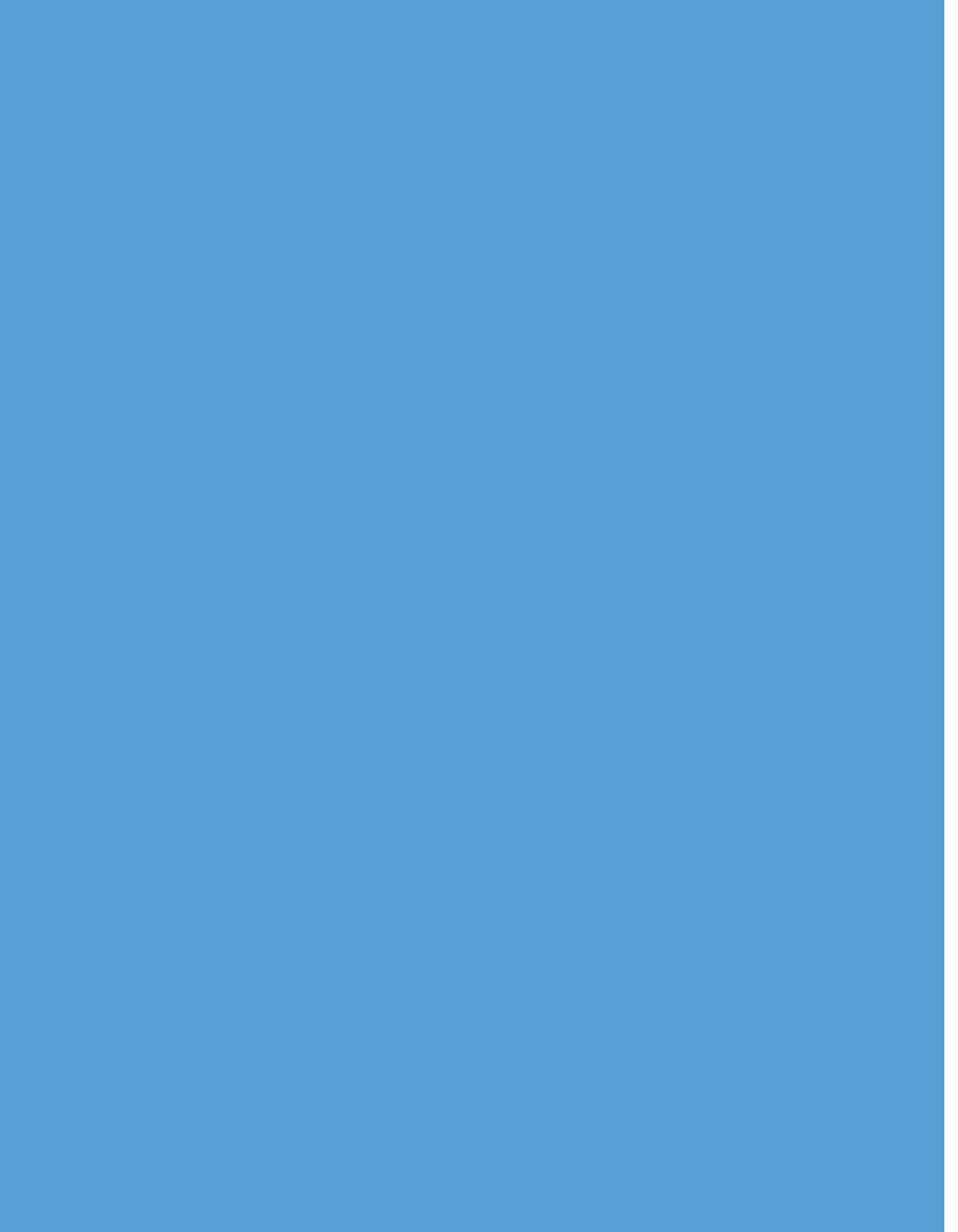

tayco | table of contents

product overview

introduction	8
desks, returns, bridges and credenzas	8
pedestals	8
freestanding storage and combo cabinets	8
reception units	8
intermediate gable supports	8
lectern	9
accessories	9
hutches and cabinets	9
coffee and end tables	9
bookcases	9
handle details	9
default vinyl color selections	9
edge profiles	9
decorative trim placement	10
grain direction	11
filing options	12
grommets	12
step-by-step order placement	13

executive

straight desks	16
arc desks	32
tables	35
5-sided corners	38
unitized desks	39
bridges	40
returns	44
straight transition worksurfaces	56
credenzas	57
intermediate gable supports	60
pedestals	61
filing and storage	62
hutches	69
o-tabletops and bases	71
reception units	72
coffee and end tables	73

professional

straight desks	76
arc desks	92
tables	95
5-sided corners	98
unitized desks	99
bridges	100
returns	104
straight transition worksurfaces	116
credenzas	117
intermediate gable supports	120
pedestals	121
filing and storage	122
hutches	129
o-tabletops and bases	131
reception units	132
coffee and end tables	133

tayco | table of contents

conference	
tabletops	136
table bases	138
tabletop and base configurations	140
hutches	141
credenzas	142
filing and storage	145
presentation tools	150

accessories	
keyboard trays	154
tackboards	155
pencil drawer	155
task lights	156
monitor arms	157
CPU holders	157
wire manager	158

terms and conditions	
terms and conditions	162
warranty	164
care and maintenance	165

product overview

introduction	8
desks, returns, bridges and credenzas	8
pedestals	8
freestanding storage and combo cabinets	8
reception units	8
intermediate gable supports	8
lectern	9
accessories	9
hutches and cabinets	9
coffee and end tables	9
bookcases	9
handle details	9
default vinyl color selections	9
edge profiles	9
decorative trim placement	10
grain direction	11
filing options	12
grommets	12
step-by-step order placement	13

tayco | product overview

Tayco introduces Metropolis, a full line of case goods and conference furniture.

Metropolis is divided into three distinct product groups for ease of specifying: Executive, Professional and Conference. The price book is divided into the same three sub-groupings, and the prefix of the product code indicates the product group.

- T – Metropolis Executive
- TL – Metropolis Professional
- TB – Metropolis Conference

Metropolis Executive and Professional series contain the building blocks for the CEO's office, a flexible team environment or a welcoming reception area. An abundance of freestanding storage towers are available for places to hang your coat, file important papers or store personal items. Whether you need to create an impression, save space or encourage collaboration, Metropolis does it all.

Metropolis Conference can be formal or casual, a place for working meetings, video-conferencing or large presentations. It customizes to your needs through a wide selection of sizes and mix-and-match table shapes and base styles. Cabinetry has been made larger to match the proportions of the conference room. Accessory items such as audiovisual cabinets, mobile media centers, lecterns, whiteboards and serving cabinets round out the line.

Metropolis Executive and Conference feature 1.5"-thick worksurfaces, hutch and freestanding storage tops. These items also have a choice of Straight, Gothic or Wave trim styles. Metropolis Professional has 1"-thick worksurfaces, hutch tops, filing and storage tops with a straight 3-mm vinyl edge.

desks, returns, bridges and credenzas

Desks are available with a choice of recessed or flush modesties. Metropolis desks, end gables and modesties are made with 45 lb./cubic foot density industrial-grade composite wood core, finished on both sides. Many pieces are available with partial or full modesties. Partial modesties (12"H) should be ordered only for pieces located next to a wall. Otherwise, full modesties should be used.

pedestals

All pedestal drawers are outfitted with full extension slides. Drawers can be easily removed by releasing the small catches on either side of the slide. Pedestals come standard with locks. One lock will lock both file drawers in a file/file pedestal and one box drawer and the file drawer in the box/box/file pedestal. File drawers will accommodate legal- or letter-size documents.

freestanding storage and combo cabinets

Various combination filing and storage units provide a place to hang a coat, store personal items and documents to suit any individual's needs.

reception units

Everything you need in a reception unit is sold as a single item complete with worksurface, counter and storage.

intermediate gable supports

Some configurations require the use of an intermediate gable support. This support must be ordered separately. The situations requiring an intermediate gable support are:

- > For use under surfaces 60" wide or greater where there is no filing or storage to support the worksurface (see picture 1). This applies to Metropolis Professional only. The intermediate support is not necessary for Metropolis Executive configurations, unless a hutch is placed over a bridge or return surface (see picture 2).

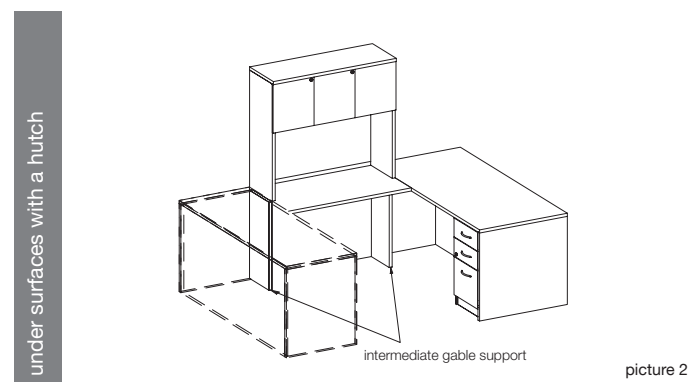
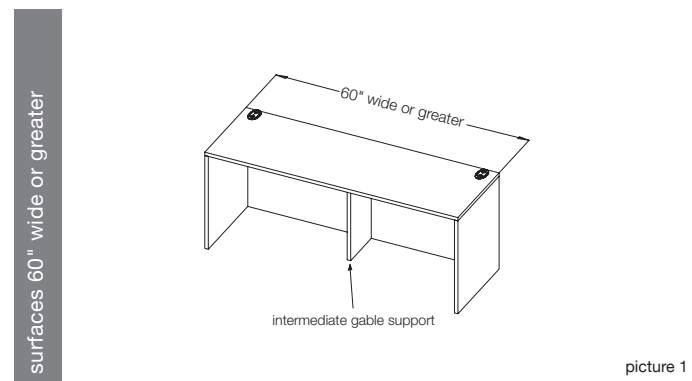

- > Under return surfaces where the return meets the primary desk or Peninsula table. This applies to Metropolis Professional only.

The 12" wide intermediary gable is for 21"- and 24"-deep surfaces and the 18"-wide intermediate gable is used with 30"- and 36"-deep worksurfaces.

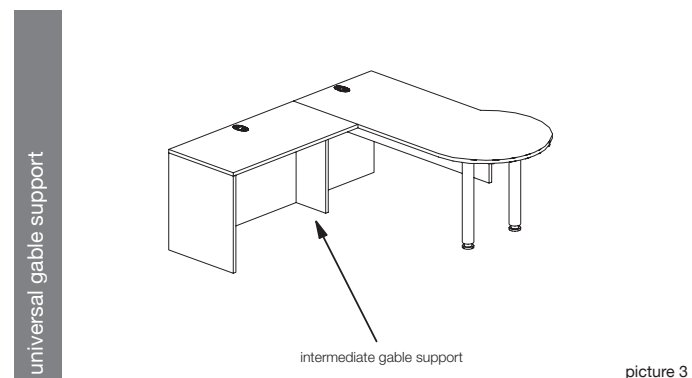

tayco | product overview

lectern

The Metropolis lectern is mobile, height-adjustable and constructed of laminate to match the conference room furniture. It glides easily to center stage and can be moved aside when not in use on friction locking wheels. An acrylic lip holds documents in place during presentations.

accessories

Computer accessories include flat-screen monitor arms, articulating keyboard trays and CPU holders.

Heavy-duty flat-screen monitor arms adjust to the user while storing wires within the arm. The monitor mounting plate meets VESA standards to accommodate most monitors. Monitor arms can be grommet- or clamp-mounted to the worksurface. Articulating and retractable keyboard trays and mobile or underdesk-mounted CPU holders complete the workstation.

Hutch-mounted tackboards can be finished in any Tayco standard fabric to match the office decor. The conference room whiteboard comes standard with a dry erase board and two fabric-wrapped tackboards. Standard task lights are available in two sizes and come with vertical wire management. An optional task light is available with a dimmer switch. A grommet-mounting swing arm task light is also available.

hutches and cabinets

Hutch and cabinet doors come in a choice of classic laminate or aluminum-framed frosted acrylic glazing. Hutches with laminate doors always come standard with locking doors (except for the Conference line). Hutches come open or closed, with or without pigeonholes and a flexible apron for wire management. Optional hutch mounted tackboards finished in any of Tayco fabrics can be ordered to complete the look.

coffee and end tables

Metropolis coffee and end tables coordinate with reception units and are available with or without a fixed shelf.

bookcases

Straight and radius bookcases have height-adjustable shelves with the exception of any desk-height shelves. They are fixed to add structural stability to the bookcase.

handle details

Six handle options are available in choice of colors. Melbourne is the standard handle option unless otherwise specified on your Purchase Order. All Conference handles are 7½" long. All Executive and Professional handles are 5" long.

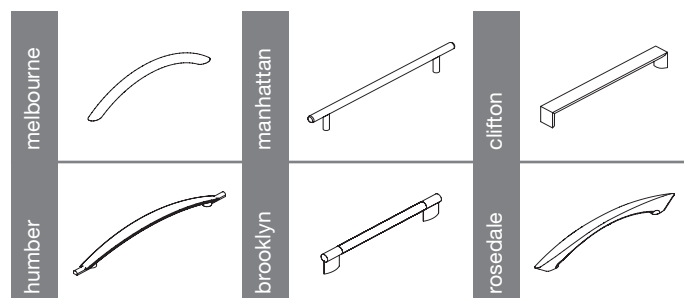

default vinyl color selections

Each laminate comes with matching vinyl trim color unless otherwise specified on your purchase order. Refer to the laminate finish card for details.

edge profiles

Metropolis Executive and Conference are available with a selection of three edge profiles.



Straight profile is available in:

- > Executive
- > Professional
- > Conference

Wave profile is available in:

- > Executive
- > Conference

Gothic profile is available in:

- > Executive
- > Conference

tayco | product overview

decorative trim placement

Generally the decorative trim is placed on the exposed surface edge.

Straight trim is applied to surface edges that are placed next to a wall or another surface.

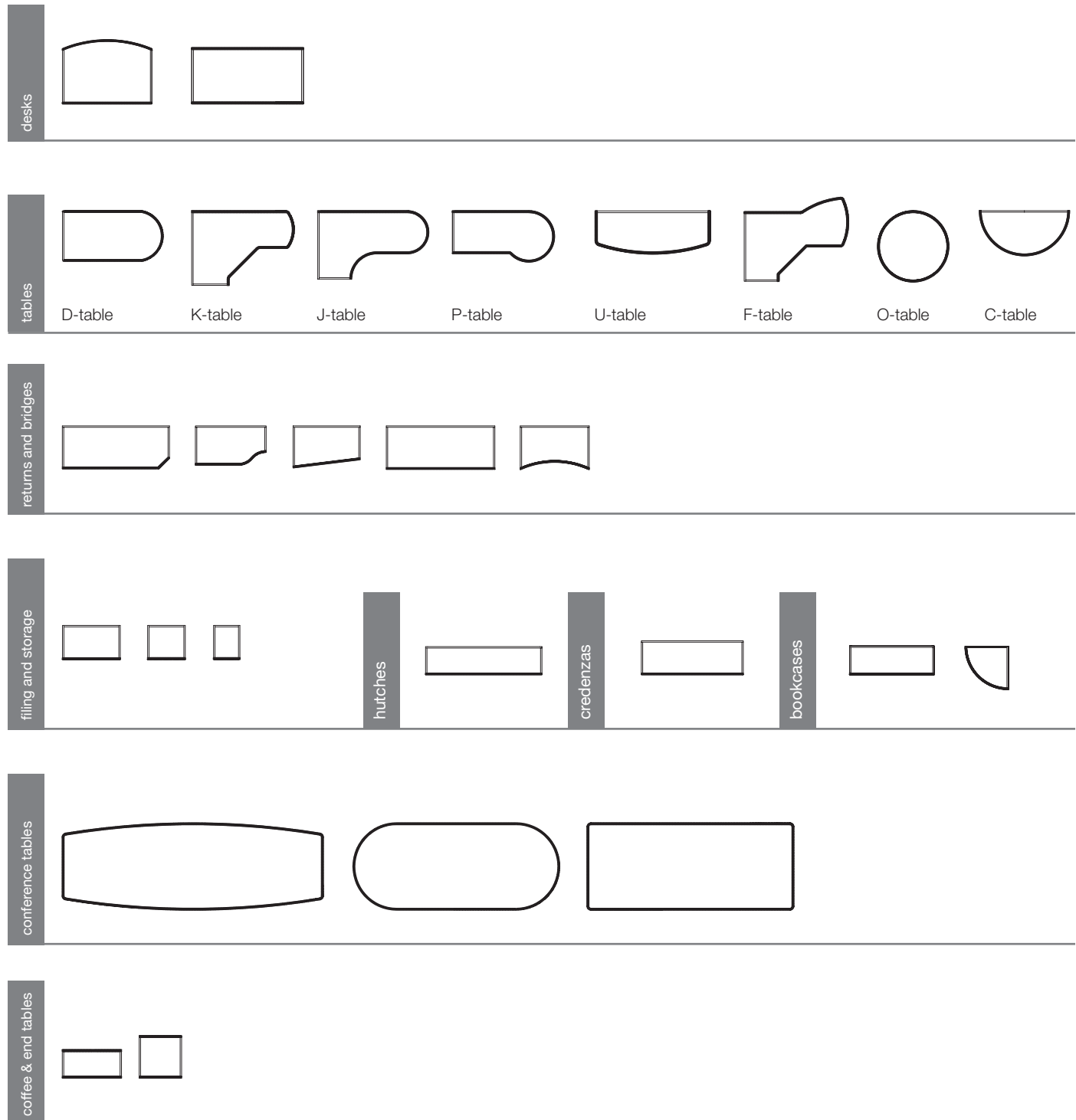

legend:

- 3 mm shaped
- 3 mm straight

tayco | product overview

grain direction

Horizontal Surfaces

When ordering a directional laminate, the grain will run the direction of the width of the worksurface (excluding bridge surfaces), hutch or storage top. Grain on bridge modesty run vertically so the grain will run the same direction on the entire suite.

Vertical Surfaces

Directional laminates run vertically on vertical surfaces such as cabinet doors, pedestal drawer fronts and gables, as well as all cabinet, lateral file and pedestal kick-plates. The grain runs horizontally across the width of modesty panels.

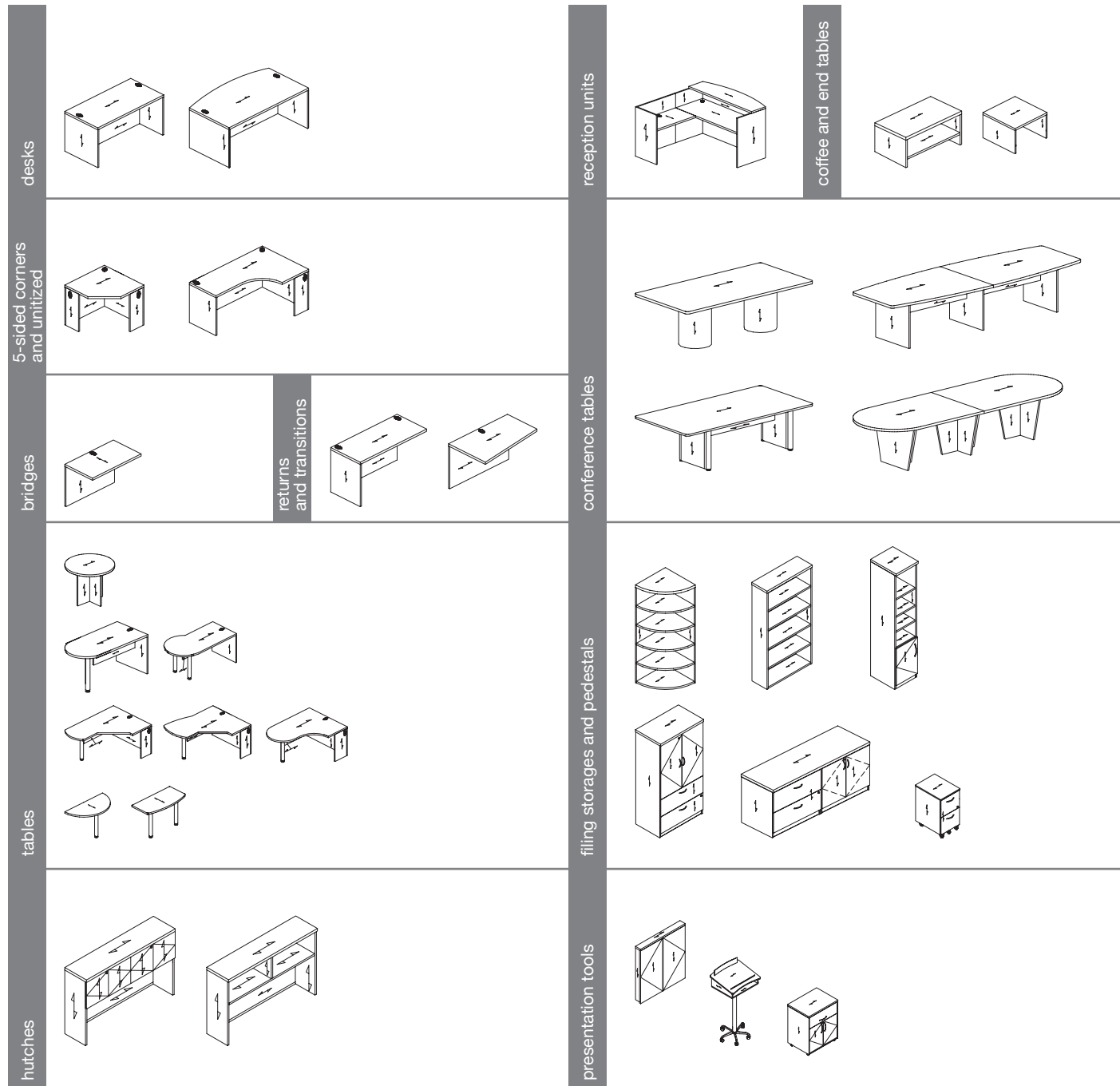



tayco | product overview

filing options

Pedestal file drawers can accommodate letter- or legal-size documents.

Letter-size papers can be filed either front to back or side to side.

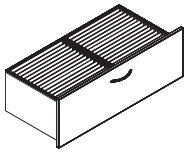
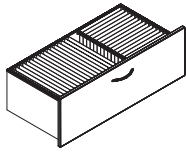
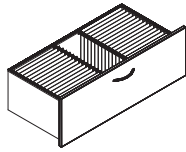
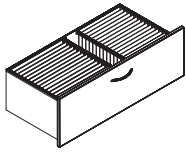
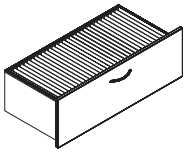
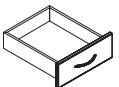
Lateral drawers can accommodate front to back or side to side filing of legal- or letter-size documents.

lateral file drawers					
	Lateral File Drawer (36W & 42W) Legal filing – front to back Underdesk: 15" Freestanding: 15"	Lateral File Drawer (36W & 42W) Legal filing – side to side Letter filing – front to back Underdesk: 15" Freestanding: 15"	Lateral File Drawer (30W, 36W & 42W) Letter filing – front to back Underdesk: 15" Freestanding: 15"	Lateral File Drawer (36W & 42W) Letter & legal filing – front to back Underdesk: 15" Freestanding: 15"	Lateral File Drawer (30W, 36W & 42W) Legal filing – side to side Underdesk: 30W–25½" 36W–31½" 42W–37½" Freestanding: 30W–25½" 36W–31½" 42W–37½"
	box drawer		file drawers		
		Box Drawer Box Height: 3" Box Depth: 15" Box Width: 12"		File Drawer Letter filing – front to back Underdesk: 15" Freestanding: 15"	File Drawer Legal filing – side to side Underdesk: 12" Freestanding: 12"

grommets

Grommets are available in black or silver to coordinate with furniture.

Black is the standard grommet option unless otherwise specified on your Purchase Order.

Components Including Grommets

- > Peninsula tables
- > Arc desks with pedestals
- > Straight desks with recessed modesties and pedestals
- > Straight desks with flush modesties and without pedestals
- > Returns without pedestals
- > 24" deep returns with pedestal
- > 30" deep returns with pedestal
- > 24" deep desks with flush modesties and pedestals
- > 30" deep desks with flush modesties and pedestals
- > 36" deep desks with flush modesties and pedestals
- > Bridges
- > Straight transition worksurfaces
- > 5-sided corner worksurfaces
- > Unitized desks
- > Reception units

Components Available With or Without Grommets

- > Arc desks without pedestals
- > Straight desks with recessed modesties and without pedestals

Components Without Grommets

- > Credenzas
- > 21" deep desks with pedestal
- > 21" deep returns with pedestal
- > "U" and "C" Tables

Grommet Placement

Surfaces up to and including 48" wide have one grommet located at back center of the surface. Surfaces 54" wide and wider have two grommets at either side of the back of the surface.

tayco | step-by-step order placement

1. purchase order number
2. quantity
3. product codes and descriptions
4. finishes
5. options
6. provide a drawing or Tayco quotation number
7. shipping address, on-site contact name and phone number
8. shipping instructions
9. confirm access to elevators, loading dock, etc.
10. requested ship date/installation date
11. submit a completed Tayco installation checklist if Tayco is installing the furniture
12. discount, net price and freight charges
13. keep Tayco order numbers on file for reference when placing additional orders

executive

straight desks	16
arc desks	32
tables	35
5-sided corners	38
unitized desks	39
bridges	40
returns	44
straight transition worksurfaces	56
credenzas	57
intermediate gable supports	60
pedestals	61
filing and storage	62
hutches	69
o-tabletops and bases	71
reception units	72
coffee and end tables	73

executive | straight desks

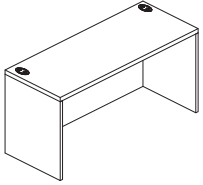
Description	Item Number	Price	Dimensions (inches)			Weight (lb.)	Cubic Feet
			H	W	D		
1.5" Straight Desk w/Full Modesty 	T-TS0G-6021	528	29.5	60	21	122.55	4.63
	T-TS0G-6621	557	29.5	66	21	131.97	5.06
	T-TS0G-7221	579	29.5	72	21	141.39	5.50
	T-TS0G-7821	606	29.5	78	21	150.81	5.93
	T-TS0G-8421	640	29.5	84	21	160.23	6.37
	T-TS0G-3024	422	29.5	30	24	92.02	2.75
	T-TS0G-3624	449	29.5	36	24	111.14	3.24
	T-TS0G-4224	466	29.5	42	24	130.26	3.73
	T-TS0G-4824	494	29.5	48	24	149.38	4.21
	T-TS0G-5424	523	29.5	54	24	168.50	4.70
	T-TS0G-6024	550	29.5	60	24	187.62	5.19
	T-TS0G-6624	579	29.5	66	24	206.74	5.67
	T-TS0G-7224	601	29.5	72	24	225.86	6.16
	T-TS0G-7824	630	29.5	78	24	244.98	6.64
	T-TS0G-8424	663	29.5	84	24	264.10	7.13
	T-TS0G-3030	444	29.5	30	30	99.05	3.34
	T-TS0G-3630	478	29.5	36	30	110.58	3.94
	T-TS0G-4230	506	29.5	42	30	122.11	4.53
	T-TS0G-4830	540	29.5	48	30	133.64	5.12
	T-TS0G-5430	579	29.5	54	30	145.17	5.71
T-TS0G-6030	606	29.5	60	30	156.70	6.30	
T-TS0G-6630	630	29.5	66	30	168.23	6.89	
T-TS0G-7230	657	29.5	72	30	179.76	7.48	
T-TS0G-7830	696	29.5	78	30	191.29	8.07	
T-TS0G-8430	730	29.5	84	30	202.82	8.66	

ordering options

- > laminate color
- > edge profile
- > grommet color

Each laminate comes with matching vinyl trim color unless otherwise specified on your purchase order. Refer to the laminate finish card for details.

details

- > Refer to page 12 for grommet placement.

executive | straight desks

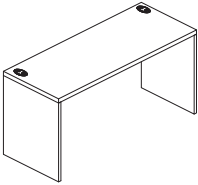
Description	Item Number	Price	Dimensions (inches)			Weight (lb.)	Cubic Feet
			H	W	D		
1.5" Straight Desk w/Partial Modesty 	T-TS0Z-6021	528	29.5	60	21	97.81	4.63
	T-TS0Z-6621	557	29.5	66	21	104.54	5.06
	T-TS0Z-7221	579	29.5	72	21	111.27	5.50
	T-TS0Z-7821	606	29.5	78	21	118.00	5.93
	T-TS0Z-8421	640	29.5	84	21	124.73	6.37
	T-TS0Z-3024	422	29.5	30	24	71.33	2.75
	T-TS0Z-3624	449	29.5	36	24	78.75	3.24
	T-TS0Z-4224	466	29.5	42	24	86.17	3.73
	T-TS0Z-4824	494	29.5	48	24	93.59	4.21
	T-TS0Z-5424	523	29.5	54	24	101.01	4.70
	T-TS0Z-6024	550	29.5	60	24	108.43	5.19
	T-TS0Z-6624	579	29.5	66	24	115.85	5.67
	T-TS0Z-7224	601	29.5	72	24	123.27	6.16
	T-TS0Z-7824	630	29.5	78	24	130.69	6.64
	T-TS0Z-8424	663	29.5	84	24	138.11	7.13
	T-TS0Z-3030	444	29.5	30	30	75.35	3.34
	T-TS0Z-3630	478	29.5	36	30	83.98	3.94
	T-TS0Z-4230	506	29.5	42	30	92.60	4.53
	T-TS0Z-4830	540	29.5	48	30	101.23	5.12
	T-TS0Z-5430	579	29.5	54	30	109.85	5.71
	T-TS0Z-6030	606	29.5	60	30	118.48	6.30
	T-TS0Z-6630	630	29.5	66	30	127.10	6.89
	T-TS0Z-7230	657	29.5	72	30	135.73	7.48
	T-TS0Z-7830	696	29.5	78	30	144.35	8.07
	T-TS0Z-8430	730	29.5	84	30	152.98	8.66

straight desks

ordering options

- > laminate color
- > edge profile
- > grommet color

details

- > Partial modesties are 12"H.
- > Refer to page 12 for grommet placement.

Each laminate comes with matching vinyl trim color unless otherwise specified on your purchase order. Refer to the laminate finish card for details.

executive | straight desks

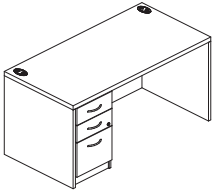
Description	Item Number	Price	Dimensions (inches)			Weight (lb.)	Cubic Feet
			H	W	D		
1.5" Straight Desk w/Full Modesty, Box/Box/File on Left-Hand Side 	T-TSBX-6021	917	29.5	60	21	163.30	31.02
	T-TSBX-6621	940	29.5	66	21	172.89	33.93
	T-TSBX-7221	984	29.5	72	21	182.48	36.83
	T-TSBX-8421	1078	29.5	84	21	201.66	42.65
	T-TSBX-6024	984	29.5	60	24	175.34	34.74
	T-TSBX-6624	1000	29.5	66	24	184.80	38.00
	T-TSBX-7224	1028	29.5	72	24	194.26	41.25
	T-TSBX-8424	1126	29.5	84	24	213.18	47.77
	T-TSBX-6030	1040	29.5	60	30	198.00	42.19
	T-TSBX-6630	1090	29.5	66	30	209.23	46.14
	T-TSBX-7230	1124	29.5	72	30	220.46	50.09
	T-TSBX-8430	1191	29.5	84	30	242.92	58.00
	T-TSBX-7236	1174	29.5	72	36	246.51	58.94
	T-TSBX-8436	1248	29.5	84	36	272.51	68.24

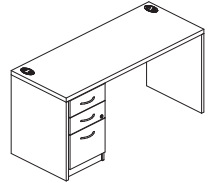
1.5" Straight Desk w/Partial Modesty, Box/Box/File on Left-Hand Side 	T-TSBX-6021-P	917	29.5	60	21	126.18	31.02
	T-TSBX-6621-P	940	29.5	66	21	135.77	33.93
	T-TSBX-7221-P	984	29.5	72	21	145.36	36.83
	T-TSBX-8421-P	1078	29.5	84	21	164.54	42.65
	T-TSBX-6024-P	984	29.5	60	24	138.22	34.74
	T-TSBX-6624-P	1000	29.5	66	24	147.68	38.00
	T-TSBX-7224-P	1028	29.5	72	24	157.14	41.25
	T-TSBX-8424-P	1126	29.5	84	24	176.06	47.77

ordering options

- > laminate color
- > edge profile
- > grommet color
- > handle color
- > handle style

Each laminate comes with matching vinyl trim color unless otherwise specified on your purchase order. Refer to the laminate finish card for details.

details

- > Partial modesties are 12"H.
- > 21"D desks do not include grommets. Refer to page 12 for details.
- > Pedestals include lock and keys. Refer to page 8 for details.w

executive | straight desks

straight desks

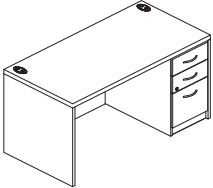
Description	Item Number	Price	Dimensions (inches)			Weight (lb.)	Cubic Feet
			H	W	D		
1.5" Straight Desk w/Full Modesty, Box/Box/File on Right-Hand Side 	T-TSXB-6021	917	29.5	60	21	163.30	31.02
	T-TSXB-6621	940	29.5	66	21	172.89	33.93
	T-TSXB-7221	984	29.5	72	21	182.48	36.8
	T-TSXB-8421	11078	29.5	84	21	201.66	42.65
	T-TSXB-6024	984	29.5	60	24	175.34	34.74
	T-TSXB-6624	1000	29.5	66	24	184.80	38.00
	T-TSXB-7224	1028	29.5	72	24	194.26	41.25
	T-TSXB-8424	1126	29.5	84	24	213.18	47.77
	T-TSXB-6030	1040	29.5	60	30	198.00	42.19
	T-TSXB-6630	1090	29.5	66	30	209.23	46.14
	T-TSXB-7230	1124	29.5	72	30	220.46	50.09
	T-TSXB-8430	1191	29.5	84	30	242.92	58.00
	T-TSXB-7236	1174	29.5	72	36	246.51	58.94
	T-TSXB-8436	1248	29.5	84	36	272.51	68.24

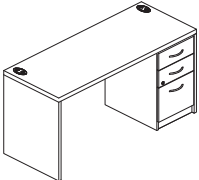
1.5" Straight Desk w/Partial Modesty, Box/Box/File on Right-Hand Side 	T-TSXB-6021-P	917	29.5	60	21	126.18	31.02
	T-TSXB-6621-P	940	29.5	66	21	135.77	33.93
	T-TSXB-7221-P	984	29.5	72	21	145.36	36.83
	T-TSXB-8421-P	1078	29.5	84	21	164.54	42.65
	T-TSXB-6024-P	984	29.5	60	24	138.22	34.74
	T-TSXB-6624-P	1000	29.5	66	24	147.68	38.00
	T-TSXB-7224-P	1028	29.5	72	24	157.14	41.25
	T-TSXB-8424-P	1126	29.5	84	24	176.06	47.77

ordering options

- > laminate color
- > edge profile
- > grommet color
- > handle color
- > handle style

details

- > Partial modesties are 12"H.
- > 21"D desks do not include grommets. Refer to page 12 for details.
- > Pedestals include lock and keys. Refer to page 8 for details.

Each laminate comes with matching vinyl trim color unless otherwise specified on your purchase order. Refer to the laminate finish card for details.

executive | straight desks

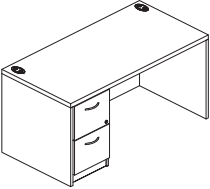
Description	Item Number	Price	Dimensions (inches)			Weight (lb.)	Cubic Feet
			H	W	D		
1.5" Straight Desk w/Full Modesty, File/File on Left-Hand Side 	T-TSFX-6021	917	29.5	60	21	163.30	31.02
	T-TSFX-6621	940	29.5	66	21	172.89	33.93
	T-TSFX-7221	984	29.5	72	21	182.48	36.83
	T-TSFX-8421	1078	29.5	84	21	201.66	42.65
	T-TSFX-6024	984	29.5	60	24	175.34	34.74
	T-TSFX-6624	1000	29.5	66	24	184.80	38.00
	T-TSFX-7224	1028	29.5	72	24	194.26	41.25
	T-TSFX-8424	1126	29.5	84	24	213.18	47.77
	T-TSFX-6030	1040	29.5	60	30	198.00	42.19
	T-TSFX-6630	1090	29.5	66	30	209.23	46.14
	T-TSFX-7230	1124	29.5	72	30	220.46	50.09
	T-TSFX-8430	1191	29.5	84	30	242.92	58.00
	T-TSFX-7236	1174	29.5	72	36	246.51	58.94
	T-TSFX-8436	1248	29.5	84	36	272.51	68.24

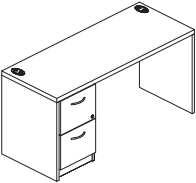
1.5" Straight Desk w/Partial Modesty, File/File on Left-Hand Side 	T-TSFX-6021-P	917	29.5	60	21	126.18	31.02
	T-TSFX-6621-P	940	29.5	66	21	135.77	33.93
	T-TSFX-7221-P	984	29.5	72	21	145.36	36.83
	T-TSFX-8421-P	1078	29.5	84	21	164.54	42.65
	T-TSFX-6024-P	984	29.5	60	24	138.22	34.74
	T-TSFX-6624-P	1000	29.5	66	24	147.68	38.00
	T-TSFX-7224-P	1028	29.5	72	24	157.14	41.25
	T-TSFX-8424-P	1126	29.5	84	24	176.06	47.77

ordering options

- > laminate color
- > edge profile
- > grommet color
- > handle color
- > handle style

Each laminate comes with matching vinyl trim color unless otherwise specified on your purchase order. Refer to the laminate finish card for details.

details

- > Partial modesties are 12"H.
- > 21"D desks do not include grommets. Refer to page 12 for details.
- > Pedestals include lock and keys. Refer to page 8 for details.

executive | straight desks

straight desks

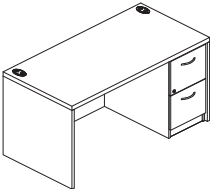
Description	Item Number	Price	Dimensions (inches)			Weight (lb.)	Cubic Feet
			H	W	D		
1.5" Straight Desk w/Full Modesty, File/File on Right-Hand Side 	T-TSXF-6021	917	29.5	60	21	163.30	31.02
	T-TSXF-6621	940	29.5	66	21	172.89	33.93
	T-TSXF-7221	984	29.5	72	21	182.48	36.83
	T-TSXF-8421	1078	29.5	84	21	201.66	42.65
	T-TSXF-6024	984	29.5	60	24	175.34	34.74
	T-TSXF-6624	1000	29.5	66	24	184.80	38.00
	T-TSXF-7224	1028	29.5	72	24	194.26	41.25
	T-TSXF-8424	1126	29.5	84	24	213.18	47.77
	T-TSXF-6030	1040	29.5	60	30	198.00	42.19
	T-TSXF-6630	1090	29.5	66	30	209.23	46.14
	T-TSXF-7230	1124	29.5	72	30	220.46	50.09
	T-TSXF-8430	1191	29.5	84	30	242.92	58.00
	T-TSXF-7236	1174	29.5	72	36	246.51	58.94
	T-TSXF-8436	1248	29.5	84	36	272.51	68.24

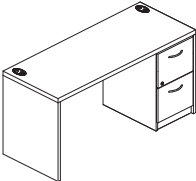
1.5" Straight Desk w/Partial Modesty, File/File on Right-Hand Side 	T-TSXF-6021-P	917	29.5	60	21	126.18	31.02
	T-TSXF-6621-P	940	29.5	66	21	135.77	33.93
	T-TSXF-7221-P	984	29.5	72	21	145.36	36.83
	T-TSXF-8421-P	1078	29.5	84	21	164.54	42.65
	T-TSXF-6024-P	984	29.5	60	24	138.22	34.74
	T-TSXF-6624-P	1000	29.5	66	24	147.68	38.00
	T-TSXF-7224-P	1028	29.5	72	24	157.14	41.25
	T-TSXF-8424-P	1126	29.5	84	24	176.06	47.77

ordering options

- > laminate color
- > edge profile
- > grommet color
- > handle color
- > handle style

details

- > Partial modesties are 12"H.
- > 21"D desks do not include grommets. Refer to page 12 for details.
- > Pedestals include lock and keys. Refer to page 8 for details.

Each laminate comes with matching vinyl trim color unless otherwise specified on your purchase order. Refer to the laminate finish card for details.

executive | straight desks

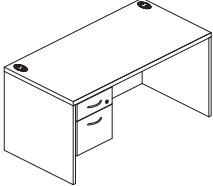
Description	Item Number	Price	Dimensions (inches)			Weight (lb.)	Cubic Feet
			H	W	D		
1.5" Straight Desk w/Full Modesty, Suspended Pedestal on Left-Hand Side 	T-TSSX-6021	822	29.5	60	21	157.06	31.02
	T-TSSX-6621	846	29.5	66	21	166.65	33.93
	T-TSSX-7221	894	29.5	72	21	176.24	36.83
	T-TSSX-8421	976	29.5	84	21	195.42	42.65
	T-TSSX-6024	877	29.5	60	24	169.10	34.74
	T-TSSX-6624	899	29.5	66	24	178.56	38.00
	T-TSSX-7224	916	29.5	72	24	188.02	41.25
	T-TSSX-8424	1026	29.5	84	24	206.94	47.77
	T-TSSX-6030	933	29.5	60	30	191.76	42.19
	T-TSSX-6630	955	29.5	66	30	202.99	46.14
	T-TSSX-7230	984	29.5	72	30	214.22	50.09
	T-TSSX-8430	1045	29.5	84	30	236.68	58.00
	T-TSSX-7236	1073	29.5	72	36	240.27	58.94
	T-TSSX-8436	1135	29.5	84	36	266.27	68.24

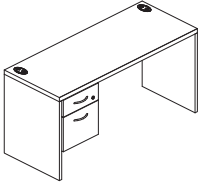
1.5" Straight Desk w/Partial Modesty, Suspended Pedestal on Left-Hand Side 	T-TSSX-6021-P	822	29.5	60	21	119.94	31.02
	T-TSSX-6621-P	846	29.5	66	21	129.53	33.93
	T-TSSX-7221-P	894	29.5	72	21	139.12	36.83
	T-TSSX-8421-P	976	29.5	84	21	158.30	42.65
	T-TSSX-6024-P	877	29.5	60	24	131.98	34.74
	T-TSSX-6624-P	899	29.5	66	24	141.44	38.00
	T-TSSX-7224-P	916	29.5	72	24	150.90	41.25
	T-TSSX-8424-P	1026	29.5	84	24	169.82	47.77

ordering options

- > laminate color
- > edge profile
- > grommet color
- > handle color
- > handle style

details

- > Partial modesties are 12"H.
- > 21"D desks do not include grommets. Refer to page 12 for details.
- > Pedestals include lock and keys. Refer to page 8 for details.

Each laminate comes with matching vinyl trim color unless otherwise specified on your purchase order. Refer to the laminate finish card for details.

executive | straight desks

straight desks

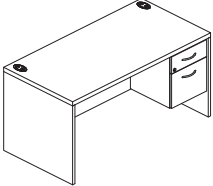
Description	Item Number	Price	Dimensions (inches)			Weight (lb.)	Cubic Feet
			H	W	D		
1.5" Straight Desk w/Full Modesty, Suspended Pedestal on Right-Hand Side 	T-TSXS-6021	822	29.5	60	21	157.06	31.02
	T-TSXS-6621	846	29.5	66	21	166.65	33.93
	T-TSXS-7221	894	29.5	72	21	176.24	36.83
	T-TSXS-8421	976	29.5	84	21	195.42	42.65
	T-TSXS-6024	877	29.5	60	24	169.10	34.74
	T-TSXS-6624	899	29.5	66	24	178.56	38.00
	T-TSXS-7224	916	29.5	72	24	188.02	41.25
	T-TSXS-8424	1026	29.5	84	24	206.94	47.77
	T-TSXS-6030	933	29.5	60	30	191.76	42.19
	T-TSXS-6630	955	29.5	66	30	202.99	46.14
	T-TSXS-7230	984	29.5	72	30	214.22	50.09
	T-TSXS-8430	1045	29.5	84	30	236.68	58.00
	T-TSXS-7236	1073	29.5	72	36	240.27	58.94
	T-TSXS-8436	1135	29.5	84	36	266.27	68.24

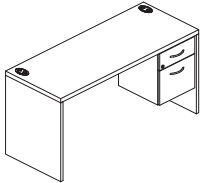
1.5" Straight Desk w/Partial Modesty, Suspended Pedestal on Right-Hand Side 	T-TSXS-6021-P	822	29.5	60	21	119.94	31.02
	T-TSXS-6621-P	846	29.5	66	21	129.53	33.93
	T-TSXS-7221-P	894	29.5	72	21	139.12	36.83
	T-TSXS-8421-P	976	29.5	84	21	158.30	42.65
	T-TSXS-6024-P	877	29.5	60	24	131.98	34.74
	T-TSXS-6624-P	899	29.5	66	24	141.44	38.00
	T-TSXS-7224-P	916	29.5	72	24	150.90	41.25
	T-TSXS-8424-P	1026	29.5	84	24	169.82	47.77

ordering options

- > laminate color
- > edge profile
- > grommet color
- > handle color
- > handle style

details

- > Partial modesties are 12"H.
- > 21"D desks do not include grommets. Refer to page 12 for details.
- > Pedestals include lock and keys. Refer to page 8 for details.

Each laminate comes with matching vinyl trim color unless otherwise specified on your purchase order. Refer to the laminate finish card for details.

executive | straight desks

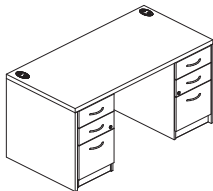
Description	Item Number	Price	Dimensions (inches)			Weight (lb.)	Cubic Feet
			H	W	D		
1.5" Straight Desk w/Full Modesty, Double Box/Box/File Pedestals 	T-TSBB-6021	1248	29.5	60	21	205.10	31.02
	T-TSBB-6621	1270	29.5	66	21	214.69	33.93
	T-TSBB-7221	1292	29.5	72	21	224.28	36.83
	T-TSBB-8421	1360	29.5	84	21	243.46	42.65
	T-TSBB-6024	1265	29.5	60	24	217.14	34.74
	T-TSBB-6624	1287	29.5	66	24	226.60	38.00
	T-TSBB-7224	1309	29.5	72	24	236.06	41.25
	T-TSBB-8424	1382	29.5	84	24	254.98	47.77
	T-TSBB-6030	1360	29.5	60	30	239.80	42.19
	T-TSBB-6630	1416	29.5	66	30	251.03	46.14
	T-TSBB-7230	1455	29.5	72	30	262.26	50.09
	T-TSBB-8430	1512	29.5	84	30	284.72	58.00
	T-TSBB-7236	1505	29.5	72	36	288.31	58.94
	T-TSBB-8436	1585	29.5	84	36	314.31	68.24

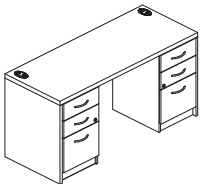
1.5" Straight Desk w/Partial Modesty, Double Box/Box/File Pedestals 	T-TSBB-6021-P	1248	29.5	60	21	167.98	31.02
	T-TSBB-6621-P	1270	29.5	66	21	177.57	33.93
	T-TSBB-7221-P	1292	29.5	72	21	187.16	36.83
	T-TSBB-8421-P	1360	29.5	84	21	206.34	42.65
	T-TSBB-6024-P	1265	29.5	60	24	180.02	34.74
	T-TSBB-6624-P	1287	29.5	66	24	189.48	38.00
	T-TSBB-7224-P	1309	29.5	72	24	198.94	41.25
	T-TSBB-8424-P	1382	29.5	84	24	217.86	47.77

ordering options

- > laminate color
- > edge profile
- > grommet color
- > handle color
- > handle style

Each laminate comes with matching vinyl trim color unless otherwise specified on your purchase order. Refer to the laminate finish card for details.

details

- > Partial modesties are 12"H.
- > 21"D desks do not include grommets. Refer to page 12 for details.
- > Pedestals include lock and keys. Refer to page 8 for details.

executive | straight desks

straight desks

Description	Item Number	Price	Dimensions (inches)			Weight (lb.)	Cubic Feet
			H	W	D		
1.5" Straight Desk w/Full Modesty, Box/Box/File on Left-Hand Side, File/File on Right-Hand Side	T-TSBF-6021	1248	29.5	60	21	205.10	31.02
	T-TSBF-6621	1270	29.5	66	21	214.69	33.93
	T-TSBF-7221	1292	29.5	72	21	224.28	36.83
	T-TSBF-8421	1360	29.5	84	21	243.46	42.65
	T-TSBF-6024	1265	29.5	60	24	217.14	34.74
	T-TSBF-6624	1287	29.5	66	24	226.60	38.00
	T-TSBF-7224	1309	29.5	72	24	236.06	41.25
	T-TSBF-8424	1382	29.5	84	24	254.98	47.77
	T-TSBF-6030	1360	29.5	60	30	239.80	42.19
	T-TSBF-6630	1416	29.5	66	30	251.03	46.14
	T-TSBF-7230	1455	29.5	72	30	262.26	50.09
	T-TSBF-8430	1512	29.5	84	30	284.72	58.00
	T-TSBF-7236	1505	29.5	72	36	288.31	58.94
	T-TSBF-8436	1585	29.5	84	36	314.31	68.24

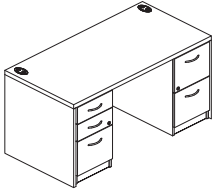

1.5" Straight Desk w/Partial Modesty, Box/Box/File on Left-Hand Side, File/File on Right-Hand Side	T-TSBF-6021-P	1248	29.5	60	21	167.98	31.02
	T-TSBF-6621-P	1270	29.5	66	21	177.57	33.93
	T-TSBF-7221-P	1292	29.5	72	21	187.16	36.83
	T-TSBF-8421-P	1360	29.5	84	21	206.34	42.65
	T-TSBF-6024-P	1265	29.5	60	24	180.02	34.74
	T-TSBF-6624-P	1287	29.5	66	24	189.48	38.00
	T-TSBF-7224-P	1309	29.5	72	24	198.94	41.25
	T-TSBF-8424-P	1382	29.5	84	24	217.86	47.77

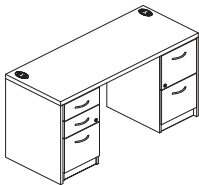

ordering options

- > laminate color
- > edge profile
- > grommet color
- > handle color
- > handle style

details

- > Partial modesties are 12"H.
- > 21"D desks do not include grommets. Refer to page 12 for details.
- > Pedestals include lock and keys. Refer to page 8 for details.

Each laminate comes with matching vinyl trim color unless otherwise specified on your purchase order. Refer to the laminate finish card for details.

executive | straight desks

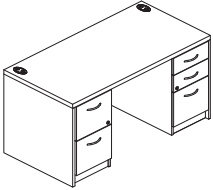
Description	Item Number	Price	Dimensions (inches)			Weight (lb.)	Cubic Feet
			H	W	D		
1.5" Straight Desk w/Full Modesty, File/File on Left-Hand Side, Box/Box/File on Right-Hand Side 	T-TSFB-6021	1248	29.5	60	21	205.10	31.02
	T-TSFB-6621	1270	29.5	66	21	214.69	33.93
	T-TSFB-7221	1292	29.5	72	21	224.28	36.83
	T-TSFB-8421	1360	29.5	84	21	243.46	42.65
	T-TSFB-6024	1265	29.5	60	24	217.14	34.74
	T-TSFB-6624	1287	29.5	66	24	226.60	38.00
	T-TSFB-7224	1309	29.5	72	24	236.06	41.25
	T-TSFB-8424	1382	29.5	84	24	254.98	47.77
	T-TSFB-6030	1360	29.5	60	30	239.80	42.19
	T-TSFB-6630	1416	29.5	66	30	251.03	46.14
	T-TSFB-7230	1455	29.5	72	30	262.26	50.09
	T-TSFB-8430	1512	29.5	84	30	284.72	58.00
	T-TSFB-7236	1505	29.5	72	36	288.31	58.94
	T-TSFB-8436	1585	29.5	84	36	314.31	68.24

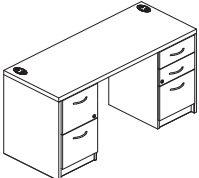
1.5" Straight Desk w/Partial Modesty, File/File on Left-Hand Side, Box/Box/File on Right-Hand Side 	T-TSFB-6021-P	1248	29.5	60	21	167.98	31.02
	T-TSFB-6621-P	1270	29.5	66	21	177.57	33.93
	T-TSFB-7221-P	1292	29.5	72	21	187.16	36.83
	T-TSFB-8421-P	1360	29.5	84	21	206.34	42.65
	T-TSFB-6024-P	1265	29.5	60	24	180.02	34.74
	T-TSFB-6624-P	1287	29.5	66	24	189.48	38.00
	T-TSFB-7224-P	1309	29.5	72	24	198.94	41.25
	T-TSFB-8424-P	1382	29.5	84	24	217.86	47.77

ordering options

- > laminate color
- > edge profile
- > grommet color
- > handle color
- > handle style

details

- > Partial modesties are 12"H.
- > 21"D desks do not include grommets. Refer to page 12 for details.
- > Pedestals include lock and keys. Refer to page 8 for details.

Each laminate comes with matching vinyl trim color unless otherwise specified on your purchase order. Refer to the laminate finish card for details.

executive | straight desks

Description	Item Number	Price	Dimensions (inches)			Weight (lb.)	Cubic Feet
			H	W	D		
1.5" Straight Desk w/Full Modesty, Double File/File Pedestals	T-TSFF-6021	1248	29.5	60	21	205.10	31.02
	T-TSFF-6621	1270	29.5	66	21	214.69	33.93
	T-TSFF-7221	1292	29.5	72	21	224.28	36.83
	T-TSFF-8421	1360	29.5	84	21	243.46	42.65

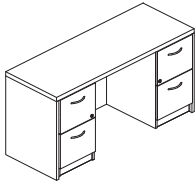

1.5" Straight Desk w/Partial Modesty, Double File/File Pedestals	T-TSFF-6021-P	1248	29.5	60	21	167.98	31.02
	T-TSFF-6621-P	1270	29.5	66	21	177.57	33.93
	T-TSFF-7221-P	1292	29.5	72	21	187.16	36.83
	T-TSFF-8421-P	1360	29.5	84	21	206.34	42.65

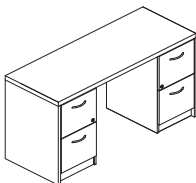

straight desks

ordering options

- > laminate color
- > edge profile
- > handle color
- > handle style

Each laminate comes with matching vinyl trim color unless otherwise specified on your purchase order. Refer to the laminate finish card for details.

details

- > Partial modesties are 12"H.
- > 21"D desks do not include grommets. Refer to page 12 for details.
- > Pedestals include lock and keys. Refer to page 8 for details.

executive | straight desks

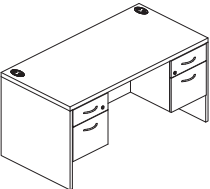
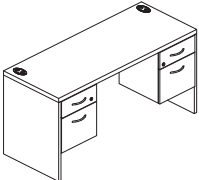
Description	Item Number	Price	Dimensions (inches)			Weight (lb.)	Cubic Feet
			H	W	D		
1.5" Straight Desk w/Full Modesty, Double Suspended Pedestals 	T-TSS-6021	1067	29.5	60	21	192.62	31.02
	T-TSS-6621	1090	29.5	66	21	202.21	33.93
	T-TSS-7221	1112	29.5	72	21	211.80	36.83
	T-TSS-8421	1174	29.5	84	21	230.98	42.65
	T-TSS-6024	1073	29.5	60	24	204.66	34.74
	T-TSS-6624	1101	29.5	66	24	214.12	38.00
	T-TSS-7224	1124	29.5	72	24	223.58	41.25
	T-TSS-8424	1191	29.5	84	24	242.50	47.77
	T-TSS-6030	1168	29.5	60	30	227.32	42.19
	T-TSS-6630	1219	29.5	66	30	238.55	46.14
	T-TSS-7230	1270	29.5	72	30	249.78	50.09
	T-TSS-8430	1360	29.5	84	30	272.24	58.00
	T-TSS-7236	1326	29.5	72	36	275.83	58.94
	T-TSS-8436	1399	29.5	84	36	301.83	68.24
1.5" Straight Desk w/Partial Modesty, Double Suspended Pedestals 	T-TSS-6021-P	1067	29.5	60	21	155.50	31.02
	T-TSS-6621-P	1090	29.5	66	21	165.09	33.93
	T-TSS-7221-P	1112	29.5	72	21	174.68	36.83
	T-TSS-8421-P	1174	29.5	84	21	193.86	42.65
	T-TSS-6024-P	1073	29.5	60	24	167.54	34.74
	T-TSS-6624-P	1101	29.5	66	24	177.00	38.00
	T-TSS-7224-P	1124	29.5	72	24	186.46	41.25
	T-TSS-8424-P	1191	29.5	84	24	205.38	47.77

ordering options

- > laminate color
- > edge profile
- > grommet color
- > handle color
- > handle style

details

- > Partial modesties are 12"H.
- > 21"D desks do not include grommets. Refer to page 12 for details.
- > Pedestals include lock and keys. Refer to page 8 for details.

Each laminate comes with matching vinyl trim color unless otherwise specified on your purchase order. Refer to the laminate finish card for details.

executive | straight desks

straight desks

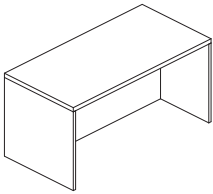
Description	Item Number	Price	Dimensions (inches)			Weight (lb.)	Cubic Feet
			H	W	D		
1.5" Straight Desk w/Recessed Full Modesty 	T-TSR0-6030	606	29.5	60	30	156.70	6.30
	T-TSR0-6630	630	29.5	66	30	168.23	6.89
	T-TSR0-7230	657	29.5	72	30	179.76	7.48
	T-TSR0-7830	696	29.5	78	30	191.29	8.07
	T-TSR0-8430	730	29.5	84	30	202.82	8.66
	T-TSR0-6036	691	29.5	60	36	178.20	7.41
	T-TSR0-6636	719	29.5	66	36	190.80	8.10
	T-TSR0-7236	747	29.5	72	36	203.40	8.80
	T-TSR0-7836	781	29.5	78	36	216.00	9.49
	T-TSR0-8436	809	29.5	84	36	228.60	10.19

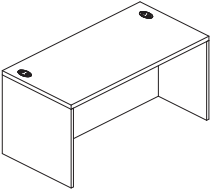
1.5" Straight Desk w/Recessed Full Modesty and Grommets 	T-TSRG-6030	617	29.5	60	30	156.70	6.30
	T-TSRG-6630	640	29.5	66	30	168.23	6.89
	T-TSRG-7230	669	29.5	72	30	179.76	7.48
	T-TSRG-7830	707	29.5	78	30	191.29	8.07
	T-TSRG-8430	742	29.5	84	30	202.82	8.66
	T-TSRG-6036	714	29.5	60	36	178.20	7.41
	T-TSRG-6636	742	29.5	66	36	190.80	8.10
	T-TSRG-7236	771	29.5	72	36	203.40	8.80
	T-TSRG-7836	805	29.5	78	36	216.00	9.49
	T-TSRG-8436	833	29.5	84	36	228.60	10.19

ordering options

- > laminate color
- > edge profile
- > grommet color

Each laminate comes with matching vinyl trim color unless otherwise specified on your purchase order. Refer to the laminate finish card for details.

details

- > Recessed modesty:

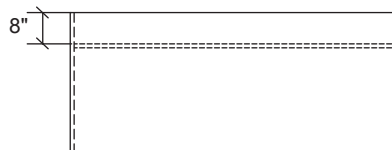

executive | straight desks

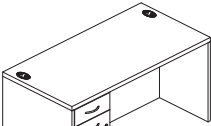
Description	Item Number	Price	Dimensions (inches)			Weight (lb.)	Cubic Feet
			H	W	D		
1.5" Straight Desk w/Recessed Full Modesty, Box/Box/File on Left-Hand Side 	T-TRBX-6030	1050	29.5	60	30	198.00	42.19
	T-TRBX-6630	1101	29.5	66	30	209.55	46.14
	T-TRBX-7230	1135	29.5	72	30	221.10	50.09
	T-TRBX-8430	1202	29.5	84	30	244.20	58.00
	T-TRBX-7236	1185	29.5	72	36	246.51	58.94
	T-TRBX-8436	1258	29.5	84	36	272.51	68.24

1.5" Straight Desk w/Recessed Full Modesty, Box/Box/File on Right-Hand Side 	T-TRXB-6030	1050	29.5	60	30	198.00	42.19
	T-TRXB-6630	1101	29.5	66	30	209.55	46.14
	T-TRXB-7230	1135	29.5	72	30	221.10	50.09
	T-TRXB-8430	1202	29.5	84	30	244.20	58.00
	T-TRXB-7236	1185	29.5	72	36	246.51	58.94
	T-TRXB-8436	1258	29.5	84	36	272.51	68.24

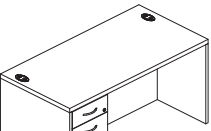
1.5" Straight Desk w/Recessed Full Modesty, Suspended Pedestal on Left-Hand Side 	T-TRSX-6030	967	29.5	60	30	191.69	42.19
	T-TRSX-6630	1011	29.5	66	30	202.92	46.14
	T-TRSX-7230	1050	29.5	72	30	214.15	50.09
	T-TRSX-8430	1135	29.5	84	30	236.61	58.00
	T-TRSX-7236	1096	29.5	72	36	240.20	58.94
	T-TRSX-8436	1168	29.5	84	36	266.20	68.24

1.5" Straight Desk w/Recessed Full Modesty, Suspended Pedestal on Right-Hand Side 	T-TRXS-6030	967	29.5	60	30	191.69	42.19
	T-TRXS-6630	1011	29.5	66	30	202.92	46.14
	T-TRXS-7230	1050	29.5	72	30	214.15	50.09
	T-TRXS-8430	1135	29.5	84	30	236.61	58.00
	T-TRXS-7236	1096	29.5	72	36	240.20	58.94
	T-TRXS-8436	1168	29.5	84	36	266.20	68.24

ordering options

- > laminate color
- > edge profile
- > grommet color
- > handle color
- > handle style

Each laminate comes with matching vinyl trim color unless otherwise specified on your purchase order. Refer to the laminate finish card for details.

details

- > Pedestals include lock and keys. Refer to page 8 for details.
- > Recessed modesty:

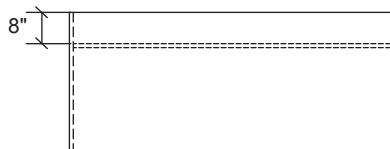

executive | straight desks

straight desks

Description	Item Number	Price	Dimensions (inches)			Weight (lb.)	Cubic Feet
			H	W	D		
1.5" Straight Desk w/Recessed Full Modesty, Box/Box/File on Left-Hand Side, File/File on Right-Hand Side	T-TRBF-6030	1371	29.5	60	30	239.87	42.19
	T-TRBF-6630	1427	29.5	66	30	251.10	46.14
	T-TRBF-7230	1466	29.5	72	30	262.33	50.09
	T-TRBF-8430	1522	29.5	84	30	284.79	58.00
	T-TRBF-7236	1517	29.5	72	36	288.38	58.94
	T-TRBF-8436	1595	29.5	84	36	314.38	68.24
1.5" Straight Desk w/Recessed Full Modesty, File/File on Left-Hand Side, Box/Box/File on Right-Hand Side	T-TRFB-6030	1371	29.5	60	30	239.87	42.19
	T-TRFB-6630	1427	29.5	66	30	251.10	46.14
	T-TRFB-7230	1466	29.5	72	30	262.33	50.09
	T-TRFB-8430	1522	29.5	84	30	284.79	58.00
	T-TRFB-7236	1517	29.5	72	36	288.38	58.94
	T-TRFB-8436	1595	29.5	84	36	314.38	68.24
1.5" Straight Desk w/Recessed Full Modesty, Double Box/Box/File Pedestals	T-TRBB-6030	1371	29.5	60	30	239.87	42.19
	T-TRBB-6630	1427	29.5	66	30	251.10	46.14
	T-TRBB-7230	1466	29.5	72	30	262.33	50.09
	T-TRBB-8430	1522	29.5	84	30	284.79	58.00
	T-TRBB-7236	1517	29.5	72	36	288.38	58.94
	T-TRBB-8436	1595	29.5	84	36	314.38	68.24
1.5" Straight Desk w/Recessed Full Modesty, Double Suspended Pedestals	T-TRSS-6030	1180	29.5	60	30	227.25	42.19
	T-TRSS-6630	1231	29.5	66	30	238.48	46.14
	T-TRSS-7230	1280	29.5	72	30	249.71	50.09
	T-TRSS-8430	1371	29.5	84	30	272.17	58.00
	T-TRSS-7236	1337	29.5	72	36	275.76	58.94
	T-TRSS-8436	1410	29.5	84	36	301.76	68.24

ordering options

- > laminate color
- > edge profile
- > grommet color
- > handle color
- > handle style

Each laminate comes with matching vinyl trim color unless otherwise specified on your purchase order. Refer to the laminate finish card for details.

details

- > Pedestals include lock and keys. Refer to page 8 for details.
- > Recessed modesty:

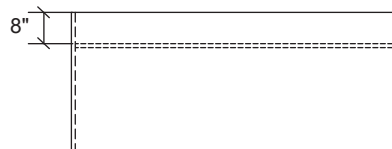

executive | arc desks

Description	Item Number	Price	Dimensions (inches)			Weight (lb.)	Cubic Feet
			H	W	D		
1.5" Arc Desk w/Recessed Full Modesty	T-TAR0-7236	881	29.5	72	36	216.17	8.80
	T-TAR0-7836	923	29.5	78	36	230.43	9.49
	T-TAR0-8436	966	29.5	84	36	244.69	10.19

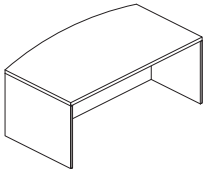

1.5" Arc Desk w/Recessed Full Modesty and Grommets

T-TARG-7236	894	29.5	72	36	216.17	8.80
T-TARG-7836	935	29.5	78	36	230.43	9.49
T-TARG-8436	976	29.5	84	36	244.69	10.19

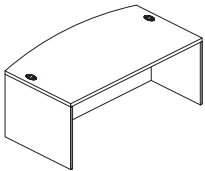

ordering options

- > laminate color
- > edge profile
- > grommet color

Each laminate comes with matching vinyl trim color unless otherwise specified on your purchase order. Refer to the laminate finish card for details.

details

- > Recessed modesty:

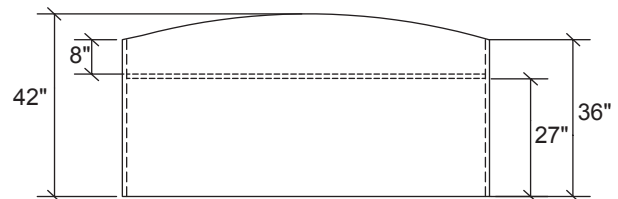

executive | arc desks

Description	Item Number	Price	Dimensions (inches)			Weight (lb.)	Cubic Feet
			H	W	D		
1.5" Arc Desk w/Recessed Full Modesty, Box/Box/File on Left-Hand Side	T-TABX-7236	1303	29.5	72	36	255.52	58.94
	T-TABX-8436	1390	29.5	84	36	281.52	68.24

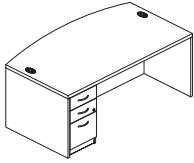

1.5" Arc Desk w/Recessed Full Modesty, Box/Box/File on Right-Hand Side	T-TAXB-7236	1303	29.5	72	36	255.52	58.94
	T-TAXB-8436	1390	29.5	84	36	281.52	68.24

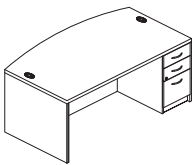

1.5" Arc Desk w/Recessed Full Modesty, Suspended Pedestal on Left-Hand Side	T-TASX-7236	1203	29.5	72	36	249.21	58.94
	T-TASX-8436	1290	29.5	84	36	275.21	68.24

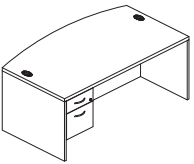

1.5" Arc Desk w/Recessed Full Modesty, Suspended Pedestal on Right-Hand Side	T-TAXS-7236	1203	29.5	72	36	249.21	58.94
	T-TAXS-8436	1290	29.5	84	36	275.21	68.24

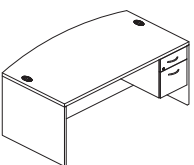

arc desks

ordering options

- > laminate color
- > edge profile
- > grommet color
- > handle color
- > handle style

Each laminate comes with matching vinyl trim color unless otherwise specified on your purchase order. Refer to the laminate finish card for details.

details

- > Pedestals include lock and keys. Refer to page 8 for details.
- > Recessed modesty:

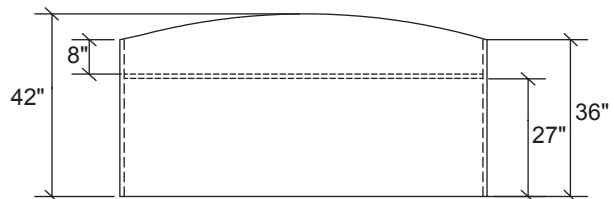

executive | arc desks

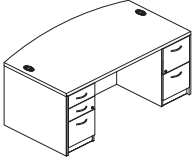
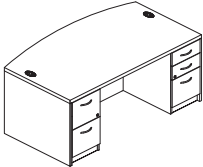
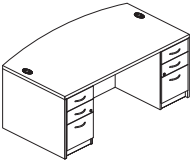
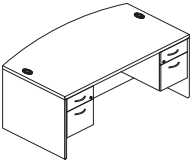
Description	Item Number	Price	Dimensions (inches)			Weight (lb.)	Cubic Feet
			H	W	D		
1.5" Arc Desk w/Recessed Full Modesty, Box/Box/File on Left-Hand Side, File/File on Right-Hand side	T-TABF-7236	1618	29.5	72	36	297.39	58.94
	T-TABF-8436	1691	29.5	84	36	323.39	68.24
							
1.5" Arc Desk w/Recessed Full Modesty, File/File on Left-Hand Side, Box/Box/File on Right-Hand Side	T-TAFB-7236	1618	29.5	72	36	297.39	58.94
	T-TAFB-8436	1691	29.5	84	36	323.39	68.24
							
1.5" Arc Desk w/Recessed Full Modesty, Double Box/Box/File Pedestals	T-TABB-7236	1618	29.5	72	36	297.39	58.94
	T-TABB-8436	1691	29.5	84	36	323.39	68.24
							
1.5" Arc Desk w/Recessed Full Modesty, Double Suspended Pedestals	T-TASS-7236	1455	29.5	72	36	290.77	58.94
	T-TASS-8436	1512	29.5	84	36	316.77	68.24
							

ordering options

- > laminate color
- > edge profile
- > grommet color
- > handle color
- > handle style

Each laminate comes with matching vinyl trim color unless otherwise specified on your purchase order. Refer to the laminate finish card for details.

details

- > Pedestals include lock and keys. Refer to page 8 for details.
- > Recessed modesty:

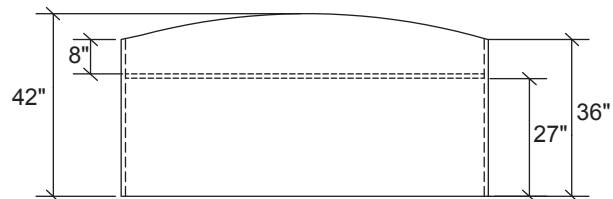

executive | tables

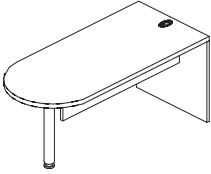
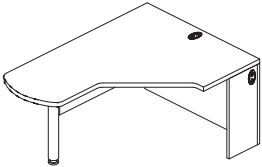
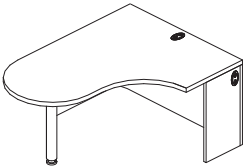
Description	Item Number	Price	Dimensions (inches)			Weight (lb.)	Cubic Feet
			H	W	D		
1.5" D-Table 	T-TD0G-6030	738	29.5	60	30	108.29	5.04
	T-TD0G-6630	762	29.5	66	30	117.27	5.51
	T-TD0G-7230	787	29.5	72	30	126.25	5.98
	T-TD0G-7830	811	29.5	78	30	135.23	6.45
	T-TD0G-8430	836	29.5	84	30	144.21	6.93
	T-TD0G-6036	792	29.5	60	36	131.34	5.93
	T-TD0G-6636	822	29.5	66	36	141.76	6.48
	T-TD0G-7236	840	29.5	72	36	152.18	7.04
	T-TD0G-7836	864	29.5	78	36	162.60	7.59
	T-TD0G-8436	888	29.5	84	36	173.02	8.15
1.5" K-Table, LH Shown 	T-TKSG-604824-L	974	29.5	60	24	149.13	5.19
	T-TKSG-664824-L	1041	29.5	66	24	156.85	5.67
	T-TKSG-724824-L	1094	29.5	72	24	164.57	6.16
	T-TKSG-784824-L	1147	29.5	78	24	172.29	6.64
	T-TKSG-844824-L	1200	29.5	84	24	180.01	7.13
	T-TKSG-604824-R	974	29.5	60	24	149.13	5.19
	T-TKSG-664824-R	1041	29.5	66	24	156.85	5.67
	T-TKSG-724824-R	1094	29.5	72	24	164.57	6.16
	T-TKSG-784824-R	1147	29.5	78	24	172.29	6.64
	T-TKSG-844824-R	1200	29.5	84	24	180.01	7.13
1.5" J-Table, LH Shown 	T-TJ0G-604824-L	971	29.5	60	24	149.48	6.22
	T-TJ0G-664824-L	1036	29.5	66	24	158.56	6.81
	T-TJ0G-724824-L	1090	29.5	72	24	167.64	7.39
	T-TJ0G-784824-L	1147	29.5	78	24	176.72	7.97
	T-TJ0G-844824-L	1200	29.5	84	24	185.80	8.56
	T-TJ0G-604824-R	971	29.5	60	24	149.48	6.22
	T-TJ0G-664824-R	1036	29.5	66	24	158.56	6.81
	T-TJ0G-724824-R	1090	29.5	72	24	167.64	7.39
	T-TJ0G-784824-R	1147	29.5	78	24	176.72	7.97
	T-TJ0G-844824-R	1200	29.5	84	24	185.80	8.56

ordering options

- > laminate color
- > edge profile
- > grommet color
- > metal color (for post support)

Each laminate comes with matching vinyl trim color unless otherwise specified on your purchase order. Refer to the laminate finish card for details.

details

- > 36"D D-tables include two post supports.

executive | tables

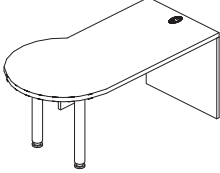
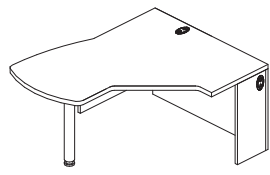
Description	Item Number	Price	Dimensions (inches)			Weight (lb.)	Cubic Feet
			H	W	D		
1.5" P-Table, LH Shown 	T-TP0G-6030-L	894	29.5	60	30	119.92	7.56
	T-TP0G-6630-L	935	29.5	66	30	128.78	8.26
	T-TP0G-7230-L	966	29.5	72	30	137.64	8.97
	T-TP0G-7830-L	1005	29.5	78	30	146.50	9.68
	T-TP0G-8430-L	1041	29.5	84	30	155.36	10.39
	T-TP0G-6030-R	894	29.5	60	30	119.92	7.56
	T-TP0G-6630-R	935	29.5	66	30	128.78	8.26
	T-TP0G-7230-R	966	29.5	72	30	137.64	8.97
	T-TP0G-7830-R	1005	29.5	78	30	146.50	9.68
	T-TP0G-8430-R	1041	29.5	84	30	155.36	10.39
1.5" F-Table, LH Shown 	T-TFSG-604824-L	1144	29.5	60	24	152.90	7.26
	T-TFSG-664824-L	1167	29.5	66	24	161.05	7.94
	T-TFSG-724824-L	1190	29.5	72	24	169.20	8.62
	T-TFSG-784824-L	1215	29.5	78	24	177.35	9.30
	T-TFSG-844824-L	1238	29.5	84	24	185.50	9.98
	T-TFSG-604824-R	1144	29.5	60	24	152.90	7.26
	T-TFSG-664824-R	1167	29.5	66	24	161.05	7.94
	T-TFSG-724824-R	1190	29.5	72	24	169.20	8.62
	T-TFSG-784824-R	1215	29.5	78	24	177.35	9.30
	T-TFSG-844824-R	1238	29.5	84	24	185.50	9.98



ordering options

- > laminate color
- > edge profile
- > grommet color
- > metal color (for post support)

Each laminate comes with matching vinyl trim color unless otherwise specified on your purchase order. Refer to the laminate finish card for details.

details

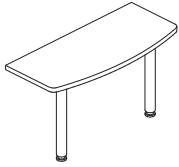
executive | tables

Description	Item Number	Price	Dimensions (inches)			Weight (lb.)	Cubic Feet
			H	W	D		
1.5" U-Table 	T-WEU0-4224	545	29.5	42	24	51.19	2.98
	T-WEU0-4824	564	29.5	48	24	56.54	3.37
	T-WEU0-6024	665	29.5	60	24	61.88	4.15
1.5" C-Table 	T-TC00-4221	393	29.5	42	21	34.00	2.00
	T-TC00-4824	452	29.5	48	24	42.10	2.53
	T-TC00-6030	510	29.5	60	30	50.00	3.78

tables

ordering options

- > laminate color
- > edge profile
- > metal color (for post support)

Each laminate comes with matching vinyl trim color unless otherwise specified on your purchase order. Refer to the laminate finish card for details.

details

executive | 5-sided corners

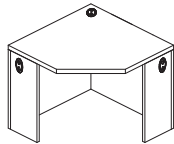
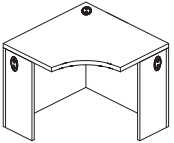
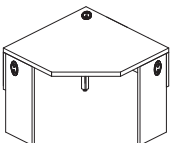
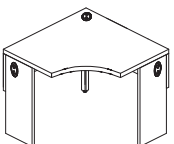
Description	Item Number	Price	Dimensions (inches)			Weight (lb.)	Cubic Feet
			H	W	D		
1.5" Straight Front Corner Worksurface w/Full Modesties 	T-W5S0-3618	606	29.5	36	18	112.69	2.55
	T-W5S0-3621	606	29.5	36	21	114.30	2.89
	T-W5S0-3624	606	29.5	36	24	116.21	3.24
	T-W5S0-4221	713	29.5	42	21	137.24	3.33
	T-W5S0-4224	713	29.5	42	24	139.52	3.73
	T-W5S0-4830	831	29.5	48	30	177.72	5.12
1.5" Curved Front Corner Worksurface w/Full Modesties 	T-W5C0-3618	606	29.5	36	18	108.90	2.55
	T-W5C0-3621	606	29.5	36	21	112.21	2.89
	T-W5C0-3624	606	29.5	36	24	114.60	3.24
	T-W5C0-4221	713	29.5	42	21	132.52	3.33
	T-W5C0-4224	713	29.5	42	24	136.12	3.73
	T-W5C0-4830	831	29.5	48	30	174.10	5.12
1.5" Straight Front Corner Worksurface w/Partial Modesties and Post 	T-W5S0-3618-P	606	29.5	36	18	83.12	2.55
	T-W5S0-3621-P	606	29.5	36	21	84.74	2.89
	T-W5S0-3624-P	606	29.5	36	24	86.65	3.24
	T-W5S0-4221-P	713	29.5	42	21	102.88	3.33
	T-W5S0-4224-P	713	29.5	42	24	105.16	3.73
	T-W5S0-4830-P	831	29.5	48	30	138.56	5.12
1.5" Curved Front Corner Worksurface w/Partial Modesties and Post 	T-W5C0-3618-P	606	29.5	36	18	79.33	2.55
	T-W5C0-3621-P	606	29.5	36	21	82.62	2.89
	T-W5C0-3624-P	606	29.5	36	24	85.10	3.24
	T-W5C0-4221-P	713	29.5	42	21	94.27	3.33
	T-W5C0-4224-P	713	29.5	42	24	97.87	3.73
	T-W5C0-4830-P	831	29.5	48	30	127.30	5.12

ordering options

- > laminate color
- > edge profile
- > grommet color
- > metal color (for modesty post)

Each laminate comes with matching vinyl trim color unless otherwise specified on your purchase order. Refer to the laminate finish card for details.

details

- > Partial modesties are 12"H.

executive | unitized desks

Description	Item Number	Price	Dimensions (inches)			Weight (lb.)	Cubic Feet
			H	W	D		
1.5" Curved Front Unitized Desk w/Full Modesties, Full and Partial Gables, LH Shown	T-UC4G-6639-L	934	29.5	66	39	146.65	10.45
	T-UC4G-7239-L	994	29.5	72	39	181.17	11.35
	T-UC4G-6639-R	934	29.5	66	39	146.65	10.45
	T-UC4G-7239-R	991	29.5	72	39	181.17	11.35
	T-UC4G-6642-L	971	29.5	66	42	184.39	11.18
	T-UC4G-7242-L	1165	29.5	72	42	194.16	12.14
	T-UC4G-6642-R	971	29.5	66	42	184.39	11.18
	T-UC4G-7242-R	1165	29.5	72	42	194.16	12.14

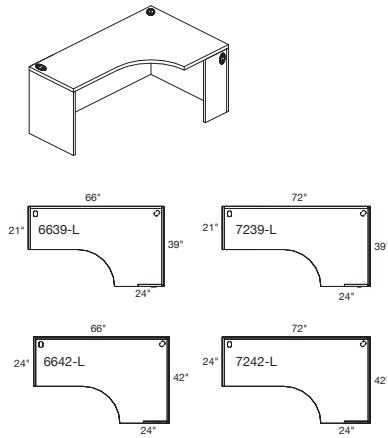

1.5" Curved Front Unitized Desk w/Partial Modesties, Full and Partial Gables, LH Shown	T-UC4Z-6639-L	934	29.5	66	39	104.04	10.45
	T-UC4Z-7239-L	994	29.5	72	39	110.22	11.35
	T-UC4Z-6639-R	934	29.5	66	39	104.04	10.45
	T-UC4Z-7239-R	994	29.5	72	39	110.22	11.35
	T-UC4Z-6642-L	971	29.5	66	42	137.95	11.18
	T-UC4Z-7242-L	1165	29.5	72	42	149.72	12.14
	T-UC4Z-6642-R	971	29.5	66	42	137.95	11.18
	T-UC4Z-7242-R	1165	29.5	72	42	149.72	12.14

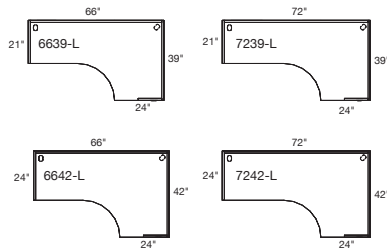

ordering options

- > laminate color
- > edge profile
- > grommet color
- > metal color (for modesty post)

Each laminate comes with matching vinyl trim color unless otherwise specified on your purchase order. Refer to the laminate finish card for details.

details

- > Partial modesties are 12"H.

executive | bridges

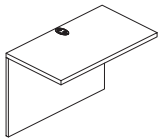
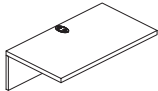
Description	Item Number	Price	Dimensions (inches)			Weight (lb.)	Cubic Feet
			H	W	D		
1.5" Straight Bridge w/Full Modesty 	T-BS0G-3021	281	29.5	30	21	46.17	1.48
	T-BS0G-3621	303	29.5	36	21	55.50	1.74
	T-BS0G-4221	337	29.5	42	21	64.83	2.00
	T-BS0G-4821	359	29.5	48	21	74.16	2.26
	T-BS0G-3024	293	29.5	30	24	49.50	1.65
	T-BS0G-3624	315	29.5	36	24	60.00	1.94
	T-BS0G-4224	349	29.5	42	24	70.50	2.24
	T-BS0G-4824	393	29.5	48	24	81.00	2.53
	T-BS0G-3030	315	29.5	30	30	56.75	2.01
	T-BS0G-3630	345	29.5	36	30	68.28	2.36
	T-BS0G-4230	381	29.5	42	30	79.81	2.72
	T-BS0G-4830	429	29.5	48	30	91.34	3.07
	1.5" Straight Bridge w/Partial Modesty 	T-BS0Z-3021	281	29.5	30	21	33.67
T-BS0Z-3621		303	29.5	36	21	43.00	1.74
T-BS0Z-4221		337	29.5	42	21	52.33	2.00
T-BS0Z-4821		359	29.5	48	21	61.66	2.26
T-BS0Z-3024		293	29.5	30	24	33.30	1.65
T-BS0Z-3624		315	29.5	36	24	43.80	1.94
T-BS0Z-4224		349	29.5	42	24	54.30	2.24
T-BS0Z-4824		393	29.5	48	24	64.80	2.53
T-BS0Z-3030		315	29.5	30	30	44.10	2.01
T-BS0Z-3630		345	29.5	36	30	55.63	2.36
T-BS0Z-4230		381	29.5	42	30	67.16	2.72
T-BS0Z-4830		429	29.5	48	30	78.69	3.07

ordering options

- > laminate color
- > edge profile
- > grommet color

Each laminate comes with matching vinyl trim color unless otherwise specified on your purchase order. Refer to the laminate finish card for details.

details

- > Partial modesties are 12"H.

executive | bridges

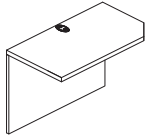
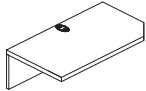
Description	Item Number	Price	Dimensions (inches)			Weight (lb.)	Cubic Feet	
			H	W	D			
1.5" Notched Bridge w/Full Modesty, LH Shown 	T-BN0G-3624-L	345	29.5	36	24	59.10	1.94	
	T-BN0G-4224-L	381	29.5	42	24	68.87	2.24	
	T-BN0G-4824-L	429	29.5	48	24	78.64	2.53	
	T-BN0G-3624-R	345	29.5	36	24	59.10	1.94	
	T-BN0G-4224-R	381	29.5	42	24	68.87	2.24	
	T-BN0G-4824-R	429	29.5	48	24	78.64	2.53	
	T-BN0G-3630-L	357	29.5	36	30	67.58	2.36	
	T-BN0G-4230-L	393	29.5	42	30	79.11	2.72	
	T-BN0G-4830-L	441	29.5	48	30	90.64	3.07	
	T-BN0G-3630-R	357	29.5	36	30	67.58	2.36	
	T-BN0G-4230-R	393	29.5	42	30	79.11	2.72	
	T-BN0G-4830-R	441	29.5	48	30	90.64	3.07	
	1.5" Notched Bridge w/Partial Modesty, LH Shown 	T-BN0Z-3624-L	345	29.5	36	24	44.29	1.94
		T-BN0Z-4224-L	381	29.5	42	24	54.06	2.24
		T-BN0Z-4824-L	429	29.5	48	24	63.83	2.53
T-BN0Z-3624-R		345	29.5	36	24	44.29	1.94	
T-BN0Z-4224-R		381	29.5	42	24	54.06	2.24	
T-BN0Z-4824-R		429	29.5	48	24	63.83	2.53	
T-BN0Z-3630-L		357	29.5	36	30	52.65	2.36	
T-BN0Z-4230-L		393	29.5	42	30	64.18	2.72	
T-BN0Z-4830-L		429	29.5	48	30	75.71	3.07	
T-BN0Z-3630-R		357	29.5	36	30	52.65	2.36	
T-BN0Z-4230-R		393	29.5	42	30	64.18	2.72	
T-BN0Z-4830-R		441	29.5	48	30	75.71	3.07	

ordering options

- > laminate color
- > edge profile
- > grommet color

Each laminate comes with matching vinyl trim color unless otherwise specified on your purchase order. Refer to the laminate finish card for details.

details

- > Partial modesties are 12"H.

executive | bridges

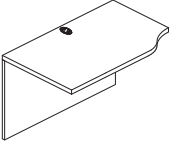
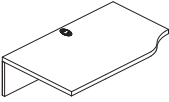
Description	Item Number	Price	Dimensions (inches)			Weight (lb.)	Cubic Feet	
			H	W	D			
1.5" Bowed Bridge w/Full Modesty, LH Shown 	T-BB0G-3624-L	345	29.5	36	24	58.03	1.94	
	T-BB0G-4224-L	381	29.5	42	24	68.16	2.24	
	T-BB0G-4824-L	429	29.5	48	24	78.29	2.53	
	T-BB0G-3624-R	345	29.5	36	24	58.03	1.94	
	T-BB0G-4224-R	381	29.5	42	24	68.16	2.24	
	T-BB0G-4824-R	429	29.5	48	24	78.29	2.53	
	T-BB0G-3630-L	357	29.5	36	30	66.47	2.36	
	T-BB0G-4230-L	393	29.5	42	30	78.00	2.72	
	T-BB0G-4830-L	441	29.5	48	30	89.53	3.07	
	T-BB0G-3630-R	357	29.5	36	30	66.47	2.36	
	T-BB0G-4230-R	393	29.5	42	30	78.00	2.72	
	T-BB0G-4830-R	441	29.5	48	30	89.53	3.07	
	1.5" Bowed Bridge w/Partial Modesty, LH Shown 	T-BB0Z-3624-L	345	29.5	36	24	42.75	1.94
		T-BB0Z-4224-L	381	29.5	42	24	52.88	2.24
		T-BB0Z-4824-L	429	29.5	48	24	63.01	2.53
T-BB0Z-3624-R		345	29.5	36	24	42.75	1.94	
T-BB0Z-4224-R		381	29.5	42	24	52.88	2.24	
T-BB0Z-4824-R		429	29.5	48	24	63.01	2.53	
T-BB0Z-3630-L		357	29.5	36	30	51.13	2.36	
T-BB0Z-4230-L		393	29.5	42	30	62.66	2.72	
T-BB0Z-4830-L		441	29.5	48	30	74.19	3.07	
T-BB0Z-3630-R		357	29.5	36	30	51.13	2.36	
T-BB0Z-4230-R		393	29.5	42	30	62.66	2.72	
T-BB0Z-4830-R		441	29.5	48	30	74.19	3.07	

ordering options

- > laminate color
- > edge profile
- > grommet color

Each laminate comes with matching vinyl trim color unless otherwise specified on your purchase order. Refer to the laminate finish card for details.

details

- > Partial modesties are 12"H.

executive | bridges

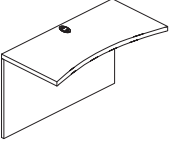
Description	Item Number	Price	Dimensions (inches)			Weight (lb.)	Cubic Feet
			H	W	D		
1.5" Concave Front Bridge w/Full Modesty 	T-BC0G-3024	338	29.5	30	24	46.67	1.65
	T-BC0G-3624	372	29.5	36	24	56.16	1.94
	T-BC0G-4224	411	29.5	42	24	65.65	2.24
	T-BC0G-4824	463	29.5	48	24	75.14	2.53
	T-BC0G-3030	351	29.5	30	30	53.70	2.01
	T-BC0G-3630	386	29.5	36	30	64.60	2.36
	T-BC0G-4230	425	29.5	42	30	75.50	2.72
	T-BC0G-4830	476	29.5	48	30	86.40	3.07

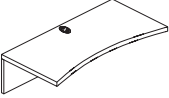
1.5" Concave Front Bridge w/Partial Modesty 	T-BC0Z-3024	338	29.5	30	24	36.79	1.65
	T-BC0Z-3624	372	29.5	36	24	46.28	1.94
	T-BC0Z-4224	411	29.5	42	24	55.77	2.24
	T-BC0Z-4824	463	29.5	48	24	65.26	2.53
	T-BC0Z-3030	351	29.5	30	30	43.75	2.01
	T-BC0Z-3630	386	29.5	36	30	54.65	2.36
	T-BC0Z-4230	425	29.5	42	30	65.55	2.72
	T-BC0Z-4830	476	29.5	48	30	76.45	3.07

ordering options

- > laminate color
- > edge profile
- > grommet color

Each laminate comes with matching vinyl trim color unless otherwise specified on your purchase order. Refer to the laminate finish card for details.

details

- > Partial modesties are 12"H.

executive | returns

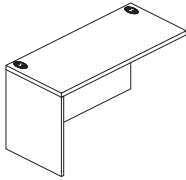
Description	Item Number	Price	Dimensions (inches)			Weight (lb.)	Cubic Feet
			H	W	D		
1.5" Straight Return w/Full Modesty, LH Shown 	T-WS1G-3021-L	417	29.5	30	21	60.74	1.97
	T-WS1G-3621-L	423	29.5	36	21	70.18	2.31
	T-WS1G-4221-L	429	29.5	42	21	79.62	2.66
	T-WS1G-4821-L	453	29.5	48	21	89.06	3.01
	T-WS1G-5421-L	476	29.5	54	21	98.50	3.36
	T-WS1G-6021-L	500	29.5	60	21	107.94	3.70
	T-WS1G-3021-R	417	29.5	30	21	60.74	1.97
	T-WS1G-3621-R	423	29.5	36	21	70.18	2.31
	T-WS1G-4221-R	429	29.5	42	21	79.62	2.66
	T-WS1G-4821-R	453	29.5	48	21	89.06	3.01
	T-WS1G-5421-R	476	29.5	54	21	98.50	3.36
	T-WS1G-6021-R	500	29.5	60	21	107.94	3.70
	T-WS1G-3024-L	423	29.5	30	24	65.92	2.20
	T-WS1G-3624-L	429	29.5	36	24	75.19	2.59
	T-WS1G-4224-L	441	29.5	42	24	84.46	2.98
	T-WS1G-4824-L	464	29.5	48	24	93.73	3.37
	T-WS1G-5424-L	489	29.5	54	24	103.00	3.76
	T-WS1G-6024-L	512	29.5	60	24	112.27	4.15
	T-WS1G-3024-R	423	29.5	30	24	65.92	2.20
	T-WS1G-3624-R	429	29.5	36	24	75.19	2.59
	T-WS1G-4224-R	441	29.5	42	24	84.46	2.98
	T-WS1G-4824-R	464	29.5	48	24	93.73	3.37
	T-WS1G-5424-R	489	29.5	54	24	103.00	3.76
	T-WS1G-6024-R	512	29.5	60	24	112.27	4.15
	T-WS1G-3030-L	464	29.5	30	30	77.42	2.68
	T-WS1G-3630-L	482	29.5	36	30	88.42	3.15
	T-WS1G-4230-L	500	29.5	42	30	99.42	3.62
	T-WS1G-4830-L	518	29.5	48	30	110.42	4.09
	T-WS1G-5430-L	536	29.5	54	30	121.42	4.56
	T-WS1G-6030-L	566	29.5	60	30	132.42	5.04
T-WS1G-3030-R	464	29.5	30	30	77.42	2.68	
T-WS1G-3630-R	482	29.5	36	30	88.42	3.15	
T-WS1G-4230-R	500	29.5	42	30	99.42	3.62	
T-WS1G-4830-R	518	29.5	48	30	110.42	4.09	
T-WS1G-5430-R	536	29.5	54	30	121.42	4.56	
T-WS1G-6030-R	566	29.5	60	30	132.42	5.04	

ordering options

- > laminate color
- > edge profile
- > grommet color

Each laminate comes with matching vinyl trim color unless otherwise specified on your purchase order. Refer to the laminate finish card for details.

details

- > Refer to page 12 for grommet placement.

executive | returns

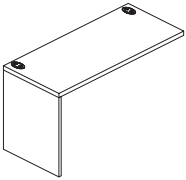
Description	Item Number	Price	Dimensions (inches)			Weight (lb.)	Cubic Feet
			H	W	D		
1.5" Straight Return w/Partial Modesty, LH Shown 	T-WS1Z-3021-L	417	29.5	30	21	48.66	1.97
	T-WS1Z-3621-L	423	29.5	36	21	58.10	2.31
	T-WS1Z-4221-L	429	29.5	42	21	67.54	2.66
	T-WS1Z-4821-L	453	29.5	48	21	76.98	3.01
	T-WS1Z-5421-L	476	29.5	54	21	86.42	3.36
	T-WS1Z-6021-L	500	29.5	60	21	95.86	3.70
	T-WS1Z-3021-R	417	29.5	30	21	48.66	1.97
	T-WS1Z-3621-R	423	29.5	36	21	58.10	2.31
	T-WS1Z-4221-R	429	29.5	42	21	67.54	2.66
	T-WS1Z-4821-R	453	29.5	48	21	76.98	3.01
	T-WS1Z-5421-R	476	29.5	54	21	86.42	3.36
	T-WS1Z-6021-R	500	29.5	60	21	95.86	3.70
	T-WS1Z-3024-L	423	29.5	30	24	55.62	2.20
	T-WS1Z-3624-L	429	29.5	36	24	64.89	2.59
	T-WS1Z-4224-L	441	29.5	42	24	74.16	2.98
	T-WS1Z-4824-L	464	29.5	48	24	83.43	3.37
	T-WS1Z-5424-L	489	29.5	54	24	92.70	3.76
	T-WS1Z-6024-L	512	29.5	60	24	101.97	4.15
	T-WS1Z-3024-R	423	29.5	30	24	55.62	2.20
	T-WS1Z-3624-R	429	29.5	36	24	64.89	2.59
	T-WS1Z-4224-R	441	29.5	42	24	74.16	2.98
	T-WS1Z-4824-R	464	29.5	48	24	83.43	3.37
	T-WS1Z-5424-R	489	29.5	54	24	92.70	3.76
	T-WS1Z-6024-R	512	29.5	60	24	101.97	4.15
	T-WS1Z-3030-L	464	29.5	30	30	69.50	2.68
	T-WS1Z-3630-L	482	29.5	36	30	80.50	3.15
	T-WS1Z-4230-L	500	29.5	42	30	91.50	3.62
	T-WS1Z-4830-L	518	29.5	48	30	102.50	4.09
T-WS1Z-5430-L	536	29.5	54	30	113.50	4.56	
T-WS1Z-6030-L	566	29.5	60	30	124.50	5.04	
T-WS1Z-3030-R	464	29.5	30	30	69.50	2.68	
T-WS1Z-3630-R	482	29.5	36	30	80.50	3.15	
T-WS1Z-4230-R	500	29.5	42	30	91.50	3.62	
T-WS1Z-4830-R	518	29.5	48	30	102.50	4.09	
T-WS1Z-5430-R	536	29.5	54	30	113.50	4.56	
T-WS1Z-6030-R	566	29.5	60	30	124.50	5.04	

ordering options

- > laminate color
- > edge profile
- > grommet color

Each laminate comes with matching vinyl trim color unless otherwise specified on your purchase order. Refer to the laminate finish card for details.

details

- > Partial modesties are 12"H.
- > Refer to page 12 for grommet placement.

executive | returns

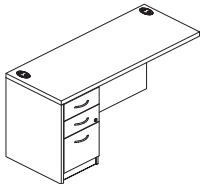
Description	Item Number	Price	Dimensions (inches)			Weight (lb.)	Cubic Feet
			H	W	D		
1.5" Straight Return w/Full Modesty, Box/Box/File, LH Shown 	T-WRBX-3021-L	750	29.5	30	21	101.88	16.48
	T-WRBX-3621-L	762	29.5	36	21	111.48	19.39
	T-WRBX-4221-L	774	29.5	42	21	121.08	22.29
	T-WRBX-4821-L	851	29.5	48	21	130.68	25.20
	T-WRBX-5421-L	864	29.5	54	21	140.28	28.11
	T-WRBX-6021-L	881	29.5	60	21	149.88	31.02
	T-WRBX-3021-R	750	29.5	30	21	101.88	16.48
	T-WRBX-3621-R	762	29.5	36	21	111.48	19.39
	T-WRBX-4221-R	774	29.5	42	21	121.08	22.29
	T-WRBX-4821-R	851	29.5	48	21	130.68	25.20
	T-WRBX-5421-R	864	29.5	54	21	140.28	28.11
	T-WRBX-6021-R	881	29.5	60	21	149.88	31.02
	T-WRBX-3024-L	774	29.5	30	24	107.22	18.46
	T-WRBX-3624-L	787	29.5	36	24	116.82	21.71
	T-WRBX-4224-L	798	29.5	42	24	126.42	24.97
	T-WRBX-4824-L	876	29.5	48	24	136.02	28.23
	T-WRBX-5424-L	887	29.5	54	24	145.62	31.48
	T-WRBX-6024-L	905	29.5	60	24	155.22	34.74
	T-WRBX-3024-R	774	29.5	30	24	107.22	18.46
	T-WRBX-3624-R	787	29.5	36	24	116.82	21.71
	T-WRBX-4224-R	798	29.5	42	24	126.42	24.97
	T-WRBX-4824-R	876	29.5	48	24	136.02	28.23
	T-WRBX-5424-R	887	29.5	54	24	145.62	31.48
	T-WRBX-6024-R	905	29.5	60	24	155.22	34.74
	T-WRBX-3030-L	798	29.5	30	30	118.87	22.41
	T-WRBX-3630-L	810	29.5	36	30	130.46	26.37
	T-WRBX-4230-L	822	29.5	42	30	142.05	30.32
	T-WRBX-4830-L	899	29.5	48	30	153.64	34.28
	T-WRBX-5430-L	912	29.5	54	30	165.23	38.23
	T-WRBX-6030-L	930	29.5	60	30	176.82	42.19
T-WRBX-3030-R	798	29.5	30	30	118.87	22.41	
T-WRBX-3630-R	810	29.5	36	30	130.46	26.37	
T-WRBX-4230-R	822	29.5	42	30	142.05	30.32	
T-WRBX-4830-R	899	29.5	48	30	153.64	34.28	
T-WRBX-5430-R	912	29.5	54	30	165.23	38.23	
T-WRBX-6030-R	930	29.5	60	30	176.82	42.19	

ordering options

- > laminate color
- > edge profile
- > grommet color
- > handle color
- > handle style

details

- > 21"D returns do not include grommets. Refer to page 12 for details.
- > Pedestals include lock and keys. Refer to page 8 for details.

Each laminate comes with matching vinyl trim color unless otherwise specified on your purchase order. Refer to the laminate finish card for details.

executive | returns

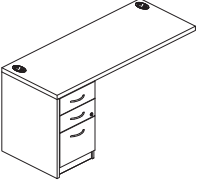
Description	Item Number	Price	Dimensions (inches)			Weight (lb.)	Cubic Feet
			H	W	D		
1.5" Straight Return w/Partial Modesty, Box/Box/File, LH Shown 	T-WRBX-3021-L-P	750	29.5	30	21	87.03	16.48
	T-WRBX-3621-L-P	762	29.5	36	21	96.63	19.39
	T-WRBX-4221-L-P	774	29.5	42	21	106.23	22.29
	T-WRBX-4821-L-P	851	29.5	48	21	115.83	25.20
	T-WRBX-5421-L-P	864	29.5	54	21	125.43	28.11
	T-WRBX-6021-L-P	881	29.5	60	21	135.03	31.02
	T-WRBX-3021-R-P	750	29.5	30	21	87.03	16.48
	T-WRBX-3621-R-P	762	29.5	36	21	96.63	19.39
	T-WRBX-4221-R-P	774	29.5	42	21	106.23	22.29
	T-WRBX-4821-R-P	851	29.5	48	21	115.83	25.20
	T-WRBX-5421-R-P	864	29.5	54	21	125.43	28.11
	T-WRBX-6021-R-P	881	29.5	60	21	135.03	31.02
	T-WRBX-3024-L-P	774	29.5	30	24	92.37	18.46
	T-WRBX-3624-L-P	787	29.5	36	24	101.97	21.71
	T-WRBX-4224-L-P	798	29.5	42	24	111.57	24.97
	T-WRBX-4824-L-P	876	29.5	48	24	121.17	28.23
	T-WRBX-5424-L-P	887	29.5	54	24	130.77	31.48
	T-WRBX-6024-L-P	905	29.5	60	24	140.37	34.74
	T-WRBX-3024-R-P	798	29.5	30	24	92.37	18.46
	T-WRBX-3624-R-P	810	29.5	36	24	101.97	21.71
	T-WRBX-4224-R-P	822	29.5	42	24	111.57	24.97
	T-WRBX-4824-R-P	899	29.5	48	24	121.17	28.23
	T-WRBX-5424-R-P	912	29.5	54	24	130.77	31.48
	T-WRBX-6024-R-P	930	29.5	60	24	140.37	34.74
T-WRBX-3030-L-P	798	29.5	30	30	104.02	22.41	
T-WRBX-3630-L-P	810	29.5	36	30	115.61	26.37	
T-WRBX-4230-L-P	822	29.5	42	30	127.20	30.32	
T-WRBX-4830-L-P	899	29.5	48	30	138.79	34.28	
T-WRBX-5430-L-P	912	29.5	54	30	150.38	38.23	
T-WRBX-6030-L-P	930	29.5	60	30	161.97	42.19	
T-WRBX-3030-R-P	798	29.5	30	30	104.02	22.41	
T-WRBX-3630-R-P	810	29.5	36	30	115.61	26.37	
T-WRBX-4230-R-P	822	29.5	42	30	127.20	30.32	
T-WRBX-4830-R-P	899	29.5	48	30	138.79	34.28	
T-WRBX-5430-R-P	912	29.5	54	30	150.38	38.23	
T-WRBX-6030-R-P	930	29.5	60	30	161.97	42.19	

ordering options

- > laminate color
- > edge profile
- > grommet color
- > handle color
- > handle style

details

- > Partial modesties are 12"H.
- > 21"D returns do not include grommets. Refer to page 12 for details.
- > Pedestals include lock and keys. Refer to page 8 for details.

Each laminate comes with matching vinyl trim color unless otherwise specified on your purchase order. Refer to the laminate finish card for details.

executive | returns

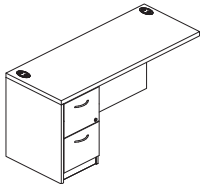
Description	Item Number	Price	Dimensions (inches)			Weight (lb.)	Cubic Feet
			H	W	D		
1.5" Straight Return w/Full Modesty, File/File, LH Shown 	T-WRFX-3021-L	750	29.5	30	21	101.88	16.48
	T-WRFX-3621-L	762	29.5	36	21	111.48	19.39
	T-WRFX-4221-L	774	29.5	42	21	121.08	22.29
	T-WRFX-4821-L	851	29.5	48	21	130.68	25.20
	T-WRFX-5421-L	864	29.5	54	21	140.28	28.11
	T-WRFX-6021-L	881	29.5	60	21	149.88	31.02
	T-WRFX-3021-R	750	29.5	30	21	101.88	16.48
	T-WRFX-3621-R	762	29.5	36	21	111.48	19.39
	T-WRFX-4221-R	774	29.5	42	21	121.08	22.29
	T-WRFX-4821-R	851	29.5	48	21	130.68	25.20
	T-WRFX-5421-R	864	29.5	54	21	140.28	28.11
	T-WRFX-6021-R	881	29.5	60	21	149.88	31.02
	T-WRFX-3024-L	774	29.5	30	24	107.22	18.46
	T-WRFX-3624-L	787	29.5	36	24	116.82	21.71
	T-WRFX-4224-L	798	29.5	42	24	126.42	24.97
	T-WRFX-4824-L	876	29.5	48	24	136.02	28.23
	T-WRFX-5424-L	887	29.5	54	24	145.62	31.48
	T-WRFX-6024-L	905	29.5	60	24	155.22	34.74
	T-WRFX-3024-R	774	29.5	30	24	107.22	18.46
	T-WRFX-3624-R	787	29.5	36	24	116.82	21.71
	T-WRFX-4224-R	798	29.5	42	24	126.42	24.97
	T-WRFX-4824-R	876	29.5	48	24	136.02	28.23
	T-WRFX-5424-R	887	29.5	54	24	145.62	31.48
	T-WRFX-6024-R	905	29.5	60	24	155.22	34.74
	T-WRFX-3030-L	798	29.5	30	30	118.87	22.41
	T-WRFX-3630-L	810	29.5	36	30	130.46	26.37
	T-WRFX-4230-L	822	29.5	42	30	142.05	30.32
	T-WRFX-4830-L	899	29.5	48	30	153.64	34.28
	T-WRFX-5430-L	912	29.5	54	30	165.23	38.23
	T-WRFX-6030-L	930	29.5	60	30	176.82	42.19
T-WRFX-3030-R	798	29.5	30	30	118.87	22.41	
T-WRFX-3630-R	810	29.5	36	30	130.46	26.37	
T-WRFX-4230-R	822	29.5	42	30	142.05	30.32	
T-WRFX-4830-R	899	29.5	48	30	153.64	34.28	
T-WRFX-5430-R	912	29.5	54	30	165.23	38.23	
T-WRFX-6030-R	930	29.5	60	30	176.82	42.19	

ordering options

- > laminate color
- > edge profile
- > grommet color
- > handle color
- > handle style

details

- > 21"D returns do not include grommets. Refer to page 12 for details.
- > Pedestals include lock and keys. Refer to page 8 for details.

Each laminate comes with matching vinyl trim color unless otherwise specified on your purchase order. Refer to the laminate finish card for details.

executive | returns

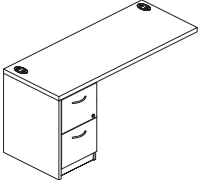
Description	Item Number	Price	Dimensions (inches)			Weight (lb.)	Cubic Feet
			H	W	D		
1.5" Straight Return w/Partial Modesty, File/File, LH Shown 	T-WRFX-3021-L-P	750	29.5	30	21	64.76	16.48
	T-WRFX-3621-L-P	762	29.5	36	21	74.36	19.39
	T-WRFX-4221-L-P	774	29.5	42	21	83.96	22.29
	T-WRFX-4821-L-P	851	29.5	48	21	93.56	25.20
	T-WRFX-5421-L-P	864	29.5	54	21	103.16	28.11
	T-WRFX-6021-L-P	881	29.5	60	21	112.76	31.02
	T-WRFX-3021-R-P	750	29.5	30	21	64.76	16.48
	T-WRFX-3621-R-P	762	29.5	36	21	74.36	19.39
	T-WRFX-4221-R-P	774	29.5	42	21	83.96	22.29
	T-WRFX-4821-R-P	851	29.5	48	21	93.56	25.20
	T-WRFX-5421-R-P	864	29.5	54	21	103.16	28.11
	T-WRFX-6021-R-P	881	29.5	60	21	112.76	31.02
	T-WRFX-3024-L-P	774	29.5	30	24	70.10	18.46
	T-WRFX-3624-L-P	787	29.5	36	24	79.70	21.71
	T-WRFX-4224-L-P	798	29.5	42	24	89.30	24.97
	T-WRFX-4824-L-P	876	29.5	48	24	98.90	28.23
	T-WRFX-5424-L-P	887	29.5	54	24	108.50	31.48
	T-WRFX-6024-L-P	905	29.5	60	24	118.10	34.74
	T-WRFX-3024-R-P	774	29.5	30	24	70.10	18.46
	T-WRFX-3624-R-P	787	29.5	36	24	79.70	21.71
	T-WRFX-4224-R-P	798	29.5	42	24	89.30	24.97
	T-WRFX-4824-R-P	876	29.5	48	24	98.90	28.23
	T-WRFX-5424-R-P	887	29.5	54	24	108.50	31.48
	T-WRFX-6024-R-P	905	29.5	60	24	118.10	34.74
	T-WRFX-3030-L-P	798	29.5	30	30	81.75	22.41
	T-WRFX-3630-L-P	810	29.5	36	30	93.34	26.37
	T-WRFX-4230-L-P	822	29.5	42	30	104.93	30.32
	T-WRFX-4830-L-P	899	29.5	48	30	116.52	34.28
T-WRFX-5430-L-P	912	29.5	54	30	128.11	38.23	
T-WRFX-6030-L-P	930	29.5	60	30	139.70	42.19	
T-WRFX-3030-R-P	798	29.5	30	30	81.75	22.41	
T-WRFX-3630-R-P	810	29.5	36	30	93.34	26.37	
T-WRFX-4230-R-P	822	29.5	42	30	104.93	30.32	
T-WRFX-4830-R-P	899	29.5	48	30	116.52	34.28	
T-WRFX-5430-R-P	912	29.5	54	30	128.11	38.23	
T-WRFX-6030-R-P	930	29.5	60	30	139.70	42.19	

ordering options

- > laminate color
- > edge profile
- > grommet color
- > handle color
- > handle style

Each laminate comes with matching vinyl trim color unless otherwise specified on your purchase order. Refer to the laminate finish card for details.

details

- > Partial modesties are 12"H.
- > 21"D returns do not include grommets. Refer to page 12 for details.
- > Pedestals include lock and keys. Refer to page 8 for details.

executive | returns

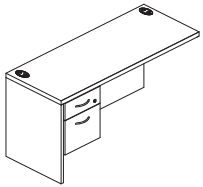
Description	Item Number	Price	Dimensions (inches)			Weight (lb.)	Cubic Feet
			H	W	D		
1.5" Straight Return w/Full Modesty, Suspended Pedestal, LH Shown 	T-WRSX-3021-L	632	29.5	30	21	87.31	16.48
	T-WRSX-3621-L	655	29.5	36	21	94.96	19.39
	T-WRSX-4221-L	686	29.5	42	21	102.61	22.29
	T-WRSX-4821-L	756	29.5	48	21	110.26	25.20
	T-WRSX-5421-L	810	29.5	54	21	117.91	28.11
	T-WRSX-6021-L	840	29.5	60	21	125.56	31.02
	T-WRSX-3021-R	632	29.5	30	21	87.31	16.48
	T-WRSX-3621-R	655	29.5	36	21	94.96	19.39
	T-WRSX-4221-R	686	29.5	42	21	102.61	22.29
	T-WRSX-4821-R	756	29.5	48	21	110.26	25.20
	T-WRSX-5421-R	810	29.5	54	21	117.91	28.11
	T-WRSX-6021-R	840	29.5	60	21	125.56	31.02
T-WRSX-3024-L	668	29.5	30	24	91.66	18.46	
T-WRSX-3624-L	709	29.5	36	24	100.06	21.71	
T-WRSX-4224-L	720	29.5	42	24	108.46	24.97	
T-WRSX-4824-L	756	29.5	48	24	116.86	28.23	
T-WRSX-5424-L	834	29.5	54	24	125.26	31.48	
T-WRSX-6024-L	864	29.5	60	24	133.66	34.74	
T-WRSX-3024-R	668	29.5	30	24	91.66	18.46	
T-WRSX-3624-R	709	29.5	36	24	100.06	21.71	
T-WRSX-4224-R	720	29.5	42	24	108.46	24.97	
T-WRSX-4824-R	756	29.5	48	24	116.86	28.23	
T-WRSX-5424-R	834	29.5	54	24	125.26	31.48	
T-WRSX-6024-R	864	29.5	60	24	133.66	34.74	
T-WRSX-3030-L	678	29.5	30	30	100.84	22.41	
T-WRSX-3630-L	714	29.5	36	30	110.02	26.37	
T-WRSX-4230-L	732	29.5	42	30	119.20	30.32	
T-WRSX-4830-L	805	29.5	48	30	128.38	34.28	
T-WRSX-5430-L	858	29.5	54	30	137.56	38.23	
T-WRSX-6030-L	887	29.5	60	30	146.74	42.19	
T-WRSX-3030-R	678	29.5	30	30	100.84	22.41	
T-WRSX-3630-R	714	29.5	36	30	110.02	26.37	
T-WRSX-4230-R	732	29.5	42	30	119.20	30.32	
T-WRSX-4830-R	805	29.5	48	30	128.38	34.28	
T-WRSX-5430-R	858	29.5	54	30	137.56	38.23	
T-WRSX-6030-R	887	29.5	60	30	146.74	42.19	

ordering options

- > laminate color
- > edge profile
- > grommet color
- > handle color
- > handle style

details

- > 21"D returns do not include grommets. Refer to page 12 for details.
- > Pedestals include lock and keys. Refer to page 8 for details.

Each laminate comes with matching vinyl trim color unless otherwise specified on your purchase order. Refer to the laminate finish card for details.

executive | returns

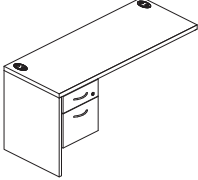
Description	Item Number	Price	Dimensions (inches)			Weight (lb.)	Cubic Feet
			H	W	D		
1.5" Straight Return w/Partial Modesty, Suspended Pedestal, LH Shown 	T-WRSX-3021-L-P	632	29.5	30	21	72.46	16.48
	T-WRSX-3621-L-P	655	29.5	36	21	80.11	19.39
	T-WRSX-4221-L-P	686	29.5	42	21	87.76	22.29
	T-WRSX-4821-L-P	756	29.5	48	21	95.41	25.20
	T-WRSX-5421-L-P	810	29.5	54	21	103.06	28.11
	T-WRSX-6021-L-P	840	29.5	60	21	110.71	31.02
	T-WRSX-3021-R-P	632	29.5	30	21	72.46	16.48
	T-WRSX-3621-R-P	655	29.5	36	21	80.11	19.39
	T-WRSX-4221-R-P	686	29.5	42	21	87.76	22.29
	T-WRSX-4821-R-P	756	29.5	48	21	95.41	25.20
	T-WRSX-5421-R-P	810	29.5	54	21	103.06	28.11
	T-WRSX-6021-R-P	840	29.5	60	21	110.71	31.02
	T-WRSX-3024-L-P	668	29.5	30	24	76.81	18.46
	T-WRSX-3624-L-P	709	29.5	36	24	85.21	21.71
	T-WRSX-4224-L-P	720	29.5	42	24	93.61	24.97
	T-WRSX-4824-L-P	756	29.5	48	24	102.01	28.23
	T-WRSX-5424-L-P	834	29.5	54	24	110.41	31.48
	T-WRSX-6024-L-P	864	29.5	60	24	118.81	34.74
	T-WRSX-3024-R-P	668	29.5	30	24	76.81	18.46
	T-WRSX-3624-R-P	709	29.5	36	24	85.21	21.71
	T-WRSX-4224-R-P	720	29.5	42	24	93.61	24.97
	T-WRSX-4824-R-P	756	29.5	48	24	102.01	28.23
	T-WRSX-5424-R-P	834	29.5	54	24	110.41	31.48
	T-WRSX-6024-R-P	864	29.5	60	24	118.81	34.74
T-WRSX-3030-L-P	678	29.5	30	30	85.99	22.41	
T-WRSX-3630-L-P	714	29.5	36	30	95.17	26.37	
T-WRSX-4230-L-P	732	29.5	42	30	104.35	30.32	
T-WRSX-4830-L-P	805	29.5	48	30	113.53	34.28	
T-WRSX-5430-L-P	858	29.5	54	30	122.71	38.23	
T-WRSX-6030-L-P	887	29.5	60	30	131.89	42.19	
T-WRSX-3030-R-P	678	29.5	30	30	85.99	22.41	
T-WRSX-3630-R-P	714	29.5	36	30	95.17	26.37	
T-WRSX-4230-R-P	732	29.5	42	30	104.35	30.32	
T-WRSX-4830-R-P	805	29.5	48	30	113.53	34.28	
T-WRSX-5430-R-P	858	29.5	54	30	122.71	38.23	
T-WRSX-6030-R-P	887	29.5	60	30	131.89	42.19	

ordering options

- > laminate color
- > edge profile
- > grommet color
- > handle color
- > handle style

details

- > Partial modesties are 12"H.
- > 21"D returns do not include grommets. Refer to page 12 for details.
- > Pedestals include lock and keys. Refer to page 8 for details.

Each laminate comes with matching vinyl trim color unless otherwise specified on your purchase order. Refer to the laminate finish card for details.

executive | returns

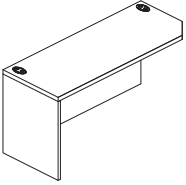
Description	Item Number	Price	Dimensions (inches)			Weight (lb.)	Cubic Feet
			H	W	D		
1.5" Notched Return w/Full Modesty, LH Shown 	T-WNOG-3024-L	447	29.5	30	24	65.22	2.20
	T-WNOG-3624-L	471	29.5	36	24	74.69	2.59
	T-WNOG-4224-L	494	29.5	42	24	84.16	2.98
	T-WNOG-4824-L	518	29.5	48	24	93.63	3.37
	T-WNOG-5424-L	536	29.5	54	24	103.10	3.76
	T-WNOG-6024-L	548	29.5	60	24	112.57	4.15
	T-WNOG-3024-R	447	29.5	30	24	65.22	2.20
	T-WNOG-3624-R	471	29.5	36	24	74.69	2.59
	T-WNOG-4224-R	494	29.5	42	24	84.16	2.98
	T-WNOG-4824-R	518	29.5	48	24	93.63	3.37
	T-WNOG-5424-R	536	29.5	54	24	103.10	3.76
	T-WNOG-6024-R	548	29.5	60	24	112.57	4.15
	T-WNOG-3030-L	524	29.5	30	30	76.75	2.68
	T-WNOG-3630-L	560	29.5	36	30	87.98	3.15
	T-WNOG-4230-L	583	29.5	42	30	99.21	3.62
	T-WNOG-4830-L	619	29.5	48	30	110.44	4.09
	T-WNOG-5430-L	642	29.5	54	30	121.67	4.56
	T-WNOG-6030-L	660	29.5	60	30	132.90	5.04
	T-WNOG-3030-R	524	29.5	30	30	76.75	2.68
	T-WNOG-3630-R	560	29.5	36	30	87.98	3.15
	T-WNOG-4230-R	583	29.5	42	30	99.21	3.62
	T-WNOG-4830-R	619	29.5	48	30	110.44	4.09
	T-WNOG-5430-R	642	29.5	54	30	121.67	4.56
	T-WNOG-6030-R	660	29.5	60	30	132.90	5.04

ordering options

- > laminate color
- > edge profile
- > grommet color

Each laminate comes with matching vinyl trim color unless otherwise specified on your purchase order. Refer to the laminate finish card for details.

details

- > Refer to page 12 for grommet placement.

executive | returns

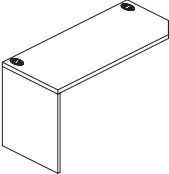
Description	Item Number	Price	Dimensions (inches)			Weight (lb.)	Cubic Feet
			H	W	D		
1.5" Notched Return w/Partial Modesty, LH Shown 	T-WNOZ-3024-L	447	29.5	30	24	54.92	2.20
	T-WNOZ-3624-L	471	29.5	36	24	64.39	2.59
	T-WNOZ-4224-L	494	29.5	42	24	73.86	2.98
	T-WNOZ-4824-L	518	29.5	48	24	83.33	3.37
	T-WNOZ-5424-L	536	29.5	54	24	92.80	3.76
	T-WNOZ-6024-L	548	29.5	60	24	102.27	4.15
	T-WNOZ-3024-R	447	29.5	30	24	54.92	2.20
	T-WNOZ-3624-R	471	29.5	36	24	64.39	2.59
	T-WNOZ-4224-R	494	29.5	42	24	73.86	2.98
	T-WNOZ-4824-R	518	29.5	48	24	83.33	3.37
	T-WNOZ-5424-R	536	29.5	54	24	92.80	3.76
	T-WNOZ-6024-R	548	29.5	60	24	102.27	4.15
	T-WNOZ-3030-L	524	29.5	30	30	66.58	2.68
	T-WNOZ-3630-L	560	29.5	36	30	77.81	3.15
	T-WNOZ-4230-L	583	29.5	42	30	89.04	3.62
	T-WNOZ-4830-L	619	29.5	48	30	100.27	4.09
	T-WNOZ-5430-L	642	29.5	54	30	111.50	4.56
	T-WNOZ-6030-L	660	29.5	60	30	122.73	5.04
	T-WNOZ-3030-R	524	29.5	30	30	66.58	2.68
	T-WNOZ-3630-R	560	29.5	36	30	77.81	3.15
	T-WNOZ-4230-R	583	29.5	42	30	89.04	3.62
	T-WNOZ-4830-R	619	29.5	48	30	100.27	4.09
	T-WNOZ-5430-R	642	29.5	54	30	111.50	4.56
	T-WNOZ-6030-R	660	29.5	60	30	122.73	5.04

ordering options

- > laminate color
- > edge profile
- > grommet color

Each laminate comes with matching vinyl trim color unless otherwise specified on your purchase order. Refer to the laminate finish card for details.

details

- > Partial modesties are 12"H.
- > Refer to page 12 for grommet placement.

executive | returns

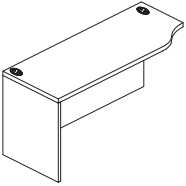
Description	Item Number	Price	Dimensions (inches)			Weight (lb.)	Cubic Feet
			H	W	D		
1.5" Bowed Return w/Full Modesty, LH Shown 	T-WBOG-3024-L	447	29.5	30	24	64.11	2.20
	T-WBOG-3624-L	471	29.5	36	24	73.79	2.59
	T-WBOG-4224-L	494	29.5	42	24	83.47	2.98
	T-WBOG-4824-L	518	29.5	48	24	93.15	3.37
	T-WBOG-5424-L	536	29.5	54	24	102.83	3.76
	T-WBOG-6024-L	548	29.5	60	24	112.51	4.15
	T-WBOG-3024-R	447	29.5	30	24	64.11	2.20
	T-WBOG-3624-R	471	29.5	36	24	73.79	2.59
	T-WBOG-4224-R	494	29.5	42	24	83.47	2.98
	T-WBOG-4824-R	518	29.5	48	24	93.15	3.37
	T-WBOG-5424-R	536	29.5	54	24	102.83	3.76
	T-WBOG-6024-R	548	29.5	60	24	112.51	4.15
	T-WBOG-3030-L	524	29.5	30	30	71.14	2.68
	T-WBOG-3630-L	560	29.5	36	30	77.93	3.15
	T-WBOG-4230-L	583	29.5	42	30	84.72	3.62
	T-WBOG-4830-L	619	29.5	48	30	91.51	4.09
	T-WBOG-5430-L	642	29.5	54	30	98.30	4.56
	T-WBOG-6030-L	660	29.5	60	30	105.09	5.04
	T-WBOG-3030-R	524	29.5	30	30	71.14	2.68
	T-WBOG-3630-R	560	29.5	36	30	77.93	3.15
	T-WBOG-4230-R	583	29.5	42	30	84.72	3.62
	T-WBOG-4830-R	619	29.5	48	30	91.51	4.09
	T-WBOG-5430-R	642	29.5	54	30	98.30	4.56
	T-WBOG-6030-R	660	29.5	60	30	105.09	5.04

ordering options

- > laminate color
- > edge profile
- > grommet color

Each laminate comes with matching vinyl trim color unless otherwise specified on your purchase order. Refer to the laminate finish card for details.

details

- > Refer to page 12 for grommet placement.

executive | returns

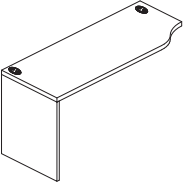
Description	Item Number	Price	Dimensions (inches)			Weight (lb.)	Cubic Feet
			H	W	D		
1.5" Bowed Return w/Partial Modesty, LH Shown 	T-WB0Z-3024-L	447	29.5	30	24	53.78	2.20
	T-WB0Z-3624-L	471	29.5	36	24	63.46	2.59
	T-WB0Z-4224-L	494	29.5	42	24	73.14	2.98
	T-WB0Z-4824-L	518	29.5	48	24	82.82	3.37
	T-WB0Z-5424-L	536	29.5	54	24	92.50	3.76
	T-WB0Z-6024-L	548	29.5	60	24	102.18	4.15
	T-WB0Z-3024-R	447	29.5	30	24	53.78	2.20
	T-WB0Z-3624-R	471	29.5	36	24	63.46	2.59
	T-WB0Z-4224-R	494	29.5	42	24	73.14	2.98
	T-WB0Z-4824-R	518	29.5	48	24	82.82	3.37
	T-WB0Z-5424-R	536	29.5	54	24	92.50	3.76
	T-WB0Z-6024-R	548	29.5	60	24	102.18	4.15
	T-WB0Z-3030-L	524	29.5	30	30	61.24	2.68
	T-WB0Z-3630-L	560	29.5	36	30	68.03	3.15
	T-WB0Z-4230-L	583	29.5	42	30	74.82	3.62
	T-WB0Z-4830-L	619	29.5	48	30	81.61	4.09
	T-WB0Z-5430-L	642	29.5	54	30	88.40	4.56
	T-WB0Z-6030-L	660	29.5	60	30	95.19	5.04
	T-WB0Z-3030-R	524	29.5	30	30	61.24	2.68
	T-WB0Z-3630-R	560	29.5	36	30	68.03	3.15
	T-WB0Z-4230-R	583	29.5	42	30	74.82	3.62
	T-WB0Z-4830-R	619	29.5	48	30	81.61	4.09
	T-WB0Z-5430-R	642	29.5	54	30	88.40	4.56
	T-WB0Z-6030-R	660	29.5	60	30	95.19	5.04

ordering options

- > laminate color
- > edge profile
- > grommet color

Each laminate comes with matching vinyl trim color unless otherwise specified on your purchase order. Refer to the laminate finish card for details.

details

- > Partial modesties are 12"H.
- > Refer to page 12 for grommet placement.

executive | straight transition worksurfaces

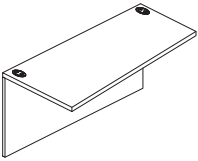
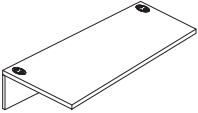
Description	Item Number	Price	Dimensions (inches)			Weight (lb.)	Cubic Feet
			H	W	D		
1.5" Straight Transition Worksurface w/Full Modesty, LH Shown 	T-BSTG-2430-L	322	29.5	24	30	42.30	1.65
	T-BSTG-3030-L	358	29.5	30	30	53.20	2.01
	T-BSTG-3630-L	382	29.5	36	30	64.10	2.36
	T-BSTG-4230-L	418	29.5	42	30	75.00	2.72
	T-BSTG-4830-L	464	29.5	48	30	85.90	3.07
	T-BSTG-5430-L	500	29.5	54	30	96.80	3.42
	T-BSTG-6030-L	536	29.5	60	30	107.70	3.78
	T-BSTG-2430-R	322	29.5	24	30	42.30	1.65
	T-BSTG-3030-R	358	29.5	30	30	53.20	2.01
	T-BSTG-3630-R	382	29.5	36	30	64.10	2.36
	T-BSTG-4230-R	418	29.5	42	30	75.00	2.72
	T-BSTG-4830-R	464	29.5	48	30	85.90	3.07
	T-BSTG-5430-R	500	29.5	54	30	96.80	3.42
	T-BSTG-6030-R	536	29.5	60	30	107.70	3.78
1.5" Straight Transition Worksurface w/Partial Modesty, LH Shown 	T-BSTZ-2430-L	322	29.5	24	30	32.40	1.65
	T-BSTZ-3030-L	358	29.5	30	30	43.30	2.01
	T-BSTZ-3630-L	382	29.5	36	30	54.20	2.36
	T-BSTZ-4230-L	418	29.5	42	30	65.10	2.72
	T-BSTZ-4830-L	464	29.5	48	30	76.00	3.07
	T-BSTZ-5430-L	500	29.5	54	30	86.90	3.42
	T-BSTZ-6030-L	536	29.5	60	30	97.80	3.78
	T-BSTZ-2430-R	322	29.5	24	30	32.40	1.65
	T-BSTZ-3030-R	358	29.5	30	30	43.30	2.01
	T-BSTZ-3630-R	382	29.5	36	30	54.20	2.36
	T-BSTZ-4230-R	418	29.5	42	30	65.10	2.72
	T-BSTZ-4830-R	464	29.5	48	30	76.00	3.07
	T-BSTZ-5430-R	500	29.5	54	30	86.90	3.42
	T-BSTZ-6030-R	536	29.5	60	30	97.80	3.78

ordering options

- > laminate color
- > edge profile
- > grommet color

Each laminate comes with matching vinyl trim color unless otherwise specified on your purchase order. Refer to the laminate finish card for details.

details

- > Partial modesties are 12"H.
- > Refer to page 12 for grommet placement.
- > Straight transition worksurface:

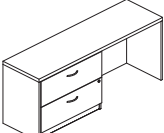

executive | credenzas

Description	Item Number	Price	Dimensions (inches)			Weight (lb.)	Cubic Feet
			H	W	D		
1.5" Credenza w/Full Modesty, Lateral File on Left-Hand Side 	T-CRL0-6021	1078	29.5	60	21	172.35	31.02
	T-CRL0-6621	1108	29.5	66	21	181.80	33.93
	T-CRL0-7221	1144	29.5	72	21	189.90	36.83
	T-CRL0-6024	1179	29.5	60	24	183.15	34.74
	T-CRL0-6624	1215	29.5	66	24	195.52	38.00
	T-CRL0-7224	1251	29.5	72	24	207.89	41.25

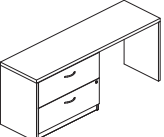
1.5" Credenza w/Partial Modesty, Lateral File on Left-Hand Side 	T-CRL0-6021-P	1078	29.5	60	21	135.23	31.02
	T-CRL0-6621-P	1108	29.5	66	21	144.68	33.93
	T-CRL0-7221-P	1144	29.5	72	21	154.13	36.83
	T-CRL0-6024-P	1179	29.5	60	24	146.03	34.74
	T-CRL0-6624-P	1215	29.5	66	24	158.40	38.00
	T-CRL0-7224-P	1251	29.5	72	24	170.77	41.25

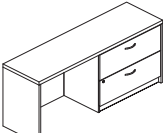
1.5" Credenza w/Full Modesty, Lateral File on Right-Hand Side 	T-CR0L-6021	1078	29.5	60	21	172.35	31.02
	T-CR0L-6621	1108	29.5	66	21	181.80	33.93
	T-CR0L-7221	1144	29.5	72	21	189.90	36.83
	T-CR0L-6024	1179	29.5	60	24	183.15	34.74
	T-CR0L-6624	1215	29.5	66	24	195.52	38.00
	T-CR0L-7224	1251	29.5	72	24	207.89	41.25

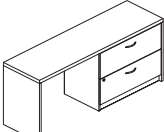
1.5" Credenza w/Partial Modesty, Lateral File on Right-Hand Side 	T-CR0L-6021-P	1078	29.5	60	21	135.23	31.02
	T-CR0L-6621-P	1108	29.5	66	21	144.68	33.93
	T-CR0L-7221-P	1144	29.5	72	21	154.13	36.83
	T-CR0L-6024-P	1179	29.5	60	24	146.03	34.74
	T-CR0L-6624-P	1215	29.5	66	24	158.40	38.00
	T-CR0L-7224-P	1251	29.5	72	24	170.77	41.25

ordering options

- > laminate color
- > edge profile
- > handle color
- > handle style

details

- > Partial modesties are 12"H.
- > Lateral Files include lock and keys.

Each laminate comes with matching vinyl trim color unless otherwise specified on your purchase order. Refer to the laminate finish card for details.

executive | credenzas

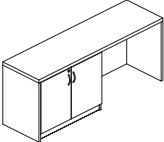
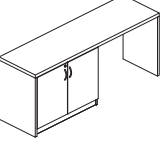
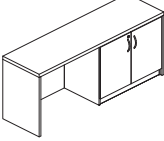
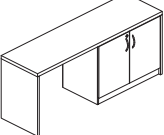
Description	Item Number	Price	Dimensions (inches)			Weight (lb.)	Cubic Feet
			H	W	D		
1.5" Credenza w/Full Modesty, Storage Cabinet on Left-Hand Side 	T-CRS0-6021	940	29.5	60	21	157.50	31.02
	T-CRS0-6621	970	29.5	66	21	166.95	33.93
	T-CRS0-7221	1007	29.5	72	21	186.30	36.83
	T-CRS0-6024	1043	29.5	60	24	169.00	34.74
	T-CRS0-6624	1078	29.5	66	24	183.05	38.00
	T-CRS0-7224	1119	29.5	72	24	197.11	41.25
1.5" Credenza w/Partial Modesty, Storage Cabinet on Left-Hand Side 	T-CRS0-6021-P	940	29.5	60	21	120.38	31.02
	T-CRS0-6621-P	970	29.5	66	21	125.89	33.93
	T-CRS0-7221-P	1007	29.5	72	21	141.30	36.83
	T-CRS0-6024-P	1043	29.5	60	24	131.88	34.74
	T-CRS0-6624-P	1078	29.5	66	24	141.99	38.00
	T-CRS0-7224-P	1119	29.5	72	24	156.05	41.25
1.5" Credenza w/Full Modesty, Storage Cabinet on Right-Hand Side 	T-CR0S-6021	940	29.5	60	21	157.50	31.02
	T-CR0S-6621	970	29.5	66	21	166.95	33.93
	T-CR0S-7221	1007	29.5	72	21	186.30	36.83
	T-CR0S-6024	1043	29.5	60	24	169.00	34.74
	T-CR0S-6624	1078	29.5	66	24	183.05	38.00
	T-CR0S-7224	1119	29.5	72	24	197.11	41.25
1.5" Credenza w/Partial Modesty, Storage Cabinet on Right-Hand Side 	T-CR0S-6021-P	940	29.5	60	21	120.38	31.02
	T-CR0S-6621-P	970	29.5	66	21	125.89	33.93
	T-CR0S-7221-P	1007	29.5	72	21	141.30	36.83
	T-CR0S-6024-P	1043	29.5	60	24	131.88	34.74
	T-CR0S-6624-P	1078	29.5	66	24	141.99	38.00
	T-CR0S-7224-P	1119	29.5	72	24	156.05	41.25

ordering options

- > laminate color
- > edge profile
- > handle color
- > handle style

Each laminate comes with matching vinyl trim color unless otherwise specified on your purchase order. Refer to the laminate finish card for details.

details

- > Partial modesties are 12"H.
- > Cabinets include lock and keys.

executive | credenzas

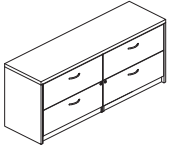
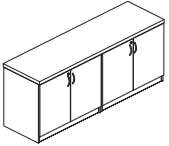
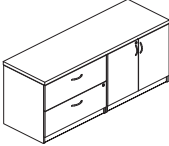
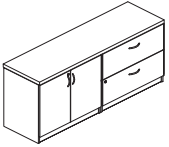
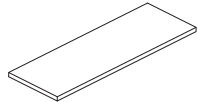
Description	Item Number	Price	Dimensions (inches)			Weight (lb.)	Cubic Feet
			H	W	D		
1.5" Credenza w/Double Lateral Files 	T-CRLL-7221	1483	29.5	72	21	232.65	36.83
	T-CRLL-7224	1573	29.5	72	24	250.64	41.25
1.5" Credenza w/Double Storage Cabinets 	T-CRSS-7221	1158	29.5	72	21	267.00	36.83
	T-CRSS-7224	1236	29.5	72	24	272.00	41.25
1.5" Credenza w/Lateral File on Left-Hand Side, Storage Cabinet on Right-Hand Side 	T-CRLS-7221	1337	29.5	72	21	229.05	36.83
	T-CRLS-7224	1449	29.5	72	24	247.04	41.25
1.5" Credenza w/Storage Cabinet on Left-Hand Side, Lateral File on Right-Hand Side 	T-CRSL-7221	1337	29.5	72	21	229.05	36.83
	T-CRSL-7224	1449	29.5	72	24	247.04	41.25
1.5" Credenza Top 	T-WSS0-6021	239	1.5	60	21	49.21	5.56
	T-WSS0-6621	262	1.5	66	21	54.14	6.08
	T-WSS0-7221	275	1.5	72	21	59.07	6.60
	T-WSS0-7821	298	1.5	78	21	64.00	7.12
	T-WSS0-8421	321	1.5	84	21	68.93	7.64

ordering options

- > laminate color
- > edge profile
- > handle color
- > handle style

Each laminate comes with matching vinyl trim color unless otherwise specified on your purchase order. Refer to the laminate finish card for details.

details

- > Cabinets and laterals include locks and keys.

executive | intermediate gable supports

Description	Item Number	Price	Dimensions (inches)			Weight (lb.)	Cubic Feet
			H	W	D		
Intermediate Gable Support	T-CGU0-12	111	28.0	12	1	8.75	1.48
	T-CGU0-18	120	28.0	18	1	13.12	2.04

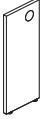

ordering options







- > laminate color
- > grommet color

Each laminate comes with matching vinyl trim color unless otherwise specified on your purchase order. Refer to the laminate finish card for details.

details

- > Refer to page 8 for specific details on intermediate gable support.

executive | pedestals

Description	Item Number	Price	Dimensions (inches)			Weight (lb.)	Cubic Feet
			H	W	D		
Underdesk Box/Box/File Pedestal 	T-FPBU-1618	516	28.0	16	18	55.00	8.15
Underdesk File/File Pedestal 	T-FPFU-1618	516	28.0	16	18	55.00	8.15
Suspended Box/File Pedestal 	T-FPSU-1618	367	16.0	16	18	44.00	5.09
Mobile Box/Box/File Pedestal 	T-FPBM-1621	679	28.0	16	21	74.00	9.26
Mobile File/File Pedestal 	T-FPFM-1621	679	28.0	16	21	68.00	9.26
Mobile Top-Load Pedestal w/Upholstered Seat Cushion 	T-1020-1618	828	23.0	16	18	55.00	6.88
Mobile Box/File Pedestal w/Upholstered Seat Cushion 	T-1030-1618	828	23.0	16	18	55.00	6.88

ordering options

- > laminate color
- > handle color
- > handle style
- > fabric color (for upholstered seat cushion, refer to seating fabric cards)

Each laminate comes with matching vinyl trim color unless otherwise specified on your purchase order. Refer to the laminate finish card for details.

details

- > Pedestals include lock and keys.

executive | filing and storage

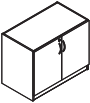
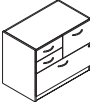
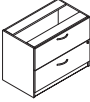
Description	Item Number	Price	Dimensions (inches)			Weight (lb.)	Cubic Feet
			H	W	D		
 Underdesk Storage Cabinet	T-FSU0-3020	632	28.0	30	20	88.00	15.11
	T-FSU0-3620	686	28.0	36	20	102.00	17.78
	T-FSU0-4220	738	28.0	42	20	117.00	20.44
	T-FSU0-3021	632	28.0	30	21	92.00	15.74
	T-FSU0-3621	686	28.0	36	21	107.00	18.52
	T-FSU0-4221	738	28.0	42	21	122.00	21.30
 Underdesk Combo Pedestal w/Box/Box/File and File/File, LH Shown	T-FPJU-3620-L	999	28.0	36	20	121.00	17.78
	T-FPJU-3621-L	999	28.0	36	21	122.00	18.52
	T-FPJU-3620-R	999	28.0	36	20	121.00	17.78
	T-FPJU-3621-R	999	28.0	36	21	122.00	18.52
 Underdesk 2-Drawer Lateral File	T-FL2U-3020	816	28.0	30	20	82.06	15.11
	T-FL2U-3620	846	28.0	36	20	86.64	17.78
	T-FL2U-4220	894	28.0	42	20	89.35	20.44
	T-FL2U-3021	816	28.0	30	21	84.60	15.74
	T-FL2U-3621	846	28.0	36	21	88.02	18.52
	T-FL2U-4221	894	28.0	42	21	91.44	21.30
1.5" Freestanding Storage Cabinet	T-FSF0-3021	696	29.5	30	21	98.00	16.48
	T-FSF0-3621	747	29.5	36	21	111.00	19.39
	T-FSF0-4221	798	29.5	42	21	124.00	22.29

ordering options

- > laminate color
- > edge profile (for freestanding cabinet)
- > handle color
- > handle style

Each laminate comes with matching vinyl trim color unless otherwise specified on your purchase order. Refer to the laminate finish card for details.

details

- > Cabinets and lateral files include lock and keys.

executive | filing and storage

Description	Item Number	Price	Dimensions (inches)			Weight (lb.)	Cubic Feet
			H	W	D		
1.5" Freestanding Combo Pedestal w/Box/Box/File and File/File, LH Shown	T-FPJF-3621-L	1045	29.5	36	21	130.00	19.39
	T-FPJF-3621-R	1045	29.5	36	21	130.00	19.39

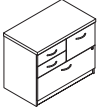

1.5" Freestanding 2-Drawer Lateral File	T-FL2F-3021	871	29.5	30	21	108.90	16.48
	T-FL2F-3621	899	29.5	36	21	117.27	19.39
	T-FL2F-4221	943	29.5	42	21	125.64	22.29

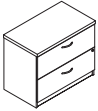

1.5" Freestanding 3-Drawer Lateral File	T-FL3F-3021	1084	40.5	30	21	145.00	21.89
	T-FL3F-3621	1131	40.5	36	21	154.96	25.75

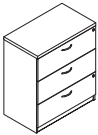

1.5" Freestanding 4-Drawer Lateral File	T-FL4F-3021	1417	52.5	30	21	171.30	27.79
	T-FL4F-3621	1465	52.5	36	21	183.24	32.70



filing and storage

ordering options

- > laminate color
- > edge profile
- > handle color
- > handle style

Each laminate comes with matching vinyl trim color unless otherwise specified on your purchase order. Refer to the laminate finish card for details.

details

- > Lateral files include locks and keys

executive | filing and storage

Description	Item Number	Price	Dimensions (inches)			Weight (lb.)	Cubic Feet
			H	W	D		
1.5" Storage Cabinet w/Shelves, LH Shown	T-FSDS-1821-L	774	68.0	18	21	133.65	22.92
	T-FSDS-1821-R	774	68.0	18	21	133.65	22.92



1.5" Combo Cabinet w/Storage and Box/Box/File, LH Shown	T-FCSB-1821-L	1215	68.0	18	21	168.00	22.92
	T-FCSB-1821-R	1215	68.0	18	21	168.00	22.92



1.5" Combo Cabinet w/Storage and File/File, LH Shown	T-FCSF-1821-L	1215	68.0	18	21	162.00	22.92
	T-FCSF-1821-R	1215	68.0	18	21	162.00	22.92



1.5" Storage Cabinet w/Coat Bar and Shelves, LH Shown	T-FSDC-2421-L	834	68.0	24	21	179.64	29.17
	T-FSDC-2421-R	834	68.0	24	21	179.64	29.17

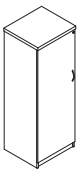

ordering options

- > laminate color
- > edge profile
- > handle color
- > handle style

Each laminate comes with matching vinyl trim color unless otherwise specified on your purchase order. Refer to the laminate finish card for details.

details

- > Cabinets include locks and keys.

executive | filing and storage

Description	Item Number	Price	Dimensions (inches)			Weight (lb.)	Cubic Feet
			H	W	D		
1.5" Storage Cabinet w/Shelves and Glazed Doors, LH Shown	T-FSDS-1821-L-G	1459	68.0	18	21	119.81	22.92
	T-FSDS-1821-R-G	1459	68.0	18	21	119.81	22.92

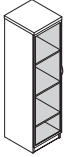

1.5" Combo Cabinet w/Storage, Box/Box/File and Glazed Doors, LH Shown	T-FCSB-1821-L-G	1745	68.0	18	21	131.00	22.92
	T-FCSB-1821-R-G	1745	68.0	18	21	131.00	22.92



1.5" Combo Cabinet w/Storage, File/File and Glazed Doors, LH Shown	T-FCSF-1821-L-G	1745	68.0	18	21	125.00	22.92
	T-FCSF-1821-R-G	1745	68.0	18	21	125.00	22.92



filing and storage

ordering options

- > laminate color
- > edge profile
- > metal color (for glazed door frame)
- > handle color
- > handle style

details

- > Only laminate drawers include lock and keys.

Each laminate comes with matching vinyl trim color unless otherwise specified on your purchase order. Refer to the laminate finish card for details.

executive | filing and storage

Description	Item Number	Price	Dimensions (inches)			Weight (lb.)	Cubic Feet
			H	W	D		
1.5" Double Door Storage Cabinet w/Shelves	T-FSDS-3621	1215	68.0	36	21	204.96	41.67

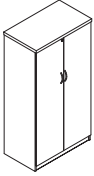

1.5" Combo Cabinet w/Storage and Lateral File	T-FCSL-3621	1442	68.0	36	21	260.82	41.67
--	-------------	------	------	----	----	--------	-------

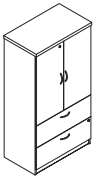

1.5" Combo Cabinet w/Storage and Combo Pedestal	T-FCSJ-3621	1595	68.0	36	21	266.82	41.67
--	-------------	------	------	----	----	--------	-------

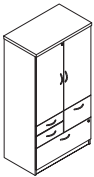

ordering options

- > laminate color
- > edge profile
- > handle color
- > handle style

Each laminate comes with matching vinyl trim color unless otherwise specified on your purchase order. Refer to the laminate finish card for details.

details

- > Cabinets include locks and keys.

executive | filing and storage

Description	Item Number	Price	Dimensions (inches)			Weight (lb.)	Cubic Feet
			H	W	D		
1.5" Double Door Storage Cabinet w/Shelves and Glazed Doors	T-FSDS-3621-G	2067	68.0	36	21	210.60	41.67

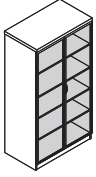

1.5" Combo Cabinet w/Storage, Lateral File and Glazed Doors	T-FCSL-3621-G	2322	68.0	36	21	222.62	41.67
--	---------------	------	------	----	----	--------	-------

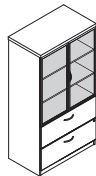

1.5" Combo Cabinet w/Storage, Combo Pedestal and Glazed Doors	T-FCSJ-3621-G	2477	68.0	36	21	229.87	41.67
--	---------------	------	------	----	----	--------	-------

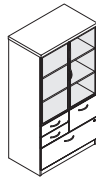

filing and storage

ordering options

- > laminate color
- > edge profile
- > metal color (for glazed door frame)
- > handle color
- > handle style

details

- > Only laminate drawers include lock and keys.

Each laminate comes with matching vinyl trim color unless otherwise specified on your purchase order. Refer to the laminate finish card for details.

executive | filing and storage

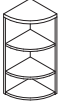
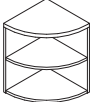
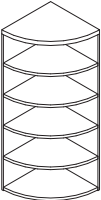
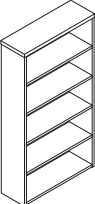
Description	Item Number	Price	Dimensions (inches)			Weight (lb.)	Cubic Feet
			H	W	D		
1.5" Desktop Radius Corner Bookcase 	T-SBRD-1538	429	38.0	15	15	46.35	8.77
1.5" Radius Corner Bookcase 	T-SBRC-292121	405	29.5	21	21	71.00	12.12
	T-SBRC-292424	471	29.5	24	24	95.50	13.57
	T-SBRC-682121	596	68.0	21	21	126.60	26.04
	T-SBRC-682424	738	68.0	24	24	152.00	32.67
1.5" Bookcase 	T-SB00-683012	601	68.0	30	12	161.90	22.67
	T-SB00-683612	678	68.0	36	12	174.60	26.67

ordering options

- > laminate color
- > edge profile

Each laminate comes with matching vinyl trim color unless otherwise specified on your purchase order. Refer to the laminate finish card for details.

details

- > Bookcases have adjustable shelves and one fixed shelf at desk height. Refer to page 9.

executive | hutches

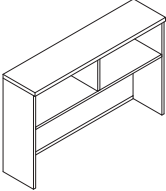
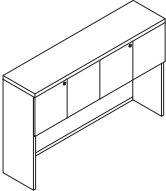
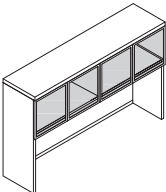
Description	Item Number	Price	Dimensions (inches)			Weight (lb.)	Cubic Feet
			H	W	D		
1.5" Open Hutch 	T-SHO0-1530	417	39.0	30	15	75.62	16.08
	T-SHO0-1536	482	39.0	36	15	84.86	18.91
	T-SHO0-1542	500	39.0	42	15	94.10	21.75
	T-SHO0-1548	554	39.0	48	15	103.34	24.59
	T-SHO0-1554	601	39.0	54	15	112.58	27.42
	T-SHO0-1560	650	39.0	60	15	121.82	30.26
	T-SHO0-1566	691	39.0	66	15	131.06	33.10
	T-SHO0-1572	745	39.0	72	15	140.30	35.93
	T-SHO0-1578	787	39.0	78	15	149.54	38.77
	T-SHO0-1584	834	39.0	84	15	158.78	41.61
1.5" Hinged-Door Hutch 	T-SHH0-1530-L	642	39.0	30	15	85.07	16.08
	T-SHH0-1536-L	678	39.0	36	15	94.31	18.91
	T-SHH0-1542-L	774	39.0	42	15	103.55	21.75
	T-SHH0-1548-L	840	39.0	48	15	117.51	24.59
	T-SHH0-1554-L	912	39.0	54	15	126.75	27.42
	T-SHH0-1560-L	971	39.0	60	15	140.72	30.26
	T-SHH0-1566-L	1030	39.0	66	15	149.96	33.10
	T-SHH0-1572-L	1084	39.0	72	15	159.20	35.93
	T-SHH0-1578-L	1137	39.0	78	15	168.44	38.77
	T-SHH0-1584-L	1179	39.0	84	15	177.68	41.61
1.5" Hinged-Door Hutch w/Glazed Doors 	T-SHH0-1530-G	1030	39.0	30	15	88.22	16.08
	T-SHH0-1536-G	1113	39.0	36	15	96.56	18.91
	T-SHH0-1542-G	1191	39.0	42	15	105.80	21.75
	T-SHH0-1548-G	1477	39.0	48	15	122.24	24.59
	T-SHH0-1554-G	1567	39.0	54	15	131.48	27.42
	T-SHH0-1560-G	1840	39.0	60	15	147.92	30.26
	T-SHH0-1566-G	1876	39.0	66	15	157.16	33.10
	T-SHH0-1572-G	1960	39.0	72	15	166.40	35.93
	T-SHH0-1578-G	2019	39.0	78	15	175.64	38.77
	T-SHH0-1584-G	2072	39.0	84	15	184.88	41.61

hutches

ordering options

- > laminate color
- > edge profile
- > metal color (for glazed door frame)

Each laminate comes with matching vinyl trim color unless otherwise specified on your purchase order. Refer to the laminate finish card for details.

details

- > Number of openings and doors per hutch:

width	30"	36"	42"	48"	54"	60"	66"	72"	78"	84"
openings	1	1	1	1	1	2	2	2	2	2
doors	2	2	3	3	3	4	4	4	4	4

- > Laminate doors include locks and keys.

executive | hutches

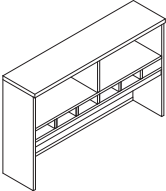
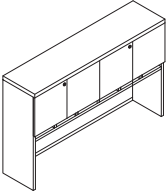
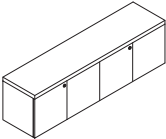
Description	Item Number	Price	Dimensions (inches)			Weight (lb.)	Cubic Feet
			H	W	D		
1.5" Open Hutch w/Pigeonholes 	T-SHOP-1530	583	39.0	30	15	87.77	16.08
	T-SHOP-1536	673	39.0	36	15	97.01	18.91
	T-SHOP-1542	696	39.0	42	15	111.69	21.75
	T-SHOP-1548	774	39.0	48	15	120.93	24.59
	T-SHOP-1554	840	39.0	54	15	135.58	27.42
	T-SHOP-1560	905	39.0	60	15	148.20	30.26
	T-SHOP-1566	966	39.0	66	15	157.44	33.10
	T-SHOP-1572	1043	39.0	72	15	170.74	35.93
	T-SHOP-1578	1096	39.0	78	15	183.36	38.77
	T-SHOP-1584	1167	39.0	84	15	195.99	41.61
1.5" Hinged-Door Hutch w/Pigeonholes 	T-SHHP-1530-L	792	39.0	30	15	97.22	16.08
	T-SHHP-1536-L	843	39.0	36	15	106.46	18.91
	T-SHHP-1542-L	955	39.0	42	15	121.14	21.75
	T-SHHP-1548-L	1045	39.0	48	15	135.10	24.59
	T-SHHP-1554-L	1135	39.0	54	15	149.75	27.42
	T-SHHP-1560-L	1208	39.0	60	15	167.10	30.26
	T-SHHP-1566-L	1248	39.0	66	15	176.34	33.10
	T-SHHP-1572-L	1326	39.0	72	15	189.64	35.93
	T-SHHP-1578-L	1382	39.0	78	15	202.26	38.77
	T-SHHP-1584-L	1438	39.0	84	15	214.89	41.61
1.5" Wall-Mounted Hinged-Door Hutch 	T-SHHW-1548-L	596	17.0	48	15	65.17	12.01
	T-SHHW-1554-L	618	17.0	54	15	71.26	13.39
	T-SHHW-1560-L	696	17.0	60	15	77.35	14.78
	T-SHHW-1566-L	730	17.0	66	15	83.44	16.16
	T-SHHW-1572-L	753	17.0	72	15	89.53	17.55

NOTE: INSTALL WALL-MOUNTED OVERHEADS DIRECTLY INTO PERMANENT STUDS. PLEASE REFER TO INSTALLATION INSTRUCTIONS.

ordering options

- > laminate color
- > edge profile

Each laminate comes with matching vinyl trim color unless otherwise specified on your purchase order. Refer to the laminate finish card for details.



details

- > Number of openings and doors per hutch:

width	30"	36"	42"	48"	54"	60"	66"	72"	78"	84"
openings	1	1	1	1	1	2	2	2	2	2
doors	2	2	3	3	3	4	4	4	4	4

- > Laminate doors include locks and keys.

executive | o-tabletops and bases

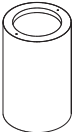
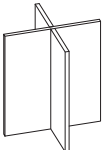
Description	Item Number	Price	Dimensions (inches)			Weight (lb.)	Cubic Feet
			H	W	D		
1.5" O-Tabletop 	T-WOXX-36	265	1.5	36	36	39.76	5.10
	T-WOXX-42	339	1.5	42	42	54.11	6.73
	T-WOXX-48	382	1.5	48	48	70.68	8.60
Post Support Base 	TB-BASE-1	212	28.0	3	3	7.00	0.85
Drum Base 	TB-BASE-2	530	28.0	18	18	30.00	19.34
Cross Base 	T-B6-36	244	28.0	24	24	33.64	14.52
	T-B6-42	254	28.0	30	30	42.29	21.41
	T-B6-48	270	28.0	36	36	49.23	29.63

o-tabletops and bases

ordering options

- > laminate color
- > edge profile (for o-tabletop)
- > metal color (for post support base)

Each laminate comes with matching vinyl trim color unless otherwise specified on your purchase order. Refer to the laminate finish card for details.

details

- > 4 post supports required for each o-tabletop.
- > Drum base:

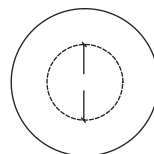

- > Drum base is not applicable on 48" o-tabletop.

executive | reception units

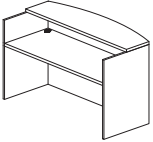
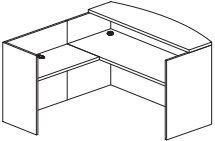
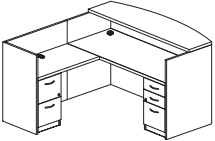
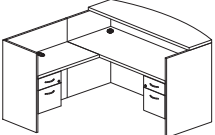
Description	Item Number	Price	Dimensions (inches)			Weight (lb.)	Cubic Feet
			H	W	D		
1.5" Reception Unit w/Countertop 	T-RC0G-7230	1251	43.5	72	30	272.25	71.03
1.5" Reception Unit w/Return and Countertop 	T-RC0G-7242-L	1621	43.5	72	72	379.87	158.77
	T-RC0G-7248-L	1698	43.5	72	78	390.60	171.31
	T-RC0G-7242-R	1621	43.5	72	72	379.87	158.77
	T-RC0G-7248-R	1698	43.5	72	78	390.60	171.31
1.5" Reception Unit w/Return and Countertop, Box/Box/File and File/File 	T-RCXK-7242-L	2279	43.5	72	72	463.61	158.77
	T-RCXK-7248-L	2354	43.5	72	78	474.34	171.31
	T-RCXK-7242-R	2279	43.5	72	72	463.61	158.77
	T-RCXK-7248-R	2354	43.5	72	78	474.34	171.31
1.5" Reception Unit w/Return and Countertop, Double Suspended Pedestals 	T-RCSK-7242-L	2091	43.5	72	72	450.99	158.77
	T-RCSK-7248-L	2174	43.5	72	78	461.72	171.31
	T-RCSK-7242-R	2091	43.5	72	72	450.99	158.77
	T-RCSK-7248-R	2174	43.5	72	78	461.72	171.31

ordering options

- > laminate color
- > edge profile
- > grommet color
- > handle color (for pedestals)
- > handle style (for pedestals)

Each laminate comes with matching vinyl trim color unless otherwise specified on your purchase order. Refer to the laminate finish card for details.

details

- > Pedestals include lock and keys. Refer to page 8 for details.

executive | coffee and end tables

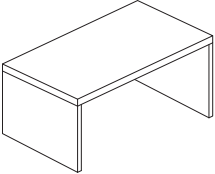
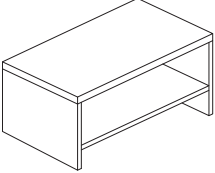
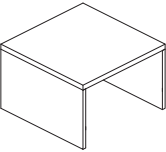
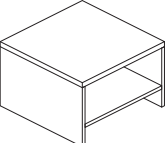
Description	Item Number	Price	Dimensions (inches)			Weight (lb.)	Cubic Feet
			H	W	D		
1.5" Coffee Table 	T-TCT0-362017	262	17.5	36	20	48.60	2.22
	T-TCT0-422017	280	17.5	42	20	53.93	2.56
	T-TCT0-482017	303	17.5	48	20	59.26	2.89
1.5" Coffee Table w/Fixed Shelf 	T-TCTS-362017	321	17.5	36	20	66.30	2.78
	T-TCTS-422017	339	17.5	42	20	74.25	3.19
	T-TCTS-482017	363	17.5	48	20	82.20	3.61
1.5" End Table 	T-TCT0-202019	244	19.5	20	20	35.70	1.33
	T-TCT0-242419	275	19.5	24	24	47.03	1.81
	T-TCT0-303019	339	19.5	30	30	58.36	2.68
1.5" End Table w/Fixed Shelf 	T-TCTS-202019	303	19.5	20	20	51.36	1.67
	T-TCTS-242419	334	19.5	24	24	62.87	2.27
	T-TCTS-303019	399	19.5	30	30	78.65	3.34

ordering options

- > laminate color
- > edge profile

Each laminate comes with matching vinyl trim color unless otherwise specified on your purchase order. Refer to the laminate finish card for details.

details

professional

straight desks	76
arc desks	92
tables	95
5-sided corners	98
unitized desks	99
bridges	100
returns	104
straight transition worksurfaces	116
credenzas	117
intermediate gable supports	120
pedestals	121
filing and storage	122
hutches	129
o-tabletops and bases	131
reception units	132
coffee and end tables	133

professional | straight desks

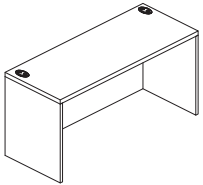
Description	Item Number	Price	Dimensions (inches)			Weight (lb.)	Cubic Feet
			H	W	D		
1" Straight Desk w/Full Modesty 	TL-TS0G-6021	489	29.0	60	21	107.70	4.63
	TL-TS0G-6621	515	29.0	66	21	117.12	5.06
	TL-TS0G-7221	536	29.0	72	21	126.54	5.50
	TL-TS0G-7821	562	29.0	78	21	135.96	5.93
	TL-TS0G-8421	593	29.0	84	21	145.38	6.37
	TL-TS0G-3024	391	29.0	30	24	77.17	2.75
	TL-TS0G-3624	417	29.0	36	24	96.29	3.24
	TL-TS0G-4224	431	29.0	42	24	115.41	3.73
	TL-TS0G-4824	457	29.0	48	24	134.53	4.21
	TL-TS0G-5424	483	29.0	54	24	153.65	4.70
	TL-TS0G-6024	510	29.0	60	24	172.77	5.19
	TL-TS0G-6624	536	29.0	66	24	191.89	5.67
	TL-TS0G-7224	557	29.0	72	24	211.01	6.16
	TL-TS0G-7824	583	29.0	78	24	230.13	6.64
	TL-TS0G-8424	614	29.0	84	24	249.25	7.13
	TL-TS0G-3030	411	29.0	30	30	84.20	3.34
	TL-TS0G-3630	443	29.0	36	30	95.73	3.94
	TL-TS0G-4230	469	29.0	42	30	107.26	4.53
	TL-TS0G-4830	499	29.0	48	30	118.79	5.12
	TL-TS0G-5430	535	29.0	54	30	130.32	5.71
	TL-TS0G-6030	562	29.0	60	30	141.85	6.30
	TL-TS0G-6630	583	29.0	66	30	153.38	6.89
	TL-TS0G-7230	608	29.0	72	30	164.91	7.48
	TL-TS0G-7830	644	29.0	78	30	176.44	8.07
	TL-TS0G-8430	678	29.0	84	30	187.97	8.66

ordering options

- > laminate color
- > grommet color

Each laminate comes with matching vinyl trim color unless otherwise specified on your purchase order. Refer to the laminate finish card for details.

details

- > Refer to page 12 for grommet placement.

professional | straight desks

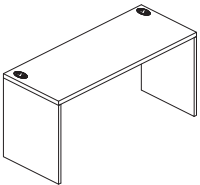
Description	Item Number	Price	Dimensions (inches)			Weight (lb.)	Cubic Feet
			H	W	D		
1" Straight Desk w/Partial Modesty 	TL-TS0Z-6021	489	29.0	60	21	81.41	4.63
	TL-TS0Z-6621	515	29.0	66	21	86.60	5.06
	TL-TS0Z-7221	536	29.0	72	21	91.79	5.50
	TL-TS0Z-7821	562	29.0	78	21	96.98	5.93
	TL-TS0Z-8421	593	29.0	84	21	102.17	6.37
	TL-TS0Z-3024	391	29.0	30	24	61.95	2.75
	TL-TS0Z-3624	417	29.0	36	24	67.50	3.24
	TL-TS0Z-4224	431	29.0	42	24	73.05	3.73
	TL-TS0Z-4824	457	29.0	48	24	78.60	4.21
	TL-TS0Z-5424	483	29.0	54	24	84.15	4.70
	TL-TS0Z-6024	510	29.0	60	24	89.70	5.19
	TL-TS0Z-6624	536	29.0	66	24	95.25	5.67
	TL-TS0Z-7224	557	29.0	72	24	100.80	6.16
	TL-TS0Z-7824	583	29.0	78	24	106.35	6.64
	TL-TS0Z-8424	614	29.0	84	24	111.90	7.13
	TL-TS0Z-3030	411	29.0	30	30	63.48	3.34
	TL-TS0Z-3630	443	29.0	36	30	69.97	3.94
	TL-TS0Z-4230	469	29.0	42	30	76.46	4.53
	TL-TS0Z-4830	499	29.0	48	30	82.95	5.12
	TL-TS0Z-5430	535	29.0	54	30	89.44	5.71
	TL-TS0Z-6030	562	29.0	60	30	95.93	6.30
	TL-TS0Z-6630	583	29.0	66	30	102.42	6.89
	TL-TS0Z-7230	608	29.0	72	30	108.91	7.48
	TL-TS0Z-7830	644	29.0	78	30	115.40	8.07
	TL-TS0Z-8430	678	29.0	84	30	121.89	8.66

straight desks

ordering options

- > laminate color
- > grommet color

Each laminate comes with matching vinyl trim color unless otherwise specified on your purchase order. Refer to the laminate finish card for details.

details

- > Partial modesties are 12"H.
- > Refer to page 12 for grommet placement.

professional | straight desks

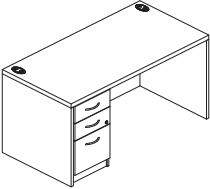
Description	Item Number	Price	Dimensions (inches)			Weight (lb.)	Cubic Feet
			H	W	D		
1" Straight Desk w/Full Modesty, Box/Box/File on Left-Hand Side 	TL-TSBX-6021	833	29.0	60	21	147.06	30.56
	TL-TSBX-6621	854	29.0	66	21	154.84	33.42
	TL-TSBX-72895	29.0	72	21	162.62	36.28	
	TL-TSBX-8981	925	29.0	84	21	178.18	42.01
	TL-TSBX-6024	895	29.0	60	24	156.15	34.22
	TL-TSBX-6624	908	29.0	66	24	164.40	37.43
	TL-TSBX-7224	935	29.0	72	24	172.65	40.64
	TL-TSBX-8424	1023	29.0	84	24	189.15	47.06
	TL-TSBX-6030	946	29.0	60	30	174.34	41.56
	TL-TSBX-6630	991	29.0	66	30	183.27	45.45
	TL-TSBX-7230	1022	29.0	72	30	192.20	49.35
	TL-TSBX-8430	1083	29.0	84	30	210.06	57.14
	TL-TSBX-7236	1067	29.0	72	36	212.17	58.06
	TL-TSBX-8436	1134	29.0	84	36	232.17	67.22

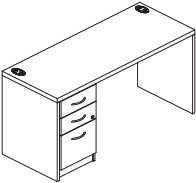
1" Straight Desk w/Partial Modesty, Box/Box/File on Left-Hand Side 	TL-TSBX-6021-P	833	29.0	60	21	122.16	30.56
	TL-TSBX-6621-P	854	29.0	66	21	129.94	33.42
	TL-TSBX-7221-P	895	29.0	72	21	137.72	36.28
	TL-TSBX-8421-P	981	29.0	84	21	153.28	42.01
	TL-TSBX-6024-P	895	29.0	60	24	131.25	34.22
	TL-TSBX-6624-P	908	29.0	66	24	139.50	37.43
	TL-TSBX-7224-P	935	29.0	72	24	147.75	40.64
	TL-TSBX-8424-P	1023	29.0	84	24	164.25	47.06

ordering options

- > laminate color
- > grommet color
- > handle color
- > handle style

Each laminate comes with matching vinyl trim color unless otherwise specified on your purchase order. Refer to the laminate finish card for details.

details

- > Partial modesties are 12"H.
- > 21"D desks do not include grommets. Refer to page 12 for details.
- > Pedestals include lock and keys. Refer to page 8 for details.

professional | straight desks

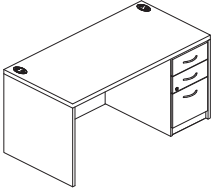
Description	Item Number	Price	Dimensions (inches)			Weight (lb.)	Cubic Feet
			H	W	D		
1" Straight Desk w/Full Modesty, Box/Box/File on Right-Hand Side 	TL-TSXB-6021	833	29.0	60	21	147.06	30.56
	TL-TSXB-6621	854	29.0	66	21	154.84	33.42
	TL-TSXB-7221	895	29.0	72	21	162.62	36.28
	TL-TSXB-8421	981	29.0	84	21	178.18	42.01
	TL-TSXB-6024	895	29.0	60	24	156.15	34.22
	TL-TSXB-6624	908	29.0	66	24	164.40	37.43
	TL-TSXB-7224	935	29.0	72	24	172.65	40.64
	TL-TSXB-8424	1023	29.0	84	24	189.15	47.06
	TL-TSXB-6030	946	29.0	60	30	174.34	41.56
	TL-TSXB-6630	991	29.0	66	30	183.27	45.45
	TL-TSXB-7230	1022	29.0	72	30	192.20	49.35
	TL-TSXB-8430	1083	29.0	84	30	210.06	57.14
	TL-TSXB-7236	1067	29.0	72	36	212.17	58.06
	TL-TSXB-8436	1134	29.0	84	36	232.17	67.22

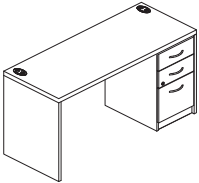
1" Straight Desk w/Partial Modesty, Box/Box/File on Right-Hand Side 	TL-TSXB-6021-P	833	29.0	60	21	122.16	30.56
	TL-TSXB-6621-P	854	29.0	66	21	129.94	33.42
	TL-TSXB-7221-P	895	29.0	72	21	137.72	36.28
	TL-TSXB-8421-P	981	29.0	84	21	153.28	42.01
	TL-TSXB-6024-P	895	29.0	60	24	131.25	34.22
	TL-TSXB-6624-P	908	29.0	66	24	139.50	37.43
	TL-TSXB-7224-P	935	29.0	72	24	147.75	40.64
	TL-TSXB-8424-P	1023	29.0	84	24	164.25	47.06

ordering options

- > laminate color
- > grommet color
- > handle color
- > handle style

Each laminate comes with matching vinyl trim color unless otherwise specified on your purchase order. Refer to the laminate finish card for details.

details

- > Partial modesties are 12"H.
- > 21"D desks do not include grommets. Refer to page 12 for details.
- > Pedestals include lock and keys. Refer to page 8 for details.

professional | straight desks

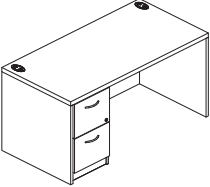
Description	Item Number	Price	Dimensions (inches)			Weight (lb.)	Cubic Feet
			H	W	D		
1" Straight Desk w/Full Modesty, File/File on Left-Hand Side 	TL-TSFX-6021	833	29.0	60	21	147.06	30.56
	TL-TSFX-6621	854	29.0	66	21	154.84	33.42
	TL-TSFX-7221	895	29.0	72	21	162.62	36.28
	TL-TSFX-8421	981	29.0	84	21	178.18	42.01
	TL-TSFX-6024	895	29.0	60	24	156.15	34.22
	TL-TSFX-6624	908	29.0	66	24	164.40	37.43
	TL-TSFX-7224	935	29.0	72	24	172.65	40.64
	TL-TSFX-8424	1023	29.0	84	24	189.15	47.06
	TL-TSFX-6030	946	29.0	60	30	174.34	41.56
	TL-TSFX-6630	991	29.0	66	30	183.27	45.45
	TL-TSFX-7230	1022	29.0	72	30	192.20	49.35
	TL-TSFX-8430	1083	29.0	84	30	210.06	57.14
	TL-TSFX-7236	1007	29.0	72	36	212.17	58.06
	TL-TSFX-8436	1070	29.0	84	36	232.17	67.22

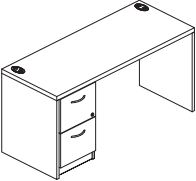
1" Straight Desk w/Partial Modesty, File/File on Left-Hand Side 	TL-TSFX-6021-P	833	29.0	60	21	122.16	30.56
	TL-TSFX-6621-P	854	29.0	66	21	129.94	33.42
	TL-TSFX-7221-P	895	29.0	72	21	137.72	36.28
	TL-TSFX-8421-P	981	29.0	84	21	153.28	42.01
	TL-TSFX-6024-P	895	29.0	60	24	131.25	34.22
	TL-TSFX-6624-P	908	29.0	66	24	139.50	37.43
	TL-TSFX-7224-P	935	29.0	72	24	147.75	40.64
	TL-TSFX-8424-P	1023	29.0	84	24	164.25	47.06

ordering options

- > laminate color
- > grommet color
- > handle color
- > handle style

Each laminate comes with matching vinyl trim color unless otherwise specified on your purchase order. Refer to the laminate finish card for details.

details

- > Partial modesties are 12"H.
- > 21"D desks do not include grommets. Refer to page 12 for details.
- > Pedestals include lock and keys. Refer to page 8 for details.

professional | straight desks

straight desks

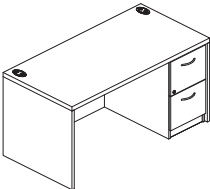
Description	Item Number	Price	Dimensions (inches)			Weight (lb.)	Cubic Feet
			H	W	D		
1" Straight Desk w/Full Modesty, File/File on Right-Hand Side 	TL-TSXF-6021	833	29.0	60	21	147.06	30.56
	TL-TSXF-6621	854	29.0	66	21	154.84	33.42
	TL-TSXF-7221	895	29.0	72	21	162.62	36.28
	TL-TSXF-8421	981	29.0	84	21	178.18	42.01
	TL-TSXF-6024	895	29.0	60	24	156.15	34.22
	TL-TSXF-6624	908	29.0	66	24	164.40	37.43
	TL-TSXF-7224	935	29.0	72	24	172.65	40.64
	TL-TSXF-8424	1023	29.0	84	24	189.15	47.06
	TL-TSXF-6030	946	29.0	60	30	174.34	41.56
	TL-TSXF-6630	991	29.0	66	30	183.27	45.45
	TL-TSXF-7230	1022	29.0	72	30	192.20	49.35
	TL-TSXF-8430	1083	29.0	84	30	210.06	57.14
	TL-TSXF-7236	1067	29.0	72	36	212.17	58.06
	TL-TSXF-8436	1134	29.0	84	36	232.17	67.22

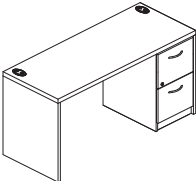
1" Straight Desk w/Partial Modesty, File/File on Right-Hand Side 	TL-TSXF-6021-P	833	29.0	60	21	122.16	30.56
	TL-TSXF-6621-P	854	29.0	66	21	129.94	33.42
	TL-TSXF-7221-P	895	29.0	72	21	137.72	36.28
	TL-TSXF-8421-P	981	29.0	84	21	153.28	42.01
	TL-TSXF-6024-P	895	29.0	60	24	131.25	34.22
	TL-TSXF-6624-P	908	29.0	66	24	139.50	37.43
	TL-TSXF-7224-P	935	29.0	72	24	147.75	40.64
	TL-TSXF-8424-P	1023	29.0	84	24	164.25	47.06

ordering options

- > laminate color
- > grommet color
- > handle color
- > handle style

Each laminate comes with matching vinyl trim color unless otherwise specified on your purchase order. Refer to the laminate finish card for details.

details

- > Partial modesties are 12"H.
- > 21"D desks do not include grommets. Refer to page 12 for details.
- > Pedestals include lock and keys. Refer to page 8 for details.

professional | straight desks

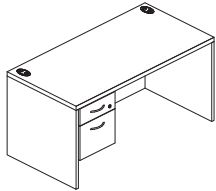
Description	Item Number	Price	Dimensions (inches)			Weight (lb.)	Cubic Feet
			H	W	D		
1" Straight Desk w/Full Modesty, Suspended Pedestal on Left-Hand Side 	TL-TSSX-6021	747	29.0	60	21	140.82	30.56
	TL-TSSX-6621	769	29.0	66	21	148.60	33.42
	TL-TSSX-7221	812	29.0	72	21	156.38	36.28
	TL-TSSX-8421	887	29.0	84	21	171.94	42.01
	TL-TSSX-6024	797	29.0	60	24	149.91	34.22
	TL-TSSX-6624	817	29.0	66	24	158.16	37.43
	TL-TSSX-7224	832	29.0	72	24	166.41	40.64
	TL-TSSX-8424	933	29.0	84	24	182.91	47.06
	TL-TSSX-6030	848	29.0	60	30	168.10	41.56
	TL-TSSX-6630	868	29.0	66	30	177.03	45.45
	TL-TSSX-7230	895	29.0	72	30	185.96	49.35
	TL-TSSX-8430	950	29.0	84	30	203.82	57.14
	TL-TSSX-7236	975	29.0	72	36	205.93	58.06
	TL-TSSX-8436	1032	29.0	84	36	225.93	67.22

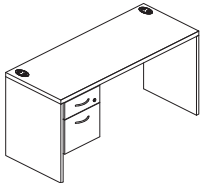
1" Straight Desk w/Partial Modesty, Suspended Pedestal on Left-Hand Side 	TL-TSSX-6021-P	747	29.0	60	21	115.92	30.56
	TL-TSSX-6621-P	769	29.0	66	21	123.70	33.42
	TL-TSSX-7221-P	812	29.0	72	21	131.48	36.28
	TL-TSSX-8421-P	887	29.0	84	21	147.04	42.01
	TL-TSSX-6024-P	797	29.0	60	24	125.01	34.22
	TL-TSSX-6624-P	817	29.0	66	24	133.26	37.43
	TL-TSSX-7224-P	832	29.0	72	24	141.51	40.64
	TL-TSSX-8424-P	933	29.0	84	24	158.01	47.06

ordering options

- > laminate color
- > grommet color
- > handle color
- > handle style

Each laminate comes with matching vinyl trim color unless otherwise specified on your purchase order. Refer to the laminate finish card for details.

details

- > Partial modesties are 12"H.
- > 21"D desks do not include grommets. Refer to page 12 for details.
- > Pedestals include lock and keys. Refer to page 8 for details.

professional | straight desks

straight desks

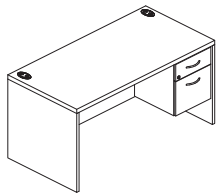
Description	Item Number	Price	Dimensions (inches)			Weight (lb.)	Cubic Feet
			H	W	D		
1" Straight Desk w/Full Modesty, Suspended Pedestal on Right-Hand Side 	TL-TSXS-6021	747	29.0	60	21	140.82	30.56
	TL-TSXS-6621	769	29.0	66	21	148.60	33.42
	TL-TSXS-7221	812	29.0	72	21	156.38	36.28
	TL-TSXS-8421	887	29.0	84	21	171.94	42.01
	TL-TSXS-6024	797	29.0	60	24	149.91	34.22
	TL-TSXS-6624	817	29.0	66	24	158.16	37.43
	TL-TSXS-7224	832	29.0	72	24	166.41	40.64
	TL-TSXS-8424	933	29.0	84	24	182.91	47.06
	TL-TSXS-6030	848	29.0	60	30	168.10	41.56
	TL-TSXS-6630	868	29.0	66	30	177.03	45.45
	TL-TSXS-7230	895	29.0	72	30	185.96	49.35
	TL-TSXS-8430	950	29.0	84	30	203.82	57.14
	TL-TSXS-7236	975	29.0	72	36	205.93	58.06
	TL-TSXS-8436	1032	29.0	84	36	225.93	67.22

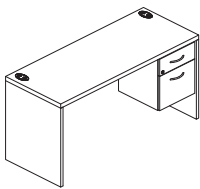
1" Straight Desk w/Partial Modesty, Suspended Pedestal on Right-Hand Side 	TL-TSXS-6021-P	747	29.0	60	21	115.92	30.56
	TL-TSXS-6621-P	769	29.0	66	21	123.70	33.42
	TL-TSXS-7221-P	812	29.0	72	21	131.48	36.28
	TL-TSXS-8421-P	887	29.0	84	21	147.04	42.01
	TL-TSXS-6024-P	797	29.0	60	24	125.01	34.22
	TL-TSXS-6624-P	817	29.0	66	24	133.26	37.43
	TL-TSXS-7224-P	832	29.0	72	24	141.51	40.64
	TL-TSXS-8424-P	933	29.0	84	24	158.01	47.06

ordering options

- > laminate color
- > grommet color
- > handle color
- > handle style

Each laminate comes with matching vinyl trim color unless otherwise specified on your purchase order. Refer to the laminate finish card for details.

details

- > Partial modesties are 12"H.
- > 21"D desks do not include grommets. Refer to page 12 for details.
- > Pedestals include lock and keys. Refer to page 8 for details.

professional | straight desks

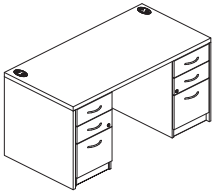
Description	Item Number	Price	Dimensions (inches)			Weight (lb.)	Cubic Feet
			H	W	D		
1" Straight Desk w/Full Modesty, Double Box/Box/File Pedestals 	TL-TSBB-6021	1134	29.0	60	21	188.86	30.56
	TL-TSBB-6621	1154	29.0	66	21	196.64	33.42
	TL-TSBB-7221	1174	29.0	72	21	204.42	36.28
	TL-TSBB-8421	1236	29.0	84	21	219.98	42.01
	TL-TSBB-6024	1149	29.0	60	24	197.15	34.22
	TL-TSBB-6624	1170	29.0	66	24	205.40	37.43
	TL-TSBB-7224	1190	29.0	72	24	213.65	40.64
	TL-TSBB-8424	1256	29.0	84	24	230.15	47.06
	TL-TSBB-6030	1236	29.0	60	30	216.14	41.56
	TL-TSBB-6630	1288	29.0	66	30	225.07	45.45
	TL-TSBB-7230	1323	29.0	72	30	234.00	49.35
	TL-TSBB-8430	1374	29.0	84	30	251.86	57.14
	TL-TSBB-7236	1368	29.0	72	36	253.97	58.06
	TL-TSBB-8436	1441	29.0	84	36	273.97	67.22

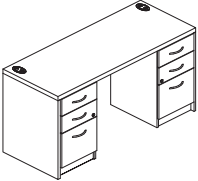
1" Straight Desk w/Partial Modesty, Double Box/Box/File Pedestals 	TL-TSBB-6021-P	1134	29.0	60	21	163.96	30.56
	TL-TSBB-6621-P	1154	29.0	66	21	171.74	33.42
	TL-TSBB-7221-P	1174	29.0	72	21	179.52	36.28
	TL-TSBB-8421-P	1236	29.0	84	21	195.08	42.01
	TL-TSBB-6024-P	1149	29.0	60	24	172.25	34.22
	TL-TSBB-6624-P	1170	29.0	66	24	180.50	37.43
	TL-TSBB-7224-P	1190	29.0	72	24	188.75	40.64
	TL-TSBB-8424-P	1256	29.0	84	24	205.25	47.06

ordering options

- > laminate color
- > grommet color
- > handle color
- > handle style

Each laminate comes with matching vinyl trim color unless otherwise specified on your purchase order. Refer to the laminate finish card for details.

details

- > Partial modesties are 12"H.
- > 21"D desks do not include grommets. Refer to page 12 for details.
- > Pedestals include lock and keys. Refer to page 8 for details.

professional | straight desks

straight desks

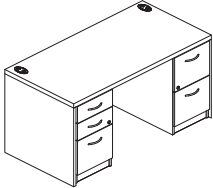
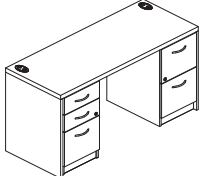
Description	Item Number	Price	Dimensions (inches)			Weight (lb.)	Cubic Feet
			H	W	D		
1" Straight Desk w/Full Modesty, Box/Box/File on Left-Hand Side, File/File on Right-Hand Side 	TL-TSBF-6021	1134	29.0	60	21	188.86	30.56
	TL-TSBF-6621	1154	29.0	66	21	196.64	33.42
	TL-TSBF-7221	1174	29.0	72	21	204.42	36.28
	TL-TSBF-8421	1236	29.0	84	21	219.98	42.01
	TL-TSBF-6024	1149	29.0	60	24	197.15	34.22
	TL-TSBF-6624	1170	29.0	66	24	205.40	37.43
	TL-TSBF-7224	1190	29.0	72	24	213.65	40.64
	TL-TSBF-8424	1256	29.0	84	24	230.15	47.06
	TL-TSBF-6030	1236	29.0	60	30	216.14	41.56
	TL-TSBF-6630	1288	29.0	66	30	225.07	45.45
	TL-TSBF-7230	1323	29.0	72	30	234.00	49.35
	TL-TSBF-8430	1374	29.0	84	30	251.86	57.14
	TL-TSBF-7236	1368	29.0	72	36	253.97	58.06
	TL-TSBF-8436	1441	29.0	84	36	273.97	67.22
1" Straight Desk w/Partial Modesty, Box/Box/File on Left-Hand Side, File/File on Right-Hand Side 	TL-TSBF-6021-P	1134	29.0	60	21	163.96	30.56
	TL-TSBF-6621-P	1154	29.0	66	21	171.74	33.42
	TL-TSBF-7221-P	1174	29.0	72	21	179.52	36.28
	TL-TSBF-8421-P	1236	29.0	84	21	195.08	42.01
	TL-TSBF-6024-P	1149	29.0	60	24	172.25	34.22
	TL-TSBF-6624-P	1170	29.0	66	24	180.50	37.43
	TL-TSBF-7224-P	1190	29.0	72	24	188.75	40.64
	TL-TSBF-8424-P	1256	29.0	84	24	205.25	47.06

ordering options

- > laminate color
- > grommet color
- > handle color
- > handle style

Each laminate comes with matching vinyl trim color unless otherwise specified on your purchase order. Refer to the laminate finish card for details.

details

- > Partial modesties are 12"H.
- > 21"D desks do not include grommets. Refer to page 12 for details.
- > Pedestals include lock and keys. Refer to page 8 for details.

professional | straight desks

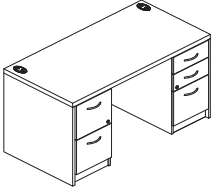
Description	Item Number	Price	Dimensions (inches)			Weight (lb.)	Cubic Feet
			H	W	D		
1" Straight Desk w/Full Modesty, File/File on Left-Hand Side, Box/Box/File on Right-Hand Side 	TL-TSFB-6021	1134	29.0	60	21	188.86	30.56
	TL-TSFB-6621	1154	29.0	66	21	196.64	33.42
	TL-TSFB-7221	1174	29.0	72	21	204.42	36.28
	TL-TSFB-8421	1236	29.0	84	21	219.98	42.01
	TL-TSFB-6024	1149	29.0	60	24	197.15	34.22
	TL-TSFB-6624	1170	29.0	66	24	205.40	37.43
	TL-TSFB-7224	1190	29.0	72	24	213.65	40.64
	TL-TSFB-8424	1256	29.0	84	24	230.15	47.06
	TL-TSFB-6030	1236	29.0	60	30	216.14	41.56
	TL-TSFB-6630	1288	29.0	66	30	225.07	45.45
	TL-TSFB-7230	1323	29.0	72	30	234.00	49.35
	TL-TSFB-8430	1374	29.0	84	30	251.86	57.14
	TL-TSFB-7236	1291	29.0	72	36	253.97	58.06
	TL-TSFB-8436	1441	29.0	84	36	273.97	67.22

1" Straight Desk w/Partial Modesty, File/File on Left-Hand Side, Box/Box/File on Right-Hand Side 	TL-TSFB-6021-P	1134	29.0	60	21	163.96	30.56
	TL-TSFB-6621-P	1154	29.0	66	21	171.74	33.42
	TL-TSFB-7221-P	1174	29.0	72	21	179.52	36.28
	TL-TSFB-8421-P	1236	29.0	84	21	195.08	42.01
	TL-TSFB-6024-P	1149	29.0	60	24	172.25	34.22
	TL-TSFB-6624-P	1170	29.0	66	24	180.50	37.43
	TL-TSFB-7224-P	1190	29.0	72	24	188.75	40.64
	TL-TSFB-8424-P	1256	29.0	84	24	205.25	47.06

ordering options

- > laminate color
- > grommet color
- > handle color
- > handle style

Each laminate comes with matching vinyl trim color unless otherwise specified on your purchase order. Refer to the laminate finish card for details.

details

- > Partial modesties are 12"H.
- > 21"D desks do not include grommets. Refer to page 12 for details.
- > Pedestals include lock and keys. Refer to page 8 for details.

professional | straight desks

Description	Item Number	Price	Dimensions (inches)			Weight (lb.)	Cubic Feet
			H	W	D		
1" Straight Desk w/Full Modesty, Double File/File Pedestals	TL-TSFF-6021	1134	29.0	60	21	188.86	30.56
	TL-TSFF-6621	1154	29.0	66	21	196.64	33.42
	TL-TSFF-7221	1174	29.0	72	21	204.42	36.28
	TL-TSFF-8421	1236	29.0	84	21	219.98	42.01

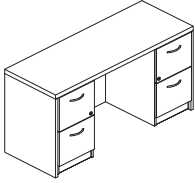

1" Straight Desk w/Partial Modesty, Double File/File Pedestals	TL-TSFF-6021-P	1134	29.0	60	21	163.96	30.56
	TL-TSFF-6621-P	1154	29.0	66	21	171.74	33.42
	TL-TSFF-7221-P	1174	29.0	72	21	179.52	36.28
	TL-TSFF-8421-P	1236	29.0	84	21	195.08	42.01

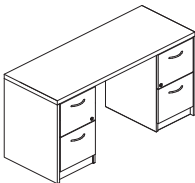

straight desks

ordering options

- > laminate color
- > handle color
- > handle style

Each laminate comes with matching vinyl trim color unless otherwise specified on your purchase order. Refer to the laminate finish card for details.

details

- > Partial modesties are 12"H.
- > 21"D desks do not include grommets. Refer to page 12 for details.
- > Pedestals include lock and keys. Refer to page 8 for details.

professional | straight desks

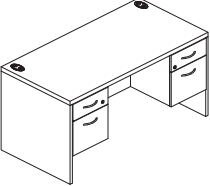
Description	Item Number	Price	Dimensions (inches)			Weight (lb.)	Cubic Feet
			H	W	D		
1" Straight Desk w/Full Modesty, Double Suspended Pedestals 	TL-TSSS-6021	970	29.0	60	21	224.42	30.56
	TL-TSSS-6621	991	29.0	66	21	232.20	33.42
	TL-TSSS-7221	1011	29.0	72	21	239.98	36.28
	TL-TSSS-8421	1067	29.0	84	21	255.54	42.01
	TL-TSSS-6024	975	29.0	60	24	232.17	34.22
	TL-TSSS-6624	1002	29.0	66	24	240.41	37.43
	TL-TSSS-7224	1022	29.0	72	24	248.65	40.64
	TL-TSSS-8424	1083	29.0	84	24	265.13	47.06
	TL-TSSS-6030	1062	29.0	60	30	251.70	41.56
	TL-TSSS-6630	1108	29.0	66	30	260.63	45.45
	TL-TSSS-7230	1154	29.0	72	30	269.56	49.35
	TL-TSSS-8430	1107	29.0	84	30	287.42	57.14
	TL-TSSS-7236	1205	29.0	72	36	289.53	58.06
	TL-TSSS-8436	1272	29.0	84	36	309.53	67.22

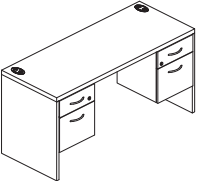
1" Straight Desk w/Partial Modesty, Double Suspended Pedestals 	TL-TSSS-6021-P	970	29.0	60	21	199.52	30.56
	TL-TSSS-6621-P	991	29.0	66	21	207.30	33.42
	TL-TSSS-7221-P	1011	29.0	72	21	215.08	36.28
	TL-TSSS-8421-P	1067	29.0	84	21	230.64	42.01
	TL-TSSS-6024-P	975	29.0	60	24	212.22	34.22
	TL-TSSS-6624-P	1002	29.0	66	24	220.46	37.43
	TL-TSSS-7224-P	1022	29.0	72	24	228.70	40.64
	TL-TSSS-8424-P	1083	29.0	84	24	245.18	47.06

ordering options

- > laminate color
- > grommet color
- > handle color
- > handle style

Each laminate comes with matching vinyl trim color unless otherwise specified on your purchase order. Refer to the laminate finish card for details.

details

- > Partial modesties are 12"H.
- > 21"D desks do not include grommets. Refer to page 12 for details.
- > Pedestals include lock and keys. Refer to page 8 for details.

professional | straight desks

straight desks

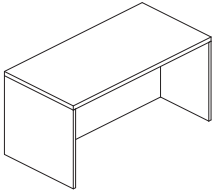
Description	Item Number	Price	Dimensions (inches)			Weight (lb.)	Cubic Feet
			H	W	D		
1" Straight Desk w/Recessed Full Modesty 	TL-TSR0-6030	562	29.0	60	30	137.93	6.30
	TL-TSR0-6630	583	29.0	66	30	149.46	6.89
	TL-TSR0-7230	608	29.0	72	30	160.99	7.48
	TL-TSR0-7830	644	29.0	78	30	172.52	8.07
	TL-TSR0-8430	676	29.0	84	30	184.05	8.66
	TL-TSR0-6036	640	29.0	60	36	150.30	7.41
	TL-TSR0-6636	666	29.0	66	36	160.20	8.10
	TL-TSR0-7236	692	29.0	72	36	170.10	8.80
	TL-TSR0-7836	723	29.0	78	36	180.00	9.49
	TL-TSR0-8436	748	29.0	84	36	189.90	10.19

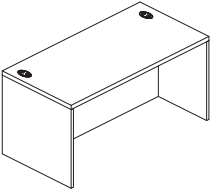
1" Straight Desk w/Recessed Full Modesty and Grommets 	TL-TSRG-6030	571	29.0	60	30	137.93	6.30
	TL-TSRG-6630	593	29.0	66	30	149.46	6.89
	TL-TSRG-7230	619	29.0	72	30	160.99	7.48
	TL-TSRG-7830	655	29.0	78	30	172.52	8.07
	TL-TSRG-8430	687	29.0	84	30	184.05	8.66
	TL-TSRG-6036	661	29.0	60	36	150.30	7.41
	TL-TSRG-6636	687	29.0	66	36	160.20	8.10
	TL-TSRG-7236	713	29.0	72	36	170.10	8.80
	TL-TSRG-7836	745	29.0	78	36	180.00	9.49
	TL-TSRG-8436	772	29.0	84	36	189.90	10.19

ordering options

- > laminate color
- > grommet color

Each laminate comes with matching vinyl trim color unless otherwise specified on your purchase order. Refer to the laminate finish card for details.

details

- > Recessed modesty:

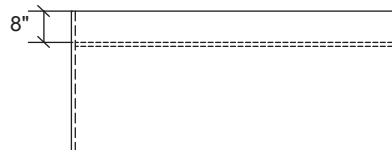

professional | straight desks

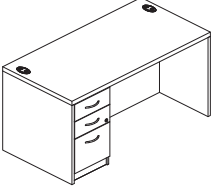
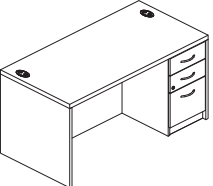
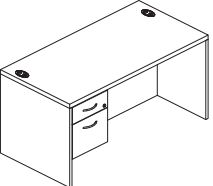
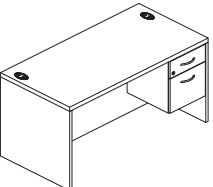
Description	Item Number	Price	Dimensions (inches)			Weight (lb.)	Cubic Feet
			H	W	D		
1" Straight Desk w/Recessed Full Modesty, Box/Box/File on Left-Hand Side 	TL-TRBX-6030	955	29.0	60	30	174.34	41.56
	TL-TRBX-6630	1002	29.0	66	30	183.29	45.45
	TL-TRBX-7230	1032	29.0	72	30	192.24	49.35
	TL-TRBX-8430	1093	29.0	84	30	210.14	57.14
	TL-TRBX-7236	1077	29.0	72	36	212.17	58.06
	TL-TRBX-8436	1144	29.0	84	36	232.17	67.22
1" Straight Desk w/Full Recessed Modesty, Box/Box/File on Right-Hand Side 	TL-TRXB-6030	955	29.0	60	30	174.34	41.56
	TL-TRXB-6630	1002	29.0	66	30	183.29	45.45
	TL-TRXB-7230	1032	29.0	72	30	192.24	49.35
	TL-TRXB-8430	1093	29.0	84	30	210.14	57.14
	TL-TRXB-7236	1077	29.0	72	36	212.17	58.06
	TL-TRXB-8436	1144	29.0	84	36	232.17	67.22
1" Straight Desk w/Recessed Full Modesty, Suspended Pedestal on Left-Hand Side 	TL-TRSX-6030	879	29.0	60	30	168.03	41.56
	TL-TRSX-6630	919	29.0	66	30	176.96	45.45
	TL-TRSX-7230	955	29.0	72	30	188.89	49.35
	TL-TRSX-8430	1032	29.0	84	30	212.75	57.14
	TL-TRSX-7236	996	29.0	72	36	205.86	58.06
	TL-TRSX-8436	1062	29.0	84	36	225.86	67.22
1" Straight Desk w/Recessed Full Modesty, Suspended Pedestal on Right-Hand Side 	TL-TRXS-6030	879	29.0	60	30	168.03	41.56
	TL-TRXS-6630	919	29.0	66	30	176.96	45.45
	TL-TRXS-7230	955	29.0	72	30	188.89	49.35
	TL-TRXS-8430	1032	29.0	84	30	212.75	57.14
	TL-TRXS-7236	996	29.0	72	36	205.86	58.06
	TL-TRXS-8436	1062	29.0	84	36	225.86	67.22

ordering options

- > laminate color
- > grommet color
- > handle color
- > handle style

Each laminate comes with matching vinyl trim color unless otherwise specified on your purchase order. Refer to the laminate finish card for details.

details

- > Pedestals include lock and keys. Refer to page 8 for details.
- > Recessed modesty:

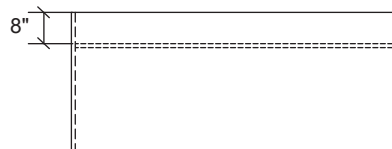

professional | straight desks

straight desks

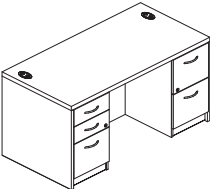
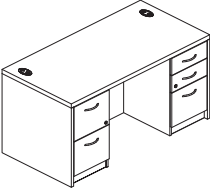
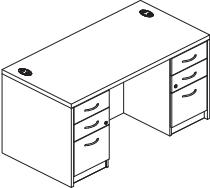
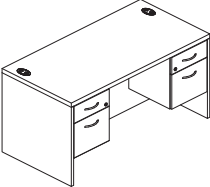
Description	Item Number	Price	Dimensions (inches)			Weight (lb.)	Cubic Feet	
			H	W	D			
1" Straight Desk w/Recessed Full Modesty, Box/Box/File on Left-Hand Side, File/File on Right-Hand Side 	TL-TRBF-6030	1246	29.0	60	30	216.21	41.56	
	TL-TRBF-6630	1297	29.0	66	30	225.14	45.45	
	TL-TRBF-7230	1332	29.0	72	30	234.07	49.35	
	TL-TRBF-8430	1383	29.0	84	30	251.93	57.14	
	TL-TRBF-7236	1379	29.0	72	36	254.04	58.06	
	TL-TRBF-8436	1450	29.0	84	36	274.04	67.22	
	1" Straight Desk w/Recessed Full Modesty, File/File on Left-Hand Side, Box/Box/File on Right-Hand Side 	TL-TRFB-6030	1246	29.0	60	30	216.21	41.56
		TL-TRFB-6630	1297	29.0	66	30	225.14	45.45
		TL-TRFB-7230	1332	29.0	72	30	234.07	49.35
		TL-TRFB-8430	1383	29.0	84	30	251.93	57.14
TL-TRFB-7236		1379	29.0	72	36	254.04	58.06	
TL-TRFB-8436		1450	29.0	84	36	274.04	67.22	
1" Straight Desk w/Recessed Full Modesty, Double Box/Box/File Pedestals 		TL-TRBB-6030	1246	29.0	60	30	216.21	41.56
		TL-TRBB-6630	1297	29.0	66	30	225.14	45.45
		TL-TRBB-7230	1332	29.0	72	30	234.07	49.35
		TL-TRBB-8430	1383	29.0	84	30	251.93	57.14
	TL-TRBB-7236	1379	29.0	72	36	254.04	58.06	
	TL-TRBB-8436	1450	29.0	84	36	274.04	67.22	
	1" Straight Desk w/Recessed Full Modesty, Double Suspended Pedestals 	TL-TRSS-6030	1073	29.0	60	30	203.59	41.56
		TL-TRSS-6630	1118	29.0	66	30	212.54	45.45
		TL-TRSS-7230	1164	29.0	72	30	221.49	49.35
		TL-TRSS-8430	1246	29.0	84	30	239.39	57.14
TL-TRSS-7236		1215	29.0	72	36	241.42	58.06	
TL-TRSS-8436		1282	29.0	84	36	261.42	67.22	

ordering options

- > laminate color
- > grommet color
- > handle color
- > handle style

Each laminate comes with matching vinyl trim color unless otherwise specified on your purchase order. Refer to the laminate finish card for details.

details

- > Pedestals include lock and keys. Refer to page 8 for details.
- > Recessed modesty:

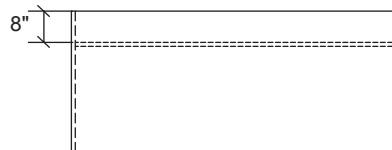

professional | arc desks

Description	Item Number	Price	Dimensions (inches)			Weight (lb.)	Cubic Feet
			H	W	D		
1" Arc Desk w/Recessed Full Modesty	TL-TARO-7236	817	29.0	72	36	178.09	8.80
	TL-TARO-7836	860	29.0	78	36	188.84	9.49
	TL-TARO-8436	902	29.0	84	36	199.59	10.19

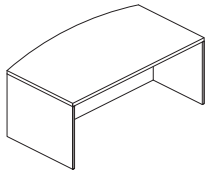

1" Arc Desk w/Recessed Full Modesty and Grommets

TL-TARG-7236	830	29.0	72	36	178.09	8.80
TL-TARG-7836	871	29.0	78	36	188.84	9.49
TL-TARG-8436	913	29.0	84	36	199.59	10.19

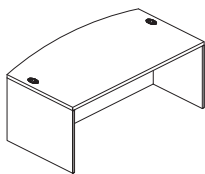

ordering options

- > laminate color
- > grommet color

Each laminate comes with matching vinyl trim color unless otherwise specified on your purchase order. Refer to the laminate finish card for details.

details

- > Recessed modesty:

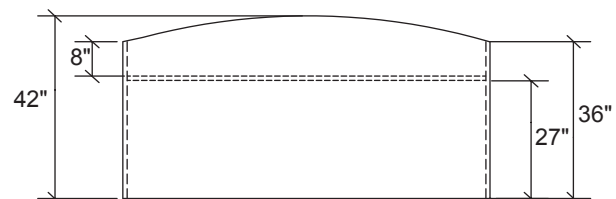

professional | arc desks

Description	Item Number	Price	Dimensions (inches)			Weight (lb.)	Cubic Feet
			H	W	D		
1" Arc Desk w/Recessed Full Modesty, Box/Box/File on Left-Hand Side	TL-TABX-7236	1184	29.0	72	36	221.12	58.06
	TL-TABX-8436	1264	29.0	84	36	244.22	67.22

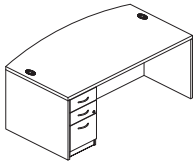

1" Arc Desk w/Recessed Full Modesty, Box/Box/File on Right-Hand Side	TL-TAXB-7236	1184	29.0	72	36	221.12	58.06
	TL-TAXB-8436	1264	29.0	84	36	244.22	67.22

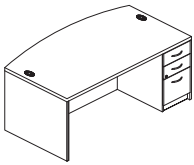

1" Arc Desk w/Recessed Full Modesty, Suspended Pedestal on Left-Hand Side	TL-TASX-7236	1094	29.0	72	36	211.71	58.06
	TL-TASX-8436	1172	29.0	84	36	231.71	67.22

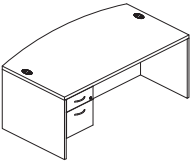

1" Arc Desk w/Recessed Full Modesty, Suspended Pedestal on Right-Hand Side	TL-TAXS-7236	1094	29.0	72	36	211.71	58.06
	TL-TAXS-8436	1172	29.0	84	36	231.71	67.22

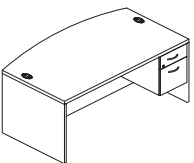

arc desks

ordering options

- > laminate color
- > grommet color
- > handle color
- > handle style

Each laminate comes with matching vinyl trim color unless otherwise specified on your purchase order. Refer to the laminate finish card for details.

details

- > Pedestals include lock and keys. Refer to page 8 for details.
- > Recessed modesty:

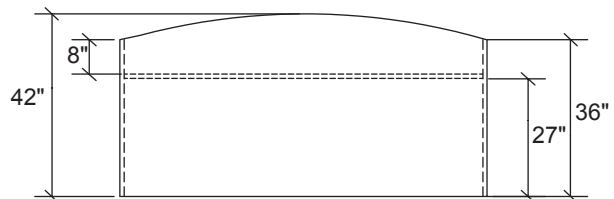

professional | arc desks

Description	Item Number	Price	Dimensions (inches)			Weight (lb.)	Cubic Feet
			H	W	D		
1" Arc Desk w/Recessed Full Modesty, Box/Box/File on Left-Hand Side, File/File on Right-Hand Side	TL-TABF-7236	1470	29.0	72	36	263.17	58.06
	TL-TABF-8436	1537	29.0	84	36	286.63	67.22

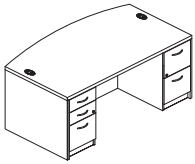

1" Arc Desk w/Recessed Full Modesty, File/File on Left-Hand Side, Box/Box/File on Right-Hand Side	TL-TAFB-7236	1470	29.0	72	36	263.17	58.06
	TL-TAFB-8436	1537	29.0	84	36	286.63	67.22

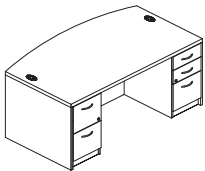

1" Arc Desk w/Recessed Full Modesty, Double Box/Box/File Pedestals	TL-TABB-7236	1470	29.0	72	36	263.17	58.06
	TL-TABB-8436	1537	29.0	84	36	286.63	67.22

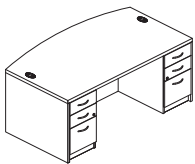

1" Arc Desk w/Recessed Full Modesty, Double Suspended Pedestals	TL-TASS-7236	1323	29.0	72	36	247.27	58.06
	TL-TASS-8436	1374	29.0	84	36	267.27	67.22

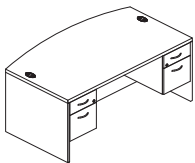

ordering options

- > laminate color
- > grommet color
- > handle color
- > handle style

Each laminate comes with matching vinyl trim color unless otherwise specified on your purchase order. Refer to the laminate finish card for details.

details

- > Pedestals include lock and keys. Refer to page 8 for details.
- > Recessed modesty:

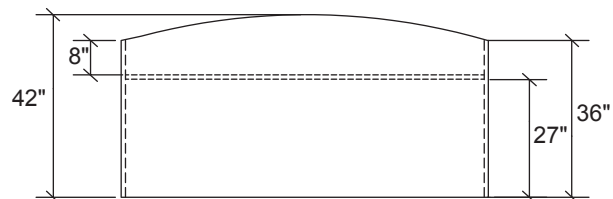

professional | tables

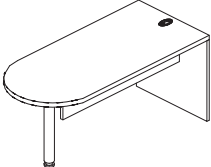
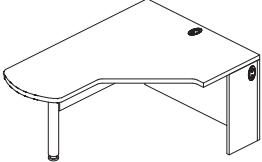
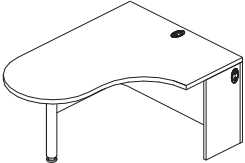
Description	Item Number	Price	Dimensions (inches)			Weight (lb.)	Cubic Feet
			H	W	D		
1" D-Table w/Full Gable 	TL-TD0G-6030	605	29.0	60	30	86.48	5.04
	TL-TD0G-6630	630	29.0	66	30	92.95	5.51
	TL-TD0G-7230	654	29.0	72	30	99.42	5.98
	TL-TD0G-7830	678	29.0	78	30	105.90	6.45
	TL-TD0G-8430	704	29.0	84	30	112.38	6.93
	TL-TD0G-6036	659	29.0	60	36	107.18	5.93
	TL-TD0G-6636	689	29.0	66	36	115.76	6.48
	TL-TD0G-7236	707	29.0	72	36	124.34	7.04
	TL-TD0G-7836	731	29.0	78	36	132.92	7.59
	TL-TD0G-8436	756	29.0	84	36	141.50	8.15
1" K-Table, LH Shown 	TL-TKSG-604824L	911	29.0	60	24	120.33	5.19
	TL-TKSG-664824L	977	29.0	66	24	125.88	5.67
	TL-TKSG-724824L	1030	29.0	72	24	131.43	6.16
	TL-TKSG-784824L	1083	29.0	78	24	136.98	6.64
	TL-TKSG-844824L	1136	29.0	84	24	142.53	7.13
	TL-TKSG-604824R	911	29.0	60	24	120.33	5.19
	TL-TKSG-664824R	977	29.0	66	24	125.88	5.67
	TL-TKSG-724824R	1030	29.0	72	24	131.43	6.16
	TL-TKSG-784824R	1083	29.0	78	24	136.98	6.64
	TL-TKSG-844824R	1136	29.0	84	24	142.53	7.13
1" J-Table, LH Shown 	TL-TJ0G-604824L	907	29.0	60	24	120.67	6.22
	TL-TJ0G-664824L	972	29.0	66	24	127.15	6.81
	TL-TJ0G-724824L	1026	29.0	72	24	133.63	7.39
	TL-TJ0G-784824L	1083	29.0	78	24	140.11	7.97
	TL-TJ0G-844824L	1136	29.0	84	24	146.59	8.56
	TL-TJ0G-604824R	907	29.0	60	24	120.67	6.22
	TL-TJ0G-664824R	972	29.0	66	24	127.15	6.81
	TL-TJ0G-724824R	1026	29.0	72	24	133.63	7.39
	TL-TJ0G-784824R	1083	29.0	78	24	140.11	7.97
	TL-TJ0G-844824R	1136	29.0	84	24	146.59	8.56

ordering options

- > laminate color
- > grommet color
- > metal color (for post support)

Each laminate comes with matching vinyl trim color unless otherwise specified on your purchase order. Refer to the laminate finish card for details.

details

- > 36"D D-tables include two post supports.

professional | tables

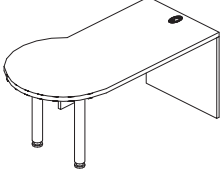
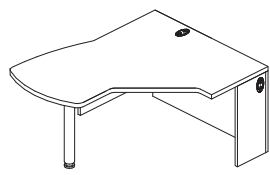
Description	Item Number	Price	Dimensions (inches)			Weight (lb.)	Cubic Feet
			H	W	D		
1" P-Table, LH Shown 	TL-TP0G-6030-L	830	29.0	60	30	96.51	7.56
	TL-TP0G-6630-L	871	29.0	66	30	103.34	8.26
	TL-TP0G-7230-L	902	29.0	72	30	110.17	8.97
	TL-TP0G-7830-L	941	29.0	78	30	117.00	9.68
	TL-TP0G-8430-L	977	29.0	84	30	123.83	10.39
	TL-TP0G-6030-R	830	29.0	60	30	96.51	7.56
	TL-TP0G-6630-R	871	29.0	66	30	103.34	8.26
	TL-TP0G-7230-R	902	29.0	72	30	110.17	8.97
	TL-TP0G-7830-R	941	29.0	78	30	117.00	9.68
	TL-TP0G-8430-R	977	29.0	84	30	123.83	10.39
1" F-Table, LH Shown 	TL-TFSG-604824L	1106	29.0	60	24	123.35	7.26
	TL-TFSG-664824L	1126	29.0	66	24	129.35	7.94
	TL-TFSG-724824L	1145	29.0	72	24	135.35	8.62
	TL-TFSG-784824L	1165	29.0	78	24	141.35	9.30
	TL-TFSG-844824L	1185	29.0	84	24	147.35	9.98
	TL-TFSG-604824R	1106	29.0	60	24	123.35	7.26
	TL-TFSG-664824R	1126	29.0	66	24	129.35	7.94
	TL-TFSG-724824R	1145	29.0	72	24	135.35	8.62
	TL-TFSG-784824R	1165	29.0	78	24	141.35	9.30
	TL-TFSG-844824R	1185	29.0	84	24	147.35	9.98



ordering options

- > laminate color
- > grommet color
- > metal color (for post support)

Each laminate comes with matching vinyl trim color unless otherwise specified on your purchase order. Refer to the laminate finish card for details.

details

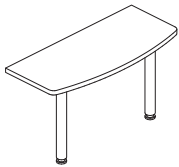
professional | tables

Description	Item Number	Price	Dimensions (inches)			Weight (lb.)	Cubic Feet
			H	W	D		
1" U-Table 	TL-WEU0-4224	471	29.0	42	24	38.79	2.98
	TL-WEU0-4824	490	29.0	48	24	42.36	3.37
	TL-WEU0-6024	590	29.0	60	24	45.92	4.15
1" C-Table 	TL-TC00-4221	366	29.0	42	21	25.00	2.00
	TL-TC00-4824	424	29.0	48	24	30.56	2.53
	TL-TC00-6030	482	29.0	60	30	36.12	3.78

tables

ordering options

- > laminate color
- > metal color (for post support)

Each laminate comes with matching vinyl trim color unless otherwise specified on your purchase order. Refer to the laminate finish card for details.

details

professional | 5-sided corners

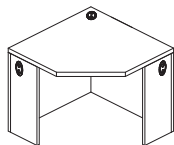
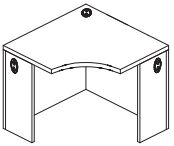
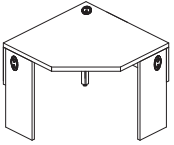
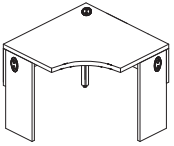
Description	Item Number	Price	Dimensions (inches)			Weight (lb.)	Cubic Feet
			H	W	D		
1" Straight Front Corner Worksurface w/Full Modesties 	TL-W5S0-3618	562	29.0	36	18	97.93	2.55
	TL-W5S0-3621	562	29.0	36	21	99.20	2.89
	TL-W5S0-3624	562	29.0	36	24	100.27	3.24
	TL-W5S0-4221	660	29.0	42	21	117.14	3.33
	TL-W5S0-4224	660	29.0	42	24	118.66	3.73
	TL-W5S0-4830	770	29.0	48	30	149.83	5.12
1" Curved Front Corner Worksurface w/Full Modesties 	TL-W5C0-3618	562	29.0	36	18	94.50	2.55
	TL-W5C0-3621	562	29.0	36	21	97.54	2.89
	TL-W5C0-3624	562	29.0	36	24	98.30	3.24
	TL-W5C0-4221	660	29.0	42	21	113.86	3.33
	TL-W5C0-4224	660	29.0	42	24	116.26	3.73
	TL-W5C0-4830	770	29.0	48	30	147.42	5.12
1" Straight Front Corner Worksurface w/Partial Modesties and Post 	TL-W5S0-3618-P	562	29.0	36	18	68.37	2.55
	TL-W5S0-3621-P	562	29.0	36	21	69.94	2.89
	TL-W5S0-3624-P	562	29.0	36	24	70.71	3.24
	TL-W5S0-4221-P	660	29.0	42	21	82.78	3.33
	TL-W5S0-4224-P	660	29.0	42	24	84.30	3.73
	TL-W5S0-4830-P	770	29.0	48	30	110.67	5.12
1" Curved Front Corner Worksurface w/Partial Modesties and Post 	TL-W5C0-3618-P	562	29.0	36	18	65.00	2.55
	TL-W5C0-3621-P	562	29.0	36	21	67.98	2.89
	TL-W5C0-3624-P	562	29.0	36	24	68.74	3.24
	TL-W5C0-4221-P	660	29.0	42	21	75.61	3.33
	TL-W5C0-4224-P	660	29.0	42	24	78.01	3.73
	TL-W5C0-4830-P	770	29.0	48	30	100.62	5.12

ordering options

- > laminate color
- > grommet color
- > metal color (for modesty post)

Each laminate comes with matching vinyl trim color unless otherwise specified on your purchase order. Refer to the laminate finish card for details.

details

- > Partial modesties are 12"H.

professional | unitized desks

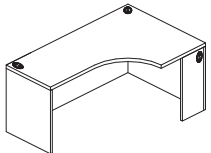
Description	Item Number	Price	Dimensions (inches)			Weight (lb.)	Cubic Feet
			H	W	D		
1" Curved Front Unitized Desk w/Full Modesties, Full and Partial Gables, LH Shown 	TL-UC4G-6639-L	865	29.0	66	39	120.60	10.45
	TL-UC4G-7239-L	921	29.0	72	39	153.90	11.35
	TL-UC4G-6639-R	865	29.0	66	39	120.60	10.45
	TL-UC4G-7239-R	921	29.0	72	39	153.90	11.35
	TL-UC4G-6642-L	899	29.0	66	42	161.10	11.18
	TL-UC4G-7242-L	1079	29.0	72	42	170.55	12.14
	TL-UC4G-6642-R	899	29.0	66	42	161.10	11.18
	TL-UC4G-7242-R	1079	29.0	72	42	170.55	12.14

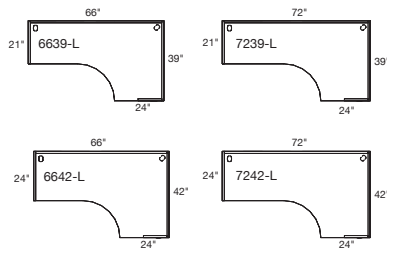

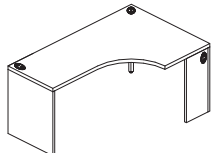
1" Curved Front Unitized Desk w/Partial Modesties, Full and Partial Gables, LH Shown 	TL-UC4Z-6639-L	865	29.0	66	39	99.79	10.45
	TL-UC4Z-7239-L	921	29.0	72	39	108.77	11.35
	TL-UC4Z-6639-R	865	29.0	66	39	99.79	10.45
	TL-UC4Z-7239-R	921	29.0	72	39	108.77	11.35
	TL-UC4Z-6642-L	899	29.0	66	42	114.66	11.18
	TL-UC4Z-7242-L	1079	29.0	72	42	126.11	12.14
	TL-UC4Z-6642-R	899	29.0	66	42	114.66	11.18
	TL-UC4Z-7242-R	1079	29.0	72	42	126.11	12.14

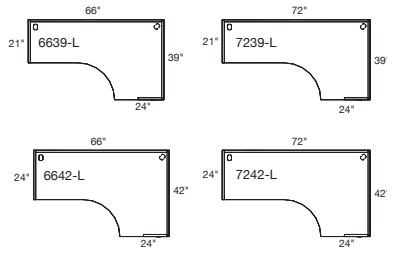

ordering options

- > laminate color
- > grommet color
- > metal color (for modesty post)

Each laminate comes with matching vinyl trim color unless otherwise specified on your purchase order. Refer to the laminate finish card for details.

details

- > Partial modesties are 12"H.

professional | bridges

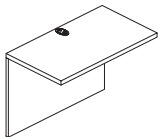
Description	Item Number	Price	Dimensions (inches)			Weight (lb.)	Cubic Feet
			H	W	D		
1" Straight Bridge w/Full Modesty 	TL-BS0G-3021	265	29.0	30	21	38.00	1.48
	TL-BS0G-3621	286	29.0	36	21	45.78	1.74
	TL-BS0G-4221	318	29.0	42	21	53.56	2.00
	TL-BS0G-4821	339	29.0	48	21	61.34	2.26
	TL-BS0G-3024	276	29.0	30	24	40.35	1.65
	TL-BS0G-3624	297	29.0	36	24	48.60	1.94
	TL-BS0G-4224	329	29.0	42	24	56.85	2.24
	TL-BS0G-4824	371	29.0	48	24	65.10	2.53
	TL-BS0G-3030	297	29.0	30	30	45.03	2.01
	TL-BS0G-3630	325	29.0	36	30	54.22	2.36
	TL-BS0G-4230	359	29.0	42	30	63.41	2.72
	TL-BS0G-4830	405	29.0	48	30	72.60	3.07

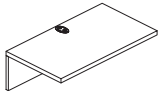
1" Straight Bridge w/Partial Modesty 	TL-BS0Z-3021	265	29.0	30	21	25.40	1.48
	TL-BS0Z-3621	286	29.0	36	21	33.18	1.74
	TL-BS0Z-4221	318	29.0	42	21	40.96	2.00
	TL-BS0Z-4821	339	29.0	48	21	48.74	2.26
	TL-BS0Z-3024	276	29.0	30	24	27.75	1.65
	TL-BS0Z-3624	297	29.0	36	24	36.00	1.94
	TL-BS0Z-4224	329	29.0	42	24	44.25	2.24
	TL-BS0Z-4824	371	29.0	48	24	52.50	2.53
	TL-BS0Z-3030	297	29.0	30	30	32.43	2.01
	TL-BS0Z-3630	325	29.0	36	30	41.62	2.36
	TL-BS0Z-4230	359	29.0	42	30	50.81	2.72
	TL-BS0Z-4830	405	29.0	48	30	60.00	3.07

ordering options

- > laminate color
- > grommet color

Each laminate comes with matching vinyl trim color unless otherwise specified on your purchase order. Refer to the laminate finish card for details.

details

- > Partial modesties are 12"H.

professional | bridges

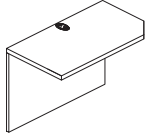
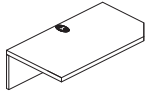
Description	Item Number	Price	Dimensions (inches)			Weight (lb.)	Cubic Feet	
			H	W	D			
1" Notched Bridge w/Full Modesty, LH Shown 	TL-BN0G-3624-L	325	29.0	36	24	48.13	1.94	
	TL-BN0G-4224-L	359	29.0	42	24	56.38	2.24	
	TL-BN0G-4824-L	405	29.0	48	24	64.63	2.53	
	TL-BN0G-3624-R	325	29.0	36	24	48.13	1.94	
	TL-BN0G-4224-R	359	29.0	42	24	56.38	2.24	
	TL-BN0G-4824-R	405	29.0	48	24	64.63	2.53	
	TL-BN0G-3630-L	337	29.0	36	30	58.25	2.36	
	TL-BN0G-4230-L	371	29.0	42	30	66.48	2.72	
	TL-BN0G-4830-L	416	29.0	48	30	74.71	3.07	
	TL-BN0G-3630-R	337	29.0	36	30	58.25	2.36	
	TL-BN0G-4230-R	371	29.0	42	30	66.48	2.72	
	TL-BN0G-4830-R	416	29.0	48	30	74.71	3.07	
	1" Notched Bridge w/Partial Modesty, LH Shown 	TL-BN0Z-3624-L	325	29.0	36	24	32.85	1.94
		TL-BN0Z-4224-L	359	29.0	42	24	41.10	2.24
		TL-BN0Z-4824-L	405	29.0	48	24	49.35	2.53
TL-BN0Z-3624-R		325	29.0	36	24	32.85	1.94	
TL-BN0Z-4224-R		359	29.0	42	24	41.10	2.24	
TL-BN0Z-4824-R		405	29.0	48	24	49.35	2.53	
TL-BN0Z-3630-L		337	29.0	36	30	38.90	2.36	
TL-BN0Z-4230-L		371	29.0	42	30	47.13	2.72	
TL-BN0Z-4830-L		416	29.0	48	30	55.36	3.07	
TL-BN0Z-3630-R		337	29.0	36	30	38.90	2.36	
TL-BN0Z-4230-R		371	29.0	42	30	47.13	2.72	
TL-BN0Z-4830-R		416	29.0	48	30	55.36	3.07	

ordering options

- > laminate color
- > grommet color

Each laminate comes with matching vinyl trim color unless otherwise specified on your purchase order. Refer to the laminate finish card for details.

details

- > Partial modesties are 12"H.

professional | bridges

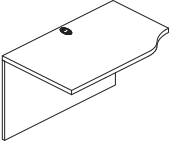
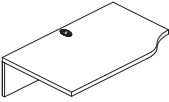
Description	Item Number	Price	Dimensions (inches)			Weight (lb.)	Cubic Feet	
			H	W	D			
1" Bowed Bridge w/Full Modesty, LH Shown 	TL-BB0G-3624-L	325	29.0	36	24	47.39	1.94	
	TL-BB0G-4224-L	359	29.0	42	24	55.64	2.24	
	TL-BB0G-4824-L	405	29.0	48	24	63.89	2.53	
	TL-BB0G-3624-R	325	29.0	36	24	47.39	1.94	
	TL-BB0G-4224-R	359	29.0	42	24	55.64	2.24	
	TL-BB0G-4824-R	405	29.0	48	24	63.89	2.53	
	TL-BB0G-3630-L	337	29.0	36	30	53.00	2.36	
	TL-BB0G-4230-L	371	29.0	42	30	62.20	2.72	
	TL-BB0G-4830-L	416	29.0	48	30	71.40	3.07	
	TL-BB0G-3630-R	337	29.0	36	30	53.00	2.36	
	TL-BB0G-4230-R	371	29.0	42	30	62.20	2.72	
	TL-BB0G-4830-R	416	29.0	48	30	71.40	3.07	
	1" Bowed Bridge w/Partial Modesty, LH Shown 	TL-BB0Z-3624-L	325	29.0	36	24	30.29	1.94
		TL-BB0Z-4224-L	359	29.0	42	24	38.54	2.24
		TL-BB0Z-4824-L	405	29.0	48	24	46.79	2.53
TL-BB0Z-3624-R		337	29.0	36	24	30.29	1.94	
TL-BB0Z-4224-R		371	29.0	42	24	38.54	2.24	
TL-BB0Z-4824-R		416	29.0	48	24	46.79	2.53	
TL-BB0Z-3630-L		337	29.0	36	30	38.16	2.36	
TL-BB0Z-4230-L		371	29.0	42	30	47.36	2.72	
TL-BB0Z-4830-L		416	29.0	48	30	56.56	3.07	
TL-BB0Z-3630-R		337	29.0	36	30	38.16	2.36	
TL-BB0Z-4230-R		371	29.0	42	30	47.36	2.72	
TL-BB0Z-4830-R		416	29.0	48	30	56.56	3.07	

ordering options

- > laminate color
- > grommet color

Each laminate comes with matching vinyl trim color unless otherwise specified on your purchase order. Refer to the laminate finish card for details.

details

- > Partial modesties are 12"H.

professional | bridges

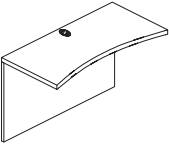
Description	Item Number	Price	Dimensions (inches)			Weight (lb.)	Cubic Feet
			H	W	D		
1" Concave Front Bridge w/Full Modesty 	TL-BC0G-3024	319	29.0	30	24	38.31	1.65
	TL-BC0G-3624	351	29.0	36	24	46.14	1.94
	TL-BC0G-4224	388	29.0	42	24	53.97	2.24
	TL-BC0G-4824	437	29.0	48	24	61.80	2.53
	TL-BC0G-3030	331	29.0	30	30	43.00	2.01
	TL-BC0G-3630	364	29.0	36	30	51.77	2.36
	TL-BC0G-4230	401	29.0	42	30	60.54	2.72
	TL-BC0G-4830	449	29.0	48	30	69.31	3.07

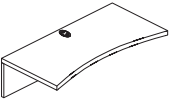
1" Concave Front Bridge w/Partial Modesty 	TL-BC0Z-3024	319	29.0	30	24	34.83	1.65
	TL-BC0Z-3624	351	29.0	36	24	42.66	1.94
	TL-BC0Z-4224	388	29.0	42	24	50.49	2.24
	TL-BC0Z-4824	437	29.0	48	24	58.32	2.53
	TL-BC0Z-3030	331	29.0	30	30	33.10	2.01
	TL-BC0Z-3630	364	29.0	36	30	41.87	2.36
	TL-BC0Z-4230	401	29.0	42	30	50.64	2.72
	TL-BC0Z-4830	449	29.0	48	30	59.41	3.07

ordering options

- > laminate color
- > grommet color

Each laminate comes with matching vinyl trim color unless otherwise specified on your purchase order. Refer to the laminate finish card for details.

details

- > Partial modesties are 12"H.

professional | returns

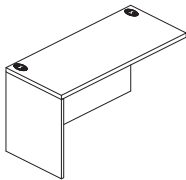
Description	Item Number	Price	Dimensions (inches)			Weight (lb.)	Cubic Feet
			H	W	D		
1" Straight Return w/Full Modesty, LH Shown 	TL-WS1G-3021-L	342	29.0	30	21	52.40	1.97
	TL-WS1G-3621-L	349	29.0	36	21	59.80	2.31
	TL-WS1G-4221-L	355	29.0	42	21	67.20	2.66
	TL-WS1G-4821-L	378	29.0	48	21	74.60	3.01
	TL-WS1G-5421-L	402	29.0	54	21	82.00	3.36
	TL-WS1G-6021-L	426	29.0	60	21	89.40	3.70
	TL-WS1G-3021-R	342	29.0	30	21	52.40	1.97
	TL-WS1G-3621-R	349	29.0	36	21	59.80	2.31
	TL-WS1G-4221-R	355	29.0	42	21	67.20	2.66
	TL-WS1G-4821-R	378	29.0	48	21	74.60	3.01
	TL-WS1G-5421-R	402	29.0	54	21	82.00	3.36
	TL-WS1G-6021-R	426	29.0	60	21	89.40	3.70
	TL-WS1G-3024-L	349	29.0	30	24	56.55	2.20
	TL-WS1G-3624-L	355	29.0	36	24	64.35	2.59
	TL-WS1G-4224-L	367	29.0	42	24	72.15	2.98
	TL-WS1G-4824-L	390	29.0	48	24	79.95	3.37
	TL-WS1G-5424-L	414	29.0	54	24	87.75	3.76
	TL-WS1G-6024-L	438	29.0	60	24	95.55	4.15
	TL-WS1G-3024-R	349	29.0	30	24	56.55	2.20
	TL-WS1G-3624-R	355	29.0	36	24	64.35	2.59
	TL-WS1G-4224-R	367	29.0	42	24	72.15	2.98
	TL-WS1G-4824-R	390	29.0	48	24	79.95	3.37
	TL-WS1G-5424-R	414	29.0	54	24	87.75	3.76
	TL-WS1G-6024-R	438	29.0	60	24	95.55	4.15
	TL-WS1G-3030-L	390	29.0	30	30	65.73	2.68
	TL-WS1G-3630-L	408	29.0	36	30	74.76	3.15
	TL-WS1G-4230-L	426	29.0	42	30	83.79	3.62
	TL-WS1G-4830-L	444	29.0	48	30	92.82	4.09
TL-WS1G-5430-L	462	29.0	54	30	101.85	4.56	
TL-WS1G-6030-L	492	29.0	60	30	110.88	5.04	
TL-WS1G-3030-R	390	29.0	30	30	65.73	2.68	
TL-WS1G-3630-R	408	29.0	36	30	74.76	3.15	
TL-WS1G-4230-R	426	29.0	42	30	83.79	3.62	
TL-WS1G-4830-R	444	29.0	48	30	92.82	4.09	
TL-WS1G-5430-R	462	29.0	54	30	101.85	4.56	
TL-WS1G-6030-R	492	29.0	60	30	110.88	5.04	

ordering options

- > laminate color
- > grommet color

Each laminate comes with matching vinyl trim color unless otherwise specified on your purchase order. Refer to the laminate finish card for details.

details

- > Refer to page 12 for grommet placement.

professional | returns

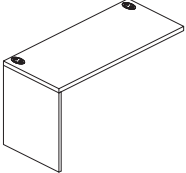
Description	Item Number	Price	Dimensions (inches)			Weight (lb.)	Cubic Feet
			H	W	D		
1" Straight Return w/Partial Modesty, LH Shown 	TL-WS1Z-3021-L	342	29.0	30	21	42.50	1.97
	TL-WS1Z-3621-L	349	29.0	36	21	49.90	2.31
	TL-WS1Z-4221-L	355	29.0	42	21	57.30	2.66
	TL-WS1Z-4821-L	378	29.0	48	21	64.70	3.01
	TL-WS1Z-5421-L	402	29.0	54	21	72.10	3.36
	TL-WS1Z-6021-L	426	29.0	60	21	79.50	3.70
	TL-WS1Z-3021-R	342	29.0	30	21	42.50	1.97
	TL-WS1Z-3621-R	349	29.0	36	21	49.90	2.31
	TL-WS1Z-4221-R	355	29.0	42	21	57.30	2.66
	TL-WS1Z-4821-R	378	29.0	48	21	64.70	3.01
	TL-WS1Z-5421-R	402	29.0	54	21	72.10	3.36
	TL-WS1Z-6021-R	426	29.0	60	21	79.50	3.70
	TL-WS1Z-3024-L	349	29.0	30	24	44.70	2.20
	TL-WS1Z-3624-L	355	29.0	36	24	52.50	2.59
	TL-WS1Z-4224-L	367	29.0	42	24	60.30	2.98
	TL-WS1Z-4824-L	390	29.0	48	24	68.10	3.37
	TL-WS1Z-5424-L	414	29.0	54	24	75.90	3.76
	TL-WS1Z-6024-L	438	29.0	60	24	83.70	4.15
	TL-WS1Z-3024-R	349	29.0	30	24	44.70	2.20
	TL-WS1Z-3624-R	355	29.0	36	24	52.50	2.59
	TL-WS1Z-4224-R	367	29.0	42	24	60.30	2.98
	TL-WS1Z-4824-R	390	29.0	48	24	68.10	3.37
	TL-WS1Z-5424-R	414	29.0	54	24	75.90	3.76
	TL-WS1Z-6024-R	438	29.0	60	24	83.70	4.15
	TL-WS1Z-3030-L	390	29.0	30	30	58.38	2.68
	TL-WS1Z-3630-L	408	29.0	36	30	67.41	3.15
	TL-WS1Z-4230-L	426	29.0	42	30	76.44	3.62
	TL-WS1Z-4830-L	444	29.0	48	30	85.47	4.09
TL-WS1Z-5430-L	462	29.0	54	30	94.50	4.56	
TL-WS1Z-6030-L	492	29.0	60	30	103.53	5.04	
TL-WS1Z-3030-R	390	29.0	30	30	58.38	2.68	
TL-WS1Z-3630-R	408	29.0	36	30	67.41	3.15	
TL-WS1Z-4230-R	426	29.0	42	30	76.44	3.62	
TL-WS1Z-4830-R	444	29.0	48	30	85.47	4.09	
TL-WS1Z-5430-R	462	29.0	54	30	94.50	4.56	
TL-WS1Z-6030-R	492	29.0	60	30	103.53	5.04	

ordering options

- > laminate color
- > grommet color

Each laminate comes with matching vinyl trim color unless otherwise specified on your purchase order. Refer to the laminate finish card for details.

details

- > Partial modesties are 12"H.
- > Refer to page 12 for grommet placement.

professional | returns

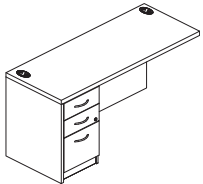
Description	Item Number	Price	Dimensions (inches)			Weight (lb.)	Cubic Feet
			H	W	D		
1" Straight Return w/Full Modesty, Box/Box/File, LH Shown 	TL-WRBX-3021-L	683	29.0	30	21	93.62	16.23
	TL-WRBX-3621-L	693	29.0	36	21	101.27	19.10
	TL-WRBX-4221-L	704	29.0	42	21	108.92	21.96
	TL-WRBX-4821-L	774	29.0	48	21	116.57	24.83
	TL-WRBX-5421-L	785	29.0	54	21	124.22	27.69
	TL-WRBX-6021-L	800	29.0	60	21	131.87	30.56
	TL-WRBX-3021-R	683	29.0	30	21	93.62	16.23
	TL-WRBX-3621-R	693	29.0	36	21	101.27	19.10
	TL-WRBX-4221-R	704	29.0	42	21	108.92	21.96
	TL-WRBX-4821-R	774	29.0	48	21	116.57	24.83
	TL-WRBX-5421-R	785	29.0	54	21	124.22	27.69
	TL-WRBX-6021-R	800	29.0	60	21	131.87	30.56
	TL-WRBX-3024-L	704	29.0	30	24	97.97	18.18
	TL-WRBX-3624-L	716	29.0	36	24	106.37	21.39
	TL-WRBX-4224-L	726	29.0	42	24	114.77	24.60
	TL-WRBX-4824-L	796	29.0	48	24	123.17	27.81
	TL-WRBX-5424-L	807	29.0	54	24	131.57	31.01
	TL-WRBX-6024-L	823	29.0	60	24	139.97	34.22
	TL-WRBX-3024-R	704	29.0	30	24	97.97	18.18
	TL-WRBX-3624-R	716	29.0	36	24	106.37	21.39
	TL-WRBX-4224-R	726	29.0	42	24	114.77	24.60
	TL-WRBX-4824-R	796	29.0	48	24	123.17	27.81
	TL-WRBX-5424-R	807	29.0	54	24	131.57	31.01
	TL-WRBX-6024-R	823	29.0	60	24	139.97	34.22
TL-WRBX-3030-L	726	29.0	30	30	107.15	22.08	
TL-WRBX-3630-L	737	29.0	36	30	116.33	25.97	
TL-WRBX-4230-L	747	29.0	42	30	125.51	29.87	
TL-WRBX-4830-L	817	29.0	48	30	134.69	33.76	
TL-WRBX-5430-L	829	29.0	54	30	143.87	37.66	
TL-WRBX-6030-L	845	29.0	60	30	153.05	41.56	
TL-WRBX-3030-R	726	29.0	30	30	107.15	22.08	
TL-WRBX-3630-R	737	29.0	36	30	116.33	25.97	
TL-WRBX-4230-R	747	29.0	42	30	125.51	29.87	
TL-WRBX-4830-R	817	29.0	48	30	134.69	33.76	
TL-WRBX-5430-R	829	29.0	54	30	143.87	37.66	
TL-WRBX-6030-R	845	29.0	60	30	153.05	41.56	

ordering options

- > laminate color
- > grommet color
- > handle color
- > handle style

Each laminate comes with matching vinyl trim color unless otherwise specified on your purchase order. Refer to the laminate finish card for details.

details

- > 21"D returns do not include grommets. Refer to page 12 for details.
- > Pedestals include lock and keys. Refer to page 8 for details.

professional | returns

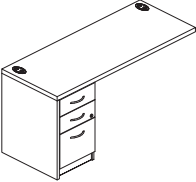
Description	Item Number	Price	Dimensions (inches)			Weight (lb.)	Cubic Feet
			H	W	D		
1" Straight Return w/Partial Modesty, Box/Box/File, LH Shown 	TL-WRBX-3021L-P	683	29.0	30	21	68.72	16.23
	TL-WRBX-3621L-P	693	29.0	36	21	76.37	19.10
	TL-WRBX-4221L-P	704	29.0	42	21	84.02	21.96
	TL-WRBX-4821L-P	774	29.0	48	21	91.67	24.83
	TL-WRBX-5421L-P	785	29.0	54	21	99.32	27.69
	TL-WRBX-6021L-P	800	29.0	60	21	106.97	30.56
	TL-WRBX-3021R-P	683	29.0	30	21	68.72	16.23
	TL-WRBX-3621R-P	693	29.0	36	21	76.37	19.10
	TL-WRBX-4221R-P	704	29.0	42	21	84.02	21.96
	TL-WRBX-4821R-P	774	29.0	48	21	91.67	24.83
	TL-WRBX-5421R-P	785	29.0	54	21	99.32	27.69
	TL-WRBX-6021R-P	800	29.0	60	21	106.97	30.56
	TL-WRBX-3024L-P	704	29.0	30	24	73.07	18.18
	TL-WRBX-3624L-P	716	29.0	36	24	81.47	21.39
	TL-WRBX-4224L-P	726	29.0	42	24	89.87	24.60
	TL-WRBX-4824L-P	796	29.0	48	24	98.27	27.81
	TL-WRBX-5424L-P	807	29.0	54	24	106.67	31.01
	TL-WRBX-6024L-P	823	29.0	60	24	115.07	34.22
	TL-WRBX-3024R-P	704	29.0	30	24	73.07	18.18
	TL-WRBX-3624R-P	716	29.0	36	24	81.47	21.39
	TL-WRBX-4224R-P	726	29.0	42	24	89.87	24.60
	TL-WRBX-4824R-P	796	29.0	48	24	98.27	27.81
	TL-WRBX-5424R-P	807	29.0	54	24	106.67	31.01
	TL-WRBX-6024R-P	823	29.0	60	24	115.07	34.22
TL-WRBX-3030L-P	726	29.0	30	30	82.25	22.08	
TL-WRBX-3630L-P	737	29.0	36	30	91.43	25.97	
TL-WRBX-4230L-P	747	29.0	42	30	100.61	29.87	
TL-WRBX-4830L-P	817	29.0	48	30	109.79	33.76	
TL-WRBX-5430L-P	829	29.0	54	30	118.97	37.66	
TL-WRBX-6030L-P	845	29.0	60	30	128.15	41.56	
TL-WRBX-3030R-P	726	29.0	30	30	82.25	22.08	
TL-WRBX-3630R-P	737	29.0	36	30	91.43	25.97	
TL-WRBX-4230R-P	747	29.0	42	30	100.61	29.87	
TL-WRBX-4830R-P	817	29.0	48	30	109.79	33.76	
TL-WRBX-5430R-P	829	29.0	54	30	118.97	37.66	
TL-WRBX-6030R-P	845	29.0	60	30	128.15	41.56	

ordering options

- > laminate color
- > grommet color
- > handle color
- > handle style

Each laminate comes with matching vinyl trim color unless otherwise specified on your purchase order. Refer to the laminate finish card for details.

details

- > Partial modesties are 12"H.
- > 21"D returns do not include grommets. Refer to page 12 for details.
- > Pedestals include lock and keys. Refer to page 8 for details.

professional | returns

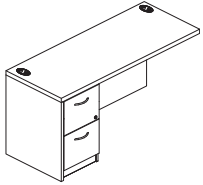
Description	Item Number	Price	Dimensions (inches)			Weight (lb.)	Cubic Feet
			H	W	D		
1" Straight Return w/Full Modesty, File/File, LH Shown 	TL-WRFX-3021-L	683	29.0	30	21	93.62	16.23
	TL-WRFX-3621-L	693	29.0	36	21	101.27	19.10
	TL-WRFX-4221-L	704	29.0	42	21	108.92	21.96
	TL-WRFX-4821-L	774	29.0	48	21	116.57	24.83
	TL-WRFX-5421-L	785	29.0	54	21	124.22	27.69
	TL-WRFX-6021-L	800	29.0	60	21	131.87	30.56
	TL-WRFX-3021-R	683	29.0	30	21	93.62	16.23
	TL-WRFX-3621-R	693	29.0	36	21	101.27	19.10
	TL-WRFX-4221-R	704	29.0	42	21	108.92	21.96
	TL-WRFX-4821-R	774	29.0	48	21	116.57	24.83
	TL-WRFX-5421-R	785	29.0	54	21	124.22	27.69
	TL-WRFX-6021-R	800	29.0	60	21	131.87	30.56
	TL-WRFX-3024-L	704	29.0	30	24	97.97	18.18
	TL-WRFX-3624-L	716	29.0	36	24	106.37	21.39
	TL-WRFX-4224-L	726	29.0	42	24	114.77	24.60
	TL-WRFX-4824-L	796	29.0	48	24	123.17	27.81
	TL-WRFX-5424-L	807	29.0	54	24	131.57	31.01
	TL-WRFX-6024-L	823	29.0	60	24	139.97	34.22
	TL-WRFX-3024-R	704	29.0	30	24	97.97	18.18
	TL-WRFX-3624-R	716	29.0	36	24	106.37	21.39
	TL-WRFX-4224-R	726	29.0	42	24	114.77	24.60
	TL-WRFX-4824-R	796	29.0	48	24	123.17	27.81
	TL-WRFX-5424-R	807	29.0	54	24	131.57	31.01
	TL-WRFX-6024-R	823	29.0	60	24	139.97	34.22
	TL-WRFX-3030-L	726	29.0	30	30	107.15	22.08
	TL-WRFX-3630-L	737	29.0	36	30	116.33	25.97
	TL-WRFX-4230-L	747	29.0	42	30	125.51	29.87
	TL-WRFX-4830-L	817	29.0	48	30	134.69	33.76
TL-WRFX-5430-L	829	29.0	54	30	143.87	37.66	
TL-WRFX-6030-L	845	29.0	60	30	153.05	41.56	
TL-WRFX-3030-R	726	29.0	30	30	107.15	22.08	
TL-WRFX-3630-R	737	29.0	36	30	116.33	25.97	
TL-WRFX-4230-R	747	29.0	42	30	125.51	29.87	
TL-WRFX-4830-R	817	29.0	48	30	134.69	33.76	
TL-WRFX-5430-R	829	29.0	54	30	143.87	37.66	
TL-WRFX-6030-R	845	29.0	60	30	153.05	41.56	

ordering options

- > laminate color
- > grommet color
- > handle color
- > handle style

Each laminate comes with matching vinyl trim color unless otherwise specified on your purchase order. Refer to the laminate finish card for details.

details

- > 21"D returns do not include grommets. Refer to page 12 for details.
- > Pedestals include lock and keys. Refer to page 8 for details.

professional | returns

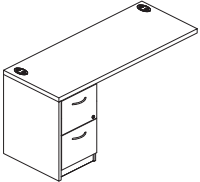
Description	Item Number	Price	Dimensions (inches)			Weight (lb.)	Cubic Feet
			H	W	D		
1" Straight Return w/Partial Modesty, File/File, LH Shown 	TL-WRFX-3021L-P	683	29.0	30	21	68.72	16.23
	TL-WRFX-3621L-P	693	29.0	36	21	76.37	19.10
	TL-WRFX-4221L-P	704	29.0	42	21	84.02	21.96
	TL-WRFX-4821L-P	774	29.0	48	21	91.67	24.83
	TL-WRFX-5421L-P	785	29.0	54	21	99.32	27.69
	TL-WRFX-6021L-P	800	29.0	60	21	106.97	30.56
	TL-WRFX-3021R-P	683	29.0	30	21	68.72	16.23
	TL-WRFX-3621R-P	693	29.0	36	21	76.37	19.10
	TL-WRFX-4221R-P	704	29.0	42	21	84.02	21.96
	TL-WRFX-4821R-P	774	29.0	48	21	91.67	24.83
	TL-WRFX-5421R-P	785	29.0	54	21	99.32	27.69
	TL-WRFX-6021R-P	800	29.0	60	21	106.97	30.56
	TL-WRFX-3024L-P	704	29.0	30	24	73.07	18.18
	TL-WRFX-3624L-P	716	29.0	36	24	81.47	21.39
	TL-WRFX-4224L-P	726	29.0	42	24	89.87	24.60
	TL-WRFX-4824L-P	796	29.0	48	24	98.27	27.81
	TL-WRFX-5424L-P	807	29.0	54	24	106.67	31.01
	TL-WRFX-6024L-P	823	29.0	60	24	115.07	34.22
	TL-WRFX-3024R-P	704	29.0	30	24	73.07	18.18
	TL-WRFX-3624R-P	716	29.0	36	24	81.47	21.39
	TL-WRFX-4224R-P	726	29.0	42	24	89.87	24.60
	TL-WRFX-4824R-P	796	29.0	48	24	98.27	27.81
	TL-WRFX-5424R-P	807	29.0	54	24	106.67	31.01
	TL-WRFX-6024R-P	823	29.0	60	24	115.07	34.22
	TL-WRFX-3030L-P	726	29.0	30	30	82.25	22.08
	TL-WRFX-3630L-P	737	29.0	36	30	91.43	25.97
	TL-WRFX-4230L-P	747	29.0	42	30	100.61	29.87
	TL-WRFX-4830L-P	817	29.0	48	30	109.79	33.76
	TL-WRFX-5430L-P	829	29.0	54	30	118.97	37.66
	TL-WRFX-6030L-P	845	29.0	60	30	128.15	41.56
TL-WRFX-3030R-P	726	29.0	30	30	82.25	22.08	
TL-WRFX-3630R-P	737	29.0	36	30	91.43	25.97	
TL-WRFX-4230R-P	747	29.0	42	30	100.61	29.87	
TL-WRFX-4830R-P	817	29.0	48	30	109.79	33.76	
TL-WRFX-5430R-P	829	29.0	54	30	118.97	37.66	
TL-WRFX-6030R-P	845	29.0	60	30	128.15	41.56	

ordering options

- > laminate color
- > grommet color
- > handle color
- > handle style

Each laminate comes with matching vinyl trim color unless otherwise specified on your purchase order. Refer to the laminate finish card for details.

details

- > Partial modesties are 12"H.
- > 21"D returns do not include grommets. Refer to page 12 for details.
- > Pedestals include lock and keys. Refer to page 8 for details.

professional | returns

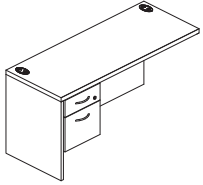
Description	Item Number	Price	Dimensions (inches)			Weight (lb.)	Cubic Feet
			H	W	D		
1" Straight Return w/Full Modesty, Suspended Pedestal, LH Shown 	TL-WRSX-3021-L	579	29.0	30	21	87.31	16.23
	TL-WRSX-3621-L	602	29.0	36	21	94.96	19.10
	TL-WRSX-4221-L	633	29.0	42	21	102.61	21.96
	TL-WRSX-4821-L	703	29.0	48	21	110.26	24.83
	TL-WRSX-5421-L	757	29.0	54	21	117.91	27.69
	TL-WRSX-6021-L	787	29.0	60	21	125.56	30.56
	TL-WRSX-3021-R	579	29.0	30	21	87.31	16.23
	TL-WRSX-3621-R	602	29.0	36	21	94.96	19.10
	TL-WRSX-4221-R	633	29.0	42	21	102.61	21.96
	TL-WRSX-4821-R	703	29.0	48	21	110.26	24.83
	TL-WRSX-5421-R	757	29.0	54	21	117.91	27.69
	TL-WRSX-6021-R	787	29.0	60	21	125.56	30.56
	TL-WRSX-3024-L	620	29.0	30	24	91.66	18.18
	TL-WRSX-3624-L	661	29.0	36	24	100.06	21.39
	TL-WRSX-4224-L	672	29.0	42	24	108.46	24.60
	TL-WRSX-4824-L	708	29.0	48	24	116.86	27.81
	TL-WRSX-5424-L	787	29.0	54	24	125.26	31.01
	TL-WRSX-6024-L	816	29.0	60	24	133.66	34.22
	TL-WRSX-3024-R	620	29.0	30	24	91.66	18.18
	TL-WRSX-3624-R	661	29.0	36	24	100.06	21.39
	TL-WRSX-4224-R	672	29.0	42	24	108.46	24.60
	TL-WRSX-4824-R	708	29.0	48	24	116.86	27.81
	TL-WRSX-5424-R	787	29.0	54	24	125.26	31.01
	TL-WRSX-6024-R	816	29.0	60	24	133.66	34.22
TL-WRSX-3030-L	631	29.0	30	30	100.84	22.08	
TL-WRSX-3630-L	667	29.0	36	30	110.02	25.97	
TL-WRSX-4230-L	685	29.0	42	30	119.20	29.87	
TL-WRSX-4830-L	757	29.0	48	30	128.38	33.76	
TL-WRSX-5430-L	810	29.0	54	30	137.56	37.66	
TL-WRSX-6030-L	840	29.0	60	30	146.74	41.56	
TL-WRSX-3030-R	631	29.0	30	30	100.84	22.08	
TL-WRSX-3630-R	667	29.0	36	30	110.02	25.97	
TL-WRSX-4230-R	685	29.0	42	30	119.20	29.87	
TL-WRSX-4830-R	757	29.0	48	30	128.38	33.76	
TL-WRSX-5430-R	810	29.0	54	30	137.56	37.66	
TL-WRSX-6030-R	840	29.0	60	30	146.74	41.56	

ordering options

- > laminate color
- > grommet color
- > handle color
- > handle style

Each laminate comes with matching vinyl trim color unless otherwise specified on your purchase order. Refer to the laminate finish card for details.

details

- > 21"D returns do not include grommets. Refer to page 12 for details.
- > Pedestals include lock and keys. Refer to page 8 for details.

professional | returns

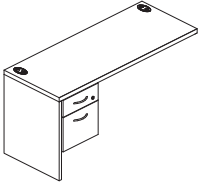
Description	Item Number	Price	Dimensions (inches)			Weight (lb.)	Cubic Feet
			H	W	D		
1" Straight Return w/Partial Modesty, Suspended Pedestal, LH Shown 	TL-WRSX-3021L-P	579	29.0	30	21	77.71	16.23
	TL-WRSX-3621L-P	602	29.0	36	21	85.36	19.10
	TL-WRSX-4221L-P	633	29.0	42	21	93.01	21.96
	TL-WRSX-4821L-P	703	29.0	48	21	100.66	24.83
	TL-WRSX-5421L-P	757	29.0	54	21	108.31	27.69
	TL-WRSX-6021L-P	787	29.0	60	21	115.96	30.56
	TL-WRSX-3021R-P	579	29.0	30	21	77.71	16.23
	TL-WRSX-3621R-P	602	29.0	36	21	85.36	19.10
	TL-WRSX-4221R-P	633	29.0	42	21	93.01	21.96
	TL-WRSX-4821R-P	703	29.0	48	21	100.66	24.83
	TL-WRSX-5421R-P	757	29.0	54	21	108.31	27.69
	TL-WRSX-6021R-P	787	29.0	60	21	115.96	30.56
	TL-WRSX-3024L-P	620	29.0	30	24	82.06	18.18
	TL-WRSX-3624L-P	661	29.0	36	24	90.46	21.39
	TL-WRSX-4224L-P	672	29.0	42	24	98.86	24.60
	TL-WRSX-4824L-P	708	29.0	48	24	107.26	27.81
	TL-WRSX-5424L-P	787	29.0	54	24	115.66	31.01
	TL-WRSX-6024L-P	816	29.0	60	24	124.06	34.22
	TL-WRSX-3024R-P	620	29.0	30	24	82.06	18.18
	TL-WRSX-3624R-P	661	29.0	36	24	90.46	21.39
	TL-WRSX-4224R-P	672	29.0	42	24	98.86	24.60
	TL-WRSX-4824R-P	708	29.0	48	24	107.26	27.81
	TL-WRSX-5424R-P	787	29.0	54	24	115.66	31.01
	TL-WRSX-6024R-P	816	29.0	60	24	124.06	34.22
TL-WRSX-3030L-P	631	29.0	30	30	91.24	22.08	
TL-WRSX-3630L-P	667	29.0	36	30	100.42	25.97	
TL-WRSX-4230L-P	685	29.0	42	30	109.60	29.87	
TL-WRSX-4830L-P	757	29.0	48	30	118.78	33.76	
TL-WRSX-5430L-P	810	29.0	54	30	127.96	37.66	
TL-WRSX-6030L-P	840	29.0	60	30	137.14	41.56	
TL-WRSX-3030R-P	631	29.0	30	30	91.24	22.08	
TL-WRSX-3630R-P	667	29.0	36	30	100.42	25.97	
TL-WRSX-4230R-P	685	29.0	42	30	109.60	29.87	
TL-WRSX-4830R-P	757	29.0	48	30	118.78	33.76	
TL-WRSX-5430R-P	810	29.0	54	30	127.96	37.66	
TL-WRSX-6030R-P	840	29.0	60	30	137.14	41.56	

ordering options

- > laminate color
- > grommet color
- > handle color
- > handle style

Each laminate comes with matching vinyl trim color unless otherwise specified on your purchase order. Refer to the laminate finish card for details.

details

- > Partial modesties are 12"H.
- > 21"D returns do not include grommets. Refer to page 12 for details.
- > Pedestals include lock and keys. Refer to page 8 for details.

professional | returns

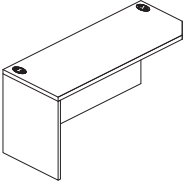
Description	Item Number	Price	Dimensions (inches)			Weight (lb.)	Cubic Feet
			H	W	D		
1" Notched Return w/Full Modesty, LH Shown 	TL-WNOG-3024-L	422	29.0	30	24	56.08	2.20
	TL-WNOG-3624-L	444	29.0	36	24	63.88	2.59
	TL-WNOG-4224-L	466	29.0	42	24	71.68	2.98
	TL-WNOG-4824-L	489	29.0	48	24	79.48	3.37
	TL-WNOG-5424-L	506	29.0	54	24	87.28	3.76
	TL-WNOG-6024-L	517	29.0	60	24	95.08	4.15
	TL-WNOG-3024-R	422	29.0	30	24	56.08	2.20
	TL-WNOG-3624-R	444	29.0	36	24	63.88	2.59
	TL-WNOG-4224-R	466	29.0	42	24	71.68	2.98
	TL-WNOG-4824-R	489	29.0	48	24	79.48	3.37
	TL-WNOG-5424-R	506	29.0	54	24	87.28	3.76
	TL-WNOG-6024-R	517	29.0	60	24	95.08	4.15
	TL-WNOG-3030-L	494	29.0	30	30	63.88	2.68
	TL-WNOG-3630-L	528	29.0	36	30	71.68	3.15
	TL-WNOG-4230-L	550	29.0	42	30	79.48	3.62
	TL-WNOG-4830-L	584	29.0	48	30	87.28	4.09
	TL-WNOG-5430-L	606	29.0	54	30	95.08	4.56
	TL-WNOG-6030-L	623	29.0	60	30	102.88	5.04
	TL-WNOG-3030-R	494	29.0	30	30	63.88	2.68
	TL-WNOG-3630-R	528	29.0	36	30	71.68	3.15
	TL-WNOG-4230-R	550	29.0	42	30	79.48	3.62
	TL-WNOG-4830-R	584	29.0	48	30	87.28	4.09
	TL-WNOG-5430-R	606	29.0	54	30	95.08	4.56
	TL-WNOG-6030-R	623	29.0	60	30	102.88	5.04

ordering options

- > laminate color
- > grommet color

Each laminate comes with matching vinyl trim color unless otherwise specified on your purchase order. Refer to the laminate finish card for details.

details

- > Refer to page 12 for grommet placement.

professional | returns

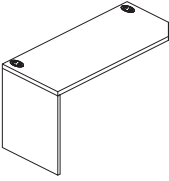
Description	Item Number	Price	Dimensions (inches)			Weight (lb.)	Cubic Feet
			H	W	D		
1" Notched Return w/Partial Modesty, LH Shown 	TL-WNOZ-3024-L	422	29.0	30	24	46.05	2.20
	TL-WNOZ-3624-L	444	29.0	36	24	53.85	2.59
	TL-WNOZ-4224-L	466	29.0	42	24	61.65	2.98
	TL-WNOZ-4824-L	489	29.0	48	24	69.45	3.37
	TL-WNOZ-5424-L	506	29.0	54	24	77.25	3.76
	TL-WNOZ-6024-L	517	29.0	60	24	85.05	4.15
	TL-WNOZ-3024-R	422	29.0	30	24	46.05	2.20
	TL-WNOZ-3624-R	444	29.0	36	24	53.85	2.59
	TL-WNOZ-4224-R	466	29.0	42	24	61.65	2.98
	TL-WNOZ-4824-R	489	29.0	48	24	69.45	3.37
	TL-WNOZ-5424-R	506	29.0	54	24	77.25	3.76
	TL-WNOZ-6024-R	517	29.0	60	24	85.05	4.15
	TL-WNOZ-3030-L	494	29.0	30	30	59.61	2.68
	TL-WNOZ-3630-L	528	29.0	36	30	67.41	3.15
	TL-WNOZ-4230-L	550	29.0	42	30	75.21	3.62
	TL-WNOZ-4830-L	584	29.0	48	30	83.01	4.09
	TL-WNOZ-5430-L	606	29.0	54	30	90.81	4.56
	TL-WNOZ-6030-L	623	29.0	60	30	98.61	5.04
	TL-WNOZ-3030-R	494	29.0	30	30	59.61	2.68
	TL-WNOZ-3630-R	528	29.0	36	30	67.41	3.15
	TL-WNOZ-4230-R	550	29.0	42	30	75.21	3.62
	TL-WNOZ-4830-R	584	29.0	48	30	83.01	4.09
	TL-WNOZ-5430-R	606	29.0	54	30	90.81	4.56
	TL-WNOZ-6030-R	623	29.0	60	30	98.61	5.04

ordering options

- > laminate color
- > grommet color

Each laminate comes with matching vinyl trim color unless otherwise specified on your purchase order. Refer to the laminate finish card for details.

details

- > Partial modesties are 12"H.
- > Refer to page 12 for grommet placement.

professional | returns

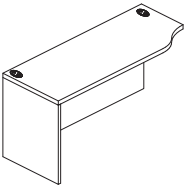
Description	Item Number	Price	Dimensions (inches)			Weight (lb.)	Cubic Feet
			H	W	D		
1" Bowed Return w/Full Modesty, LH Shown 	TL-WB0G-3024-L	422	29.0	30	24	55.34	2.20
	TL-WB0G-3624-L	444	29.0	36	24	63.14	2.59
	TL-WB0G-4224-L	466	29.0	42	24	70.94	2.98
	TL-WB0G-4824-L	489	29.0	48	24	78.74	3.37
	TL-WB0G-5424-L	506	29.0	54	24	86.54	3.76
	TL-WB0G-6024-L	517	29.0	60	24	94.34	4.15
	TL-WB0G-3024-R	422	29.0	30	24	55.34	2.20
	TL-WB0G-3624-R	444	29.0	36	24	63.14	2.59
	TL-WB0G-4224-R	466	29.0	42	24	70.94	2.98
	TL-WB0G-4824-R	489	29.0	48	24	78.74	3.37
	TL-WB0G-5424-R	506	29.0	54	24	86.54	3.76
	TL-WB0G-6024-R	517	29.0	60	24	94.34	4.15
	TL-WB0G-3030-L	494	29.0	30	30	64.09	2.68
	TL-WB0G-3630-L	528	29.0	36	30	72.39	3.15
	TL-WB0G-4230-L	550	29.0	42	30	80.69	3.62
	TL-WB0G-4830-L	584	29.0	48	30	88.99	4.09
	TL-WB0G-5430-L	606	29.0	54	30	97.29	4.56
	TL-WB0G-6030-L	623	29.0	60	30	105.59	5.04
	TL-WB0G-3030-R	494	29.0	30	30	64.09	2.68
	TL-WB0G-3630-R	528	29.0	36	30	72.39	3.15
	TL-WB0G-4230-R	550	29.0	42	30	80.69	3.62
	TL-WB0G-4830-R	584	29.0	48	30	88.99	4.09
	TL-WB0G-5430-R	606	29.0	54	30	97.29	4.56
	TL-WB0G-6030-R	623	29.0	60	30	105.59	5.04

ordering options

- > laminate color
- > grommet color

Each laminate comes with matching vinyl trim color unless otherwise specified on your purchase order. Refer to the laminate finish card for details.

details

- > Refer to page 12 for grommet placement.

professional | returns

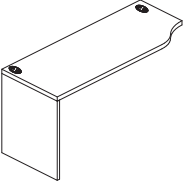
Description	Item Number	Price	Dimensions (inches)			Weight (lb.)	Cubic Feet
			H	W	D		
1" Bowed Return w/Partial Modesty, LH Shown 	TL-WBOZ-3024-L	422	29.0	30	24	45.44	2.20
	TL-WBOZ-3624-L	444	29.0	36	24	53.24	2.59
	TL-WBOZ-4224-L	466	29.0	42	24	61.04	2.98
	TL-WBOZ-4824-L	489	29.0	48	24	68.84	3.37
	TL-WBOZ-5424-L	506	29.0	54	24	76.64	3.76
	TL-WBOZ-6024-L	517	29.0	60	24	84.44	4.15
	TL-WBOZ-3024-R	422	29.0	30	24	45.44	2.20
	TL-WBOZ-3624-R	444	29.0	36	24	53.24	2.59
	TL-WBOZ-4224-R	466	29.0	42	24	61.04	2.98
	TL-WBOZ-4824-R	489	29.0	48	24	68.84	3.37
	TL-WBOZ-5424-R	506	29.0	54	24	76.64	3.76
	TL-WBOZ-6024-R	517	29.0	60	24	84.44	4.15
	TL-WBOZ-3030-L	494	29.0	30	30	54.05	2.68
	TL-WBOZ-3630-L	528	29.0	36	30	62.35	3.15
	TL-WBOZ-4230-L	550	29.0	42	30	70.65	3.62
	TL-WBOZ-4830-L	584	29.0	48	30	78.95	4.09
	TL-WBOZ-5430-L	606	29.0	54	30	87.25	4.56
	TL-WBOZ-6030-L	623	29.0	60	30	95.55	5.04
	TL-WBOZ-3030-R	494	29.0	30	30	54.05	2.68
	TL-WBOZ-3630-R	528	29.0	36	30	62.35	3.15
	TL-WBOZ-4230-R	550	29.0	42	30	70.65	3.62
	TL-WBOZ-4830-R	584	29.0	48	30	78.95	4.09
	TL-WBOZ-5430-R	606	29.0	54	30	87.25	4.56
	TL-WBOZ-6030-R	623	29.0	60	30	95.55	5.04

ordering options

- > laminate color
- > grommet color

Each laminate comes with matching vinyl trim color unless otherwise specified on your purchase order. Refer to the laminate finish card for details.

details

- > Partial modesties are 12"H.
- > Refer to page 12 for grommet placement.

professional | straight transition worksurface

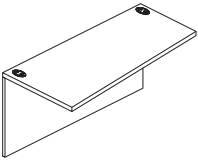
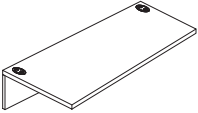
Description	Item Number	Price	Dimensions (inches)			Weight (lb.)	Cubic Feet
			H	W	D		
1" Straight Transition Worksurface w/Full Modesty, LH Shown 	TL-BSTG-2430-L	248	29.0	24	30	33.97	1.65
	TL-BSTG-3030-L	284	29.0	30	30	42.69	2.01
	TL-BSTG-3630-L	307	29.0	36	30	51.41	2.36
	TL-BSTG-4230-L	343	29.0	42	30	60.13	2.72
	TL-BSTG-4830-L	390	29.0	48	30	68.85	3.07
	TL-BSTG-5430-L	426	29.0	54	30	77.57	3.42
	TL-BSTG-6030-L	462	29.0	60	30	86.29	3.78
	TL-BSTG-2430-R	248	29.0	24	30	33.97	1.65
	TL-BSTG-3030-R	284	29.0	30	30	42.69	2.01
	TL-BSTG-3630-R	307	29.0	36	30	51.41	2.36
	TL-BSTG-4230-R	343	29.0	42	30	60.13	2.72
	TL-BSTG-4830-R	390	29.0	48	30	68.85	3.07
	TL-BSTG-5430-R	426	29.0	54	30	77.57	3.42
	TL-BSTG-6030-R	462	29.0	60	30	86.29	3.78
1" Straight Transition Worksurface w/Partial Modesty, LH Shown 	TL-BSTZ-2430-L	248	29.0	24	30	24.07	1.65
	TL-BSTZ-3030-L	284	29.0	30	30	32.79	2.01
	TL-BSTZ-3630-L	307	29.0	36	30	41.51	2.36
	TL-BSTZ-4230-L	343	29.0	42	30	50.23	2.72
	TL-BSTZ-4830-L	390	29.0	48	30	58.95	3.07
	TL-BSTZ-5430-L	426	29.0	54	30	67.67	3.42
	TL-BSTZ-6030-L	462	29.0	60	30	76.39	3.78
	TL-BSTZ-2430-R	248	29.0	24	30	24.07	1.65
	TL-BSTZ-3030-R	284	29.0	30	30	32.79	2.01
	TL-BSTZ-3630-R	307	29.0	36	30	41.51	2.36
	TL-BSTZ-4230-R	343	29.0	42	30	50.23	2.72
	TL-BSTZ-4830-R	390	29.0	48	30	58.95	3.07
	TL-BSTZ-5430-R	426	29.0	54	30	67.67	3.42
	TL-BSTZ-6030-R	462	29.0	60	30	76.39	3.78

ordering options

- > laminate color
- > grommet color

Each laminate comes with matching vinyl trim color unless otherwise specified on your purchase order. Refer to the laminate finish card for details.

details

- > Partial modesties are 12"H.
- > Refer to page 12 for grommet placement.
- > Straight transition worksurface:

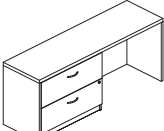

professional | credenzas

Description	Item Number	Price	Dimensions (inches)			Weight (lb.)	Cubic Feet
			H	W	D		
1" Credenza w/Full Modesty, Lateral File on Left-Hand Side 	TL-CRLO-6021	973	29.0	60	21	155.70	30.56
	TL-CRLO-6621	989	29.0	66	21	163.89	33.42
	TL-CRLO-7221	1011	29.0	72	21	172.08	36.28
	TL-CRLO-6024	1046	29.0	60	24	166.65	34.22
	TL-CRLO-6624	1082	29.0	66	24	175.12	37.43
	TL-CRLO-7224	1118	29.0	72	24	183.59	40.64

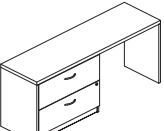
1" Credenza w/Partial Modesty, Lateral File on Left-Hand Side 	TL-CRLO-6021-P	973	29.0	60	21	130.80	30.56
	TL-CRLO-6621-P	989	29.0	66	21	138.99	33.42
	TL-CRLO-7221-P	1011	29.0	72	21	147.18	36.28
	TL-CRLO-6024-P	1046	29.0	60	24	141.75	34.22
	TL-CRLO-6624-P	1082	29.0	66	24	150.22	37.43
	TL-CRLO-7224-P	1118	29.0	72	24	158.69	40.64

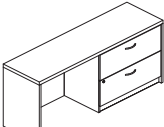
1" Credenza w/Full Modesty, Lateral File on Right-Hand Side 	TL-CR0L-6021	973	29.0	60	21	155.70	30.56
	TL-CR0L-6621	989	29.0	66	21	163.89	33.42
	TL-CR0L-7221	1011	29.0	72	21	172.08	36.28
	TL-CR0L-6024	1046	29.0	60	24	166.65	34.22
	TL-CR0L-6624	1082	29.0	66	24	175.12	37.43
	TL-CR0L-7224	1118	29.0	72	24	183.59	40.64

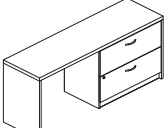
1" Credenza w/Partial Modesty, Lateral File on Right-Hand Side 	TL-CR0L-6021-P	973	29.0	60	21	130.80	30.56
	TL-CR0L-6621-P	989	29.0	66	21	138.99	33.42
	TL-CR0L-7221-P	1011	29.0	72	21	147.18	36.28
	TL-CR0L-6024-P	1046	29.0	60	24	141.75	34.22
	TL-CR0L-6624-P	1082	29.0	66	24	150.22	37.43
	TL-CR0L-7224-P	1118	29.0	72	24	158.69	40.64

ordering options

- > laminate color
- > handle color
- > handle style

Each laminate comes with matching vinyl trim color unless otherwise specified on your purchase order. Refer to the laminate finish card for details.

details

- > Partial modesties are 12"H.
- > Lateral Files include lock and keys.

professional | credenzas

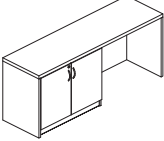
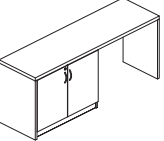
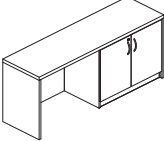
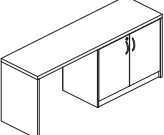
Description	Item Number	Price	Dimensions (inches)			Weight (lb.)	Cubic Feet
			H	W	D		
1" Credenza w/Full Modesty, Storage Cabinet on Left-Hand Side 	TL-CRS0-6021	808	29.0	60	21	141.26	30.56
	TL-CRS0-6621	838	29.0	66	21	149.04	33.42
	TL-CRS0-7221	875	29.0	72	21	166.72	36.28
	TL-CRS0-6024	911	29.0	60	24	187.90	34.22
	TL-CRS0-6624	946	29.0	66	24	203.97	37.43
	TL-CRS0-7224	987	29.0	72	24	240.53	40.64
1" Credenza w/Partial Modesty, Storage Cabinet on Left-Hand Side 	TL-CRS0-6021-P	808	29.0	60	21	116.36	30.56
	TL-CRS0-6621-P	838	29.0	66	21	121.96	33.42
	TL-CRS0-7221-P	875	29.0	72	21	137.02	36.28
	TL-CRS0-6024-P	911	29.0	60	24	163.00	34.22
	TL-CRS0-6624-P	946	29.0	66	24	176.90	37.43
	TL-CRS0-7224-P	987	29.0	72	24	210.83	40.64
1" Credenza w/Full Modesty, Storage Cabinet on Right-Hand Side 	TL-CR0S-6021	808	29.0	60	21	141.26	30.56
	TL-CR0S-6621	838	29.0	66	21	149.04	33.42
	TL-CR0S-7221	875	29.0	72	21	166.72	36.28
	TL-CR0S-6024	911	29.0	60	24	187.90	34.22
	TL-CR0S-6624	946	29.0	66	24	203.97	37.43
	TL-CR0S-7224	987	29.0	72	24	240.53	40.64
1" Credenza w/Partial Modesty, Storage Cabinet on Right-Hand Side 	TL-CR0S-6021-P	808	29.0	60	21	116.36	30.56
	TL-CR0S-6621-P	838	29.0	66	21	121.96	33.42
	TL-CR0S-7221-P	875	29.0	72	21	137.02	36.28
	TL-CR0S-6024-P	911	29.0	60	24	163.00	34.22
	TL-CR0S-6624-P	946	29.0	66	24	176.90	37.43
	TL-CR0S-7224-P	987	29.0	72	24	210.83	40.64

ordering options



- > laminate color
- > handle color
- > handle style

details

- > Partial modesties are 12"H.
- > Cabinets include lock and keys.

Each laminate comes with matching vinyl trim color unless otherwise specified on your purchase order. Refer to the laminate finish card for details.

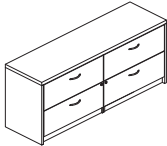
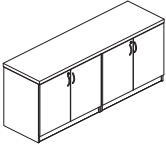
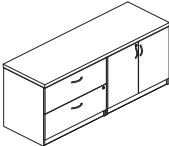
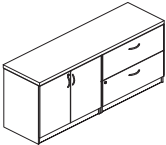
professional | credenzas

Description	Item Number	Price	Dimensions (inches)			Weight (lb.)	Cubic Feet
			H	W	D		
1" Credenza w/Double Lateral Files 	TL-CRLL-7221	1399	29.0	72	21	205.87	36.28
	TL-CRLL-7224	1484	29.0	72	24	220.00	40.64
1" Credenza w/Double Storage Cabinets 	TL-CRSS-7221	1092	29.0	72	21	225.45	36.28
	TL-CRSS-7224	1166	29.0	72	24	236.26	40.64
1" Credenza w/Lateral File on Left-Hand Side, Storage Cabinet on Right-Hand Side 	TL-CRLS-7221	1261	29.0	72	21	211.03	36.28
	TL-CRLS-7224	1367	29.0	72	24	222.74	40.64
1" Credenza w/Storage Cabinet on Left-Hand Side, Lateral File on Right-Hand Side 	TL-CRSL-7221	1261	29.0	72	21	211.03	36.28
	TL-CRSL-7224	1367	29.0	72	24	222.74	40.64
1" Credenza Top 	TL-WSS0-6021	213	1.0	60	21	32.81	5.56
	TL-WSS0-6621	234	1.0	66	21	36.09	6.08
	TL-WSS0-7221	245	1.0	72	21	39.37	6.60
	TL-WSS0-7821	266	1.0	78	21	42.65	7.12
	TL-WSS0-8421	287	1.0	84	21	45.93	7.64

ordering options

- > laminate color
- > handle color
- > handle style

Each laminate comes with matching vinyl trim color unless otherwise specified on your purchase order. Refer to the laminate finish card for details.

details

- > Cabinets and laterals include locks and keys.

professional | intermediate gable supports

Description	Item Number	Price	Dimensions (inches)			Weight (lb.)	Cubic Feet
			H	W	D		
Intermediate Gable Support	T-CGU0-12	111	28.0	12	1	8.75	1.48
	T-CGU0-18	120	28.0	18	1	13.12	2.04

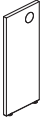

ordering options







- > laminate color
- > grommet color

Each laminate comes with matching vinyl trim color unless otherwise specified on your purchase order. Refer to the laminate finish card for details.

details

- > Refer to page 8 for specific details on intermediate gable support.

professional | pedestals

Description	Item Number	Price	Dimensions (inches)			Weight (lb.)	Cubic Feet
			H	W	D		
Underdesk Box/Box/File Pedestal 	T-FPBU-1618	516	28.0	16	18	55.00	8.15
Underdesk File/File Pedestal 	T-FPFU-1618	516	28.0	16	18	55.00	8.15
Suspended Box/File Pedestal 	T-FPSU-1618	367	16.0	16	18	44.00	5.09
Mobile Box/Box/File Pedestal 	T-FPBM-1621	679	28.0	16	21	74.00	9.26
Mobile File/File Pedestal 	T-FPFM-1621	679	28.0	16	21	68.00	9.26
Mobile Top-Load Pedestal w/Upholstered Seat Cushion 	T-1020-1618	828	23.0	16	18	55.00	6.88
Mobile Box/File Pedestal w/Upholstered Seat Cushion 	T-1030-1618	828	23.0	16	18	55.00	6.88

ordering options

- > laminate color
- > handle color
- > handle style
- > fabric color (for upholstered seat cushion, refer to seating fabric cards)

Each laminate comes with matching vinyl trim color unless otherwise specified on your purchase order. Refer to the laminate finish card for details.

details

- > Pedestals include lock and keys.

professional | filing and storage

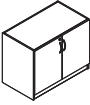
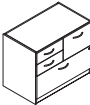
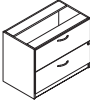
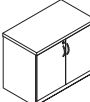
Description	Item Number	Price	Dimensions (inches)			Weight (lb.)	Cubic Feet
			H	W	D		
 Underdesk Storage Cabinet	T-FSU0-3020	632	28.0	30	20	88.00	15.11
	T-FSU0-3620	686	28.0	36	20	102.00	17.78
	T-FSU0-4220	738	28.0	42	20	117.00	20.44
	T-FSU0-3021	632	28.0	30	21	92.00	15.74
	T-FSU0-3621	686	28.0	36	21	107.00	18.52
	T-FSU0-4221	738	28.0	42	21	122.00	21.30
 Underdesk Combo Pedestal w/Box/Box/File and File/File, LH Shown	T-FPJU-3620-L	999	28.0	36	20	121.00	17.78
	T-FPJU-3621-L	999	28.0	36	21	122.00	18.52
	T-FPJU-3620-R	999	28.0	36	20	121.00	17.78
	T-FPJU-3621-R	999	28.0	36	21	122.00	18.52
 Underdesk 2-Drawer Lateral File	T-FL2U-3020	816	28.0	30	20	82.06	15.11
	T-FL2U-3620	846	28.0	36	20	86.64	17.78
	T-FL2U-4220	894	28.0	42	20	89.35	20.44
	T-FL2U-3021	816	28.0	30	21	84.60	15.74
	T-FL2U-3621	846	28.0	36	21	88.02	18.52
	T-FL2U-4221	894	28.0	42	21	91.44	21.30
 1" Freestanding Storage Cabinet	TL-FSF0-3021	665	29.0	30	21	88.00	16.23
	TL-FSF0-3621	717	29.0	36	21	97.00	19.10
	TL-FSF0-4221	769	29.0	42	21	106.00	21.96

ordering options

- > laminate color
- > handle color
- > handle style

Each laminate comes with matching vinyl trim color unless otherwise specified on your purchase order. Refer to the laminate finish card for details.

details

- > Cabinets and lateral files include lock and keys.

professional | filing and storage

Description	Item Number	Price	Dimensions (inches)			Weight (lb.)	Cubic Feet
			H	W	D		
1" Freestanding Combo Pedestal w/Box/Box/File and File/File, LH Shown	TL-FPJF-3621-L	1023	29.0	36	21	130.00	19.10
	TL-FPJF-3621-R	1023	29.0	36	21	130.00	19.10

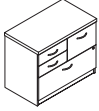

1" Freestanding 2-Drawer Lateral File	TL-FL2F-3021	844	29.0	30	21	92.70	16.23
	TL-FL2F-3621	872	29.0	36	21	107.10	19.10
	TL-FL2F-4221	919	29.0	42	21	121.50	21.96

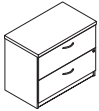

1" Freestanding 3-Drawer Lateral File	TL-FL3F-3021	952	40.0	30	21	136.50	21.64
	TL-FL3F-3621	999	40.0	36	21	144.25	25.46

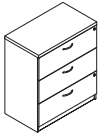

1" Freestanding 4-Drawer Lateral File	TL-FL4F-3021	1285	52.0	30	21	153.10	27.55
	TL-FL4F-3621	1332	52.0	36	21	162.98	32.41



filing and storage

ordering options

- > laminate color
- > handle color
- > handle style

Each laminate comes with matching vinyl trim color unless otherwise specified on your purchase order. Refer to the laminate finish card for details.

details

- > Lateral files include lock and keys.

professional | filing and storage

Description	Item Number	Price	Dimensions (inches)			Weight (lb.)	Cubic Feet
			H	W	D		
1" Storage Cabinet w/Shelves, LH Shown	TL-FSDS-1821-L	742	67.0	18	21	128.70	22.60
	TL-FSDS-1821-R	742	67.0	18	21	128.70	22.60



1" Combo Cabinet w/Storage and Box/Box/File, LH Shown	TL-FCSB-1821-L	1082	67.0	18	21	163.00	22.60
	TL-FCSB-1821-R	1082	67.0	18	21	163.00	22.60



1" Combo Cabinet w/Storage and File/File, LH Shown	TL-FCSF-1821-L	1082	67.0	18	21	162.00	22.92
	TL-FCSF-1821-R	1082	67.0	18	21	162.00	22.92



1" Storage Cabinet w/Coat Bar and Shelves, LH Shown	TL-FSDC-2421-L	802	67.0	24	21	169.95	28.76
	TL-FSDC-2421-R	802	67.0	24	21	169.65	28.76

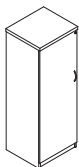

ordering options

- > laminate color
- > handle color
- > handle style

Each laminate comes with matching vinyl trim color unless otherwise specified on your purchase order. Refer to the laminate finish card for details.

details

- > Cabinets include locks and keys.

professional | filing and storage

Description	Item Number	Price	Dimensions (inches)			Weight (lb.)	Cubic Feet
			H	W	D		
1" Storage Cabinet w/Shelves and Glazed Doors, LH Shown	TL-FSDS-1821-LG	1427	67.0	18	21	113.85	22.60
	TL-FSDS-1821-RG	1427	67.0	18	21	113.85	22.60

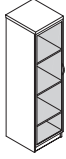

1" Combo Cabinet w/Storage, Box/Box/File and Glazed Doors, LH Shown	TL-FCSB-1821-LG	1612	67.0	18	21	121.00	22.60
	TL-FCSB-1821-RG	1612	67.0	18	21	121.00	22.60

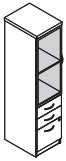

1" Combo Cabinet w/Storage, File/File and Glazed Doors, LH Shown	TL-FCSF-1821-LG	1612	67.0	18	21	116.00	22.60
	TL-FCSF-1821-RG	1612	67.0	18	21	116.00	22.60

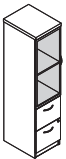

filing and storage

ordering options

- > laminate color
- > metal color (for glazed door frame)
- > handle color
- > handle style

Each laminate comes with matching vinyl trim color unless otherwise specified on your purchase order. Refer to the laminate finish card for details.

details

- > Only laminate drawers include lock and keys.

professional | filing and storage

Description	Item Number	Price	Dimensions (inches)			Weight (lb.)	Cubic Feet
			H	W	D		
1" Double Door Storage Cabinet w/Shelves	TL-FSDS-3621	1130	67.0	36	21	195.39	41.09

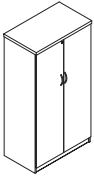

1" Combo Cabinet w/Storage and Lateral File	TL-FCSL-3621	1309	67.0	36	21	251.25	41.09
---	--------------	------	------	----	----	--------	-------

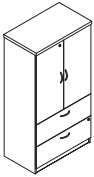

1" Combo Cabinet w/Storage and Combo Pedestal	TL-FCSJ-3621	1463	67.0	36	21	257.35	41.09
---	--------------	------	------	----	----	--------	-------

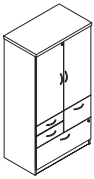

ordering options

- > laminate color
- > handle color
- > handle style

Each laminate comes with matching vinyl trim color unless otherwise specified on your purchase order. Refer to the laminate finish card for details.

details

- > Cabinets include locks and keys.

professional | filing and storage

Description	Item Number	Price	Dimensions (inches)			Weight (lb.)	Cubic Feet
			H	W	D		
1" Double Door Storage Cabinet w/Shelves and Glazed Doors	TL-FSDS-3621-G	1982	67.0	36	21	210.60	41.09

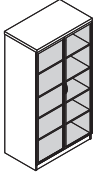

1" Combo Cabinet w/Storage, Lateral File and Glazed Doors	TL-FCSL-3621-G	2198	67.0	36	21	213.05	41.09
--	----------------	------	------	----	----	--------	-------

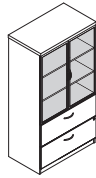

1" Combo Cabinet w/Storage, Combo Pedestal and Glazed Doors	TL-FCSJ-3621-G	2345	67.0	36	21	219.87	41.09
--	----------------	------	------	----	----	--------	-------

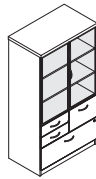

filing and storage

ordering options

- > laminate color
- > metal color (for glazed door frame)
- > handle color
- > handle style

Each laminate comes with matching vinyl trim color unless otherwise specified on your purchase order. Refer to the laminate finish card for details.

details

- > Only laminate drawers include lock and keys.

professional | filing and storage

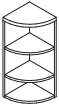
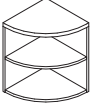
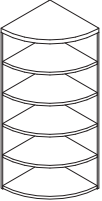
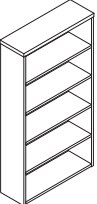
Description	Item Number	Price	Dimensions (inches)			Weight (lb.)	Cubic Feet
			H	W	D		
1" Desktop Radius Corner Bookcase 	TL-SBRD-1537	376	37.0	15	15	44.00	8.57
1" Radius Corner Bookcase 	TL-SBRC-292121	352	29.0	21	21	50.00	11.94
	TL-SBRC-292424	418	29.0	24	24	58.00	14.97
	TL-SBRC-672121	543	67.0	21	21	121.00	25.68
	TL-SBRC-672424	685	67.0	24	24	148.00	32.21
1" Bookcase 	TL-SB00-673012	548	67.0	30	12	156.00	22.35
	TL-SB00-673612	625	67.0	36	12	168.00	26.30

ordering options

> laminate color

Each laminate comes with matching vinyl trim color unless otherwise specified on your purchase order. Refer to the laminate finish card for details.

details

> Bookcases have adjustable shelves and one fixed shelf at desk height. Refer to page 9.

professional | hutches

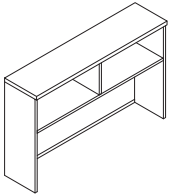
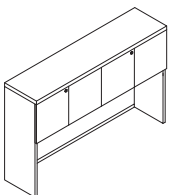
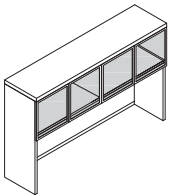
Description	Item Number	Price	Dimensions (inches)			Weight (lb.)	Cubic Feet
			H	W	D		
1" Open Hutch 	TL-SHO0-1530	342	38.5	30	15	69.79	16.08
	TL-SHO0-1536	408	38.5	36	15	79.03	18.91
	TL-SHO0-1542	426	38.5	42	15	88.27	21.75
	TL-SHO0-1548	480	38.5	48	15	97.51	24.59
	TL-SHO0-1554	527	38.5	54	15	106.75	27.42
	TL-SHO0-1560	576	38.5	60	15	115.99	30.26
	TL-SHO0-1566	617	38.5	66	15	125.23	33.10
	TL-SHO0-1572	671	38.5	72	15	134.47	35.93
	TL-SHO0-1578	712	38.5	78	15	143.71	38.77
	TL-SHO0-1584	760	38.5	84	15	152.95	41.61
1" Hinged-Door Hutch 	TL-SHH0-1530-L	573	38.5	30	15	79.24	16.08
	TL-SHH0-1536-L	605	38.5	36	15	88.48	18.91
	TL-SHH0-1542-L	691	38.5	42	15	102.44	21.75
	TL-SHH0-1548-L	749	38.5	48	15	111.68	24.59
	TL-SHH0-1554-L	814	38.5	54	15	120.92	27.42
	TL-SHH0-1560-L	867	38.5	60	15	134.89	30.26
	TL-SHH0-1566-L	920	38.5	66	15	144.13	33.10
	TL-SHH0-1572-L	968	38.5	72	15	153.37	35.93
	TL-SHH0-1578-L	1015	38.5	78	15	162.61	38.77
	TL-SHH0-1584-L	1053	38.5	84	15	171.85	41.61
1" Hinged-Door Hutch w/Glazed Doors 	TL-SHH0-1530-G	898	38.5	30	15	82.39	16.08
	TL-SHH0-1536-G	981	38.5	36	15	91.63	18.91
	TL-SHH0-1542-G	1059	38.5	42	15	107.17	21.75
	TL-SHH0-1548-G	1344	38.5	48	15	116.41	24.59
	TL-SHH0-1554-G	1434	38.5	54	15	125.65	27.42
	TL-SHH0-1560-G	1708	38.5	60	15	142.09	30.26
	TL-SHH0-1566-G	1744	38.5	66	15	151.33	33.10
	TL-SHH0-1572-G	1827	38.5	72	15	160.57	35.93
	TL-SHH0-1578-G	1887	38.5	78	15	169.81	38.77
	TL-SHH0-1584-G	1940	38.5	84	15	179.05	41.61

ordering options

- > laminate color
- > metal color (for glazed door frame)

Each laminate comes with matching vinyl trim color unless otherwise specified on your purchase order. Refer to the laminate finish card for details.

details

- > Number of openings and doors per hutch:

width	30"	36"	42"	48"	54"	60"	66"	72"	78"	84"
openings	1	1	1	1	1	2	2	2	2	2
doors	2	2	3	3	3	4	4	4	4	4

- > Laminate doors include locks and keys.

hutches

professional | hutches

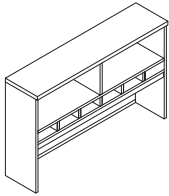
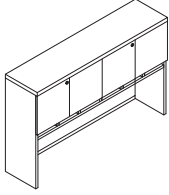
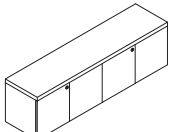
Description	Item Number	Price	Dimensions (inches)			Weight (lb.)	Cubic Feet
			H	W	D		
1" Open Hutch w/Pigeonholes 	TL-SHOP-1530	451	38.5	30	15	81.94	16.08
	TL-SHOP-1536	541	38.5	36	15	91.18	18.91
	TL-SHOP-1542	564	38.5	42	15	105.86	21.75
	TL-SHOP-1548	641	38.5	48	15	115.10	24.59
	TL-SHOP-1554	707	38.5	54	15	129.75	27.42
	TL-SHOP-1560	773	38.5	60	15	142.37	30.26
	TL-SHOP-1566	833	38.5	66	15	151.61	33.10
	TL-SHOP-1572	911	38.5	72	15	164.91	35.93
	TL-SHOP-1578	964	38.5	78	15	177.53	38.77
	TL-SHOP-1584	1035	38.5	84	15	190.16	41.61
1" Hinged-Door Hutch w/Pigeonholes 	TL-SHHP-1530-L	659	38.5	30	15	91.39	16.08
	TL-SHHP-1536-L	710	38.5	36	15	100.63	18.91
	TL-SHHP-1542-L	823	38.5	42	15	120.03	21.75
	TL-SHHP-1548-L	913	38.5	48	15	129.27	24.59
	TL-SHHP-1554-L	1003	38.5	54	15	143.92	27.42
	TL-SHHP-1560-L	1076	38.5	60	15	161.27	30.26
	TL-SHHP-1566-L	1115	38.5	66	15	170.51	33.10
	TL-SHHP-1572-L	1194	38.5	72	15	183.81	35.93
	TL-SHHP-1578-L	1250	38.5	78	15	196.43	38.77
	TL-SHHP-1584-L	1306	38.5	84	15	209.06	41.61
1" Wall-Mounted Hinged-Door Hutch 	TL-SHHW-1548-L	463	16.5	48	15	56.42	11.72
	TL-SHHW-1554-L	485	16.5	54	15	61.21	13.07
	TL-SHHW-1560-L	564	16.5	60	15	66.00	14.43
	TL-SHHW-1566-L	598	16.5	66	15	70.79	15.78
	TL-SHHW-1572-L	620	16.5	72	15	75.58	17.13

NOTE: INSTALL WALL-MOUNTED OVERHEADS DIRECTLY INTO PERMANENT STUDS. PLEASE REFER TO INSTALLATION INSTRUCTIONS.

ordering options

- > laminate color
- > metal color (for glazed door frame)

Each laminate comes with matching vinyl trim color unless otherwise specified on your purchase order. Refer to the laminate finish card for details.



details

- > Number of openings and doors per hutch:

width	30"	36"	42"	48"	54"	60"	66"	72"	78"	84"
openings	1	1	1	1	1	2	2	2	2	2
doors	2	2	3	3	3	4	4	4	4	4

- > Laminate doors include locks and keys.

professional | o-tabletops and bases

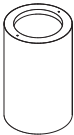
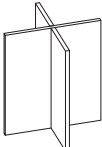
Description	Item Number	Price	Dimensions (inches)			Weight (lb.)	Cubic Feet
			H	W	D		
1" O-Tabletop 	TL-WOXX-36	250	1.0	36	36	26.50	4.63
	TL-WOXX-42	320	1.0	42	42	36.07	6.12
	TL-WOXX-48	360	1.0	48	48	47.12	7.82
Post Support Base 	TB-BASE-1	212	28.0	3	3	7.00	0.85
Drum Base 	TB-BASE-2	530	28.0	18	18	30.00	19.34
Cross Base 	T-B6-36	244	28.0	24	24	33.64	14.52
	T-B6-42	254	28.0	30	30	42.29	21.41
	T-B6-48	270	28.0	36	36	49.23	29.63

o-tabletops and bases

ordering options

- > laminate color
- > metal color (for post support base)

Each laminate comes with matching vinyl trim color unless otherwise specified on your purchase order. Refer to the laminate finish card for details.

details

- > 4 post supports required for each o-tabletop.
- > Drum base:

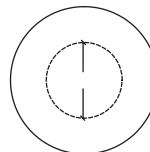

- > Drum base is not applicable on 48" o-tabletop.

professional | reception units

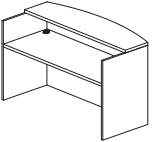
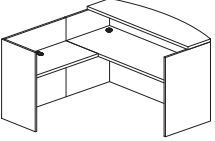
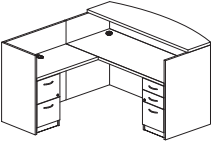
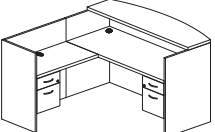
Description	Item Number	Price	Dimensions (inches)			Weight (lb.)	Cubic Feet
			H	W	D		
1" Reception Unit w/Countertop 	TL-RC0G-7230	1117	43.0	72	30	228.15	71.03
1" Reception Unit w/Return and Countertop 	TL-RC0G-7242-L	1409	43.0	72	72	337.11	157.10
	TL-RC0G-7248-L	1486	43.0	72	78	332.55	157.10
	TL-RC0G-7242-R	1409	43.0	72	72	337.11	169.50
	TL-RC0G-7248-R	1486	43.0	72	78	332.55	169.50
1" Reception Unit w/Return and Countertop, Box/Box/File and File/File 	TL-RCXK-7242-L	2035	43.0	72	72	420.85	157.10
	TL-RCXK-7248-L	2102	43.0	72	78	416.29	169.50
	TL-RCXK-7242-R	2035	43.0	72	72	420.85	157.10
	TL-RCXK-7248-R	2102	43.0	72	78	416.29	169.50
1" Reception Unit w/Return and Countertop, Double Suspended Pedestals 	TL-RCSK-7242-L	1868	43.0	72	72	408.23	157.10
	TL-RCSK-7248-L	1941	43.0	72	78	403.67	169.50
	TL-RCSK-7242-R	1868	43.0	72	72	408.23	157.10
	TL-RCSK-7248-R	1941	43.0	72	78	403.67	169.50

ordering options

- > laminate color
- > grommet color
- > handle color (for pedestals)
- > handle style (for pedestals)

Each laminate comes with matching vinyl trim color unless otherwise specified on your purchase order. Refer to the laminate finish card for details.

details

- > Pedestals include lock and keys. Refer to page 8 for details.

professional | coffee and end tables

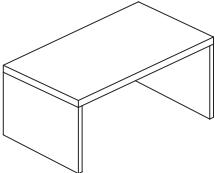
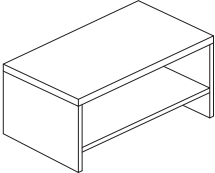
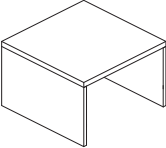
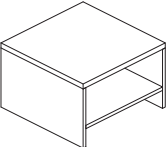
Description	Item Number	Price	Dimensions (inches)			Weight (lb.)	Cubic Feet
			H	W	D		
1" Coffee Table 	TL-TCT0-362017	235	17.0	36	20	39.45	2.22
	TL-TCT0-422017	253	17.0	42	20	43.02	2.56
	TL-TCT0-482017	277	17.0	48	20	46.59	3.61
1" Coffee Table w/Fixed Shelf 	TL-TCTS-362017	295	17.0	36	20	56.70	2.78
	TL-TCTS-422017	313	17.0	42	20	63.58	3.19
	TL-TCTS-482017	336	17.0	48	20	70.46	3.61
1" End Table 	TL-TCT0-202019	217	19.0	20	20	30.66	1.33
	TL-TCT0-242419	248	19.0	24	24	39.30	1.81
	TL-TCT0-303019	313	19.0	30	30	47.94	2.68
1" End Table /w Fixed Shelf 	TL-TCTS-202019	277	19.0	20	20	40.03	1.67
	TL-TCTS-242419	307	19.0	24	24	53.05	2.27
	TL-TCTS-303019	372	19.0	30	30	69.81	3.34

ordering options

> laminate color



Each laminate comes with matching vinyl trim color unless otherwise specified on your purchase order. Refer to the laminate finish card for details.

details

conference

tabletops	136
table bases	138
tabletop and base configurations	140
hutches	141
credenzas	142
filling and storage	145
presentation tools	150

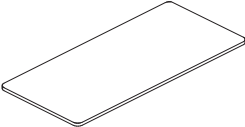
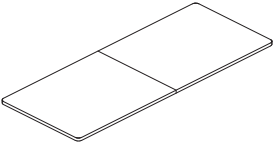
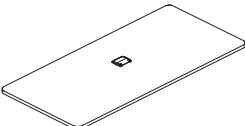
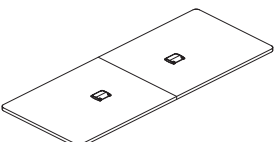
conference | tabletops

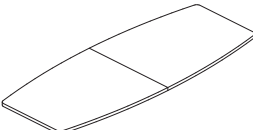
Description	Item Number	Price	Dimensions (inches)			Weight (lb.)	Cubic Feet
			H	W	D		
1.5" Straight Tabletop  	TB-MSSN-7236	398	1.5	72	36	97.55	5.28
	TB-MSSN-8436	447	1.5	84	36	113.49	6.11
	TB-MSSN-7242	494	1.5	72	42	107.77	6.07
	TB-MSSN-8442	543	1.5	84	42	126.55	7.03
	TB-MSSN-9648	596	1.5	96	48	172.43	9.03
	TB-MSSN-10848	612	1.5	108	48	202.11	8.73
	TB-MSSN-12048	682	1.5	120	48	224.11	9.63
	TB-MSSN-13248	760	1.5	132	48	246.11	10.53
	TB-MSSN-14448	831	1.5	144	48	268.11	11.44
	1.5" Straight Tabletop w/Power and Data  	TB-MSS1-7236	636	1.5	72	36	97.55
TB-MSS1-8436		686	1.5	84	36	113.49	6.11
TB-MSS1-7242		732	1.5	72	42	107.77	6.07
TB-MSS1-8442		781	1.5	84	42	126.55	7.03
TB-MSS1-9648		834	1.5	96	48	172.43	9.03
TB-MSS1-10848		1089	1.5	108	48	202.11	8.73
TB-MSS1-12048		1159	1.5	120	48	224.11	9.63
TB-MSS1-13248		1237	1.5	132	48	246.11	10.53
TB-MSS1-14448		1308	1.5	144	48	268.11	11.44
1.5" Boat-Shaped Tabletop  		TB-MBBN-7236	442	1.5	72	36	91.78
	TB-MBBN-8436	489	1.5	84	36	107.28	6.11
	TB-MBBN-7242	554	1.5	72	42	108.66	6.07
	TB-MBBN-8442	602	1.5	84	42	129.34	7.03
	TB-MBBN-9648	673	1.5	96	48	167.78	9.03
	TB-MBBN-10848	691	1.5	108	48	185.35	8.73
	TB-MBBN-12048	771	1.5	120	48	206.05	9.63
	TB-MBBN-13248	860	1.5	132	48	226.75	10.53
	TB-MBBN-14448	958	1.5	144	48	247.45	11.44

ordering options

- > laminate color
- > edge profile
- > grommet color (for tabletops with power and data)

Each laminate comes with matching vinyl trim color unless otherwise specified on your purchase order. Refer to the laminate finish card for details.

details

- > Tabletops 108"W or larger are configured in two-piece tops.
- > Single-piece tabletops are equipped with one power and data grommet and two-piece tabletops are equipped with two power and data grommets.
- > Power and data grommets include two power receptacles, one RJ11 and one RJ45.
- > Tabletops 72"W to 96"W with power and data include one grommet.
- > Tabletops 108"W to 144"W with power and data include two grommets.

conference | tabletops

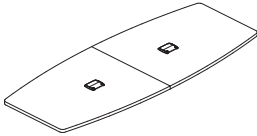
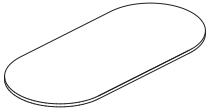
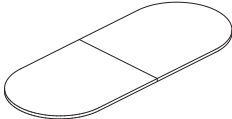
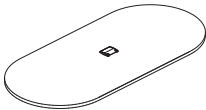
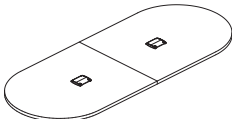
Description	Item Number	Price	Dimensions (inches)			Weight (lb.)	Cubic Feet
			H	W	D		
1.5" Boat-Shaped Tabletop w/Power and Data  	TB-MBB1-7236	681	1.5	72	36	91.78	5.28
	TB-MBB1-8436	727	1.5	84	36	107.28	6.11
	TB-MBB1-7242	793	1.5	72	42	108.66	6.07
	TB-MBB1-8442	841	1.5	84	42	129.34	7.03
	TB-MBB1-9648	912	1.5	96	48	167.78	9.03
	TB-MBB1-10848	1168	1.5	108	48	185.35	8.73
	TB-MBB1-12048	1248	1.5	120	48	206.05	9.63
	TB-MBB1-13248	1337	1.5	132	48	226.75	10.53
	TB-MBB1-14448	1435	1.5	144	48	247.45	11.44
	1.5" Racetrack Tabletop  	TB-MRRN-7236	442	1.5	72	36	90.38
TB-MRRN-8436		489	1.5	84	36	116.26	6.11
TB-MRRN-7242		554	1.5	72	42	103.05	6.07
TB-MRRN-8442		602	1.5	84	42	123.31	7.03
TB-MRRN-9648		673	1.5	96	48	160.68	9.03
TB-MRRN-10848		691	1.5	108	48	183.15	8.73
TB-MRRN-12048		771	1.5	120	48	206.95	9.63
TB-MRRN-13248		860	1.5	132	48	230.75	10.53
TB-MRRN-14448		958	1.5	144	48	254.55	11.44
1.5" Racetrack Tabletop w/Power and Data  		TB-MRR1-7236	681	1.5	72	36	90.38
	TB-MRR1-8436	727	1.5	84	36	116.26	6.11
	TB-MRR1-7242	793	1.5	72	42	103.05	6.07
	TB-MRR1-8442	841	1.5	84	42	123.31	7.03
	TB-MRR1-9648	912	1.5	96	48	160.68	9.03
	TB-MRR1-10848	1168	1.5	108	48	183.15	8.73
	TB-MRR1-12048	1248	1.5	120	48	206.95	9.63
	TB-MRR1-13248	1337	1.5	132	48	230.75	10.53
	TB-MRR1-14448	1435	1.5	144	48	254.55	11.44

ordering options

- > laminate color
- > edge profile
- > grommet color (for tabletops with power and data)

Each laminate comes with matching vinyl trim color unless otherwise specified on your purchase order. Refer to the laminate finish card for details.

details

- > Tabletops 108"W or larger are configured in two-piece tops.
- > Single-piece tabletops are equipped with one power and data grommet and two-piece tabletops are equipped with two power and data grommets.
- > Power and data grommets include two power receptacles, one RJ11 and one RJ45.
- > Tabletops 72"W to 96"W with power and data include one grommet.
- > Tabletops 108"W to 144"W with power and data include two grommets.

conference | table bases

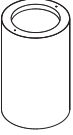
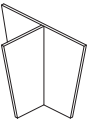
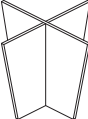
Description	Item Number	Price	Dimensions (inches)			Weight (lb.)	Cubic Feet
			H	W	D		
Post Support Base	TB-BASE-1	212	28.0	3	3	7.00	0.85
							
Drum Base	TB-BASE-2	530	28.0	18	18	30.00	19.34
							
Wedge Base	TB-B3-T36	159	28.0	28	18	24.67	19.34
	TB-B3-T42	159	28.0	32	18	28.12	19.34
	TB-B3-T48	159	28.0	36	18	32.16	19.34
							
	TB-B3-X48	200	28.0	36	35	45.52	19.34

ordering options

- > laminate color
- > metal color (for post support base)

Each laminate comes with matching vinyl trim color unless otherwise specified on your purchase order. Refer to the laminate finish card for details.

details

- > Refer to page 140 for base configuration requirements for selected tabletops.

conference | table bases

table bases

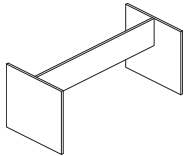
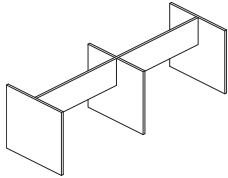
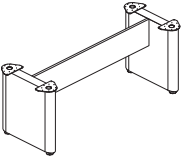
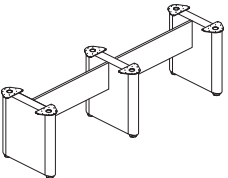
Description	Item Number	Price	Dimensions (inches)			Weight (lb.)	Cubic Feet
			H	W	D		
Gable and Modesty Base 	TB-B4-7236	318	28.0	42	21	41.45	3.52
	TB-B4-8436	318	28.0	54	21	44.55	4.07
	TB-B4-7242	318	28.0	42	24	52.15	4.05
	TB-B4-8442	318	28.0	54	24	55.89	4.69
	TB-B4-9648	318	28.0	66	30	63.75	6.02
	TB-B4-10848	518	28.0	77	30	67.75	3.49
	TB-B4-12048	518	28.0	89	30	71.99	3.85
	TB-B4-13248	518	28.0	101	30	76.23	4.21
	TB-B4-14448	518	28.0	113	30	80.47	4.57
	Elliptical Base 	TB-B5-72	587	28.0	42	24	56.50
TB-B5-84		587	28.0	54	24	61.50	5.00
TB-B5-96		587	28.0	66	24	66.50	5.50
	TB-B5-108	881	28.0	77	24	86.50	4.50
	TB-B5-120	881	28.0	89	24	91.50	5.00
	TB-B5-132	881	28.0	101	24	96.50	5.50
	TB-B5-144	881	28.0	113	24	101.50	6.00





ordering options

- > laminate color
- > metal color (for elliptical base)

Each laminate comes with matching vinyl trim color unless otherwise specified on your purchase order. Refer to the laminate finish card for details.

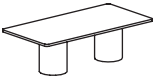
details

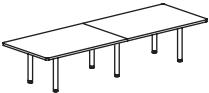
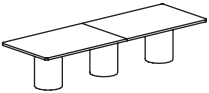
conference | tabletop and base configurations

Tabletop Sizes	Post Support	Drum Base	Wedge Base + Cross Base
			
72" x 36"	4	2	2 wedge
84" x 36"	4	2	2 wedge
72" x 42"	4	2	2 wedge
84" x 42"	4	2	2 wedge
96" x 48"	4	2	2 wedge
			
108" x 48"	6	3	2 wedge + 1 cross base
120" x 48"	6	3	2 wedge + 1 cross base
132" x 48"	6	3	2 wedge + 1 cross base
144" x 48"	6	3	2 wedge + 1 cross base

conference | hutches

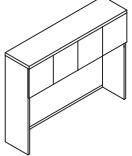
Description	Item Number	Price	Dimensions (inches)			Weight (lb.)	Cubic Feet
			H	W	D		
1.5" Hinged-Door Hutch 	TB-SHH0-1530	642	48.5	30	15	119.70	19.63
	TB-SHH0-1536	678	48.5	36	15	141.30	23.09
	TB-SHH0-1560	971	48.5	60	15	177.75	36.94
	TB-SHH0-1566	1030	48.5	66	15	188.55	40.41
	TB-SHH0-1572	1084	48.5	72	15	200.70	43.87

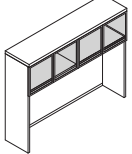
1.5" Hinged-Door Hutch w/Glazed Doors 	TB-SHH0-1530-G	1082	48.5	30	15	118.80	36.94
	TB-SHH0-1536-G	1169	48.5	36	15	126.00	40.41
	TB-SHH0-1560-G	1932	48.5	60	15	161.55	36.94
	TB-SHH0-1566-G	1970	48.5	66	15	172.35	40.41
	TB-SHH0-1572-G	2057	48.5	72	15	186.55	43.87

ordering options

- > laminate color
- > edge profile
- > metal color (for glazed door frame)

Each laminate comes with matching vinyl trim color unless otherwise specified on your purchase order. Refer to the laminate finish card for details.

details

- > Number of doors per hutch:

width	30"	36"	60"	66"	72"
doors	2	2	4	4	4

- > Hutch doors are not lockable.

conference | credenzas

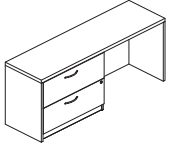
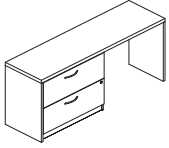
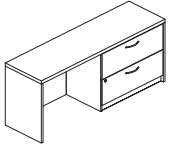
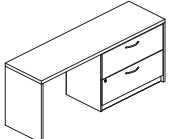
Description	Item Number	Price	Dimensions (inches)			Weight (lb.)	Cubic Feet
			H	W	D		
1.5" Credenza w/Full Modesty, Lateral File on Left-Hand Side	TB-CRL0-6021	1132	29.5	60	21	172.35	31.02
	TB-CRL0-6621	1163	29.5	66	21	181.80	33.93
	TB-CRL0-7221	1201	29.5	72	21	189.90	36.83
							
1.5" Credenza w/Partial Modesty, Lateral File on Left-Hand Side	TB-CRL0-6021-P	1132	29.5	60	21	148.95	31.02
	TB-CRL0-6621-P	1163	29.5	66	21	155.70	33.93
	TB-CRL0-7221-P	1201	29.5	72	21	162.72	36.83
							
1.5" Credenza w/Full Modesty, Lateral File on Right-Hand Side	TB-CR0L-6021	1132	29.5	60	21	172.35	31.02
	TB-CR0L-6621	1163	29.5	66	21	181.80	33.93
	TB-CR0L-7221	1201	29.5	72	21	189.90	36.83
							
1.5" Credenza w/Partial Modesty, Lateral File on Right-Hand Side	TB-CR0L-6021-P	1132	29.5	60	21	148.95	31.02
	TB-CR0L-6621-P	1163	29.5	66	21	155.70	33.93
	TB-CR0L-7221-P	1201	29.5	72	21	162.72	36.83
							

ordering options

- > laminate color
- > edge profile
- > handle color
- > handle style

Each laminate comes with matching vinyl trim color unless otherwise specified on your purchase order. Refer to the laminate finish card for details.

details

- > Partial modesties are 12"H.
- > Lateral files include lock and keys.
- > All handles are 7 1/2" long.

conference | credenzas

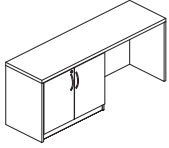
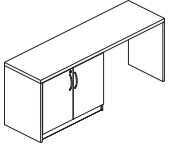
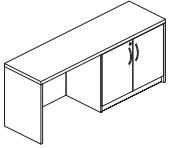
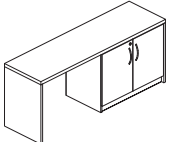
Description	Item Number	Price	Dimensions (inches)			Weight (lb.)	Cubic Feet
			H	W	D		
1.5" Credenza w/Full Modesty, Storage Cabinet on Left-Hand Side	TB-CRS0-6021	987	29.5	60	21	168.75	31.02
	TB-CRS0-6621	1019	29.5	66	21	178.20	33.93
	TB-CRS0-7221	1058	29.5	72	21	186.30	36.83
							
1.5" Credenza w/Partial Modesty, Storage Cabinet on Left-Hand Side	TB-CRS0-6021-P	987	29.5	60	21	145.35	31.02
	TB-CRS0-6621-P	1019	29.5	66	21	152.10	33.93
	TB-CRS0-7221-P	1058	29.5	72	21	166.78	36.83
							
1.5" Credenza w/Full Modesty, Storage Cabinet on Right-Hand Side	TB-CR0S-6021	987	29.5	60	21	168.75	31.02
	TB-CR0S-6621	1019	29.5	66	21	178.20	33.93
	TB-CR0S-7221	1058	29.5	72	21	186.30	36.83
							
1.5" Credenza w/Partial Modesty, Storage Cabinet on Right-Hand Side	TB-CR0S-6021-P	987	29.5	60	21	145.35	31.02
	TB-CR0S-6621-P	1019	29.5	66	21	152.10	33.93
	TB-CR0S-7221-P	1058	29.5	72	21	166.78	36.83
							

credenzas

ordering options

- > laminate color
- > edge profile
- > handle color
- > handle style

details

- > Partial modesties are 12"H.
- > Cabinets include lock and keys.
- > All handles are 7 1/2" long.

Each laminate comes with matching vinyl trim color unless otherwise specified on your purchase order. Refer to the laminate finish card for details.

conference | credenzas

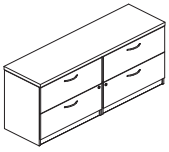
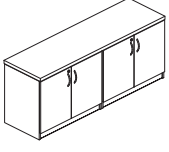
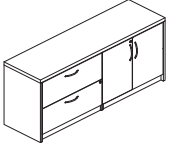
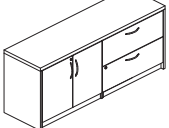
Description	Item Number	Price	Dimensions (inches)			Weight (lb.)	Cubic Feet
			H	W	D		
1.5" Credenza w/Double Lateral Files 	TB-CRLL-7221	1572	29.5	72	21	232.65	36.83
1.5" Credenza w/Double Storage Cabinets 	TB-CRSS-7221	1226	29.5	72	21	225.45	36.83
1.5" Credenza w/Lateral File on Left-Hand Side, Storage Cabinet on Right-Hand Side 	TB-CRLS-7221	1417	29.5	72	21	229.05	36.83
1.5" Credenza w/Storage Cabinet on Left-Hand Side, Lateral File on Right-Hand Side 	TB-CRSL-7221	1417	29.5	72	21	229.05	36.83

ordering options

- > laminate color
- > edge profile
- > handle color
- > handle style

Each laminate comes with matching vinyl trim color unless otherwise specified on your purchase order. Refer to the laminate finish card for details.

details

- > Cabinets and laterals include locks and keys.
- > All handles are 7 1/2" long.

conference | filing and storage

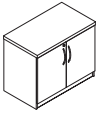
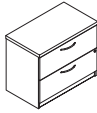
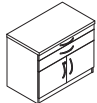
Description	Item Number	Price	Dimensions (inches)			Weight (lb.)	Cubic Feet
			H	W	D		
1.5" Freestanding Storage Cabinet 	TB-FSF0-3021	731	29.5	30	21	99.45	16.48
	TB-FSF0-3621	784	29.5	36	21	113.40	19.39
1.5" Freestanding 2-Drawer Lateral File 	TB-FL2F-3021	923	29.5	30	21	108.90	16.48
	TB-FL2F-3621	953	29.5	36	21	117.27	19.39
1.5" Serving Cabinet 	TB-FCS0-3021	901	29.5	30	21	110.08	16.48
	TB-FCS0-3621	1219	29.5	36	21	123.75	19.39

filing and storage

ordering options

- > laminate color
- > edge profile
- > handle color
- > handle style

details

- > Cabinets and laterals include lock and keys.
- > All handles are 7 1/2" long.

Each laminate comes with matching vinyl trim color unless otherwise specified on your purchase order. Refer to the laminate finish card for details.

conference | filing and storage

Description	Item Number	Price	Dimensions (inches)			Weight (lb.)	Cubic Feet
			H	W	D		
1.5" Storage Cabinet w/Shelves, LH Shown	TB-FSDS-1821-L	813	78.0	18	21	146.70	26.10
	TB-FSDS-1821-R	813	78.0	18	21	146.70	26.10



1.5" Double Door Storage Cabinet w/Shelves	TB-FSDS-3621	1275	78.0	36	21	254.25	47.45
---	--------------	------	------	----	----	--------	-------

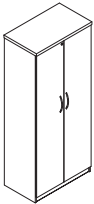

1.5" Combo Cabinet w/Storage and Lateral Files	TB-FCSL-3621	1514	78.0	36	21	279.90	47.45
---	--------------	------	------	----	----	--------	-------

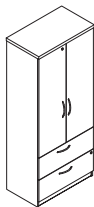

ordering options

- > laminate color
- > edge profile
- > handle color
- > handle style

Each laminate comes with matching vinyl trim color unless otherwise specified on your purchase order. Refer to the laminate finish card for details.

details

- > Cabinets and laterals include locks and keys.
- > All handles are 7 1/2" long.

conference | filing and storage

Description	Item Number	Price	Dimensions (inches)			Weight (lb.)	Cubic Feet
			H	W	D		
1.5" Storage Cabinet w/Shelves and Glazed Door, LH Shown	TB-FSDS-1821-LG	1532	78.0	18	21	131.85	26.10
	TB-FSDS-1821-RG	1532	78.0	18	21	131.85	26.10

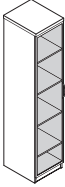

1.5" Double Door Storage Cabinet w/Shelves and Glazed Doors	TB-FSDS-3621-G	2171	78.0	36	21	225.45	47.45
--	----------------	------	------	----	----	--------	-------

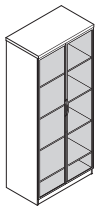

1.5" Combo Cabinet w/Storage, Lateral Files and Glazed Doors	TB-FCSL-3621-G	2439	78.0	36	21	278.10	47.45
---	----------------	------	------	----	----	--------	-------

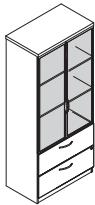

ordering options

- > laminate color
- > edge profile
- > metal color (for glazed door frame)
- > handle color
- > handle style

details

- > Only laminate drawers include lock and keys.
- > All handles are 7 1/2" long.

Each laminate comes with matching vinyl trim color unless otherwise specified on your purchase order. Refer to the laminate finish card for details.

conference | filing and storage

Description	Item Number	Price	Dimensions (inches)			Weight (lb.)	Cubic Feet
			H	W	D		
1.5" Storage Cabinet w/Coat Bar and Shelves, LH Shown	TB-FSDC-2421-L	876	78.0	24	21	194.40	33.22
	TB-FSDC-2421-R	876	78.0	24	21	194.40	33.22



1.5" Combo Cabinet w/Storage and Bookcase, LH Shown	TB-FCBS-7821-L	996	78.0	21	21	139.05	29.66
	TB-FCBS-7821-R	996	78.0	21	21	139.05	29.66

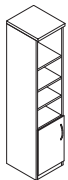

1.5" Combo Cabinet w/Storage and Bookcase	TB-FCBS-7830	1066	78.0	30	21	176.62	40.34
	TB-FCBS-7836	1166	78.0	36	21	211.95	47.45

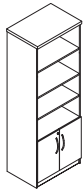

1.5" Audiovisual Cabinet	TB-FCAV-7836	2009	78.0	36	26	335.25	56.94
	TB-FCAV-7842	2115	78.0	42	26	370.35	65.49

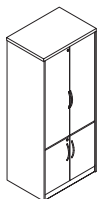

ordering options

- > laminate color
- > edge profile
- > handle color
- > handle style

details

- > Cabinets include locks and keys.
- > All handles are 7 1/2" long.

Each laminate comes with matching vinyl trim color unless otherwise specified on your purchase order. Refer to the laminate finish card for details.

conference | filing and storage

Description	Item Number	Price	Dimensions (inches)			Weight (lb.)	Cubic Feet
			H	W	D		
1.5" Radius Corner Bookcase	TB-SBRC-782121	625	78.0	21	21	147.60	29.66

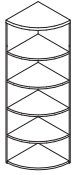

1.5" Bookcase

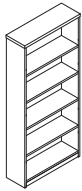

TB-SB00-782415	550	78.0	24	15	137.82	25.25
TB-SB00-783015	631	78.0	30	15	172.27	30.66
TB-SB00-783615	712	78.0	36	15	206.72	36.06

ordering options

- > laminate color
- > edge profile

Each laminate comes with matching vinyl trim color unless otherwise specified on your purchase order. Refer to the laminate finish card for details.

details

- > Bookcases have adjustable shelves and one fixed shelf at desk height. Refer to page 9.

conference | presentation tools

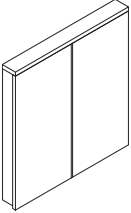
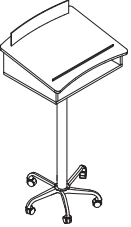
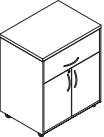
Description	Item Number	Price	Dimensions (inches)			Weight (lb.)	Cubic Feet
			H	W	D		
1.5" Whiteboard Cabinet 	TB-VB00-4850	954	51.0	48	5.6	112.95	15.89
Mobile Lectern 	TB-LP0M	925	41.0	26	23	109.35	21.09
1.5" Mobile Media Center 	TB-FCMT-3624 TB-FCMT-4230	1587 1826	46.0 46.0	36 42	24 30	228.15 279.90	32.41 45.25

ordering options

- > laminate color
- > edge profile (for whiteboard cabinet and mobile media center)
- > handle color
- > handle style
- > tackboard fabric (for whiteboard cabinet)

Each laminate comes with matching vinyl trim color unless otherwise specified on your purchase order. Refer to the laminate finish card for details.

details

- > Mobile Lectern includes decorative acrylic valance and paper stopper. Mobile Lectern bases are black.
- > Mobile Media Center includes locks and keys.
- > All handles are 7 1/2" long.

accessories

keyboard trays	154
tackboards	155
pencil drawer	155
task lights	156
monitor arms	157
CPU holders	157
wire manager	158

metropolis | accessories

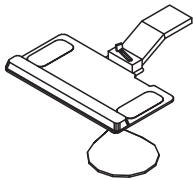
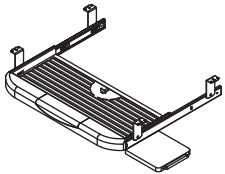
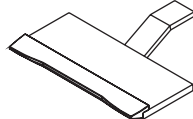
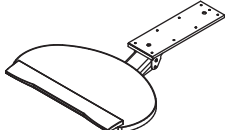
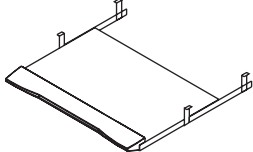
Description	Item Number	Price	Dimensions (inches)			Weight (lb.)	Cubic Feet
			H	W	D		
Articulating Keyboard Tray w/Mouse Tray 	T-KAS0-2011-L	471	20	11	3.00	0.83	
	T-KAS0-2011-R	471	20	11	3.00	0.83	
Retractable Keyboard Tray w/Mouse Tray 	T-KRMP-2211	57	22	11	2.00	0.90	
Articulating Laminate Keyboard Tray 	T-KAS0-2510	383	25	10	15.00	0.94	
Curved Articulating Laminate Keyboard Tray 	T-KAC0-2814	383	28	14	15.10	1.33	
Retractable Laminate Keyboard Tray 	T-KRS0-2516	107	25	16	12.00	1.34	

ordering options

> laminate color (for laminate keyboard trays)

Each laminate comes with matching vinyl trim color unless otherwise specified on your purchase order. Refer to the laminate finish card for details.

details

> Available in black only and with built-in mouse tray:

T-KAS0-2011-L/R

T-KRMP-2211

> All keyboard trays include palm rests.

metropolis | accessories

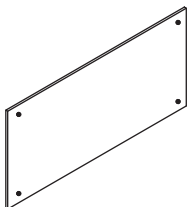
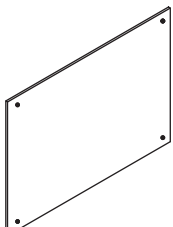
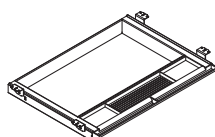
Description	Item Number	Price	Dimensions (inches)			Weight (lb.)	Cubic Feet
			H	W	D		
14"H Tackboard for Hutch w/Pigeonholes 	T-ATH0-1427	137	14.0	27	0.5	1.70	0.81
	T-ATH0-1433	143	14.0	33	0.5	2.10	0.96
	T-ATH0-1439	149	14.0	39	0.5	2.50	1.12
	T-ATH0-1445	155	14.0	45	0.5	2.90	1.28
	T-ATH0-1451	161	14.0	51	0.5	3.30	1.43
	T-ATH0-1457	166	14.0	57	0.5	3.70	1.59
	T-ATH0-1463	173	14.0	63	0.5	4.10	1.74
	T-ATH0-1469	179	14.0	69	0.5	4.50	1.90
	T-ATH0-1475	197	14.0	75	0.5	4.90	2.06
T-ATH0-1481	226	14.0	81	0.5	5.40	2.21	
21"H Tackboard for Hutch without Pigeonholes 	T-ATH0-2127	173	21.0	27	0.5	2.70	1.12
	T-ATH0-2133	179	21.0	33	0.5	3.10	1.34
	T-ATH0-2139	197	21.0	39	0.5	3.50	1.56
	T-ATH0-2145	214	21.0	45	0.5	3.90	1.77
	T-ATH0-2151	232	21.0	51	0.5	4.30	1.99
	T-ATH0-2157	257	21.0	57	0.5	4.70	2.21
	T-ATH0-2163	280	21.0	63	0.5	5.10	2.42
	T-ATH0-2169	311	21.0	69	0.5	5.50	2.64
	T-ATH0-2175	321	21.0	75	0.5	5.90	2.86
T-ATH0-2181	334	21.0	81	0.5	6.30	3.07	
Plastic Pencil Drawer 	T-ADPP	46	2.8	21	16	2.00	0.62

ordering options

> fabric color (for tackboard)

details

> Plastic Pencil Drawers are available in black only.

metropolis | accessories

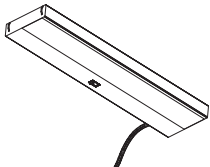
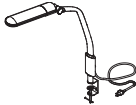
Description	Item Number	Price	Dimensions (inches)			Weight (lb.)	Cubic Feet
			H	W	D		
Task Light 	T-ELT0-26	192	2	24	7	8.00	0.98
	T-ELT0-44	200	2	40	7	12.00	1.54
Task Light w/Dimmer Switch 	T-ELTD-26	369	2	28	7	10.00	1.12
	T-ELTD-44	375	2	46	7	14.00	1.75
Swing Arm Task Light 	T-ELSO	263	26.5	3.5	4	4.50	0.52

ordering options

details

- > All task lights come in black finish.
- > Swing arm task light includes clamp mount.

metropolis | accessories

Description	Item Number	Price	Dimensions (inches)			Weight (lb.)	Cubic Feet
			H	W	D		

Monitor Arm - Grommet Mount

T-AFMA-G

254

16.0 5-20

10.00

0.80

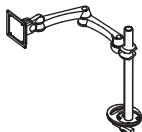

Monitor Arm - Clamp Mount

T-AFMA-C

254

16.0 5-20

10.00

0.80

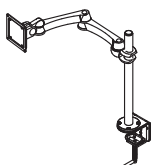

CPU Holder - Fixed Mount

T-ACPU

161

18.0 8.5 11.5

8.00

1.01



CPU Holder - Mobile

T-ACPU-M

176

4.3 15.5 9

8.00

0.34

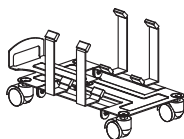

ordering options

> Monitor Arms are available in black or silver.

details

- > Monitor arms have 3-dimension adjustability.
- > CPU holders are adjustable and available in black only.

metropolis | accessories

Description	Item Number	Price	Dimensions (inches)			Weight (lb.)	Cubic Feet
			H	W	D		
Vertical Wire Manager	T-EE00	116	28.0	4	4	1.00	0.25



[ordering options](#)

[details](#)

> Wire manager is available in black only.

terms and conditions

terms and conditions	162
warranty	164
care and maintenance	165

tayco | terms and conditions

prices

Prices listed herein are for the Metropolis product line. Prices are subject to change without notice. Not included in the list prices are special packaging, freight, unloading, unpacking and installation. Possession of this price list does not constitute an offer to sell. Only orders received from authorized Tayco dealers will be processed.

payment

Terms of payment are net 30 days from date of invoice, upon credit approval.

In Canada remit payment to:

630 Kipling Avenue, Toronto, Ontario, Canada M8Z 5G1

Outside of Canada remit payment to:

P.O. Box 8500-53858, Philadelphia, PA 19178-3858

order placement and confirmation

Tayco requires that all orders be in writing and accompanied by an Order Cover Sheet to avoid errors. When placing orders, please refer to products by their product code and Tayco quotation number, if applicable. Specify all applicable finishes and clearly indicate the total net value of the order on the Purchase Order. Also note the "ship to" address if it is different from the "bill to" address.

In Canada orders should be faxed or emailed to:

(416) 252-4467, purchaseorders@tayco.com

In the United States orders should be faxed to:

(888) 291-0127

order acknowledgement

Upon receiving a Purchase Order, Tayco will fax an Order Acknowledgement indicating the shipping schedule and a description of the goods ordered. It is the responsibility of the Purchaser to verify the Order Acknowledgement for accuracy.

order changes

All changes to a Purchase Order must be made in writing and are subject to approval by Tayco. Please note: changes may affect the lead-time and may be subject to additional charges. Once production has begun, no changes will be accepted.

order cancellation

All cancellations must be made in writing and are subject to approval by Tayco. Orders in production will incur a minimum charge of 50% (of net) for cancellation. Once production has begun, cancellations will not be accepted.

specifications

Detailed specifications are available upon request. Tayco reserves the right to make changes in materials, dimensions, style or specifications if the changes will improve an item's quality or appearance.

storage

In the event that the Purchaser requests postponement of delivery beyond the acknowledged shipping date (after the goods have become a "work in progress", or at a time when Tayco is about to make shipment), the Purchaser must exercise one of two options:

- > Immediately transfer the goods to a storage facility of the Purchaser's choice at the risk and expense of the Purchaser. Such transfer to storage shall be deemed as delivery to the Purchaser for all purposes, including invoicing and payment.
- > Store the product at Tayco for up to 30 days. Storage fees will be incurred five days after the order is ready for shipment. The storage rate is \$25 per day up to a maximum of \$100 per week. On the 31st day after manufacturing completion, the order must be shipped or the Purchaser must make arrangements for the storage of goods.

All goods are payable from the date Tayco has finished manufacturing.

order delays

Tayco's Order Acknowledgement will state a shipping date, which is Tayco's best estimate at the time the order is acknowledged. However, Tayco shall not incur any obligation or liability to the Purchaser for failure to ship by the specified date unless Tayco has agreed to an unequivocal, firm shipping date in a separately signed written document, executed by authorized personnel at Head Office. Tayco holds no liability for any failure to deliver or any delay in delivering or performing any obligation due to any cause outside the reasonable control of Tayco, including but not limited to, fire, flood, bad weather, war, terrorism, civil disturbance, riot, act of government, government regulation, governmental restriction on export or import, currency restriction, labor dispute, strike, plant shutdown, unavailability of materials, equipment failure or failure of supplier, carrier or subcontractor to deliver on time or otherwise perform.

back charges

Tayco will not accept charges for expenses incurred by the Purchaser in expediting shipments, for the repair of damage caused by others or for delay of any shipment. Deductions from invoice payments are not permitted unless authorized in writing by Tayco.

assembly

Some assembly is required. Desks that include filing or storage, as well as hutches, ship assembled. Desk shells (without filing or storage), bridge desks and tables require assembly.

freight terms

All goods are sold F.O.B. Tayco, Toronto, Canada, unless otherwise quoted. All shipments are LTL (less than truckload) dock-to-dock, Monday through Friday, 8 a.m. to 5 p.m. The following services may be arranged for an extra charge: delivery after hours on Canadian or U.S. holidays or weekends, residential or inside delivery, delivery to government buildings or schools, use of special equipment (tailgate, pump-truck), delivery to an end user, delivery by appointment or within specific time requirements. Special requests must be noted on the Purchase Order. Tayco will provide customers with an anticipated date of delivery. Every effort is made to adhere to the prescribed delivery date;

tayco | terms and conditions

however, neither Tayco nor the carrier will guarantee or be held responsible in any manner for delays or deviation from the planned delivery date. Drivers are not responsible or permitted to assist in the off-load of product. Tayco is not responsible for any costs incurred for late deliveries, including labor or other charges resulting from unforeseen delays.

freight claims

Tayco is not responsible for damage that occurs in transit or in storage. The carrier signs for all goods received in good order from Tayco. It is the Purchaser's responsibility to examine goods upon receipt and file any claims with Tayco. Any damages or shortages must be noted on the bill of lading prior to signing for the delivery. Any claims against Tayco for apparent defects, errors or shortages must be made by the Purchaser, in writing, within five (5) working days after delivery. Failure by the Purchaser to make any claim against Tayco within five days shall constitute acceptance of the goods and waive the right to claim any apparent defects, errors or shortages.

termination

If at any time Tayco is reasonably led to believe that its interests are imperiled, Tayco may, without prejudice, terminate any order immediately or may defer shipment until the situation is remedied to Tayco's satisfaction. Reasons for order termination include, but are not limited to, the following: default in payment of any sum due to Tayco, breach of any of the terms and conditions of an order or other contract with Tayco, a material change in ownership or form of the purchasing organization or if at any time the Purchaser's financial condition becomes unsatisfactory to Tayco.

packaged cubic footage

The cubic footage listed in this price book is calculated for single item orders and should be used only as a guide in estimating shipping costs. When shipping multiple items, the cubic footage per item will be reduced, as Tayco packs orders to reduce space and freight costs. Please consult with Customer Service if more accurate (order-specific) information is required.

return merchandise

It is not Tayco's policy to accept returned product. In extenuating circumstances the return of product may be approved by Tayco. The Purchaser must request a Return Authorization Form from Tayco. All such returns must be shipped freight prepaid including duty and brokerage fees unless otherwise indicated by Tayco. Standard items are subject to a minimum restocking charge of 50% of the net value of the returned items. COD (cash on delivery) returns will not be accepted.

repairs

Liability for the repair of items will be limited to repair or replacement. Tayco will not issue credit allowances for any repairs without Tayco's prior written consent.

replacement parts

Replacement parts will be processed as a priority. Please consult with Customer Service for prices and include product codes and descriptions with your Purchase Order.

tayco | warranty

Tayco products included in our standard offering are covered by a limited lifetime warranty to the original customer. Tayco warrants that its products are defect-free in design, materials and workmanship under normal use and care. Upon inspection, Tayco reserves the right to repair, correct or exchange at our option any product that is defective in material or workmanship. Value of exchanged products will be of equal value or better of the original item.

limitations to the warranty include:

- > Keyboard trays and mechanisms are warranted for three years from the date of delivery.
- > Moving parts, which include slides, glides and casters, are warranted for five years from the date of delivery.
- > Seating upholstery and fabrics are warranted for five years from the date of delivery.
- > Flat-screen monitor arms are warranted for three years from the date of delivery.
- > Electrical components are warranted for 10 years from the date of delivery.

this warranty does not include:

- > Ballast and light bulbs;
- > Customer's own material of any kind;
- > Product damage caused by improper installation, accident, negligence, natural disaster, insufficient or excessive electrical supply, environmental conditions or any unauthorized repair or modification;
- > Product damage caused by a carrier or transportation of the product from one location to another;

tayco | care and maintenance

fabrics

To remove dust particles, lightly vacuum the fabric surface. Spills and fluid should be immediately blotted. For minor fabric stains and marks use water-based fabric solvent, applying light pressure, to lift the dirt and stain. Any use of water and soaps may harm the fabric, causing water stains and damage to the fabric's contents. Do not scrub the fabric with bristle or vacuum brushes as the fabric may pill or tear and the appearance may be permanently affected. Professional steam cleaning is recommended.

laminates

Dust laminated surfaces for regular maintenance. Clean any dirt or stain with a damp cloth. Do not use an excessive amount of water, abrasive cleaners, acids or alkalis and do not scratch or scrape surfaces. For persistent stains and marks use a commercial cleaner, such as Cabinet Magic® or Countertop Magic®, both manufactured by Magic American Corporation.

acrylic glazing (frosted)

Dust regularly to keep surfaces free of dust particles. Clean any dirt or stain with a damp cloth. Dry the area using a dry paper cloth. The use of fiber cloths or rags is not recommended as loose particles and debris remaining on the cloth may scratch or harm the acrylic surface. Do not use other chemical cleaners or window cleaners as their chemical compositions may alter and/or permanently affect the surface appearance.

painted metals

Tayco's painted metal products are powder-paint-coated. To clean these products, use a damp cloth, using only a small amount of lukewarm water if necessary. Dry with a clean, dry cloth. To avoid scratching and damaging the painted surface, do not use hard bristled brushes or abrasives.

THE USE OF HARSH CLEANERS AND CHEMICALS MAY PERMANENTLY ALTER THE PRODUCT FINISH APPEARANCE AND WILL VOID ANY WARRANTY.

tayco.
work well.™

office furniture
in your comfort zone.
www.tayco.com

WORK WELL IS A TRADEMARK OF TAYCO PANELINK LTD. ALL RIGHTS RESERVED.
UP IS A TRADEMARK OF TAYCO PANELINK LTD. ALL RIGHTS RESERVED.
TEKNIT™ IS A TRADEMARK OF INTERFACE FABRICS, INC., AN INTERFACE COMPANY.
JANUARY 2008 | REVISION 1 | TPL-MKT-02-086
PRINTED IN CANADA