

lzf



POWERED BY
GlobalLighting

www.globallighting.com



Farolillo
Bang Design

FAROLILLO Bang Design

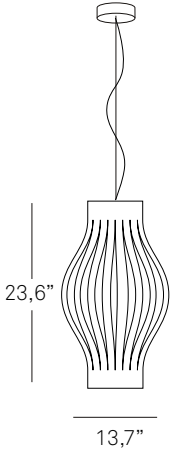
SUSPENSION	INFO	Lamping	Ship Wgt + Dims	Model Specify colour	Size
	<p>Natural wood</p> <p>Canopy: brushed nickel</p> <p>Cord lenght: 6' clear</p> <p>Family susp and table</p> 	 <p>1 x 18 W CFL spiral</p> <p>GU24 base</p>	<p>9 lb 20x20x16"</p>	FAR01 S CHW	







		 <p>1 x 18 W CFL spiral</p> <p>GU24 base</p>	<p>9 lb 20x20x24"</p>	FAR02 S CHW	
--	--	---	---------------------------	--------------------	---

TABLE	INFO	Lamping	Ship Wgt + Dims	Model Specify colour	Size
	<p>Natural wood</p> <p>Cord lenght: 6" clear</p> <p>Family susp and table</p> 	 <p>1 x 18 W CFL spiral</p> <p>GU24 base</p>	<p>5 lb 20x20x24"</p>	FAR02 M CHW	

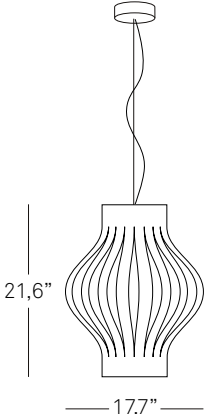

FAROLILLO Bang Design

FAMILY

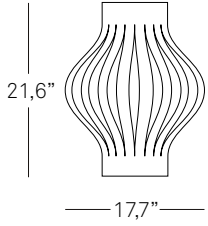
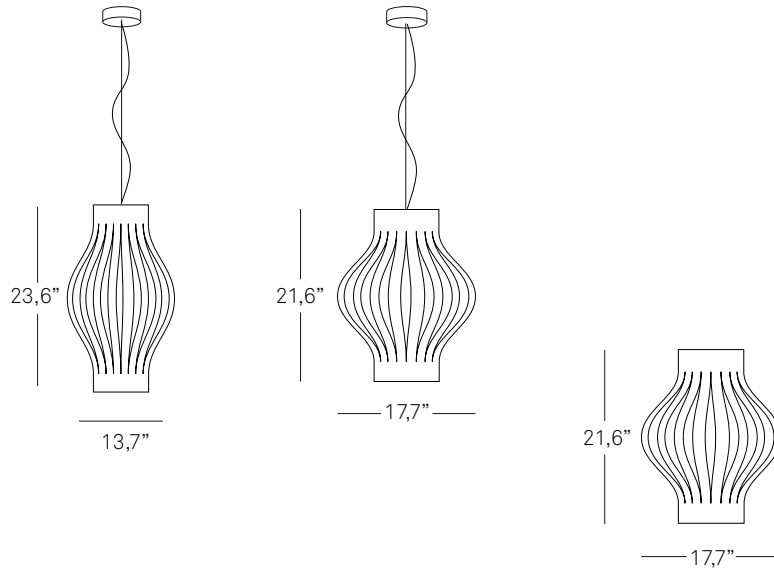

SHADE FINISHES

REF. CHW

Natural timber veneer



CHW-20
American white wood

CHW-25
Orange



CHW-21
Cherry

CHW-26
Red



CHW-22
Beech

CHW-27
Green



CHW-24
Yellow

CHW-29
Grey





FAROLILLO

Bang Design

Born from boyhood memories of adorning the family Christmas tree with “Lantern style” decorations that were somehow reminiscent of archetypal Asian paper lanterns; the Farolillo lamps evoke an universal fondness and familiarity from their elegant form.

The outer-shade is created with a slotted wood veneer cylinder that is secured circumferentially to an internal cylinder-diffuser. This arrangement allows the outer-shade to “billow-out” when compressed, achieving a “lantern shape” that can be played with and ordered, either in a subtle-shallow form or a dramatic-ballooned form.

lzf POWERED BY GlobalLighting

10



Farolillo 1
Bang Design



Farolillo Family
Bang Design



Farolillo
Bang Design