

## FRICITION ADJUSTMENTS

a. After prolonged use, the Ball Joint Swivel/Tilt Mechanism may require increased friction. This can be achieved by tightening the 3 Ball Joint Friction Screws (A) using Hex Key C.

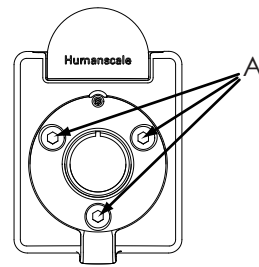

## EXPANDING/COLLAPSING CROSSBAR

- Unfold Crossbar Wings to accommodate 3 or 4 monitors per row.
- Fold away Crossbar Wings to hide behind 1 or 2 monitors.

## PARAMOUNT INSTALLATION HARDWARE

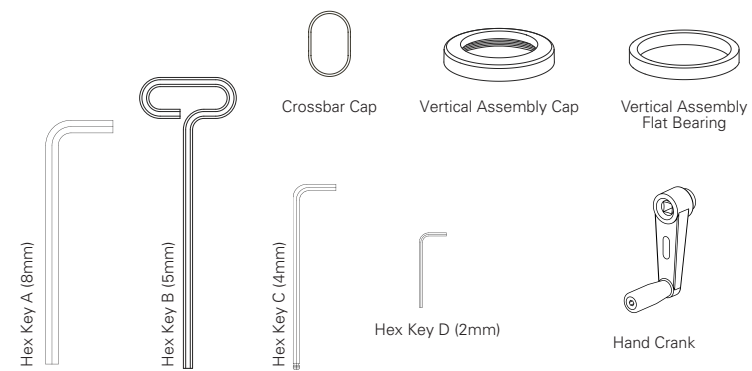

## MOUNTING OPTIONS

### Beam Mount

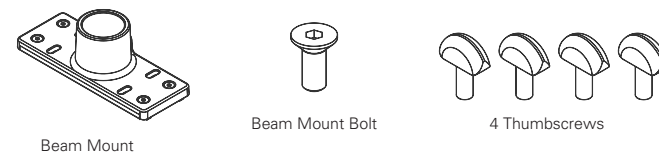

### Slatwall Mount



### Desk Mount

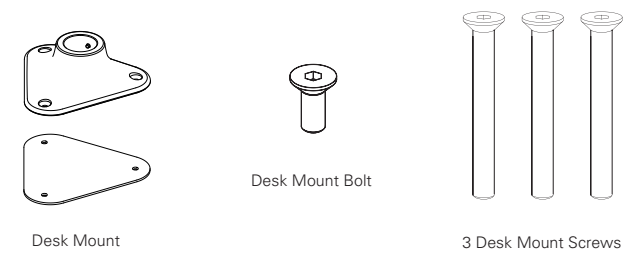

**Additional hardware required: Electric drill with 1/8" drill bit**



[www.humanscale.com](http://www.humanscale.com)

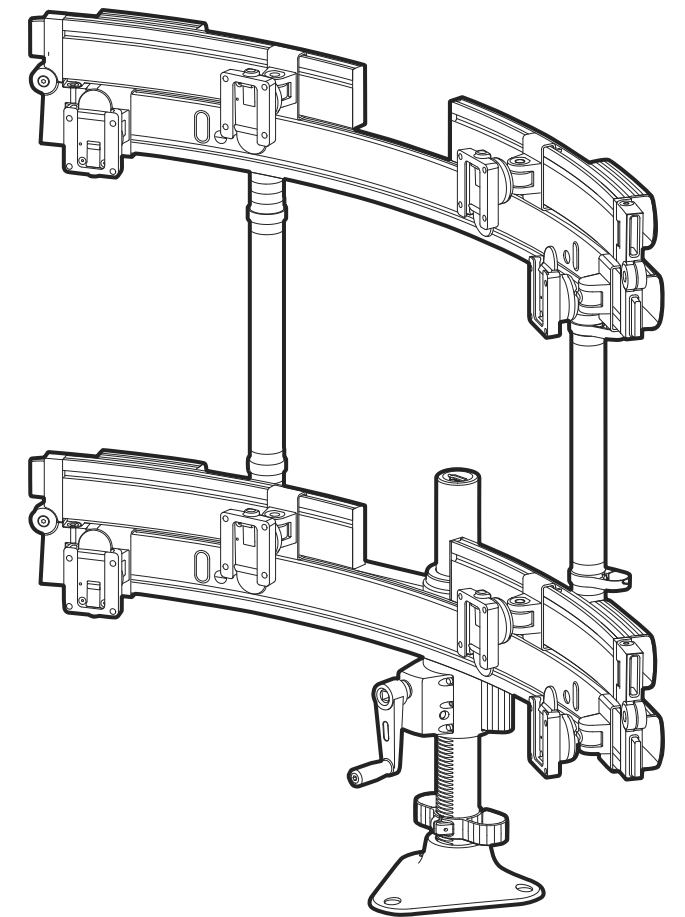

# Paramount Instructions

## STEP 1: ATTACH MOUNT TO WORK SURFACE

### Beam Mount

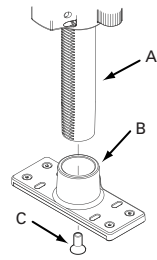

- Slide Vertical Assembly (A) into Beam Mount (B) as shown.
- Fasten Beam Mount Bolt (C) into the underside of Beam Mount using Hex Key A.

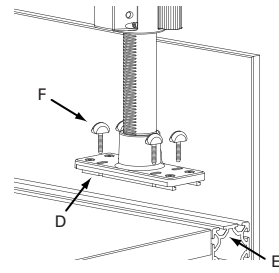

- Insert the lips on the underside of Beam Mount (D) into the slot(s) of systems furniture (E). Push backward to engage.
- Fasten using 4 Thumbscrews (F) provided. Be sure Thumbscrews are fully engaged.

### Desk Mount

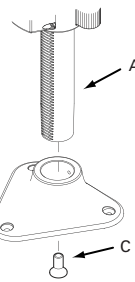

- Slide Vertical Assembly (A) into Desk Mount (B) as shown.
- Fasten Desk Mount Bolt (C) into the underside of Desk Mount using Hex Key A.

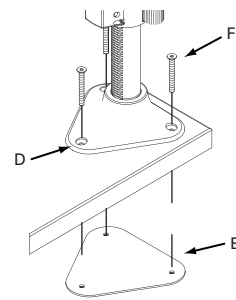

- Place Desk Mount and Vertical Assembly on the desk surface in the desired location.

- Trace the 3 Mounting Holes (D) onto the desk surface. Remove Desk Mount and Vertical Assembly.

- Using an electric drill, drill three 1/2" holes where Mounting Holes were traced.

- Replace Desk Mount and Vertical Assembly on the desk surface. Align holes.

- Place Desk Mount Plate (E) on the underside of the desk and align holes. Fasten using 3 Desk Mount Screws (F) and Hex Key B.

### Slatwall Mount

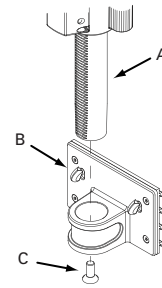

- Slide Vertical Assembly (A) into Slatwall Mount (B) as shown.
- Fasten Slatwall Mount Bolt (C) into the underside of Slatwall Mount using Hex Key A.

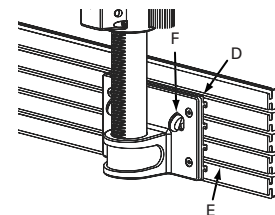

- Insert the lips on the backside of Slatwall Mount (D) into the slot(s) of systems furniture (E). Push downward to engage.

- Fasten using 2 Thumbscrews (F) provided. Be sure Thumbscrews are fully engaged.

## STEP 2: ATTACH FIRST ROW CROSSBAR

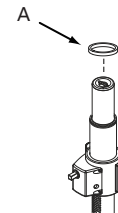

- Slide Flat Bearing (A) onto Vertical Assembly.

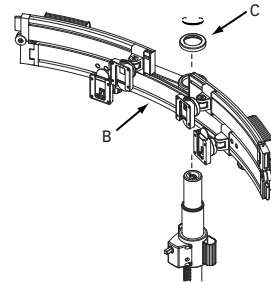

- Slide First Row Crossbar (B) onto Vertical Assembly.
- Fasten Cap (C) to Vertical Assembly.

## STEP 3: ATTACH SECOND ROW CROSSBAR (If Applicable)

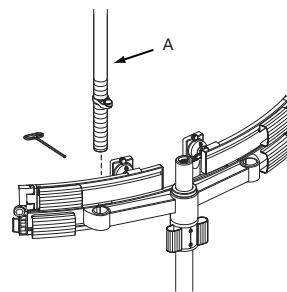

- Slide Second Row Post (A) into First Row Crossbar as shown.

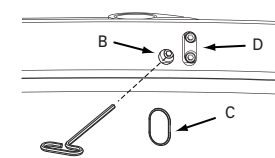

- While holding the post, tighten Clamping Screw (B) using Hex Key B.

- Snap in provided Caps (C) to cover large clamp screw hole (D).

- Repeat previous steps to attach other Second Row Post (C).

- Slide Second Row Crossbar (D) onto Second Row Posts. Tighten all 6 Clamping Screws (E + F).

- Snap in provided Caps (G) to cover large clamp screw hole (F).

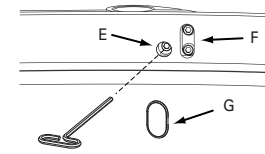

## STEP 4: ATTACH VESA BRACKETS TO MONITORS

- Place VESA Bracket in position on back of monitor with lip (A) toward top of monitor. Attach using 4 VESA Bracket Screws.

*Note: VESA Bracket can accommodate 75mm or 100mm hole patterns. For this, you may also use screws that came with your monitor.*

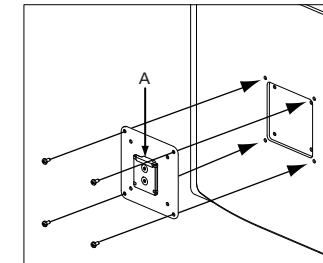

- If mounting space for 75mm VESA Bracket is inset into back of monitor, place the 4 Plastic Spacers (B) between VESA Bracket and monitor. Align with hole pattern and attach using 4 Extended VESA Bracket Screws (C).

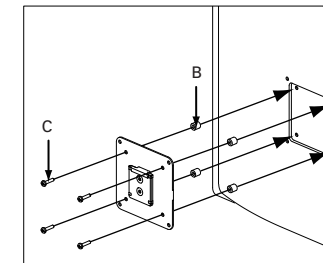

## STEP 5: ATTACH MONITORS TO PARAMOUNT

- Slide VESA Bracket (A) into Ball Joint (B) until it clicks.

- To remove, depress Quick-Release Tab (C) and slide monitor up and away from Paramount.

- Repeat steps for each monitor required.

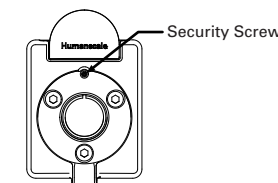
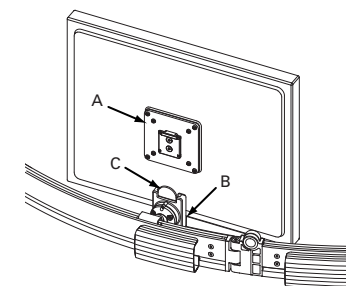

*Note: If security is required, tighten Security Screw using Hex Key D.*

## ADJUSTMENT INSTRUCTIONS

### Main Height Adjustment

- Attach Hand Crank (A), as shown.
- Rotate Hand Crank to adjust Paramount to desired height.

*Note: When not in use, store Hand Crank on Crank Mechanism (B) with the handle turned away.*

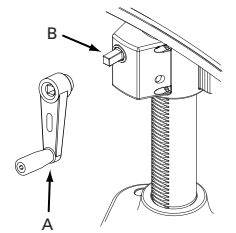

### Second Row Crossbar Height Adjustment

- Remove all but center monitor.
- While holding Second Row Crossbar, loosen bottom Clamping Screws (A) slowly.

- Lower Second Row Crossbar to desired height.

- Continue holding Second Row Crossbar and tighten Clamping Screws.

- If necessary, adjust Second Row Posts individually:

- Loosen top and bottom Clamping Screws for one Second Row Post and adjust to desired height.
- Re-tighten Clamping Screws.
- Repeat with other Post if necessary.

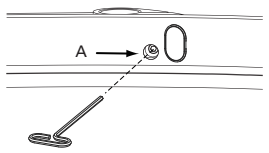
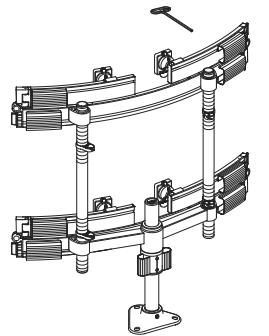

### Lateral Monitor Adjustment

- Push Glider Assembly (A) to desired location.

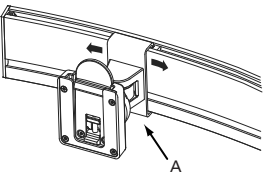

### Individual Monitor Fine Tune Adjustment

- Raise and lower individual monitors by turning Adjustment Screw (A) located under each Ball Joint.

- Using Hex Key C, turn Adjustment Screw clockwise to raise the height of the monitor and counterclockwise to lower the height.

*Note: This can also be done with an electric drill and 4mm Allen drill bit. Adjustment may be easier with monitor removed.*

