

COMBOLIGHT

Mixed Lamp Usage

(MLU) Series

COMBOLIGHT® MLU Series

In today's architectural lighting applications more designers are combining different lamp types, such as AR111 with PAR38 Metal Halide, to suit various display needs.

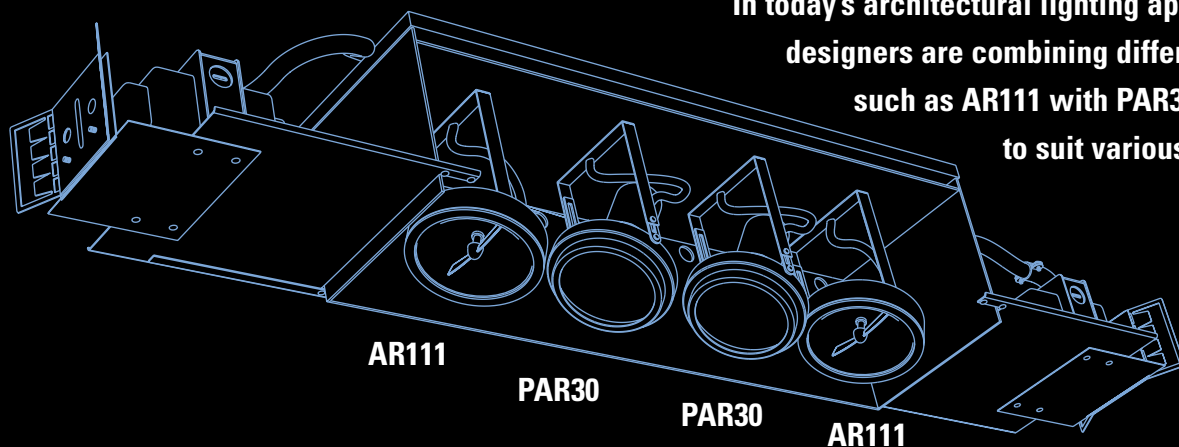

RSA introduces a new series of recessed multi-lamp fixtures to meet this need.

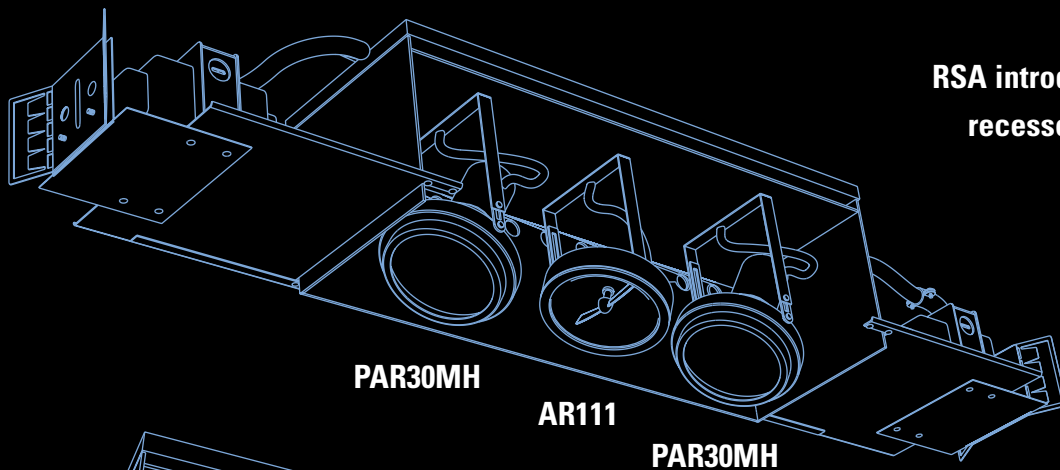

Combolight® MLU Series
Mixed Lamp Usage

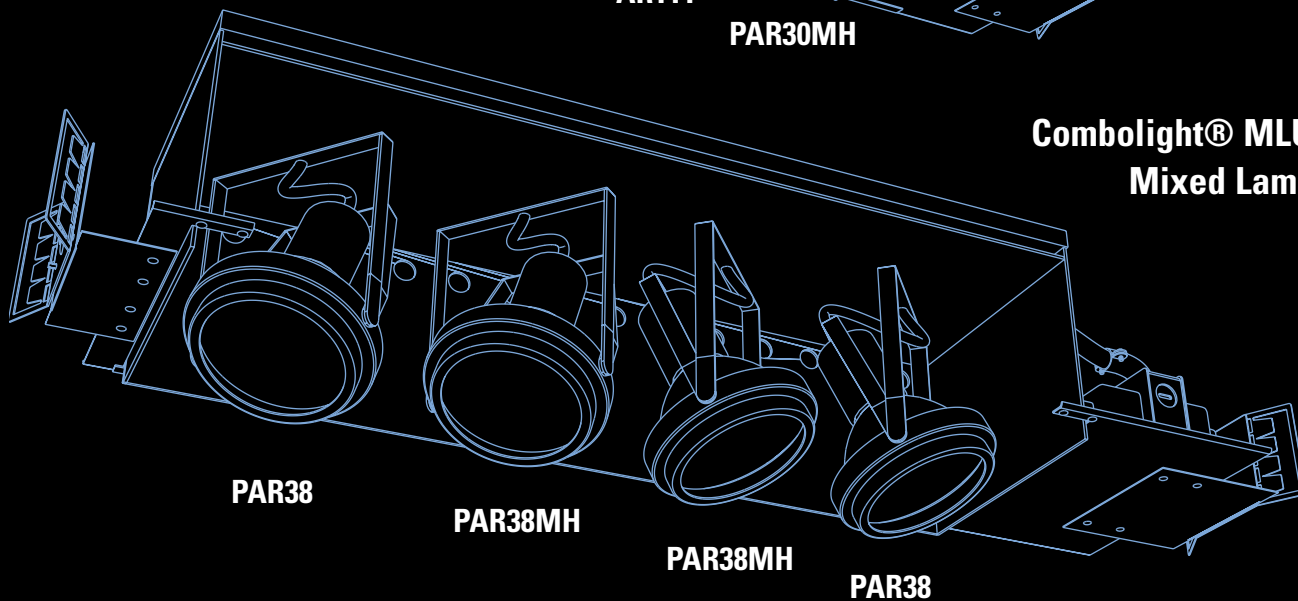

Mixed Lamp Usage

- Standard Combolight Recessed fixtures with the ability to mix various types of halogen, incandescent and metal halide lamp types
- Available in two, three, four, five, six and four light square units
- Available lamps include MR16, AR70, AR111, PAR16, PAR20, PAR20MH, PAR30, PAR30MH, PAR38 & PAR38MH
- Available with integral power supplies (low voltage electronic transformers or Aromat metal halide ballasts)
- Standard or retractable yoke or optional double gimbal lamp holders adjust 90° x 90°
- Custom configurations available. Consult RSA Factory for details.
- Fixture is comprised of sturdy steel construction with a durable powder coat finish inside and out



Mixed Lamp Usage

With the ability to place a variety of lamp types in one fixture the MLU line expands the display illumination possibilities of Combolight®.



Finishes include black, white silver as well as specific custom finishes.



Available lamps include MR16, AR70, AR111, PAR16, PAR20, PAR20MH, PAR30, PAR30MH, PAR38 & PAR38MH

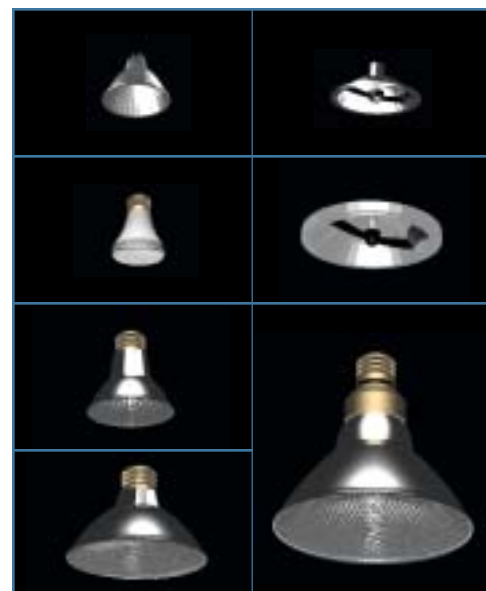



AR111 PAR20MH PAR20MH AR111

MIXED LAMP USAGE LAMP GROUP 2

- Standard new construction fixture with 3/4" Trim or Trimless
- Ability to specify different incandescent, halogen and metal halide lamp types within the same fixture
- Adjustable Plaster Frame can accommodate 1/2" to 1" Ceiling Thickness
- Includes butterfly brackets for black iron installations
- Low voltage models offered with magnetic transformer or electronic transformer with fuse and short circuit protection
- Metal Halide models offered with Aromat® ballasts

Fixture Configuration	A	B	C	Ceiling Cut-out
2 Light Mag. Xfmr.	26.75"	8.20"	13.99"	7.37" x 15.27"
2 Light Elec. Xfmr.	26.75"	8.20"	13.99"	
3 Light Mag. Xfmr.	38.60"	8.20"		7.37" x 22.12"
3 Light Elec. Xfmr.	33.60"	8.20"		
4 Light Mag. Xfmr.	45.45"	8.20"		7.37" x 28.97"
4 Light Elec. Xfmr.	40.45"	8.20"		
5 Light Elec. Xfmr.	47.35"	8.20"		7.37" x 35.87"
6 Light Elec. Xfmr.	54.20"	8.20"		7.37" x 42.72"
4 Light Sq. Mag. Xfmr.	30.94"	8.20"	13.50" ²	14.37" x 14.46"
4 Light Sq. Elec. Xfmr.	25.94"	8.20"	13.50" ²	

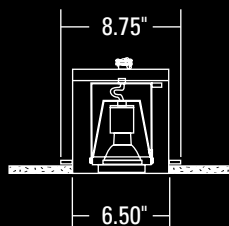
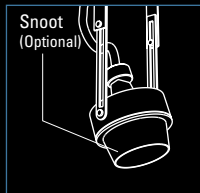
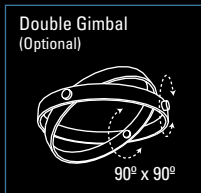
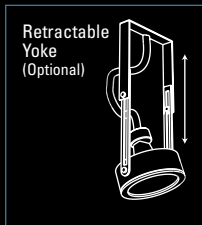

PAR30 MR16 PAR30 MR16

MLU LAMP GROUP 2 AVAILABLE LAMPS

LAMP	DESCRIPTION
	MR16 12 volt 50 watt Order # - MR1650
	MR16 12 volt 75 watt Order # - MR1675
	AR70 12 volt 50 watt Order # - AR7020
	AR70 12 volt 75 watt Order # - AR7050
	AR111 12 volt 35 watt Order # - AR11135
	AR111 12 volt 50 watt Order # - AR11150
	AR111 12 volt 75 watt Order # - AR11175
	AR111 12 volt 100 watt Order # - AR111100
	PAR16 120 volt Order # - PAR16
	PAR20 120 volt Order # - PAR20
	PAR20 Metal Halide 39 watt Order # - PAR20MH39
	PAR30 120 volt Order # - PAR30
	PAR30 Metal Halide 39 watt Order # - PAR30MH39
	PAR30 Metal Halide 70 watt Order # - PAR30MH70

EXAMPLE: Four light Fixture - two PAR20 flanked by two AR111

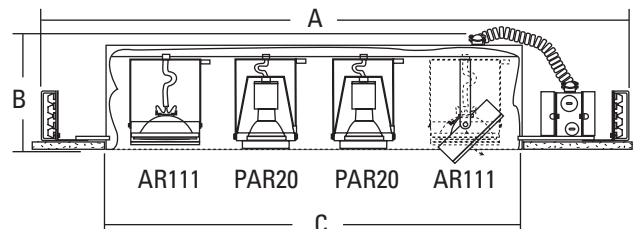

Use only dimmers specifically designed for use with magnetic or electronic transformers. Low voltage fixtures using magnetic transformers may produce audible sound when used with dimmers, which may be objectionable in acoustically critical areas.

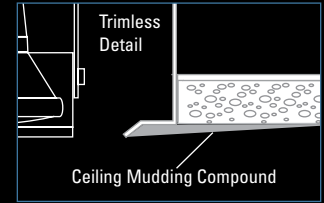
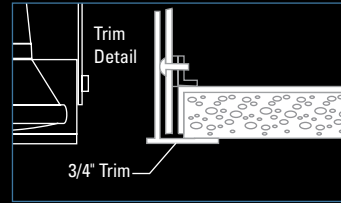

MLU LAMP GROUP 2 ORDERING

FIXTURE TYPE	MLU212 (2) Two Light Mixed Lamps		Available Lamps			
	Cell 1	Cell 2	MR1650	AR11135	PAR20MH39	
	← Specify Lamp Types →		MR1675	AR11150	PAR30	
	MLU213 (3) Three Light Mixed Lamps		AR7020	AR11175	PAR30MH39	
	Cell 1	Cell 2	Cell 3	AR7050	AR11100	PAR30MH70
	← Specify Lamp Types →		PAR16	PAR20	(See previous page for details)	
	MLU214 (4) Four Light Mixed Lamps		← Specify Lamp Types →			
Cell 1	Cell 2	Cell 3	Cell 4			
MLU215 (5) Five Light Mixed Lamps		← Specify Lamp Types →				
Cell 1	Cell 2	Cell 3	Cell 4	Cell 5		
MLU216 (6) Six Light Mixed Lamps		← Specify Lamp Types →				
Cell 1	Cell 2	Cell 3	Cell 4	Cell 5	Cell 6	
MLU222 (4) Four Light Square Mixed Lamps		← Specify Lamp Types →				
Cell 1	Cell 2	Cell 3	Cell 4			

TRIM	Catalog #	Description
	BK	Black Trim
	WH	White Trim
	S	Industrial Silver Trim
	PT	Custom Color (Specify)
	TR	Trimless (NO TRIM)

INTERIOR	Catalog #	Description
	BK	Black
	WH	White
	S	Industrial Silver
	PT	Custom Color (Specify)

LAMP HOLDER	Catalog #	Description
	YK	Regular Yoke
	RT	Retractable Yoke
	DG	Double Gimbal (Lamp holders may not be mixed)

TRANSFORMER	Catalog #	Description
	ELC	Electronic Transformer
	MAG	Magnetic Transformer
		For use with low voltage lamps only. Transformer type may not be mixed

VOLTAGE	Catalog #	Description
	120	120 Volt (Standard)
	277	277 Volt (Voltage may not be mixed)

Optional Accessories - See page 216 for details.

Baffles	Snoots	Louvers	Lenses

Ordering Example	FIXTURE TYPE	LAMP CELL 1	LAMP CELL 2	LAMP CELL 3	LAMP CELL 4	TRIM	INTERIOR	LAMP HOLDER	TRANSFORMER	VOLTAGE
	MLU214	AR11150	PAR20	PAR20	AR11150	WH	BK	RT	ELC	120

Four Light MLU New Construction Fixture, Two AR111 / Two PAR20, White Trim, Black Interior, Retractable Yoke, Electronic Transformer, 120 Volt



PAR38

PAR20

PAR38

PAR20

MIXED LAMP USAGE LAMP GROUP 3

- Standard new construction fixture with 3/4" Trim or Trimless
- Ability to specify different incandescent, halogen and metal halide lamp types within the same fixture
- Adjustable Plaster Frame can accommodate 1/2" to 1" Ceiling Thickness
- Includes butterfly brackets for black iron installations
- Low voltage models offered with magnetic transformer or electronic transformer with fuse and short circuit protection
- Metal Halide models offered with Aromat® ballasts

Fixture Configuration	A	B	C	Ceiling Cut-out
2 Light Mag. Xfmr.	29.80"	9.10"	17.79"	9.37" x 18.32"
2 Light Elec. Xfmr.	29.80"	9.10"	17.79"	
3 Light Mag. Xfmr.	38.60"	9.10"		9.37" x 27.17"
3 Light Elec. Xfmr.	33.60"	9.10"		
4 Light Mag. Xfmr.	45.45"	9.10"		9.37" x 36.07"
4 Light Elec. Xfmr.	40.45"	9.10"		
5 Light Elec. Xfmr.	61.40"	9.10"		9.37" x 44.92"
6 Light Elec. Xfmr.	70.30"	9.10"		9.37" x 53.82"
4 Light Sq. Mag. Xfmr.	39.94"	9.10"		18.37" x 18.46"
4 Light Sq. Elec. Xfmr.	34.94"	9.10"	17.50" ²	

Retractable Yoke (Optional)



Double Gimbal (Optional)

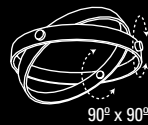

Snoot (Optional)

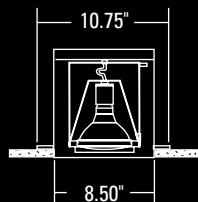

PAR38MH

AR111

AR111

PAR38MH

MLU LAMP GROUP 3 AVAILABLE LAMPS

LAMP	DESCRIPTION
	MR16 12 volt 50 watt Order # - MR1650
	MR16 12 volt 75 watt Order # - MR1675
	AR70 12 volt 20 watt Order # - AR7020
	AR70 12 volt 50 watt Order # - AR7050
	AR111 12 volt 35 watt Order # - AR11135
	AR111 12 volt 50 watt Order # - AR11150
	AR111 12 volt 75 watt Order # - AR11175
	AR111 12 volt 100 watt Order # - AR111100
	PAR16 120 volt Order # - PAR16
	PAR20 120 volt Order # - PAR20
	PAR20 Metal Halide 39 watt Order # - PAR20MH39
	PAR30 120 volt Order # - PAR30
	PAR30 Metal Halide 39 watt Order # - PAR30MH39
	PAR30 Metal Halide 70 watt Order # - PAR30MH70
	PAR38 120 volt Order # - PAR38
	PAR38 Metal Halide 70 watt Order # - PAR38MH70
	PAR38 Metal Halide 100 watt Order # - PAR38MH100

EXAMPLE: Four light Fixture - two AR111 flanked by two PAR38MH

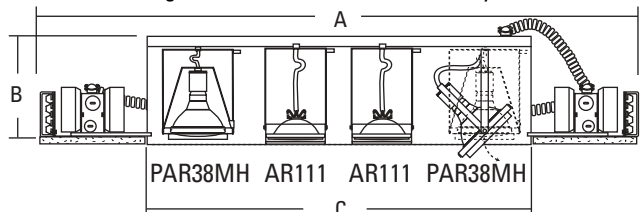

Use only dimmers specifically designed for use with magnetic or electronic transformers. Low voltage fixtures using magnetic transformers may produce audible sound when used with dimmers, which may be objectionable in acoustically critical areas.

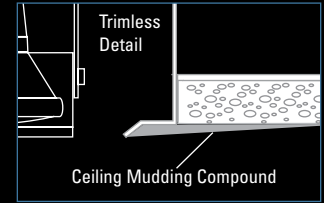
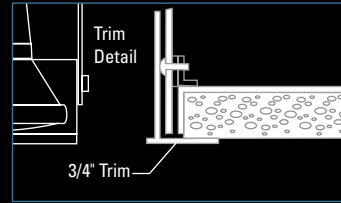

MLU LAMP GROUP 3 ORDERING

FIXTURE TYPE	MLU312 (2) Two Light Mixed Lamps		Available Lamps			
	Cell 1	Cell 2	MR1650	AR11135	PAR20MH39	
	← Specify Lamp Types		MR1675	AR11150	PAR30	
	MLU313 (3) Three Light Mixed Lamps		AR7020	AR11175	PAR30MH39	
	Cell 1	Cell 2	Cell 3	AR7050	AR111100	PAR30MH70
	← Specify Lamp Types		PAR16	PAR20	PAR38	
			(See previous page for details)		PAR38MH70	
				PAR38MH100		
MLU314 (4) Four Light Mixed Lamps		← Specify Lamp Types				
Cell 1	Cell 2	Cell 3	Cell 4			
MLU315 (5) Five Light Mixed Lamps		← Specify Lamp Types				
Cell 1	Cell 2	Cell 3	Cell 4	Cell 5		
MLU316 (6) Six Light Mixed Lamps		← Specify Lamp Types				
Cell 1	Cell 2	Cell 3	Cell 4	Cell 5	Cell 6	
MLU322 (4) Four Light Square Mixed Lamps		← Specify Lamp Types				
Cell 1	Cell 2					
Cell 3	Cell 4					

TRIM	Catalog #	Description
	BK	Black Trim
	WH	White Trim
	S	Industrial Silver Trim
	PT	Custom Color (Specify)
	TR	Trimless (NO TRIM)

INTERIOR	Catalog #	Description
	BK	Black
	WH	White
	PT	Custom Color (Specify)

LAMP HOLDER	Catalog #	Description
	YK	Regular Yoke
	RT	Retractable Yoke
	DG	Double Gimbal (Lamp holders may not be mixed)

TRANSFORMER	Catalog #	Description
	ELC	Electronic Transformer
	MAG	Magnetic Transformer
		For use with low voltage lamps only. Transformer type may not be mixed

VOLTAGE	Catalog #	Description
	120	120 Volt (Standard)
	277	277 Volt (Voltage may not be mixed)

Optional Accessories - See page 216 for details.

Baffles	Snoots	Louvers	Lenses

Ordering Example									
FIXTURE TYPE	LAMP CELL 1	LAMP CELL 2	LAMP CELL 3	LAMP CELL 4	TRIM	INTERIOR	LAMP HOLDER	TRANSFORMER	VOLTAGE
MLU314	PAR38MH70	AR11175	AR11175	PAR38MH70	WH	BK	RT	ELC	120

Four Light MLU New Construction Fixture, Two AR111 / Two PAR20, White Trim, Black Interior, Retractable Yoke, Electronic Transformer, 120 Volt