

# 2010 Professional Installation Handbook



Mannington Mills, Inc.,  
P.O. Box 30, Salem, NJ 08079  
Mannington.com  
1-800-FLOOR-US (356-6787)

# Welcome

Welcome to another new edition of the Mannington Professional Installation Handbook. This Guide has been created for installers and specifiers of Mannington floor covering products. It will prove especially helpful to those who require a basic knowledge of products and how to install those products properly.

Our commitment is to provide comprehensive information to assist you in performing the best installation possible. Only by helping you perform at your best can we obtain optimum results and the longest performance life for our floor covering products.

Mannington strongly recommends following all the directions and advice we have so carefully researched and provided for you in this new handbook. We have based all of our instructions on industry-accepted recommendations. Also, regular field testing of our products and their installation systems produces important real-world experience. These kinds of helpful hints have been included for your help.

## Talk To Us

We always enjoy hearing from our installers and specifiers. If you have ideas on how we can make this handbook better for you, contact us. Remember, we are trying to help you provide the best installation possible for your customers. We know how important honest, hard work is in today's business world. You can contact us by calling our Customer Care Department at 1-800-FLOOR-US (356-6787).

## Important Notice to Floor Covering Installers

If it becomes necessary to remove any resilient floor covering materials containing asbestos, it is important to recognize that governmental regulations apply. Please also be aware that governmental regulations involving the removal of existing asbestos-containing materials vary from state to state.

Always exercise safeguards to protect yourself and others on the job site.

Mannington recommends that whenever possible, new wood panel underlayment be installed over existing resilient floor covering. Mannington Embossing Leveler is an alternative. Removal of existing floor covering should only be done as a last resort.



**DANGER: Do not sand, dry sweep, dry scrape drill, saw, beadblast, or mechanically chip or pulverize existing resilient flooring, backing, lining felt or asphaltic "cutback" adhesives. These products may contain either asbestos fibers or crystalline silica. Avoid creating dust. Inhalation of such dust containing respirable fibers or crystalline silica may cause cancer and respiratory tract diseases. Smoking by individuals exposed to asbestos fibers greatly increases the risk of serious bodily harm. Unless positively certain that the product is a nonasbestos-containing material, you must presume it contains asbestos. Regulations may require that the material be tested to determine asbestos content.**

For specific instructions on how to remove existing resilient floor covering, consult this handbook, or refer to the Resilient Floor Covering Institute's brochure, *Recommended Work Practices for Removal of Resilient Floor Coverings*.

# Table of Contents

Introduction . . . . .	4	Laminate Installation Guide . . . . .	79
General Installation Guidelines . . . . .	6	Porcelain Installation Guide . . . . .	92
Choosing the Correct Underlayment Panel . . . . .	10	Commercial . . . . .	102
Residential Resilient Installation Guide . . . . .	14	Commercial Resilient Sheet and Modular Installation Guide . . . . .	103
Residential Triple Option Installation . . . . .	16	Commercial Vinyl Composition Tile and Premium Tile Installation Guide . . . . .	114
Sobella Installation Guide . . . . .	25	Commercial Luxury Vinyl Tile Floors Installation Recommendations . . . . .	118
Residential Perimiflex Installation System for Aurora Flex . . . . .	32	iCore® II Installation Guidelines . . . . .	123
Adura Installation Guide . . . . .	43	Installation Accessories . . . . .	127
Residential Resilient Installation Accessories . . . . .	52		
Hardwood Installation Guide . . . . .	59		
LocNGo Wood Installation . . . . .	75		

## How to use this Guide

We have included many handy features in the Guide to help you find the information you need more quickly and easily. To begin, you will notice a block of grey tabs along the side of each page indicating the name of the chapter. This will be very helpful when you wish to quickly thumb through the Guide to find a particular section.

Throughout the Guide you will also notice three icons. Each denotes the type of message that follows it.



**NOTE:** A helpful hint or words of wisdom from Mannington to achieve optimum results.



**CAUTION:** A cautionary direction that should be followed before proceeding with the application or job at hand.



**DANGER:** A warning of possible danger or bodily harm.

All the information contained in this handbook pertains to Mannington floor covering products. It is based on industry-accepted recommendations established by various trade organizations and on thorough field testing of various products and their installation systems. This information is also based on the most up-to-date technical information available. We are constantly striving to improve, standardize, and simplify all aspects of flooring installation as new products and procedures are developed. As the professional installer or specifier, it is your responsibility to remain current regarding recommendation for suitability of intended use of our floor covering products and their required installation systems. One last advisory note: Always use Mannington recommended adhesives, seam sealers and floor patching products.

As you might understand, it is not possible to cover all situations or conditions relevant to the installation of flooring. Final decisions and responsibility for each specific installation rest with the floor covering contractor. If you encounter any unusual situations or conditions, stop the installation immediately and contact your local Mannington Distributor, Mannington Regional Installation Specialist, or call Mannington Customer Care at 1-800-FLOOR-US.

# Introduction

No floor covering material is functional until it is installed into a location. The skill with which this material is fit into the location and the overall condition of the location greatly influences the appearance and the performance of the floor-covering material. Additionally, the type of floor-covering material selected must be appropriate for the intended use. Therefore, it is absolutely critical that sufficient consideration is given to these factors. This is the intent of this *Professional Installation Handbook*. Although this handbook cannot possibly cover every possible situation nor answer every specific floor covering question, it can provide general guidelines and references to enable installers, sales representatives and product specifiers to make solid decisions regarding the floor covering process.

Mannington Mills, Inc. is a manufacturing company that offers a full array of flooring products that provide alternatives and solutions for both residential and commercial flooring customers. The utmost care and sophisticated process control systems are incorporated into our manufacturing activities. In fact, both the commercial Inlaid and VCT plants in Salem, NJ are ISO 9001 certified, and our laminate plant in High point, NC is also ISO 9001 certified. This ISO certification carries a requirement that the manufacturing processes from raw materials through finished inventories be routinely audited as a provision for maintaining this ISO certification. In addition, both our commercial and residential operations in Salem, NJ and our Carpet plant in Calhoun, GA are ISO 14001 certified. These certifications ensure our Environmental Management Systems are part of everyday business from design through manufacturing of our products. We are constantly exploring ways to improve our products and manufacturing technologies to reduce our environmental footprint, increase resource efficiency, cut waste, and improve the use of recycled materials.

This commitment to quality and the environment in manufacturing should be evident in the floor covering products we supply.

We expect these flooring products to be installed with the same commitment to quality. The professional installer should ultimately be the last inspector of the quality of any finished flooring products and should never install a product with a visible defect.

Additionally, professional flooring installers should abide by the following guidelines:

- Conduct their business as professionals and secure all required licenses, permits, insurances and applicable tax identification numbers.
- Present themselves as professionals, in both appearance and deed, to all business associates.
- Follow all Mannington- and industry-established recommendations regarding installation requirements and work practices.
- Install products and perform installation techniques with which they are knowledgeable, trained and truly competent.

### Basic Guidelines

Regardless of the type of hard-surface flooring product being installed, the following basic guidelines should be considered to insure a successful installation. In the event that there is a flooring complaint, more often than not, one or more of these six essential guidelines was ignored or not properly completed.

1. Proper storage, handling and transporting of materials
  - Interior storage location – protected from the weather
  - Do not overstack – protect from forklift traffic
  - Fully support product during transportation
2. Job site conditions
  - Interior locations only (Exception – thru body Porcelain)
  - Permanent HVAC, operational and regulated
  - Dry, secure; all windows and doors installed and operable
3. Subfloor selection and preparation
  - Clean, dry and structurally sound
  - Concrete subfloors tested for moisture (MVT)
  - Wood subfloors covered with appropriate underlayment
4. Product cutting and fitting
  - Material layout is aligned in correct position and balanced
  - Appropriate tools and equipment are available and maintained
  - Craftsmanship is exhibited and evident in fit and function
5. Securing the flooring
  - Correct adhesives are selected and applied in correct amounts
  - Fasteners are of sufficient length and specifically designed for this purpose
  - Proper moldings and transitions are used (even in “floating” installations)
6. Seam alignment and treatment
  - By definition – a seam is a line of junction
  - All flooring products have the probability of seams
    - Tile products – tight, square and true
    - Wood and Laminate – tight, straight and properly positioned
    - Porcelain – fully grouted and sealed
    - Resilient – Strategically placed and properly sealed
  - Minimize complexity of design and layout

# General Installation Guidelines

These guidelines are relevant for all types of floor coverings. Although there may be some specific requirements detailed for specific product categories, the information provided in this section should be considered before beginning any flooring installation.

## Storage

All floor covering products require care during storage and handling. It is important to store flooring products in a dry, temperature-controlled interior area. The temperature range should be between 65° F and 100° F, and the relative humidity should be controlled and maintained between 30% to 70%. If it is not possible to provide these storage conditions, you must make provision to have the material conditioned for at least 48 hours before beginning the installation.

Roll sheet goods must be stored tightly rolled, face-out on a sturdy cardboard core. Resilient products 12' wide must be stored horizontally and fully supported across their entire width. Six-foot wide rolls may be stored standing on edge in a protected area. It is important to comply with these storage recommendations to prevent compression or distortion of the rolls.

Flooring materials that are shipped in cartons must also be stored properly. These cartons must be kept squarely positioned on the pallet to prevent distortion of the contents and to be fully supported. Stored cartons are to be protected from forklift and other traffic that can damage carton corners. Never double-stack pallets of flooring products. Check specific product instructions to determine maximum carton stacking on pallets.

## Handling

Flooring products can be heavy and bulky. Always use proper material-handling equipment when moving these products. Always use proper lifting techniques and never lift more than you can safely handle. Fully support products during transportation. Distribute the load as evenly as possible in the truck.

Flooring products can be damaged by rough handling before installation. Exercise care when handling and transporting these products.

## Pre-Installation Checklist

Before starting the job, always check the flooring materials to ensure they are the correct pattern, style and color. Also make certain that the correct amount of product is available to complete the job.

Remember to thoroughly inspect all materials for visible defects. **Mannington Mills, Inc will not pay labor charges on claims filed for materials installed with obvious visible defects.** If you discover visible defects, do not proceed with the installation; contact your material provider for assistance.

Be certain to thoroughly understand the requirements of the installation with regard to seam placement, product layout, plank direction, etc. before starting the job.

Be certain to have all necessary and correct adhesives, seam treatments, moldings and trims available on the before beginning the job.

Be certain to have a thorough understanding of the scope of the project and the expectations of time of completion before starting the job.

## General Installation Guidelines (continued)

### Job Site Conditions

The environment and condition play a very important role in assuring a successful flooring product installation. If the job site is not climate-controlled or structurally sound, the chances for a successful flooring installation are dramatically reduced. All Mannington products are designed to be installed in climate controlled interior locations.

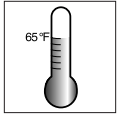

### Temperature and Humidity Requirements

Do not install floor covering products until the work area can be climate controlled. The recommended temperature range for starting the installation is no cooler than 65° F and no warmer than 100° F. This acceptable climatic condition must be maintained for at least 48 hours before, during and after the installation. This requirement can seldom be fulfilled with temporary space heaters or air conditioners. A permanent, operational heating or cooling system should be operational before proceeding with the installation of the flooring products.

Once the floor covering is installed, the temperature of the location should not be allowed to fall below 55° F or exceed 100° F for the life of the floor covering. Failing to maintain a climate-controlled interior environment will adversely affect the performance of the flooring products and/or the adhesives.

### Structural Requirements

The structural integrity of the job site is a critical component to the performance of the floor covering. The type and method of construction, the grade level, the subflooring system, and composition all impact the installation of flooring products. Many times local building codes establish only minimum requirements and these construction practices may not result in sufficient rigidity, flatness or smoothness.

Structural subflooring systems are constructed of either concrete (or cement-like materials) or wood. The description of each of these subfloor constructions that are referred to in this handbook are provided to give professional flooring installers enough information to make intelligent decisions regarding the suitability of the subfloor systems they may encounter. For comprehensive information, contact The American Concrete Institute or The American Plywood Association about their respective products.

## Subfloor Recommendations and Preparation

### Concrete Subfloors

New and existing concrete subfloors should meet the requirements prescribed in the latest edition of ASTM F 710, "Standard Practice for Preparing Concrete Floors to Receive Resilient Flooring." Although this practice specifically addresses preparing the concrete substrate to receive resilient flooring, the requirements are appropriate for all Mannington floors.

Concrete subfloors must be permanently dry, clean, smooth, flat and structurally sound. Concrete subfloors on or below grade must have an acceptable vapor retarding membrane to isolate the concrete from the soil. Newly poured concrete, regardless of grade level, must be given ample time to cure and fully dry. Drying times for concrete slabs vary greatly depending on mix, atmospheric conditions, construction practices and location of slab.

Concrete subfloors must have a minimum compressive strength of 3000 PSI and a dry density of at least 100 pounds per cubic foot. The concrete surface must be free of surface defects or surface contaminants. Surface defects include cracks, holes, flaking or dusting of the concrete surface. Surface contaminants should be considered as any substance that will interfere with the bond of the floor covering to the subfloor, such as curing or parting compounds, paints, oils, solvents or existing adhesives.

Surface defects must be corrected before installing any finished flooring product. Low spots, cracks, holes and other irregularities can be patched smooth using a latex Portland cement compound designed for this purpose.

## General Installation Guidelines (continued)

Mannington MVP-2023 patching compound is ideal for this type of surface preparation. If the surface of the concrete is found to be flaking or dusting, these conditions must be mechanically removed and the concrete then re-surfaced with an appropriate compound. All surface contaminants that may interfere with bond must also be mechanically removed and then be re-surfaced before installing any flooring product which requires a direct glue-down procedure. Mannington does not recommend using any chemicals or solvents to remove concrete surface contaminants.

Many concrete slabs will have joints designed in to them. Expansion and isolation joints are designed to allow the concrete slab to expand and contract. These expansion joints must never be filled with patching or leveling compound nor covered with hard surface flooring products. Expansion joint covers are available and designed to be used with specific types of floor covering products. Other types of concrete joints such as construction, control and/or saw cuts can be smoothed and leveled using an appropriate Portland cement patching compound like Mannington MVP-2023.



### Moisture Testing

Regardless of the time in place or the grade level, all concrete subfloors must be tested for moisture and alkalinity before covering with flooring products. Although nearly each product type in each product category has a different tolerance for permissible moisture vapor emissions, it is important to have a quantitative reading to be able to resolve any potential problems before, rather than after the fact. The most common quantitative moisture test is the Anhydrous Calcium Chloride test. This test must be performed in accordance with ASTM F 1869-04, "Standard Test Method for Measuring Moisture Vapor Emissions Rate of Concrete Subfloor Using Anhydrous Calcium Chloride." According to the ASTM, the moisture emissions from the concrete floor shall not exceed 3 lbs/1000 sq. ft./24 hours. At least one test kit should be used in areas up to 1000 sq. ft. Additional kits should be used in larger areas. Certain Mannington Flooring products can tolerate up to 8 lbs of moisture vapor emission. The acceptable moisture tolerance rates for Mannington flooring products are:



Calcium Chloride Test Kit

Flooring Product	RH%	MVER	RH% / M-Guard Adhesive	MVER/M-Guard Adhesive
Residential Cushioned Vinyl	≤75%	3 lbs.	NA	NA
Aura Luxury Vinyl Homestead	≤75%	5 lbs.	NA	NA
Laminate Floors w AquaBarrier II	≤75%	5 lbs.	NA	NA
Hardwood –fully adhered with UltraSpread – floated over AquaBarrier II	≤75%	5 lbs.	NA	NA
Fine Fields; Magna	≤75%	5 lbs.	NA	NA
CustomSpec; Insight	≤75%	3 lbs.	NA	NA
VCT & PT products.				
Essentials: Designer Essentials; Inspirations; Brushworks; Solid Point; Color Point Safewalks	≤75%	5 lbs.	≤ 85 % M-Guard V-11	≤ 8 lbs. M-Guard V-11
BioSpec; Lifelines: Relay RE; Assurance II; Assurance Squared; Natures Paths Realities; Primus	≤75%	3 lbs.	≤ 80 % M-Guard V-68	≤ 8 lbs. M-Guard V-68



## General Installation Guidelines (continued)

Another quantitative moisture test method is the In Situ Relative Humidity test. This test measures the relative humidity level within the concrete slab. This test must be performed in accordance with ASTM F 2170. The relative humidity of the slab must not exceed 75%. If the relative humidity in the slab exceeds 75%, **do not install any Mannington Floor Coverings.** (Unless an approved moisture resistant adhesive is used.)

### Moisture Meters

There are many manufacturers of quality moisture reading devices. However, there is no standard correlation between the meter reading and the calcium chloride or the relative humidity test methods. Each meter is calibrated to its own scale and must be interpreted as directed by the manufacturer.

### Concrete Curing, Hardening, Sealing and Parting Compounds

Often, various compounds will be added in the concrete mix or applied to the surface of the freshly placed concrete to assist in the curing process. These compounds may interfere with the bond of any fully-adhered flooring product. If any of these surface compounds is suspected to remain on the surface, they must be removed by grinding, scarifying or bead blasting.



### Alkali Testing

A pH test should be conducted on all concrete floors, regardless of the age or the grade level. The test is performed using a wide range pH paper and distilled water. Puddle the water on the surface of the concrete for a minimum of 60 seconds and then dip the pH paper into the water. The acceptable pH range is between 5 to 10 on the pH scale. If the pH is greater than 10, it must be reduced before proceeding with any fully-adhered flooring product installation.

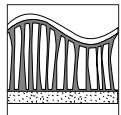

### Bond Testing

If the surface of the concrete shows any evidence of contamination, or if the history of the concrete is unknown, a bond test should be performed before beginning the flooring installation. To conduct a bond test select approximately a 3' X 3' piece of the exact flooring product specified for the job and adhere it to the subfloor with the exact adhesive that will be used during installation. On large installations, conduct several bond tests. After 72 hours attempt to remove the test sample. If sufficient force must be used to remove the sample, you may consider the concrete suitable for installation.

### Residual Adhesive

Completely remove all residual adhesives on a previously covered concrete underfloors or cover them with a cementitious underlayment intended for this purpose. Never use solvent-based adhesive removers. Complete removal of all residual solvent is very difficult. Any remaining on the surface of the concrete will prohibit satisfactory bond of the new adhesives. Complete removal of asphalt cutback or asphalt emulsion adhesive from a concrete underfloor is nearly impossible. Wet-scrape these adhesives from the concrete. Then cover the concrete with a minimum of 1/8" of a trowelable or self-leveling cementitious underlayment intended for this purpose. Mannington MVP 2023 may be used to cover residual adhesive stainants on concrete underfloors.



**DANGER: Older asphalt adhesives may contain asbestos fibers. Do not use power devices that create asbestos dust in removing these adhesives. The inhalation of asbestos dust may cause bodily harm. Smoking by individuals exposed to asbestos fibers greatly increases this risk.**

## General Installation Guidelines (continued)

### Wood Underfloors

All wood subfloor systems should be suspended at least 18" above the ground with adequate cross-ventilation. Cover the ground surface of crawl spaces with a suitable vapor barrier. All wood subfloors must be structurally sound, dry, and in compliance with local building codes. Wood subfloors should be of double-layer construction at least 1" in total thickness, solidly fastened to appropriately spaced floor joists.

**!** **CAUTION: Wood subfloors directly fastened to concrete or built using sleeper construction, either with on- or below-grade concrete subfloors, are not satisfactory for the installation of fully-adhered floor covering products. This non-ventilated construction practice will result in deterioration of the wood subfloor system.**

### Double Plywood Subfloors

Double-layered plywood subfloors should have a first layer at least  $\frac{5}{8}$ " thick and a second layer at least  $\frac{3}{8}$ " thick, with staggered panels and overlapping joints. Install the long dimension of these panels perpendicular to the floor joists. Panels that carry the American Plywood Association (APA) performance rating of Sturd-I-Floor were designed as combination subfloor/underlayment panels. Field experience, however, has determined these panels are rarely satisfactory for direct installation of Fully Adhered resilient products. In most instances, construction traffic and weather exposure damage the Sturd-I-Floor surface before the finished flooring can be installed. If you encounter this situation, Mannington recommends installing  $\frac{1}{4}$ " underlayment panels.

### UNDERLAYMENT CHART

Type	Manufacturer	Thickness	Dimensions	Warranty	General Comments	Availability
Accuply	Halex Corp.	6 mm	4' x 5'	Limited lifetime warranty	Solid core 5-ply birch. Additional Info: (800) 576-1636	Canada USA
APA underlayment, APA CC plugged, APA underlayment CC plugged, APA AC, BC, AD & BD, APA underlayment AC or BC	Varies	1/4" 11/32" 15/32"	4' x 8'	No warranty - panels manufactured to industry underlayment standards PS1	Construction and industrial plywood. Additional Info: (253) 620-7400	Canada USA Mexico
APA-rated Sturd-I-Floor with sanded face	Varies	19/32", 5/8" 23/32" 3/4", 1" 11/8"	4' x 8'	No warranty - panels manufactured to industry underlayment standards PS1	Construction and industrial plywood. Additional Info: (253) 620-7400	Canada USA Mexico
Halex HU 845	Halex Corp.	6 mm 9 mm	4' x 5'	10-year limited warranty	Solid core arctic birch. Additional Info: (800) 576-1636	Canada USA
Lauan-Type I Ext. (facegrades-OVL, CC, BB)	Varies (usually imported)	Min. 5.2 mm	4' x 8'	Check with supplier	Most panels are an imported lauan substitute.	Canada USA Mexico

# General Installation Guidelines (continued)

## UNDERLAYMENT CHART

Type	Manufacturer	Thickness	Dimensions	Warranty	General Comments	Availability
Multi-ply Underlayment	Halex Corp.	1/4"	4' x 4'	10-year limited warranty	Premium quality hardwood veneers. Additional Info: (800) 576-1636	Canada USA
National Particleboard Association Grade 1-M-1	Varies	1/4" to 3/4" ≤	4' x 8'	No warranty - M-1 grade meets ANSI standard A208.1 underlayment ref. ICBO, SBCCI, BOCA	Particles of wood bonded w/synthetic resins under heat & pressure. Additional Info: (301) 670-0604	Canada USA Mexico
Proboard Plus	Proboard Ltd.	6.0 mm	4' x 8'	1-year limited warranty	Particles of wood bonded with synthetic resins under heat & pressure. Additional Info: (807) 597-6921	Canada
Riverside ULAY	Riverside Forest Products Ltd.	6.0 mm	4' x 4' 4' x 8'	7-year limited warranty	Specially mfd. plywood panel provides superior underlayment performance for resilient floor covering (250) 545-4411	Canada USA
Southern Gold A-C Pine Plywood	Georgia-Pacific	1/4" 11/32" 15/32" 19/32" 23/32"	4' x 8' avail. all loc. Crosset AR 4' x 9' 4' x 4'	No warranty - panels manufactured to industry underlayment standards PS1	Pine plywood with double sanded face. Additional Info: (800) 284-5347	Canada USA Mexico
Southern Gold Premium Sturd-I-Floor	Georgia-Pacific	11/32" 15/32" 19/32" 23/32"	4' x 8'	No warranty - panels manufactured to industry underlayment standards PS1	Construction & industrial plywood with fully sanded face. Additional Info: (800) 284-5347	Canada USA Mexico
SurePly Premium Underlayment	Patriot Timber Products International	1/4"	4' x 4' 4' x 8'	Limited lifetime warranty	Solid core 5 ply Birch construction (336) 299-7755	Canada USA
TECPly Brand Plywood	Plywood & Door Manufacturing Corp.	5.2 mm	4' x 8' 4' x 4'	10-year limited warranty	5-ply arctic white birch with exterior glue. Additional Info: (908) 687-7890	Canada USA Mexico
UltraPly	Moreland Co.	5.5 mm	4' x 8'	10-year limited warranty	Hardwood construction with solid core and exterior glue. Additional Info: (800) 397-7769	USA



**NOTE:** This information is provided for reference only. It must not be interpreted as an endorsement or warranty for any listed panel.

## General Installation Guidelines (continued)

### Existing Floor Coverings

In some cases, you may install Mannington products over a single layer of existing floor coverings. **Installing Mannington Commercial Resilient products over existing resilient can compromise their performance properties.** The performance of the new flooring, however, is directly dependent on the condition and continued bond of the existing floor covering.

In any case, the existing resilient flooring should meet the following conditions:

- Be fully adhered (full-spread) and well bonded to a suitable substrate
- Consist of a single layer only
- Be free of all evidence of alkaline salts, hydrostatic pressure, or moisture from the substrate
- Not be a foam-backed or thickly cushioned product
- Not be a perimeter-fastened or loose-laid product
- Not be asphalt tile, self-stick tile, rubber tile, or surface containing residual asphalt-based adhesives

It is the floor covering retailers or installer's responsibility to determine if the existing floor covering is suitable as an underfloor for the installation of any Mannington flooring product. If there is any doubt about the suitability of the existing floor, remove it or cover it with an appropriate underlayment.

### Removal of Existing Floor Coverings



**DANGER: Do not sand, dry-sweep, dry-scrape, drill, saw, beadblast, or mechanically chip or pulverize existing resilient flooring, backing, lining felt, or asphaltic "cutback" adhesives.** These products may contain either asbestos fibers or crystalline silica. Avoid creating dust. Inhalation of such dust containing respirable fibers or crystalline silica may cause cancer and respiratory tract diseases. Smoking by individuals exposed to asbestos fibers greatly increases the risk of serious bodily harm. Unless positively certain that the product is a nonasbestos-containing material, you must assume it contains asbestos. Regulations may require that the material be tested to determine asbestos content.

### Molds and Moisture

If there are visible indications of mold and mildew, the source of the problem must be located and corrected. This includes making any structural repairs that may be necessary. The resilient flooring must not be installed until both problems have been addressed.

For additional information, we suggest you refer to the U.S. EPA website: [www.epa.gov/iaq](http://www.epa.gov/iaq) listed under index section titled Molds & Moisture, "A Brief Guide to Mold, Moisture, and Your Home."

### Other Subfloors

#### Metal Subfloors

You may encounter metal subfloors made of steel, stainless steel, lead, or aluminum. These types of subfloors are typically found in specialized commercial applications. You must thoroughly clean them of all surface contaminants before installing new floor covering. While these underfloors are usually compatible with Mannington flooring products, our recommendation is to always conduct a bond test with the appropriate adhesive and the specified floor covering.

## General Installation Guidelines (continued)

### Poured Floors

When working with a poured floor (polyurethane or epoxy-based) make sure it is fully cured and securely bonded to a concrete substrate. Be careful to remove all waxes and finishes and ensure that the surface is completely smooth. Always conduct a bond test using the appropriate adhesive and the specified floor covering before starting the installation.

**Terrazzo** is a poured cementitious floor with a hard sealer on the surface. Be sure the floor is smooth and free of waxes and dressings. A terrazzo floor can be smoothed out with a terrazzo grinder.

There are several brands of poured polyurethane floor covering products. Mannington Flooring products may be installed directly over these surfaces as long as they are fully and firmly adhered to the substrate. Be sure that all waxes and dressings are stripped off. Sand the surface smooth.

---

 **NOTE:** The responsibility for warranties and/or performance of the concrete or poured subfloors as a suitable base for Mannington flooring products, regardless of their type and grade level, rests with the concrete manufacturer or the poured floor manufacturer and not with Mannington Floors, in the event of inherent deficiencies which would affect the bond and performance of Mannington flooring and adhesive.

---

 **NOTE:** Mannington Floors will not pay labor charges on claims filed on materials installed with obvious visible defects.

---



# Residential Resilient

# Residential Resilient Installation Guide

## Storage and Handling

All resilient products must be stored in a protected interior location, ideally one that can be climate controlled. Optimum storage temperatures are between a low of 65°F and high of 100°F. Additionally, the humidity of the storage area should be controlled and maintained between 30% and 70%.

Always store resilient sheet products tightly rolled, face-out on a sturdy cardboard core designed for that purpose. For 12' wide resilient flooring, store the roll horizontally and support it across the entire width. You may also store 6' wide resilient flooring vertically (on edge). You must follow these storage recommendations to prevent compression and distortion of the resilient sheet materials.

Flooring products can be heavy and bulky. Be good to yourself and always use proper lifting techniques when handling these products. Whenever possible make use of material-handling equipment such as dollies or material carts. Never lift more than you can safely handle; get assistance. Flooring products can be damaged by rough handling before installation. Exercise care when handling and transporting these products.

Before starting the job, always check the flooring materials to ensure they are the correct pattern, style, and color. Also make sure that the size and amount of the products are sufficient to complete the installation. Inspect the materials closely before installation for any visible defects. Mannington Flooring products are manufactured to high quality standards and are carefully inspected before leaving our facility. Occasionally, however, defects are not detected. If you notice a visible defect in the flooring product, stop the installation and contact your local Mannington Distributor for assistance.



**NOTE: Mannington Floors will not pay labor charges on claims filed for materials installed with obvious visible defects.**

## Job Site Conditions

The environment where flooring products are installed is critically important in regard to successful installation and continued performance of the flooring products. Mannington Flooring products are intended to be installed in interior locations only. These interior locations must meet climatic and structural requirements as well.

## Temperature Requirements

Do not install flooring products until the work area can be temperature controlled. We recommend that the work area be maintained at a minimum temperature of 65°F and a maximum temperature of 100°F for 48 hours before, during, and after the installation. This requirement can seldom be fulfilled with temporary space heaters. A permanent heating or cooling source should be operational before proceeding with the installation of any flooring product. For the entire life of the floor, the temperature should never fall below 55°F. If this minimum temperature cannot be maintained, the performance of the flooring products and adhesives can be adversely affected. Ideally the job site relative humidity will be maintained in the 40% to 50% range.

You may install all Mannington flooring products over hydroponic radiant-heated flooring systems, provided the surface temperature of the system does not exceed 90°F. Before installing flooring products over newly-constructed radiant heating systems, operate the system at maximum capacity to force any residual moisture from the cementitious topping of the radiant heating system. Then set the thermostat to a comfortable room temperature for the installation. For the smoothest job and best results, always condition flooring, adhesives, and installation accessories to the job site temperature before beginning the installation. There are many in-floor warming systems being introduced, while most of these systems are compatible with rigid products such as ceramic or hardwood, they are generally unsuitable with resilient flooring products. Always check with the flooring manufacturer before covering these in-floor warming systems

## Structural Requirements

The structural integrity of the job site is critical for satisfactory flooring installation. The type and method of construction, grade level, and flooring system components all impact the installation of flooring products. Many times local building codes establish only minimum requirements for flooring systems. These minimum requirements may not provide sufficient rigidity for successful installation and continued performance of flooring products. Structural flooring systems are constructed of either concrete (or cementlike materials) or wood. The description of each of these structural flooring constructions is presented in the General Installation information in Section I.

**For more comprehensive information, contact the manufacturer of the particular flooring underlayment system. The American Concrete Institute and APA The Engineered Wood Association, aka the American Plywood Association can provide details for their respective products.**

## Residential Triple Option Installation

### General Instructions

Before beginning any installation, carefully read the General Installation Guidelines described on pages 6-10. We have designed the Triple Option installation method for use with all Mannington running line felt-backed Residential Resilient sheet products. **(The product must be 12' wide. The Triple Option installation method cannot be used with 6' roll goods.)**

### Triple Option Installation Methods

Mannington's Triple Option installation methods simplify the installation process of Mannington Residential Resilient felt-backed flooring products. Triple Option lets installers match the installation technique to the job site conditions. The three installation methods are:

- **FULLY ADHERED:** The Fully Adhered technique has a long history of proven success. It's the best option in areas subjected to heavy foot or rolling traffic, or in more complex job sites with multiple alcove drops, center islands, or when intricate net-fit cutting is required.
  - Acceptable substrates are clean, dry, smooth, and include both wood panel and concrete underfloors.
  - This technique becomes an installer's only option if:
    - the vinyl roll is distorted or not rolled face-out on a 4" core
    - the backing becomes kinked, cracked, or severely folded during installation
- **LOOSE LAID:** Loose Laid is the easiest of the Triple Option installation methods. Using this method, the vinyl is fit just slightly short of all vertical surfaces (approximately 1/16" away) so that it lies completely flat with no fullness or "pinch" points. This installation method makes removal of the floor at the end of its life cycle remarkably easy.
  - Loose-Laid floors can be installed over many substrates that are unacceptable for Fully Adhered products (particleboard, chipboard, flakeboard, lightweight concrete).
  - This non-adhered installation method allows the material to be rolled back to correct any substrate problems and is easily removed when required.
  - Although the floor is referred to as Loose Laid, V-31 adhesive is necessary at all seams and around any floor vents.
  - Restrictive and transition moldings are required.



- **Loose Laid should not be used if the job site:**
  - is larger than two full drops of material
  - is greater than 30' in length
  - is exceptionally "cut up" and complex
- **Loose Laid is not an option if:**
  - the roll is distorted
  - the roll is not rolled face-out
  - the felt becomes kinked, cracked, or severely folded during installation
- **PERIMETER-FASTENED:** In a Perimeter-Fastened installation, the sheet vinyl is fastened to an acceptable substrate around the perimeter of the work area and at any product seams. This installation method makes removal of the floor at the end of its life cycle easy.
  - Using this option, the vinyl can be installed over many types of substrates that may not be appropriate for a Fully Adhered installation (particleboard, chipboard, flakeboard, lightweight concrete).
  - Perimeter-Fastened installations require that the product be adhered with a 4" to 6" band of V-31 adhesive applied with a 1/16" x 1/16" x 1/16" notched trowel around the perimeter and at any seams.
  - If the substrate is wood, the product can be fastened using staples.
    - The staples should:
      - have at least a 1/2" crown
      - be of sufficient length to fully seat into the underfloor panels
      - be spaced every 2" around the perimeter of the room
      - be applied after the adhesive when a combination of staples and adhesive is being used
  - Restrictive moldings (cover base, quarter round, etc.) and transition moldings must be used in a Perimeter-Fastened installation.
  - **Perimeter-Fastened is not an option if:**
    - The job site and material are not conditioned and climate controlled. This is particularly important in new construction.
    - the roll is distorted
    - the roll is not rolled face-out
    - the felt becomes kinked, cracked, or severely folded during installation

Whichever option an installer chooses, it's important to:

- **Employ good resilient sheet flooring work practices regarding the careful handling and fitting of the products.**
- **Be vigilant in underfloor selection and preparation.**
- **Install in indoor climate-controlled (temperature and humidity) environments.**

### Cutting and Fitting

You may use pattern scribing, freehand knifing, or direct scribing techniques when installing Mannington felt-backed resilient products. The material is flexible and will handle easily when cutting and fitting. Always fold the material in a wide radius to avoid sharp kinks and creases that may cause breaks in the backing. You may flash cover all Mannington products that are fully adhered or perimeter-fastened (see pages 41-42). Thoroughly sweep the surface after you have completed the entire underfloor preparation. Be sure to carefully vacuum or sweep around the perimeter of the room to remove loose dirt and debris.

### One Piece Installation

Precut the floor covering to fit the area, allowing 2" to 4" extra length and width for fitting. Position the resilient flooring in the room, allowing enough material to drop into offsets, closets, alcoves, etc.

Align pattern squarely in room, parallel to all walls. If the room is not square, align the pattern so the run-off is located in the least conspicuous area.

HINT: When aligning resilient flooring with straight line patterns, avoid positioning a pattern line next to the wall. If the line falls several inches from the wall, any pattern runoff caused by an out-of-square room will be less noticeable. After the sheet is positioned, weight it to prevent shifting. Make relief cuts around unusual objects such as pipes, fixtures, floor registers, etc.

Make relief cuts on all inside and outside corners. Rough-cut the sheet to remove excess material. Trim and fit the perimeter so the floor covering lies flat before adhesive is spread.

### Seamed Installation

Fit and cut the first sheet as in a one-piece installation and weight this sheet to prevent it from shifting. (Use floor roller, tool box, adhesive container, etc.) Position the second sheet in the room and align it to the first sheet for accurate pattern match. Once you have achieved pattern alignment, weight the second sheet to prevent it from shifting.

Before positioning the resilient flooring material in the room, determine the best possible placement of the seam and the dry zone. Snap a white chalk line indicating where the seam will be positioned. Snap two white chalk lines 18" on either side of the seam chalk line.

## Pattern Matching

When your work area requires more than one sheet of material, provide additional length on the second and succeeding sheets to allow for proper pattern alignment. Install Mannington Resilient Floors using either the "Reverse" or "Do Not Reverse" method.

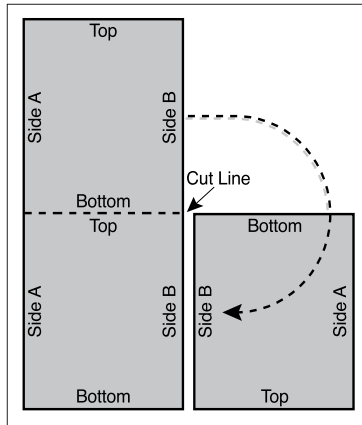

### "Reverse" Method

"Reverse Sheets for Seaming" means turning the second sheet 180° to the first sheet. To determine the amount of additional material required to assure proper pattern alignment when the "Reverse Sheets" method is recommended, cut the first sheet at least 3" longer than the net room requirements. Cut the second and all succeeding sheets to this length plus the length of the pattern repeat.

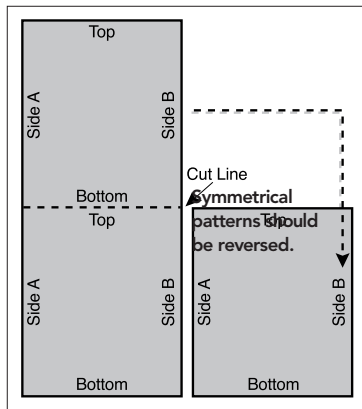

### "Do Not Reverse" Method

"Do Not Reverse Sheets for Seaming" means placing the opposite selvage edges together. To determine the amount of additional material needed to align patterns in "Do Not Reverse" designs, cut the first sheet 3" longer than the net room requirements. Cut the second and all succeeding sheets to the next multiple of the pattern repeat over the net room dimension, providing the starting wall is the same.

### Minimizing Pattern Run-Out

To minimize pattern run-out, cut the material to the appropriate sizes the day before the actual installation. (Remember, always store material at its recommended temperature.) When you have completed cutting the resilient sheet, tightly roll the cuts face-out around a core, maintaining as equal a diameter as possible. When cutting and storing the flooring pieces, remember that each piece must be installed in sequential order. If you need more than one roll of floor covering, make sure that all rolls are marked with the same shade letter.

You can correct pattern run-outs during installation. You may "shrink" or compress the design by tightly rolling the sheet face-in. To stretch the design, tightly roll the material face-out.

Begin pattern matching in the center of the sheet. This method divides any pattern run-out toward the end of each sheet.



**NOTE:** Symmetrical patterns should be reversed. Nonsymmetrical patterns should not be reversed. It is impossible to obtain an accurate pattern match when turning the material 90° to another sheet. This method of "quarter turning" the material may also cause shade variation.



**NOTE:** All Mannington residential rotogravure 6' wide material is split from 12" wide rolls, thereby leaving only one true selvage edge. Installations with only one seam will not present a problem. As long as you reverse the sheets, they will overlap with selvage edge to selvage edge. With the third sheet, however, you may find it necessary to move the sheet by the width of one design unit to obtain a proper pattern match. On 6' wide "Do Not Reverse" patterns, you may have to move the sheet by one design unit to provide proper overlap and pattern alignment at all seams.

It is important to obtain accurate overlap of the selvage edges to ensure pattern match across the sheets, as well as along the length of the seam. There are several techniques you may use to determine proper overlap. The first method is to cut notches or “windows” along the selvage grout line. These notches will allow you to see the overlapped grout line and will assist you in positioning the second sheet. The second method Mannington recommends to determine proper overlap is to measure the design elements across the first sheet with a tape measure to determine the pattern repeat and then transfer this measurement across both sheets to assist in the positioning of the second sheet.

### Seam Cutting

Seaming is one of the most important aspects of resilient sheet installation. It is often the sole criteria for judging the entire installation. We cannot emphasize enough the importance of taking the time to ensure a properly aligned, cut, and sealed seam. Always double-cut seams in Mannington Residential felt-back products with a new, sharp utility knife blade. Use a steel straightedge as a guide. A dull blade will not produce an acceptable seam. If the seam is long, or if it is being cut on a concrete underfloor, we advise sharpening or changing blades as needed. It is also good practice to remove any oily, protective coating on the new blades with a clean cloth before starting to cut the seam.

### Double-Cutting of Seams

The most accurate method for cutting seams in felt-backed and fiberglass-reinforced vinyl back products is double-cutting. When double cutting, both sheets are cut at the same time. This ensures the edges of both sheets are cut exactly the same, with no gaps or fullness. Many of today’s resilient flooring patterns feature very narrow grout or design lines. It is very difficult to align and cut these narrow lines in the exact center. Because the grout or design lines are often the focal point of the pattern, it is extremely important to maintain the exact width of these grout lines throughout the entire installation. The most accurate method of maintaining the line width is to make the seam cut along the side of the grout line.

Cut the seam net, not full. Keep the knife blade parallel to the straightedge, at a 90° angle to the floor covering. Position the knife to allow as much of the cutting edge of the blade as possible to come in contact with the floor covering. It is difficult to keep the utility knife steady if only the point of the knife is riding on the floor.



With the sheets aligned, position the steel straightedge so it completely covers the grout line of the top sheet. Using the straightedge as a guide, cut the length of the seam in the "shadow" of the grout line with a utility knife. This technique will ensure that all grout lines are of the same width. This is important, since you will completely cut away the bottom sheet grout line and will leave the grout line of the top sheet intact.



Once the seam is cut, remove the selvage edge and turn back the material to expose the subfloor.



Apply adhesive as required with the chosen installation method.



Carefully place the second sheet into position.



Thoroughly clean the seam area with a clean white cloth and wipe dry. Remove any adhesive that has dried on the surface with a clean white cloth dampened with a good quality-grade mineral spirits or painter's naphtha. Avoid wiping down or across the seam cut with a soiled cloth. Keep the seam cut free of soil, adhesives, or contaminants.

**Apply adhesive as required with the chosen Triple Option installation method.**

### Adhesive Recommendations & Application

Mannington strongly recommends that when residential felt-backed products are to be fully adhered to an approved underfloor, you use Mannington V-31 adhesive (see page 52).

### Adhesive Application – Fully Adhered Products

Apply adhesive with the following recommended notched trowels.

- Porous underfloors: Use a trowel notched 1/16" wide, 1/16" deep, and 1/16" apart
- Nonporous underfloors: Use a trowel notched 1/16" wide, 1/32" deep, and 1/32" apart

It is always a good idea to allow "open time" for the adhesive before laying the sheet down. Open time is the elapsed time between when the adhesive was spread and when the floor covering material is positioned into the adhesive. This allows moisture to "flash off" the adhesive, permitting the adhesive to develop more body and tack. Open time is always dictated by the underfloor porosity and atmospheric conditions. Make certain to provide ample open time on nonporous underfloors and at seam lines.

After trimming the material to fit the room, tube or lap it back to expose approximately one-half of the underfloor. Strike a white chalk line near the fold of the material. This line provides a guide for adhesive application. Spread the adhesive, leaving no gaps, voids, puddles, or thin spots, over 100% of the exposed underfloor. Keep the trowel clean and properly notched to maintain this uniform coverage.

After the adhesive has begun to tack up, gently position the sheet into the adhesive. Roll the floor covering forward into the adhesive to eliminate trapping air. Do not drop or flop the material into the adhesive. Using a 75 lb. (or heavier) three-section floor roller, roll the material in both directions, starting in the middle of the sheet width and rolling toward the edges. This process eliminates air and embeds the floor covering into the adhesive. Roll areas that cannot be reached with a floor roller with a hand seam roller.

**Failure to roll the floor covering can result in the following problems:**

- Lack of bond between material and underfloor
- Telegraphing of adhesive ridges
- Permanent indentations when heavy items are placed on the new flooring, resulting from adhesive displacement

Once the first half of the material is adhered and rolled, fold back the second half and repeat the procedure. When folding back the sheet use extreme caution to prevent tearing the felt backing at the glue line. Also, be careful to regulate the adhesive spread at the glue line. This will avoid an adhesive ridge left in the center of the sheet.

### Adhesive Application – Perimeter-Fastened

When installing resilient sheeting using the Options Felt Backing Perimeter installation system, the material is only fastened around the perimeter of the work area as well as at all seam lines. Fasten the material using either Mannington V-31 Premium Latex Adhesive or staples.

Once the material has been fit, tube or lap back the flooring material and re-sweep the underfloor and back of material before fastening the product. Spread Mannington V-31 adhesive with a standard  $1/16"$  x  $1/16"$  x  $1/16"$  notched trowel in a 4" to 6" wide band around the perimeter of the room. Thoroughly roll the material into the adhesive using a hand roller to ensure adhesion and to flatten out any adhesive ridges. Re-trim any fullness that may have occurred in the resilient sheet.

### Adhesive Application – Loose Laid

Even though adhesive is not required when using the loose-laid method, it is essential to apply an 8" band of V-31 adhesive at all seams, and around any floor vents. Apply an 8" wide band of V-31 adhesive centered on the seam cut. Allow enough open time for adhesive to tack up, but do not allow adhesive to form a skin, or overdry. Reposition the cut seam edges and roll the material into the adhesive using a hand roller. Exercise care to help prevent adhesive contamination in the seam cut.



**NOTE:** It is impossible to obtain an accurate pattern match when turning material 90° to another sheet. This method of "quarter turning" the material may also cause shade and texture variation. For these reasons, Mannington does not recommend "quarter turning" of any of our resilient floor covering products.

### Seam Sealing

Before beginning the seam sealing process, thoroughly clean the work area of all scraps, soil, tools, etc. The long-term performance of any seam cut into a resilient sheet product depends on several significant requirements. The most important of these is the selection and application of the appropriate seam sealer for the type of resilient sheet being seamed. It is the flooring installer's responsibility to use only recommended sealers and to be proficient in their application.



**CAUTION:** These adhesive solvents are flammable. Follow all precautions listed on the cans.

Avoiding adhesive contamination of the seam cut is another critical requirement. Mannington seam sealers consist of a solvent (THF) and a resin (PVC). The solvents cause the edges of the seam to "melt" and permit the resins to "attach" to each edge of the seam. This process results in a chemical weld. Adhesive forced up into the cut will adhere to the edges of the sheet, inhibit solvent action, and prevent a chemical weld from occurring. Additionally, adhesive forced into the cut creates a discolored line at the seam.



**NOTE:** We recommend waiting 24 hours to return the furniture or appliances to the room; circumstances, however, may otherwise require it. If so, replace appliances before starting seam sealing. Always use wood or hardboard runways when moving furniture and/or appliances, even when using an appliance dolly.

Seal seams in Mannington Resilient floors immediately after installation with the recommended Mannington seam sealer. This seam sealing process provides a continuous, impervious surface that will be as strong as the resilient surface and will remain intact for the life of the flooring.

Mannington offers four types of residential seam sealers:

- MHS 22 (#832222) High Gloss Sealer (two-part seam sealer) is designed for Mannington products with a high shine urethane-based wearlayer. The VST-96 Professional Applicator Bottle.
- MCT 20 (#832203) is a do-it-yourself consumer seam sealer kit. The 2-oz tube contains standard gloss seam sealer and is recommended for use with vinyl wearlayers.
- MLG 33 (#832233) Low Gloss Sealer (two-part seam sealer) is designed for Mannington products with a low gloss vinyl or urethane-based wearlayer. The VST-96 Professional Applicator Bottle.
- MSS 20 (#832202) Standard Gloss Sealer, available in one-pint containers, is for all vinyl wearlayer products. Use the VST-96 Professional Applicator Kit (#832204). See next page for sealer instructions.

The Versatile Sealing Tip (VST) is used to chemically seal all Mannington resilient sheet products. The VST is included in the Professional Applicator Kit, the MHS 22 High Gloss Seam Sealer Kit, and the MLG 33 Low Gloss Seam Sealer Kit. Be sure to order the Professional Applicator Kit separately when you order a seam sealer other than MHS 22 and MLG 33. The VST's unique, ergonomic design offers many benefits. The all-composite plastic tip will not leak. The plastic fin will not cut or mar the resilient sheet's seam. The flat "landing face" on the tip provides just the right angle and keeps the bottle steady during application. The flat, angled head has ridges (texture) and lets you apply a firm, downward pressure on the applicator tip without getting tired.

## Residential Resilient Installation Guide (continued)



Before sealing the seam, make sure the seam cut is clean, dry, and free of adhesive contamination. Shake the seam sealer container to blend the ingredients and allow air bubbles to disperse (usually 15 minutes) before pouring sealer into the applicator bottle. Fill the bottle at least 2/3 full with the appropriate seam sealer and tightly screw on the VST applicator tip.



Check the flow of sealer through the applicator tip on a scrap piece of material before use. If the flow is restricted, insert the cleaning wire into the tip to clear the obstruction. Insert the plastic fin of the VST slightly back from one end of the wall and push forward to make full penetration of the fin. Use your forefinger to apply a downward pressure on the flat, textured "head" of the VST.



Gently squeeze the bottle to start the flow of the sealer. In a slow, continuous motion, pull the applicator along the length of the seam. The correct angle of the applicator tip to the seam is determined by the flat support or "landing face" of the VST. Most importantly, once the tip is inserted into the seam cut, it does not need to be removed until the seam is sealed, ensuring complete sealer application along the entire length of the seam.



Seam sealer flow will stop when hand pressure is removed. This allows you to leave the applicator inserted in the seam cut when you reposition yourself along the length of the seam. This helps eliminate the chance of sealer skips caused by repositioning the applicator during seaming.

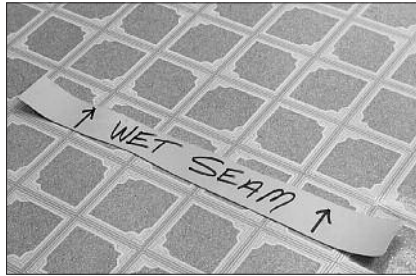

You must apply seam sealer into the seam cut and leave a bead of sealer approximately 1/8" wide centered on the seam. This applies to all Mannington Residential products. To avoid walking on the seam, mark it with a scrap piece of floor covering.

Remember, it is crucial that the seam sealer be applied to the full thickness of the floor covering from top to bottom. To ensure a strong, tight seam, make certain there are no skips or voids along the cut.

Allow seam sealer to completely dry before walking on the seam or moving furniture over it. We recommend waiting 24 hours.



**NOTE:** When using two-part seam sealer kits, it is necessary to combine the entire contents of parts A & B (see pages 62 & 63). Once mixed, two-part sealers cannot be saved for reuse.





## Sobella™ Installation Methods

Sobella's™ installation methods simplify the installation process and let installers match the installation technique to the job site conditions. Sobella™ can be installed by using the Fully Adhered technique or the Loose Laid technique.

- **FULLY ADHERED:** The Fully Adhered technique has a long history of proven success. It's the best technique in areas subjected to heavy foot or rolling traffic, or in more complex job sites with multiple alcove drops, center islands, or when intricate net-fit cutting is required.
  - This technique requires that the flooring product be fully adhered to an acceptable substrate using Mannington MT-711 Adhesive. Acceptable substrates are clean, dry and smooth. They include both wood panel and concrete underfloors.
- **LOOSE LAID:** Loose Laid is the easiest installation method. Using this method, Sobella™ is fit just slightly short of all vertical surfaces (1/8" to 1/4" away) so that it lies completely flat with no fullness or "pinch points." This installation method makes removal of the floor at the end of its life cycle remarkably easy.
  - Loose Laid floors can be installed over many substrates that are not suitable for Fully Adhered products (particleboard, chipboard, flakeboard, lightweight concrete).
  - Only one major seam is permitted when installing with the Loose Laid systems.
  - Never secure any permanent fixtures into the Sobella™. The product must be "free floating" with no "pinch points."
  - This non-adhered installation method allows the material to be rolled back to correct any substrate problems, and is easily removed when required.

**No matter which installation system will be used it's important to consider the following:**

### Storage and Handling

Sobella™ must be stored in a protected interior location, ideally one that can be climate controlled. Optimum storage temperatures are between a low of 65°F and high of 100°F. Additionally, the humidity of the storage area should be controlled and maintained between 30% and 70%.

Always store Sobella™ tightly rolled, face out on a sturdy cardboard core designed for that purpose. Store the roll horizontally and support it across the entire width.

Flooring products can be heavy and bulky. Be good to yourself and always use proper lifting techniques when handling these products. Whenever possible, make use of material-handling equipment such as dollies or material carts. Never lift more than you can safely handle; get assistance. Flooring products can be damaged by rough handling before installation. Exercise care when handling and transporting these products.

Before starting the job, always check the flooring materials to ensure they are the correct pattern, style, and color. Also make sure that the size and amount of the products are sufficient to complete the installation. Inspect the materials closely before installation for any visible defects. Mannington Flooring products are manufactured to high-quality standards and are carefully inspected before leaving our facility. Occasionally, however, defects are not detected. If you notice a visible defect in the flooring product, stop the installation and contact your local Mannington Distributor for assistance.



**NOTE:** Mannington Floors will not pay labor charges on claims filed for materials installed with obvious visible defects.

## Job Site Conditions

The environment where Sobella™ is to be installed is critically important in regard to successful installation and continued performance of the flooring products. Mannington is intended to be installed in interior locations only. These interior locations must meet climatic and structural requirements as well.

## Temperature Requirements

Do not install Sobella™ until the work area can be temperature controlled. We recommend that the work area be maintained at a minimum temperature of 65°F and a maximum temperature of 100°F for 48 hours before and after the installation and while installing. This requirement can seldom be fulfilled with temporary space heaters. A permanent heating or cooling source should be operational before proceeding with the installation of any flooring product. For the entire life of the floor, the temperature should never fall below 55°F. If this minimum temperature cannot be maintained, the performance of the flooring products and adhesives can be adversely affected. Ideally, the job site relative humidity will be maintained in the 30% to 70% range.

## Radiant-Heated Subfloors

You may install Sobella™ over hydroponic radiant-heated flooring systems, provided the surface temperature of the system does not exceed 90°F. Before installing flooring products over newly constructed radiant heating systems, operate the system at maximum capacity to force any residual moisture from the cementitious topping of the radiant heating system. Then set the thermostat to a comfortable room temperature for the installation. There are many In-floor warming systems being introduced, while most of these systems are compatible with rigid products such as ceramic or hardwood, they are generally unsuitable with resilient flooring products. Always check with the flooring manufacturer before covering these in-floor warming systems.

For the smoothest job and best results, always condition flooring, adhesives, and installation accessories to the job site temperature before beginning the installation.

## Structural Requirements

The structural integrity of the job site is critical for satisfactory flooring installation. The type and method of construction, grade level, and flooring system components all impact the installation of flooring products. Many times, local building codes establish only minimum requirements for flooring systems. These minimum requirements may not provide sufficient rigidity for successful installation and continued performance of flooring products. Structural flooring systems are either constructed of concrete (or cementlike materials) or wood.

## Cutting & Fitting

You may use pattern scribing, freehand knifing, or direct scribing techniques when installing Sobella™. The material is flexible and will handle easily for cutting and fitting. Always fold the material in a wide radius to avoid sharp kinks and creases that may cause breaks in the backing. You may flash cove Sobella™ only when using the Fully Adhered technique.

## One Piece Installation

Thoroughly clean the subfloor, sweep or vacuum to remove all dust and debris.

Remove any quarter round, shoe base or wall base, and undercut any doorways.

Precut the floor covering to fit the area, allowing 2" to 4" extra length and width for fitting. Position the resilient flooring in the room, allowing enough material to drop into offsets, closets, alcoves, etc.

Align pattern squarely in room, parallel to all walls. If the room is not square, align the pattern so the run-off is located in the least conspicuous area. After the sheet is positioned, weight it to prevent shifting. Make relief cuts around unusual objects such as pipes, fixtures, floor registers, etc. Make relief cuts on all inside and outside corners. Rough-cut the sheet to remove excess material. Trim and fit the perimeter so the floor covering lies flat.

### FULLY ADHERED

When using the Fully Adhered technique, apply the adhesive with a 1/16" wide, 1/32" deep, and 1/32" apart notched trowel.

After trimming the material to fit the room, tube or lap it back to expose approximately half of the underfloor. Strike a white chalk line near the fold of the material. This line provides a guide for adhesive application. Spread the adhesive, leaving no gaps, voids, puddles, or thin spots, over 100% of the exposed underfloor. Keep the trowel clean and properly notched to maintain this uniform coverage.

**Immediately after adhesive application, gently position the sheet into the adhesive.** Roll the floor covering forward into the adhesive to avoid trapping air. Do not drop or flop the material into the adhesive. Using a 75-lb (or heavier) three-section floor roller, roll the material in both directions, starting in the middle of the sheet width and rolling toward the edges. This process eliminates air and embeds the floor covering into the adhesive. Roll areas that cannot be reached with a floor roller, with a hand seam roller.

**Failure to roll the floor covering can result in the following problems:**

- Lack of bond between material and underfloor
- Telegraphing of adhesive ridges
- Permanent indentations when heavy items are placed on the new flooring, resulting from adhesive displacement

When the first half of the material is adhered and rolled, fold back the second half and repeat the procedure. When folding back the sheet, use extreme caution to prevent tearing the felt backing at the glue line. Also, be careful to regulate the adhesive spread at the glue line. This will avoid an adhesive ridge left in the center of the sheet.

### LOOSE LAID

The most critical requirement when loose laying a one-piece Sobella™ installation is to be certain that the material is laying flat and positioned squarely in the room. In long drops, pull a string down a pattern line to assure that the material is positioned squarely in the work area.

Provide a gap of between 1/8" and a 1/4" around all edges of the Sobella™ flooring. Once the Sobella™ is positioned in the room, allow 15 to 20 minutes for the material to relax and lay flat before the final trimming. Undercut all door casings so the material can be slid under these casings without "pinching" or locking material. When fitting around in-floor forced-air vents, it is necessary to apply a narrow band of adhesive around the vent to prevent air from being blown under the flooring.

**Never secure cabinets or other permanent fixtures on top of loose laid Sobella™. Be certain that wall base and transition strips are not fastened into the Sobella™.**

### Seamed Installation

When the work area requires more than one Sobella™ drop, determine the best possible placement of the seam. **If the work area requires more than one seam, the Fully Adhered method must be used.** Fit and cut the first sheet as in a one-piece installation. Weight this sheet to prevent it from shifting. Position the second sheet in the room and align it to the first sheet for accurate pattern match. Once you have achieved pattern alignment, weight the second sheet to prevent it from shifting.

### Pattern Matching

When your work area requires more than one sheet of material, provide additional length on the second and succeeding sheets to allow for proper pattern alignment. Install Sobella™ using the "Reverse" or "Do Not Reverse" method.

### Seam Cutting

Seaming is one of the most important aspects of resilient sheet installation. Always double-cut seams in Mannington Sobella™ with a new, sharp utility knife blade.

### Double-Cutting of Seams

The most accurate method for cutting seams in Sobella™ is double-cutting. In this technique, both sheets are cut at the same time. This ensures the edges of both sheets are cut exactly the same, with no gaps or fullness. **The construction of Sobella™ will not permit the product to be compressed or stretched into match.** Overlap the sheets of Sobella™ and bring the pattern into an exact match. The most accurate method of maintaining the pattern grout line width is to make the seam cut along the side of the grout line. With the sheets aligned, position the steel straightedge so it completely covers the grout line of the top sheet. Using the straightedge as a guide, cut the length of the seam in the "shadow" of the grout line with a utility knife. This technique will ensure that all grout lines are of the same width.

Cut the seam net, not full. Do not add fullness to the cut by placing scrap under the seam. Keep the knife blade parallel to the straightedge, at a 90° angle to the floor covering.

All seams are to be double cut "dry."

When using the Fully Adhered technique, the sheets will be adhered up to a pre-determined dry zone; the seam is cut and then a uniform application of MT 711 is applied. After providing sufficient open time, carefully position the sheets into the adhesive and roll across the seam with a hand roller.

If the Loose Laid system is used, after cutting the seam, apply a 6" band of MT 711 at the seam line, provide sufficient open time and then carefully position the sheet edges into the adhesive. Use caution to prevent the sheet edges from getting into the adhesive. Roll the seam area with a hand seam roller.

### Seam Sealing

All seams in Sobella™ flooring must be sealed with Mannington MLG 33 two-part seam sealer. Thoroughly mix all of part A and part B into the supplied VST applicator bottle. When using MLG 33 two-part seam sealer, it is necessary to mix the entire contents of Parts A and B. Once mixed, MLG 33 cannot be saved for re-use. Check the flow of sealer through the applicator tip on a scrap piece of material, before use. If the flow is restricted, insert the cleaning wire into the tip to clear the obstruction. Before sealing the seam, make sure the seam cut is clean, dry, and free of adhesive contamination.

Insert the plastic fin of the VST slightly back from one end of the wall and push forward to make full penetration of the fin. Use your forefinger to apply a downward pressure on the flat, textured “head” of the VST. Gently squeeze the bottle to start the flow of the sealer. In a slow, continuous motion, pull the applicator along the length of the seam.

You must apply seam sealer into the seam cut and leave a bead of sealer approximately 1/8" wide centered on the seam.

Remember, it is crucial that the seam sealer be applied to the full thickness of the floor covering from top to bottom. To ensure a strong, tight seam, make certain there are no skips or voids along the cut.

Allow seam sealer to completely dry before walking on the seam or moving furniture over it. We recommend waiting 24 hours.

### Finishing and Maintenance

#### Molding and Base Installation

Protect all exposed edges of the flooring with trim or restrictive molding.

- Always use moldings and transition strips over product edges.
- Nail wood moldings into the wall and not into the floor covering.
- Use metal or vinyl transition or reducer strips where Sobella™ meets other types of flooring, and at doorways.
- Apply a bead of silicone or latex caulk around bathtubs, shower stalls, toilets, and patio doors.

#### Job Site Cleanup

To enhance the appearance of the finished installation, it is always good practice to thoroughly clean the area before leaving.

- Sweep the floor.
- Remove all scraps and trash from the job site. (Leave any large pieces of flooring, rolled face out, with the customer for future repairs.)
- Remove any adhesive smears or residue from the surface of the flooring with a clean cloth dampened with mineral spirits or lighter fluid. (WARNING – flammable)
- If possible, wait 24 hours before moving furniture or appliances onto or across the floor. Always use wood or hardboard runways to move furniture and/or appliances, even when using a dolly. **This is especially important when using the Loose Laid installation method.**
- Leave Mannington maintenance and warranty literature with the customer. These are available from your Mannington Distributor.

## Repairs

### Small Cuts

Small cuts will eventually gap open. To repair, clean any dirt from the cut and apply MLG 33 seam sealer.

### Replacing Damaged Areas – Plugs

If you must replace a damaged area, follow these steps:

- Select a design element from the scrap material that matches the design to be removed from the existing resilient. Accurately overlay this piece over the damaged area.
- Double cut on the inside of the grout line, if possible, and remove the damaged piece. If the floor covering you are repairing is installed over existing resilient flooring, be careful not to cut too deep.
- If the Sobella™ was installed Fully Adhered apply a thin layer of MT 711 to the back of the repair piece and place into position. Roll with a hand roller. Apply MLG 33 seam sealer. Protect from foot traffic until sealer is fully cured.
- If the Sobella™ was installed Loose Laid apply a thin layer of MT 711 on the back of the repair piece as well as under the edges of the repair area. Position the repair piece into the cut-out area and lightly roll the area with a hand seam roller. Apply MLG 33 seam sealer. Protect from foot traffic until sealer is fully cured.

### Residential Perimiflex Installation System for Aurora® Flex

Follow all General Installation Guidelines as described on pages 5-10. Mannington has designed Perimiflex-backed products specifically to be installed by perimeter fastening only. This permits you to install these products over many types of underfloors not suitable for a fully adhered installation.

Currently only Mannington Aurora Flex utilizes the Perimiflex system.

### Perimiflex Packaging and Handling Procedures

- Always store and transport Perimiflex products rolled tightly, face out, and secured with tape on a heavy 4" core. Rolls not wound tightly can cause buckling/bubbling problems. Never store this type of floor covering rolled face in.
- All Perimiflex material must be rolled with interleaf paper. Failure to use interleaf paper may lead to scalloped edges. Scalloped edges make pattern matching more difficult, and can lead to buckles after installation.
- Caution must be taken to ensure the interleaf paper is not wrinkled within the roll. Wrinkled paper can cause undesirable dull impression marks. Although most impression marks will disappear in time, care must be taken to avoid their original formation.
- Never write on the Perimiflex backing with ink pens, felt-tipped markers, or waxed crayons. Also, do not use these markers on the underfloor, since they may bleed through to the face of the material. Use a lead pencil to do any marking on the Perimiflex backing.
- Do not allow the roll to sag or bend during storage and/or transportation. Distorted materials may not lie flat. If material is flattened or distorted during storage or transporting, do not attempt to install it. Rolling the Perimiflex material tightly around a core face out and leaving it rolled for several hours may remove most distortion.
- Always use plywood or hardboard runways when moving appliances or heavy furniture. Use these runways even if using an appliance dolly or if the heavy objects are equipped with wheels or rollers.

### Cutting and Fitting

Keep the Perimiflex material tightly rolled face out until you have prepared the underfloor. Remove all baseboard quarter round or moldings from the perimeter of the work area. Undercut door trims and casing with a jamb or hand saw so you can tuck the material underneath. Once the material is unrolled, completely install it in less than two hours.

This ensures the material will retain its full contractibility, and will remain flat and tight after installation.

### Seam Cutting & Seam Sealing

#### Seamed Installation

When the work area requires two or more pieces of material, you must complete the seaming steps before fastening the perimeter of the material. Make seams in the Perimiflex Installation System using the "straightedge and butt" method.



**NOTE:** The "straightedge and butt" seaming procedure requires you to use a straightedge to trim the selvage edges of the sheets. The pattern is brought into match and the edges butted together. A short straightedge (like the leg of a framing square) often makes following the grout line easier.



# Residential Resilient Installation Guide (continued)

## Straightedge & Butt Method

"Reverse" or "Do Not Reverse" sheets as instructed. Position the new seam at least 4" from any seam or tile lines in existing resilient flooring and 6" from underfloor joints. If the job requires seaming, follow these steps:



Weight the first piece of material to avoid shifting. Using a straightedge as a guide, cut the seam on one shoulder of the grout line, leaving the pattern or grout line on the sheet. When cutting seams over an existing resilient floor, protect the existing flooring from knife cuts.



Position the material in the room, aligning the pattern squarely with the walls. Match the pattern at the seam line.



Cut off the grout on the second sheet, remembering to cut on the shoulder of the grout line.



Put the seams together and place masking tape over the seam in several places to hold it in place.



Cut and fit the material to the room.



Fold back both seam edges and sweep underfloor where adhesive will be applied – the seam line and the perimeter of the room. Apply a 6" wide band of Mannington V-61 adhesive centered on the seam line.



After applying the adhesive down the seam lengthwise, scrape the adhesive in the other direction (perpendicular). This will help prevent having too much adhesive in the seam. Allow the adhesive to tack up prior to laying down the resilient sheets.



Lay one sheet into the adhesive. Roll the edge of the sheet vinyl with a hand floor roller.



Working from the center of the seam, carefully position the second piece of resilient into alignment.

# Residential Resilient Installation Guide



You can stretch or compress the material by using the handle of a screwdriver to bring the pattern into match. Use masking tape to hold the pattern in place on one side of the screwdriver.



Take the screwdriver out of the seam and begin to work the seam with your hands to correctly position the design elements.



Roll the seam with a hand roller. Leave the masking tape in place to secure the seam while fitting and fastening the perimeter of the material. Also leave the masking tape in place for a minimum of one hour to allow the adhesive to set. Remove the tape just prior to seam sealing.



Thoroughly clean the seam cut of all adhesives, dirt, etc., before sealing the seam. It is also important to thoroughly remove any residue on the face of the material caused by the tape. Seal all seams with appropriate Mannington seam sealer (see pages 25 and 27 for directions). When inserting the VST applicator tip into the seam cut it is crucial the seam sealer be applied the full depth of the cut.

## Fastening Perimiflex Products

The Perimiflex Installation System only requires fastening the perimeter of the material. This allows the material to contract and bridge many underfloor irregularities, and to remain tight and flat to provide a smooth appearance.

### Staples

When the underfloor is wood, staples are the preferred fasteners. Staples should have at least a 1/2" crown and be of sufficient length to secure material to the underfloor. Staple length should be the longest that can be fully seated (3/8" to 1/2"). Space staples every 2" around the perimeter. If the job requires a combination of staples and adhesives, complete the adhesive areas first. Position all staples close enough to the wall so they can be covered by a restrictive molding (e.g., quarter round, shoe molding, rubber/vinyl cove base, etc.).

## Adhesive Recommendations and Application

The Perimiflex Installation System makes use of one type of adhesive: V-61 Adhesive

- V-61 is a water-based, latex adhesive for use over porous and nonporous floors, any approved suspended wood underlayments, concrete underfloors, and existing resilient floors that are free of all foreign matter and meet the requirements outlined in the General Guidelines section.
- Clean fresh adhesive smears with a damp cloth. Dried adhesive can be removed with mineral spirits.
- Do not allow the adhesive to freeze.
- Maximum coverage per quart for V-61 is 110 lineal feet (33.5 m) in a 3" wide (7.6 cm) band.

### Adhesive Application

The entire underfloor should be thoroughly cleaned prior to installation. Remove all dust, dirt, dressings, or waxes that will prevent good adhesive bond. Thoroughly strip existing resilient floors using a solution of ammonia and water or a floor stripper. Apply V-61 adhesive in a 3" wide band around the perimeter of the room, and around any pipes, fixtures, or floor registers, using the appropriate size notched spreader.

Do not apply excessive adhesive.

At all seams, apply adhesive in a 6" wide band centered on the seams. Adhesive spread must be uniform and consistent, with no skips or misses.

Provide tack or open time when using V-61 adhesive. Open time is always dictated by underfloor porosity and atmospheric conditions. Do not allow the adhesive to "skin over" before laying the material into the adhesive. As with full-spread installations, you must roll the material into the adhesive.

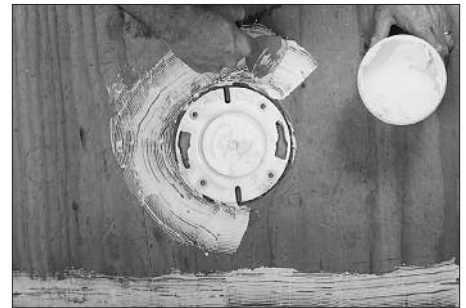

### Flash Coving Perimiflex Products

You may flash cove all Mannington products using the Perimiflex Installation System with traditional flash coving techniques. Follow the general steps outlined on pages 41-42.

To avoid any sharp bends or creases in the material, Mannington recommends using a wooden cove stick at the floor/wall line to support the resilient. You must securely fasten the cove stick to the wall and/or underfloor so it will not pull loose when the Perimiflex material contracts. The adhesive should be fully spread on both the cove stick and the wall, using a small brush to ensure thin, uniform coverage.

We achieve best results when using pattern scribing techniques to fit the material. It is important that the Perimiflex materials are rolled face out until ready to transcribe the pattern. You must transcribe the pattern and cut, fit, and fasten the material into the work area within two hours. It is important to transcribe the material at the same temperature as the job site.

To fill outside corners when flash coving, you can achieve the best results by using boot-type plugs. Seal all inside and outside corners with the appropriate Mannington seam sealer. You may apply seam sealer to inside and outside corners using a cotton swab.

### Finishing & Maintenance

Cover all exposed edges using a restrictive molding such as cove base, wood moldings, or quarter round. Apply a bead of silicone or latex caulk around bathtubs, shower stalls, and toilets. Leave Mannington maintenance and warranty literature with the customer. These are available from your Mannington Distributor.



**NOTE:** It is important to install the flooring as flat as possible before leaving the job site. This is best done by using a soft bristle pushbroom or a lightweight roller. You may also apply hand pressure to smooth out the flooring before fastening. Although most Perimiflex-backed products will be flat and tight within 24 to 48 hours, do not rely on the product's contractibility to compensate for installation-related buckles.

### Repairs

#### Small Cuts

Small cuts will eventually gap open. To repair, clean and compress the material. When the cut is closed, place paper masking tape around the area. Clean dirt from the cut and apply seam sealer. Remove masking tape after 24 hours.

#### Replacing Damaged Areas – Plugs

If you must replace a damaged area, follow these steps:

- Select a design element from the scrap material that matches the design to be removed from the existing resilient.
- Place wide masking tape around the damaged area to hold the floor from pulling back too much.
- Cut on the inside of the grout line, if possible, and remove the damaged piece. If the floor covering you are repairing is installed over existing resilient flooring, be careful not to cut too deep.
- Cut plug from scrap material.
- Lift edges of flooring and apply a band of adhesive carefully under the flooring and in patch area.
- Hold flooring up slightly with a knife or screwdriver to allow in sufficient air circulation to tack up the adhesive.
- Put the patch piece in place and tape two sides securely.
- Slightly warm the Perimiflex flooring and pull it into place until it fits to the patch. Tape securely and roll with a hand roller.
- After 1/2 hour, remove the tape one side at a time. Clean any adhesive that may have squeezed into the seam by passing the back side of a hook knife through the area.
- Apply seam sealer. Cut scrap material in 1/2" widths and place on each side of the seam. Tape over top of these "bridges" to hold material in place while the sealer dries. Do the same procedure with "bridges" on each side of the patch and leave for 24 hours.

### Repair Techniques for Buckled Perimiflex Products

Buckling or bubbling of perimeter-fastened floor coverings has many causes. The most common cause of buckling is mishandling of the material. Mishandling may occur during packaging, roll cutting, or at the time of installation. It is critical to maintain the tension in the product during all phases of handling and storage. It is also important to follow proper installation procedures during each step of the installation. This ensures the material will be flat and remain flat for the life of the floor covering. It is essential for the material to lie flat before leaving the job. Do not rely on the product's contractibility to overcome any fullness or compression-type buckles that are evident when finishing the installation.

If a perimeter-fastened product does buckle or bubble after installation, use the repair techniques below:

- Release the material from the underfloor. Start in an area where you can easily get under the edge of the material (e.g., doorway, corner, etc.). Gently lift the material and insert a dull putty knife under the material. Work the putty knife back and forth at the adhesive line while gently lifting the material edge. Do not exert excessive force on the material. This technique works rather easily on concrete or existing resilient floors. In case of wood panel underlayments, use caution to avoid delamination of the underlayment. Applying heat to the material with a heat gun or hair dryer may make this removal procedure easier. Exercise caution to avoid scorching the face of the resilient sheet.
- Release as much of the product as necessary in the area of the room where most of the buckles occur. Use a soft-bristle pushbroom or a lightweight roller to push the fullness out toward the wall. Retrim the material at the wall line so it lies flat.
- Reapply Mannington V-61 adhesive. Give the adhesive sufficient open time to develop good initial tack. Open time is always determined by underfloor porosity and atmospheric conditions. Typically, the open time will be 10 to 15 minutes. Roll the flooring to ensure good adhesive bond. If you are using staples, space them every 2" around the perimeter. Be certain they are of sufficient length to penetrate the underfloor.

---

**NOTE: Use staples only in areas where restrictive moldings will cover them.**

---

## Resilient Installation Techniques

### Freehand Knifing

All Mannington Residential Resilient products can be fit using the freehand knifing technique. Freehand knifing is accomplished by fitting the material to the room with about 2" of the product lapped up the wall. Avoid using this technique with inlaid resilient products because if they are folded they may break and crack.



Using a sharp knife held parallel to the wall, trim away the excess material until the product is flat on the floor. Hold your cutting hand so the palm faces the wall and is out in front of you within your comfort zone. Ride the knife point at the juncture of the floor and the wall. Make sure the knife blade is flexible enough to allow some pressure to be applied to it. Hook knives and Ward type knives work well, but utility and Airway type knives do not.

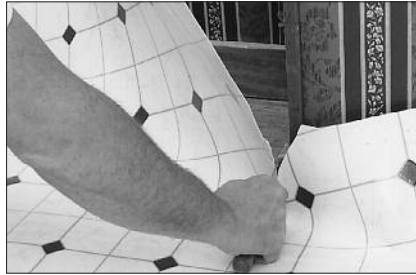

Make outside relief cuts with the floor covering held back from the corner. Cut the material from the face. You can use a pattern design line as a guide to ensure there will be sufficient material to fall around the corner.

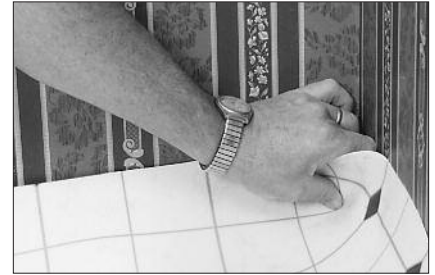

Make inside and outside corner relief cuts before trimming walls. When making any relief cuts, make them all to one side of the room first. If you need to shift floor covering, you can shift it into the cuts. If you make relief cuts on both sides of the room, when you shift the floor covering you will be short of material on one side or the other.



Cut a "V" when making inside relief cuts. Use your left hand to find the corner with your thumb and forefinger. Place them over floor covering into corner about 2" up the wall. Make outside relief cuts with the floor covering held back from the corner. Cut the material from the face.

## Pattern Scribing

Pattern scribing can make installing resilient flooring in those “impossible” areas much easier. By carefully making a template of the room and then removing all excess material, you can turn a difficult job into an easy, perfectly installed floor. Follow the steps below.

When using multiple pieces of scribing paper, carefully butt the sheets together and draw reference lines across both sheets for proper alignment later. Using a roofing square or pencil dividers, transfer the outline of the area being scribed onto the scribing paper. If you're using both a square and dividers, set the width of the dividers to match the width of the leg of the square to minimize mistakes. We advise making lots of notes on the paper.



After all preparation is complete, place scribing paper on the area to be covered. Place the roll-set (curl) downward to make paper positioning easier.



Cut windows in the paper to expose the subfloor and then use masking tape to hold the paper in place. Paper should be rough-trimmed using a utility knife to 1" from all obstructions.



Pencil dividers make it easier to scribe irregular-shaped obstacles. Keep the dividers at a 90° angle to the item being scribed in order to keep the scribe accurate.

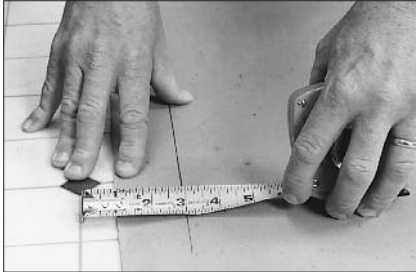

After you have transcribed the entire area to the paper, carefully remove the pattern and place it on the resilient floor covering to be used. Take the time to square the pattern to the resilient floor covering using a tape measure or ruler and be sure to center the pattern.

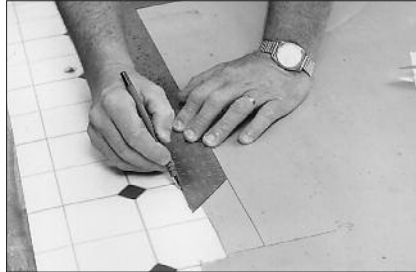

Using the same roofing square or dividers, transfer the marks on the pattern to the sheet goods, making a perfect duplicate of the floor. Be sure to keep the dividers set to the same measurement you started with and use the same leg of the square you used to make the pattern. To ensure correct pattern transfer, the person who performed the pattern scribing should also transfer the pattern onto the resilient flooring.



Follow the pencil marks on the surface of the resilient with a knife or scissors. Use caution so you don't damage the underfloor you're working over. A hookblade utility knife may make this easier.



Now that the transfer and cutout are complete, the material is ready to be installed. The floor covering is an exact duplicate of the floor, with all excess material removed and all cuts made for possible obstacles. Place the material into the room and fasten as required.

# Residential Resilient Installation Guide (continued)

## Direct Scribing

Direct scribing, also known as three-wall scribing, can be used with all Mannington products. Generally this fitting technique is used when the installation area is not complicated.



When installing 6' wide resilient flooring, snap a chalk line 6" off the wall. Also, make two additional reference marks in the center of that area. Snap a chalk line marking the center of the sheet on the floor and mark that same distance with a piece of tape on the wall.

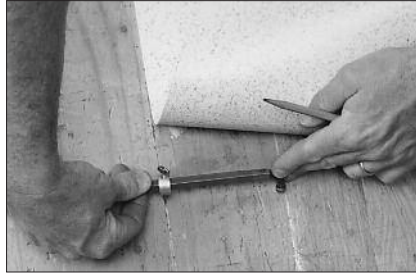

Position material squarely in room with about 2" flashed up each end of wall. Material should be positioned against the long wall overlapping the 6" reference line. Trace the edge of the sheet with a pencil marking onto the subfloor. Set dividers, or bar scriber if you need to transcribe deeper offsets, to the distance between the edge of material (pencil mark) and reference line.



Scribe the contour of the long wall to the resilient flooring with the set bar scriber.



Cut resilient flooring with a hookblade knife along the scribed line.



Slide the resilient flooring to the wall. The sheet should now be positioned on the 6" reference line and next to the long wall.



Now fit the two remaining walls, which we will name Wall A and Wall B. Make a reference mark (key mark) at the edge of the resilient sheet extending onto the subfloor with a pencil. Place a piece of tape on the long wall (the opposite edge of the sheet), visually aligning it to the pencil mark you just made on the resilient and subfloor. You will now have a reference mark on the right side of the sheet and a reference mark on the left side.



Slide the flashing sheet away from the wall (Wall A) until it lies flat on the floor and against the wall. Go back to the key mark you made on the resilient and subfloor and you will notice the mark is no longer in alignment. Set your bar scriber or dividers to that difference.



Slide the resilient flooring to the wall. The sheet should now be positioned on the 6" reference line and next to the long wall.

With the dividers properly set, go back to Wall A and scribe the contour of the wall to the material. Cut the material along the scribed line.



Shift the sheet back on the key marks. When the key marks are aligned, the material will fit next to Wall A. Repeat the process for the opposite wall, Wall B.



## Flash Coving Resilient Sheet Products

All Mannington Resilient sheet goods can be installed using the flash coving method. This edging technique, often preferred by hospitals and other healthcare facilities, is a process of extending the resilient flooring up the wall to create a wall base. Normally, the floor covering is extended up the wall to a height of 4" to 6". Coving is popular with end-users because it eliminates the need for a floor/wall juncture and it is also easy to maintain. As with all resilient installations, proper preparation of the work area is critical to the success of the installation. Clean the underfloor carefully and make certain it is structurally sound. The juncture of the floor and wall also needs special preparation before beginning a coved installation. Follow the instructions below to install the cove cap and the cove stick (cove fillet strip).

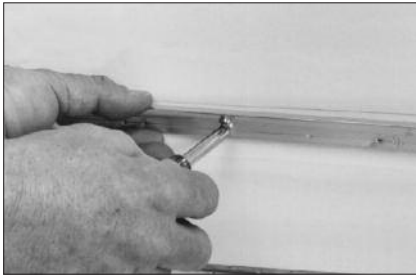

Measure desired height for the cove caps at each corner and strike a chalk line. Attach aluminum or vinyl cove caps at this height using flathead nails with a hammer or brad pusher, or use contact cement. Always miter inside and outside corners in the cap. When mitering the outside corners, file the ends of the cap smooth. You can use a specially designed miter tool with interchangeable die sets to make corners on the cove cap. This tool eliminates sharp edges at the outside corners.

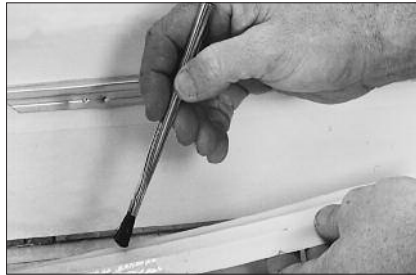

Cove stick supports the resilient flooring as it is flashed up the wall, eliminating the chance of puncturing the resilient flooring. Firmly secure plastic or wood cove sticks where the floor meets the wall with adhesive or nails. Use nonstaining nails and set them flush with the stick. The stick should have a minimum radius of 1-1/8" and be precisely mitered at all inside and outside corners. Provide a smooth transition in the door casings and other areas where the coving ends by cutting back the cove stick.

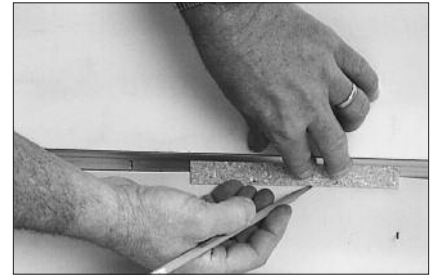

Tack the scribing felt to the wall with brad type nails before you begin to scribe it. Use a combination square, a small metal ruler, or a 1" piece of resilient to pattern scribe the felt. Fit the scribing tool up inside the cove cap and scribe the felt by sliding the tool along the cap as you mark the felt with a pencil.



Scribe and cut the outside corners of the felt using a utility knife.

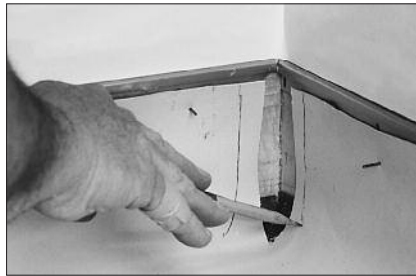

Scribe the inside corners of the felt using pencil dividers.



After scribing the entire work area, position sheet flooring and transcribe the pattern with pencil dividers. Be careful when cutting the material on the inside and outside corners.



Dry fit the material. Inside corners should fit snugly, but not be forced into position. Make sure to always position the shorter side first and then the longer side. Gently pull the material away from the wall.

## Residential Resilient Installation Guide (continued)

Apply the appropriate adhesive to the floor, wall, cove cap, and cove stick. Allow the appropriate amount of open time. Fit the material back into place. Remember to always position the shorter side first. Roll the flooring with the appropriate size roller (use a hand roller on coved areas). Apply the appropriate seam sealer at all seams, following the recommended directions for the resilient floor you are installing.



*The most demanding aspect of a coved installation is forming the outside corners. Fill outside corners with a boot-type plug, rather than a V-type plug, on the least visible wall. The plugged corner fill piece should extend back at least several inches from the corner. The seam of the floor should be below the cove stick. Using an underscriber, scribe the back of the plug at the corner. This will mark the pattern of the corner on the plug.*

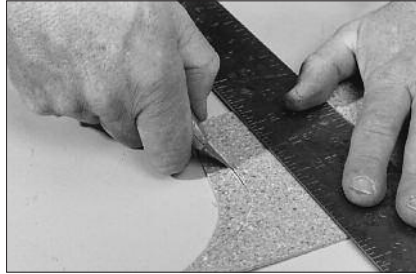

*Cut along the scribed line at a 45° angle with a curved trim knife or a utility blade while holding the plug steady with a metal ruler and your other hand. When cutting, leave the face of the plug longer than the back.*



*Check the fill piece for accurate fit. Make any minor adjustments to the plug as necessary to fill the space correctly. Remove the fitted fill piece and apply the appropriate adhesive. Reposition the fill piece and apply seam sealer.*



# Adura® Luxury Floors Installation Guide

## General Information

All of the general installation instructions stated in General Installation Guidelines regarding storage and job site conditions, including climatic and structural requirements, are applicable to Adura® Luxury Floors. Review and consider these requirements before proceeding with the installation.

These installation specifications are for all Fully Adhered installations of Mannington Adura® Luxury Floors. Recommendations are based on the most recent available information. All instructions and recommendations must be followed for a satisfactory installation.

- Adura® Luxury Floors must be stored and installed in climate-controlled interior locations where the temperature can be regulated to between 65° and 85° F.
- Install Adura® Floors only after the job site has been cleaned and cleared of other trade apparatus that may damage a finished installation.
- Before installation always, check the cartons to ensure the pattern number is correct. Work from several cartons to mix design elements. Do not “cluster” similar design elements.
- All subfloor/underlayment patching must be done with a non-shrinking water resistant Portland cement patching compound such as Mannington MVP-2023.
- Never install Mannington resilient product over residual asphalt-type (cut back) adhesive. It can bleed through the new floor covering. Residual asphalt-type adhesive must be thoroughly removed or covered with underlayment plywood or Mannington latex underlayment.
- Adura® Luxury Floors are to be adhered with Mannington MT-711. MT-711 is a solvent-free, acrylic-based pressure sensitive adhesive that is appropriate with Mannington resilient and carpet modular flooring products.
- Use only Adura® Luxury Grout when grouting is desired.

All precautions and requirements regarding subfloor selection and preparation found in the General Installation Information section apply to Adura® Luxury Flooring.

## Installation

### Tile Layout

As with all tile formats, Adura® tiles should be “balanced” in the work area. Tiles may be laid squarely in the work area or laid out diagonally in the work area. In either case, the room must be accurately measured to square off the area and to determine the center point of the area. The work area should be divided into quadrants designated by striking chalk lines. It is critical that the intersection of the chalk lines be square at 90°. All border tiles should be of nearly equal dimensions and at least one-half of a tile wide. Careful and precise measurements must be taken during tile layout. Lay all tiles in the same direction with all directional arrows pointing in the same direction.

### Plank Layout

It is also important to balance the layout of the plank format. Proper planning and layout will prevent narrow plank widths at wall junctures. Determine layout to prevent having less than half a plank width (2") or very short length pieces. As with all plank products, lay the long dimension of the plank parallel to the long dimension of the work area. Accurately measure the room to determine the center line; adjust this established line to accommodate a balanced layout and then transpose this line to a comfortable width away from the starting wall (approximately 2' to 3' wide). Apply the adhesive in this area and begin installing planks.

## Combinations – Tile and Plank Layout

The modularity of Adura® Luxury Flooring allows for interesting and decorative combinations of tile and planks. When determining proper layout for this custom installation, it is important to consider the dimensions of the modular “design unit” and then balance the design unit in the work area. Careful and precise measurements must be taken to ensure success with a combination design.

## Adhesive Application

Mannington MT-711 adhesive is required for adhering Adura® to all approved substrates. Apply the adhesive with a 1/16" wide, 1/16" deep, and 1/16" apart notched trowel. The MT-711 adhesive should be given sufficient open time so that the trowel ridges appear “cloudy” or “hazy” and the trowel “valleys” are clear. The adhesive must be sufficiently tacky to prevent tile slippage during placement. Do not allow adhesive to tack up over night.

## Tile Installation

After the MT-711 has had sufficient open time, begin laying the tile at the intersection of the working lines. Be certain this tile is installed squarely on the lines. After the first tile is in place, begin laying tiles outward along both guide lines. Press tiles firmly against adjoining tiles and press into the adhesive. Begin stair-stepping the tiles into the field area. Maintain the squareness of the installation by keeping tiles along guide lines. Lay all tiles in the same direction, all directional arrows pointing in the same direction.

## Plank Installation

After the MT-711 adhesive has had sufficient open time, begin laying planks along the designated starting line. Planks ends should be staggered in a random manner so as to avoid clustering the end joints. Varying the length of the starting plank can assure sufficient stagger of end joints. End joints should be staggered by at least 4". Pay particular attention to the randomness of the plank layout; avoid establishing a repeating pattern. Continue installing the planks in a random fashion and complete each area before beginning the next. If required, use a kneeling board to avoid walking on freshly installed planks.

## Cutting and Fitting Border Tiles and Planks

Adura® luxury floors can be cut with a large tile cutter or by using the score and snap technique. Direct or pattern scribe the tiles to fit into complicated, irregular walls or pipes, etc.

## Grouting Adura® Tile

Certain Adura® Luxury Floor tile patterns and Homestead Collection tile patterns lend themselves to the design option of applying a specially produced acrylic grout between the tiles. Specific installation procedures must be followed when grouting Adura® tiles.

### 1. Required tools

- Hard-edge rubber grouting float
- Dense, square-edge sponge
- Nylon scrubbing pad
- Water buckets
- Plastic tile spacers



# Adura® Luxury Floors Installation Guide (continued)

## 2. Procedure



The desired grout width must be determined before tile layout begins. It's critical to include grout width measurement to tile size to ensure a balanced layout. Grout width should be at least 1/16" wide and no more than 1/4" wide. Commercially available hard plastic ceramic tile spacers may be used to maintain equal grout joint width.



Tiles may be grouted immediately after installation. Insure that the tiles are firmly bonded to the subfloor by re-rolling the entire installation with a three-section 100 pound (or heavier) floor roller just prior to grouting. Be certain to clean any debris from grout joints.

Only Mannington acrylic grout may be used with Adura® Luxury tiles. This pre-mixed grout has been developed to bond to Luxury vinyl tiles and is flexible and durable. **Never use cement-based, epoxy or furan grout.**



Apply the acrylic grout in to the tile joints with the narrow edge of the rigid rubber float. Firmly pack each tile joint so as to leave no voids or skips. As each tile joint is grouted, remove excess grout from tile edges with the stiff edge of the float pulled in a 45° angle across each joint. Grout only in small increments and clean each section as you go. Never apply grout in an area greater than 20 square feet without stopping to clean.



Use a dampened nylon scrubbing pad to loosen remaining grout from the tile surface. Wipe alongside the joint with the nylon pad to avoid removing grout from the joint. Do not use excessive water during cleanup.



Use the special square edge sponge to remove the excess water and grout haze. Be certain to wipe diagonally across tile joints to avoid dragging grout from the joint. Rinse the sponge frequently and change the cleanup water frequently. Thoroughly remove all residual grout and grout haze before leaving the job. Dried grout haze is difficult to remove.



If a slight grout haze is noticed after 24 hours, it can be removed by scrubbing with the nylon pad and a solution of 1/4 cup ammonia in a gallon of clean water. Thoroughly rinse the area with clean water. **Do not use chemical grout cleaners.**

If skips or voids in the grout joint are discovered after final cleanup, they can be filled by applying new grout directly over the old.

### Finishing the Job

Adura® luxury floors must be rolled with a minimum 100-pound three-section floor roller immediately after installation. Before grouting, roll the flooring in both directions to firmly seat the tile into the adhesive.

Cover all exposed edges. Use wood molding or vinyl cove base along all walls, cabinet toe kicks, etc. Use transition strips in doorways or where new flooring joins another floor covering. Caulk along tubs, toilet bowls, etc.

Do not wash the floor for 48 hours after installation. After 48 hours, damp mop to remove residual surface dirt. Follow appropriate maintenance schedule for Adura® luxury floors.

### Repairing Adura® Tile and Plank

Although the wear surface of Adura® plank and tile is durable, it is not bulletproof. Should an accident occur that damages the surface of the product, a simple repair procedure exists. The key to this process is having ample material available to replace the damaged area(s). This should be considered when placing the original order. Extra tiles and planks should be wrapped in their packaging and stored in an interior, climate-controlled location.

To remove a tile or plank, gently heat with a hot-air blower to allow the material to become more flexible. Insert a thin 2" wide putty knife in the seam and gently lift up. Be careful not to damage the surrounding flooring. Remove the damaged tile or plank from the floor. When removing a tile, pay attention to the orientation of the embossed arrow on the back of the damaged piece so that the new tile can be installed in the same direction. Inspect the subfloor for lumps of residual adhesive, remove and smooth out as necessary.

Using a 1/32" notched trowel, apply a thin coating of MT711 to the back of the replacement piece. Consider the thickness of the residual adhesive layer when determining the appropriate adhesive application to the replacement piece; too much adhesive will cause the replacement flooring to be higher than the surrounding tile or plank. Provide sufficient open time (typically 15 minutes) and then position the tile or plank into the repair area. Roll evenly with a hand roller and, if necessary, weight the tile or plank for several hours until the adhesive sets.

If the tile was grouted, the grout must be removed and replaced during tile replacement.

### Cautions and Miscellaneous

- Furniture should be moved onto the newly-installed floor, using an appliance hand truck over hardboard runways.
- Do not place heavy items on newly-installed floor covering for at least 24 hours after completion of the installation. Heavy furniture should be equipped with suitable non-staining, wide-bearing casters.
- Floor covering subjected to excessive heat and light exposure is subject to thermal degradation. Use appropriate precautions to minimize potential effects on the floor covering.
- Oil- or petroleum-based products can result in surface staining. Do not track asphalt driveway sealer or automobile oil drips onto the vinyl floor covering.
- Use non-staining walk-off mats. Rubber can discolor resilient floor coverings.
- To achieve maximum product performance, Mannington Adura® floors should not be installed over existing resilient floor coverings. In the rare cases where removal of the existing resilient floor covering is not an option, the existing flooring must be covered with MANNINGTON MVP 2023 used as an Embossing Leveler or other appropriate porous underlayment.

### Mannington MUL - The Prefect Solution for Problem Subfloors

Mannington MUL is a six-foot wide vinyl-coated sheet designed to be used as an underlayment with Adura and Adura Elements when the subfloor is not suitable for a fully adhered resilient product or when removal of the flooring system is being considered. These two options are possible because the Mannington MUL is not adhered directly to the subfloor but rather is permitted to "float" over the questionable subfloor. These subfloors are:

- Gypsum underlayments
- Residual adhesives
- Painted subfloors
- Stripwood hard wood floors
- Oriented Strand Board
- Flakeboard
- Particleboard
- Existing ceramic tile ( properly prepared)
- Concrete (on all grade levels)
- Existing resilient vinyl floors

Mannington MUL is available in 85 square yard rolls 6' wide by 127.5' long. Also available in 170 square yard rolls 6' wide by 255'.

## Directions for Use

Mannington MUL is intended to be used in climate controlled indoor residential locations only.

## Subfloor Considerations

Although MUL may be used over many unconventional subfloor systems it is still critical that these subfloors are clean, dry, smooth, flat and structurally sound.

MUL will bridge minor cracks on the same plane on concrete subfloors. MUL is not intended for use over expansion joints (structural design joints) or structural (out-of-plane) movement cracks.

## MUL Installation

- Thoroughly sweep or vacuum the entire work area.
- Plan the MUL layout so that the seams of the MUL do not coincide with the seams in the finished product. When installing Adura plank position the MUL sheets perpendicular to plank layout.
- When installing MUL over residual adhesive the adhesive must be scrapped smooth and have no residual tack.
- Unroll the MUL vinyl side down just prior to beginning the flooring installation.
- Trim the MUL back approximately 1/8" to 1/4" from all fixed vertical surfaces.
- Align the factory edges of the MUL and secure with 2" wide thin, clear tape.
- When installing Adura Luxury Flooring apply Mannington MT 711 with a 1/16" wide, 1/16" deep, 1/16" apart notched trowel. Begin applying adhesive at the pre-determined chalk lines, and provide sufficient open time so that the trowel ridges appear "cloudy" or "hazy" and the trowel "Valleys" are clear. The adhesive must be sufficiently tacky to prevent tile slippage during placement. DO NOT ALLOW ADHESIVE TO DRY AND TURN CLEAR.
- Fit the Adura Luxury flooring to the edges of the MUL sheet, maintaining the 1/8" to 1/4" expansion/contraction gap.
- Roll the Adura Luxury Flooring with a minimum 100 pound three-section floor roller immediately after installation. Roll the flooring in both directions to firmly seat the tile into the adhesive.
- When installing wall base or transitions strips do not fasten through the finished flooring or the MUL.

## ADURA Loc N'Go Luxury Flooring

### General Information

These installation specifications are for Loc-N'-Go Luxury Plank flooring. All recommendations are based on the most recent available information. All instructions and recommendations must be followed for a satisfactory installation.

- The floor covering should be stored and installed in climate controlled indoor locations – Temperature 65°- 85°F.
- Install Loc-N'-Go Luxury Plank flooring only after the jobsite has been cleaned and cleared of other trade apparatus that may damage a finished tile installation.
- To minimize shade variation, mix and install planks from several different cartons.
- All subfloor / underlayment patching must be done with a non-shrinking water resistant Portland cement patching compound such as Mannington MVP-2023.



## Subfloor Information

Although the Mannington Loc-N'-Go Luxury Plank flooring is installed as a "Floating" floor, correct preparation of the subfloor is still a major part of a successful installation. Roughness or unevenness of the subfloor may telegraph through the new floor covering, resulting in an unsightly surface and excessive wear on high spots.

## Wood Subfloors

### General

All wood floors must be suspended at least 18" above the ground. Adequate cross-ventilation must be provided and the ground surface of a crawl space must be covered with a suitable vapor barrier. Wood subfloors directly on concrete or installed over sleeper construction are not satisfactory for the installation of Mannington Loc N Go flooring products.

All wood and wood composition panels are suitable for use under Loc n Go flooring providing that they are smooth, flat, structurally sound and free of deflection. This includes plywood, particleboard, oriented strand board (OSB), flakeboard and wafer board.

If the surface of the wood subfloor is not smooth, a ¼" underlayment panel should be installed over the subfloor.

### Concrete Subfloors

- Concrete subfloors must be dry, smooth, and free from dust, solvent, paint, wax, grease, oil, asphalt sealing compounds and other extraneous materials. The surface must be hard and dense, and free from powder or flaking.
- New concrete slabs must be thoroughly dry (at least six weeks) and completely cured.
- All concrete slabs must be checked for moisture before installing material. Details for moisture testing can be found in the Mannington Professional Installation Guide.

The final responsibility for determining if the concrete is dry enough for installation of the flooring lies with the floor covering installer.

Although the Loc- N' Go is not susceptible to damage from moisture, excessive subfloor moisture is an ideal breeding ground for mold, mildew and fungus. All of which can contribute to an unhealthy indoor environment.

- Holes, grooves, expansion joints and other depressions must be filled with Mannington MVPP 2023 Latex Underlayment (or equivalent), and troweled smooth and feathered even with the surrounding surface.
- Concrete floors with a radiant heating system are satisfactory, provided the temperature of the floor does not exceed 90°F at any point. Before installing the flooring, the heating system should be turned on to eliminate residual moisture.

### Existing Floor Coverings

Loc' N –Go can also be installed over most existing hard –surface floor coverings provided that the exiting floor surface can be made smooth.

- Ceramic tile should be made smooth by applying a cementitious overlay such as patching or leveling compound.
- When the removal of the existing resilient floor covering is not an option, the existing flooring must be covered with MANNINGTON MVP 2023 used as an Embossing Leveler or equivalent. Existing sheet vinyl floors should not be heavily cushioned and consist of one layer only.

## Installation

### Plank Layout

Loc N Go is designed to be installed as a “floating” floor. Do not secure the planks to the subfloor. Always undercut all doorjamb. Do not install cabinets or kitchen islands on top of Loc N Go. Use care when installing wall moldings and transition strips to not fasten through the Loc N Go planks. Do not install in areas that receive excessive direct sunlight. Do not exceed a runs of 40' without providing additional expansion gap.

- It is important to balance the layout of the plank format. Proper planning and layout will prevent narrow plank widths at wall junctures. Determine layout to prevent having less than ½ plank width (2”) or very short length pieces.
- As with all plank products, lay the long dimension of the plank parallel to the long dimension of the work area.
- Accurately measure the room to determine the centerline, adjust this established line to accommodate a balanced layout and then transpose this line to a comfortable width away from the starting wall (approximately 2' to 3' wide). Determine if the starter row will need to cut. If not, it will be necessary to cut off the overhang adhesive tab, both along the full length of the plank and the end adhesive tab.
- Position the first plank so that both the head and side seam bottom adhesive tab is exposed. This requires installing the product from left to right in the room.
- Install two planks in the first row, positioned approximately 1/8” from the wall. Then cut a plank to length to start the second row, stagger the end seam at least 6” from the first plank.
- Align the top adhesive tab over the exposed bottom adhesive tab of the first plank in the first row and bring the decorative faces tightly together before engaging the adhesive tabs.
- Install the second plank in the second row in the same manner.
- Work across the length of the room installing planks along the wall in the first row and then aligning the planks in the second row. It is critical to keep these two rows straight and square, as they are the “foundation” for the rest of the installation. Check squareness and straightness often.
- If a plank is misaligned during installation, carefully pull up to release the adhesive bond on the tabs, reposition and re-engage the adhesive tabs. The longer the adhesive tabs are in contact the more difficult it will be to separate them.
- Once proper plank alignment is assured the adhesive tabs should be rolled with either a hand seam roller or a three-section floor roller to insure full and permanent contact of the adhesive tabs.
- Cut the last plank in the first row to fit approximately 1/8” short of the end wall. Planks may be cut with a utility knife using the “score and snap” technique. Often times the remainder of this plank may be used to start the third row.
- Continue installing planks, being certain to maintain a random appearance and offset end seams by at least 6”.

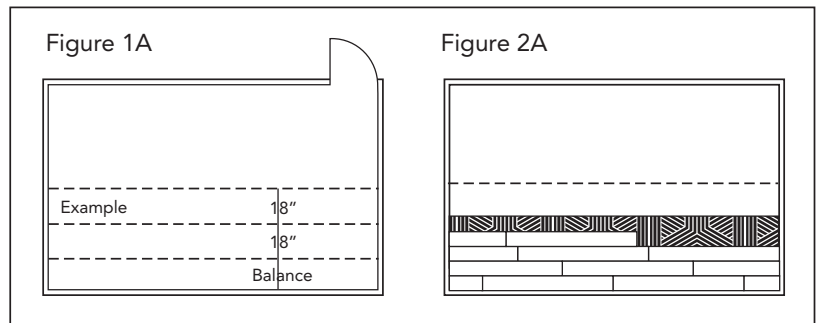

- When fitting around obstacles or into irregular spaces Mannington Loc N Go can be cut easily and cleanly using a utility knife with a sharp blade. It is often beneficial to make a cardboard template of the area and transfer this pattern to the plank.
- Roll the completed installation in both directions with a 100 lbs three-section floor roller.
- Protect all exposed edges of the Loc N Go by installing wall molding and/or transition strips. Use caution to prevent the fasteners from securing the planks to the subfloor.

### Repairs

#### Plank Replacement

If a plank becomes damaged the following replacement procedure should be used:

- Using a straight edge and a sharp utility knife cut out and remove, about a 2" strip of the center of the plank. This will allow you to determine the location of the top and bottom adhesive strips of the damaged plank.
- Position a straight edge along the side seam on the bottom adhesive tab of the damaged plank and cut through the plank. This will leave the adhesive tab of the damaged plank in place, under the adjoining plank.
- Use a heat gun to help release the adhesive and slowly and carefully peel away top adhesive tab of the damaged plank from the adjoining plank.
- Insert a 2" putty knife under the adjoining plank to remove the bottom adhesive tab of the damaged piece. Once a corner is loosened, the tab can be folded under and peeled away.
- Slip a sheet of waxed paper (lining paper) under the adjoining plank(s), slip the bottom adhesive tab of the replacement plank under the waxed paper and position the top adhesive tab in place.
- Carefully remove the waxed paper to allow adhesive contact on the replacement plank and the adjoining plank(s).
- Roll the adhesive tabs with a hand roller to assure good bond.

## Resilient Installation Accessories

### Mannington Adhesives & Sealers

Using the proper installation accessories for a job not only reduces the chance of installation failure, but also adds to the integrity and life of a floor. We have specially engineered each of our products to meet the needs of the appropriate Mannington floor covering to produce optimum end results. We constantly strive to improve all of our products. Regular product enhancements increase the level of performance and ease of use for the installer, but we always stress the importance of adhering to all proper installation procedures.

The following products are available from your local Mannington Distributor and Retailer. Follow all directions on each product's packaging and the information contained in this handbook. If you have any questions regarding a product, contact your local Mannington Distributor or contact Mannington Mills, Inc.

### V-31 Premium Latex Adhesive

#### Description:

V-31 adhesive is a nontoxic, nonflammable, light-colored, latex-based adhesive. It provides a water- and alkali-resistant bond for all Mannington Residential felt-backed floor coverings. You can use it over all approved suspended wood underlayments; on-, above-, or below-grade fully cured concrete; and on existing smooth, non cushioned, tightly bonded resilient floor coverings.

#### Features:

- Easy application
- VOC-compliant/solvent-free/low odor
- Non flammable
- Moisture- and alkali-resistant
- Readily identifiable mylar chips
- Contains fungicide protection
- Complies with SCAQMD Rule 1168

#### Directions:

Make sure the underfloor is clean and free of all foreign matter such as dirt, paint, oil, wax, etc. It must be smooth and level. Sand off high spots and fill low spots, cracks, holes, etc., with the appropriate Mannington patching compound.

Maintain the adhesive, floor covering, and job site at a temperature of at least 65°F for a minimum of 48 hours before, during, and after the installation.

#### Porous Substrate



On porous underfloors, apply the adhesive with a trowel having notches 1/16" wide, 1/16" deep, spaced 1/16" apart.

#### Nonporous Substrate

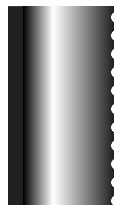

On nonporous underfloors, apply a thinner spread of adhesive using a trowel with notches 1/16" wide, 1/32" deep, spaced 1/32" apart.

Lay the floor covering into the adhesive to avoid trapping air under the sheet. Do not drop or flop the material into the adhesive. Allowing some open time will eliminate the possibility of gas bubbles or adhesive displacement. (This is especially important on nonporous underfloors.) Do not allow the adhesive to form a skin or to overdry.

Immediately roll the adhered material in both directions using a 75-lb (or heavier), three-section floor roller.

You can clean fresh adhesive smears with water. Dried adhesive can be removed with mineral spirits.

Avoid heavy traffic on the finished installation for 24 hours.

#### Coverage:

Approximately 135 to 180 sq ft per gallon

#### Packaging:

4-gallon pail #839835  
44 lbs (19.98 kg)

1-gallon can (4 per carton) #839831  
Carton weight 44 lbs (19.98 kg)



#### Precautions:

- Do not use with Perimiflex or any other vinyl-backed materials.
- Do not use where excessive moisture, alkali, or hydrostatic pressure exists.
- Use with adequate ventilation.
- Avoid contact with eyes.
- Do not ingest.
- KEEP OUT OF THE REACH OF CHILDREN.

## Resilient Installation Accessories (continued)

### V-61 Perimiflex Adhesive

#### Description:

V-61 adhesive is a latex adhesive for use with Mannington Perimiflex products installed over porous and non-porous underfloors. You can use it over all approved suspended wood underlayments, concrete floors of all grade levels, and existing vinyl floors.

#### Features:

- Smooth, easy troweling
- Low odor
- Nonflammable
- Plasticizer-resistant
- Easy cleanup with water
- Readily identifiable Mylar chips

#### Directions:

V-61 is intended for use on porous and nonporous underfloors. Make sure the underfloor is clean and free of all foreign matter such as dirt, paint, oil, wax, etc.

Maintain the adhesive, floor covering, and job site at a temperature of at least 65°F for a minimum of 48 hours before, during, and after the installation.

Apply V-61 with the supplied trowel in approximately a 3" wide band around the perimeter of the room and around any pipes, fixtures, or floor registers.

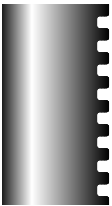
**Porous Substrate**  

 On porous underfloors, apply the adhesive with a trowel having notches  $\frac{1}{16}$ " wide,  $\frac{1}{16}$ " deep, spaced  $\frac{1}{16}$ " apart.

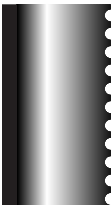
On nonporous underfloors, apply a thinner spread of adhesive using a trowel with notches  $\frac{1}{16}$ " wide,  $\frac{1}{32}$ " deep, spaced  $\frac{1}{32}$ " apart.

**Nonporous Substrate**  

 Spread V-61 in approximately a 6" wide band centered on all seam lines. Keep the adhesive spread uniformly and consistently, with no skips or misses. Do not apply excessive adhesive.

Provide adequate tack or open time when using Perimiflex\* adhesives. Do not allow adhesive to "skin over" before laying the material into the adhesive.

Roll the adhered areas with a hand seam roller to embed the material into the adhesive.

Clean fresh adhesive smears with water. Remove dried adhesive with mineral spirits.

\*When applying V-61 adhesive over nonporous surfaces, it is best to provide approximately a 10-minute open time before placing the flooring material into the adhesive.

#### Coverage:

Maximum coverage for V-61 is 110 lineal feet (33.5 m) in a 3" wide (7.6 cm) band per quart.

#### Packaging:

1-quart can (12 per carton) #839861  
 Carton weight 36 lbs (16.3 kg)

#### Precautions:

- Keep adhesive from freezing
- Use with adequate ventilation
- Vapor is harmful
- Do not ingest
- Avoid contact with eyes
- KEEP OUT OF THE REACH OF CHILDREN

### MT-711 Adhesive Mannington Adura® Flooring and Sobella™ (Fully Adhered)

#### Description:

Mannington MT-711 adhesive is pressure sensitive, solvent free, and acrylic based. It is nonflammable, and anti-microbial with zero calculated VOC's.

#### Features:

- Easy application
- VOC-compliant/solvent free/low odor
- Non-flammable
- Moisture and alkali resistant
- Readily identifiable mylar chips
- Contains fungicide protection
- Complies with SCAQMD Rule 1168

#### Substrate Preparations:

The floor must be sound, smooth, dry and clean. Mechanically remove any dirt, wax, loose paint, dry adhesive and all foreign matter that would interfere with a good bond. Cutback adhesive must be removed and/or covered prior to applying adhesive for installing Mannington flooring. The installation site must be temperature and humidity controlled by the use of permanent HVAC or equivalent system. The floor and room temperature as well as flooring materials and adhesive, must be maintained at 65° - 95° F (18.3° - 35.0° C), and the humidity below 65% for 48 hours prior to, during, and after the testing and installation. Do not use on substrates that have been chemically cleaned.

Concrete subfloors must be tested for moisture vapor emissions rate (MVER) per Calcium Chloride Test Method ASTM F1869, or for in-situ Relative Humidity per ASTM F2170. The surface pH must not exceed 9.0. MVER of concrete substrates must be below 3.0 lbs., or with in-situ Relative Humidity below 75% per ASTM F2170. Site conditions, floor preparations, and moisture and alkalinity must comply with either appropriate ASTM F710 or CRI 104 guidelines.

## Resilient Installation Accessories (continued)

### Installation Procedures:

#### Mannington Residential Adura® Luxury Vinyl Floors

Apply Mannington MT-711 adhesive with a  $\frac{1}{16}$ " x  $\frac{1}{16}$ " x  $\frac{1}{16}$ " U-notched trowel. The MT-711 adhesive should be given sufficient open time so that the trowel ridges appear "cloudy" or "hazy" and the trowel "valleys" are clear. Begin applying adhesive at the intersection of the chalk lines, spread only as much adhesive as can be covered before the adhesive becomes completely clear. The adhesive must be sufficiently tacky to prevent slippage during placement. Do not spread adhesive in an area too large to control adhesive tack times. Adhesive coverage is approximately 150 square feet per gallon. (3.68 m<sup>2</sup>/L).

#### Mannington Sobella® Residential Sheet Flooring

When the Fully Adhered Installation System is used, apply the MT-711 adhesive with a  $\frac{1}{16}$ " x  $\frac{1}{32}$ " x  $\frac{1}{32}$ " U-notched trowel over 100% of the exposed subfloor, avoiding puddles or thin spots. Immediately after adhesive application, gently position the sheet into the adhesive. If the subfloor is non-porous provide some additional open time. Roll the material in both directions with a 75 - 100 lbs. (34.9 - 45.4 Kg), or heavier three-section floor roller. When the Loose Laid Installation System is used, apply the adhesive in a 6-inch band centered on the seam using a  $\frac{1}{16}$ " x  $\frac{1}{32}$ " x  $\frac{1}{32}$ " U-notched trowel. Also apply adhesive around any in-floor forced air vents. Adhesive coverage is approximately 25 square feet per gallon (5.52 m<sup>2</sup>/L).

### Packaging:

1-gallon pail #849889, weighs approximately 9 lbs (4.08 kg) 4 per carton

4-gallon pail #849886, weighs approximately 37 lbs (16.33 kg)

### Precautions:

- Use with adequate ventilation
- Do not use where excessive moisture, alkali, or hydrostatic pressure exists
- Do not apply directly over gypsum-based surfaces
- Prevent prolonged breathing of vapor and skin contact
- Avoid contact with eyes
- KEEP OUT OF THE REACH OF CHILDREN

## Seam Sealers/Applicators

### MSS 20 Standard Sealer

#### Description:

MSS 20 is used to seal all seams in Mannington Resilient products with a vinyl wearlayer. MSS 20 provides a chemical "weld" to provide a continuous, impervious surface. A properly sealed seam will be as strong as the surface of the floor covering, and will remain intact for the life of the floor.

#### Directions:

Prior to sealing the seam, make certain all seams are clean, dry, and free of adhesive contamination.

Fill the VST-96 professional applicator bottle (sold separately) at least  $\frac{2}{3}$  full of sealer. After securing the VST tip to the applicator bottle, allow the bottle to stand until all air bubbles have dispersed.

Check the flow of the sealer through the fin on a scrap piece of flooring prior to use.

Use the forefinger of one hand on the top flat portion of the tip to guide and ensure proper fin penetration. Use the other hand to control sealer flow. Hold the bottle at approximately a 45° angle.

Lightly squeeze the bottle to apply a uniform bead of sealer approximately  $\frac{1}{8}$ " wide, centered on the seam cut.

**It is crucial that the seam sealer penetrate the full thickness of the seam cut to ensure a proper chemical weld.**



## Resilient Installation Accessories (continued)

Allow the sealed seam to dry at least one hour before permitting traffic on the floor. Avoid walking or moving furniture directly over the sealer until it is fully dry; 24 hours is recommended. Mark the seam by placing scrap pieces of flooring on both sides of the seam.

When sealing multiple seams, keep applicator tip open by inserting the supplied cleaning wire.

After all seams are sealed, pour unused sealer back into pint can. Do not store seam

sealer in the applicator bottle. Thoroughly rinse the applicator bottle and tip with a solvent such as mineral spirits. Insert cleaning wire into applicator tip to keep it clear. Applicator bottle can be reused. Prior to use, make certain the applicator bottle is dry and completely clean.

### Coverage:

One pint of MSS 20 seam sealer will seal approximately 400 to 600 lineal feet of seams.

MSS 20 is also available in 2-oz consumer tubes (MCT 20) designed for do-it-yourself consumers. One tube will seal approximately 60 to 90 lineal feet.

### Packaging:

1-pint can (12 per carton) #832202  
Carton weight 15 lbs (6.8 kg)

2-oz tube (12 per carton) #832203  
Carton weight 3 ¼ lbs (1.5 kg)

### Precautions:

- Flammable liquid. Do not use near heat, sparks, pilot lights, fire, or other open flames
- Do not ingest
- Use with adequate ventilation
- Avoid contact with skin and eyes
- Avoid prolonged breathing of vapors
- Keep container tightly closed when not in use
- KEEP OUT OF THE REACH OF CHILDREN



## High Gloss MHS 22 Urethane Sealer Kit

### Description:

MHS 22 sealer (two-part seam sealer) is designed for Mannington products with high-gloss urethane-based wearlayers. There is no substitute sealer available. A properly sealed seam will be as strong as the surface of the floor covering, and will remain intact for the life of the floor. The new Versatile Sealing Tip (VST-96) is included in this kit.

### Directions:

Prior to sealing, be certain all seams are clean, dry, and free of adhesive contamination.

Empty entire contents of Parts A and B into the supplied applicator bottle. After securing the VST tip to the applicator bottle, gently shake the bottle to mix the ingredients. Allow the bottle to stand until all air bubbles have dispersed, typically 15 minutes.

Prior to use, check the flow of the sealer on a scrap piece of flooring.

Use the forefinger of one hand on top of the flat portion of the tip to guide and ensure proper fin penetration. Use the other hand to control sealer flow. Hold the bottle at approximately a 45° angle.

Lightly squeeze the bottle to apply a uniform bead of sealer approximately 1/8" wide centered on the seam cut.

**It is crucial that the seam sealer penetrate the full thickness of the seam cut to ensure a proper chemical weld.**

Allow the sealed seam to dry before traffic is allowed on the floor. Do not walk on or move heavy furniture directly over the sealer until it is fully dry. We recommend 24 hours. Mark the seam by placing a scrap piece of flooring along each side of the seam.

MHS 22 **cannot** be saved for reuse. Safely discard any unused sealer.

### Coverage:

One kit of MHS 22 will seal approximately 70 lineal feet of seams.

### Packaging:

6 kits per carton #832222  
Carton weight 3 lbs (1.4 kg)

### Precautions:

- Flammable liquid. Do not use near heat, sparks, pilot lights, fire, or other open flames
- Do not ingest
- Avoid contact with skin and eyes
- Use in well-ventilated areas
- Avoid prolonged breathing of vapors
- Do not save for reuse
- KEEP OUT OF THE REACH OF CHILDREN

## Resilient Installation Accessories (continued)



### Low Gloss MLG 33 Urethane Sealer Kit

#### Description:

MLG 33 sealer (two-part seam sealer) is designed for Mannington products with low-gloss vinyl or urethane-based wear-layers. A properly sealed seam will be as strong as the surface of the floor covering, and will remain intact for the life of the floor. The Versatile Sealing Tip (VST-96) is included in this kit.

#### Directions:

Prior to sealing, be certain all seams are clean, dry, and free of adhesive contamination.

Part B, which contains the de-glossing agent, must be shaken vigorously before blending with Part A.

Empty entire contents of Parts A and B into the supplied applicator bottle. After securing the VST tip to the applicator bottle, gently shake the bottle to mix the ingredients. After mixing, the bottle should stand until all trapped air bubbles have dispersed, typically 15 minutes.

Prior to use, check the flow of the sealer on a scrap piece of flooring.

Use the forefinger of one hand on top of the flat portion of the tip to guide and ensure proper fin penetration. Use the other hand to control sealer flow. Hold the bottle at approximately a 45° angle.

Lightly squeeze the bottle to apply a uniform bead of sealer approximately  $\frac{1}{8}$ "

wide centered on the seam cut.

**It is crucial that the seam sealer penetrate the full thickness of the seam cut to ensure a proper chemical weld.**

Allow the sealed seam to dry before traffic can be allowed on the floor. Do not walk on or move heavy furniture directly over the sealer until it is fully dry. We recommend 24 hours. Mark the seam by placing a scrap piece of flooring along each side of the seam.

MLG 33 **cannot** be saved for reuse. Safely discard any unused sealer.

#### Coverage:

One kit of MLG 33 will seal approximately 70 lineal feet of seams.

#### Packaging:

6 kits per carton #832233  
Carton weight 3 lbs (1.4 kg)

#### Precautions:

- Flammable liquid. Do not use near heat, sparks, pilot lights, fire, or other open flames
- Do not ingest
- Avoid contact with skin and eyes
- Use in well-ventilated areas
- Avoid prolonged breathing of vapors.
- Do not save for reuse
- KEEP OUT OF THE REACH OF CHILDREN



### ST-96 Professional Applicator Kit

#### Description:

The Professional Seam Sealer Applicator Kit contains a 4-ounce bottle, a tip cleaning pin, and the Versatile Sealing Tip (VST-96). The kit is intended to be used with Mannington MLG 33 and MCS 42 seam sealers. (MLG 33 seam sealer kits contain the VST-96.) The ergonomic design and specially engineered tip help apply the appropriate amount of seam sealer while completely penetrating the seam cut for all Mannington Residential and Commercial Resilient sheet flooring applications. Prior to sealing seams in all products, make certain that all seams are clean, dry, and free of adhesive contamination.

#### Packaging:

6 per carton #832204  
Carton weight 2 lbs (0.9 kg)



## Resilient Installation Accessories (continued)

### Floor Care Products

#### Mannington Award Series® Floor Care Products

This is the most professional way to keep Mannington Resilient floors looking new. It gives consumers the materials needed to clean and maintain their new floor from day one.

##### Rinse-Free Cleaner

###### Description:

Removes dirt easily for a cleaner, shinier floor

###### Coverage:

200 sq ft per quart

###### Packaging:

(MFC-11) #8321106 quarts per carton  
Carton weight 13 lbs (5.9 kg)



Rinse-Free Cleaner

##### Heavy Duty Cleaner & Stripper

###### Description:

Dissolves stubborn dirt and built-up floor polish

###### Coverage:

200 sq ft per quart

###### Packaging:

(MFS-13) #832130  
6 quarts per carton  
Carton weight 13 lbs (5.9 kg)



Heavy Duty Cleaner & Stripper

##### High-Gloss Polish

###### Description:

Restores floor finish with a long-lasting shine

###### Coverage:

500 sq ft per quart

###### Packaging:

(MFP-15) #832150  
6 quarts per carton  
Carton weight 13 lbs (5.9 kg)



High-Gloss Polish

### Patching & Leveling Compounds

#### MVP-2023

##### Description:

A fast-setting, polymer-modified, cement-based patching compound which, when mixed only with water, is used to level concrete and approved wood underlayment prior to the installation of a floor covering. Floor covering can be installed in just one hour after application. When mixed with MVP 2023 Additive, it can be used as an embossing leveler over vinyl sheet goods, vinyl composition tile, cement terrazzo, and residual cutback surfaces.

##### Uses:

- For patching and filling cracks, holes, voids, and depressions in concrete and approved wood underlayment prior to the installation of floor coverings.
- When mixed with MVP-2023 Additive, it can be used as an embossing leveler over vinyl sheet goods, vinyl composition tile, cement terrazzo, and residual cutback surfaces.
- For repairing subfloors from featheredge to ½" (12.5 mm) thickness. If needed, MVP-2023 can be applied in two layers to exceed thicknesses greater than ½" (12.5 mm). **Note:** First layer must be completely dry.
- Offers a compatible bond with all floor covering adhesives when these adhesives are subsequently used for the installation of floor covering materials.
- For floors that require a high compressive strength patching compound. Will resist caster chair traffic.

##### Limitations:

- For interior use only.
- **Do not** apply over presswood, flakeboard, metal, or similar type substrates. Follow the floor covering manufacturer's recommendations regarding proper underlayment qualities.
- **Do not** apply directly over gypsum-based substrates.

## Resilient Installation Accessories (continued)



- When applying a skim coat of MVP-2023 [less than  $\frac{1}{32}$ " (0.8 mm)] over porous or very dry substrate, mix MVP-2023 with diluted MVP-2023 Additive to prevent premature dehydration (see mixing ratio in the technical data table).
- **Do not** use as a concrete resurfacing material when concrete surface is to be left exposed or unprotected.
- **Do not** use for leveling large surfaces.
- **Do not** use when the substrate temperature is below 50°F (10°C) or above 100°F (38°C).

### Recommended Substrates:

#### MVP-2023 mixed with water or diluted MVP-2023 Additive (1 part in 3 equal parts of water):

- Fully cured concrete.
- Any wood underlayment that is recommended or guaranteed by either the wood manufacturer or the floor covering manufacturer, such as Exterior grade plywood, Group 1, CC type.

#### MVP-2023 mixed with MVP-2023 Additive (full strength)

- Properly prepared vinyl composition and vinyl asbestos tile or non-cushioned sheet goods (vinyl or urethane wear layers).
- Properly prepared cement terrazzo.
- Residual cutback adhesive.
- Ceramic tile.

### Packaging:

Boxes: 4.4 lbs (2 kg); 10 lbs (4.5 kg)

Pail: 40 lbs (18.1 kg)

Bags: 25 lbs (11.3 kg); 50 lbs (22.7 kg)

#832165

### Color:

Gray

### Shelf Life:

Six months when stored in original container at room temperature 72°F (22°C) in a dry area.

### Mixing Ratios:

#### MVP-2023 Additive System (MVP-2023 mixed with MVP-2023 Additive)

##### Full Strength Mixture:

Mix 2.5 parts MVP-2023 powder with 1 part MVP-2023 Additive liquid.

##### Diluted Mixture:

Dilute MVP-2023 Additive liquid using 1 part MVP-2023 Additive with 3 parts water. Then, mix 2.5 parts MVP-2023 powder with 1 part diluted MVP-2023 Additive.

### Thickness Recommendations:

MVP-2023 mixed with water:  
Up to  $\frac{1}{2}$ " (12.5 mm) per application

MVP-2023 mixed with MVP-2023 Additive:  
Diluted Mixture . . . . .Up to  $\frac{1}{4}$ " (6 mm)  
(3 parts water/1 part MVP-2023 Additive)

Full Strength . . . . .Up to  $\frac{1}{8}$ " (3.2 mm)  
Mixture

### Approximate Coverages:

	Thickness	
	$\frac{1}{32}$ " (0.8 mm)	$\frac{1}{16}$ " (1.6 mm)
10 lbs (4.5 kg)	40 - 56 sq ft (3.7 - 5.2 m <sup>2</sup> )	20 - 28 sq ft (1.8 - 2.6 m <sup>2</sup> )
25 lbs (11.3 kg)	100-140 sq ft (9.3 - 13.0 m <sup>2</sup> )	50 - 70 sq ft (4.6 - 6.5 m <sup>2</sup> )

## MVP-2023 Additive

### Description:

An acrylic latex additive to be used with MVP-2023 for superior bond strength and to extend the pot life of the MVP-2023. This system is ideal for leveling non-cushioned embossed mineral fibrous felt-backed sheet goods with a vinyl or urethane wear layer, and non-cushioned embossed vinyl tiles. MVP-2023 Additive mixed full strength with MVP-2023 may also be used to skim-coat existing cutback adhesive residue prior to the direct glue-down installation of floor coverings.

### Uses:

- For leveling non-cushioned embossed mineral fibrous felt-backed sheet goods that have a vinyl or urethane wear layer.
- For leveling non-cushioned embossed vinyl tile.
- For use as an underlayment over existing unglazed ceramic tile.
- For use as an underlayment over cutback adhesive residue.
- For use over cement terrazzo.
- To extend the pot life of the MVP-2023 mix up to 20-30 minutes.
- For thin application of MVP-2023 over very porous or dry concrete to eliminate the premature dehydration of the patching compounds.
- When diluted 1:1 with water, MVP-2023 Additive may be used as a primer.

### Packaging:

Jug: 1 US gal. (3.7 L) #832166

### Color:

Milky white

### Shelf Life:

12 months when stored in original container at room temperature in a heated area. Protect from freezing.

### Approximate Coverages:

The coverage of MVP-2023 Additive depends on the usage of MVP-2023.



Hardwood

# Hardwood Flooring Installation Guide

## General Recommendations

All general installation instructions stated in General Installation Guidelines regarding storage and job site conditions, including climatic and structural requirements, are applicable to Mannington Hardwood Floors. Review and consider these requirements before proceeding with the installation.

## Product Inspection

Wood is a natural product, containing natural variations in color, tone, and grain. Before any Mannington engineered wood flooring leaves our plant, each plank goes through numerous inspection stations. Color variation between planks, however, is to be expected in a wood floor. Mannington cannot guarantee against natural variation in each plank, nor minor differences between samples and the color of the floor. With Mannington, you're protected by our exclusive Pre-Installation Limited Warranty. Return any planks you are not satisfied with, uncut, BEFORE installation and we'll replace them, no questions asked.

We urge you to inspect for color, finish, and graining BEFORE installation. Care should be taken during installation to remove or repair particular characteristics you do not desire. We suggest you use cut planks as starter strips to begin each new row and to "rack" the flooring to ensure a random appearance.

Furthermore, we recommend that you examine cartons to determine those that contain random length planks and those that contain full length planks. Plan the layout accordingly so that a random appearance is maintained throughout the installation.



**NOTE: Mannington Hardwood Floors accepts no responsibility for costs incurred when a floor with visible defects has been installed.**

## Job Site Conditions

In addition to the general instructions, Mannington Hardwood has category specific requirements.

Mannington engineered wood flooring does not need to be acclimated to the job site unless the flooring will be transported from one extreme temperature or humidity to another. If there is a severe temperature or humidity difference, make sure to condition the cartons of wood flooring and UltraSpread Mastic™ adhesive, if being used, 24 hours before the installation.

## Temperature & Humidity Requirements

The job site in a wood flooring installation must be climate controlled. If you are transporting wood flooring from one extreme temperature or humidity to another, however, make sure to condition the cartons 24 hours before installation; 48 hours for bamboo. Wood flooring performs best in climate-controlled interior environments. A permanent HVAC unit (or equivalent) must be operational in order to provide consistent room temperature between 60° and 80° F (16° to 27° C) and a humidity level of 35% to 55%. Temperature and humidity must be controlled for the life of the flooring.

UltraSpread Mastic™ has a minimum working temperature of 65°F. Never use UltraSpread Mastic™ below this temperature. Open time for UltraSpread Mastic™ is affected by temperature and humidity. As a general rule, the higher the temperature and humidity, the shorter the open time.

## Moisture Requirements

**Wood subfloor** moisture content must never exceed 14% moisture content when measured with a dependable moisture meter. The difference between the wood subfloor system moisture content and that of the hardwood flooring must not be greater than 4%.

**The moisture content of the bamboo flooring and the wood subfloor must never be greater than 2% of each other.**

**Concrete subfloors** must be visibly dry, with no history or evidence of excessive moisture vapor transmission. As a frame of reference, Calcium Chloride test results should be at 5 pounds or less moisture vapor transmission.

# Hardwood Flooring Installation Guide (continued)

## Subfloor Information

All subfloors should be free of dirt, oil, grease, wax, paint, or any substance that would hinder adhesion. All subfloors should also be level to ¼" per 10' span and should be visually dry and structurally sound.

## Wood Subfloors

All wood subfloors must be structurally sound, dry, at least ¾" in thickness, solidly fastened to appropriately spaced floor joists, and in compliance with all local building codes. First, make sure subfloor is dry. Subfloor wood moisture content cannot exceed 14% prior to installation. For bamboo it cannot exceed 10%. To determine wood moisture content use a quality moisture meter. Next, determine if subfloor is structurally sound; both floor joist spacing and subfloor panel selection must be considered. Use the following requirements as a guide:

- Planks may be installed (stapled, nailed, glued, or floated) to a single layer of ¾" thick, tongue-and-groove plywood or ¾" structural grade oriented strand board (OSB) substrate over appropriately spaced floor joists.
- If the subfloor is plywood or OSB less than ¾" thick, add a second cross layer for strength and stability (minimum ⅝" thick to total 1" in thickness). To reduce the possibility of squeaking, install the underlayment per the manufacturer's guidelines.
- 19.2" and 24" on center joist spacing may be acceptable if the subfloor system is designed in accordance with local building codes and is free of deflection.



**NOTE: Do not staple or nail down Mannington engineered wood flooring over particleboard subfloors.**

## Concrete Subfloors

All concrete subfloor systems must meet or exceed local building code specifications.

For concrete slabs that are on- or below-grade, it is recommended they be constructed so that ground water vapor cannot penetrate. Suspended, above-grade concrete subfloors often require extended drying time to lose initial moisture. Curing and drying time will vary depending on the type of concrete mix and the environment in which it is placed. New concrete slabs require a minimum of six weeks drying time before they can be covered with a wood floor. You can install Mannington engineered hardwood floors over concrete subfloors when using Mannington UltraSpread Mastic™ (glue-down method) or Mannington MegaGlue™ adhesive (floating method) if the subfloor is visually dry and has no history of moisture problems.

## Preparing Concrete Underfloors

Remove all curing agents, parting agents, or surface hardeners by grinding before installing wood flooring products. Also remove all paint, varnish, or other surface contaminants. You may remove these either chemically or mechanically, but do not use solvent-based strippers under any circumstances. Residual solvents can prohibit satisfactory bond of flooring adhesives. Be careful to maintain any physical expansion joints in the concrete underfloor. These joints were placed to permit expansion and movement of the slab. Use transition moldings manufactured specifically for this purpose to maintain the functionality of the expansion joint. **Fill and level all other cold joints, cracks, or depressions with Mannington MVP 2023 or a quality cementitious patching compound.**



**NOTE: Mannington Hardwood Floors' moisture release warranty is in effect only when Mannington UltraSpread Mastic is used and the flooring is installed according to Mannington installation instructions.**

# Hardwood Flooring Installation Guide (continued)



**NOTE:** Moisture tests can only indicate conditions at the time of the test. Neither Mannington nor the flooring contractor can be responsible if moisture levels change in the future.

## Radiant-Heated Subfloors

Selected styles of Mannington engineered wood flooring may be installed over radiant-heated subfloors provided the surface temperature of the system does not exceed 85° F. Mannington does not recommend installing, Hickory, Brazilian Cherry, Tigerwood or Imperial Tigerwood over radiant heat systems. Before installing Mannington engineered wood flooring over newly constructed radiant heating systems, operate the system at maximum capacity to force any residual moisture from the cementitious topping of the radiant heating system. Then set the thermostat to a comfortable room temperature for the installation.

## Structural Requirements

The structural integrity of the job site is critical for a satisfactory wood installation. The type and method of construction, grade level, and flooring system components all impact the installation of wood flooring products. Many times local building codes establish only minimum requirements for flooring systems. These minimum requirements may not provide sufficient rigidity for successful installation and continued performance of wood flooring products.

Subfloor must be clean. Remove all oil, dirt, grease, wax, sealers, paint, adhesives, and any other substance that would hinder installation.

Subfloor must be flat to 1/4" per 10' span. To check, just stretch a 10' string or lay a 10' straightedge over subfloor. If the subfloor dips or crowns 1/4" or more in the span, it must be leveled. Use a latex underlayment material such as Mannington MVP 2023 to level low areas in the subfloor. If the floor has a crown or rise, level it by sanding or grinding to meet 1/4" specifications.

There are additional concerns an installer must take into consideration for each different type of subfloor (wood, concrete, lightweight concrete, etc.) other than the requirements stated above. You may find existing subfloors that do not meet industry standards. In that case, do not precede until repair or replacement of the subfloor is completed, so your hardwood floor installation will be successful.

## Blend Cartons

To provide for a uniform appearance throughout the entire installation, open sufficient cartons to blend planks for both shade and length variations. Plank length can vary from 12" to 84" depending on the style. (Most styles 12" to 43" .) Make sure your work area is well lit. Good visibility ensures that color is consistent and that visually defective planks are detected and removed. Keep in mind, it is always a good idea to retain a few planks in case a repair is ever required.

## Staple-Down Installation

### Requirements and Procedures

This fast and easy method uses our own Mannington Spotnails Floor Monster Pneumatic Stapler and exclusive Mannington Spotnails nylon-coated precision staples. The staple-down technique is compatible for all Mannington Hardwood products (except Bamboo, Caspian LOCnGO™, and Tradewinds Collections) for use over plywood and structural OSB. The steps outlined in this section are also suitable for the nail-down method, provided that a specifically designed tongue-and-groove engineered flooring nailer is used. The Mannington Spotnails Floor Monster pneumatic stapler comes complete with two adapters, Allen wrenches, and oil. For a successful installation you will need the tools listed below.



# Hardwood Flooring Installation Guide (continued)

## Special Tools

- Mannington Spotnails Floor Monster pneumatic stapler (sku# FS4825W2)
- 1/2", 9/16", and 3/8" stapler attachment (included with stapler)
- Mannington Spotnails nylon-coated staples (sku# 4811PN-30M, 5,000/box)
- Safety glasses
- Compressor (with regulator)
- Tapping block (sku# TPBK009X)
- Power drill



## Setup and Use of Mannington Spotnails Floor Monster Pneumatic Stapler

### Inspect Equipment Prior to Use

- Become familiar with the tools and their operation, especially the pneumatic stapler. When used improperly, staples can damage wood flooring. Test the tools on scrap material first.
- Parts that engage the planks (especially pre-finished surfaces) must have no sharp burrs that can scratch or damage the flooring.
- Make sure the tool's adapter seats properly in the tongue and groove of the flooring.
- Use the retaining feet of the adapter to make adjustments so that the plank is held securely against the subfloor.

**!** CAUTION: Make certain the adapter size for the Mannington Spotnails Floor Monster pneumatic stapler correlates directly with the size of the product being installed. For instance, if you are installing 1/2" thick wood flooring, use the 1/2"-9/16" adapter.

**!** CAUTION: Only use Mannington Spotnails 4811PN nylon-coated staples during staple-down installation with the Mannington Spotnails Floor Monster stapler.

## Floor Monster Setup

- Loosen screws on retaining feet.
- Using a scrap piece of flooring, test tool on subfloor and engage the adapter into tongue and groove.
- Slide retaining feet down until they make contact with plank.
- Tighten screws. (See illustration A.)
- Calibrate the compressor so staples are properly set in the nail pocket to avoid damaging the floor or squeaking.

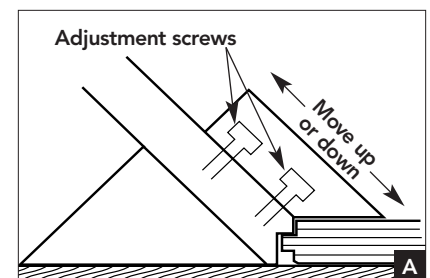

**✓** NOTE: If stapler is improperly set up, staples will not position correctly and may cause squeaking, crackling, and dimpling of the floor.

# Hardwood Flooring Installation Guide (continued)

## Compressor Setup

- With the correct adapter fastened, attach tool to compressor.
- Set the regulator at 80 psi and start the compressor.



**NOTE:** Pressure must never exceed 100 psi, since it can damage the stapler or cause harm to you or others.

- On a scrap piece of flooring, set stapler flush on the substrate and fully engage the stapler into the tongue-and-groove joint. Pull the trigger and examine staple placement
- When the top of the staple's crown is flush with the nail pocket, the tool is properly positioned. (See illustration B.)
- Should the staple penetrate too deeply or not deeply enough, reduce or increase the pressure until the staple is flush.

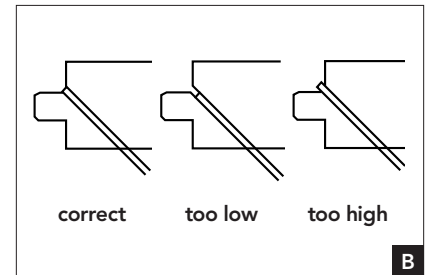

## Job Preparation and Installation



Before installation, do a calculation to determine the width of the last row of planks. If it is less than 1-1/2" wide, split the difference between the starter row and the last row. In any case, you will most likely be required to cut the last row of planks to width with a table saw equipped with a plywood cutting blade.



For the staple-down and nail-down methods, cover the subfloor with red rosin paper or any other suitable lining material. This will help keep dust away from the wood floor, retard moisture from below, and may help prevent squeaks from occurring. There is no complete moisture barrier system, however, for nail-down and staple-down applications. Maximum wood subfloor moisture should never exceed 14%.



Snap a chalk line from these points, parallel to the wall and perpendicular to the adjacent walls. Since most walls are not straight, the edge of some planks may have to be trimmed along the wall or cut to fit. It is not necessary to leave an expansion space for Mannington 9/16", 1/2", and 3/8" thick planks. **Bamboo requires a 5/16" expansion space for a nail down installation.**



Select a starter wall. An outside wall is best because it's most likely to be straight and square with the room. Measure out from this wall, at each end, the width of the plank plus 1/4."



# Hardwood Flooring Installation Guide (continued)

## “Racking” the Floor

This process is essential to achieve a random appearance. Start by either using random length planks found in the carton or by cutting four to five planks in random lengths, differing by at least 6". When starting these first few rows or courses, make certain to always measure from the tongue end of the plank for cutting. As you continue working across the floor be sure to maintain the 6" minimum between end joints on all adjacent rows. Randomly install different lengths to avoid a patterned appearance. Never waste materials; the ends cut from starter rows should be used at the opposite side of the room to complete rows or may also be used to start the next row.

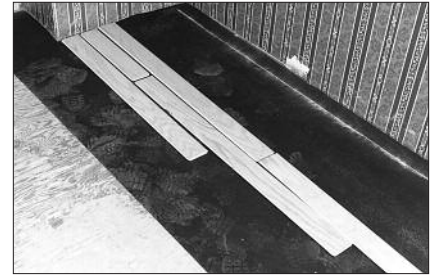

**NOTE:** Remember, it is extremely important to blend planks from several cartons to ensure a good balance of color, graining and plank length.

## Installation Procedure



Install the first row of planks by laying the tongue edges on the chalk line. Proper alignment is critical. Misaligned starter rows can ruin the entire installation. Secure each plank to the subfloor using a pneumatic brad tacker or with finishing nails. Drill pilot holes through the face of each plank (in dark grain) if using finishing nails.



**NOTE:** Proper alignment of planks is critical. Misaligned starter rows can ruin the entire installation.



After the first row is complete, adjacent rows should also be predrilled in the nail pocket and secured with finishing nails set at 45°. Rows of flooring will need to be installed in this manner until flooring planks are a sufficient distance away from the wall to accommodate the stapler. Stapling schedule is every 6" to 8" on center.



**NOTE:** Avoid clustering end joints and stagger random lengths so that the end joints are no closer than 6".



The precise engineering of our UltraFit™ tongue-and-groove system delivers a very stable floor. But you **MUST** make a good connection. Use a tapping block to tap the planks until the tongue and groove “snap” into place.



**CAUTION:** Never use a rubber mallet to tap planks, since this can mar or damage the flooring.

## Hardwood Flooring Installation Guide (continued)



Using the Mannington Spotnails Floor Monster stapler, with the proper adapter attached (see stapler instructions for proper setup), continue to staple new planks every 6" to 8" on center, fastening the ends of the planks approximately 2" from each end.



Using a pry bar, position the final filler planks.



Face nail or tack each final plank into place with the pneumatic stapler. Install the molding and retain a few leftover planks in case a repair is ever required. **Do not use manual nailers on any Mannington Hardwood Floors maple flooring or on any Tradewinds Collection or Caspian LOCKnGO. Bamboo flooring should not be stapled.** Sweep floor to remove all dust and dirt. Take care not to scratch the finish.

### Alternative Fastening Method For Mannington Wood Floors

With the sales growth of Engineered Hardwood, in new home construction, we have become aware of some changes in the construction process in building these homes. For many years, the standard in the industry, for joist spacing for sub floor construction, was 16" on center. This was a time tested, consistent procedure that builders used when, building new homes. This joist spacing, along with a  $\frac{3}{4}$ " plywood sub floor, gave a solid foundation for flooring to be installed over.

The new materials that are being used today, Engineered Joists and OSB, allow the builder to make some changes in how these houses are being built. The new Engineered Joists system, allows the joist spacing to be increased from 16" on center, to 19.2", or even to a distance of 24" on center. This extra spacing on the joist system, without any increased thickness in the sub floor, can potentially contribute to some increased deflection in the sub floor. This deflection in the sub floor, can cause movement between the tongue and the groove of the Hardwood panel, causing a squeak or crackle noise when the floor is walked on. Some Hardwood Manufacturers recommend that any sub floor over joist spacing of 19.2" or greater, should be at least 1  $\frac{1}{8}$ " thick. Where this is possible, this may reduce the potential for squeak and crackle, as the sub floor will have less deflection, or movement.

Where it is not possible to add another  $\frac{3}{8}$ " thickness to the sub floor, Mannington Installation has come up with an alternative fastening method for our Engineered Hardwood. Our recommended installation procedure, over a wood substrate, is glue, using Mannington's' Ultra Spread adhesive, staple, using the Floor Monster/Striker stapler, or nail, using an approved nailer for engineered hardwood. When the glue down method is used, it is recommended that a  $\frac{1}{4}$ " underlayment is added, to eliminate any problems with the sub floor, when a repair has to be made. When the staple down method is used, the Floor Monster/ Striker Stapler will shoot an 1  $\frac{3}{8}$ " staple, with the regulator on the compressor set at 80 psi., making sure the staple is properly seated in the nailer pocket of the tongue. When a nailer is used, be sure to check the alignment of the cleat, to determine if the cleat is properly seated in the nailer pocket, and is not causing any bumps in the veneer, or damaging the side edge of the hardwood.

When the joist spacing is 19'2" or greater, it is recommended that you apply a thin bead of Mannington Mega Glue to the bottom of the groove, to lock the tongue and groove profile together, to eliminate any potential movement, which could contribute to squeak and crackle. When using this new method, you may choose to staple or nail down the hardwood, as either method is acceptable. The use of the Mega Glue, along with a staple or cleat, reduces the movement of the material as the sub floor deflects. This creates a much more uniform bond on the floor, and gives increased stability to the hardwood. By applying the Mega Glue to the bottom of the groove, there is little to no clean up that will have to be done.

## Hardwood Flooring Installation Guide (continued)

As with all of our installation procedures, this method has been tested outside, in the field, in over 25 houses, with no complaints. This procedure has eliminated all squeak and crackle complaints, and minimized any gapping concerns at the time of installation. The use of Mega Glue has been tested against different brands of wood glue, with the opinion that the Mega Glue holds better, cleans up easier, and is easy to apply. In doing repairs, such as board replacement, the Mega Glue was able to be removed easily, and the area prepared for re-installation with minimum concern.

It is the belief of Mannington's Installation Dept., that this alternative fastening method for Hardwood, will greatly minimize, or even eliminate any squeak and crackle issues in the field. We believe that if we can come up with solutions to problems in the field, we will be a better company to do business with.

### Final Inspection

After the floor is cleaned, inspect the floor for nicks, scratches, or any other imperfections that need attention. Touch up nicks and scratches with Mannington Hardwood Floors touch-up products. The newly installed floor can accept foot traffic immediately.

### Floor Protection During Construction

Always protect the surface of installed flooring during construction by laying a quality felt paper over the floor and taping it to the baseboards. Never use plastic or polyethylene sheeting to cover the floor because they will trap moisture. The covering material must allow the floor to breathe.

## Glue-Down Installation

### Requirements and Procedures

The Mannington glue-down system makes installation smooth and easy. Wood planks are glued to the subfloor using Mannington UltraSpread Mastic™ adhesive and a minimum  $\frac{3}{16}$ " x  $\frac{5}{32}$ " V-notched trowel. This moisture-cured polyurethane adhesive forms a tenacious bond. The adhesive is VOC compliant, nonflammable, contains 0% water, and has a very mild odor. You can install Mannington engineered hardwood floors over concrete subfloors when you are using Mannington UltraSpread Mastic™ if the subfloor is visually dry and has no history of moisture problems.



**NOTE:** Do not fully adhere Mannington Hardwood Floors over perimeter-installed resilient flooring.

### Special Tools

- Mannington UltraSpread Mastic™
- Mannington PROTVNX trowel  $\frac{3}{16}$ " x  $\frac{5}{32}$ " V-notched (minimum)
- Non-marring blue painters tape
- Tapping block (sku# TPBK009X)
- 100-lb roller



# Hardwood Flooring Installation Guide (continued)

## Job Preparation and Installation

Before installation, do a calculation to determine the width of the last row of planks. If it is less than one half of plank width, split the difference between the starter row and the last row. In any case, you will most likely be required to cut the last row of planks to width with a table saw equipped with a plywood cutting blade.

## “Racking” the Floor

This process is essential to achieve a random appearance. Start by either using random length planks found in the carton or by cutting four to five planks in random lengths, differing by at least 6". When starting these first few rows or courses, make certain to always measure from the tongue end of the plank when cutting. As you continue working across the floor be sure to maintain the 6" minimum between end joints on all adjacent rows. Randomly install different lengths to avoid a patterned appearance. Never waste materials; the ends cut from starter rows should be used at the opposite side of the room to complete rows or used to start the next row.

 **NOTE:** It is extremely important to blend planks from several cartons to ensure a good balance of color, graining, and plank length.

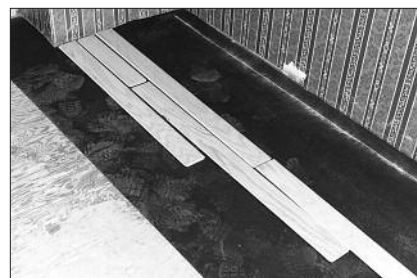

## Installation Procedure



Select a starter wall. An outside wall is best because it's more likely to be straight and square with the room. Measure out from this wall, at each end, the width of two planks.



Snap a chalk line from these points, parallel to that wall and perpendicular to the adjacent walls. Since most walls are not straight, the edge of some planks may have to be trimmed along the wall or cut to fit.



Spread Mannington UltraSpread Mastic from the chalk line out to the width of two planks with a minimum 3/16" x 5/32" V-notched trowel. You can start laying planks immediately into wet adhesive; however, for optimum performance Mannington recommends allowing the adhesive to set for 30 minutes.



Install the first row of starter planks and secure into position with the tongue facing the starter wall. Proper alignment is critical, misaligned starter rows can ruin the entire installation. It may be helpful to firmly secure a straight edge along the chalk line as a guide; this also helps to prevent planks from shifting in the wet adhesive. Or else, top nail the first row with finishing nails (wood subfloor) or sprig/pin nails (concrete subfloor).



The precise engineering of our UltraFit™ tongue-and-groove system creates a very stable floor. But you **MUST** make a good connection. Use a tapping block to tap the planks together until the tongue and groove “snap” into place.

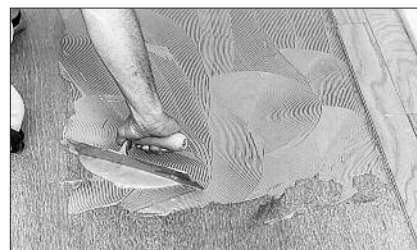

When the first two starter rows are secure, spread 2-1/2' to 3' of adhesive across the length of the room. (Never spread more adhesive than can be covered in approximately three hours). If the adhesive has set and will not transfer to the back of the plank, scrape up the adhesive and apply fresh UltraSpread Mastic™ adhesive.

## Hardwood Flooring Installation Guide (continued)



Place planks into position on top of adhesive and tap into place with a tapping block. Avoid clustering the end joints. Stagger random lengths so that end joints are no closer than 6."

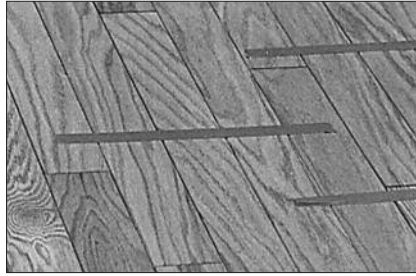

After several rows of planks are down, secure the rows using non-marring, releasable blue painters tape. Do not allow the tape to remain on the planks longer than required. Repeat this process as the installation progresses.



**NOTE:** Releasable blue painters tape should never be left on flooring planks for more than a few hours. This type of tape is affected by heat and sunlight and will lose its "releasable" property. Always use fresh tape when securing wood planks. Never get mineral spirits or paint thinner on the blue tape as this may leave a blemish.

When you have finished installing planks across the work area, if you used a starter straightedge go back to the beginning of the installation and remove straightedges. Spread adhesive onto exposed subfloor and use a pry bar to position the final two rows into place. Remove the tongue from the last row to complete the installation.



Thoroughly roll the flooring in both directions using a clean, three-section 100-lb floor roller. Clean with any urethane adhesive cleaner.

### Final Inspection

After the floor is rolled and cleaned, inspect the floor for nicks and scratches, and planks that may have moved during installation, as well as any other imperfections that need attention. Touch up nicks and scratches with Mannington Hardwood Floors touch-up products. In typical climates, the new floor can accept foot traffic within 12 hours. Arid (dry) climates may require more curing time. Keep a few leftover planks in case a repair is ever required.

### Floor Protection During Construction

Always protect the surface of installed flooring during construction by laying a quality felt paper over the floor and taping it to the baseboards. Never use plastic or polyethylene sheeting to cover the floor since they trap moisture. The covering material must allow the floor to breathe.

## Floating Installation – Mannington Hardwood Floors

### Floating Installation Requirements and Procedures

Mannington  $\frac{9}{16}$ ",  $\frac{1}{2}$ " and  $\frac{3}{8}$ " thick engineered wood plank flooring 3" and wider can be installed using the floating method over numerous subfloors, including concrete, gypsum, plywood, composition board, ceramic tile, vinyl tile, sheet vinyl, and radiant-heated floors. The floating method is one of the easiest methods of installing engineered wood floors and is the only technique that is appropriate for many substrates that are not suitable for other installation methods. Do not use the floating installation system with bamboo floors.

✓ **NOTE:** While the floating method offers some advantages, there are some things of which you should be aware:

- (1) The floor may have a hollow sound when walked on.
- (2) The wood rests on the subfloor with its own weight, which may cause the floor to have slight vertical movement.

✓ **NOTE:** All Mannington hardwoods may be installed using the floating installation method. The only exceptions to this rule are Mannington Bamboo and  $\frac{3}{4}$ " thick hardwood.

✓ **NOTE:** Mannington does not recommend floating the following species over radiant heated subfloors: • Hickory • Brazilian Cherry • Tigerwood • Imperial Tigerwood

### Special Tools

- Appropriate Mannington underlayment (see below for details)
- Mannington MegaGlue™ Adhesive (sku #600021)
- Glue scraper
- Spacing wedges
- Safety glasses
- Tapping block (sku #TPBK009X)
- Pry bar
- Non-marring blue painters tape



### Mannington Underlayments

#### AquaBarrier II™

AquaBarrier II™ is an underlayment sheeting that combines a foam cushion layer and a moisture barrier film all in one sheet. The underlayment also has a built-in edge sealing system for attaching the sheets together. AquaBarrier II™ is used for below-grade or on-grade subfloors where moisture is a concern.



**AquaBarrier II - Jumbo Roll (Item #600001)**  
1 roll of underlayment (300 sq ft)

# Hardwood Flooring Installation Guide (continued)

## ComfortBarrier™

ComfortBarrier is an underlayment foam cushion to be used for above grade subfloors ONLY where subfloor moisture is not a concern.

## Whisper 3N1

Whisper 3N1 is a multi-use underlayment. It serves as a comfort, sound and moisture barrier. This new underlayment is thin, light and dense making it easier for installers to work with it on the job site.

Product specifications are as follows:

Thickness: 1 mm	Roll weight: 6.5 lbs.
Roll size: 300 s.f.	Pallet dimensions: 78" x 44" x 47"
Length: 50'	Rolls per pallet: 60
Width: 72"	Pallet weight: 471 lbs.
Roll diameter: 6"	

Whisper 3N1 will be available with or without connecting flaps. These flaps are designed to connect seams when a room requires more than one width of underlayment. In order for the underlayment to act as a moisture barrier, the flaps must be used at any seam.

## Installation of Whisper 3N1 and AquaBarrier™ II Underlayment

Whisper 3N1 and AquaBarrier II™ underlayment eliminates the need for a separate moisture barrier film and underlayment cushion.

You will need one (1) roll of AquaBarrier II for every four (4) cartons of wood flooring installed. The amount of MegaGlue™ Adhesive required depends on the plank width being installed. Refer to MegaGlue™ Adhesive Requirements chart on page 87 for further details. Install AquaBarrier™ II by laying it out, poly side facing up. Seal all seams using the built-in edge sealing tape system. Tape any relief cuts or butt seams with duct tape.

## Installation of ComfortBarrier™

If the installation area is above ground and protection against moisture is not a concern, you may install ComfortBarrier. Please note, the directions outlined below explain the installation and use of AquaBarrier™ II underlayment. Please follow these general guidelines. However, when the installation requires more than one sheet of ComfortBarrier, simply butt each end together and seal with duct tape.

## "Racking" the Floor

This process is essential to achieve a random appearance. Start by either using random length planks found in the carton or by cutting four to five planks in random lengths, differing by at least 6". When starting these first few rows or courses, make certain to always measure from the tongue end of the plank when cutting. As you continue working across the floor be sure to maintain the 6" minimum between end joints on all adjacent rows. Randomly install different lengths to avoid a patterned appearance. Never waste materials; the ends cut from starter rows should be used at the opposite side of the room to complete rows or used to start the next row.



ComfortBarrier (Item #600002)  
1 roll of underlayment (300 sq ft)



Install one sheet of AquaBarrier™ II underlayment net along the starting wall. Unroll only one sheet at a time during plank installation to prevent damaging the underlayment. If any part of the AquaBarrier II underlayment is punctured or damaged during installation, seal the area with duct tape.

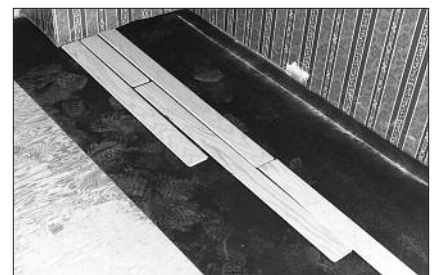

# Hardwood Flooring Installation Guide (continued)



**NOTE:** It is extremely important to blend planks from several cartons to ensure a good balance of color, graining, and plank length.

## Floating Installation

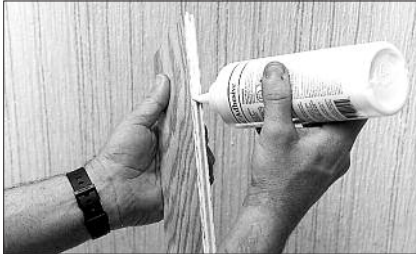

In a floating floor installation, the flooring is NOT nailed or glued to the underlayment, but is glued in the plank's groove only. Apply Mannington MegaGlue adhesive to the bottom of groove along the entire length and on the end of each plank. **Do not completely fill the groove with adhesive.**

## Job Preparation



Undercut all doorcasings 1/16" higher than the thickness of the flooring and underlayment to be installed. Place a scrap piece of plank and a sheet of underlayment against the doorcasing to act as a guide, and cut the doorcasing with a hand saw or power jamb saw set to the correct height.



After deciding the direction in which the planks will run, measure the width of the room (the dimension perpendicular to the direction of the flooring). The last row of flooring should be no less than 1-1/2" wide. If it is less, we recommend cutting the starter row narrower. This will require extra cutting but it will make the rest of the installation easier and faster.

## Installation Method

Cut the Mannington MegaGlue adhesive applicator nozzle at a 45° angle with a utility knife. Do not cut off any part of the cap locking ring around the nozzle. The installation sequence is critical and provides stability to the first two rows. Proper alignment is critical. Misaligned starter rows can ruin the entire installation.



Before starting to glue planks, dry-lay the entire first two rows on top of the selected underlayment. Begin in the upper right corner of the work area with the groove side of the planks facing the wall. Place spacing wedges along the walls on both the ends and sides of all planks.

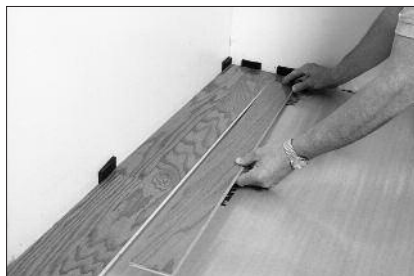

The installation sequence is critical and provides stability to the first two rows. Closely follow the next several instructions to obtain the proper gluing sequence for the first few rows of planks. To start, glue the first plank in the second row to the first plank in the starter row, and so on.



Use a tapping block and a hammer to push glued planks together until no gaps are seen. Immediately wipe away any excess adhesive with a clean damp cloth.



**CAUTION:** Never use a hammer or mallet directly on the flooring.



## Hardwood Flooring Installation Guide (continued)



Glue the next plank to the plank in the previous row. Apply adhesive only to the width end of the plank. Tap the planks together carefully with a tapping block and hammer. Remember to continually remove adhesive squeezed up between the joints with a glue scraper or a clean damp cloth.



Glue the next plank in the same row to the previously glued plank from the previous row. Apply adhesive to both the length and width edges of the plank.



At the end wall use a pry bar, if needed, to pull the ends of the planks tight. Continue laying the floor on top of the selected underlayment, working right to left, laying plank after plank, row after row, tapping the planks together as you go. Be sure to continue using 5/16" spacing wedges at all walls and obstructions throughout the installation.

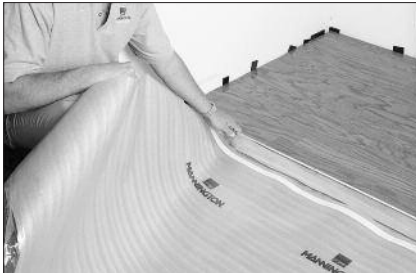

Once the first sheet of underlayment is covered with wood flooring, install the second sheet.

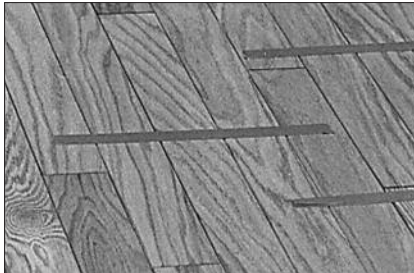

After several runs of planks are down, use strips of non-marring, releasable blue painters tape to hold the planks securely. Repeat this process as the installation progresses.

Remove the tape as you go. Do not allow the tape to remain on flooring planks longer than two hours.



**NOTE:** Releasable blue painters tape must never be left on the flooring planks for more than a few hours. This type of tape is affected by heat and sunlight and will lose its "releasable" property. Always use fresh tape when securing wood planks. Never get mineral spirits or paint thinner on the blue tape as this may leave a blemish.



The last row will most likely require cutting to width but it should be no less than 1-1/2" wide. To do this, lay the plank on top of, and edge-to-edge with, the plank in the next-to-the-last row. Trace the wall contour on the last plank using a scrap piece of plank and cut as required.



Install cut planks and pull into place with a pry bar. Install spacing wedges between planks and wall. Allow floor to dry for a minimum of 12 hours before removing all spacing wedges and allowing foot traffic. Sweep the floor to remove all dust and dirt, taking care not to scratch the finish.

# Hardwood Flooring Installation Guide (continued)

## Final Inspection

After the floor is cleaned, inspect it for nicks and scratches, and for planks that may have moved during installation, as well as any other imperfections that need attention. Touch up nicks and scratches with Mannington Hardwood Floors touch-up products. In most climates, the floor can accept foot traffic within 12 hours.

## Floor Protection During Construction

Always protect the surface of installed flooring during construction by laying a quality felt paper over the floor and taping it to the baseboards. Never use plastic or polyethylene sheeting to cover the floor because they trap moisture. The covering material must allow the floor to breathe.

## Repairs – Mannington Hardwood Floors

Although Mannington engineered wood flooring is inherently tough, it can be accidentally chipped by something falling on top of it. Always inspect each plank closely before installation. If damage occurs after installation, however, the following repair procedure may be used.



**NOTE:** Warranty does not cover labor for repair and replacement when a floor with visual defects has been permanently installed.

## Plank Replacement



To replace an entire damaged plank, begin by drilling four 1/2" holes in the damaged plank approximately 1/4" away from all four plank corners. Use extreme caution when drilling to prevent damage to adjoining planks. It's a good idea to mark your cutting path before drilling or sawing into the damaged plank.



To remove the plank you must cut it with a circular saw. Set saw to precise depth of plank. Cut diagonally from one corner hole to the opposite corner hole to create an "X" in the damaged plank. Follow directions below to remove cut planks.



To remove cut planks, loosen by prying up at saw cut with a chisel or small pry bar.

Position weights on an existing plank along the seam edge of the damaged plank. This will weight the existing floor as you break the glue bond. With your hands, pry and lift the piece out of place. Wear gloves as an extra precaution to avoid injury. Use extreme caution when removing the damaged plank pieces to also prevent harm to adjoining planks.



Use a chisel and a hammer to remove any remaining damaged plank pieces.



Once the plank is thoroughly removed, clean the tongue-and-groove joints of the surrounding planks with a sharp chisel.

## Hardwood Flooring Installation Guide (continued)



Vacuum all sawdust and debris away from repair area before proceeding.

Prepare the replacement plank by cutting off the plank's bottom groove along both the length and width using a power saw. Cutting this bottom flange away will help ease placement of the repair plank into the repair area. Also cut off 3" of the tongue from the repair plank. Check planks for fit.



Always use Mannington adhesive and sundry products. When employing the floating method, apply adhesive to the bottom of the groove on the repair plank. For the glue-down method, spread the appropriate amount of UltraSpread Mastic™ with the correct V-notched trowel.



Slide the repair plank into place using a tapping block, first inserting the side with 3" cut off the tongue. Wipe away any excess glue with a clean dampened cloth or with a Mannington glue scraper. Weight the repair plank and avoid active foot traffic for approximately 12 hours after the repair has been completed.

### LOCnGO™ Wood Installation Instructions

#### Interlocking Floating Installation Requirements & Procedures

Mannington LOCnGO must be installed over an approved underlayment pad, such as Mannington Whisper 3-in-1 or AquaBarrier™ II. Install only one sheet of underlayment at a time, cover with the wood flooring and then install the next sheet of underlayment.

#### "Racking" the Floor

This process is essential to achieve a random appearance. Start by either using random length planks found in the carton or by cutting four to five planks in random lengths, differing by at least 6." When starting these first few rows or courses, be certain to measure from the tongue end of the plank when cutting. As you continue working across the floor, be sure to maintain the 6" minimum between end joints on all adjacent rows. Randomly install different lengths to avoid a patterned appearance. Never waste materials; the ends cut from starter rows should be used at the opposite side of the room to complete rows or used to start the next row.



**NOTE:** As stated earlier, it is extremely important to blend planks from several cartons to ensure a good balance of color, graining, and plank length.

As with all plank wood flooring, the long dimension of the plank should be installed in the long dimension of the work area. Measure the width of the work area to ensure a "balanced" layout of plank width on opposite long walls of the work area. If the planks have been cut down in width and the locking mechanism has been damaged, apply a thin bead of MegaGlue™ in the end joints. This should only be necessary on the first and perhaps last rows of planks.

Once the starting wall has been determined, lay the first plank using 1/2" spacers to maintain the expansion gap. Align and lock the end joints of the second and consecutive planks in the first row. Cut a starter plank or use a random plank of at least 9" to begin the second row. Maintain a random stagger of the end joints across the entire installation. Place the tongue of the plank into the groove of the plank in the first row. Align the second plank of the second row over the end joints of the adjoining plank; then insert the tongue into the groove of the plank in the first row and lock into place. Drop the end joints into place ensuring that the seam is tight. The "locking system"

## Hardwood Flooring Installation Guide (continued)

will secure the end joints; these end joints will be held down by the following rows so no adhesive is necessary in the field end joints. Be certain to maintain the  $\frac{1}{2}$ " expansion gap at all fixed, vertical objects throughout the entire installation. Continue installing planks, clicking the side seam and locking the end joints into place, until reaching the last row.

More than likely, this last row will need to be cut to fit. Scribe the last row of planks to fit the opening, being certain to provide the  $\frac{1}{2}$ " expansion gap, and cut along the scribed line with a scroll or jigsaw. Position the first plank in the last row to click into the next to last row and, if the locking mechanism has been cut, place a bead of MegaGlue™ adhesive in the end joint. Align and fasten the remainder of the planks, being certain to apply adhesive at the end joints.

If at any time during the installation you need to remove a "locked" plank, insert the supplied plastic tool into the gap at the side of the end joints. The tool should slide in easily. As you are inserting the tool, pull up on the board to remove.

Remove all spacers and cover expansion joint with wall base or quarter round. Be certain to fasten into the wall and not into the flooring product. Use the appropriate transition moldings at doorways, etc. Again, be certain not to nail or staple through the finished flooring product when fastening transition moldings.

### Glue-Down Installation Requirements & Procedures

The Mannington glue-down system makes installation smooth and easy. LOCnGO planks are glued to the subfloor using urethane-based Mannington UltraSpread Mastic™ adhesive and a minimum  $\frac{3}{16}$ " x  $\frac{5}{32}$ " V-notched trowel. This moisture-cured polyurethane adhesive forms a tenacious bond. The adhesive is VOC compliant, nonflammable, contains 0% water, and has a very mild odor.

Before installation, do a calculation to determine the width of the last row of planks. If it is less than one half of plank width, split the difference between the starter row and the last row. In any case, you will most likely be required to cut the last row of planks to width with a table saw equipped with a plywood cutting blade.

Select a starter wall. An outside wall is best because it's more likely to be straight and square with the room. Measure out from this wall, at each end, the width of two or three planks.

Snap a chalk line from these points, parallel to that wall and perpendicular to the adjacent end walls. Since most walls are not straight, the edge of some planks may have to be trimmed along the wall or cut to fit.

It is not necessary to leave an expansion space for Mannington LOCnGO planks when fully adhered.

### "Racking" the Floor

This process is essential to achieve a random appearance. Start by either using random length planks found in the carton or by cutting planks in random lengths, differing by at least 6". When starting these first few rows or courses, make certain to always measure from the tongue end of the plank when cutting. As you continue working across the floor be sure to maintain the 6" minimum between end joints on all adjacent rows. Randomly install different lengths to avoid a patterned appearance. Never waste materials; the ends cut from starter rows should be used at the opposite side of the room to complete rows or used to start the next row.



**NOTE:** As stated earlier, it is extremely important to blend planks from several cartons to ensure a good balance of color, graining, and plank length.

## Hardwood Flooring Installation Guide (continued)

Spread Mannington UltraSpread Mastic™ from the chalk line out to the width of two planks with a minimum  $\frac{3}{16}$ " x  $\frac{5}{32}$ " V-notched trowel. You can start laying planks immediately into wet adhesive; however, for optimum performance, Mannington recommends allowing the adhesive to set for 30 minutes.

Install the first row of starter planks and secure into position with the tongue facing the starter wall. Proper alignment is critical. Misaligned starter rows can ruin the entire installation. The locking feature of these LOCnGO planks eliminates the need to tape or otherwise secure the planks to keep them aligned and in position.

When the first two starter rows are secure, spread 2' to 3' of adhesive across the length of the room. (Never spread more adhesive than can be covered in approximately 3 hours. If the adhesive has set and will not transfer to the back of the plank, scrape up the adhesive and apply fresh UltraSpread Mastic™ adhesive.) Always work off of the product. Keep foot traffic to a minimum until the adhesive has had an opportunity to set.

Place planks into position on top of adhesive and lock into place. Avoid clustering the end joints. Stagger random lengths so that end joints are no closer than 6". Roll the completed wood floor installation in both directions with a three-section 100-lb floor roller.

Retain a few leftover planks in case a repair is ever required.

### Cleanup

Clean UltraSpread Mastic™ adhesive from floor and tools with urethane adhesive cleaner. Do not allow adhesive to dry on the surface of the flooring.

### Moldings and Trim

Finish your installation with Mannington Wood Floors™ matching moldings and trim. Our prefinished moldings and trim are manufactured to match our line of finishes to enhance the final appearance of your wood floor installation.



#### Reducer Strip

*This molding creates a perfect transition between floors of different heights; for example, engineered wood to resilient flooring.*

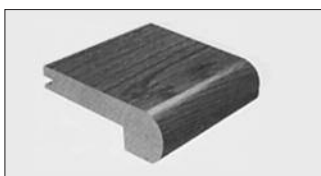

#### Step Nosing

*Stairs often take a lot of traffic and they also serve as a decorative focal point. This protective strip along the edges will catch the brunt of foot traffic, while enhancing the overall beauty of the staircase.*



#### Baby Threshold

*Baby Thresholds are used in the doorways of adjoining rooms with floors of two different heights.*



#### T-Molding

*T-Molding should be used to join two different floor surfaces that are approximately the same height; for example, engineered wood to ceramic tile.*



#### Wall Base

*This molding accents the wood floor at the base of the walls. It gives any room a formal finished look, while maintaining a crisp, sharp juncture between the floor and wall. This molding can be used with or without Quarter Round.*



#### Quarter Round

*The rounded profile of this molding creates a subtle blend between the floor and the wall. It can be used with or without Wall Base molding.*

# Hardwood Flooring Installation Guide (continued)

## Molding Installation

Install Mannington wood moldings using traditional methods. Simply nail moldings into place with clean finishing nails. Follow the instructions below for specific installation techniques on each molding.

### Quarter Round & Wall Base

Nail Quarter Round and Wall Base molding into the wall with finishing nails. Wall Base and Quarter Round can either be used separately or together, each achieving a different look and style. Do not fasten these moldings directly into the flooring. They should be kept slightly off the floor so as not to bind or jam the flooring.

Step Nosing requires a unique installation method. Glue the wood flooring and Step Nosing directly to the stair tread using Mannington UltraSpread Mastic™.

When installing T-Molding, Baby Threshold, or Reducer Strip, first drill small holes in the molding to avoid wood splits. Using the drilled holes as your guide, hammer finishing nails directly into the subfloor every 18".

### Finish Moldings

Use appropriate finish moldings or terminating profiles as transitions to door thresholds, steps, or other floor coverings. T-Molding, Baby Threshold, and Reducer Strip moldings can be glued or nailed to the subfloor using finishing nails. When installing Quarter Round and Wall Base it is important to miter all corners as well as junctures. Drill small holes for nailing in the molding to avoid wood splits and nail into the wall every 18".

## Installation Accessories

### Floor Adhesives

Style Number	Package Size	Coverage	Lbs/Pkg	Gal/Pallet	Lbs/Pallet
<i>New Mannington VOC-Compliant UltraSpread 50 Mastic™ Adhesive</i>					
US601	4 1-gal cans	50 sq ft/gal	56	180 (45 ctns)	2,570
US605	5 gal pail	250 sq ft	70	135 (27 pails)	1,766
<i>MegaGlue™ Adhesive</i>					
ADH 600021XSA	12-16 oz bottles	Varies according to plank width*	N/A	N/A	N/A

\*See MegaGlue™ Adhesive Requirements Chart below.

## MegaGlue™ Adhesive Requirements

Requirements per 100 sq ft	
Plank Width	Approximate Number of MegaGlue™ Bottles /100 sq ft
3"	2.5
5"	1.5



Laminate

# Laminate Flooring Installation Guide

## General Instructions

Mannington Laminate Floors provides a full line of laminate flooring products in various styles, decors, and product constructions. The information contained in this chapter is relevant and pertinent to all Mannington Laminate Flooring products. A thorough understanding and careful consideration of these installation guidelines will contribute to a successful installation. Be certain to review page 4 for information on subfloor selection and preparation.

## Storage and Handling

 **NOTE:** Open cartons just prior to installation.

When storing pallets, do not stack them more than three high, and make certain they are protected from forklift trucks or other traffic. Also during storage, carefully protect package corners and lay boxes horizontally. The storage area must be climate controlled with a temperature range between 65°F and 100°F (18°C and 32°C) and a relative humidity in the 40% to 65% range.



*Always handle cartons carefully so you will not damage the product inside. Always store flooring horizontally in the original, unopened package. Do not puncture packaging. Cartons should not be opened until time of installation. Even if packaging is opened a few days before installation, atmospheric conditions may permanently alter the product, thus making it more difficult to install.*



*Wipe planks with a soft cloth and thoroughly inspect before installation. Mannington Laminate Floors does not cover claims for repair labor or replacement when a plank with visual defects has been permanently installed.*

## Job Site Conditions

Although not required for glueless laminate, for best results condition the unopened cartons for approximately 48 hours in the area where the floor will be installed. Job site temperature should be 65°F or higher and the relative humidity should not exceed 65%.

If a single room exceeds 2000 square feet or has a length or width greater than 45 feet, additional expansion joints will be required. This is accomplished by providing a greater than  $\frac{1}{16}$ " amount of expansion at all fixed vertical surfaces. Extra caution must be exercised when transitioning from a larger area to a smaller area. Be certain to maintain adequate expansion in the doorways by using T-moldings and/or undercutting the door frames.

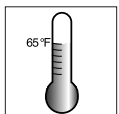

### Temperature Requirements

As with all flooring installations, the site must be climate controlled. The temperature should be at least 65°F and the relative humidity should not exceed 65%. It is particularly important to maintain these temperature and humidity requirements for at least 48 hours before and after installation, as well as during. Furthermore, these conditions must be maintained for the life of the laminate floor product. Never install Mannington Laminate Floors in high-humidity areas where the floor is usually wet (steam rooms, saunas).



# Laminate Flooring Installation Guide (continued)

## Structural Requirements

The structural integrity of the job site is critical for a satisfactory flooring installation. The type and method of construction, grade level, and flooring system components all impact the installation of flooring products. Many times, local building codes establish only minimum requirements for flooring systems. These minimum requirements may not provide sufficient rigidity for successful installation and continued performance of flooring products. Hardwood, laminate, and porcelain flooring products require that the subfloor system is free of deflection.

Subfloor variations should not exceed  $\frac{1}{8}$ " in 6' (3.18 mm in 1.8 m). Use a 6' level or straightedge to check for variation. All high spots must be sanded or ground smooth. Fill in low spots, cracks, and depressions with Mannington MVP 2023 or equivalent.

## Radiant-Heated Subfloors

Mannington Laminate Flooring may be installed over hydroponic radiant-heated subfloors, provided the surface temperature of the system does not exceed 90°F. Before installing Mannington Laminate Flooring over newly constructed radiant-heating systems, operate the system at maximum capacity to force any residual moisture from the cementitious topping of the radiant heating system. Then set the thermostat to a comfortable room temperature for the installation.

## Existing Flooring Coverings

Mannington Laminate Floors can be installed over existing resilient floor coverings, wood flooring, and ceramic tile (grout joints must be leveled). Do not install Mannington Laminate Floors over carpet. Remove all carpet before proceeding with a Mannington Laminate Floors installation and examine the subfloor underneath. Make any repairs to the subfloor, if necessary, prior to installation.

## Whisper 3N1

Whisper 3N1 is a multi-use underlayment. It serves as a comfort, sound and moisture barrier. This new underlayment is thin, light and dense making it easier for installers to work with it on the job site.

Product specifications are as follows:

Thickness: 1 mm Roll weight: 6.5 lbs.

Roll size: 300 s.f. Pallet dimensions: 78" x 44" x 47"

Length: 50' Rolls per pallet: 60

Width: 72" Pallet weight: 471 lbs.

Roll diameter: 6"

Whisper 3N1 is available with or without connecting flaps. These flaps are designed to connect seams when a room requires more than one width of underlayment that is wider than 70". In order for the underlayment to act as a moisture barrier, the flaps must be used at any seam.

## Installation of Whisper 3N1 and AquaBarrier™

Whisper 3N1 and AquaBarrier II™ underlayment eliminates the need for a separate moisture barrier film and underlayment cushion. You will need one (1) roll of AquaBarrier II for every four (4) cartons of wood flooring installed. The amount of MegaGlue™ Adhesive required depends on the plank width being installed. Refer to MegaGlue™ Adhesive Requirements chart on page 71 for further details. Install AquaBarrier™ II by laying it out, poly side facing up. Seal all seams using the built-in edge sealing tape system. Tape any relief cuts or butt seams with duct tape.

# Laminate Flooring Installation Guide (continued)

## Laying and Fitting – Mannington Glueless Laminate Flooring

### General Instructions

Mannington “glueless” laminate floors are designed to be “floated.” That means they should never be nailed or glued to the subfloor. Glueless laminate planks are joined together by a specially designed mechanical locking profile; no adhesive is required to join the planks.

### Installation Procedure

Carefully measure the room to determine squareness and the width of the last row. If the width of the last row is determined to be less than 2" (50 mm), not including the bottom lip of the groove, the first row must be cut accordingly. Inspect each plank before installing. Closely inspect the edges of the plank to determine the tongue and groove profile. Remove any manufacturing residues from the tongue and groove before installing the plank. The factory-milled profiles of glueless laminate floors must always be removed when abutting a fixed vertical surface. This provides a full plank thickness at the juncture of the floor and walls. After determining the appropriate starting wall, remove the tongue of the first plank, and position this edge along the starting wall using  $\frac{5}{16}$ " spacers to maintain proper expansion gap. If the starting wall is irregular, the first row of planks must be scribed to fit.

Position one width of the appropriate Mannington Laminate underlayment along the starting wall. Always lay planks from left to right. In this procedure the tongue edge of the plank will be inserted into the groove, so it's important to lay out the first row with the tongue edge facing the starting wall. The last plank in the first row should be at least 12" (300 mm) long. If it is not, cut the first plank in the first row shorter to accommodate the required length of the last plank. Typically the remainder piece from the last plank may be used to start the next row; this plank should also be 12" (300 mm) or longer.

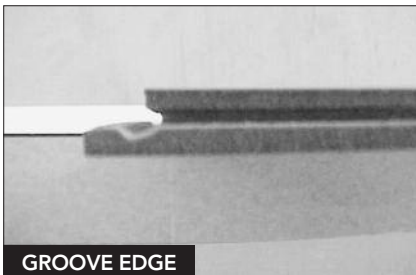

GROOVE EDGE

Closely inspect the edges of the planks to determine the tongue and groove profile.

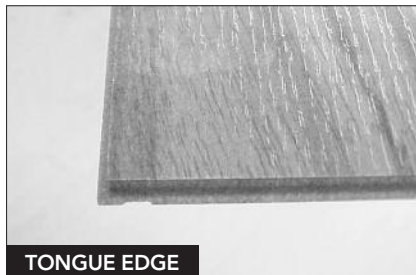

TONGUE EDGE

In this procedure the tongue edge of the plank will be inserted into the groove, so it's important to lay out the first row with the tongue edge facing the starting wall.



Cut off all milled profiles from the edges abutting vertical surfaces. This provides a solid edge to receive spacing devices.



Job layout and determining an appropriate starting point is also very important with glueless laminate installations. The installation should be “balanced” with nearly equal panel widths at the sides and no panels shorter than 12" at the length walls. Sometimes it is advantageous to start the installation in areas that would be difficult to tilt in the last row, for example under cabinets, door casings, etc.

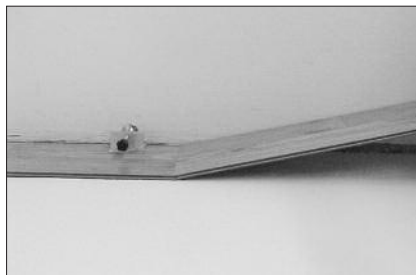

With the panel properly prepared, always lay planks from left to right, groove profile facing away from the wall. To join the second plank in the first row to the first plank, position the tongue end over the groove end of the first plank and insert the tongue at a slight angle. A slight downward “wiggle” motion locks the planks.

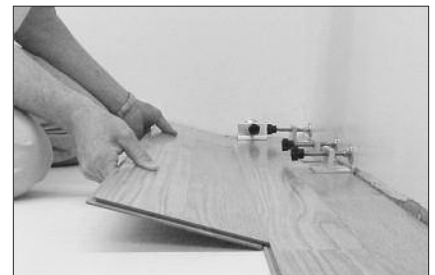

Begin second row with at least 12" stagger of end joints, assemble the first panel in the second row to the adjacent panel in the first row by slightly angling tongue into groove until plank locks into position. Insert the tongue at about a 20° angle and lock the planks together. (Use non-marring blue tape to secure the panel across the assembled joint to hold it in place.)

## Laminate Flooring Installation Guide (continued)

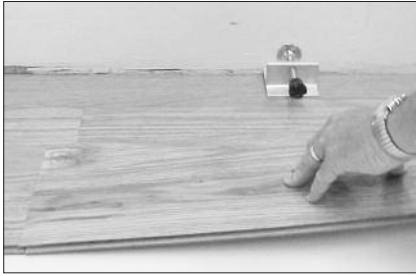

Position the end tongue of the second plank over the first plank in the second row, approximately 1/8" to 1/4" away from the side groove. Lock the end seam together. Always lock the end ("head") seams together before connecting sides seams.

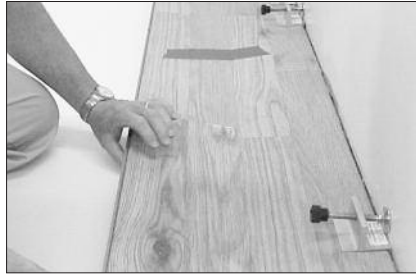

Slightly angle the side tongue profile of this panel into the side groove of the panels in the first row, and with a slight wiggling action, press tongue into groove and lower into position. (The tape will secure the previously assembled panels together.) If necessary, tap with the heel of your hand to close any minor gaps.

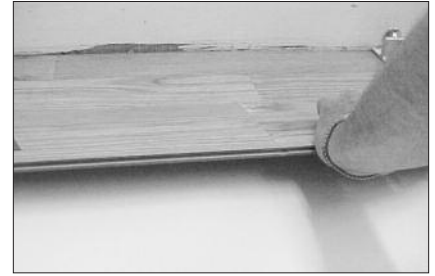

Continue to lay the flooring from left to right, row after row.



The last row of panels will more than likely need to be cut to fit. If not, it is still necessary to cut off the groove profile to provide a full plank thickness at the wall. If nothing prevents angling this last row of planks into position, proceed as normal to complete the installation.



If there are obstacles (door casings, toe kicks, radiators) that prevent the last row panels from being angled into position, it is necessary to lightly plane or sand off a bit of the locking profile of the groove and tongue.

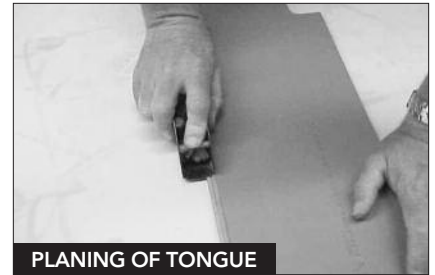

Position the panel onto the already installed row; slide the panel under the obstruction. It's a good practice to pre-fit the panel to make certain it will slide back into place before applying adhesive.



Separate the panels to completely expose the groove. Apply a light coat of Mannington MegaGlue™ onto the groove; slide the last row panel back into position. If necessary, use a last board puller to position the panel and lightly tap panel to close any gap. Wipe off any excess glue.

# Laminate Flooring Installation Guide (continued)

## Pipes, Pillars and Posts

Installing flooring around pipes, pillars, and posts is easy if the following directions are used. Remember, you still must maintain the  $\frac{5}{16}$ " expansion gap around all of these obstacles.

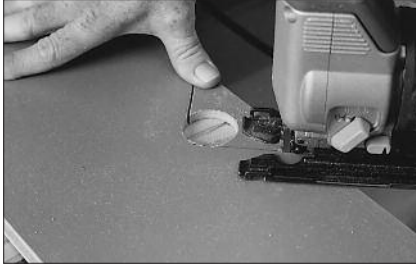

First measure the diameter of the obstacle. Then measure that distance from the edge of the plank to be installed around the obstacle so you know where to drill the hole. Drill holes in the floor plank  $\frac{5}{8}$ " larger in diameter than the obstacle and the correct distance from the edge of the plank. If the hole is near the edge of the plank, cut the plank at a 45° angle to both sides of the hole.



If the hole is near the center of the plank, cut perpendicular to the long edge, going directly through the middle of the hole.



Now you will have two separate plank pieces to enable positioning around the obstacle. Apply a liberal amount of MegaGlue™ adhesive to the cut pieces and press into place. Tighten with a pull bar and wipe away excess adhesive with a clean, damp cloth.

## Installation Instructions for Wet Areas

(Bathrooms, Laundry Rooms, and Utility Rooms)



When installing laminate planks in a bathroom, remove the toilet and fit flooring to within  $\frac{5}{16}$ " of the toilet flange. Fill this expansion gap with high-quality silicone caulk.



To finish installations in a high-humidity or wet environment, the expansion gaps at all vertical surfaces such as walls, cabinets, etc., must be filled with high-quality silicone caulk.



Install Quarter Round moldings directly into the wet silicone caulk.



Install T-Moldings and Wall Base over the silicone caulk-filled expansion gaps. Nail Wall Base directly into the wall, not into the laminate flooring. Fill the expansion gap between planks and tub with a high-quality silicone caulk then install the profile into the wet silicone. In areas where a square edge profile cannot be installed, completely fill the  $\frac{5}{16}$ " expansion gap with silicone caulk.



**NOTE:** Use Mannington End Cap moldings against bathtubs and shower stalls when possible.

## Laminate Flooring Installation Guide (continued)

### Repairs – Mannington Laminate Floors

Although Mannington Laminate Floors are inherently tough, they can be accidentally chipped by falling objects. Always inspect each plank closely before installation; however, if damage occurs after installation, use the following repair procedures.

#### Mannington Laminate Repair Sealant

Mannington Laminate Repair sealant is a color-matched compound that is used to repair small nicks and chips. The sealant is applied to the damaged area to fill the void and the excess is removed with a dry cloth.

#### Plank Replacement for Glueless Laminate

Although the traditional method of plank replacement can be used with Mannington glueless laminate products, it is often easier and quicker to simply disassemble the planks back to the damaged area. Determine the closest wall to the repair area and remove the molding. Lift up to disengage tongue and groove of the planks and unlock the planks. Install a conditioned plank to replace the damaged one and reassemble the flooring. Replace trim molding.

#### Floor Care Maintenance Instructions

Mannington Laminate Floors are the closest thing to “maintenance-free” floors. The melamine-impregnated surface with aluminum oxide makes it resistant to dirt and scratches.

- Ordinary vacuuming with a non-beaterbar vacuum or sweeping is usually sufficient to keep the floor clean. If needed, an occasional cleaning with a cloth or mop (microfiber or terry cloth hooded) slightly moistened with Mannington UltraClean® is recommended.
- Never flood the floor with water.
- Do not use soap-based detergents because these can leave a dull finish on your floor.
- Do not use abrasive cleaners, steel wool, or scouring powder because these can scratch your floor.



**IMPORTANT: Never wax, polish, sand, or lacquer Mannington Laminate Floors.**

- Use doormats outside each entrance to your home to prevent dirt, sand, grit, and other substances such as oil, asphalt, and driveway sealer from being tracked onto your floor.
- For increased indentation resistance, use wide-bearing, non-staining floor protectors – such as clear hard plastic or non-staining felt protectors – for heavy furnishings.

# Laminate Flooring Installation Guide (continued)

## Moldings – Mannington Laminate Floors

Finish your installations with our seven choices of moldings. Manufactured to coordinate with our line of laminate floors, Mannington Laminate Wrapped Moldings will enhance the appearance of any installation. Refer to the illustrations and descriptions below for the proper use of each molding.

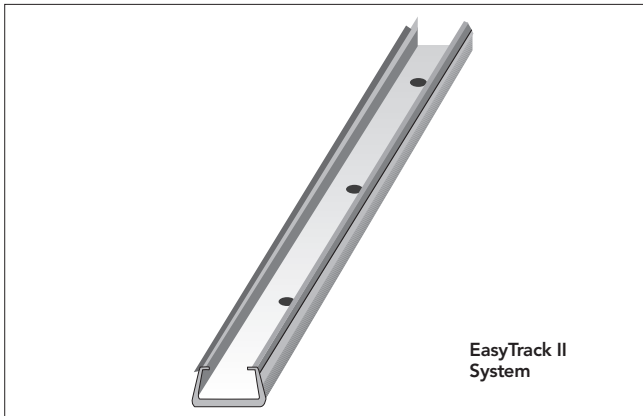

Use EasyTrack™ II System with T-Moldings and Reducer Strip moldings. Fasten EasyTrack™ II to the subfloor using either the supplied screws or construction adhesive. To use supplied screws, simply screw directly into wood subfloor or into concrete subfloors that have been drilled and plugged with dowels or plastic anchors. When using adhesive, allow it to fully cure before permitting foot traffic. The EasyTrack™ II System is included with all T-Molding and Reducer Strips.

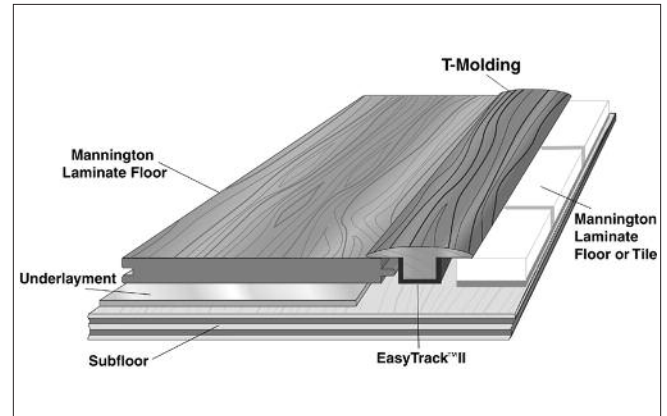

T-Molding is used in doorways or thresholds where it is necessary to join two sections of laminate flooring. It can also be used when an expansion joint is needed for covering large areas (plank length and/or width exceeding 45', or more than 2000 sq. ft.). Additionally, T-Molding can be used to transition laminate floors to other flooring materials with similar heights, such as ceramic tile or hardwood. Leave a full 1-1/8" space between laminate planks (or between laminate planks and other flooring) to allow a sufficient amount of space for EasyTrack™ II and the required 5/16" expansion gap on each side of the EasyTrack™ II.

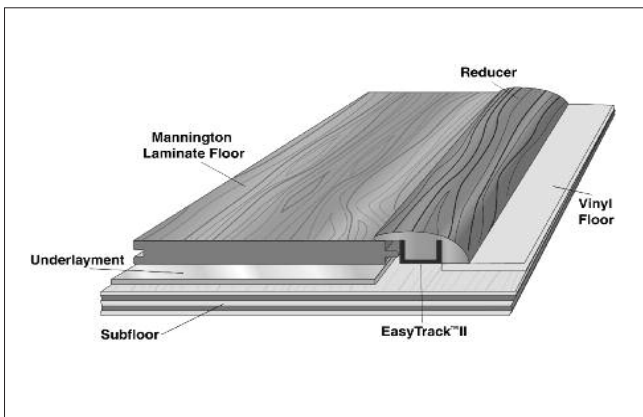

Reducers are used to join laminate flooring with other types of flooring lower in height, such as sheet vinyl or low pile carpet. A 1-1/2" space is required between laminate plank ends and the edge of the Reducer Strip to allow for the 5/16" expansion gap. EasyTrack™ II and screws are included.

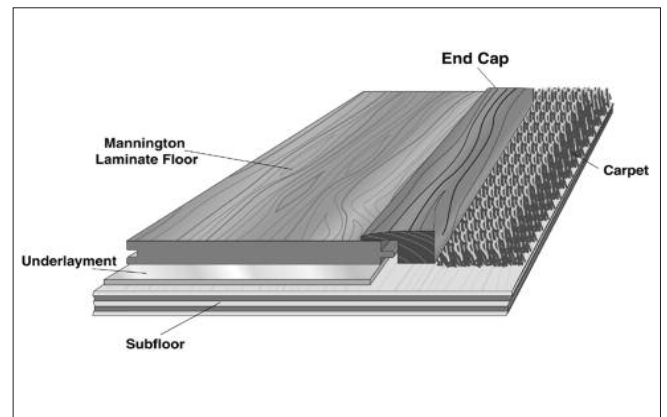

End Caps are typically used at exterior doorways to finish the space where the laminate floor ends, or any other place to give a finished appearance. They can also be used to join the laminate floor to another type of floor, such as carpet. Install End Caps against any vertical surface, with construction adhesive or finishing nails. If you choose to nail End Caps, first pre-drill holes. When using adhesive, allow the adhesive to fully cure before allowing foot traffic. An 11/16" space is required between plank ends and all vertical surfaces to meet the proper expansion space.

## Laminate Flooring Installation Guide (continued)

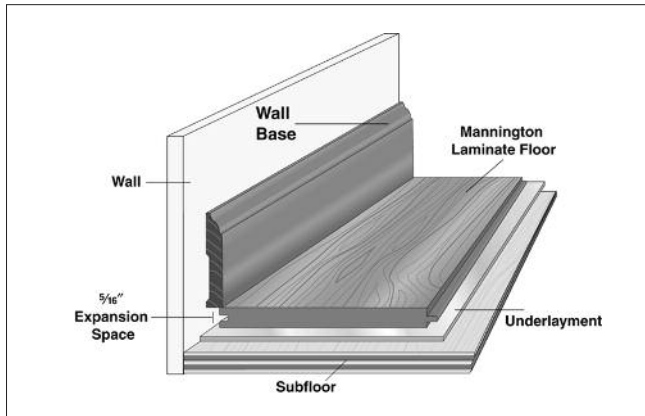

Wall Base covers the required 5/16" expansion gap to help join and blend the juncture of the new laminate flooring with the wall. Always fasten Wall Base into the wall, not into the flooring. When nailing Wall Base, first pre-drill holes. Use with or without Quarter Round.

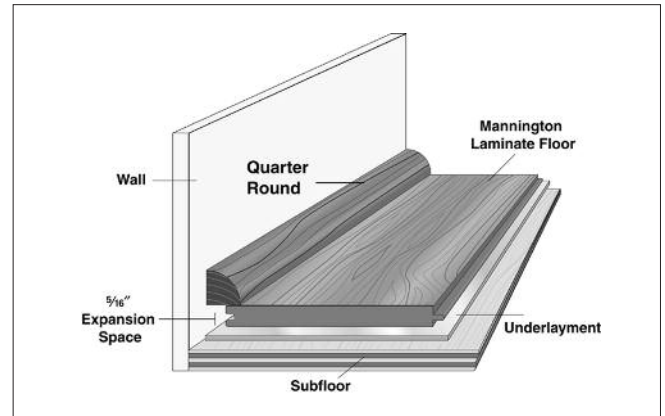

Quarter Round covers the required 5/16" expansion space to help join and blend the juncture of the new laminate flooring with the wall. Always nail Quarter Round into the wall, not into the flooring. When nailing, first pre-drill holes. Use with or without Wall Base molding.

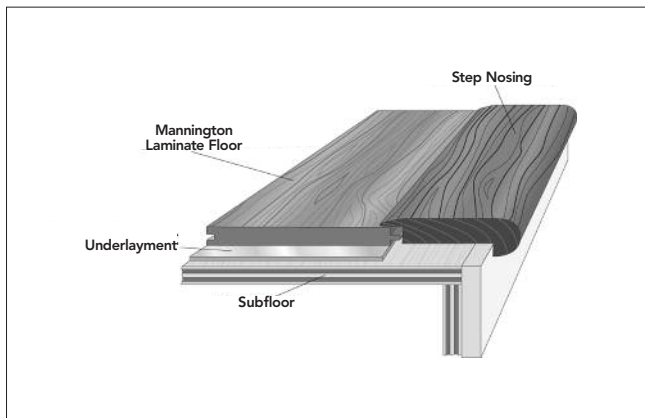

Step Nosing adds a finished look to laminate floors where subfloors change one level, such as a sunken family room. When nailing Step Nosing, first pre-drill holes. When using construction adhesive, let it fully cure before allowing foot traffic. A 1-1/4" space is required between plank ends and the edge of the stair riser to allow for the 5/16" expansion gap.

# Laminate Flooring Installation Guide (continued)

## The NatureForm® Tile Collection

### General Instructions

The NatureForm Tile Collection is designed to be installed using the “floating” floor system. This means that the panels are not secured to the subfloor; rather each panel joint is glued to the next, creating a strong, continuous surface. (Please check the product to be sure it is the “glued” version and not the new “click” NatureForm Tile product.)

NatureForm Laminate Tile is uniquely designed to provide a realistic ceramic tile visual. Each panel contains either three tiles (large slate/stone collection) or 12 tiles (small slate/stone collection), including grout lines, which allows for larger panel dimensions. Each panel is 15¾" wide by 47½" long. The depth and dimension of tile designs and grout lines, combined with realistic embossing, gives The NatureForm Tile Collection the realistic look of ceramic tile, with the benefits of laminate flooring.

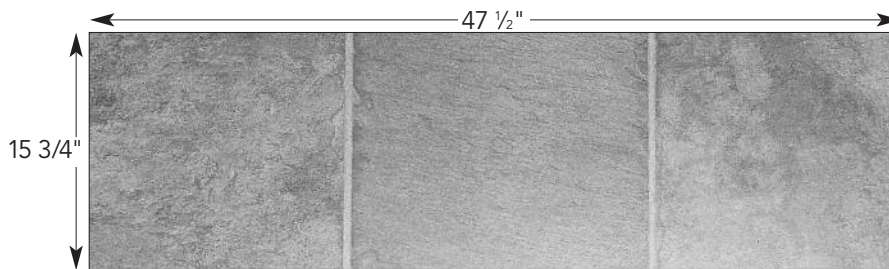

### Storage & Handling

Always store cartons horizontally on a fully supported flat surface. Do not stack pallets more than two high. Protect packages from forklift or other traffic. Also, during storage, carefully protect package corners and lay boxes horizontally. The storage area must be climate-controlled with a temperature range between 65°F and 90°F (18°C and 32°C) and a relative humidity not exceeding 65%.

### Job Site Conditions

Condition the unopened cartons in the area where the floor will be installed for approximately 48 hours. Job site temperature should be 65°F or higher with a relative humidity not to exceed 65%.

As with all flooring installations, the job site must be climate-controlled. Never install laminate tiles in high-humidity areas where the floor is usually wet (steam rooms and saunas).

If the job site has a panel length or width of more than 30', additional expansion joints will be required. Mannington T-Moldings should be used.

### Subfloor/Underfloor Recommendations & Preparation

The NatureForm Tile Collection can be installed over all structurally sound wood or concrete subfloor systems on all grade levels. Subfloors must be clean and free of debris. The subfloor must also be smooth and flat to within ¼" ≤ per 10' span. All low spots must be filled with a high-quality cementitious compound, like Mannington MVP 2023, and all high spots must be removed by sanding or grinding.

Tiles can be installed over existing hard surface floor coverings. Heavily textured ceramic tile must be smoothed and leveled with MVP 2023.

NatureForm Laminate Tile may be installed over radiant-heated subfloors provided that the surface temperature of the in-floor heating system does not exceed 90°F.



# Laminate Flooring Installation Guide (continued)

## Wall Base Removal & Installation Preparation



Carefully remove all existing wall base, trim, and transition moldings using a pry bar.



Measure out the entire work area to ensure proper panel layout. Keep in mind the last panel to be laid in the work area must be at least 3" wide. A calculator may be helpful when figuring out how to arrange the floor. A NatureForm Laminate Tile panel measures 15-3/4" wide.



As with all tile formats, the best appearance is achieved by "balancing" the tiles at both the end and side walls. This can be accomplished by finding the centerline of the work area and adjusting the panels to provide equal size tiles at all walls.

## Getting Started



NatureForm Tiles must be installed over a Mannington Laminate underlayment such as AquaBarrier™ II, ComfortBarrier™ or Mannington® Hush. If you elect to use the Hush underlayment, be certain to take into account the additional thickness when undercutting door casings. Use a scrap piece of the new NatureForm Tile flooring as a guide. Be certain to allow enough room under

the casing for a 5/16" expansion gap. Lay the panel face down over a sheet of Mannington Hush and against the frame to act as a cutting guide. Make the cut using a hand or power jamb saw and simply slide the panel underneath the door casing.



**NOTE:** NatureForm Tiles are intended to be installed as a floating floor system. Never secure flooring to the underfloor with nails, glue, or screws.

## Laying & Adhering



After careful planning and layout, begin by dry-laying the first row. Always work from left to right in the installation area and against the tongue side of the panel with the groove edge facing the wall. Whenever possible, avoid working directly on top of the panels because damage may occur. Maintain an expansion gap of 5/16" by using spacing wedges in the corners and where panels join together. If the starting wall is irregular, the first row must be scribed, cut, and fit to the contour of the wall.

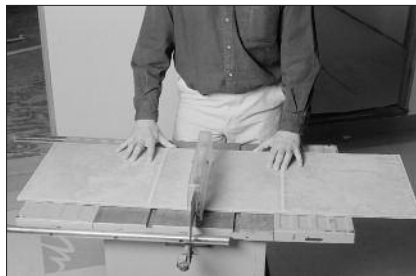

The tile panels can be cut using traditional cutting tools such as hand saws, jig saws, circular saws, power miter or chop saws, etc. The wide panel width of NatureForm Tile can be effectively cut to length using a table saw.

## Laminate Flooring Installation Guide (continued)



**NOTE:** Establish an area away from the work area for cutting and utilize "dust" containment systems when cutting. Keep the debris created during cutting out of the work area.

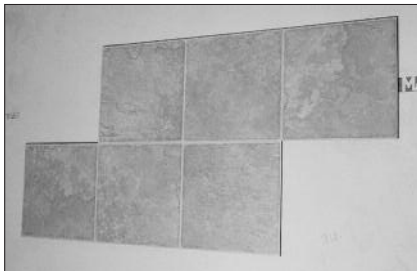

Stagger the end joints of the second row by at least one full tile pattern. Carefully align the grout lines on the panels. Pay particular attention to tile pattern repeats. Lay out panels so repetitive tile designs are not clustered.



Continue to dry-lay the first two rows of the tile panels as a trial layout, using spacing wedges to provide the required 5/16" expansion gap. Check each panel's alignment to be certain all panels are straight and both along the length and across the width.

### Last Row Installation



The last row of tile panels should be the same width as the first row. To scribe the last row of panels into place accurately, align the panel over the last installed row of panels and scribe to fit. Be certain to provide the required expansion gap.



Saw each panel in the last row accordingly and fit them into place using the pull bar. Then add the spacing wedges to hold the joints firmly in place and to create the required expansion gap between these last panels and the wall.

If installing NatureForm Laminate Tiles into a bathroom, always remove the toilet. Fit the panel to within  $\frac{5}{16}$ " of the toilet flange. Fill this and all other expansion gaps with a high-quality silicone caulking compound. Any time NatureForm Tiles are installed in an area that may become wet, the expansion gap must always be filled with a high-quality silicone caulk.

When fitting around pipes, pillars, or columns, always provide a  $\frac{5}{16}$ " expansion gap.

### Floor Care Maintenance

Follow same procedures as recommended on page 85.

# Laminate Flooring Installation Guide (continued)

## Technical & Packaging Information

### Packaging – Revolutions™ Plank

	Board	Thickness	Width	Length	Weight	Sq Ft	Cartons
Plank	1	5/16"	5 5/16"	50 1/2"	2.97 lbs	1.85	—
Carton	12	4"	5 5/16"	51 3/8"	35.7 lbs	22.24	1
Pallet	588	27 5/9"	54"	42"	1,749 lbs	1,090.0	49

### Packaging – Revolutions™ Tile

#### Adirondack

	Board	Thickness	Width	Length	Weight	Sq Ft	Cartons
Plank	1	5/16"	15 3/4"	50 3/4"	8.04 lbs	5.52	—
Carton	4	1 1/2"	16 1/4"	51 5/8"	32.15 lbs	22.11	1
Pallet	224	39 2/3"	32 1/2"	51 5/8"	1,800.53 lbs	1,237	56

### Packaging – All Other Revolutions™ Tile

	Board	Thickness	Width	Length	Weight	Sq Ft	Cartons
Plank	1	5/16"	12 3/4"	50 3/4"	7.07 lbs	4.46	—
Carton	5	1 3/4"	13 3/8"	51 5/8"	35.35 lbs	22.32	1
Pallet	270	31 1/4"	40"	51 5/8"	1,909.05 lbs	1,205.34	54

### Packaging – NatureForm® Tile Collection\* and Valu Tile

	Board	Thickness	Width	Length	Weight	Sq Ft	Cartons
Plank	1	5/16"	15 3/4"	47 1/8"	7.5 lbs	5.15	—
Carton	4	1 1/2"	16 5/16"	48 1/8"	30 lbs	20.61	1
Pallet	224	39 2/3"	32 5/8"	48 1/8"	1,680 lbs	1,154	56

### Packaging – Coordinations™

#### Coordinations and Value Lock

	Board	Thickness	Width	Length	Weight	Sq Ft	Cartons
Plank	1	5/16"	7 7/16"	50 1/2"	4.20 lbs	2.65	—
Carton	8	2 5/8"	8 1/8"	51 3/8"	33.60 lbs	21.21	1
Pallet	400	26 3/4"	40 1/2"	51 3/8"	1,680 lbs	1,061	50

## Molding Tips

- Before installing the first plank, select a dozen or more planks that closely blend with the molding.
- All Laminate Wrapped Molding Strips and Easy Track II come in 94" long pieces.
- Quarter Round, Wall Base, Step Nosing and End Caps are not available with Easy Track II System.
- Reducer Strips and T-Moldings include aluminum track screws and may be installed with or without the Easy Track II system.



Porcelain

# Porcelain Tile Installation Guide

## ESSENTIALS FOR PRODUCT SELECTION, JOB SITE CONDITIONS, SUBSTRATE PREPERATION, INSTALLATION AND MAINTENANCE.

The Mannington program is comprised exclusively of Porcelain tile. Our tile has been independently certified as porcelain tile by the Porcelain Tile Certification Agency which guarantees its performance characteristics. Made with special clays and minerals that are kiln-fired at temperatures exceeding 2400° Fahrenheit, porcelain ceramic tile is harder, denser and more durable than other ceramic tile products. It is frost proof and highly stain, scratch and water resistant. Extremely low water absorption precludes normal stains and makes cleaning quicker and easier. Porcelain tiles can be installed in both interior or exterior application and performs well in heavy traffic areas. In addition to performance, porcelain tiles are aesthetically pleasing and have become one of the most widely specified and selected products for flooring and wall surfaces. They offer a wide selection of sizes and colors to satisfy the needs for most residential and commercial installations. Porcelain tiles are beautiful in any color, are water resistant and when properly installed will last a lifetime. Porcelain tile, made from all natural products, is environmentally friendly.

There are essentially three **types of porcelain tile**. First, there is **glazed porcelain** tile in which the body of the tile is fully covered by glaze. Usually the body of the tile is a different color than the surface and you can tell that by looking at the face of the tile and then turning it over. If the body is a different color there is a high likelihood that it is a glazed porcelain tile. Another type of porcelain tile is **Color-Core™** tile. This is where the body is an integral part of the overall color of the tile. If you see the body color on the face of the tile you are most likely looking at Color-Core porcelain. Thirdly, there is **Tru-Color™** porcelain tile which is the same color all the way through the body of the tile. While some manufacturing techniques can become very complicated and proprietary, most if not all porcelain tile falls into one of these three categories.

**Product selection** is one of the most important and critical requirements for a high performance and aesthetically pleasing tile installation. The process for selecting your tile can seem daunting and confusing but Mannington offers a tile selection process that can alleviate some of the confusion. The process is as follows:

1. Choose Your Color and Texture
2. Choose Your Size and Layout
3. Choose Your Mosaics, Trim and Decorative Accents
4. Choose Your Grout

If you follow this strategy while selecting your porcelain tile it may overcome some of your concerns. Regardless of your requirements you will find a variety of sizes and colors, some with border and accents, allowing virtually unlimited decoration options. Additionally, Mannington offers a myriad of pattern options on our website at [www.mannington.com](http://www.mannington.com). The pattern that you select can significantly enhance the aesthetic and visual appearance of you tile. Just by changing the pattern you can change the look of the tile.

All ceramic or porcelain tiles are not suitable for all areas. Color-Core and Tru-Color porcelain features coloration throughout the tile, is less likely to show scratches and minor wear and is usually more slip resistant than glazed tile. Most porcelain tiles are wear-rated and most manufacturers worldwide meet international standards. Since all tiles are not rated for floor traffic it's important that you consult your Mannington Distributor or Retail Dealer representative to determine that your selection is appropriate for your particular job requirements. While selecting your tile please pay attention to several key porcelain tile characteristics. Pay attention to the shade rating which is classified by a "V" rating, V1, V2, V3, or V4.

## Porcelain Tile Installation Guide (continued)

V1 – Uniform Appearance	Differences among pieces of tile from the same production run are minimal
V2 – Slight Variation	Clearly distinguishable texture and/or pattern differences within the same pattern
V3 – Moderate Variation	While the colors present on a single piece of tile will be indicative of the colors to be expected on the other tiles, the amount of colors on each piece may vary significantly.
V4 – Substantial Variation	Random color differences from tile to tile so that one tile may have totally different colors than on other tiles. Thus, the final installation will be unique.

The shade rating is available for all Mannington porcelain tiles. It is extremely important to know what range of color your final installation will have after installation and it may require that you view several pieces of tile in order to ascertain the range. If slip resistance is a concern, check the Coefficient of Friction (COF). A tile with a COF  $\geq 0.60$  both wet and dry is considered slip resistant. There is a trade off between slip resistance and cleanability in some instances. Choose the tile that meets your aesthetic and performance requirements.

### Storage and Handling

Porcelain tile does not require special consideration regarding temperature or humidity and in certain climates it can be stored outdoors. Prior to beginning installation, check the materials to ensure that you have the correct pattern, style and color. Check your quantities to make sure you have the required amounts to complete your job. Inspect the tiles before installation for any visible defects. Mannington products are manufactured to high-quality standards and are carefully inspected prior to shipment. Occasionally, however, defects are not detected. If visible defects in the product are detected, stop the installation and contact your local Mannington Distributor immediately. Consideration should always be given to security and protection from incidental damage from other construction trades.

### Job Site Conditions

The environment where tile is installed is critically important to successful installation and continued performance. The area should be free of all construction debris, dirt and surface contaminants. Unobstructed access to the job site should be provided and provisions must be made for handling the product from storage to the installation area. Prior to installation, permanent lighting or temporary lighting representative of permanent lighting, must be provided. Always consider the potential adverse effects of extreme temperatures and humidity on mortar and grout with exterior installations of Porcelain tile. Adequate ventilation, heating and/or air conditioning should be available to sustain an environment required for the installation of bonding and grouting materials. The type and methods of construction, grade level and flooring system components all impact the final installation. Some minimal code requirements for flatness, levelness and deflection may not provide a suitable system for the installation of Porcelain tile.

### Substrates:

**Concrete and Masonry** – When tile is directly bonded to an existing concrete or masonry substrate, the tile installation is greatly affected by the suitability and condition of the concrete or masonry supporting the installation and providing the bonding surface. Flatness of the substrate must be checked to meet industry methods and specifications. The Tile Council of North America (TCNA) Handbook for Ceramic Tile Installation requires that tile substrates have no more than ¼" variation in 10 feet and no more than 1/16" variation in 1 foot from the required plane.

If substrates do not meet the flatness requirements and remedial corrections are not made, the installation will likely have lippage or flatness issues, a leading cause of complaints. When correcting concrete or masonry substrates use only products specifically designated for this purpose. Bonding materials like cement mortars (thin-sets) are not designed for patching or other thick applications. If the tile is 15"x15" or larger, it is strongly suggested that a medium bed thinset mortar be selected, allowing for the spreading of more mortar underneath the tile. Follow closely all manufacturers recommendations and directions.

In some instances grinding down high spots on floors will be necessary. Concrete and substrates must be clean and free from dust, paint, or drywall compounds that can act as bond breakers. It is important to check for cracks in concrete substrates. Bonding over cracks can lead to loss of bond or the crack telegraphing through the tile. Crack isolation, self leveling underlayments and uncoupling membranes are available to address problems of this type. Since there are many different methods of installation over concrete and masonry substrates the TCNA Handbook and the American National Standard (ANSI) Specifications for Ceramic Tile should be followed.

**Wood Substrates** – Unlike a concrete substrate, a wood subfloor only provides the support for tile installation, not the bonding surface. When wood is the substrate, it's important to be aware that wood expands and contracts when its moisture content changes. Wood substrates deflect, or bend, under loads more than concrete substrates. Tile installations require a rigid substrate that will not deflect, or bend when loads are applied. The greatest deflection will occur in the wood panels fastened to joists at the midway point between the joists particularly under point or concentrated loads. Too much deflection causes cracked and/or powdered grout joints, cracked and debonded tiles. Subfloor panel thickness and joist spacing determine subfloor panel deflection. Smaller joist spacing and thicker subfloor panes allow less deflection. Most floor installation methods in the TCNA Handbook limit joist spacing to 16" on center. However, there are methods in the Handbook that allows for a wider joist spacing, (19.2" on center and 24" on center) if certain requirements to prepare the substrate are met. All methods require the subfloor to be at least 19/32" (5/8"). Many methods require the subfloor to be 23/32" (3/4").

Some methods require a second layer of plywood for greater rigidity to reduce deflection. Since there are many different methods of installation over wood substrates the TCNA Handbook and the ANSI Specifications for Ceramic Tile should be followed. Further subfloor placement and fastening requirements can be obtained from the American Plywood Association (APA). Follow all applicable industry methods and specifications and individual manufacturers recommendations and directions. Backerboards and some types of plywood panels are suitable underlayments to install over a wood subfloor to receive ceramic tile. There are several types, each having different application suitability and some unique installation requirements for different applications. Because of their significant differences the TCNA Handbook contains separate installation methods and standards for the various board types. To ascertain proper use and installation methods review the TCNA Handbook and the specific board manufacturer's instructions.

**Membranes** – Membranes are flexile sheets that are bonded to concrete, wood and poured underlayments. They have a broad range of uses and come in many forms. Some are pre-manufactured sheet goods that are simply bonded to the substrate. Others are applied as a wet material that becomes the bonded membrane once it has dried in place. Some mortars used as the tile adhesive now possess the flexibility and meet the performance requirements of a crack isolation membrane. Crack isolation membranes, full and partial coverage, and uncoupling membranes are unique products. The proper methods and specifications for their use can be found in the TCA Handbook and the ANSI Specifications for Ceramic tile. Manufacturer recommendations and directions must be carefully followed.

## Porcelain Tile Installation Guide (continued)

**Layout** – Layout is critical to an aesthetically pleasing tile installation. Tile layouts should be centered and balanced as much as possible with respect to the tiled area and any specific focal points. Usually, a space offers more than one acceptable layout, making the final selection a matter of personal preference. The ANSI Specification for Ceramic Tile says: “an excessive amount of cuts shall not be made. Usually, no cuts smaller than half size should be made. Make all cuts on the outer edges of the field.” When multi-room layouts necessitate cuts smaller than ½ tile the best possible layout will place smaller cuts in the least obvious places. Movement joint requirements must be considered also. See the TCNA Handbook for Ceramic Tile Installation section EJ-171 for complete recommendations.

**Bonding Materials** – Innovative technology has produced a plethora of bonding materials for the installation of tile products. Careful consideration must be given to the type of substrate and type of tile selected in choosing the proper bonding material. Common tilesetter terms such as “thin-set” and “mastic” are not specifically defined meanings. The term “thin-set” is used interchangeably to describe a cement-based mortar and a method that encompasses all bonding materials that facilitates thin-bed installations. Therefore mastics (organic adhesives) and epoxies could be called “thin-set” Industry standardized terms for cement mortars are “dry-set mortar” or “latex/polymer modified mortar” instead of “thin-set”. Dry-set Portland cement mortar does not contain polymers and is often referred to as “unmodified mortar”. Cement based mortars that contain polymer additives are called “latex/polymer modified portland cement mortar” or “modified mortar”. Both perform dramatically better than organic adhesive (mastic) and are generally preferred for most jobs. Modified and unmodified mortars are sometimes interchangeable, however, many applications require the specific use of one or the other.

All bonding materials have minimum and maximum thicknesses that should not be ignored. Too little reduces bond strength and too much provides inadequate compressive strength and may shrink causing lippage and cracked tiles. Minimum bond coat thickness after proper bedding is 3/32” for cement mortars and 1/32” for organic adhesives. While cement mortars thickness varies by product generally about ¼” is standard. For thicker applications, use a medium-bed mortar which will maintain compressive strength and minimize the potential for shrinkage.

Organic adhesives (mastic) are ready to use products sometimes referred to as mastic or glue. They are categorized as Type I or Type II based on suitability for use in wet areas. Organic adhesives and cement-based mortars differ in composition and application suitability. Organic adhesives have considerably more limitations and should not be used interchangeably with cement mortars. Organic adhesive is not the best choice for bonding floor tile, even in dry areas its low compressive strength, as compared to cement mortar, will not withstand impact or loading. Epoxy bonding materials are available and should be used with the express manufacturers recommendations and directions.

**Tools** – Your Mannington Distributor can recommend a wide variety of tools for proper tile installation. The single most important tool is the notched trowel. They come in a variety of sizes and notch configuration and the proper selection is vital to the performance of the finished installation. There are square notches and rounded notches in a variety of widths and depths. The tile industry is one of a few industries that use notched trowels. They are designed specifically to apply a gauged amount of bonding material to the substrate. The National Tile Contractors Association, Inc. (NTCA) recommends the following Trowel Guidelines:



## Porcelain Tile Installation Guide (continued)

Adhesives –	4-1/4 wall tile and ceramic mosaics on dry wall – V-notch $\frac{3}{16}'' \times \frac{5}{32}''$ . 6'' X 6'' to 9'' X 9'' on dry wall – Square notch $\frac{1}{4}'' \times \frac{1}{4}'' \times \frac{1}{4}''$
Dry-Set Mortars –	4-1/4 wall tile and ceramic mosaics on masonry and concrete : U-notch $\frac{1}{4}'' \times \frac{1}{4}'' \times \frac{5}{16}''$ 6'' X 6'' to 9'' X 9'' on masonry walls and concrete: U-notch $\frac{1}{4}'' \times \frac{1}{4}'' \times \frac{3}{8}''$
Medium Bed Mortars - with thickness variation:	12'' X 12'' and larger size tiles on masonry or concrete & tiles $\frac{3}{8}'' \times \frac{3}{4}'' \times \frac{9}{16}''$ - $\frac{25}{64}'' \times \frac{3}{4}'' \times \frac{19}{32}''$

Always check trowel for excessive wear before use. Use the flat side of the trowel to key mortar or adhesive into substrate to achieve the best possible mechanical bond. Comb in one direction with the notched side of the trowel, holding at a 45 degree angle. Specifications require no less than  $\frac{3}{32}$  inch (2mm) mortar and  $\frac{1}{32}$  inch (1mm) adhesive between tile and substrate after proper bedding. Set tile with a sliding motion perpendicular to the mortar ridges. The 80 – 95 % coverage shall be sufficiently distributed to give full support to the tile with particular attention to support under all corners and edges of the tile. Periodically remove sheets or individual tiles to assure proper bond coverage consistent with industry specifications.

**Grouting** – A bad grout job can ruin a perfect installation. In addition to the aesthetic value of a quality grout job, it can affect the longevity and maintenance requirement of the tiled area. Properly mixed and applied polymer-modified cementitious grouts withstand the heavy service and maintenance conditions of commercial areas. Poorly-installed grout can show signs of wear under lighter conditions of a residential bathroom. Grout joint width and type of tile determine the grout product selection. A Grout Guide is provided in the TNCA Handbook covering suggested joint widths and tile type and use for the following grouts: Jobsite Mix (Sanded), Standard Unsanded Cement Grout, Standard Sanded Cement Grout, Polymer Modified Unsanded Tile Grout, Polymer Sanded Tile Grout, Modified Epoxy Emulsion, 100% Solid Epoxy, Furan, Silicone Urethane and Mastic Grout. Grout manufacturers provide printed instructions for proper mixing, cleaning and curing of each type of grout. These instructions must be carefully followed. A variety of sealers are available to enhance and protect certain types of grouts. Careful attention must be given to selection, application and clean-up of all sealers. Follow manufacturers' instructions explicitly. Top finishes and waxes affect the appearance of the tile and therefore are not recommended.

**Clean Up** – A final rinse of the grouted area should leave the surface clean and free of grout haze. Most grout haze can be removed from Porcelain tile with warm water and a mild detergent using a nylon pad or soft bristle brush. Acid cleaning is rarely recommended and should be done only by qualified personnel. When necessary, a solution of Sulfamic Acid is recommended with strict adherence to the manufacturers' instructions. All acid or acid based cleaners can adversely affect most grouts. Thorough rinsing to neutralize the acid is mandatory. Restrict traffic and use of freshly – grouted areas for at least 12 to 24 hours in residential applications and up to 72 hours in commercial installations. Exposure to water and freezing temperatures must be avoided. Temperature and humidity affect the curing time of all cementitious materials. Allow for extended cure times for temperatures below 60 degrees F and/or when relative humidity is above 70%. Check individual data sheets and closely follow manufacturers recommendations and directions.

## Porcelain Tile Installation Guide (continued)

**Maintenance** – Porcelain tiles require a minimum of maintenance. Sweep thoroughly and mop with a clean damp mop. If necessary a mild household detergent can be used. Do not use abrasive cleaners or brushes with hard bristles. Clean up spills immediately, use detergent in strengths recommended by their manufacturer, allow the detergent to remain on the surface of the tile as recommended and rinse thoroughly with clean water to remove the detergent and the emulsified residue. Choose a product compatible for cleaning the tile and grout at the same time. It is strongly recommended that a small test area be used prior to usage of installation, tile, cleaning and maintenance products to determine if the product selected will serve its intended purpose.

**Suggested Cleaners for Porcelain Tile** – Most household cleaners are sufficient to clean common stains so long as the problem is addressed immediately. Where stain removal becomes a problem, contact a cleaning and maintenance product supplier or your local Mannington distributor for professional suggestions.

### Technical & Packaging Information – Mannington Porcelain Tile

#### Warranties

Mannington (Mannington Mills Inc.) warrants that its first choice production porcelain tile (tile) is manufactured in accordance with ANSI A137.1-1988 standards. In the event that it is established that the tile has a manufacturing defect resulting from it not being manufactured in accordance with the said standards, Mannington will furnish, free of charge, material for replacement of the defective tile of compatible color and shade as determined by Mannington. Mannington shall not be responsible for labor charges incurred for installing replacement material and such charges are excluded from this warranty.

Mannington makes no warranty as to the suitability of its tile for installation for any particular purpose or location and it does not warrant that its tile will not scratch, chip or show signs of wear.

Mannington specifically excludes liability for consequential or incidental damages resulting from breach of its warranty except where exclusion of consequential damages is not permitted by applicable State law.

**This warranty is a limited warranty and shall constitute the full extent of Mannington's liability on its warranty. This warranty is in place of all other warranties, expressed or implied, including the implied warranty of merchantability and the implied warranty of fitness for a particular purpose.**

To make claim under this warranty, Mannington must receive notification of the claim as soon as reasonably possible but in no event later than one year after the tile has been installed. Claims must be made by calling-1-800-FLOOR-US or in writing and sent by certified mail to Mannington addressed to: Mannington Mills, Inc., Customer Care Department, 75 Mannington Mills Road, Salem, New Jersey 08079.

Claims concerning shade, appearance, caliber, finish or obvious defects in the tile must be communicated before the tile is installed. **No such claims will be accepted for tile that has been installed before Mannington receives a written claim sent by certified mail to Mannington addressed to: Mannington Mills, Inc., Customer Care Department, 75 Mannington Mills Road, Salem, New Jersey 08079.**

# Porcelain Tile Installation Guide (continued)

## Carton Labeling

Shade: Two-digit code; maximum of 5 shades; target shade is 50.

<b>48 – 49</b>	<b>50</b>	<b>51 – 52</b>
<b>Lighter</b>	<b>Target</b>	<b>Darker</b>

Production Run Identification: Alpha character (A – Z) represents this.

Sequence:      XX      A      X      Example: 50A5

                  Shade    Run    Size

```
graph TD
    A[50A5] --> B[Shade]
    A --> C[Run]
    A --> D[Size]
```

Size: One digit code; maximum of 5 calibrations per size; target caliber is 5.

<b>3 – 4</b>	<b>5</b>	<b>6 – 7</b>
<b>Lighter</b>	<b>Target</b>	<b>Darker</b>

How To Read Full Carton Label:

<b>ETOT13</b>	<b>WALNUT</b>	<b>50A6</b>	<b>1</b>
↓	↓	↓	↓
Order Code, Color Code, & Tile Size	Color Name	Shade, Production Run & Caliber	First Quality

 **NOTE: Rectified tiles are all one size due to manufacturing process and will not have a caliber listing.**

 **NOTE: Some lot listing methods on cartons will vary. Please contact customer service in Salem, NJ with any questions. *Need to add contact information***

## Trim Shapes Available



3" x 12" or 3" x 13"  
Bullnose



5" x 5", 6" x 6", OR  
6 1/2" x 6 1/2"  
Bullnose



5" x 5", 6" x 6", OR  
6 1/2" x 6 1/2"  
Bullnose Corner



2 1/4" x 5", 2 1/4" x 6",  
OR 2 1/4" x 6 1/2"  
V-Cap Countertop



Quarter Round  
Beak



1" x 5", 1" x 6",  
OR 1" x 6 1/2"  
Quarter Round



V-Cap  
Corner

## Installation Patterns

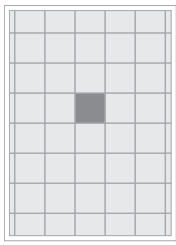

**Pattern 100**  
6" x 6"  
12" x 12"  
13" x 13"  
18" x 18"  
20" x 20" (100%)

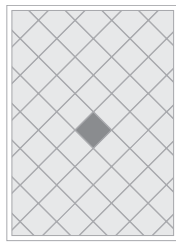

**Pattern 101**  
6" x 6"  
12" x 12"  
13" x 13"  
18" x 18"  
20" x 20"  
(100%)

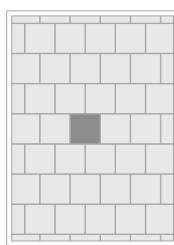

**Pattern 102**  
6" x 6"  
12" x 12"  
13" x 13"  
18" x 18"  
20" x 20"  
(100%)

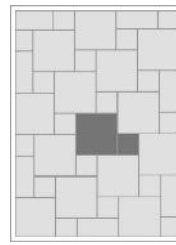

**Pattern 103**  
12" x 12" (80%)  
6" x 6" (20%)

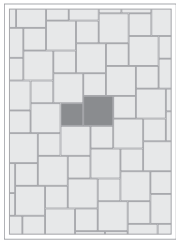

**Pattern 104**  
18" x 18" (69%)  
12" x 12" (31%)  
or  
18" x 18" (66%)  
13" x 13" (34%)  
or  
16" x 16" (60%)  
13" x 13" (40%)  
or  
20" x 20" (70%)  
13" x 13" (30%)

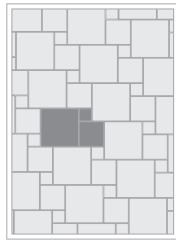

**Pattern 105**  
20" x 20" (65%)  
13" x 13" (27%)  
6.5" x 6.5" (8%)



**Pattern 106**  
18" x 18" (70%)  
12" x 12" (30%)

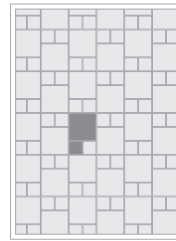

**Pattern 107**  
12" x 12" (66%)  
6" x 6" (34%)  
or  
13" x 13" (66%)  
6.5" x 6.5" (34%)

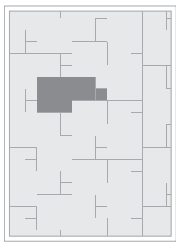

**Pattern 108**  
20" x 20" (61%)  
13" x 13" (26%)  
6.5" x 6.5" (13%)

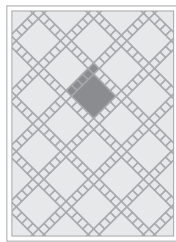

**Pattern 109**  
12" x 12" (57%)  
4" x 12"  
(Mosaic) Listello (43%)

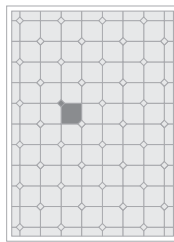

**Pattern 110**  
12" x 12" (95%)  
3" x 3" (5%)  
or  
18" x 18" (98%)  
3" x 3" (2%)  
or  
20" x 20" (92%)  
6.5" x 6.5" (8%)

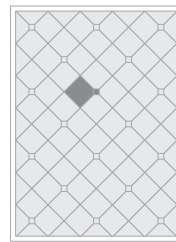

**-Pattern 111**  
12" x 12" (98%)  
3" x 3" (2%)  
or  
18" x 18" (99%)  
3" x 3" (1%)  
or  
20" x 20" (97%)  
6.5" x 6.5" (3%)

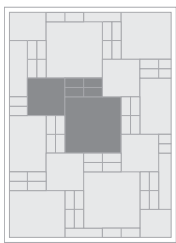

**Pattern 112**  
18" x 18" (60%)  
12" x 12" (27%)  
3" x 6" (13%)

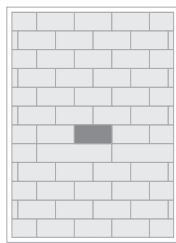

**Pattern 113**  
3" x 6" (100%)

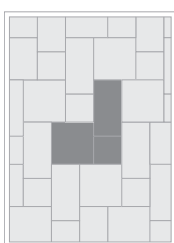

**Pattern 114**  
12" x 12" (20%)  
12" x 24" (38%)  
18" x 18" (42%)

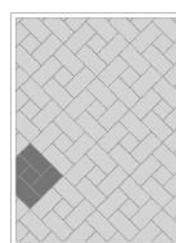

**Pattern 115**  
12" x 12" (11.11%)  
12" x 24" (88.8%)  
  
Pattern F or A

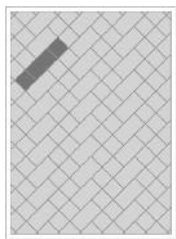

**Pattern 116**  
12" x 12" (50%)  
12" x 24" (50%)  
  
Pattern F or A



**Pattern 117**  
6" x 6" (33.3%)  
12" x 12" (66.6%)

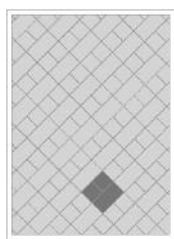

**Pattern 118**  
12" x 12" (50%)  
12" x 24" (50%)

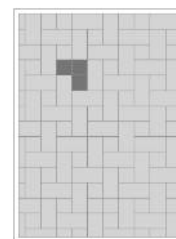

**Pattern 119**  
12" x 12" (33%)  
12" x 24" (66%)

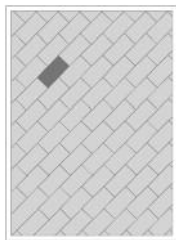

**Pattern 120**  
12" x 24" (100%)  
  
Pattern C or D

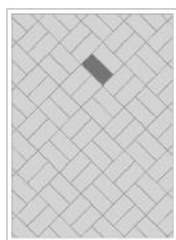

**Pattern 121**  
12" x 24" (100%)  
  
Pattern C or D



Commercial

# Commercial Resilient Sheet & Modular Flooring Installation Guide

## General Commercial Installation

### Subfloor Information

Careful and correct preparation of the subfloor is a major part of a satisfactory resilient floor covering installation. Roughness or unevenness of the subfloor will telegraph through the new floor covering, resulting in an unsightly surface and excessive wear on high spots. Proper subfloor preparation and suitable underlayment installation are essential for a trouble-free job.

### Wood Subfloors

#### General

All wood floors must be suspended at least 18" above the ground. Adequate cross-ventilation must be provided and the ground surface of a crawl space must be covered with a suitable vapor barrier. Wood subfloors directly on concrete or installed over sleeper construction are not satisfactory for the installation of Mannington Resilient flooring products. Wood subfloors must be covered with a minimum ¼" or heavier underlayment rated panel to assure a successful finished flooring installation.

#### Underlayment

Many times wood panel subfloors are damaged during the construction process or are not of underlayment grade. These panels must be covered with an approved underlayment. Underlayment panels are intended to be used to provide a smooth surface on which to adhere the finished floor covering. It must be understood that underlayment panels cannot correct structural deficiencies.

Particleboard, chipboard, construction grade plywood, any hardboard and flakeboard are not recommended as underlayment. All have inadequate uniformity, poor dimensional stability, and variable surface porosity. Mannington Resilient Floors will not accept responsibility for adhered installation over these subfloors. In all cases, the underlayment manufacturer or underlayment installer is responsible for all underlayment warranties.

### Concrete Subfloors

1. Concrete subfloors must be dry, smooth, and free from dust, solvent, paint, wax, grease, oil, asphalt sealing compounds and other extraneous materials. The surface must be hard and dense, and free from powder or flaking.
2. New concrete slabs must be thoroughly dry (at least six weeks) and completely cured. Curing agents, surface hardeners and other additives may cause adhesive bonding failure. These should be removed by sanding or grinding.
3. All concrete slabs must be checked for moisture before installing material. Details for moisture testing can be found in the Mannington Professional Installation Handbook. Anhydrous Calcium Chloride tests conducted according to ASTM F 1869 and In Situ Relative humidity tests as conducted according to ASTM F 2170 are the most commonly accepted test procedures. Mannington Commercial LVT must never be installed where moisture emissions may exist. Moisture emission from subfloor cannot exceed 3 lbs. per 1,000 sq. ft. per 24 hours as measured with the calcium chloride test or 75% relative humidity. Use Mannington Commercial M-Guard V-68 where high moisture resistant adhesive is required up to 8lbs or 80%RH. Mannington will not assume responsibility for floor covering failure due to hydrostatic pressure or moisture vapor emission. The final responsibility for determining if the concrete is dry enough for installation of the flooring lies with the floor covering installer.
4. Holes, grooves, expansion joints and other depressions must be filled with Mannington MVP 2023 Latex Underlayment (or equivalent) , and trowelled smooth and feathered even with the surrounding surface.

## Commercial Resilient Sheet & Modular Flooring Installation Guide (cont.)

5. Concrete floors with a hydroponics radiant heating system are satisfactory, provided the temperature of the floor does not exceed 90°F at any point. Before installing the flooring, the heating system should be turned on to eliminate residual moisture.

### Existing Resilient Floor Coverings

To achieve maximum product performance, Mannington Commercial Flooring products should not be installed over existing resilient floor coverings. In the rare cases where removal of the existing resilient floor covering is not an option, the existing flooring must be covered with MANNINGTON MVP 2023 used as an Embossing Leveler or other appropriate porous underlayment.

Refer to pages 6-7 for general requirements for site conditions and preparation.

### Resilient Sheet Installation System

Since Mannington Commercial Resilient Sheet Flooring products are intended for use in high-traffic areas, underfloor selection and preparation are especially important. In most cases, remove all existing floor coverings before installing these commercial products. (You must strictly follow all federal, state, and local regulations regarding the removal of existing flooring.) Furthermore, all concrete underfloors must be tested for moisture before starting the installation. Mannington requires that the anhydrous calcium chloride test be performed in accordance with standard test method ASTM-F1869. Alternate test is ASTM-F2170 with a relative humidity level of 75% maximum.



**NOTE:** Please be aware that installing these products over existing flooring may reduce their excellent indentation resistance.

### Roll Width Product Construction

Fine Fields®, Inlaid Magna® Micaflec and Magna® Multiflec BioSpec®, LifeLines II™, Relay RE and Mannington Assurance™ II are available in 6' wide rolls only.

CustomSpec II® and Insight® Heterogeneous Light Commercial come in 12' wide rolls only.

Realities and Primus heterogeneous commercial comes in 6', 9' and 12' wide rolls.

### Temperature Requirements

It is imperative to maintain the material, adhesive, and job site at a minimum temperature of 65°F and a maximum temperature of 90°F for 48 hours before and after the installation and while installing. If the material has been stored at colder temperatures, it will need to be unrolled and allowed to relax overnight before proceeding with the installation. When using V-95 adhesive (NOTE: V-95 has replaced V-85), make sure to maintain the adhesive, floor covering, and job site at a minimum temperature of 65°F for a minimum of 48 hours before and after the installation and while installing. NOTE: If the flooring contractor elects to install new floor covering over an existing floor covering, the flooring contractor assumes all responsibility as to the suitability and continued performance of the existing floor covering.

### Removing Existing Flooring

If removal of existing resilient floor covering is required, follow all recommended Resilient Floor Covering Institute (RFCI) work practices at [www.rfci.com](http://www.rfci.com).



## Commercial Resilient Sheet & Modular Flooring Installation Guide (cont.)

Do not sand, dry sweep, dry scrape, drill, saw, beadblast, or mechanically chip or pulverize existing resilient flooring, backing, lining felt, paint, asphaltic “cutback” adhesives, or other adhesives. These products may contain asbestos fibers or crystalline silica. Avoid creating dust. Inhalation of such dust is a cancer and respiratory tract hazard. Smoking by individuals exposed to asbestos fibers greatly increases the risk of serious bodily harm. Unless positively certain that the product is a non-asbestos containing material, you must presume it contains asbestos. Regulations may require that the material be tested to determine asbestos content. The Resilient Floor Covering Institute (RFCI) document “Recommended Work Practices for Removal of Resilient Floor Coverings” should be consulted for a defined set of instructions addressed to the task of removing all resilient floor covering structures.

### Patching & Leveling Compounds

We recommend the use of latex/Portland cement trowelable underlayments or self-leveling cementitious products for repairing or leveling concrete subfloors. Sand and fill approved underlayment panel joints using a latex/Portland cement compound. The properties and handling characteristics of Mannington MVP 2023 Fast Patch make it an ideal compound for use under Mannington Commercial Resilient Sheet Flooring products. Do not use gypsum or mineral-based patching compounds in commercial applications under any circumstances.

### Cutting and Fitting

Mannington Commercial inlaid products are flexible and will handle easily when cutting and fitting. This product characteristic lets the installer fit the material using freehand knifing techniques.

- If the job site is complex and requires a precise fit, use pattern-scribing techniques.
- The material may also be fit using direct scribing techniques. See page 40.
- Once the material has been fit, it is necessary to tube or lap back half of the sheet to expose the underfloor for adhesive application.
- Take care when folding the material back. Always fold the material in a wide radius to avoid sharp kinks and creases, which may cause breaks in the product.
- Fully adhere Mannington Commercial Resilient Sheet Flooring to an approved underfloor.
- After you have trimmed the material to fit the room, tube or lap it back to expose the underfloor. Apply adhesive with the recommended notched trowel.
- Spread adhesive over 100% of the exposed subfloor, leaving no gaps or puddles.
- Maintain uniform coverage by keeping the trowel clean and properly notched.
- In most cases it is advisable to give the adhesive sufficient open time. Open time allows the moisture to flash off the adhesive, permitting the adhesive to develop more body and immediate tack. Open time is always determined by subfloor porosity and atmospheric conditions. Be certain to provide ample open time on non-porous subfloors and at seam lines.

## Commercial Resilient Sheet & Modular Flooring Installation Guide (cont.)

### Type of Underfloor and Adhesive Trowel Notch

Porous substrates with V-81  $\frac{1}{16}$ " wide,  $\frac{1}{16}$ " deep, and  $\frac{1}{16}$ " apart

Non-porous substrates with V-81  $\frac{1}{16}$ " wide,  $\frac{1}{32}$ " deep, and  $\frac{1}{32}$ " apart

Porous substrates with V-82  $\frac{1}{16}$ " wide,  $\frac{1}{32}$ " deep, and  $\frac{1}{32}$ " apart

Porous substrates with M-Guard V-68  $\frac{1}{16}$ " wide,  $\frac{1}{16}$ " deep,  $\frac{1}{16}$ " apart and  $\frac{3}{8}$ " short nap roller

Non-porous substrates with M-Guard V-68  $\frac{1}{16}$ " wide,  $\frac{1}{32}$ " deep,  $\frac{1}{32}$ " apart and  $\frac{3}{8}$ " short nap roller

Porous substrates with V-95  $\frac{1}{16}$ " wide,  $\frac{1}{32}$ " deep, and  $\frac{1}{32}$ " apart

Non-porous substrates with V-95  $\frac{1}{16}$ " wide,  $\frac{1}{32}$ " deep, and  $\frac{1}{32}$ " apart

- After the adhesive has begun to tack up, roll the sheet forward into the adhesive to avoid trapping air. Do not drop or flop the material into the adhesive. Roll the floor covering with a three-section, 100 lb (or heavier) floor roller in both directions.
- After the first half of the sheet has been adhered and rolled, fold back the second half and repeat the procedure.



**CAUTIONS:** When providing open time, do not permit the adhesive to "skin over" or dry. Too much open time will result in insufficient bonding.

BioSpec, LifeLines II and Relay RE should be installed using V-82 or M-Guard V-68 adhesive over porous substrates. Use V-95 adhesive over non-porous substrates or where high performance is needed.

Mannington V-95 adhesive has low initial tack. It may be necessary to apply weights to the floor covering, especially in the seam area, until the adhesive sets. When using V-95 adhesive, roll the adhered flooring with a 100 lb (or heavier) roller within one hour after the flooring is installed.

Wait one to two hours and re-roll the flooring again to ensure full contact has been achieved. Re-rolling the material will also help remove any trapped air bubbles.

### Seam Cutting

#### Double-cutting method

CustomSpec II® and Insight™

- If required to seam CustomSpec® II or Insight™, provide additional length on the second and succeeding sheets to allow for proper pattern alignment.
- Position CustomSpec® II and Insight™ floors using the "Reverse" or "Do Not Reverse" method (see page 19).
- To minimize pattern run-out, the floor covering should always be laid out minimizing the length of the seams.
- Cut material to the appropriate sizes the day before the actual installation.
- Store the material at recommended temperatures.
- Roll these cuts tightly, face-out around a core, maintaining as equal a diameter as possible.
- Cut and install the pieces in sequential order. If the job requires more than one roll of floor covering, make sure all rolls are marked with the same shade letter and that the roll serial numbers are in consecutive order.

## Commercial Resilient Sheet & Modular Flooring Installation Guide (cont.)

- After aligning the pattern and providing adequate overlap, adhere the sheets of material up to the predestinated dry zone.
- Cut the seam using a utility knife with a new, sharp blade. Using a steel straightedge, cut through both sheets of flooring at a 90° angle to the floor covering.
- Once you have cut the seam, remove the selvage and fold back the sheets to expose the dry zone.
- Apply adhesive with a properly notched trowel across the dry zone.
- Allow the adhesive to develop tack and lay the sheet that was on the bottom during the cutting process into the adhesive first.
- Then place the top sheet into the adhesive; avoid scraping adhesive into the cut. Roll the area with the three-section floor roller.
- Bring seam edges level with the use of a hand seam roller.
- Thoroughly clean the seam area and wipe dry.

### Sealing Seams

CustomSpec II® and Insight™

Seal all CustomSpec II® and Insight™ seams using Mannington Commercial MCS 42 Seam Sealer.

- Apply the sealer using the VST-96 Professional Applicator Kit. (Note: MCS 42 replaces MCS 32).
- Fill the applicator bottle at least two-thirds full with the seam-sealing liquid and allow all entrapped air bubbles to disperse prior to sealing the seam.
- Apply the sealer in a continuous bead the entire length of the seam. Do not wipe the sealer from the surface of CustomSpec II® and Insight™.
- Allow the seam sealer to thoroughly dry (minimum two hours) before traffic is allowed on the floor.
- Do not allow dirt or dust to contaminate the wet sealer. Avoid walking on the seam or moving heavy furniture over it for another 24 hours.
- It is crucial to apply the seam sealer between the full thickness of the floor covering from top to bottom.
- To ensure a strong, tight seam, make sure there are no skips or skids along the cut. A properly sealed seam will provide a continuous, impervious surface and will remain intact for the life of the flooring.

### Recess scribing method

Magna®, Fine Fields®, BioSpec®, LifeLines II,™ Relay RE and Mannington Assurance™ II

When seaming is required with Magna®, LifeLines II,™ Relay RE, Fine Fields®, BioSpec®, and Mannington Assurance™ II, position the materials as "Reverse Sheets." This requires positioning the similar edges of the sheet together for seaming.

- Cut the selvage edge of one sheet using a straightedge and a utility knife or edge trimmer. Trim off about 3/8" from the edge. Trimming is necessary since 6' rolls are typically stored on end, causing compression on one edge.

## Commercial Resilient Sheet & Modular Flooring Installation Guide (cont.)

- Position the sheets in such a manner that the top sheet will overlap the previously straightened sheet by approximately 1/2".
- Fold back the sheets to expose the underfloor and apply the appropriate adhesive. Place the trimmed sheet into the adhesive while providing sufficient overlap of the second sheet; then lay in the second sheet.
- Roll the adhered areas to within 6" of the seam line with a 100-pound three-section floor roller.
- Adjust the recess scribe, before actually cutting the seam, by cutting a slit in a scrap piece of resilient flooring material. Insert the button on one edge of the slit. The needle should just touch the opposite side of the slit. Make sure to set the scribe to produce a net fit, neither gapped nor too full.
- Using a recess-scribing tool, insert the scribe against the straightedge piece of resilient. Use the bottom end of the tool, the guide, to follow the bottom sheet and lightly score the top sheet with the needle of the scribing tool. Keep the scribing tool perpendicular to the seam when scribing.
- Cut the seam net with a utility knife (straight or hook blade). Cut the seam by following the scribed mark. A burr may be created on the seam if the needle of the scribe is set too deep or if too much pressure is applied. Remove any burrs by placing the seam with the back of a hook knife.



**CAUTION:** If the scribe is pulled too tightly against the bottom sheet, the seam will be too full and will have the potential to peak.

- After scribing and cutting the seam, roll the seam area with a hand seam roller to bring the seam edges level. Re-roll the entire adhered area with the 100-pound floor roller. Thoroughly clean the seam area and wipe dry.

### Recommended Seaming Methods – Chemical or Heat-Welded Seams

#### PRODUCT CHEMICALLY WELDED

##### Mannington Assurance II™

- To utilize a chemical seam sealing method for Mannington Assurance II™, the flooring must be installed full spread using appropriate adhesive. Use V-95, centered at the seam location, in a 4" - 6" wide band.
- After installing the flooring, apply a narrow bead of MLG-33 seam sealer using the applicator with the fin up.
- Do not insert the fin into the seam.
- Be sure that the sealer is in contact with both sides of the flooring.
- Leave this bead of sealer on top of the flooring.
- Do not wipe the seam.
- Allow 24 hours for the sealer to set before allowing foot traffic or moving furniture or appliances across seamed area.

##### Magna, Fine Fields®, BioSpec® LifeLines II™ and Relay RE

- Thoroughly clean the seam of all adhesives, dirt, etc, before sealing it.
- If the seams are to be chemically welded, use Mannington Commercial MCS 42 Seam Sealer. (NOTE: MCS 42 replaces MCS 32).

## Commercial Resilient Sheet & Modular Flooring Installation Guide (cont.)

- When inserting the applicator tip into the seam cut, it is crucial that the seam sealer be applied to the full depth of the cut.
- Wipe off all sealer from the surface of the seam with a clean, white cloth dampened with mineral spirits.
- Because the seam sealer should not be allowed to remain on the surface of the flooring more than 30 or 40 seconds, it is recommended that five or six lineal feet of seam be sealed and then wiped clean. Be certain to overlap each application of seam sealer.

### Heat Welding

Heat welding is the act of fusing resilient sheets together with a heated thermal, vinyl weld rod. This technique is suitable for installing the following Mannington Commercial Resilient Sheet Flooring products: Fine Fields®, LifeLines II™, Rely RE, BioSpec®, Magna®, Mannington Assurance™ II, Realities and Primus.

**Never use heat welding on Mannington resilient products CustomSpec II or Insight.**

 **NOTE:** Heat welding is the preferred method of sealing seams for homogeneous products. Mannington's welding rod is available on spools and is designed to fit the most popular heat welding guns. Mannington offers a broad range of solid rod colors to coordinate with all of our heat weldable flooring. Camouflage weld rods are offered for Fine Fields® and BioSpec.®

To achieve good sealing results, knowledge of proper heat welding procedures is important. Follow the steps outlined in this section.

A repeated stop/start method will produce rough uneven seams, creating an unpleasant appearance.

Temperature setting is critical to the success of any heat welding application. If the welding gun is set too hot or applied too slowly, the flooring is likely to burn, char, or craze the surface next to the weld rod. If welding gun is not hot enough or is applied too quickly, the weld may have poor fusion. Regulate the temperature requirements to achieve an even seam with good bond strength and integrity.

Prior to heat welding, allow the flooring adhesive to completely dry. Preheat welding gun and determine proper temperature setting and router depth by practicing on scrap pieces of flooring. Make certain the speed nozzle is clean and free of obstructions.

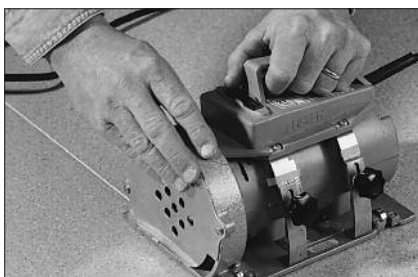

After waiting 24 hours for the adhesive to dry, use a power-grooving machine to cut a groove the entire length of the seam. Adjust the machine so the depth of the groove is about two-thirds of the product's thickness. Stop machine grooving several inches away from the wall.



Extend the groove to the wall using a hand-grooving tool.

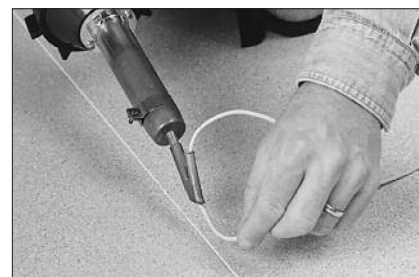

Insert welding rod into the speed nozzle, allowing approximately 3" to extend out. Arrange welding rod in such a manner that it will not interfere with the application. Be careful when inserting the welding rod because the nozzle is extremely hot.

# Commercial Resilient Sheet & Modular Flooring Installation Guide (cont.)

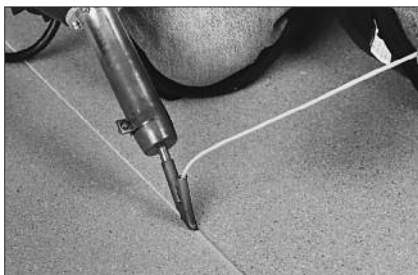

Pull the gun along the length of the seam toward your body while maintaining a downward pressure. Keep the gun perpendicular to the floor. Weld the seam at a constant, even speed.



Stop and change direction of the weld when you are near the back wall. Pull the gun out of the groove and cut the weld rod.



Allow welded rod to cool, and then groove the installed rod with a hand-grooving tool. Grooving the rod makes it possible to achieve complete seam coverage when you start seaming from the opposite direction to finish the job.



Reposition yourself and your tools at the back wall and continue welding into the grooved rod you just made so there are no missed spots in the seam. It is important to achieve a smooth, continuous coverage of the rod into the seam.

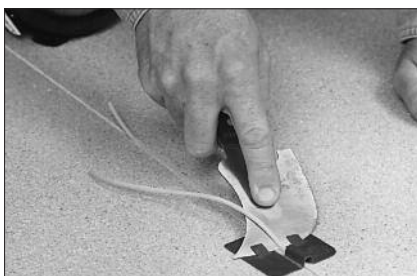

After the welded rod shrinks and cools for approximately 30 minutes, trim the excess by using the following two steps: Remove approximately two-thirds of the exposed welded rod. Use a spatula trim knife and trim plate to trim off the top layer. There should be about 1/32" excess weld rod projected above the surface of the resilient.



**CAUTION:** When trimming weld rods on Mannington Assurance II, do not allow weld rod to cool.



The second step is to trim the welded rod level until it is flush with the surface of the resilient sheet. Use an extremely sharp spatula knife without the trim. Place at a 5° to 10° angle to the floor surface. Keep the sharpened side down against the welded rod. Be careful not to cut or dig into the resilient surface. Inspect the finished seam carefully and remove any missed high spots with a spatula knife. If there are low spots, the seam weld may require a rod re-application.



Once the entire area has been trimmed and inspected, smooth out seam with one of the two recommended methods. When using camouflage weld rods, both steps are required.

**Glaze Curing the Seam:** Apply heat from the welding tool by removing speed nozzle and using the same heat setting to direct a flow of heat from the gun along the length of the seam.



**Seam Sealing the Seam:** To smooth out the seam, apply MCS 42 seam sealer to the welded seam and leave it on no longer than 30 to 40 seconds. Wipe all sealer from the surface of the seam with a clean white cloth dampened with mineral spirits. Do not wipe the seams of camouflage weld rods.

Allow the sealer to be absorbed into the rod. These last two steps reduce porosity of the trimmed rod and glaze the surface of the welded rod to produce a smooth, continuous appearance.

## Commercial Resilient Sheet & Modular Flooring Installation Guide (cont.)

### Seam Cutting Mannington Commercial Realities Heterogeneous

Mannington Commercial Realities heterogeneous sheet vinyl is available in 6', 9' and 12' widths. Choose product width to eliminate unnecessary seams and minimize waste.

When seaming is required with Mannington Commercial Realities heterogeneous sheet vinyl, the materials should be positioned Reverse Sheets for seaming.

The construction of heterogeneous vinyl requires that the seam be cut using the **trace cutting technique**. The selvage edge of the one sheet should be straight-edged approximately 3/8" from the edge. Position the sheets in such a manner that the straight-edged top sheet will overlap the untrimmed bottom sheet and maintain the pattern match. Carefully trace along the edge of the top sheet with a utility knife, with a sharp blade, or a cutting tool designed for this purpose. Remove the trimmed selvage edge of the bottom of the sheet.

Once the seams are cut, weight the sheets and tube or lap back the sheets to expose the underfloor. Apply the appropriate Mannington Adhesive, using the correctly notched trowel, over 100% of the exposed underfloor. After providing sufficient open time for the adhesive, lay the straight-edged sheet into the adhesive first, and then lay in the second sheet. Roll the adhered areas to within about 6" of the seam line, with a 100lb. three-section floor roller.

Roll the seam area with a hand seam roller to bring the seam edges level. Reroll the entire adhered area with the 100-pound floor roller. Thoroughly clean the seam area and wipe dry.

### Heat Welding Realities Heterogeneous Vinyl

Seams may be heat welded using coordinating solid color weld rod. Wait at least 24 hours after initial installation to allow the adhesive to cure before grooving the sheet vinyl to receive the heat weld rod.

Proper temperature of the heat welding tool is critical to the success of this process. Heat welding is always dependant on speed of the application and temperature. Practice on a scrap piece of material to determine optimum speed and temperature.

After the weld rod has cooled, trim the applied weld rod in two steps. Always use a trim plate with a sharp spatula trim knife for the first pass. Trim weld rod flush with the spatula knife, being careful not to gouge the vinyl surface.

Mannington Commercial Heat Weld Rod is color coordinated for use with Mannington Commercial heterogeneous sheet vinyl. Contrasting colors may be used if so desired.

### Chemical Seam Sealing Realities Heterogeneous Vinyl

Seams in Mannington Commercial Realities Heterogeneous Vinyl may be sealed using the chemical seam sealing method. The seam will be sealed with MLG 33 and the supplied applicator tip. Before sealing the seams, make certain all seams are clean, dry and free of adhesive contamination.

Insert the fin into the seam cut and lightly squeeze the bottle to apply a uniform bead of sealer approximately 1/8" wide, centered on the seam cut. *It is crucial that the seam sealer penetrate the full thickness of the seam cut to insure a proper chemical bond.* **Do not wipe the sealer from the surface of the heterogeneous vinyl.**

## Commercial Resilient Sheet & Modular Flooring Installation Guide (cont.)

### Flash Coving

All Mannington resilient sheet goods can be installed using the flash coving method. This edging technique, often preferred by hospitals and other healthcare facilities, is a process of extending the resilient flooring up the wall to create a wall base. Normally, the floor covering is extended up the wall to a height of 4" to 6". Coving is popular with end users because it eliminates the need for a floor/wall juncture and it is also easy to maintain.

As with all resilient installations, proper preparation of the work area is critical to the success of the installation. Clean the underfloor carefully and make certain it is structurally sound. The juncture of the floor and wall also needs special preparation before beginning a coved installation. Follow the instructions below to install the cove cap and the cove stick (cove fillet strip).

- Measure desired height for the cove caps at each corner and strike a chalk line.
- Attach aluminum or vinyl cove caps at this height using flathead nails with a hammer or brad pusher, or use contact cement.
- Always miter inside and outside corners in the cap. When mitering the outside corners, file the ends of the cap smooth. Use a specially designed miter tool with interchangeable die sets to make corners on the cove cap. This tool eliminates sharp edges at the outside corners.
- Cove sticks support the resilient flooring as it is flashed up the wall, eliminating the chance of puncturing the resilient flooring. Firmly secure plastic or wood cove sticks where the floor meets the wall, with adhesive or nails.
- Use nonstaining nails and set the flush with the stick. The stick should have a minimum radius of 1<sup>1</sup>/<sub>8</sub>" and be precisely mitered at all inside and outside corners.
- Provide a smooth transition in the door casings and other areas where the coving ends, by cutting back to the cove stick.
- Tack the scribing felt to the wall with brad type nails, before beginning to scribe it. Use a combination square, a small metal ruler, or a 1" piece of resilient to pattern scribe the felt.
- Fit the scribing tool up inside the cove cap, and scribe the felt by sliding the tool along the cap as you mark the felt with a pencil.
- Scribe and cut the outside corners of the felt, using a utility knife, and the inside corners of the felt, using dividers.
- After scribing the entire work area, position the pattern squarely on the resilient sheet flooring and transcribe the pattern with pencil dividers. Be careful when cutting the material on the inside and outside corners.
- Dry fit the material. Inside corners should fit snug, but not be forced into position. Make sure to always position the shorter side first and then the longer side.
- Gently pull material away from the wall. Apply the appropriate adhesive to the floor, wall, cove cap, and cove stick.
- Allow the appropriate amount of open time. Fit the material back into place. Remember to always position the shorter side first.
- Roll the flooring with the appropriate size roller (use a hand roller on coved areas). Apply the appropriate seam sealer at all seams, following the recommended directions for the resilient floor being installed.



## Commercial Resilient Sheet & Modular Flooring Installation Guide (cont.)

- The most demanding aspect of a coved installation is forming the outside corners. Fill outside corners with a “boot” type plug, rather than a V-type plug, on the least visible wall. The plugged corner fill piece should extend back at least several inches from the corner. The seam of the floor should be below the cove stick. Using an underscriber, scribe the back of the plug at the corner. This will mark the pattern of the corner on the plug.
- Cut along the scribed line at a 45° angle, with a curved trim knife or a utility blade, while holding the plug steady with a metal ruler and your other hand. When cutting, leave the face of the plug longer than the back.
- Check the fill piece for accurate fit. Make any minor adjustments to the plug, as necessary, to fill the space correctly. Remove the fitted fill piece and apply the appropriate adhesive. Reposition the fill piece and apply seam sealer.



**NOTE:** If planning to heat weld the seams, be aware that only Mannington Commercial Fine Fields®, BioSpec®, Mannington Assurance™ II, Magna®, LifeLines II™ and Relay RE products can be used. Remove the urethane coating before heat welding each inside corner by grooving or sanding. Preformed metal corner caps may also be used.

---

# Commercial Vinyl Composition Tile and Premium Visual Tile Installation System

For Essentials™ • Designer Essentials® • Inspirations™ • Brushwork® • ColorPoint • SolidPoint • Safe Walks

## General Instructions

Follow all General Installation Guidelines as described on pages 3 to 8. Always store Mannington Commercial Vinyl Composition Tile (VCT) and Premium Tile (PT) in a protected, dry interior area. Do not double-stack pallets. Keep the job site, adhesives, and tile at a minimum temperature of 65°F and maximum of 100°F for at least 48 hours before installation. Maintain this minimum temperature during the installation and for 48 hours after the installation, to assure proper bond of the adhesives.

Store VCT and PT on a dry, level surface. Do not stack VCT or PT cartons more than five cartons high. Be careful to stack cartons in straight tiers. Never double-stack pallets of VCT or PT cartons. Store pallets so they are protected from accidental damage from forklift trucks or other traffic. Protection of the carton corners is highly recommended.

If you intend to cover a concrete slab with resilient floor covering, always test the concrete slab for the presence of moisture.

The **required** quantitative tests are the calcium chloride test or the in situ relative humidity test. The maximum acceptable moisture vapor emission specification is not to exceed 8 lbs per 1,000 sq ft per 24 hours or not exceed 85% RH for all Vinyl Composition Tile and Premium Tile products when installed with Mannington M-Guard V-11 Vinyl Composition Tile adhesive. **This only applies to Mannington Commercial VCT and PT installations using M-Guard V-11 adhesive.** If any other adhesive is specified or selected, follow the adhesive manufacturer's warranty and recommendations regarding acceptable maximum moisture emission levels. The 5 lbs. moisture vapor emission rating is only applicable to Mannington Commercial VCT, PT, and Commercial felt-backed Resilient sheet products, and not any other Mannington Resilient sheet product. The maximum acceptable moisture vapor emission level for all Mannington Residential, homogeneous and heterogenous Resilient sheet products is 3 lbs per 1,000 sq ft per 24 hours except when using M-Guard V-68 high moisture resistant adhesive for Commercial Vinyl Back products.



**NOTE: Moisture testing can only indicate conditions at the time of the test and cannot predict any future changes in moisture levels. Neither Mannington nor the flooring contractor can be responsible if moisture levels change in the future.**

Install Mannington VCT and PT only after the job site has been cleaned and cleared of other trade apparatus that may damage the finished tile installation. The lighting on the job site must be sufficient to permit inspection and preparation of the underfloor, layout, installation, cleanup, and final inspection of the tile. Always check the cartons to assure the pattern number is correct and that there is a sufficient quantity of tile for the installation. Make certain the lot numbers are the same on all cartons. To minimize any minor shade variation on large installations, mix and install tiles from several different cartons. If the shade variation is extreme, do not install the tile.



**NOTE: Please be aware that installing Vinyl Composition Tile (VCT) and Premium Tile (PT) over existing flooring may reduce its excellent indentation resistance.**

# Commercial Vinyl Composition Tile and Premium Visual Tile Installation System (continued)

## Tile Layout

You may position VCT and PT either square or diagonal to the room. In both cases, layout is critical. All border tiles should be relatively even in width and, if possible, at least one-half of a tile wide. Additionally, if you lay the tile on a diagonal, border tile color and/or graining against the wall should be consistent within the area.

## Square Layout

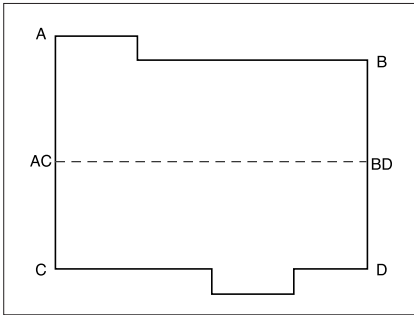

Divide the room into equal quadrants. Because most sites will not be perfect rectangles and will have irregular walls, begin laying the tiles from the center of the work area. To determine the center, take accurate measurements of the length and width of the room, disregarding small offsets, alcoves, etc. Find and mark the midpoints of the end walls (AC & BD) and strike a chalk line between these points. This line bisects the work area across the length of the room.

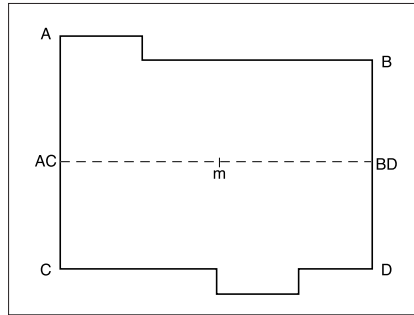

Measure line AC/BD to find and mark the midpoint (m).



**NOTE:** Do not install VCT or PT over existing VCT or PT below grade.

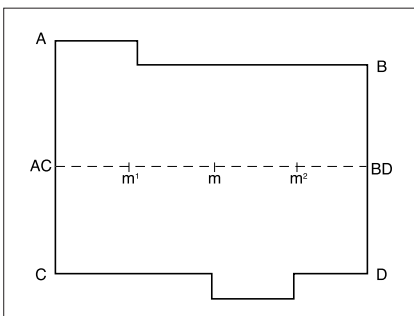

Using point m as the center, measure out an equal distance from the center on both sides of the midpoint (usually 3" to 5") and mark points  $m^1$  and  $m^2$ .

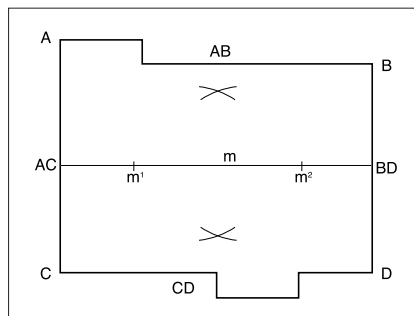

Using any convenient measurement greater than m to  $m^1$ , strike two arcs perpendicular to line AC/BD from points  $m^1$  and  $m^2$ .

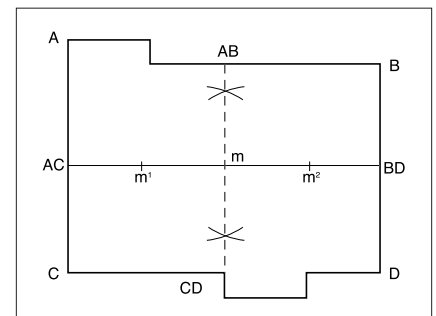

Strike a chalk line between the arcs from the intersection of the arcs. This line will pass through point m at right angles to line AC/BD. Once the work area is divided into equal quadrants, the tile should be dry-laid, or precise measurements taken to determine the size of the border tile. Adjust lines AB/CD and/or AC/BD to ensure equal border tile (at least one-half of a tile).

# Commercial Vinyl Composition Tile and Premium Visual Tile Installation System (continued)

## Diagonal Layout

If you intend to lay the tile on a diagonal (45°) to the work area, square the room as outlined in the diagram.

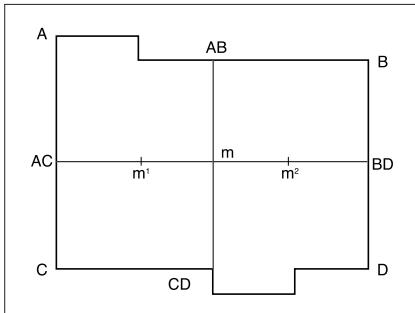

Using point  $m$  as a center, measure out any workable dimension along lines  $AC/BD$  and  $AB/CD$ . Typically, the measurement will be equal to  $m$  to  $m^1$  and  $m^2$ .

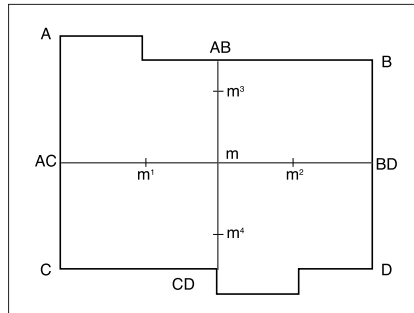

Mark line  $AB/CD$ , creating points  $m^3$  and  $m^4$ .

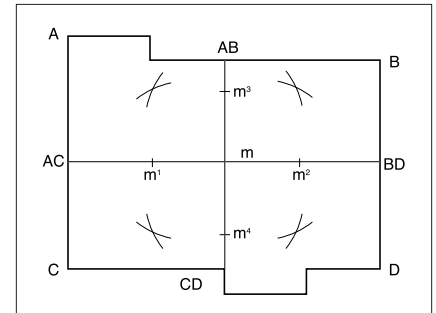

Using a dimension greater than  $m$  to  $m^1$ , etc., strike an arc from  $m^1$ ,  $m^2$ ,  $m^3$ , and  $m^4$ .

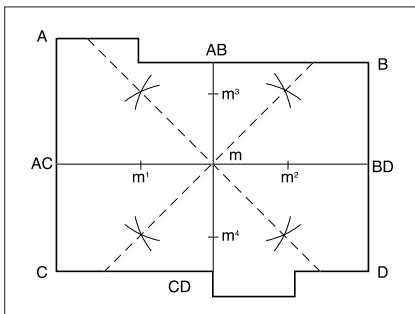

Connect the intersecting points to create lines  $AD$  and  $BC$ . Dry-lay tile or take accurate measurements along lines  $AD$  and  $BC$  to determine the size of the border tile. If proper tile size or color is not obtained, adjust the diagonal lines. The grain of border tiles laid on a diagonal should run in the same direction as the grain of the corresponding tile.

## Adhesive Recommendations & Application

M-Guard V-11 is a premium moisture-resistant pressure-sensitive adhesive developed specifically for installing Mannington Vinyl Composition Tile (VCT) and Premium Tile PT over approved substrates. Intended Use: M-Guard V-11 may be used on concrete or approved and appropriately constructed wood or wood composition subfloors/underlayments. M-Guard V-11 is suitable for use over new concrete substrates with in-situ moisture measurements of 85% RH as measured by ASTM F2170 or moisture vapor emission rate (MVER) of up to 8 lbs (3.6Kg) per ASTM F 1869, and a pH below 11. (*M-Guard V-11 is not designed to be used over floors with moisture vapor emissions (MVE) from water of intrusion or hydrostatic pressure. It is designed only for slabs with high vapor emission from water of hydration.*) All concrete slabs on or below grade must have a functioning vapor barrier directly under the concrete slab.

Use of adhesives contrary to this recommendation is strictly the responsibility of the flooring contractor and/or the adhesive manufacturer.

## Application

- Make sure the subfloor is clean of dirt, paint, oils, wax, etc. The subfloor must be smooth and level before starting the installation.

## Commercial Vinyl Composition Tile and Premium Visual Tile Installation System (continued)

- Maintain the adhesive, tile, and job site at a minimum temperature of 65°F and a maximum temperature of 100°F during the installation, and for 48 hours after the installation.
- After you complete the tile layout, apply adhesive to one-half of the work area. Exercise caution to maintain the working lines. If necessary, re-strike the working lines over the adhesive after it dries clear.
- Apply M-Guard V-11 with a trowel notched  $\frac{1}{16}$ " wide,  $\frac{1}{32}$ " deep, and  $\frac{1}{32}$ " apart. M-Guard V-11 can also be applied using a roller or a brush.
- Apply adhesive evenly, with no bare spots or heavy puddles. Avoid overlapping edges of adhesive.
- Before installing tile, allow M-Guard V-11 adhesive to develop tack and dry. This normally takes 45 to 50 minutes. Humidity and/or subfloor porosity, however, always dictate the proper open time.
- Set tiles firmly against adjoining tiles and press into adhesive. Do not slide tiles into place.
- You can remove fresh adhesive smears with a cloth dampened with water. Dried adhesive may be cleaned using mineral spirits and a clean cloth.

### Tile Installation

After the M-Guard V-11 adhesive dries, begin laying tile at the intersection of the working lines. Place the first tile squarely against the working lines. Since the positioning of this tile determines the accuracy of the entire installation, it is critical to lay the starter tile exactly on the lines.

Once you have set the first tile firmly in place, begin laying tiles outward along both guide lines. Place tiles firmly against adjoining tiles and press into adhesive. Do not slide into place. Keep tiles on the guide line.

After you have positioned several tiles along the working lines, begin stair-stepping tiles into the field area. This will keep tiles square to each other throughout the installation. Lay tiles up to where border tiles must be cut to fit. Apply adhesive to the second half of the work area, let it dry clear, then continue laying tile.

### Cutting & Fitting Border Tiles

You may cut border tile to fit, using several techniques. The most common technique for square layouts is to place a full tile directly over the last full field tile. Using another full tile placed firmly against the wall and over the border tile, score the border tile. Be certain the graining of the border tile is properly aligned. Cut the border tile along the scored line and position factory edges of tiles together with the cut edge against the wall.

Use a template cut from stiff cardboard or hardboard to cut border tile in diagonal layouts. For Mannington Commercial 12" VCT and PT, cut the template to the diagonal dimension of the tile, approximately 17" square. Use accurate measurements to measure and cut the template. Use the template in place of the tile and proceed as outlined above.

You may direct scribe or pattern scribe the border tile for irregular walls, pipes, etc. For intricate cuts, we recommend you heat the tile from the back and cut with a sharp utility knife along the scribed marks.

### Finishing & Maintenance

Do not wash or scrub the floor for at least 4 or 5 days after installation, to allow the floor tiles to bond to the underlayment/subfloor. Keep heavy furniture and equipment off the floor for at least 48 hours to allow the adhesive to set. Sweep or vacuum thoroughly, and remove any residual adhesive with a clean, white cloth dampened with mineral spirits. Apply a minimum of two coats of a high-quality cross-linked acrylic floor polish to temporarily protect the floor until regular maintenance procedures can begin. Leave Mannington maintenance and warranty literature with the end-user. These are available from your Mannington Distributor.

# Commercial Luxury Vinyl Tile Floors Installation Recommendations

## Mannington Commercial Luxury Vinyl Tile Installation Recommendations

### General Information

These installation specifications are for all fully adhered installations of Mannington Commercial LVT, Nature's Paths, Nature's Path Select, Walkways, Assurance Squared and Create luxury vinyl flooring. All recommendations are based on the most recent available information. All instructions and recommendations must be followed for a satisfactory installation.

1. The floor covering, adhesive, and room temperature must be kept at a minimum temperature of 65°F or warmer for at least 48 hours before, during, and 48 hours after installation. Maximum temperature must not exceed 100° F.
2. Install Mannington Commercial LVT only after the jobsite has been cleaned and cleared of other trade apparatus that may damage a finished tile installation.
3. Always check the cartons to assure the pattern number is correct. To minimize shade variation, mix and install tiles/planks from several different cartons.
4. All subfloor / underlayment patching must be done with a non-shrinking water resistant Portland cement patching compound such as Mannington MVP-2023.
5. Never install Mannington Commercial LVT over residual asphalt-type (cut back) adhesive. It can bleed through the new floor covering
6. Mannington Commercial LVT is to be adhered with Mannington Commercial adhesives, Nature's Paths and Nature's Paths Select and Walkways will be adhered with Mannington Commercial V-82 or V-95 Adhesive. Create will be adhered using Mannington MT-711 or V-95 adhesive.

### Subfloor Information

Careful and correct preparation of the subfloor is a major part of a satisfactory resilient floor covering installation. Roughness or unevenness of the subfloor will telegraph through the new floor covering, resulting in an unsightly surface and excessive wear on high spots. Proper subfloor preparation and suitable underlayment installation are essential for a trouble-free job.

### Wood Subfloors

#### General

All wood floors must be suspended at least 18" above the ground. Adequate cross-ventilation must be provided and the ground surface of a crawl space must be covered with a suitable vapor barrier. Wood subfloors directly on concrete or installed over sleeper construction are not satisfactory for the installation of Mannington Resilient flooring products.

Wood subfloors must be covered with a minimum ¼" or heavier underlayment rated panel to assure a successful finished flooring installation.

# Commercial Luxury Vinyl Tile Floors Installation Recommendations

(continued)

## Underlayment

Many times wood panel subfloors are damaged during the construction process or are not of underlayment grade. These panels must be covered with an approved underlayment. Underlayment panels are intended to be used to provide a smooth surface on which to adhere the finished floor covering. It must be understood that underlayment panels cannot correct structural deficiencies.

Particleboard, chipboard, construction grade plywood, any hardboard and flakeboard are not recommended as underlayment. All have inadequate uniformity, poor dimensional stability, and variable surface porosity. Mannington Resilient Floors will not accept responsibility for adhered installation over these subfloors.

**In all cases, the underlayment manufacturer or underlayment installer is responsible for all underlayment warranties.**

## Concrete Subfloors

1. Concrete subfloors must be dry, smooth, and free from dust, solvent, paint, wax, grease, oil, asphalt sealing compounds and other extraneous materials. The surface must be hard and dense, and free from powder or flaking.
2. New concrete slabs must be thoroughly dry (at least six weeks) and completely cured. Curing agents, surface hardeners and other additives may cause adhesive bonding failure. These should be removed by sanding or grinding.
3. All concrete slabs must be checked for moisture before installing material. Details for moisture testing can be found in the Mannington Professional Installation Handbook. Anhydrous Calcium Chloride tests conducted according to ASTM F 1869 and In Situ Relative humidity tests as conducted according to ASTM F 2170 are the most commonly accepted test procedures.

Mannington Commercial LVT must never be installed where moisture emissions may exist. Moisture emission from subfloor cannot exceed 3 lbs. per 1,000 sq. ft. per 24 hours as measured with the calcium chloride test or 75% relative humidity. Use Mannington Commercial M-Guard V-68 where high moisture resistant adhesive is required up to 8lbs or 80% RH. Mannington will not assume responsibility for floor covering failure due to hydrostatic pressure or moisture vapor emission. The final responsibility for determining if the concrete is dry enough for installation of the flooring lies with the floor covering installer

4. Holes, grooves, expansion joints and other depressions must be filled with Mannington MVP 2023 Latex Underlayment (or equivalent) , and trowelled smooth and feathered even with the surrounding surface.
5. Concrete floors with a hydroponics radiant heating system are satisfactory, provided the temperature of the floor does not exceed 90°F at any point. Before installing the flooring, the heating system should be turned on to eliminate residual moisture.

## C. Existing Resilient Floor Coverings

To achieve maximum product performance, Mannington Commercial LVT should not be installed over existing resilient floor coverings. In the rare cases where removal of the existing resilient floor covering is not an option, the existing flooring must be covered with MANNINGTON MVP 2023 used as an Embossing Leveler or other appropriate porous underlayment.



**Note: Consult Mannington's Professional Installation Handbook or the Recommended Work Practices brochure from the Resilient Floor Covering Institute for specific instructions on removal of old resilient floor covering.**

# Commercial Luxury Vinyl Tile Floors Installation Recommendations

(continued)



**WARNING:** Do not sand, dry scrape, bead blast or mechanically pulverize existing resilient flooring, backing or lining felt. These products may contain asbestos fibers that are not readily identifiable. Using the above non-recommended procedures on asbestos-containing material can create asbestos dust. The inhalation of asbestos dust may cause asbestos or other serious bodily harm. Smoking greatly increases the risk of serious bodily harm.

## Installation

### Nature's Path Tile Layout

As with all tile formats, tiles should be "balanced" in the work area. Tiles may be laid squarely in the work area or laid out diagonally in the work area. In either case, the room must be accurately measured to square off the area and to determine the center point of the area. The work area should be divided into quadrants designated by striking chalk lines. It is critical that the intersection of the chalk lines be square at 90°. All border tiles should be of nearly equal dimensions and at least one-half of a tile wide. Careful and precise measurements must be taken during tile layout. Adjust this established line to accommodate a balanced layout and then transpose this line to a comfortable width away from the starting wall (approximately 2' to 3' wide). Apply the adhesive in this area and begin installing the tiles. **Lay all tiles in the same direction, all directional arrows pointing in the same direction.**

### Nature's Path Plank Layout

It is also important to balance the layout of the plank format. Proper planning and layout will prevent narrow plank widths at wall junctures. Determine layout to prevent having less than ½ plank width or very short length pieces. As with all plank products, lay the long dimension of the plank parallel to the long dimension of the work area. Accurately measure the room to determine the center line, adjust this established line to accommodate a balanced layout and then transpose this line to a comfortable width away from the starting wall (approximately 2' to 3' wide). Apply the adhesive in this area and begin installing planks.

### Combinations – Tile & Plank Layout

The modularity of Mannington Commercial LVT allows for interesting and decorative combinations of tile and planks. When determining proper layout for this custom installation it is important to consider the dimensions of the modular "design unit" and then balance the design unit in the work area. Careful and precise measurements must be taken to insure success with a combination design.

### Create Layout

The unique sizes and shapes of the Mannington Commercial Create allow for many interesting layouts. Create is available in 9" X 9" squares, 18" X 18" squares, 9" x 18" rectangles as well as Circles and Diamonds. The modular size of the square and rectangles can be combined or used separately. The area of each 9"X 9" tile is 0.56 square foot; 18" X 18" is 2.25 square feet and the 9" X 18" area is 1.13 square feet.

Circles and Diamonds must always be used together. The area of each circle is 0.75 sq ft and the area of each diamond is 0.25 sq. ft. When designing an area the ratio of circles to Diamonds is one-to-one, this means one Circle and one Diamond must be ordered for every Square Foot of the project. Example: Work area is 327 square feet in size, 327 pieces of Circle will be needed, 10 cartons ( $327 \div 36 = 9.08$  cartons) 327 pieces of diamonds will be needed, 9 cartons ( $327 \div 39 = 8.38$  cartons). **In addition to these product requirements an overage/waste factor of approximately 15% should be added.**

Regardless of which size or shape Create product is to be installed it is important to balance the installation. Square off the work area as with any modular product and establish starting lines.



# Commercial Luxury Vinyl Tile Floors Installation Recommendations

(continued)

## Adhesive Application

Mannington Commercial V-82, MT-711 or V-95 adhesive is required for adhering Mannington Commercial LVT to all approved substrates.

For Nature's Paths and Nature's Paths Select, Assurance Squared and Walkways apply the V-82 adhesive with a 1/16" wide, 1/32" deep, 1/32" apart notched trowel. Begin applying adhesive at the pre-determined chalk lines working in two to three foot increments working towards an exit of the room. The V-82 adhesive has a 30 minute working time. Do not apply more adhesive than can be covered in this time. Set Nature's Path into the wet adhesive and never work directly on top of the freshly installed product. Roll each installed section of flooring with a three –section 100 pound floor roller.

MT-711, used with Mannington Commercial Create will be applied with a 1/16" wide, 1/16" deep, 1/16" apart notched trowel along the pre-determined starting line. Allow MT-711 to develop tack before installing the Create product into the work area, the adhesive should have sufficient tack to hold the tile in place but not allowed to go completely clear. The non-typical sizes and shapes of the Create product benefit from being installed on a "tacky" adhesive, however, avoid working directly on freshly installed products to prevent shifting and gapping from occurring. Use knee boards if required.

Mannington Commercial V-95 two-part epoxy adhesive is used with Mannington Commercial LVT over non-porous substrates or where high performance adhesive is required. Apply the adhesive with a 1/16" wide, 1/32" deep, 1/32" apart notched trowel and then roll the adhesive ridges smooth with a pre-soaked 3/8" nap roller.

Wait 10-20 minutes then install flooring material. Be careful to insure proper transfer as material is laid into the adhesive. Proper adhesive transfer to the backing should be confirmed periodically by lifting the material. (Note that floor temperature directly affects setting time: The warmer it gets, the faster it sets.)

Begin applying adhesive at the pre-determined chalk lines working in two to three foot increments working towards an exit of the room. The V-95 adhesive should be provided a 30 to 40 minute open time. Set Mannington Commercial LVT into the wet adhesive and never work directly on top of the freshly installed product. Immediately roll each installed section of flooring with a three –section 100 pound floor roller. Wait approximately 1 hour and then re-roll the installed sections. Do not permit V-95 to dry on the surface of the flooring.

## Tile & Plank Installation

Nature's Path, Natures Paths Select and Assurance Squared tiles will be installed using the "wet set" method. This means that the tiles will be set before the adhesive begins to skin over or set. This requires that the tiles be installed from a wall working backwards towards an exit. Move the established lines to within 2' or 3' of the starting wall and apply the appropriate Mannington adhesive. Set the tile into the wet adhesive; do not slide tiles/planks into place. Thoroughly roll each section of installed product with a 100 pound three section floor roller. Do not walk or work on newly installed tile except to roll. Continue this process by striking parallel chalk lines, applying adhesive and setting product along the line. Continue this process working towards the exit.

Nature's Path tiles have arrows imprinted on the back of the tiles. Lay all tiles in the same direction, all directional arrows pointing in the same direction.

After the appropriate adhesive has been applied, begin laying Nature's Paths planks along the designated starting line, working back to the starting wall. Planks ends should be staggered in a random manner so as to avoid clustering the end joints. Varying the length of the starting plank can assure sufficient stagger of end joints. End joints should be staggered by at least 4". Pay particular attention to the randomness of the plank layout, avoid establishing a repeating pattern. Continue installing the planks in a random fashion and complete each area before

# Commercial Luxury Vinyl Tile Floors Installation Recommendations

(continued)

beginning the next. If required use a kneeling board to avoid walking on freshly installed planks.

## Create Installation

The Create products will be installed into "Tacky Wet" MT-711 adhesive. The adhesive will appear clear in the "Valleys" and cloudy in the "Ridges." Set size and shape as designed and place products firmly against each other. Do not slide the products into position to avoid dragging adhesive into the joints. Even though the Create products are installed into a "tacky wet" adhesive it is still recommended to transpose starting lines along a wall and work towards an exit, staying off of the newly installed product. Roll each completed section with a three-section 100 pound floor roller.

## Cutting and Fitting Border Tiles

Mannington Commercial LVT can be cut with a large tile cutter or by using the score and snap technique. Direct or pattern scribe the flooring to fit into complicated, irregular walls or pipes, etc.

## Finishing the Job

Mannington Commercial LVT must be rolled with a minimum 100 pound three-section floor roller immediately after installation. Roll the flooring in both directions to firmly seat the tile into the adhesive.

Cover all exposed edges. Use wood molding or vinyl cove base along all walls, cabinet toekicks, etc. Use transition strips in doorways or where new flooring joins another floor covering. Caulk along tubs, toilet bowls, etc.

Do not wash the floor for 48 hours after installation.

After 48 hours, damp mop to remove residual surface dirt.

Follow appropriate maintenance schedule for Nature's Path.

## Cautions and Miscellaneous

- Furniture should be moved onto the newly installed floor using an appliance hand truck over hardboard runways.
- Do not place heavy items on newly installed floor covering for at least 24 hours after completion of the installation. Heavy furniture should be equipped with suitable non-staining, wide-bearing caster.
- Floor covering subjected to excessive heat and light exposure is subject to thermal degradation. Use appropriate precautions to minimize potential affects on the floor covering.
- Oil or petroleum based products can result in surface staining. Do not track asphalt driveway sealer or automobile oil drips onto the vinyl floor covering.
- Use a non-staining walk off mats. Rubber can discolor resilient floor coverings.

# iCORE® II Advanced Composite Flooring

## ICORE II® Advanced Composite Flooring Installation Guidelines

### Getting Started

Assemble all tools listed below before beginning the installation process.

### Tools & Materials

- CoreWeld™
- Mannington® Whisper 3N1 underlayment
- Spacing wedges – 5/16" (1 cm)
- Pull bar
- Utility knife
- Tapping block and Hammer
- Pencil
- Tape measure
- Carpenter's square
- Transition moldings
- Hand or power jamb saw
- Circular saw, table saw, jig saw or preferably Bullet® Cutter
- Drill
- Chalk line
- Blue masking tape
- Safety glasses\*

\* Always wear safety glasses when using hammer or power equipment. Follow safety instructions and MSDS Data Sheets.

\* For future repairs, wrap remaining panels in original box and store in a normal, dry interior storage area at normal room temperature.

### Job Site Conditions

- Can be installed over structurally sound wood and concrete sub floors on all grade levels.
- Sub floor must be clean and free of debris.
- Sub floor must be level to within ¼ inch per 10-foot span.
- Low spots can be filled using Mannington's MVP 2023 floor patching compound.
- Sanding or grinding must be used to remove high spots.
- Can be installed over most existing hard surface flooring. Remove hardwood floors that are glued down over concrete.
- Can be installed over most properly prepared ceramic tile floors.

## iCORE® II Advanced Composite Flooring (continued)

- Can be installed over radiant heated flooring. (Maximum Temperature 90°)
- iCore II should not be installed over carpet.
- Jobsite installation temperature should be between 60° and 95°.
- iCore II is intended for indoor use in buildings that are climate controlled.
- iCore II should never be installed in areas subjected to direct and prolonged sunlight
- iCore II should not be installed over concrete sub floors where moisture problems exist.\*

\* Although moisture will not affect iCORE II plank, it is recommended not to install iCORE II over concrete slab with a history of excessive moisture.

If required, carefully remove existing wall base, trim, and transition moldings. Measure out the entire work area to ensure proper panel layout. Make sure the last panel to be laid in the work area will be no less than 2" wide. If not, the first panel to be laid in the work area must be cut to compensate for the difference in the last panel.

Undercut all bottom door casings so the new flooring will fit underneath. Use a scrap piece of the iCore II plank and Whisper 3N1 underlayment as a guide. Make the cut using a hand or power jamb saw. Be certain to allow enough room under the casing for an expansion gap.

Install Mannington Whisper 3N1 underlayment, only one sheet at a time during panel installation to prevent damaging the underlayment. Once the first sheet of Mannington Whisper 3N1 underlayment is covered with iCORE II flooring, install the second sheet. Do not overlap sheets. Butt the two edges of the sheet together and seal with duct tape.



**NOTE: Mannington Whisper 3N1 is a closed cell construction & does not require a moisture barrier if installed on or below grade.**

A 5/16" expansion space must be provided at all fixed, vertical structures. Use spacing wedges positioned at the head seams to prevent movement of the rows and position spacers between the side of the first row and the wall. *Spacers must be positioned around pillars, posts, pipes, thresholds, etc., to maintain the required expansion gap.*

### Laying iCore II

Fill the CoreWeld applicator and screw on the applicator tip. Snip off the very top of the applicator tip to the second ring. Apply an even application of weld to all head seams as you go. The majority of the CoreWeld will penetrate into the joint and will also evaporate quickly from the surface of the flooring, however, wipe the area with a clean cloth to ensure that all of the CoreWeld has been removed from the surface.

Once the starting wall has been determined, begin laying the iCORE II planks along the wall using spacers or adjustable wedges to maintain the expansion gap. It is imperative that this row be installed straight and tight at all end joints. Cut the last plank to fit.



**NOTE: iCORE II planks can be cut using traditional cutting tools such as hand saws, jig saws, circular saws, power miter or chop saws, etc. However, the preferred cutting tool, which will minimize dust & noise, is a guillotine, or Bullet® type cutter. Establish an area away from the work area for cutting and utilize "dust" containment systems when cutting. Keep the "dust" out of the work area since it can easily interfere with the fit of the planks.**

## iCORE® II Advanced Composite Flooring (continued)

iCore II planks incorporate a durable side click profile design which simplifies the installation process. Planks can be assembled tongue-to-groove, or groove-to-tongue according to the installer's preference.

The plank head seams have a horizontal click tongue & groove profile machined into the ends of each plank. This design enables the installer to first connect the side seams and then join the head seams horizontally either by hand, or with a tapping block. It is important that when using a tapping block, or similar device that you **only tap on the tongue-side of the plank head seam**. Following this instruction will assure that the decorative layer is not damaged.

Typically the cut-off plank from the first row can be used to start the second row providing that it is 12" or longer. Stagger the end joints of the second row by at least 12" from the end joints in the first row.

If using a tapping block, be careful not to use too much force, or to contact the decorative surface of the plank.

Randomly stagger the end joints to achieve a random and aesthetically pleasing appearance.

Closely inspect these first three rows to assure that everything is straight and true. Be certain that all end joints are tight and aligned. If necessary, adjust these three rows of iCORE II planks using adjustable wedges before proceeding with the installation. It is sometimes helpful to secure the alignment of these three rows with blue, non-marring masking tape.

**Apply CoreWeld to the head seams only.** CoreWeld should be applied to the head seams just **before** assembly. Place a generous amount of CoreWeld on the seams, and then push the plank end into the mating plank. Be careful, because the CoreWeld may "split" slightly. (Remember to wear safety glasses!) This method ensures that CoreWeld fully penetrates the seam and securely bonds the ends of the planks.



**NOTE: Continue installing the planks across the work area. Periodically throughout the installation, check to be certain that the panels are staying straight and true. Maintain the 5/16" expansion gap. Apply Core Weld to the head seams as you go.**

It is likely that the last row of planks will need to be rip cut to fit. Remember this last row must be at least 2" wide. Scribe the last row of panels as required maintaining the 5/16" expansion gap. Install the cut planks and pull into place with a pull bar.



**NOTE: After welding is complete, pour unused CoreWeld back into the can. Do not store CoreWeld in the applicator bottle.**

Use the appropriate finish molding or terminating profile as a transition to door thresholds, steps, or other floor coverings. When installing base, caution must be taken to not nail into iCORE II planks; iCORE II is a "floating floor" and the planks must have the ability to move / expand as building / subfloor shifts. iCORE II has matching moldings for all running line decor color. The moldings include quarter-round, wall base, step-nosing, and end-molding. T-molding and reducers have a rigid aluminum core and color match decor sheet for added durability.

### Repairs

Always inspect each panel closely before installation; however, if damage occurs after installation, the following repair procedures may be used.

If a panel is slightly damaged or chipped, fill it using Mannington Color-Matched Patchal Pencils. Follow all directions described on the container.

# iCORE® II Advanced Composite Flooring (continued)

## Plank Replacement



1. To replace a damaged plank, begin by drilling a ¼" to ½" hole in each corner of the damaged plank. Use extreme caution when drilling to prevent damaging surrounding planks.



2. Set a circular saw to the exact depth of the plank thickness and carefully cut along the perimeter of the plank approximately ½" in from the adjoining planks using the previously drilled holes as reference spots. Remove the center of the plank.



3. Use a sharp utility knife to cut straight through the locking profiles on both end joints. Remove the end pieces, the locking profile may remain in the adjoining plank. (If the end pieces are firmly welded with CoreWeld it may be necessary to reapply CoreWeld to loosen the piece.)

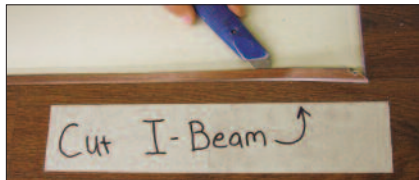

4. Cut along the length seam with a sharp utility knife being certain to keep the knife straight up and down to break the CoreWeld bond, be careful not to cut away the groove of the adjoining plank. It may be necessary to cut through the side "I-Beam" channel of the damaged plank to free it from the adjoining plank



5. Thoroughly clean the repair area with a vacuum cleaner, pay particular attention to adjoining plank edges.

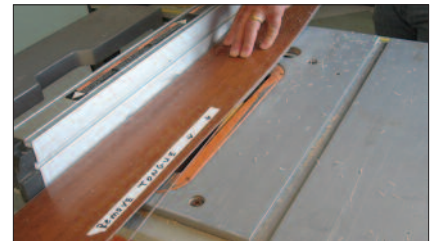

6. Prepare the repair plank by cutting off the tongue along both the side edge and the end edge leaving the full decorative surface to create a "shiplap" profile, cut off the end groove leaving the full decorative surface intact.



7. Position the groove side of the repair plank over the tongue of the adjoining plank and apply CoreWeld on to the groove of the opposite adjoining plank. Lay the prepared replacement plank onto adjoining groove.



8. Apply a generous amount of CoreWeld around all edges of the repaired area and weight the replacement plank for several minutes to assure a good weld.

## Installation Accessories

### Mannington Adhesives & Sealers

Using the proper installation accessories for a job not only reduces the chance of installation failure, but also adds to the integrity and life of a floor. We have specially engineered each of our products to meet the needs of the appropriate Mannington floor covering to produce optimum end results. We constantly strive to improve all of our products. Regular product enhancements increase the level of performance and ease of use for the installer, but we always stress the importance of adhering to all proper installation procedures.

The following products are available from your local Mannington Distributor and retailer. Follow all directions on each product's packaging and the information contained in this handbook. If you have any questions regarding a product, contact your local Mannington Distributor, Mannington Regional Installation Specialist, or call Mannington's Installation Services Specialist for assistance at 800-FLOOR-US.



**NOTE: Material Safety Data Sheets are available from your Mannington Distributor and Mannington's Customer Care Department at 1-800-FLOOR-US (800-356-6787).**

Product	Adhesives	Seam Sealer	Applicator	Seam Method
Commercial - CustomSpec II®	V-81	MCS 42** (Pints)	VST-96	Double-Cut Dry
Commercial - Fine Fields®	V-81	MCS 42** (Pints) or Heat Welding	VST-96	Recess Scribe Wet
Commercial - BioSpec® (Homogeneous)	V-82* or V-95***	MCS 42** (Pints) or Heat Welding	VST-96	Recess Scribe Wet
Commercial - Magna®	V-81	MCS 42** (Pints) or Heat Welding	VST-96	Recess Scribe Wet
Commercial - Mannington Assurance II™ (Homogeneous)	V-82* or V-95	Topcoat of MLG-33 (w/V-85) or Heat Welding	VST-96 w/Fin-Up	Recess Scribe Wet
Commercial - LifeLines II™ (Homogeneous)	V-82* or V-95	MCS 42** (Pints) or Heat Welding	VST-96	Recess Scribe Wet
Commercial - Insight™	V-81	MCS 42** (Pints)	VST-96	Double-Cut Dry
Commercial - VCT	M-Guard V-11	n/a	n/a	n/a
Commercial - Relay RE	V-82 or V-95	MLG 33** (Pints) or Heat Welding	VST-96	Recess Scribe Wet
Commercial - Realities	V-82 or V-95	MCS 42** (Pints) or Heat Welding	VST-96	Recess Scribe Wet
Commercial - Natures Paths	V-82 or V-95	MLG ##	n/a	n/a

\*V-82 should be used when installing over porous substrates only.

\*\*Replaces MCS 32.

\*\*\*Replaces V-85

## Installation Accessories (continued)

### M-Guard V-11 Adhesive – moisture-resistant clear thin-spread adhesive

#### Description:

M-Guard V-11 is a premium moisture-resistant pressure-sensitive adhesive developed specifically for installing Mannington Vinyl Composition Tile (VCT) and Premium Tile PT over approved substrates.

Intended Use: M-Guard V-11 may be used on concrete or approved and appropriately constructed wood or wood composition subfloors/underlayments.

M-Guard V-11 is suitable for use over new concrete substrates with in-situ moisture measurements of 85% RH as measured by ASTM F2170 or moisture vapor emission rate (MVER) of up to 8 lbs (3.6Kg) per ASTM F 1869, and a pH below 11.

(M-Guard V-11 is not designed to be used over floors with moisture vapor emissions (MVE) from water of intrusion or hydrostatic pressure. It is designed only for slabs with high vapor emission from water of hydration.) All concrete slabs on or below grade must have a functioning vapor barrier directly under the concrete slab.

#### Product and Packaging Information

Order Code	849896	849895
Description	5 Gal. Pail	1 Gal. Pail 4/Ctn
Color	Beige Paste	
Unit Weight	50 lbs.	40 lbs.
Pails/Pallet	36 Pails	36 Cases
Pallet Weight	1,850 lbs.	1,475 lbs.
Pallet Dimensions	42" x 48"	42" x 48"
Pallet Height	48"	36"
Back	F	F
Quality	1	1

#### Environmental:

M-Guard V-11 is CRI Green Label Plus Certified (Cert# GLP 7501); Meets VOC content limit of SCAMD Rule #1168; meets CHPS requirement CA 01351: is non-flammable and has anti-microbial protection.



#### Proper Storage:

Store in climate controlled interior locations. Keep container closed when not in use. Store at 60-95°F (15-35°C) and out of the sun. Use adequate ventilation to avoid breathing vapors when cover is removed. Shelf life is one year in un-open containers. M-Guard V-11 is freeze thaw stable.

#### Warranty:

Mannington Mills, Inc. warrants M-Guard V-11 Adhesive

#### Bond:

Mannington hereby warrants that their M-Guard V-11 Adhesive will provide suitable adhesive bond when installed over surfaces with moisture vapor emissions of up to 8 pounds per ASTM F1869 or 85% R.H. per ASTM F2170.

#### Special considerations:

Coverage with a 1/16" X 1/32" X 1/32" trowel is 200 -250 sq ft per gallon



### V-81 Commercial Premium Latex Adhesive

#### Description:

V-81 is a premium latex adhesive developed specifically for use with Mannington commercial-grade Resilient sheet products having a felt backing. V-81 is nonflammable, light-colored, and provides a strong moisture- and alkali-resistant bond. You may use it over all approved suspended wood underlayments and on-, above-, or below-grade concrete substrates.

#### Features:

- Easy application
- VOC-compliant/solvent-free/low odor
- Non-flammable
- Moisture- and alkali-resistant
- Readily identifiable mylar chips
- Contains fungicide protection
- Complies with SCAQMD Rule 1168

#### Directions:

Make sure the underfloor is clean and free of all foreign matter such as dirt, paint, oil, wax, etc. It should be smooth and level. Sand off high spots and fill low spots, cracks, holes, etc., with the appropriate Mannington patching compound.

#### Porous Substrate



Maintain the adhesive, floor covering, and job site at a temperature of at least 65°F for a minimum of 48 hours before and after the installation and while installing.

#### Nonporous Substrate



On porous underfloors, apply the adhesive with a trowel having notches 1/16" wide, 1/16" deep, spaced 1/16" apart.

On nonporous underfloors, apply a thinner spread of adhesive using a trowel with notches 1/16" wide, 1/32" deep, spaced 1/32" apart.

Provide adhesive open time but do not allow the adhesive to "skin over" before laying the floor covering into the adhesive.



## Installation Accessories (continued)

Immediately roll the adhered material in both directions using a 100-lb, three-section floor roller.

You can clean fresh adhesive smears with water. Remove dried adhesive with mineral spirits.

Avoid heavy traffic on the finished floor for at least 24 hours.

### Coverage:

Approximately 135 to 180 sq ft per gallon

### Packaging:

1-Gallon Pail #849846 (4 per carton)  
9.2 lbs (4.17 kg)

4-Gallon Pail #849845  
41.4 lbs (18.78 kg)

### Precautions:

- Do not use with Perimiflex or any other vinyl-backed materials.
- Do not use where **excessive** moisture, alkali, or hydrostatic pressure exists.
- Use with adequate ventilation.
- Avoid contact with eyes.
- Do not ingest.
- KEEP OUT OF THE REACH OF CHILDREN.

## V-82 Adhesive

### Description:

V-82 is a nonflammable, solvent-free, light-colored acrylic adhesive that provides good moisture and alkali resistance, and a strong bond for Mannington's Commercial homogeneous vinyl-backed products. Use over approved suspended wood floors and for on-, above-, or below-grade concrete.

### Features:

- Easy application
- VOC-compliant/solvent-free/low odor
- Non-flammable
- Moisture- and alkali-resistant
- Readily identifiable mylar chips
- Contains fungicide protection
- Complies with SCAQMD Rule 1168

### Directions:

Make sure the underfloor is clean and free of all foreign matter such as dirt, paint, oil, wax, etc. It should be smooth and level. Sand off high spots and fill low spots, cracks, holes, etc., with the appropriate Mannington patching compound.

Maintain the adhesive, floor covering, and job site at a temperature of at least 65°F for a minimum of 48 hours before and after the installation and while installing.

V-82 adhesive should be applied with a trowel having notches  $\frac{1}{16}$ " wide,  $\frac{1}{32}$ " deep, spaced  $\frac{1}{32}$ " apart.

The adhesive must be spread over 100% of the exposed subfloor, leaving no gaps or puddles. Uniform coverage can be maintained by keeping the trowel clean and properly notched.

Provide adhesive open time but do not allow the adhesive to "skin over" before laying the floor covering into the adhesive. V-82 has a 30-minute working time after spread.

After the adhesive has been applied, roll the sheet forward into the adhesive to eliminate trapping air. Do not drop or flop the material into the adhesive. Roll the floor covering with



a three-section, 160 lb floor roller in both directions.

Fresh adhesive smears can be cleaned with water. Remove dried adhesive with mineral spirits or painter's naphtha. (Caution: mineral spirits and naphtha are flammable.)

Avoid heavy traffic on the finished floor for at least 24 hours.

**!** Caution: All nonporous substrates must be rendered porous by applying an overlay of a cementitious product before applying V-82.

### Coverage:

Approximately 150 - 200 sq ft per gallon

### Packaging:

4-Gallon Pail #849882  
46.4 lbs (21.05 kg)

### Precautions:

- Use with adequate ventilation.
- Do not use where **excessive** moisture, alkali, or hydrostatic pressure exists.
- Avoid prolonged breathing of vapor and skin contact.
- Do not ingest.
- Avoid contact with eyes.
- KEEP OUT OF THE REACH OF CHILDREN.

## Installation Accessories (continued)

### V-95 Adhesive

#### Description:

V-95 is a solvent-free, two-component, epoxy adhesive for high-performance indoor installations of Mannington Commercial BioSpec, LifeLines, and Mannington Assurance II resilient sheet and modular flooring products. V-95 has good resistance to humidity, water, weather, and heat, as well as outstanding adhesion and elasticity at low temperatures. You may use V-95 on all approved wood underlayments and on-, above-, or below-grade fully cured concrete substrates.

V-95 must also be used when installing Mannington Commercial BioSpec, LifeLines, Mannington Assurance II slip-retardant flooring, Relay RE, Realities, Primus and Assurance II Modular over nonporous substrates or in areas subject to standing water, topical moisture, or where heavy rolling loads are expected (i.e. under hospital beds, entryways, around floor drains, spas, saunas, or on ramps).

#### Features:

- Easy application
- VOC-compliant/solvent-free/low odor
- Non-flammable
- Moisture- and alkali-resistant
- Readily identifiable mylar chips
- Contains fungicide protection
- Complies with SCAQMD Rule 1168

#### Directions:

Make sure the underfloor is clean and free of all foreign matter such as dirt, paint, oil, wax, etc. It should be smooth and level. Sand off high spots and fill low spots, cracks, holes, etc., with the appropriate Mannington patching compound.

Maintain the adhesive, floor covering, and job site at a minimum temperature of 65°F and a maximum temperature of 100°F for at least 48 hours before and after the installation and while installing.

Pour all of the "Part B" bottle into the pail containing "Part A" while slowly mixing with

a low-speed drill mixer (300 RPM or less), until a smooth consistency is obtained.

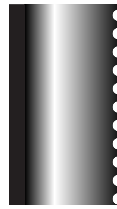

V-95 adhesive should be applied with a trowel having notches  $\frac{1}{16}$ " wide,  $\frac{1}{32}$ " deep, spaced  $\frac{1}{32}$ " apart.

The adhesive must be spread over 100% of the exposed subfloor, leaving no gaps or puddles. Uniform coverage can be maintained by keeping the trowel clean and properly notched. Do not spread more adhesive than can be covered within 20 - 25 minutes.

 **NOTE: The floor temperature directly affects the setting time. The warmer it gets the faster the adhesive sets.**

Install the flooring material into the adhesive while still fresh. Proper adhesive transfer to the backing should be confirmed periodically by lifting the material. Roll the floor covering across the width and length with a 100-lb, three-section floor roller to break down adhesive ridges and ensure removal of trapped air. Wait one to two hours and then repeat the rolling procedure to ensure complete removal of all trapped air.

 **NOTE: The instant grab of V-95 is low, so it is sometimes required to apply weights, particularly on the seams, to maintain contact until the adhesive sets (16 - 24 hours).**

The material should be ready for light traffic in 12 hours, regular traffic in 24 hours. If you must walk on the floor before this time, lay plywood boards across the material to disperse the load. Wait at least 72 hours before allowing heavy traffic on the floor.

 **CAUTION: It is impossible to remove V-95 once it is dry. You can remove fresh adhesive with mineral spirits.**

#### Coverage:

Approximately 185 - 245 sq ft per gallon

#### Packaging:

1-Gallon Pail #800291  
(one 2-part pkg. per ctn.)  
Approximately 11.8 lbs (5.35 kg)

#### Precautions:

- Use with adequate ventilation.
- Do not use where **excessive** moisture, alkali, or hydrostatic pressure exists.
- Do not apply directly over gypsum-based surfaces.
- Avoid prolonged breathing of vapor and skin contact.
- Do not ingest.
- Avoid contact with eyes.
- **KEEP OUT OF THE REACH OF CHILDREN.**

## Installation Accessories (continued)

### M-Guard V-68 Ultra Premium Commercial Adhesive

For use with Mannington Commercial Homogenous and Heterogeneous vinyl back sheet products and Luxury Vinyl Tile (LVT) and Luxury Vinyl Plank (LVP) products

- Warranted over concrete slabs with up to 8 pounds moisture vapor emissions
- Contains antimicrobial protection
- High solids
- Excellent water and alkali resistance
- Solvent free – low odor

#### Description

Mannington Commercial V-68 Adhesive is an ultra premium, high moisture resistant adhesive. This product was specially developed for the installation of a broad range of Mannington Commercial vinyl back products over most porous substrates. Mannington Commercial V-68 is recommended for use over concrete slabs with vapor emission rates of up to eight pounds per ASTM F1869, or insitu relative humidity readings of up to 80% per ASTM F2170 without any further moisture vapor remediation. Mannington Commercial V-68 is formulated with a pro-prietary blend of biocides that help protect the adhesive from the growth of mold, mildew, and bacteria in both the wet and dry state.

Mannington Commercial V-68 is not designed to be used over floors with Moisture Vapor Emissions (MVE) from water of intrusion or hydrostatic pressure. It is designed for slabs with high vapor emission from the water of hydration.

#### Technical Data:

- **FREEZE-THAW STABILITY:** Stable above +10°F or 12.2°C up to 5 cycles. Protect from freezing.
- **DO NOT STORE OUTDOORS.** If frozen thaw completely at room temperature. Determine suitability of the adhesive before attempting to complete the installation. Excess alkalinity before applying adhesive and floor covering. If moisture vapor emission rates are higher than eight pounds, or insitu R.H. is over 80% additional time must be provided to allow the moisture to escape. If the pH is higher than 10.0, it must be neutralized by rinsing with a mild solution of muriatic acid

and then the slab must be rinsed thoroughly and retested after 24 hours to verify suitability. Do not install floor covering over concrete surfaces that exceed these recommended limits.

- **Cleanup:** Excess fresh adhesive should be removed immediately with soapy water and a damp cloth. If the adhesive dries, a white cotton cloth dampened with a mineral spirits.
- **Product Specification Sheets** M-Guard V-68 Ultra Premium Commercial Adhesive
- **Shelf Life:** Minimum 1 yr. at 70°F
- **Tach Time:** use wet installation method
- **Color:** White
- **Packaging:** 4 Gallon Pails
- **Limitations:** Do not expose newly covered floors to heavy traffic for 72 hrs.

#### Use Over:

Porous substrates including plywood or wood composition panels, patching and self-leveling compounds, cement terrazzo that has been made porous by grinding, and concrete (on, above and below grade in the absence of excess (greater than 8 lbs MVER) moisture. All sealed or nonporous concrete must be made porous by grinding or sanding, before the application of the adhesive. Mannington Commercial V-68 is not recommended over non-porous substrates. Check concrete slabs for porosity by placing dime to quarter size drops of water in several locations throughout the slab, if the water begins to soak into the concrete within 30 minutes your slab is porous enough for floor covering installation with Mannington Commercial V-68 Apply adhesive, roll immediately with short nap roller, and lay floor covering immediately into adhesive. Do not let the adhesive skin over. Roll with a 100 pound roller to ensure a good bond. All concrete slabs on, or below grade must have a functioning vapor barrier directly under the concrete slab. The vapor barrier must always be on top of the capillary break. (All concrete slabs must be thoroughly cured and free of curing agents, excessive alkali and moisture, etc.)

#### Moisture Test:

Perform testing for moisture vapor emissions per the anhydrous calcium chloride test method ASTM F1869, or use the Insitu Relative Humidity test method ASTM F2170.

Also test for excess alkalinity before applying adhesive and floor covering. If moisture vapor emission rates are higher than eight pounds, or insitu R.H. is over 80% additional time must be provided to allow the moisture to escape. If the pH is higher than 10.0, it must be neutralized by rinsing with a mild solution of muriatic acid and then the slab must be rinsed thoroughly and retested after 24 hours to verify suitability. Do not install floor covering over concrete surfaces that exceed these recommended limits.

#### Cleanup:

Excess fresh adhesive should be removed immediately with soapy water and a damp cloth. If the adhesive dries, a white cotton cloth dampened with a mineral spirits.

#### RECOMMENDED TROWEL AND APPROXIMATE COVERAGE:



Short 3/16" nap roller is to be applied to smooth the adhesive immediately after it has been applied with the proper trowel to provide a uniform adhesive film. (Pre-wet the roller with adhesive before rolling begins)

1/16 x 1/32 x 1/32

Up to 200 square feet per gallon

Over prepped nonporous surfaces. Prepped nonporous surfaces are rendered porous by means such as grinding.

1/16 x 1/16 x 1/16

Up to 150 square feet per gallon

Over porous surfaces.

#### CAUTION:

Use adequate ventilation. Avoid prolonged breathing of vapors. After using, be sure to wash your hands thoroughly, particularly before eating. May cause skin and eye irritation. Avoid contact with skin and eyes. Keep container closed. Thoroughly wash exposed area with soap and water. Eyes: flush with large amounts of water, lifting upper and lower lids occasionally; call a physician immediately. Ingestion: Do not induce vomiting. Call a physician immediately. KEEP OUT OF REACH OF CHILDREN. [Refer to Material Safety Data Sheet (MSDS) for further information.]

## Installation Accessories (continued)

### Directions

Preparation: For proper results when installing floor coverings with Mannington Commercial V-68 always climatize the adhesive, floor covering, and installation area. At a minimum, store the adhesive, and the floor covering at the job site for at least 48 hours with the job site environment at a minimum of 65°F and maximum 100° F, and a relative humidity of between 45% and 65%.

Area to be covered must be clean, sound, dry and free of any foreign matter that would interfere with a solid bond. Level any high spots, and fill all cracks, holes and minor depressions with a suitable underlayment or floor patch, otherwise irregularities can “telegraph” through the new surface.

### Application:

Mannington Commercial V-68 has been specially formulated to act as both an ultra premium resilient flooring adhesive, and also to function as a moisture vapor emissions retarder. This adhesive can be used over concrete slabs with up to 8 pounds of MVE per ASTM F1869 or up to 80% R.H. per ASTM test method F2170 without any further moisture vapor remediation. Mannington Commercial V-68 is a firm setting, wet-install, acrylic based adhesive that is an excellent choice for all types of vinyl back resilient floor covering products.

Install flooring products into the Mannington Commercial V-68 while it is still wet, do not allow adhesive to skin over. All substrates must exhibit some amount of porosity, with the ability to absorb water topically, otherwise the adhesive will not set-up and cure. Mannington Commercial V-68 acts as an adhesive as well as a MVE reducer, therefore all applications require the adhesive to be troweled on the substrate, and then immediately rolled with a short (3/16”) nap paint roller, (pre-wet the roller with adhesive before rolling begins). The trowel acts as a meter to ensure the proper amount of adhesive is used, and the roller spreads the adhesive to make a consistent film over the surface of the substrate.

Once the adhesive is nap rolled, lay floor covering into the wet adhesive immediately, this will ensure good transfer. Do not let the adhesive skin over. Then roll the entire floor with a 100 pound three-section floor roller. Roll the floor while the adhesive is still soft and wet underneath the flooring this will ensure good bonding. Seal seams where appropriate, and restrict to light traffic for 24 hours. Restrict from heavy traffic for 72 hours. If seam contamination occurs, extend open time or reduce trowel size.

### WARNING!

Do not sand, scrape, abrade, chip, pulverize, or demolish existing resilient tile, sheet flooring, backing, lining felt, adhesive, or adhesive residue. These products may contain asbestos fibers that are not readily identifiable. Avoid creating dust. Inhalation of asbestos dust may cause asbestosis or other serious bodily harm. If old floors must be removed, consult and follow the recommended work practices of the resilient flooring manufacturers.

### Warranty:

Mannington warrants the adhesive against manufacturing defects as follows:

**BOND** – Mannington hereby warrants that Mannington Commercial V-68 adhesive will provide suitable adhesive bond when installed over surfaces with moisture vapor emissions of up to 8 pounds per ASTM- 1869 or 80% RH per ASTM F-2170.

**CONDITIONS** – This warranty shall not be effective, unless the following conditions are satisfied. The bond created by Mannington Commercial V-68 adhesive is warranted to be free of defect in material and workmanship for 5 years on recommended Mannington Commercial sheet and 10 years on Mannington recommended Luxury Vinyl Tile from the initial installation date, provided:

1. The substrate is suitably prepared according to Mannington’s Installation Handbook.
2. Mannington Commercial V-68 adhesive is properly applied according to label and Mannington’s Installation Handbook.

3. Moisture testing must be done utilizing either ASTM F1869 (Calcium chloride) or ASTM F 2170 (%RH) prior to the floor covering being in-stalled.

4. Mannington Commercial V-68 must not be used on concrete slabs that do not have a vapor retardant membrane properly placed above the sand layer and next to the concrete.

5. Mannington Commercial V-68 must not be used on concrete slabs that have hydrostatic pressure or sources of moisture intrusion.

6. Alkalinity tests must also be performed. PH must not be greater than 10.0.

7. All tests have appropriate documentation available on request.

Please note that calcium chloride and alkalinity tests state only the condition of the floor at the time of the test. Test results are not indicative, nor do they predict, how environmental conditions may impact moisture or alkalinity in the future.

## Installation Accessories (continued)

### Low Gloss MLG 33 Urethane Sealer Kit

#### Description:

MLG 33 sealer (two-part seam sealer) is designed for Mannington products with low-gloss urethane-based wearlayers. A properly sealed seam will be as strong as the surface of the floor covering, and will remain intact for the life of the floor. The Versatile Sealing Tip (VST-96) is included in this kit.

#### Directions:

Prior to sealing, be certain all seams are clean, dry, and free of adhesive contamination.

Part B, which contains the de-glossing agent, must be shaken vigorously before blending with Part A.

Empty entire contents of Parts A and B into the supplied applicator bottle. After securing the VST tip to the applicator bottle, gently shake the bottle to mix the ingredients. After mixing, the bottle should stand until all trapped air bubbles have dispersed, typically 15 minutes.

Prior to use, check the flow of the sealer on a scrap piece of flooring.

Use the forefinger of one hand on top of the flat portion of the tip to guide and ensure proper fin penetration. Use the other hand to control sealer flow. Hold the bottle at approximately a 45° angle.

Lightly squeeze the bottle to apply a uniform bead of sealer approximately 1/8" wide centered on the seam cut.

**It is crucial that the seam sealer penetrate the full thickness of the seam cut to ensure a proper chemical weld.**

Allow the sealed seam to dry before traffic can be allowed on the floor. Do not walk on or move heavy furniture directly over the sealer until it is fully dry. We recommend 24 hours. Mark the seam by placing a scrap piece of flooring along each side of the seam.

MLG 33 **cannot** be saved for reuse. Safely discard any unused sealer.



#### Coverage:

One kit of MLG 33 will seal approximately 70 lineal feet of seams.

#### Packaging:

6 kits per carton #832233  
Carton weight 3 lbs (1.4 kg)

#### Precautions:

- Flammable liquid. Do not use near heat, sparks, pilot lights, fire, or other open flames.
- Do not ingest.
- Avoid contact with skin and eyes.
- Use in well-ventilated areas.
- Avoid prolonged breathing of vapors.
- Do not save for reuse.
- KEEP OUT OF THE REACH OF CHILDREN.

### MCS 42 Commercial Seam Sealer (replaces MCS 32)

#### Description:

MCS 42 is used to seal all seams in Mannington Commercial Resilient sheet flooring (except Mannington Assurance II and Realities). A properly sealed seam will be as strong as the surface of the floor covering and will remain intact for the life of the floor.

#### Directions:

Before sealing the seam, make certain all seams are clean, dry, and free of adhesive contamination.

Fill the VST-96 Professional Applicator bottle (sold separately) at least 2/3 full of sealer. Allow applicator bottle to stand until all air bubbles have dispersed. Before using, check the flow through the fin on a scrap piece of flooring.

Use the forefinger of one hand on the top flat portion of the tip to guide and ensure proper fin penetration. Use the other hand to control sealer flow. Hold the bottle at approximately a 45° angle.

When sealing seams in **CustomSpec II** and **Insight**, lightly squeeze the bottle and apply a uniform bead of sealer approximately 1/8" wide centered on the seam cut. *It is crucial that the seam sealer penetrate the full thickness of the seam cut to ensure a proper chemical weld. Do not wipe the sealer from the surface of Realities, Momentum, CustomSpec II or Insight.* Mark the seam by writing on scrap pieces of flooring placed on both sides of the seam.

When sealing seams in **Mannington Commercial inlaid products** (except Mannington Assurance II, see page 137 for chemical seam sealing techniques), insert the applicator tip into the seam cut making certain that the seam sealer is applied the full depth of the cut. Work in 5' to 6' sections at a time. Gently squeeze the bottle to start the flow of the sealer. Seam sealer flow will stop when hand pressure is removed. This allows you to leave the applicator inserted in the seam cut when you reposition yourself along the length of the seam. *It is crucial that*

## Installation Accessories (continued)

the seam sealer penetrate the full thickness of the seam cut to ensure a proper chemical weld. Allow the sealer to remain on the surface of the floor for about 30 - 40 seconds after application. Wipe the sealer from the surface of the inlaid product after each sectional application, with a clean white cloth dampened with mineral spirits.

Allow the sealed seam to dry at least one hour before permitting traffic on the floor. Avoid walking or moving furniture directly over the sealer until it is fully dry; 24 hours is recommended.

When sealing multiple seams, keep the applicator tip open by inserting the supplied cleaning wire.

After all seams are sealed, pour any unused sealer back into the pint can. Do not store seam sealer in the applicator bottle – it will harden.

### Coverage:

One pint of MCS 42 will seal approximately 400 - 600 lineal feet

### Packaging:

1-Pint Cans (12 per carton) #849842  
Carton weight 15 lbs (6.8 kg)

### Precautions:

- Flammable liquid. Do not use near heat, sparks, pilot lights, fire, or other open flames.
- Use with adequate ventilation.
- Avoid contact with skin and eyes.
- Avoid prolonged breathing of vapors.
- Keep the container tightly closed when not in use.
- KEEP OUT OF THE REACH OF CHILDREN.

## ST-96 Professional Applicator Kit

### Description:

The Professional Seam Sealer Applicator Kit contains a 4-oz. bottle, a tip cleaning pin, and the Versatile Sealing Tip (VST-96). The Kit is intended to be used with Mannington MLG 33 and MCS 42 seam sealers. (MLG 33 seam sealer kit contains the VST-96.) The ergonomic design and specially engineered tip help apply the appropriate amount of seam sealer while completely penetrating the seam cut for all Mannington Residential and Commercial Resilient sheet flooring applications. Prior to sealing seams in all products, make certain that all seams are clean, dry, and free of adhesive contamination.

### Packaging:

6 per carton #832204  
Carton weight 2 lbs (0.9 kg)



## Installation Accessories (continued)

### Patching & Leveling Compounds

#### MVP-2023

##### Description:

A fast-setting, polymer-modified, cement-based patching compound which, when mixed only with water, is used to level concrete and approved wood underlayment prior to the installation of a floor covering. Floor covering can be installed in just one hour after application.

##### Uses:

- For patching and filling cracks, holes, voids, and depressions in concrete and approved wood underlayment prior to the installation of floor coverings.
- When mixed with MVP-2023 Additive, it can be used as an embossing leveler over vinyl sheet goods, vinyl composition tile, cement terrazzo, and residual cutback surfaces.
- For repairing subfloors from featheredge to 1/2" (12.5 mm) thickness. If needed, MVP-2023 can be applied in two layers to exceed thicknesses greater than 1/2" (12.5 mm). **Note:** First layer must be completely dry.
- Offers a compatible bond with all floor covering adhesives when these adhesives are subsequently used for the installation of floor covering materials.
- For floors that require a high compressive strength patching compound. Will resist caster chair traffic.

##### Limitations:

- For interior use only.
- **Do not** apply over presswood, flakeboard, metal, or similar type substrates. Follow the floor covering manufacturer's recommendations regarding proper underlayment qualities.
- **Do not** apply directly over gypsum-based substrates.

- When applying a skim coat of MVP-2023 [less than 1/32" (0.8 mm)] over porous or very dry substrate, mix MVP-2023 with diluted MVP-2023 Additive to prevent premature dehydration (see mixing ratio in the technical data table).

- **Do not** use as a concrete resurfacing material when concrete surface is to be left exposed or unprotected.

- **Do not** use when the substrate temperature is below 50°F (10°C) or above 100°F (38°C).

##### Recommended Substrates:

##### MVP-2023 mixed with water or diluted MVP-2023 Additive (1 part in 3 equal parts of water):

- Fully cured concrete.
- Any wood underlayment that is recommended or guaranteed by either the wood manufacturer or the floor covering manufacturer, such as Exterior grade plywood, Group 1, CC type.

##### MVP-2023 mixed with MVP-2023 Additive (full strength)

- Properly prepared vinyl composition and vinyl asbestos tile or non-cushioned sheet goods (vinyl or urethane wear layers).
- Properly prepared cement terrazzo.
- Residual cutback adhesive.
- Ceramic tile.

##### Packaging:

Boxes: 4.4 lbs (2 kg); 10 lbs (4.5 kg);  
Pail: 40 lbs (18.1 kg)  
Bags: 25 lbs (11.3 kg); 50 lbs (22.7 kg)

##### Color:

Gray

##### Shelf Life:

Six months when stored in original container at room temperature 72°F (22°C) in a dry area.

##### Mixing Ratios:

##### MVP-2023 Additive System (MVP-2023 mixed with MVP-2023 Additive)

##### Full Strength Mixture:

Mix 2.5 parts MVP-2023 powder with one part MVP-2023 Additive liquid

##### Diluted Mixture:

Dilute MVP-2023 Additive liquid using one part MVP-2023 Additive with 3 parts water. Then, mix 2.5 parts MVP-2023 powder with one part diluted MVP-2023 Additive.

##### Thickness Recommendations:

MVP-2023 mixed with water:

Up to 1/2" (12.5 mm) per application

MVP-2023 mixed with MVP-2023 Additive:  
Diluted Mixture . . . . . Up to 1/4" (6 mm)  
(3 parts water/1 part MVP-2023 Additive)

Full Strength Mixture . . . Up to 1/8" (3.2 mm)

##### Approximate Coverage:

	Thickness	
	1/32" (0.8 mm)	1/16" (1.6 mm)
10 lbs (4.5 kg)	40 - 56 sq ft (3.7 - 5.2 m <sup>2</sup> )	20 - 28 sq ft (1.8 - 2.6 m <sup>2</sup> )
25 lbs (11.3 kg)	100 - 140 sq ft (9.3 - 13.0 m <sup>2</sup> )	50 - 70 sq ft (4.6 - 6.5 m <sup>2</sup> )

## Installation Accessories (continued)

### MVP-2023 Additive

#### Description:

An acrylic latex additive to be used with MVP-2023 for superior bond strength and to extend the pot life of the MVP-2023. This system is ideal for leveling non-cushioned embossed mineral fibrous felt-backed sheet goods with a vinyl or urethane wear layer, and non-cushioned embossed vinyl tiles. MVP-2023 Additive mixed full strength with MVP-2023 may also be used to skim-coat existing cutback adhesive residue prior to the direct glue-down installation of floor coverings.

#### Uses:

- For leveling non-cushioned embossed mineral fibrous felt-backed sheet goods that have a vinyl or urethane wear layer.
- For leveling non-cushioned embossed vinyl tile.
- For use as an underlayment over existing unglazed ceramic tile.
- For use as an underlayment over cutback adhesive residue.
- For use over cement terrazzo.
- To extend the pot life of the MVP-2023 mix up to 20-30 minutes.
- For thin application of MVP-2023 over very porous or dry concrete to eliminate the premature dehydration of the patching compounds.

#### Packaging:

Jug: 1 US gal. (3.7 L)

#### Color:

Milky white

#### Shelf Life:

12 months when stored in original container at room temperature in a heated area. Protect from freezing.

#### Approximate Coverage:

The coverage of MVP-2023 Additive depends on the usage of MVP-2023.



