

**Haworth prices in this book will increase on August 30, 2008 by 4%**

**Orlando**

**Product Offering**

The Orlando casegoods and tables product offering consists of the following:

Bookcases	Double Pedestal Desks	Single Pedestal Desks
Bridges	Lateral File	Tables
Corner Unit	Mobile Computer Table	Vertical Storage Units
Credenzas	Mobile Pedestal	Wardrobe/Storage Cabinets
D-Top Desk	Returns	

**Cable Management**

To help you route power cords and communication cables around and through Orlando casegoods, we have designed several features into the products. We also offer several accessory products to bring electrical power and data to the desk height and route cords and cables down and around the product.

Desks, returns, bridges and credenzas feature a continuous 1"(25mm) space between the modesty panel and the desk top to allow routing of cords and cables.

Vertical storage units feature a continuous 2"(51mm) space between the top of the back panel and the bottom of the cabinet. This allows for routing of the task light power cord behind the back panel, and it also functions as the attachment location for a tackboard or grid. Additional power cords and communications cables can be routed through two crescent-shaped cutouts in the bottom edge of the back panel on the Vertical Storage Unit. Returns, bridges, and kneespace credenzas feature modesties that are easily detached for power.

Another built-in cable routing feature is a cutout in the top corner of the pedestal and lateral file side panel within the kneewell. Used in conjunction with a field-installed grommet to route cords and cables from the desk top to the kneewell space of the casegood. For the convenience of desk-height power, a power and data dome (refer to Accessories pages) can be field installed into a 3" opening in any casegoods top. The black half-sphere provides four receptacle sites or two data and two power sites. The power dome's 15-amp plugs can be connected to a building electrical outlet or Haworth systems panel receptacle.

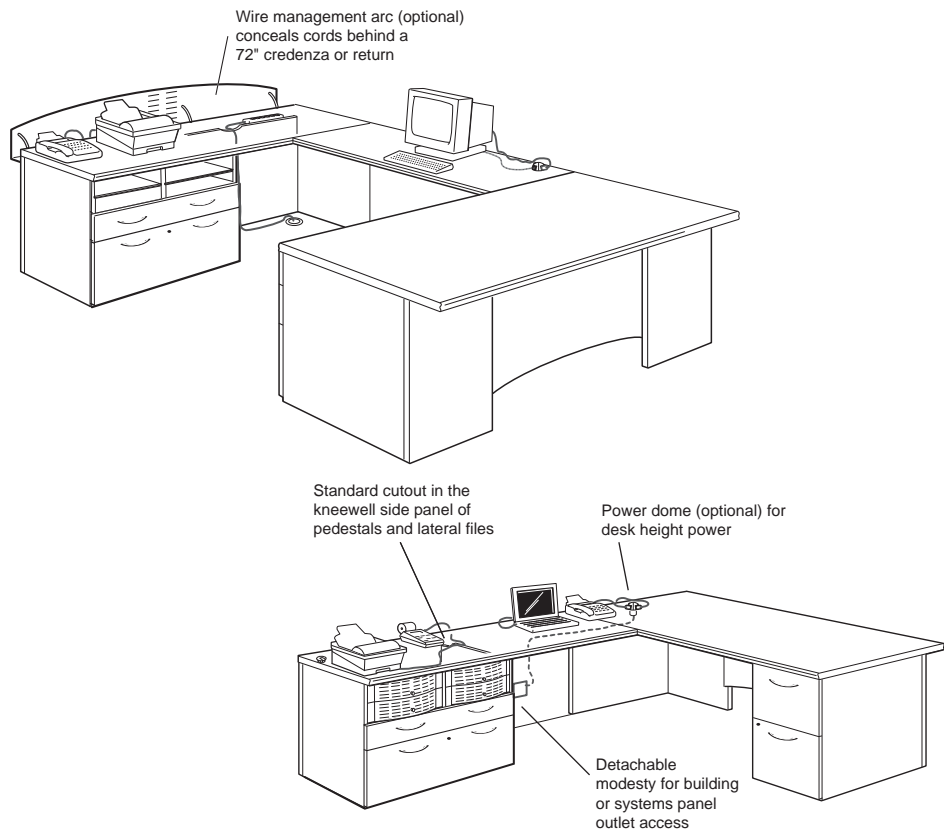

# Orlando

## Cable Management continued . . .

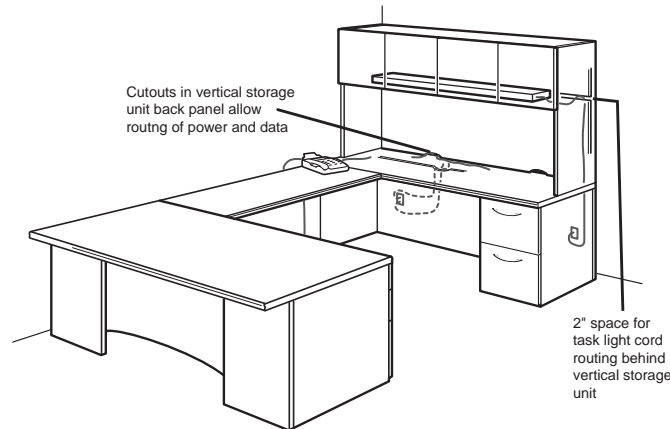

## Storage Capacities

Orlando offers several standard storage features as well as some unique storage options. All desk, return and credenza pedestal file (12") drawers offer full-extension interior drawer access to front-to-back letter filing or side-to-side legal filing. Box drawers (6") offer 3/4-extension interior drawer access.

Standard pedestal accessories include one pencil tray per pedestal in top 6" drawer, and one divider for every 6" box drawer.

Lateral file drawers are available in two heights, 6" and 12". Twelve inch drawers will accommodate front-to-back letter or legal filing or side-to-side legal filing. Each 12" lateral file drawer is provided with two front-to-back filing bars.

In addition to offering standard pedestals and two-drawer lateral files, a unique combination of open shelves and project drawers are available with the standard 6" high and 12" high file drawers. Desks offer the open storage shelf above a box/file pedestal option. Returns and credenzas offer two options; side-by-side open storage shelves with dividers above a 6"-high and 12"-high lateral file combination, and side-by-side double project drawers above a 6"-high and 12"-high lateral file combination.

### Pedestal Files — 15 7/8" (404mm) Width

#### SHALLOW DEPTH DRAWERS

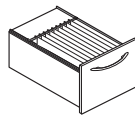

Letter / Legal - Side-to-Side  
12" (304mm)

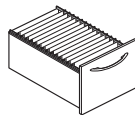

Letter - Front-to-Back  
16 3/4" (425mm)

#### DEEP DEPTH DRAWERS

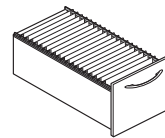

Letter - Front-to-Back  
26" (660mm)

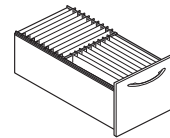

Legal - Side-to-Side  
12" (304mm)  
Letter - Front-to-Back  
9 3/4" (248mm)

### Lateral Files — 36" (914mm) Width

- Two adjustable bars are included to accommodate side/side letter filing.

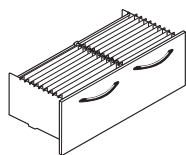

Letter / Legal - Front-to-Back  
16" (436mm)  
16" (436mm)

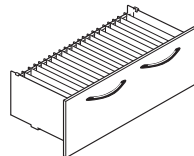

Letter / Legal - Side-to-Side  
32 3/4" (832mm)

**Storage Capacities continued . . .**

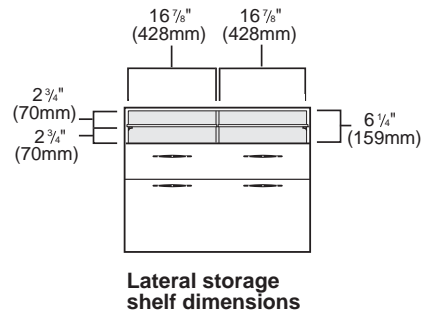
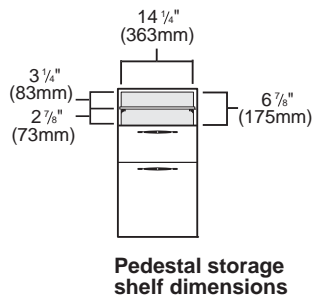

# Orlando

Technical Specifications		
Top Construction		1 1/4"(31mm) thick medium-density particle board core, wood veneer or laminate work surface and backer sheet, solid wood edges
Modesty panel		3/4"(19mm) medium-density particle board core with wood veneer surfaces
End Panel Construction		1 1/4"(31mm) thick medium-density particle board core with wood veneer surface
Drawer Front Construction		Pedestal box and file drawers: medium-density particle board core with wood veneer surface Lateral file drawers: particle board core with wood veneer surface Project drawers: Steel with powder coat finish
Drawer Box Construction		Modular/Steel: 3" project drawers are steel. 6"(152mm) letter box drawers are steel with spacers for dividers. 12"(305mm) drawers are steel.
Drawer/Door Pulls		Zinc die cast, black finish
Veneer		All exposed veneers are plain-sliced and book-matched; drawer fronts, per pedestal, are matched in sets for consistent grain and color. Beech is rift-cut. Anegre is quarter cut.
Finishing		The EcoShield™ finish uses water based stains and water based UV cured urethane top coat to provide a consistent, hard and durable surface. Wood pores are open to reflect the nature of each particular species. EcoShield is a low VOC, low formaldehyde emitting finish.

Because of the natural properties of wood, variations of grain pattern and finish color can be expected. Materials used in the manufacturing of products are carefully selected to promote consistent and acceptable color. Wood is susceptible to color change from long-term exposure to sunlight.

To keep your wood writing surfaces looking beautiful for the life of the product it is highly recommended that a blotter pad, glass or plexiglass surface be used under writing instruments.

Also, Orlando wood casegoods are available with select laminates for use on tops and writing surfaces.

## Edge/Drawer/Pull/Leg Detail

All Orlando worksurfaces feature a radiused solid wood edge on the user's and visitor's side of the top. The other two sides feature a square wood edge banding. Bumper and round tables feature the radiused edge except on the straight edge of the table which features the square wood edge banding.

Pedestal drawers, lateral file drawers and wardrobe/storage doors feature an easy-to-grab handle which meets ADA guidelines.



Edge Detail

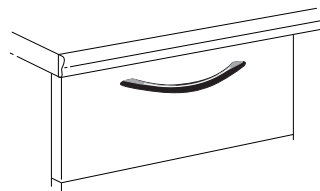

Drawer Pull

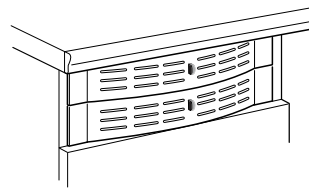

Project Drawer Pulls

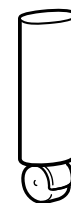

D-Top, Corner and Table Leg – Caster



D-Top, Corner and Table Leg – Glide

# Orlando

**General Specifications**

Orlando product specification numbers are based on an alpha-numeric logic that identifies a product by product line, size and certain characteristics.

For instance, a product number that reads **OCXL-2272-LR** identifies the product as an Orlando credenza with lateral storage, 22"(559mm) deep and 72"(1829mm) wide.

The alpha-numeric logic for this product complete with finish color code is shown below:

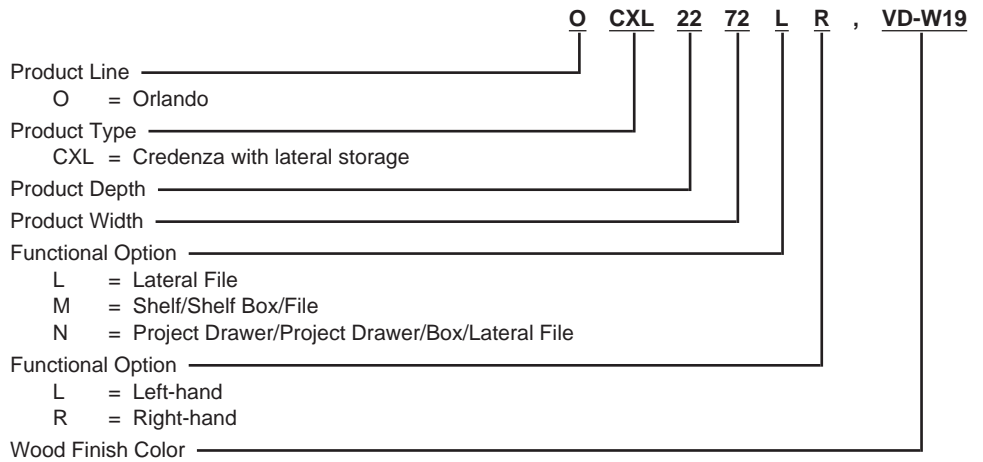

**Tag by Office**

Haworth requires that all items in the order be tagged with an individual office location. Items will be manufactured, labeled and shipped so that installers can easily identify items by office. Tagged offices will be keyed alike.

**Finishes**

A complete listing of finishes and fabrics for Orlando casegoods can be found on pages 339-343.

**Lock Programs**

Desks, returns and credenzas with pedestals, wardrobe/storage cabinets, and lateral files each feature one or more locks. Vertical storage units are available with or without locks.

All locks will have a black finish regardless of veneer type or wood finish color.

Refer to the current Lock Programs Specification Guidelines Price List for master keying and prices (not part of this pricebook).

## Orlando

	Height	Depth	Width	Number	① ②	Wood Finish Group			
						1	2	3	4
<b>Single Pedestal Desk, Overhang Top</b>	29 1/4"(745mm)	36"(914mm)	72"(1829mm)	ODOS-3672-	■ ■	\$2215	\$2332	\$2449	\$2612

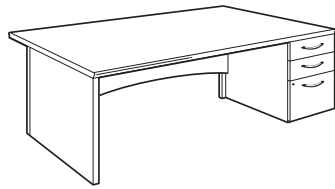

ODOS-3672-HR (Right-hand shown)

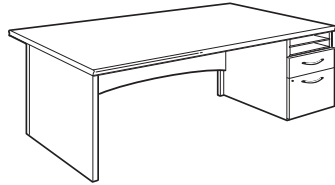

ODOS-3672-KR (Right-hand shown)

**Features**

- Pedestal configurations:
  - Box/box/file with lock or open storage shelf/box/file with lock.
- Recessed 3/4-height modesty panel with continuous wireway cutout.
- Desk top overhang is 6"(152mm).
- Accommodates these separately-specified accessories: center pencil drawer, grommet, power dome. See Accessories section.
- Drawer pulls are standard in black finish only.
- Kneespace clearance:
  - 28 1/8"(715mm)-high x 26 1/2"(673mm)-deep x 55"(1397mm)-wide.
- False pedestal back on side with no pedestal provides a double pedestal desk appearance from the approach side.
- Drawer interior is steel.
- Shelves use matching veneer.
- Desk shipped unassembled. Storage unit shipped assembled.
- Desks ordered as left- or right-hand cannot be field reconfigured to the opposite orientation.

■ Available on RUSH.

**To Order, Specify:**

1) Product number, including:

**① Storage Pedestal Option:**

**H** Box/Box/File ■

**K** Storage Shelf/Box/File, add \$63 list

**② Pedestal Orientation:**

**L** Left-hand

**R** Right-hand

2) Wood finish color.

3) Laminate surface color (if specified).

<b>Single Pedestal Desk, Flush Top</b>	29 1/4"(745mm)	30"(762mm)	66"(1676mm)	ODRS-3066-	■ ■	\$2114	\$2225	\$2336	\$2492
--	----------------	------------	-------------	------------	-----	--------	--------	--------	--------

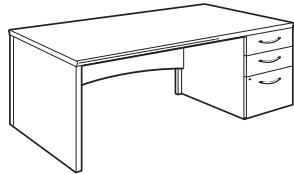

ODRS-3066-HR (Right-hand shown)

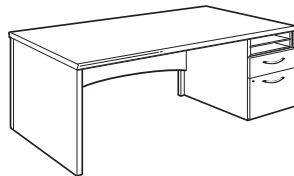

ODRS-3066-KR (Right-hand shown)

**Features**

- Pedestal configurations:
  - Box/box/file with lock or open storage shelf/box/file with lock.
- Recessed 3/4-height modesty panel with continuous wireway cutout.
- Accommodates these separately-specified accessories: center pencil drawer, grommet, power dome. See Accessories section.
- Drawer pulls are standard in black finish only.
- Kneespace clearance:
  - 28 1/8"(715mm)-high x 26 1/2"(673mm)-deep x 49"(1245mm)-wide.
- False pedestal back on side with no pedestal provides a double pedestal desk appearance from the approach side.
- Drawer interior is steel.
- Shelves use matching veneer.
- Desk shipped unassembled. Storage unit shipped assembled.
- Desks ordered as left- or right-hand cannot be field reconfigured to the opposite orientation.

**To Order, Specify:**

1) Product number, including:

**① Storage Pedestal Option:**

**H** Box/Box/File

**K** Storage Shelf/Box/File, add \$63 list

**② Pedestal Orientation:**

**L** Left-hand

**R** Right-hand

2) Wood finish color.

3) Laminate surface color (if specified).

<b>D-Top Desk</b>	29 1/4"(745mm)	36"(914mm)	72"(1829mm)	ORED-3672	■	\$2187	\$2301	\$2415	\$2577
-------------------	----------------	------------	-------------	-----------	---	--------	--------	--------	--------

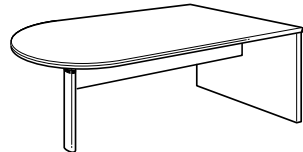

ORED-3672

**Features**

- Includes full-height end panel, 9"(229mm) high modesty panel and 3"(76mm) elliptical steel support leg.
- Attaches to a return or bridge only and cannot be specified as a freestanding desk.
- Support leg is standard in charcoal finish only.
- Kneespace clearance:
  - 28 1/8"(715mm)-high x 17 1/4"(438mm)-deep x 51 3/4"(1314mm)-wide.
- Shipped unassembled.

■ Available on RUSH.

**To Order, Specify:**

1) Product number.

2) Wood finish color.

3) Laminate surface color (if specified).

Orlando

	Height	Depth	Width	Number	Wood Finish Group			
					1	2	3	4
<b>Double Pedestal Desk, Overhang Top</b>	29 1/4"(745mm)	36"(914mm)	72"(1829mm)	ODOD-3672-	\$2540	\$2673	\$2806	\$2994

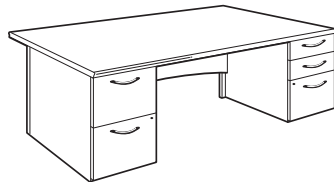

ODOD-3672-JH

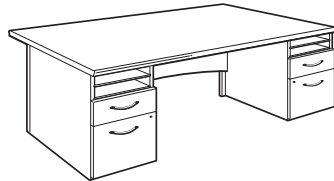

ODOD-3672-KK

**Features**

- Pedestal configurations:
  - File/file and box/box/file with two locks or open storage shelf/box/file on both sides with two locks.
- Recessed 3/4-height modesty panel with continuous wireway cutout.
- Desk top overhang is 6"(152mm).
- Accommodates these separately-specified accessories:
  - center pencil drawer, grommet, power dome. See Accessories section.
- Drawer pulls are standard in black finish only.
- Kneespace clearance:
  - 28 1/8"(715mm)-high x 26 1/2"(673mm)-deep x 40 3/8"(1026mm)-wide.
- Drawer interior is steel.
- Shelves use matching veneer.
- Desks shipped unassembled. Storage units shipped assembled.
- Available on RUSH.

**To Order, Specify:**

- 1) Product number, including:
  - ❶ **Pedestal Option:**
    - JH** File/File drawer pedestal, left and Box/Box/File drawer pedestal, right ■
    - KK** Shelf/Shelf/Box/File drawer pedestals left and right, add \$126 list
- 2) Wood finish color.
- 3) Laminate surface color (if specified).

<b>Double Pedestal Desk, Flush Top</b>	29 1/4"(745mm)	30"(762mm)	60"(1524mm)	ODRD-3060-	\$2275	\$2395	\$2515	\$2682
	29 1/4"(745mm)	30"(762mm)	66"(1676mm)	ODRD-3066-	2400	2527	2654	2830

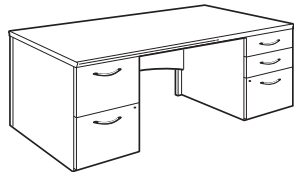

ODRD-3060-JH  
ODRD-3066-JH

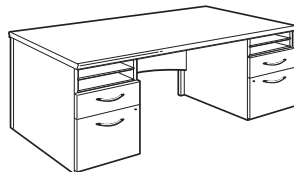

ODRD-3060-KK  
ODRD-3066-KK

**Features**

- Pedestal configurations:
  - File/file and box/box/file with two locks or open storage shelf/box/file on both sides with two locks.
- Recessed 3/4-height modesty panel with continuous wireway cutout.
- Accommodates these separately-specified accessories:
  - center pencil drawer, grommet, power dome. See Accessories section.
- Drawer pulls are standard in black finish only.
- Kneespace clearance:
  - 66"(1676mm) desk - 28 1/8"(715mm)-high x 26 1/2"(673mm)- deep x 34 3/8"(871mm)-wide.
  - 60"(1524mm) desk - 28 1/8"(719mm)-high x 26 1/2"(673mm)- deep x 28 3/8"(721mm)-wide.
- Shelves use matching veneer.
- Drawer interior is steel.
- Desks shipped unassembled. Storage units shipped assembled.

**To Order, Specify:**

- 1) Product number, including:
  - ❶ **Pedestal Option:**
    - JH** File/File drawer pedestal, left and Box/Box/File drawer pedestal, right
    - KK** Shelf/Shelf/Box/File drawer pedestals, left and right, add \$126 list
- 2) Wood finish color.
- 3) Laminate surface color (if specified).

# Orlando

	Height	Depth	Width	Number	Wood Finish Group			
					1	2	3	4

### Desk-Height Return with Lateral Storage

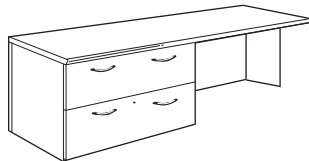

ORRL-2272-LLF  
(Left-hand shown)

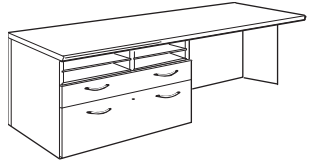

ORRL-2272-MLF  
(Left-hand shown)

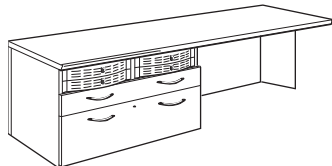

ORRL-2272-NLF  
(Left-hand shown)

29 1/4"(745mm)	22"(559mm)	72"(1829mm)	ORRL-2272-	■ ■ ■ F	\$2094	\$2201	\$2308	\$2458
----------------	------------	-------------	------------	---------	--------	--------	--------	--------

#### Features

- Lateral file configurations:
    - Two lateral files with lock, open storage shelves/6" lateral file/12" lateral file with lock, or project drawers/6" lateral file/12" lateral file with lock.
  - Attaches to a single pedestal desk or D-top desk.
  - Attachment hardware included.
  - Kneespace clearance:
    - 28 1/8"(715mm)-high x 20"(508mm)-deep x 35 5/8"(905mm)-wide.
  - Drawer pulls and project drawers are standard in black finish only.
  - Returns shipped unassembled. Storage unit shipped assembled.
  - Shelves use matching veneer.
  - Can accommodate a Vertical Storage Unit.
  - Returns ordered as left- or right-hand cannot be field reconfigured to the opposite orientation.
  - Return features a full modesty.
- Available on RUSH.

#### To Order, Specify:

1) Product number, including:

#### ① Lateral File Drawer Option:

- L** Lateral File
- M** Shelf/Shelf/Box/File, add \$191 list
- N** Project Drawer/Project Drawer/Box/Lateral file, add \$823 list ■

#### ② Desk Orientation:

- L** Left-hand
- R** Right-hand

2) Wood finish color.

3) Laminate surface color (if specified).

### Desk-Height Return with Pedestal Storage



ORRS-2248-JLF  
(Left-hand with modesty shown)



ORRS-2248-KLF  
(Left-hand with modesty shown)

	Height	Depth	Width	Number	Wood Finish Group			
					1	2	3	4

29 1/4"(745mm)	22"(559mm)	48"(1219mm)	ORRS-2248-	■ ■ ■ ■ ■	\$1667	\$1752	\$1837	\$1955
----------------	------------	-------------	------------	-----------	--------	--------	--------	--------

#### Features

- Pedestal configurations:
    - File/file with lock or open storage shelf/box/file with lock.
  - Attaches to a single pedestal desk or D-top desk.
  - Attachment hardware included.
  - Drawer pulls are standard in black finish only.
  - Kneespace clearance:
    - 28 1/8"(715mm)-high x 20"(508mm)-deep x 31 5/8"(804mm)- wide.
  - Shelves use matching veneer.
  - Returns shipped unassembled. Storage unit shipped assembled.
  - Returns ordered as left- or right-hand cannot be field reconfigured to the opposite orientation.
- Available on RUSH.

#### To Order, Specify:

1) Product number, including:

#### ① Pedestal Storage Option:

- J** File/file
- K** Shelf/Shelf/Box/File, add \$63 list

#### ② Desk Orientation:

- L** Left-hand
- R** Right-hand

#### ③ Modesty Panel Option:

- F** Full modesty, add \$63 list
- N** No modesty

2) Wood finish color.

3) Laminate surface color (if specified).

Orlando

	Height	Depth	Width	Number ①	Wood Finish Group			
					1	2	3	4
<b>Bridge</b>	29 1/4"(745mm)	22"(559mm)	36"(914mm)	OBR-2236- <input type="checkbox"/>	\$836	\$877	\$918	\$ 975
	29 1/4"(745mm)	22"(559mm)	48"(1219mm)	OBR-2248- <input checked="" type="checkbox"/>	897	942	984	1048

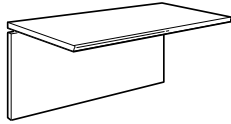

OBR-2236-F  
OBR-2248-F  
(With modesty panel)

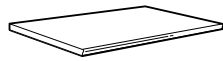

OBR-2236-N  
OBR-2248-N  
(Without modesty panel)

**Features**

- Attaches to a single pedestal desk or D-top desk and single pedestal credenza.
- Attachment hardware included.
- Kneespace clearance:  
–28 1/8"(715mm)-high x 20"(508mm)-deep.
- Shipped unassembled.
- Available on RUSH.

**To Order, Specify:**

- 1) Product number, including:
  - ① **Modesty Panel Option:**
    - F** Full modesty, add \$63 list ■
    - N** No modesty
- 2) Wood finish color.
- 3) Laminate surface color (if specified).

<b>Corner Unit without Modesty Panels</b>	29 1/4"(745mm)	22"(559mm)	36"(914mm)	OUC-2236- <input type="checkbox"/>	\$1679	\$1761	\$1843	\$1957
---	----------------	------------	------------	------------------------------------	--------	--------	--------	--------

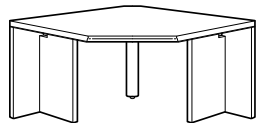

OUC-2236-N  
(Without modesty panel)

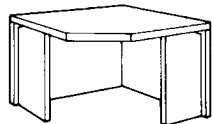

OUC-2236-F  
(With modesty panel)

**Features**

- Includes two full-height end panels.
- Corner unit without modesty panels includes 3"(76mm) elliptical steel support leg.
- Attaches to return, bridge or desk.
- Attachment hardware included.
- Elliptical steel support leg is standard in charcoal finish only.
- Kneespace clearance:  
–28 1/8"(715mm)-high x 18"(457mm)-deep x  
23 1/2"(597mm)-wide.
- Shipped unassembled.
- Not intended to support a vertical storage unit end panel or bookcase.

**To Order, Specify:**

- 1) Product number, including:
  - ① **Modesty Panel Option:**
    - F** Full modesty, add \$126 list
    - N** No modesty
- 2) Wood finish color.
- 3) Laminate surface color (if specified).

<b>Credenza with Asymmetrical Kneespace</b>	29 1/4"(745mm)	22"(559mm)	66"(1676mm)	OCXS-2266-J <input type="checkbox"/>	\$1472	\$1551	\$1626	\$1737
	29 1/4"(745mm)	22"(559mm)	72"(1829mm)	OCXS-2272-J <input checked="" type="checkbox"/>	1676	1764	1852	1976

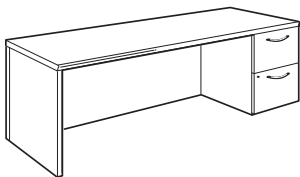

OCXS-2266-JR  
OCXS-2272-JR  
(Right-hand shown)

**Features**

- Pedestal configurations:  
–File/file with lock.
- Full-height back panel with continuous wireway cutout.
- Drawer pulls are standard in black finish only.
- Kneespace clearance:  
–66"(1676mm) credenza - 28 1/8"(715mm)-high x  
20"(508mm)-deep x 48 1/2"(1231mm)-wide.  
–72"(1829mm) credenza - 28 1/8"(715mm)-high x  
20"(508mm)-deep x 54 1/2"(1384mm)-wide.
- Credenza shipped unassembled. Storage unit shipped assembled.
- Drawer interior is steel.
- Credenzas ordered as left- or right-hand cannot be field reconfigured to the opposite orientation.
- Available on RUSH.

**To Order, Specify:**

- 1) Product number, including:
  - ① **Pedestal Orientation:**
    - L** Left-hand
    - R** Right-hand
- 2) Wood finish color.
- 3) Laminate surface color (if specified).

# Orlando

	Height	Depth	Width	Number <sup>①②</sup>	Wood Finish Group			
					1	2	3	4

<b>Credenza with Lateral Storage</b>	29 1/4"(745mm)	22"(559mm)	72"(1829mm)	OCXL-2272- <span style="background-color: #cccccc; border: 1px solid black; padding: 0 2px;"> </span> <span style="background-color: #cccccc; border: 1px solid black; padding: 0 2px;"> </span>	\$2155	\$2268	\$2382	\$2541
--------------------------------------	----------------	------------	-------------	--	--------	--------	--------	--------

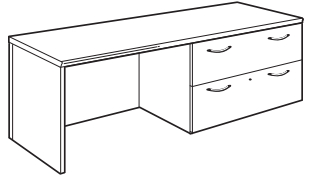

OCXL-2272-LR (Right-hand shown)

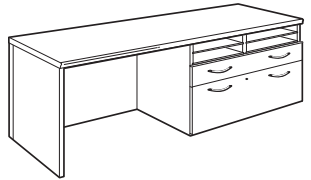

OCXL-2272-MR (Right-hand shown)

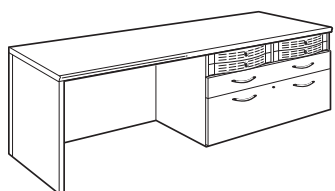

OCXL-2272-NR (Right-hand shown)

**Features**

- Lateral file configurations:
    - Two lateral files with lock, open storage shelves/6" lateral file/12" lateral file with lock, or project drawers/6" lateral file/12" lateral file with lock.
  - Full-height back panel with a continuous wireway cutout.
  - Drawer pulls and project drawers are standard in black finish only.
  - Kneespace clearance:
    - 28 1/8"(715mm)-high x 20"(508mm)-deep x 34 7/8"(885mm)- wide.
  - Credenza shipped unassembled. Storage unit shipped assembled.
  - Drawer interior is steel.
  - Credenzas ordered as left- or right-hand cannot be field reconfigured to the opposite orientation.
- Available on RUSH.

**To Order, Specify:**

- 1) Product number, including:
  - ① **Lateral File Drawer Option:**
    - L** Lateral file ■
    - M** Shelf/Shelf/Box/File, add \$191 list
    - N** Project Drawer/Project Drawer/Box/Lateral file, add \$823 list
  - ② **Lateral Storage Orientation:**
    - L** Left-hand
    - R** Right-hand
- 2) Wood finish color.
- 3) Laminate surface color (if specified).

<b>Credenza with Symmetrical Kneespace</b>	29 1/4"(745mm)	22"(559mm)	66"(1676mm)	OCSD-2266-JJ <span style="background-color: #cccccc; border: 1px solid black; padding: 0 2px;"> </span>	\$1969	\$2075	\$2176	\$2324
	29 1/4"(745mm)	22"(559mm)	72"(1829mm)	OCSD-2272-JJ <span style="background-color: #cccccc; border: 1px solid black; padding: 0 2px;"> </span> ■	2072	2181	2290	2443

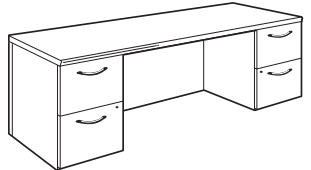

OCSD-2266-JJ  
OCSD-2272-JJ  
(With modesty panel)

**Features**

- Pedestal configuration:
    - Two file/file with locks.
  - Full-height back panel has a continuous wireway cutout.
  - Drawer pulls are standard in black finish only.
  - Kneespace clearance:
    - 66"(1676mm) credenza - 28 1/8"(715mm)-high x 20"(508mm)-deep x 33 3/8"(846mm)-wide.
    - 72"(1829mm) credenza - 28 1/8"(715mm)-high x 20"(508mm)-deep x 39 3/8"(999mm)-wide.
  - Credenza shipped unassembled. Storage unit shipped assembled.
  - Drawer interior is steel.
- Available on RUSH.

**To Order, Specify:**

- 1) Product number, including:
  - ① **Modesty Panel Option:**
    - F** Full modesty, add \$63 list ■
    - N** No modesty
- 2) Wood finish color.
- 3) Laminate surface color (if specified).

<b>Door/Drawer Credenza</b>	29 1/4"(745mm)	22"(559mm)	72"(1829mm)	OCFM-2272- <span style="background-color: #cccccc; border: 1px solid black; padding: 0 2px;"> </span>	\$3070	\$3232	\$3393	\$3620
-----------------------------	----------------	------------	-------------	---	--------	--------	--------	--------

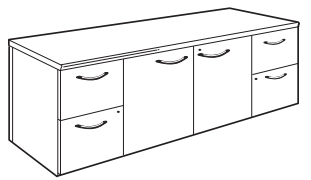

OCFM-2272-K  
(With lock)

**Features**

- Pedestal configuration:
    - Two file/file pedestals with locks and two-door center storage with lock option.
  - Center storage includes one adjustable shelf.
  - Drawer pulls are standard in black finish only.
  - Credenza shipped unassembled. Pedestals and center storage shipped assembled.
  - Drawer interior is steel.
  - Center Storage Cabinet interior dimensions:
    - Width: 18 7/8"(479mm)
    - Height: 25 5/8"(651mm)
    - Depth: 18 1/2"(472mm)
- Available on RUSH.

**To Order, Specify:**

- 1) Product number, including:
  - ① **Center Storage Lock Option:**
    - K** Lock, add \$100 list
    - N** No lock ■
- 2) Wood finish color.
- 3) Laminate surface color (if specified).

# Orlando

	Height	Depth	Width	Number ①	Wood Finish Group			
					1	2	3	4
<b>Four Door Vertical Storage Unit</b>	38 3/4"(980mm)	16 7/8"(429mm)	66"(1676mm)	OVF-3966- ■	\$2150	\$2262	\$2377	\$2534
	38 3/4"(980mm)	16 7/8"(429mm)	72"(1829mm)	OVF-3972- ■ ■	2274	2394	2513	2681

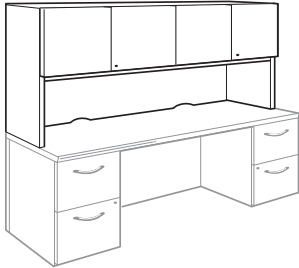

OVF-3966-K  
OVF-3972-K  
(With locks)

**Features**

- Attaches to a credenza, flush-top desk, or 72"(1829mm) return.
- 20 3/4"(527mm) clearance from credenza or desk top to underside of storage unit valence.
- Accepts separately-specified task lighting (see Accessories section), tackboard and grid.
- Lower shelf construction is wood.
- Features a 2"(51mm) continuous space under cabinet to accommodate task light power cord.
- Shipped assembled.
- Available on RUSH.

**To Order, Specify:**

1) Product number, including:

① **File Lock Option:**

**K** Locks, add \$200 list

**N** No lock ■

2) Wood finish color.

	Height	Depth	Width	Number ①	Wood Finish Group			
					1	2	3	4
<b>Vertical Storage Unit Open Center Storage</b>	38 3/4"(980mm)	16 7/8"(429mm)	72"(1829mm)	OVS-3972- ■	\$2111	\$2222	\$2333	\$2489

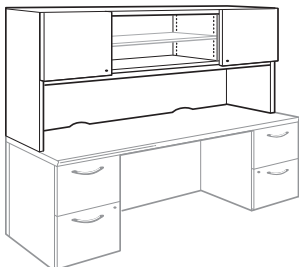

OVS-3972-K  
(With locks)

**Features**

- Attaches to a credenza, flush-top desk, or 72"(1829mm) return.
- 20 3/4"(527mm) clearance from credenza or desk top to underside of storage unit valence.
- Accepts separately-specified task lighting (see Accessories section), adjustable shelves, tackboard and grid.
- Features a 2"(51mm) continuous space under cabinet to accommodate task light power cord.
- Shipped assembled.
- Lower shelf construction is wood.
- Available on RUSH.

**To Order, Specify:**

1) Product number, including:

① **File Lock Option:**

**K** Locks, add \$200 list ■

**N** No lock

2) Wood finish color.

	Height	Depth	Width	Number ①②	Wood Finish Group			
					1	2	3	4
<b>Two Door Vertical Storage Unit</b>	38 3/4"(980mm)	16 7/8"(429mm)	72"(1829mm)	OVX-3972- ■ ■	\$2111	\$2222	\$2333	\$2489

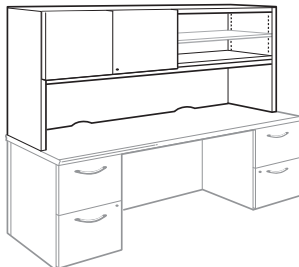

OVX-3972-KL (Left-hand shown)  
(With lock)

**Features**

- Attaches to a credenza, flush-top desk, or 72"(1829mm) return.
- 20 3/4"(1527mm) clearance from credenza or desk top to underside of storage unit valence.
- Accepts separately-specified task lighting (see Accessories section), adjustable shelves, tackboard and grid.
- Features a 2"(51mm) continuous space under cabinet to accommodate task light power cord.
- Shipped assembled.
- Lower shelf construction is wood.

**To Order, Specify:**

1) Product number, including:

① **File Lock Option:**

**K** Lock, add \$100 list

**N** No lock

② **Storage Orientation:**

**L** Left-hand

**R** Right-hand

2) Wood finish color.

## Orlando

	Height	Depth	Width	Description	Number	Price
<b>Adjustable Shelf</b>	13/16" (21mm)	14 1/2" (368mm)	35 1/4" (895mm)	For 72" open cabinet	OCAJ-35 ■	\$148

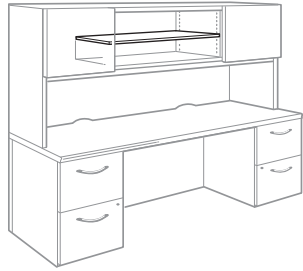

OCAJ-35

**Features**

- Mounts in pre-assigned adjustment holes.
- Mounting hardware included.
- Can only be used with Vertical Storage Unit Open Center Storage and Two Door Vertical Storage Unit.

■ Available on RUSH.

**To Order, Specify:**

- 1) Product number.
- 2) Wood finish color.

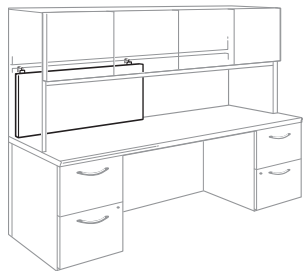
**Tackboard**OATB-2032  
OATB-2035

Height	Depth	Width	Description	Number	Fabric Grade						
					A	B	C	D	E	F	G
18 1/2" (472mm)	1 1/4" (32mm)	32" (816mm)	For 66" storage unit	OATB-2032 ■	\$148	\$156	\$166	\$170	\$177	\$184	\$189
		35" (892mm)	For 72" storage unit	OATB-2035 ■	154	163	173	177	184	195	197

**Features**

- Includes one tackboard and mounting hardware.
- Mounts on a vertical storage unit back panel.
- Each vertical storage unit will accept a maximum of two tackboards.
- COM yardage:
  - OATB-2032 – 1 yard
  - OATB-2035 – 1.5 yards

■ Available on RUSH.

**To Order, Specify:**

- 1) Product number.
- 2) Fabric surface and color.

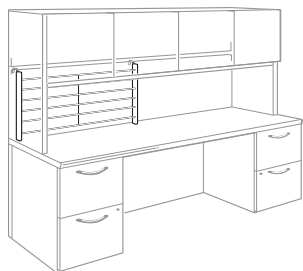
**Grid**OAHG-2032  
OAHG-2035

Height	Depth	Width	Description	Number	Price
20 1/2" (521mm)	1 1/4" (32mm)	31 7/8" (810mm)	For 66" storage unit	OAHG-2032	\$169
		34 7/8" (886mm)	For 72" storage unit	OAHG-2035 ■	169

**Features**

- Includes mounting hardware.
- Mounts on a vertical storage unit back panel.
- Each vertical storage unit will accept a maximum of two grids.
- Standard in charcoal finish color only.

■ Available on RUSH.

**To Order, Specify:**

- 1) Product number.  
(No finish specification required.)

# Orlando

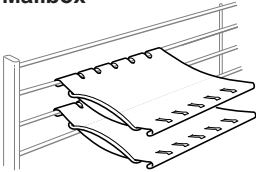
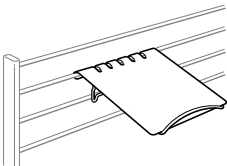
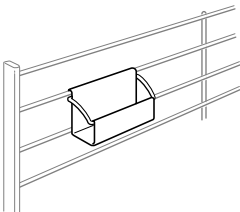
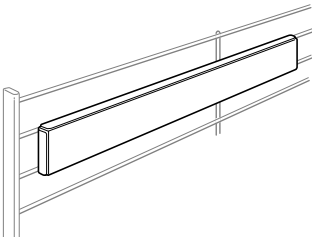
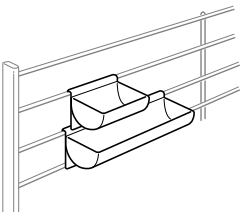
	Height	Depth	Width	Description	Number	Price
 <p>HGMB-0002 Class BA – SIN 711-1; Discount Group I</p>	12 1/2"(318mm)	10 3/4"(273mm)		Grid mounted	HGMB-0002	\$111
	<b>Features</b> <ul style="list-style-type: none"> <li>Includes two trays and support hardware.</li> <li>Provides convenient storage for paper documents.</li> <li>Available in grid mount.</li> <li>Shipped unassembled.</li> </ul>			<b>To Order, Specify:</b> <ol style="list-style-type: none"> <li>Product number.</li> <li>Trim color.</li> </ol>		
<p>◆ Available on RUSH.</p>						
 <p>HGRT-0001 Class BA – SIN 711-1; Discount Group IX, Grade IV</p>	10 3/4"(273mm)	13"(330mm)			HGRT-0001	\$108
	<b>Features</b> <ul style="list-style-type: none"> <li>Includes one tray and mounting hardware.</li> <li>Provides angled tray for holding open documents.</li> <li>Requires the support of a grid.</li> <li>Shipped unassembled.</li> </ul>			<b>To Order, Specify:</b> <ol style="list-style-type: none"> <li>Product number.</li> <li>Trim color.</li> </ol>		
<p>◆ Available on RUSH.</p>						
 <p>HGDB-0004 Class BA – SIN 711-1; Discount Group IX, Grade IV</p>	3 1/2"(89mm)	2 1/2"(64mm)	6"(152mm)		HGDB-0004	\$126
	<b>Features</b> <ul style="list-style-type: none"> <li>Includes four diskette bins.</li> <li>Provides open storage for up to (23) 5 1/4" diskettes or (10) 3 1/2" diskettes.</li> <li>Mounts on a grid or can be freestanding on desk top.</li> </ul>			<b>To Order, Specify:</b> <ol style="list-style-type: none"> <li>Product number.</li> <li>Trim color.</li> </ol>		
<p>◆ Available on RUSH.</p>						
 <p>HGTS-0024 HGTS-0030 Class BA – SIN 711-1; Discount Group IX, Grade IV</p>	3 1/2"(89mm)	1/4"(6mm)	24"(610mm)		HGTS-0024	\$273
			30"(762mm)		HGTS-0030	343
	<b>Features</b> <ul style="list-style-type: none"> <li>Includes four tackstrips.</li> <li>Provides mini-tackable cork surface.</li> <li>Mounts between two horizontal grid members.</li> </ul>			<b>To Order, Specify:</b> <ol style="list-style-type: none"> <li>Product number.</li> <li>Bracket trim color.</li> </ol>		
<p>◆ Available on RUSH.</p>						
 <p>HGBN-0004 HGBN-0008 (Both sizes shown) Class BA – SIN 711-1; Discount Group IX, Grade IV</p>	3 1/2"(89mm)	3"(76mm)	4"(102mm)		HGBN-0004	\$119
			8"(203mm)		HGBN-0008	151
	<b>Features</b> <ul style="list-style-type: none"> <li>Includes four storage bins of <b>one size</b>.</li> <li>Provides open storage for miscellaneous office supplies.</li> <li>Requires the support of a grid.</li> </ul>			<b>To Order, Specify:</b> <ol style="list-style-type: none"> <li>Product number.</li> <li>Trim color.</li> </ol>		
<p>◆ Available on RUSH.</p>						

## Orlando

	Height	Depth	Width	Number	Wood Finish Group			
					1	2	3	4
<b>Two-High Lateral File</b>	29 1/4"(745mm)	22"(559mm)	36"(914mm)	OSLF-2936 ■	\$1426	\$1502	\$1576	\$1682

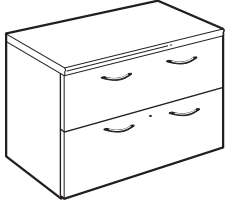

OSLF-2936

**Features**

- Two drawers with one front-mounted lock.
- Letter or legal lateral filing.
- Front-to-back filing bars provided.
- Anti-tilt mechanism.
- Drawer pulls are standard in black finish only.
- Shipped assembled.

■ Available on RUSH.

**To Order, Specify:**

- 1) Product number.
- 2) Wood finish color.
- 3) Laminate surface color (if specified).

<b>Lateral File Mounted Bookcase</b>	38 3/4"(980mm)	16"(405mm)	36"(914mm)	OSBF-3936 ■	\$1083	\$1137	\$1191	\$1273
--------------------------------------	----------------	------------	------------	-------------	--------	--------	--------	--------

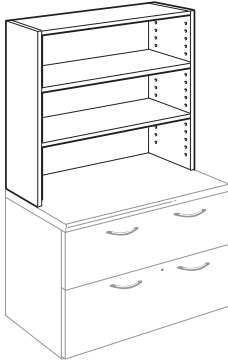

OSBF-3936

**Features**

- Includes two adjustable shelves.
- Attaches to a two-high lateral file.
- Attachment hardware included.
- Shipped assembled.

■ Available on RUSH.

**To Order, Specify:**

- 1) Product number.
- 2) Wood finish color.

<b>Three-High Bookcase</b>	38 7/8"(988mm)	16"(405mm)	36"(914mm)	OSBC-3936 ■	\$1093	\$1151	\$1207	\$1289
----------------------------	----------------	------------	------------	-------------	--------	--------	--------	--------



OSBC-3936

**Features**

- Includes two adjustable shelves.
- Shipped assembled.

■ Available on RUSH.

**To Order, Specify:**

- 1) Product number.
- 2) Wood finish color.

<b>Five-High Bookcase</b>	68"(1725mm)	16"(405mm)	36"(914mm)	OSBC-6836 ■	\$1388	\$1462	\$1534	\$1637
---------------------------	-------------	------------	------------	-------------	--------	--------	--------	--------

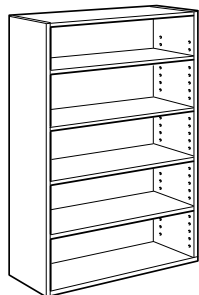

OSBC-6836

**Features**

- Includes four adjustable shelves.
- Shipped assembled.

■ Available on RUSH.

**To Order, Specify:**

- 1) Product number.
- 2) Wood finish color.

# Orlando

	Height	Depth	Width	Number	Wood Finish Group					
					1	2	3	4		
<b>Wardrobe/Storage Cabinet</b>	68"(1725mm)	22"(559mm)	24"(610mm)	OSWC-6824-	■	■	\$2973	\$3129	\$3286	\$3505

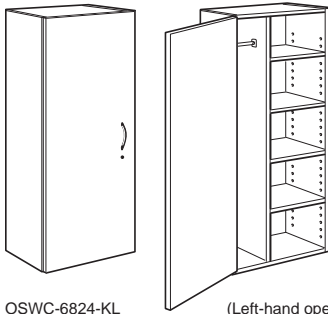

OSWC-6824-KL (Left-hand with lock, closed view)  
(Left-hand open view)

**Features**

- Storage configuration:  
–Full-height storage with four wood adjustable shelves and full-height wardrobe storage.
- Door pull is standard in black finish only.
- Shipped assembled.

**To Order, Specify:**

1) Product number, including:

**1 Door Lock Option:**

- K** Lock, add \$100 list
- N** No lock

**2 Door Swing Orientation:**

- L** Left-hand
- R** Right-hand

2) Wood finish color.

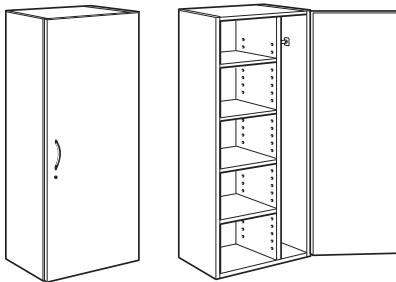

OSWC-6824-KR (Right-hand with lock, closed view)  
(Right-hand open view)

<b>Wardrobe/File Storage Cabinet</b>	68"(1725mm)	22"(559mm)	24"(610mm)	OSWF-6824-	■	■	\$3334	\$3510	\$3685	\$3932
--------------------------------------	-------------	------------	------------	------------	---	---	--------	--------	--------	--------

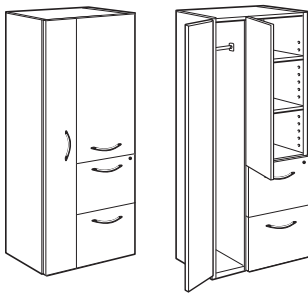

OSWF-6824-NL (Left-hand no lock, closed view)  
(Left-hand open view)

**Features**

- Standard storage configuration:  
–Lower file/file pedestal with lock, upper three-high storage with two wood adjustable shelves and full-height wardrobe storage.
- Drawer/door pulls are standard in black finish only.
- Shipped assembled.
- Available on RUSH.

**To Order, Specify:**

1) Product number, including:

**1 Door Lock Option:**

- K** Lock, add \$200 list
- N** No lock

**2 Door Swing Orientation:**

- L** Left-hand
- R** Right-hand

2) Wood finish color.

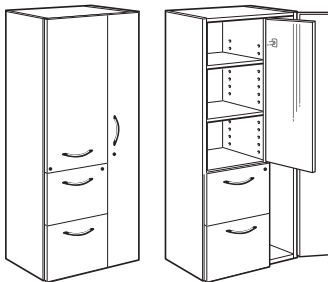

OSWF-6824-KR (Right-hand with lock, closed view)  
(Right-hand open view)

# Orlando

	Height	Depth	Width	Number	Wood Finish Group			
					1	2	3	4

**“Putter” Mobile Pedestal**

27 1/2”(701mm)	20”(508mm)	16”(406mm)	OPMQ-2216 ■	\$1355	\$1427	\$1497	\$1599
----------------	------------	------------	-------------	--------	--------	--------	--------



OPMQ-2216  
Class RA – SIN 711-8;  
Discount Group IX, Grade IV

**Features**

- Drawer configuration:
  - Open storage shelf/box/file with front-mounted lock.
- Casters are standard in charcoal finish only.
- Shelf interior dimensions:
  - Width: 14 1/4”(362mm)
  - Height: 3 1/4”(83mm)
  - Depth: 18”(457mm)
- Shipped assembled.
- Available on RUSH.

**To Order, Specify:**

- 1) Product number.
- 2) Wood finish color.

**“Tugger” Mobile Computer Table**

29 1/4”(745mm)	27”(686mm)	36”(914mm)	OBCT-2736	\$1031	\$1085	\$1140	\$1215
----------------	------------	------------	-----------	--------	--------	--------	--------

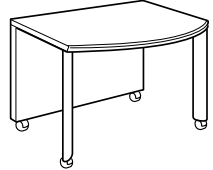

OBCT-2736  
Class RA – SIN 711-8; Discount Group IX, Grade IV

**Features**

- Includes four casters; two locking, two non-locking.
- Support legs and casters are standard in charcoal finish only.
- Kneespace clearance:
  - 28 1/8”(715mm)-high x 26 1/2” (673mm)-wide.
- Shipped unassembled.

**To Order, Specify:**

- 1) Product number.
- 2) Wood finish color.
- 3) Laminate surface color (if specified).

**“Bumper” Docking Table**

Height	Diameter	Flat Side	Number ①	Wood Finish Group			
				1	2	3	4
29 1/4”(745mm)	42”(1067mm)	30”(762mm)	OBBCD-4230-■	\$1529	\$1610	\$1690	\$1803
	48”(1219mm)	36”(914mm)	OBBCD-4836-■ ■	1683	1771	1860	1984

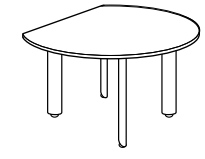

OBBCD-4230-G  
OBBCD-4836-G  
Class RA – SIN 711-9;  
Discount Group IX, Grade IV

**Features**

- Available with four glides or two locking and two non-locking casters.
- Table legs, glides and casters standard in charcoal finish only.
- Available on RUSH.

**To Order, Specify:**

- 1) Product number, including:
  - ① Leg Option:
    - C** Casters, add \$78 list ■
    - G** Glides
- 2) Wood finish color.
- 3) Laminate surface color (if specified).

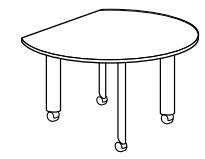

OBBCD-4230-C  
OBBCD-4836-C  
Class RA – SIN 711-9; Discount Group IX, Grade IV

**Round Table**

29 1/4”(745mm)	42”(1067mm)	OBCR-42-■	\$1590	\$1674	\$1758	\$1875
	48”(1219mm)	OBCR-48-■	1683	1771	1860	1984

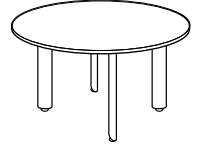

OBCR-42-G  
OBCR-48-G  
Class RA – SIN 711-9; Discount Group IX, Grade IV

**Features**

- Available with four glides or two locking and two non-locking casters.
- Table legs, glides and casters standard in charcoal finish only.

**To Order, Specify:**

- 1) Product number, including:
  - ① Leg Option:
    - C** Casters, add \$78 list
    - G** Glides
- 2) Wood finish color.
- 3) Laminate surface color (if specified).

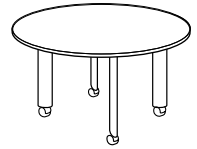

OBCR-42-C  
OBCR-48-C  
Class RA – SIN 711-9; Discount Group IX, Grade IV

# Orlando

	Height	Depth	Width	Number	Price
<b>Wire Management Arc</b>	12"(305mm)	4"(102mm)	66"(1676mm)	OWM-6612	\$369
			72"(1829mm)	OWM-7212	390

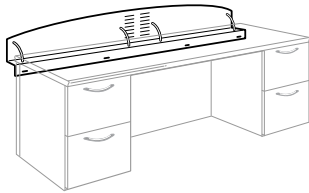

OWM-6612  
OWM-7212  
Class RA – SIN 711-8;  
Discount Group IX, Grade IV

**Features**

- Horizontal metal trough provides cable storage behind casegood.
- Mounts on the back side of a 66"(1676mm) or 72"(1829mm) wide return or credenza.
- Price includes mounting screws.
- Standard in charcoal finish only.

**To Order, Specify:**

- 1) Product number.  
(No finish specification required.)

**16 1/2" Pedestal Drawer Accessories**

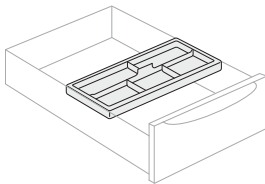

JPTA-6  
Class FP – SIN 711-3;  
Discount Group XII

Description	Number	Price
Pencil Tray	JPTA-6 ■	\$24
Dividers	JBDA-6 ■	23
CD Holder	JCDA-12 ■	21

**Features**

- Black trim color.
- Accessories for letter width modular box drawers.
- Available on RUSH.

**To Order, Specify:**

- 1) Product number.  
(No finish specification required.)

**Lateral File Accessories**

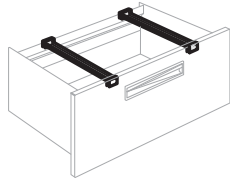

JFFA-15  
Class FM – SIN 711-3;  
Discount Group XII

Front-to-back hanging bars	JFFA-15 ■	\$24
Side-to-side hanging bars	JFHA-36 ■	41
Dividers	JFDA-15 ■	24
Compressor	JFCA-36 ■	24

**Feature**

- Black trim color.
- Available on RUSH.

**To Order, Specify:**

- 1) Product number.  
(No finish specification required.)