

Tripoli™ Price List

January 2011

This Haworth North American price book contains US list prices.



Canadian customers can convert the US list price into their Canadian equivalent by going to www.Haworth.com/Canada to find the current Canadian multipliers. These multiplier factors allow you to convert the US list price into a Canadian list price.

Tripoli — Table of Contents

Product Catalog Number Code	5	Tables	
Desks		Table — Square Occasional — Wood	46
Single Pedestal Rectangular Top Desk — Laminate or Wood Top	6	Table — Rectangle Occasional — Wood	46
Single Pedestal Bow Top Desk — Laminate or Wood Top ...	7	Table — Occasional Drum — Wood	46
Double Pedestal Rectangular Top Desk — Laminate or Wood Top	8	Accessories/Task Lighting	
Double Pedestal Bow Top Desk — Laminate or Wood Top ...	9	Center Drawer	47
Shell — Desk — Laminate or Wood Top	10	Pencil Tray	47
Attached Convergent D-Top — Laminate or Wood Top	11	Pencil + Drawer	47
Attached Convergent P-Top — Laminate or Wood Top	12	Grommet	48
End Panel	13	Enhanced Power Module	48
Mid-Support Panel — Wood	13	Fixed Mount CPU Holder	49
Bridge — Laminate or Wood Worksurface	14	Adjustable CPU Holder	49
Corner Shell — Laminate or Wood Worksurface	15	Mini Shelf	50
Return — Laminate or Wood Worksurface	16-17	Phone Shelf	50
Credenzas		Phone Shelf Bracket	50
Credenza with Pedestals — Laminate or Wood Worksurface	18-19	Personal Shelf	50
Credenza with Pedestals and Closed Storage — Laminate or Wood Worksurface	20-21	Personal Shelf Bracket	51
Credenza with Lateral Files — Laminate or Wood Worksurface	22-23	Paper Sorter	51
Credenza with Closed Storage — Laminate or Wood Worksurface	24-25	Tool Cup	51
Credenza Shell — Laminate or Wood Top	26-27	Letter Tray	51
Upper Storage		Waste Bin	52
Vertical Storage Unit	28	Letter Tray Stacking Kit	52
Tackboards — Vertical Storage Units — Fabric	29	Letter Tray Stacking Bracket	52
Tackboards — Vertical Storage Units — Fabric and Slat Rail	29	Binder Bin	53
Overhead Storage Unit	30	Tack Strip	53
Tackboards — Overhead Storage Units — Fabric	31	Gooseneck Kit	53
Tackboards — Overhead Storage Units — Fabric and Slat Rail	31	Adaptable Electronic Ballast Task Light	54
Reception Stations		Adaptable Casegoods Electronic Ballast Task Light — Starter Light	55
Reception Station L-Shaped — Wood	32	Adaptable Casegoods Electronic Ballast Task Light — Add-on Light	55
Tackboards — Reception Station L-Shaped	32	LIM L	56
Reception Station U-Shaped — Wood	33	LIM Mounted	57
Tackboards — Reception Station U-Shaped	33	LIM C	57
Storage		LIM Hardware	58
Attached Pedestal — Letter Width	34	Finishes and Fabrics	
Filler Strip — Pedestal	34	Finish Matrix	59-60
Mobile Pedestal	35	Fabrics/Color Legend	61-62
Attached Lateral Files	36	Customer's Own Material	
Freestanding Lateral File — Two-High and Three-High — Laminate or Wood Top	37	COM Yardage Requirements	63-65
Freestanding Lateral File — Four-High — Wood	38	Terms of Sale	
Two-High Attached Storage Cabinet with Solid Doors	38	North American	66-69
Two-High Storage Cabinet with Solid Doors — Laminate or Wood Top	39	Index	70-72
Utility Cart — Laminate or Wood Top	40	Lifetime Product Warranty	Inside Back Cover
Attached Wardrobe Cabinet — 9 1/2" Wide — Wood	41		
Freestanding Wardrobe Cabinet — 31" Wide — Wood	41		
Freestanding Wardrobe Cabinet — 16 1/2" Wide — Wood	42		
Storage Cabinet — 16 1/2" Wide — Wood	42		
Freestanding Wardrobe/ Storage Cabinet — Wood	43		
Combination Unit — Wood	43		
Bookcases			
Bookcase — Two-High and Three-High — Laminate or Wood	44		
Bookcase — Four-High and 64" High — Wood	45		

This page intentionally blank

Tripoli — Product Catalog Number Code

Tripoli Product Catalog Number Code

Example: Tripoli laminate top double pedestal desk with full overlay modesty, 30"(762mm) deep, 60"(1524mm) wide, ABS edgeband edge, standard core, standard slides, one B/B/F and one F/F pedestal with black miterfold drawers and rectangular top.

<p>T</p>	<p>J</p>	<p>D</p>	<p>F</p>	<p>-</p>	<p>30</p>	<p>60</p>	<p>-</p>	<p>J</p>	<p>S</p>	<p>S</p>	<p>56</p>	<div style="border: 1px solid black; padding: 5px; width: fit-content;"> <p>Legend: B - Box Drawer F - File Drawer</p> </div>
												<p>Pedestal Drawer Option: 5N – One B/B/F Black Miterfold SN – One B/B/F Wood } Available for Single Pedestal Desks Only</p> <p>55 – Two B/B/F Black Miterfold SS – Two B/B/F Wood 56 – One B/B/F and one F/F Black Miterfold ST – One B/B/F and one F/F Wood } Available for Double Pedestal Desks Only</p>
												<p>Drawer Mechanism: S – Standard Slide</p>
												<p>Core Material: S – Standard</p>
												<p>Edge Option: J – ABS Edge } Laminate Top Only 1 – Square } Veneer Top Only 2 – Bevel 3 – Chamfer 4 – Radius</p>
												<p>Width: 60" – 60" Available for Rectangular Top Desks Only 66" – 66" } Available for Rectangular and Bow Top Desks 72" – 72" 78" – 78"</p>
												<p>Depth: 30" – 30" Rectangular Top Only 36" – 36" Rectangular and Bow Tops</p>
												<p>Shape: F – Rectangular Top B – Bow Top</p>
												<p>Product Type: S – Single Pedestal Desks D – Double Pedestal Desks</p>
												<p>Top Finish: J – Laminate K – Veneer</p>
												<p>Product Line: T – Tripoli</p>

Tripoli — Single Pedestal Desks

Single Pedestal Rectangular Top Desk — Laminate or Wood Top

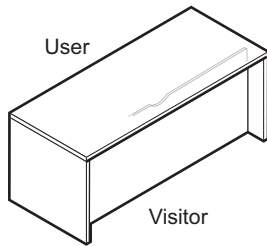
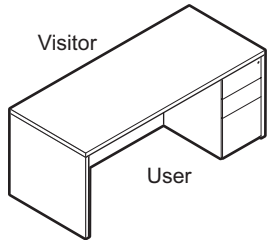

TJSF-JSS5N
TKSF-1SS5N

Height	Depth	Width	Number ① ②	Wood Finish Group			
				1	2	3	4
Laminate Top with Edgeband (J)							
29 1/2"(749mm)	30"(762mm)	60"(1524mm)	TJSF-3060-JSS	\$3122	\$3226	\$3330	\$3479
		66"(1676mm)	TJSF-3066-JSS	3195	3302	3408	3560
		72"(1829mm)	TJSF-3072-JSS	3267	3376	3485	3640
		78"(1981mm)	TJSF-3078-JSS	3409	3523	3636	3799
	36"(914mm)	66"(1676mm)	TJSF-3666-JSS	\$3278	\$3387	\$3497	\$3653
		72"(1829mm)	TJSF-3672-JSS	3448	3563	3678	3842
		78"(1981mm)	TJSF-3678-JSS	3513	3630	3747	3915
		Wood Top with Wood Edge					
29 1/2"(749mm)	30"(762mm)	60"(1524mm)	TKSF-3060- SS	\$3285	\$3395	\$3504	\$3660
		66"(1676mm)	TKSF-3066- SS	3363	3475	3587	3747
		72"(1829mm)	TKSF-3072- SS	3439	3554	3668	3832
		78"(1981mm)	TKSF-3078- SS	3589	3709	3828	3999
	36"(914mm)	66"(1676mm)	TKSF-3666- SS	\$3450	\$3565	\$3680	\$3844
		72"(1829mm)	TKSF-3672- SS	3629	3760	3891	4078
		78"(1981mm)	TKSF-3678- SS	3698	3821	3945	4121

Features

- Includes worksurface, case, and one pedestal.
- 1 1/2"(38mm) thick worksurface in choice of finish: Laminate (with Square ABS edgeband) or Wood Veneer with profiled edge (Square, Bevel, Chamfer or Radius) applied to user and visitor edges only.
- Full-modesty panel recessed 6"(152mm) for visitor side overhang.
- Non-veneer clear coat wireway scallop in top center of modesty panel.
- Box/Box/File pedestal with choice of drawer option:
 - Black miterfold
 - Wood - English dovetailed Baltic Birch
- Pedestal 15 1/2"(394mm) wide.
- Box drawers with one black Polystyrene drawer divider per drawer and one black Polystyrene pencil tray per pedestal.
- File drawer with an integrated file hanging system:
 - Letter size front-to-back filing
 - Legal size side-to-side filing
- Box and file drawers have full extension slides.
- Concealed finger-pulls with clear coat finish vertically routed into MDF.
- One lock standard per pedestal.
- Lock plug is available in black or chrome.
- Lock plug(s) and key(s) are shipped with random numbering unless they are specified "keyed-alike" or "master-keyed".
- Glides provide 2"(51mm) adjustment range.
- Desk shell shipped unassembled, pedestals shipped assembled ready for field installation.

Specification Tips

- Non-handed design, allows pedestal location to be determined on site.
- Accommodates separately specified center drawer.
- Separately specified grommets can be field installed in desk worksurface.
- See Stack-on Application Rules for upper storage requirements.

To Order, Specify:

Laminate Top Desk

- 1) Product number, including:

② Pedestal Drawer Option:

5N Box/Box/File Black Miterfold

SN Box/Box/File Wood, add \$75 list

- 2) Wood finish for case and fronts.
- 3) Laminate worksurface color.
- 4) Edgeband trim color.
- 5) Trim color for lock plug.

Note: Upcharge for Premium Laminates \$56 (list).

Wood Top Desk

- 1) Product number, including:

① Edge Option:

1 Square

2 Bevel

3 Chamfer

4 Radius

② Pedestal Drawer Option:

5N Box/Box/File Black Miterfold

SN Box/Box/File Wood, add \$75 list

- 2) Wood finish.
- 3) Trim color for lock plug.

Tripoli — Single Pedestal Desks

	Height	Depth	Width	Number	Wood Finish Group			
					1	2	3	4
Single Pedestal Bow Top Desk — Laminate or Wood Top	Laminate Top with Edgeband (J)							
	29 1/2"(749mm)	36"(914mm)	72"(1829mm)	TJSB-3672-JSS	\$3731	\$3855	\$3980	\$4157
			78"(1981mm)	TJSB-3678-JSS	3798	3925	4051	4232
	Wood Top with Wood Edge							
	29 1/2"(749mm)	36"(914mm)	72"(1829mm)	TKSB-3672-SS	\$3927	\$4058	\$4189	\$4376
			78"(1981mm)	TKSB-3678-SS	3997	4130	4263	4454

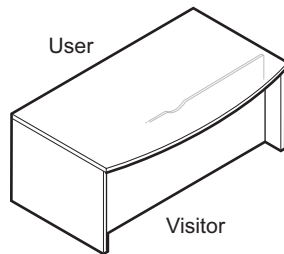
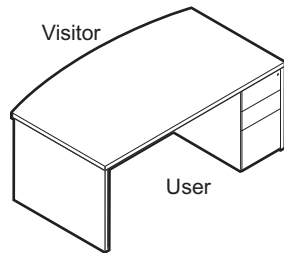

TJSB-JSS5N
TKSB-1SS5N

Features

- Includes worksurface, case, and one pedestal.
- 1 1/2" (38mm) thick worksurface in choice of finish: Laminate (with Square ABS edgeband) or Wood Veneer with profiled edge (Square, Bevel, Chamfer or Radius) applied to user and visitor edges only.
- Full-modesty panel recessed 6" (152mm) at end panels and 12" (304mm) at center of bow worksurface for visitor side overhang: worksurface depth at center of bow is 42" (1067mm).
- Non-veneer clear coat wireway scallop in top center of modesty panel.
- Box/Box/File pedestal with choice of drawer option:
 - Black miterfold
 - Wood - English dovetailed Baltic Birch
- Pedestal 15 1/2" (394mm) wide.
- Box drawers with one black Polystyrene drawer divider per drawer and one black Polystyrene pencil tray per pedestal.
- File drawer with an integrated file hanging system:
 - Letter size front-to-back filing
 - Legal size side-to-side filing
- Box and file drawers have full extension slides.
- Concealed finger-pulls with clear coat finish vertically routed into MDF.
- One lock standard per pedestal.
- Lock plug is available in black or chrome.
- Lock plug(s) and key(s) are shipped with random numbering unless they are specified "keyed-alike" or "master-keyed".
- Glides provide 2" (51mm) adjustment range.
- Desk shell shipped unassembled, pedestals shipped assembled ready for field installation.

Specification Tips

- Non-handed design, allows pedestal location to be determined on site.
- Accommodates separately specified center drawer.
- Separately specified grommets can be field installed in desk worksurface.
- See Vertical Storage Application Rules for upper storage requirements.

To Order, Specify:

Laminate Top Desk

- 1) Product number, including:

2) Pedestal Drawer Option:

5N Box/Box/File Black Miterfold

SN Box/Box/File Wood, add \$75 list

- 2) Wood finish for case and fronts.
- 3) Laminate worksurface color.
- 4) Edgeband trim color.
- 5) Trim color for lock plug.

Note: Upcharge for Premium Laminates \$56 (list).

Wood Top Desk

- 1) Product number, including:

1) Edge Option:

1 Square

2 Bevel

3 Chamfer

4 Radius

2) Pedestal Drawer Option:

5N Box/Box/File Black Miterfold

SN Box/Box/File Wood, add \$75 list

- 2) Wood finish.
- 3) Trim color for lock plug.

Tripoli — Double Pedestal Desks

Double Pedestal Rectangular Top Desk — Laminate or Wood Top

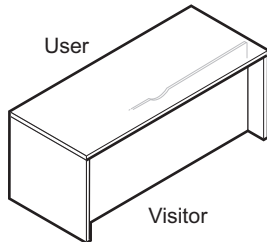
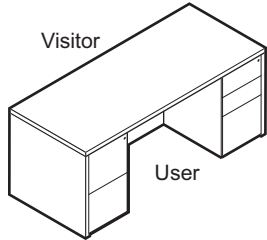

TJDF-JSS56
TKDF-1SS56

Height	Depth	Width	Number ① ②	Wood Finish Group			
				1	2	3	4
Laminate Top with Edgeband (J)							
29 1/2"(749mm)	30"(762mm)	66"(1676mm)	TJDF-3066-JSS	\$4592	\$4745	\$4898	\$5117
		72"(1829mm)	TJDF-3072-JSS	4664	4819	4975	5197
		78"(1981mm)	TJDF-3078-JSS	4733	4891	5049	5274
	36"(914mm)	66"(1676mm)	TJDF-3666-JSS	\$4677	\$4833	\$4989	\$5211
		72"(1829mm)	TJDF-3672-JSS	4787	4947	5106	5334
		78"(1981mm)	TJDF-3678-JSS	4918	5082	5246	5480
Wood Top with Wood Edge							
29 1/2"(749mm)	30"(762mm)	66"(1676mm)	TKDF-3066-SS	\$4685	\$4841	\$4997	\$5220
		72"(1829mm)	TKDF-3072-SS	4760	4919	5077	5304
		78"(1981mm)	TKDF-3078-SS	4830	4991	5152	5382
	36"(914mm)	66"(1676mm)	TKDF-3666-SS	\$4772	\$4931	\$5090	\$5317
		72"(1829mm)	TKDF-3672-SS	4885	5048	5211	5443
		78"(1981mm)	TKDF-3678-SS	5019	5186	5354	5593

Features

- Includes worksurface, case, and two pedestals.
- 1 1/2" (38mm) thick worksurface in choice of finish: Laminate (with Square ABS edgeband) or Wood Veneer with profiled edge (Square, Bevel, Chamfer or Radius) applied to user and visitor edges only.
- Matched veneer drawer fronts.
- Full-modesty panel recessed 6" (152mm) for visitor side overhang.
- Non-veneer clear coat wireway scallop in top center of modesty panel.
- Choice of two Box/Box/File pedestals or one Box/Box/File pedestal and one File/File pedestal.
- Pedestals with a choice of drawer option:
 - Black miterfold
 - Wood - English dovetailed Baltic Birch
- Pedestals 15 1/2" (394mm) wide.
- Box drawers with one black Polystyrene drawer divider per drawer and one black Polystyrene pencil tray per pedestal.
- File drawer with an integrated file hanging system:
 - Letter size front-to-back filing
 - Legal size side-to-side filing
- Box and file drawers have full extension slides.
- Concealed finger-pulls with clear coat finish vertically routed into MDF.
- One lock standard per pedestal; each pedestal locks separately.
- Common key numbers within each desk.
- Lock plug is available in black or chrome.
- Lock plug(s) and key(s) are shipped with random numbering unless they are specified "keyed-alike" or "master-keyed".
- Glides provide 2" (51mm) adjustment range.
- Desk shell shipped unassembled, pedestals shipped assembled ready for field installation.

Specification Tips

- Non-handed design, allows pedestal location to be determined on site.
- Accommodates separately specified center drawer.
- Separately specified grommets can be field installed in desk worksurface.
- Not intended to be used with stack-on storage.

To Order, Specify:

Laminate Top Desk

1) Product number, including:

② Pedestal Drawer Option:

55 Two Box/Box/File Black Miterfold

SS Two Box/Box/File Wood, add \$150 list

56 One Box/Box/File and One File/File Black Miterfold

ST One Box/Box/File and One File/File Wood, add \$150 list

2) Wood finish for case and fronts.

3) Laminate worksurface color.

4) Edgeband trim color.

5) Trim color for lock plug.

Note: Upcharge for Premium Laminates \$56 (list).

Wood Top Desk

1) Product number, including:

① Edge Option:

1 Square

2 Bevel

3 Chamfer

4 Radius

② Pedestal Drawer Option:

55 Two Box/Box/File Black Miterfold

SS Two Box/Box/File Wood, add \$150 list

56 One Box/Box/File and One File/File Black Miterfold

ST One Box/Box/File and One File/File Wood, add \$150 list

2) Wood finish.

3) Trim color for lock plug.

Tripoli — Double Pedestal Desks

	Height	Depth	Width	Number	Wood Finish Group			
					1	2	3	4
Double Pedestal Bow Top Desk								
— Laminate or Wood Top								
Laminate Top with Edgeband (J)								
	29 1/2"(749mm)	36"(914mm)	72"(1829mm)	TJDB-3672-JSS	\$4925	\$5089	\$5253	\$5488
			78"(1981mm)	TJDB-3678-JSS	5057	5226	5394	5635
Wood Top with Wood Edge								
	29 1/2"(749mm)	36"(914mm)	72"(1829mm)	TKDB-3672-SS	\$5025	\$5193	\$5360	\$5599
			78"(1981mm)	TKDB-3678-SS	5160	5332	5504	5750

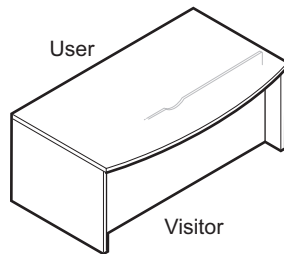
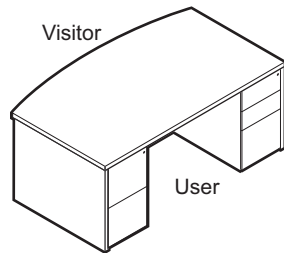

TJDB-JSS56
TKDB-1SS56

Features

- Includes worksurface, case, and two pedestals.
- 1 1/2"(38mm) thick worksurface in choice of finish: Laminate (with Square ABS edgeband) or Wood Veneer with profiled edge (Square, Bevel, Chamfer or Radius) applied to user and visitor edges only.
- Matched veneer drawer fronts.
- Full-modesty panel recessed 6"(152mm) at end panels and 12"(304mm) at center of bow worksurface for visitor side overhang: worksurface depth at center of bow is 42"(1067mm).
- Non-veneer clear coat wireway scallop in top center of modesty panel.
- Choice of two Box/Box/File pedestals or one Box/Box/File pedestal and one File/File pedestal.
- Pedestals with a choice of drawer option:
 - Black miterfold
 - Wood - English dovetailed Baltic Birch
- Pedestals 15 1/2"(394mm) wide.
- Box drawers with one black Polystyrene drawer divider per drawer and one black Polystyrene pencil tray per pedestal.
- File drawer with an integrated file hanging system:
 - Letter size front-to-back filing
 - Legal size side-to-side filing
- Box and file drawers have full extension slides.
- Concealed finger-pulls with clear coat finish vertically routed into MDF.
- One lock standard per pedestal; each pedestal locks separately.
- Common key numbers within each desk.
- Lock plug is available in black or chrome.
- Lock plug(s) and key(s) are shipped with random numbering unless they are specified "keyed-alike" or "master-keyed".
- Glides provide 2"(51mm) adjustment range.
- Desk shell shipped unassembled, pedestals shipped assembled ready for field installation.

Specification Tips

- Non-handed design, allows pedestal location to be determined on site.
- Accommodates separately specified center drawer.
- Separately specified grommets can be field installed in desk worksurface.
- Not intended to be used with stack-on storage.

To Order, Specify:

Laminate Top Desk

- 1) Product number, including:

2) Storage Option:

- 55** Two Box/Box/File Black Miterfold
- SS** Two Box/Box/File Wood, add \$150 list
- 56** One Box/Box/File & One File/File Black Miterfold
- ST** One Box/Box/File & One File/File Wood, add \$150 list

- 2) Wood finish for case and fronts.
- 3) Laminate worksurface color.
- 4) Edgeband trim color.
- 5) Trim color for lock plug.

Note: Upcharge for Premium Laminates \$56 (list).

Wood Top Desk

- 1) Product number, including:

1) Edge Option:

- 1** Square
- 2** Bevel
- 3** Chamfer
- 4** Radius

2) Storage Option:

- 55** Two Box/Box/File Black Miterfold
- SS** Two Box/Box/File Wood, add \$150 list
- 56** One Box/Box/File & One File/File Black Miterfold
- ST** One Box/Box/File & One File/File Wood, add \$150 list

- 2) Wood finish.
- 3) Trim color for lock plug.

Tripoli — Desk Shells

Shell — Desk — Laminate or Wood Top	Height	Depth	Width	Number ①	Wood Finish Group				
					1	2	3	4	
	Laminate Top with Edgeband (J)								
	29 1/2"(749mm)	30"(762mm)	60"(1524mm)	TJYF-3060-JSNV	\$1896	\$1939	\$1981	\$2043	
			66"(1676mm)	TJYF-3066-JSNV	1973	2016	2060	2122	
			72"(1829mm)	TJYF-3072-JSNV	2046	2090	2134	2196	
			78"(1981mm)	TJYF-3078-JSNV	2123	2167	2212	2276	
			84"(2134mm)	TJYF-3084-JSNV	2201	2246	2291	2356	
		36"(914mm)	60"(1524mm)	TJYF-3660-JSNV	\$1973	\$2018	\$2063	\$2127	
			66"(1676mm)	TJYF-3666-JSNV	2152	2197	2243	2308	
			72"(1829mm)	TJYF-3672-JSNV	2233	2279	2325	2391	
			78"(1981mm)	TJYF-3678-JSNV	2337	2384	2430	2497	
			84"(2134mm)	TJYF-3684-JSNV	2413	2460	2508	2575	
		Wood Top with Wood Edge							
		29 1/2"(749mm)	30"(762mm)	60"(1524mm)	TKYF-3060-■ SNV	\$1935	\$1979	\$2022	\$2085
				66"(1676mm)	TKYF-3066-■ SNV	2013	2057	2101	2165
			72"(1829mm)	TKYF-3072-■ SNV	2088	2133	2178	2242	
			78"(1981mm)	TKYF-3078-■ SNV	2166	2211	2257	2322	
			84"(2134mm)	TKYF-3084-■ SNV	2246	2292	2338	2404	
		36"(914mm)	60"(1524mm)	TKYF-3660-■ SNV	\$2013	\$2059	\$2105	\$2170	
			66"(1676mm)	TKYF-3666-■ SNV	2196	2242	2289	2355	
			72"(1829mm)	TKYF-3672-■ SNV	2279	2326	2373	2440	
			78"(1981mm)	TKYF-3678-■ SNV	2385	2433	2480	2548	
			84"(2134mm)	TKYF-3684-■ SNV	2462	2510	2559	2628	

TJYF-JSNV
TKYF-1SNV

Features

- Includes worksurface, case and attachment hardware.
- 1 1/2"(38mm) thick worksurface in choice of finish:
Laminate (with Square ABS edgeband) or Wood Veneer with profiled edge (Square, Bevel, Chamfer or Radius) applied to user and visitor edges only.
- Full-modesty panel recessed 6"(152mm) for visitor side overhang.
- Non-veneer clear coat wireway scallop in top center of modesty panel.
- Glides provide 2"(51mm) adjustment range.
- Shipped unassembled.

Specification Tips

- Accommodates separately specified mobile pedestal or attached storage. Storage elements can be reconfigured in the field.
- 30"(762mm) deep shell accommodates maximum 23"(584mm) deep storage.
- 36"(914mm) deep shell accommodates maximum 29"(737mm) deep storage.
- Accommodates separately specified center drawer.
- Separately specified grommets can be field installed in desk worksurface.
- See Vertical Storage Application Rules for upper storage requirements.

To Order, Specify:

Laminate Top Desk

- 1) Product number.
- 2) Wood finish for case.
- 3) Laminate worksurface color.
- 4) Edgeband trim color.

Note: Upcharge for Premium Laminates
\$56 (list).

Wood Top Desk

- 1) Product number, including:

① Edge Option:

- 1 Square
- 2 Bevel
- 3 Chamfer
- 4 Radius

- 2) Wood finish.

Tripoli — Attached Convergent D-Tops with Support Column

Attached Convergent D-Top — Laminate or Wood Top

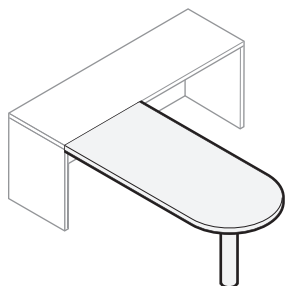

TJND-JSNN
TKND-1SNN

Height	Depth	Width	Number ① ②	Price				
Laminate Top with Edgeband (J)								
29 1/2"(749mm)	30"(762mm)	54"(1372mm)	TJND-3054-JSNN	\$1400				
		60"(1524mm)	TJND-3060-JSNN	1458				
		66"(1676mm)	TJND-3066-JSNN	1510				
		72"(1829mm)	TJND-3072-JSNN	1607				
		78"(1981mm)	TJND-3078-JSNN	1665				
					Wood Finish Group			
					1	2	3	4
Wood Top with Wood Edge								
29 1/2"(749mm)	30"(762mm)	54"(1372mm)	TKND-3054- <input type="checkbox"/> SN <input type="checkbox"/>	\$1521	\$1572	\$1622	\$1695	
		60"(1524mm)	TKND-3060- <input type="checkbox"/> SN <input type="checkbox"/>	1586	1639	1692	1767	
		66"(1676mm)	TKND-3066- <input type="checkbox"/> SN <input type="checkbox"/>	1641	1696	1750	1829	
		72"(1829mm)	TKND-3072- <input type="checkbox"/> SN <input type="checkbox"/>	1746	1804	1862	1946	
		78"(1981mm)	TKND-3078- <input type="checkbox"/> SN <input type="checkbox"/>	1810	1870	1931	2017	

Features

- Includes worksurface, two flat brackets, column base and column base attachment hardware.
- 1 1/2"(38mm) thick worksurface in choice of finish: Laminate (with Square ABS edgeband) or Wood Veneer with profiled edge (Square, Bevel, Chamfer or Radius) applied to all edges except non-cope connection edge.
- Worksurfaces with Radius or Bevel profiled edge available with coped connection edge option.
- 4"(102mm) diameter column leg with 3"(76mm) adjustment availability.
- Shipped unassembled.

Specification Tips

- Not designed to stand alone.
- Includes two flat brackets to allow for attachment to modular credenza.
- Convergent D-top may be attached to a return or bridge with separately specified end panel.
- Connecting edge will require a cope when attaching to a credenza unit with Radius or Bevel profiled edge.
- May not be used to support a vertical storage unit.
- Accommodates separately specified center drawer.
- Separately specified grommets can be field installed in desk worksurface.

To Order, Specify:

Laminate Top Convergent

- 1) Product number.
- 2) Laminate worksurface color.
- 3) Edgeband trim color.
- 4) Column trim color.

Note: Upcharge for Premium Laminates \$56 (list).

Wood Top Convergent

- 1) Product number, including:

① Edge Option:

- 1 Square
- 2 Bevel
- 3 Chamfer
- 4 Radius

② Coped Edge Option:

- N No Cope
- Y Coped (Bevel and Radius edges only)

- 2) Wood finish.
- 3) Column trim color.

Note: \$230 upcharge (list) for chrome column trim.

Tripoli — Attached Convergent P-Tops with Support Column

	Height	Depth	Width	Number ① ② ③	Price
Attached Convergent P-Top — Laminate or Wood Top	Laminate Top with Edgeband (J)				
	29 1/2"(749mm)	30"(762mm)	72"(1829mm)	TJNP-3072-JS ■ N	\$1844
				Wood Finish Group	
				1	2
				3	4
	Wood Top with Wood Edge				
	29 1/2"(749mm)	30"(762mm)	72"(1829mm)	TKNP-3072-■ S ■ ■	\$2004 \$2071 \$2138 \$2233

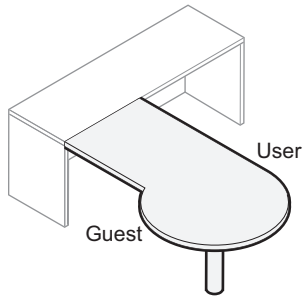

TJNP-JSLN
TKNP-1SLN
(Left-hand shown)

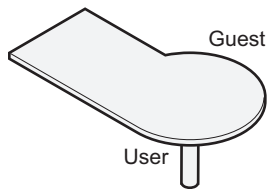

TJNP-JSRN
TKNP-1SRN
(Right-hand shown)

Features

- Includes worksurface, two flat brackets, column base and column base attachment hardware.
- 42"(1067mm) diameter conference end, handed with radius extending away from user.
- 1 1/2"(38mm) thick worksurface in choice of finish: Laminate (with Square ABS edgeband) or Wood Veneer with profiled edge (Square, Bevel, Chamfer or Radius) applied to all edges except non-coped connection edge.
- Worksurfaces with Radius or Bevel profiled edge available with coped connection edge option.
- 4"(102mm) diameter column leg with 3"(76mm) adjustment availability.
- Shipped unassembled.

Specification Tips

- Not designed to stand alone.
- Includes two flat brackets to allow for attachment to modular credenza.
- Convergent P-top may be attached to a return or bridge with separately specified end panel.
- Connecting edge will require a cope when attaching to a credenza unit with Radius or Bevel profiled edge.
- May not be used to support a vertical storage unit.
- Accommodates separately specified center drawer.
- Separately specified grommets can be field installed in desk worksurface.

To Order, Specify:

Laminate Top Convergent

- 1) Product number, including:

② Orientation:

- L** Left-hand
R Right-hand

- 2) Laminate worksurface color.
- 3) Edgeband trim color.
- 4) Column trim color.

Note: Upcharge for Premium Laminates \$56 (list).

Wood Top Convergent

- 1) Product number, including:

① Edge Option:

- 1** Square
2 Bevel
3 Chamfer
4 Radius

② Orientation:

- L** Left-hand
R Right-hand

③ Coped Edge:

- N** No Cope
Y Coped (Bevel and Radius edges only)

- 2) Wood finish.
- 3) Column trim color.

Note: \$230 upcharge (list) for chrome column trim.

Tripoli — Support Panels

	Height	Depth	Width	Number	Wood Finish Group			
					1	2	3	4
End Panel	28"(711mm)	30"(762mm)	1 1/8"(32mm)	TKES-2830-S	\$298	\$308	\$318	\$332

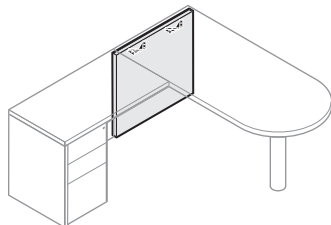

TKES-S

Features

- 1 1/4"(32mm) thick support panel, designed to support the connection end of a convergent worksurface in applications with a return or bridge.
- Glides provide 2"(51mm) adjustment range.
- Connection hardware included.
- Field installation required.

To Order, Specify:

- 1) Product number.
- 2) Wood finish.

Specification Tips

- Connects beneath convergent D-top or P-top to support the perpendicular attachment of a return or bridge.
- The end panel support does not create a freestanding convergent desk. Additional return or bridge/credenza is required for support.

Mid-Support Panel — Wood

28"(711mm)	10 1/8"(257mm)	UXSS-2810-S	\$257	\$267	\$278	\$293
	14"(356mm)	UXSS-2814-S	268	279	289	306

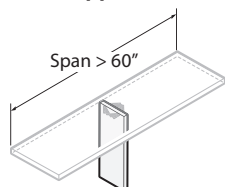

UXSS-S

Features

- Includes 1 1/8"(29mm) thick end panel, glides and attachment hardware.
- Option of 10 1/8"(257mm) and 14"(356mm) deep panel.
- Glides provide 2"(51mm) adjustment range.



To Order, Specify:

- 1) Product number.
- 2) Wood finish.

Specification Tips

- Used to provide support when unsupported span of a worksurface is 60"(1524mm) or greater.
- 10 1/8"(257mm) mid-support panel recommended for use under worksurfaces 22"(559mm) deep.
- 14"(356mm) mid-support panel recommended for use under worksurfaces 30"(762mm) deep and greater.
- Product number shared with Masters Series and Vancouver supports.

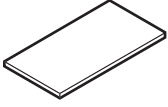
Tripoli — Bridges

Bridge — Laminate or Wood Worksurface	Height	Depth	Width	Number ①②③④	Wood Finish Group			
					1	2	3	4
Laminate Top with Edgeband (J)								
	29 1/2"(749mm)	22"(559mm)	36"(914mm)	TJBF-2236-JS ■ ■ N	\$ 949	\$1000	\$1055	\$1123
			42"(1067mm)	TJBF-2242-JS ■ ■ N	1000	1056	1112	1188
			48"(1219mm)	TJBF-2248-JS ■ ■ N	1052	1113	1170	1254
			54"(1372mm)	TJBF-2254-JS ■ ■ N	1105	1171	1229	1321
Wood Top with Wood Edge								
	29 1/2"(749mm)	22"(559mm)	36"(914mm)	TKBF-2236- ■ S ■ ■ ■	\$ 932	\$ 983	\$1038	\$1106
			42"(1067mm)	TKBF-2242- ■ S ■ ■ ■	986	1042	1098	1174
			48"(1219mm)	TKBF-2248- ■ S ■ ■ ■	1043	1104	1161	1245
			54"(1372mm)	TKBF-2254- ■ S ■ ■ ■	1101	1167	1225	1317

TJBF-JSNNN
TKBF-1SNNNTJBF-JSYNN
TKBF-1SYNNTJBF-JSYQN
TKBF-1SYQNTJBF-JSYFN
TKBF-1SYFN

Features

- Includes worksurface, optional modesty panel and attachment hardware.
- 1 1/2"(38mm) thick worksurface in choice of finish: Laminate (with Square ABS edgeband) or Wood Veneer with profiled edge (Square, Bevel, Chamfer or Radius) applied to user edge only.
- Worksurfaces with Radius or Bevel profiled edge available with coped connection edge option.
- Optional modesty:
 - Full height (F)
 - Three-quarter height (Q)
 - No modesty (N)
- Modesty panel is 3/4"(19mm) thick and includes non-veneer wireway scallop centered in top edge.
- Optional modesty panel with veneer finish both sides.
- Optional 2"(51mm) black grommet centered in back of worksurface. Grommet specification includes a non-veneer clear coat wireway scallop.
- Shipped unassembled.

Specification Tips

- Specified for use between single pedestal desks, desk shells, credenza shells, corner units and convergent worksurfaces with support panel for U-shaped applications.
- Connecting edge will require a cope when attaching to a desk or credenza unit with Radius or Bevel profiled edge: see Coped Profile Applications in Specification Guide.
- Bridges with profiled edges not for use with corner units.

To Order, Specify:

Laminate Top Bridge

- 1) Product number, including:

② Grommet Option:

- N** No Grommet
- Y** Grommet, add \$109 list

③ Modesty Option:

- F** Full Height
- Q** Three-quarter Height, subtract \$84 list
- N** No Modesty, subtract \$100 list

- 2) Wood finish for optional modesty.
- 3) Laminate worksurface color.
- 4) Edgeband trim color.

Note: Upcharge for Premium Laminates \$56 (list).

Wood Top Bridge

- 1) Product number, including:

① Edge Option:

- 1** Square
- 2** Bevel
- 3** Chamfer
- 4** Radius

② Grommet Option:

- N** No Grommet
- Y** Grommet, add \$109 list

③ Modesty Option:

- F** Full Height
- Q** Three-quarter Height, subtract \$84 list
- N** No Modesty, subtract \$100 list

④ Coped Edge:

- N** No Cope
- L** Left
- R** Right
- B** Both

- 2) Wood finish.

Tripoli — Shells

	Height	Depth	Width	Number ①②	Wood Finish Group			
					1	2	3	4
Corner Shell — Laminate or Wood Worksurface	Laminate Top with Edgeband (J)							
	29 1/2"(749mm)	42"(1067mm)	42"(1067mm)	TJCS-4242-JS ■ T	\$2182	\$2250	\$2318	\$2416
	Wood Top with Wood Edge							
	29 1/2"(749mm)	42"(1067mm)	42"(1067mm)	TKCS-4242-■ S ■ T	\$2361	\$2435	\$2509	\$2615

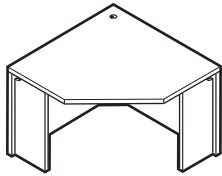

TJCS-JSFT
TKCS-1SFT
(Full modesty shown)

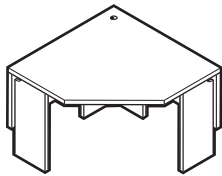

TJCS-JSQT
TKCS-1SQT
(Three-quarter modesty shown)

Features

- Includes worksurface, case and attachment hardware.
- 1 1/2" (38mm) thick worksurface in choice of finish:
Laminate (with Square ABS edgeband) or Wood Veneer with profiled edge (Square, Bevel, Chamfer or Radius) applied to user edge only.
- Optional modesty:
– Full height (F)
– Three-quarter height (Q)
- 22" (559mm) deep attachment.
- End panels with non-veneer integrated wireways with clear coat finish.
- Standard with 2" (51mm) grommet in back corner.
- Glides provide 2" (51mm) adjustment range.
- Shipped unassembled.

Specification Tips

- Specify for attachment to returns and bridges.
- Accommodates separately specified Adjustable Keyboard Pad or Center Drawer.
- Not for use with bridge or return with coped edge. See Coped Profile Applications in Specification Guide.
- See Corner Unit Applications in Specification Guide.

To Order, Specify:**Laminate Top**

- 1) Product number, including:

② Modesty Option:

F Full Height

Q Three-quarter Height, subtract \$49 list

- 2) Wood finish for case.
- 3) Laminate worksurface color.
- 4) Edgeband trim color.

Note: Upcharge for Premium Laminates \$56 (list).

Wood Top

- 1) Product number, including:

① Edge Option:

1 Square

2 Bevel

3 Chamfer

4 Radius

② Modesty Option:

F Full Height

Q Three-quarter Height, subtract \$49 list

- 2) Wood finish.

Tripoli — Returns with End Panel Support

	Height	Depth	Width	Number	① ② ③			Wood Finish Group				
					1	2	3	4				
Return — Laminate Worksurface												
	Laminate Top with Edgeband (J)											
	29 1/2"(749mm)	22"(559mm)	36"(914mm)	TJRS-2236-JS	■ ■ ■ N	\$1281	\$1339	\$1390	\$1478			
			42"(1067mm)	TJRS-2242-JS	■ ■ ■ N	1295	1355	1407	1494			
			48"(1219mm)	TJRS-2248-JS	■ ■ ■ N	1308	1370	1423	1511			
			54"(1372mm)	TJRS-2254-JS	■ ■ ■ N	1322	1386	1440	1528			
			60"(1524mm)	TJRS-2260-JS	■ ■ ■ N	1335	1401	1456	1544			
			66"(1676mm)	TJRS-2266-JS	■ F ■ N	1348	1416	1472	1560			
			72"(1829mm)	TJRS-2272-JS	■ F ■ N	1362	1432	1489	1577			
			78"(1981mm)	TJRS-2278-JS	■ F ■ N	1374	1446	1504	1592			

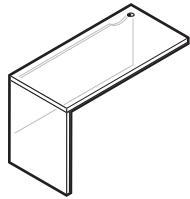

TJRS-JSYQLN
(Three-quarter modesty left-hand shown)

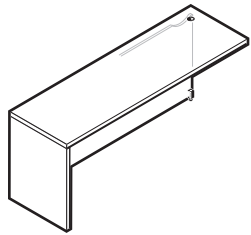

TJRS-JSYFLN
(Full modesty left-hand shown)

Features

- Includes worksurface, case and attachment hardware.
- 1 1/2" (38mm) thick Laminate worksurface with Square ABS edgeband.
- Optional modesty:
 - Full height available with all width returns
 - Three-quarter height available for 36" (914mm)-60" (1524mm) wide returns
- Modesty panel is 3/4" (19mm) thick; veneer finish both sides.
- Optional 2" (51mm) black grommet oriented to connection end of return top. Grommet specification includes a non-veneer clear coat wireway scallop.
- Glides provide 2" (51mm) adjustment range.
- Shipped unassembled.

Specification Tips

- Handed design (left or right) based on position of worksurface support panel.
- Not for freestanding application. Connects to single pedestal desk, desk shell, credenza shell and applicable corner units.
- Specify optional 21" (533mm) deep attached storage units.
- Modesty panel with visible wireway scallop may require discrete placement of the return.

To Order, Specify:

Laminate Top

- 1) Product number, including:

① Grommet Option:

- N** No Grommet
Y Grommet, add \$109 list

② Modesty Option:

- F** Full Height
Q Three-quarter Height (36", 42", 48", 54" & 60" only), subtract \$84 list

③ Orientation:

- L** Left
R Right

- 2) Wood finish for case.
 3) Laminate worksurface color.
 4) Edgeband trim color.

Note: Upcharge for Premium Laminates \$56 (list).

Tripoli — Returns with End Panel Support

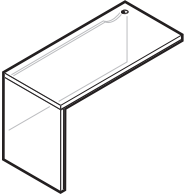
Return — Wood Worksurface	Height	Depth	Width	Number	Wood Finish Group						
					1	2	3	4			
 <p>TKRS-1SYQLN (Three-quarter modesty left-hand shown)</p>	Wood Top with Wood Edge										
	29 1/2"(749mm)	22"(559mm)	36"(914mm)	TKRS-2236-	S			\$1408	\$1466	\$1517	\$1605
			42"(1067mm)	TKRS-2242-	S			1423	1483	1535	1622
			48"(1219mm)	TKRS-2248-	S			1437	1499	1552	1640
			54"(1372mm)	TKRS-2254-	S			1452	1516	1570	1658
			60"(1524mm)	TKRS-2260-	S			1467	1533	1588	1676
			66"(1676mm)	TKRS-2266-	S	F		1482	1550	1606	1694
			72"(1829mm)	TKRS-2272-	S	F		1496	1566	1623	1711
		78"(1981mm)	TKRS-2278-	S	F		1511	1583	1641	1729	

TKRS-1SYQLN
(Three-quarter modesty left-hand shown)

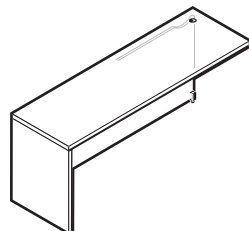

TKRS-1SYFLN
(Full modesty left-hand shown)

Features

- Includes worksurface, case and attachment hardware.
- 1 1/2" (38mm) thick Wood Veneer worksurface with profiled edge (Square, Bevel, Chamfer or Radius) applied to user edge only.
- Worksurfaces with Radius or Bevel profiled edge available with coped connection edge option.
- Optional modesty:
 - Full height available with all width returns
 - Three-quarter height available for 36" (914mm)–60" (1524mm) wide returns
- Modesty panel is 3/4" (19mm) thick; veneer finish both sides.
- Optional 2" (51mm) black grommet oriented to connection end of return top. Grommet specification includes a non-veneer clear coat wireway scallop.
- Glides provide 2" (51mm) adjustment range.
- Shipped unassembled.

Specification Tips

- Handed design (left or right) based on position of worksurface support panel.
- Not for freestanding application. Connects to single pedestal desk, desk shell, credenza shells and applicable corner units.
- Specify optional 21" (533mm) deep attached storage units.
- Connection edge may require a cope when attaching to a desk or shell with Radius or Bevel profile: see Coped Profile Applications in Specification Guide.
- Returns with profiled edges not for use with corner units.
- Modesty panel with visible wireway scallop may require discrete placement of the return.

To Order, Specify:

Wood Top

1) Product number, including:

1 Edge Option:

- 1 Square
- 2 Bevel
- 3 Chamfer
- 4 Radius

2 Grommet Option:

- N No Grommet
- Y Grommet, add \$109 list

3 Modesty Option:

- F Full Height
- Q Three-quarter Height (36", 42", 48", 54" & 60" only), subtract \$84 list

4 Orientation:

- L Left
- R Right

5 Coped Edge:

- Y Coped (Bevel and Radius edges only)
- N No Cope

2) Wood finish.

Tripoli — Credenzas with Pedestals

Credenza with Pedestals — Laminate Worksurface

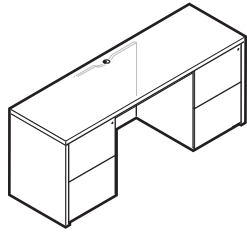

TJZP-JSS66YS

Height	Depth	Width	Number	Wood Finish Group				
				1	2	3	4	
Laminate Top with Edgeband (J)								
29 1/2"(749mm)	22"(559mm)	66"(1676mm)	TJZP-2266-JSS	■ ■ ■	\$3804	\$3935	\$4065	\$4249
		72"(1829mm)	TJZP-2272-JSS	■ ■ ■	3826	3965	4103	4299
		78"(1981mm)	TJZP-2278-JSS	■ ■ ■	3847	3994	4140	4348

Features

- Includes worksurface, case, and two pedestals.
- 1 1/2"(38mm) thick Laminate worksurface with Square ABS edgeband.
- Matched veneer drawer fronts.
- Two File/File pedestals with choice of drawer option:
 - Black miterfold
 - Wood - English dovetailed Baltic Birch
- Pedestals with option of 15 1/2"(394mm) letter width or 18 3/4"(476mm) legal width.
- File drawer with an integrated file hanging system.
- File drawers have full extension slides.
- Concealed finger-pulls with clear coat finish vertically routed into MDF.
- Optional back panel finish:
 - Non-veneer back (S) is designed for application where back of unit is not visible.
 - Veneer back (V) is designed for freestanding application where back of unit is visible.
- Non-veneer clear coat wireway scallop in top center of modesty panel.
- Optional 2"(51mm) black grommet centered in back of worksurface. Grommet specification includes a non-veneer clear coat wireway scallop.
- One lock standard per pedestal; each pedestal locks separately.
- Common key numbers within each credenza.
- Lock plug is available in black or chrome.
- Lock plug(s) and key(s) are shipped with random numbering unless they are specified "keyed-alike" or "master-keyed".
- Glides provide 2"(51mm) adjustment range.
- Credenza shell shipped unassembled, pedestals shipped assembled ready for field installation.

Specification Tips

- May use with a vertical storage unit of equal width.
- Legal width pedestals available for 72"(1829mm) and 78"(1981mm) wide credenzas.

To Order, Specify:

Laminate Top

1) Product number, including:

① Pedestal Drawer Option:

Letter Width Pedestals

66 Two File/File Black Miterfold

TT Two File/File Wood, add **\$150** list

Legal Width Pedestals

(72" and 78" wide only)

99 Two File/File Black Miterfold, add **\$100** list

MM Two File/File Wood, add **\$250** list

② Grommet Option:

N No Grommet

Y Grommet, add **\$109** list

③ Back Finish Option:

S Non-veneer

V Veneer, add **\$125** list

2) Wood finish for case and fronts.

3) Laminate worksurface color.

4) Edgeband trim color.

5) Trim color for lock plug.

Note: Upcharge for Premium Laminates **\$56** (list).

Tripoli — Credenzas with Pedestals

Credenza with Pedestals — Wood Worksurface

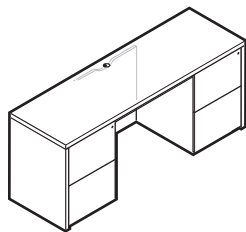

TKZP-1SS66YS

Height	Depth	Width	Number	Wood Finish Group							
				1	2	3	4				
Wood Top with Wood Edge											
29 1/2"(749mm)	22"(559mm)	66"(1676mm)	TKZP-2266-	SS				\$3882	\$4013	\$4143	\$4327
		72"(1829mm)	TKZP-2272-	SS				3904	4043	4181	4377
		78"(1981mm)	TKZP-2278-	SS				3926	4073	4219	4427

Features

- Includes worksurface, case, and two pedestals.
- 1 1/2"(38mm) thick Wood Veneer worksurface with profiled edge (Square, Bevel, Chamfer or Radius) applied to user edge only.
- Matched veneer drawer fronts.
- Two File/File pedestals with choice of drawer option:
 - Black miterfold
 - Wood - English dovetailed Baltic Birch
- Pedestals with option of 15 1/2"(394mm) letter width or 18 3/4"(476mm) legal width.
- File drawer with an integrated file hanging system.
- File drawers have full extension slides.
- Concealed finger-pulls with clear coat finish vertically routed into MDF.
- Optional back panel finish:
 - Non-veneer back (S) is designed for application where back of unit is not visible.
 - Veneer back (V) is designed for freestanding application where back of unit is visible.
- Non-veneer clear coat wireway scallop in top center of modesty panel.
- Optional 2"(51mm) black grommet centered in back of worksurface. Grommet specification includes a non-veneer clear coat wireway scallop.
- One lock standard per pedestal; each pedestal locks separately.
- Common key numbers within each credenza.
- Lock plug is available in black or chrome.
- Lock plug(s) and key(s) are shipped with random numbering unless they are specified "keyed-alike" or "master-keyed".
- Glides provide 2"(51mm) adjustment range.
- Credenza shell shipped unassembled, pedestals shipped assembled ready for field installation.

Specification Tips

- May use with a vertical storage unit of equal width.
- Legal width pedestals available for 72"(1829mm) and 78"(1981mm) wide credenzas.

To Order, Specify:

Wood Top

1) Product number, including:

1 Edge Option:

- 1 Square
- 2 Bevel
- 3 Chamfer
- 4 Radius

2 Pedestal Drawer Option:

Letter Width Pedestals

- 66 Two File/File Black Miterfold
- TT Two File/File Wood, add \$150 list

Legal Width Pedestals

(72" and 78" wide only)

- 99 Two File/File Black Miterfold, add \$100 list
- MM Two File/File Wood, add \$250 list

3 Grommet Option:

- N No Grommet
- Y Grommet, add \$109 list

4 Back Finish Option:

- S Non-veneer
- V Veneer, add \$125 list

- 2) Wood finish.
- 3) Trim color for lock plug.

Tripoli — Credenzas with Pedestals and Closed Storage

Credenza with Pedestals and Closed Storage — Laminate Worksurface

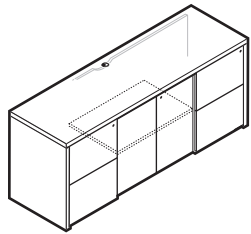

TJZS-JSS66YLS

Height	Depth	Width	Number	Wood Finish Group				
				1	2	3	4	
Laminate Top with Edgeband (J)								
29 1/2"(749mm)	22"(559mm)	66"(1676mm)	TJZS-2266-JSS	■ ■ ■ ■	\$5168	\$5340	\$5511	\$5751
		72"(1829mm)	TJZS-2272-JSS	■ ■ ■ ■	5287	5468	5649	5902
		78"(1981mm)	TJZS-2278-JSS	■ ■ ■ ■	5309	5499	5690	5956

Features

- Includes worksurface, storage cabinet, and two pedestals.
- 1 1/2" (38mm) thick Laminate worksurface with Square ABS edgeband.
- Matched veneer storage drawer and door fronts.
- Two File/File pedestals with choice of drawer option:
 - Black miterfold
 - Wood - English dovetailed Baltic Birch
- Pedestals with option of 15 1/2" (394mm) letter width or 18 3/4" (476mm) legal width.
- File drawer with an integrated file hanging system.
- File drawers have full extension slides.
- Concealed finger-pulls with clear coat finish vertically routed into MDF for pedestal drawers.
- Storage cabinet with touch latch doors and concealed hinges.
- One 3/4" (19mm) thick interior wood shelf in storage cabinet with ±1 1/4" (32mm) adjustment range.
- Adjustable shelf depth sized to allow 1/2" (12.7mm) wireway at the rear of the cabinet.
- Optional back panel finish:
 - Non-veneer back (S) is designed for application where back of unit is not visible.
 - Veneer back (V) is designed for freestanding application where back of unit is visible.
- Non-veneer clear coat wireway scallop in top center of back panel.
- Optional 2" (51mm) black grommet centered in back of worksurface. Grommet specification includes a non-veneer clear coat wireway scallop.
- One lock standard per pedestal; each pedestal locks separately.
- Common key numbers within each credenza.
- Optional lock available for storage cabinet.
- Lock plug is available in black or chrome.
- Lock plug(s) and key(s) are shipped with random numbering unless they are specified "keyed-alike" or "master-keyed".
- Glides provide 2" (51mm) adjustment range.
- Credenza shell shipped unassembled, storage shipped assembled ready for field installation.

Specification Tips

- May use with a vertical storage unit of equal width.
- Center storage cabinet is inset to allow access to finger-pulls on pedestals.
- Legal width pedestals available for 72" (1829mm) and 78" (1981mm) wide credenzas.
- Interior storage clear dimensions:
 - Height: 25 5/16" (643mm)
 - Depth: 19 13/32" (492.9mm)
 - Width: 66" – 30 5/16" (769.7mm)
 - 72" – 33 5/16" (845.9mm)
 - 78" – 36 5/16" (922.1mm)

To Order, Specify:

Laminate Top

1) Product number, including:

1 Pedestal Drawer Option:

Letter Width Pedestals

66 Two File/File Black Miterfold

TT Two File/File Wood, add \$150 list

Legal Width Pedestals

(72" and 78" wide only)

99 Two File/File Black Miterfold, add \$100 list

MM Two File/File Wood, add \$250 list

2 Grommet Option:

N No Grommet

Y Grommet, add \$109 list

3 Lock Option For Storage:

N No Lock

L Lock, add \$104 list

4 Back Finish Option:

S Non-Veneer

V Veneer, add \$125 list

2) Wood finish for case and fronts.

3) Laminate worksurface color.

4) Edgeband trim color.

5) Trim color for lock plug.

Note: Upcharge for Premium Laminates \$56 (list).

Tripoli — Credenzas with Pedestals and Closed Storage

Credenza with Pedestals and Closed Storage — Wood Worksurface

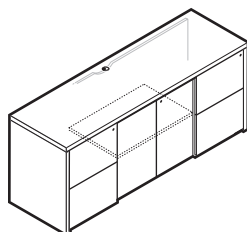

TKZS-1SS66YLS

Height	Depth	Width	Number	Wood Finish Group							
				1	2	3	4				
Wood Top with Wood Edge											
29 1/2"(749mm)	22"(559mm)	66"(1676mm)	TKZS-2266-	SS				\$5273	\$5445	\$5616	\$5856
		72"(1829mm)	TKZS-2272-	SS				5395	5576	5757	6010
		78"(1981mm)	TKZS-2278-	SS				5417	5607	5798	6064

Features

- Includes worksurface, storage cabinet, and two pedestals.
- 1 1/2"(38mm) thick Wood Veneer worksurface with profiled edge (Square, Bevel, Chamfer or Radius) applied to user edge only.
- Matched veneer storage drawer and door fronts.
- Two File/File pedestals with choice of drawer option:
 - Black miterfold
 - Wood - English dovetailed Baltic Birch
- Pedestals with option of 15 1/2"(394mm) letter width or 18 3/4"(476mm) legal width.
- File drawer with an integrated file hanging system.
- File drawers have full extension slides.
- Concealed finger-pulls with clear coat finish vertically routed into MDF for pedestal drawers.
- Storage cabinet with touch latch doors and concealed hinges.
- One 3/4"(19mm) thick interior wood shelf in storage cabinet with ± 1 1/4"(32mm) adjustment range.
- Adjustable shelf depth sized to allow 1/2"(12.7mm) wireway at the rear of the cabinet.
- Optional back panel finish:
 - Non-veneer back (S) is designed for application where back of unit is not visible.
 - Veneer back (V) is designed for freestanding application where back of unit is visible.
- Non-veneer clear coat wireway scallop in top center of back panel.
- Optional 2"(51mm) black grommet centered in back of worksurface. Grommet specification includes a non-veneer clear coat wireway scallop.
- One lock standard per pedestal; each pedestal locks separately.
- Common key numbers within each credenza.
- Optional lock available for storage cabinet.
- Lock plug is available in black or chrome.
- Lock plug(s) and key(s) are shipped with random numbering unless they are specified "keyed-alike" or "master-keyed".
- Glides provide 2"(51mm) adjustment range.
- Credenza shell shipped unassembled, storage shipped assembled ready for field installation.

Specification Tips

- May use with a vertical storage unit of equal width.
- Center storage cabinet is inset to allow access to finger pulls on pedestals.
- Legal width pedestals available for 72"(1829mm) and 78"(1981mm) wide credenzas.
- Interior storage clear dimensions:
 - Height: 25 5/16"(643mm)
 - Depth: 19 13/32"(492.9mm)
 - Width: 66" – 30 5/16" (769.7mm)
 - 72" – 33 5/16"(845.9mm)
 - 78" – 36 5/16"(922.1mm)

To Order, Specify:

Wood Top

1) Product number, including:

1 Edge Option:

- 1 Square
- 2 Bevel
- 3 Chamfer
- 4 Radius

2 Pedestal Drawer Option:

Letter Width Pedestals

- 66 Two File/File Black Miterfold
- TT Two File/File Wood, add \$150 list

Legal Width Pedestals

(72" and 78" wide only)

- 99 Two File/File Black Miterfold, add \$100 list

MM Two File/File Wood, add \$250 list

3 Grommet Option:

- N No Grommet
- Y Grommet, add \$109 list

4 Lock Option for Storage:

- N No Lock
- L Lock, add \$104 list

5 Back Finish Option:

- S Non-Veneer
- V Veneer, add \$125 list

2) Wood finish.

3) Trim color for lock plug.

Tripoli — Credenzas with Lateral Files

	Height	Depth	Width	Number	Wood Finish Group				
					1	2	3	4	
Credenza with Lateral Files — Laminate Worksurface	Laminate Top with Edgeband (J)								
	29 1/2"(749mm)	22"(559mm)	66"(1676mm)	TJZL-2266-JSS	■ ■ ■	\$4715	\$4903	\$5091	\$5354
			72"(1829mm)	TJZL-2272-JSS	■ ■ ■	4737	4933	5126	5399

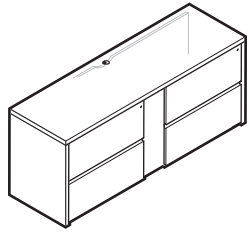

TJZL-JSSSYS

Features

- Includes worksurface, two lateral files, and filler strip.
- 1 1/2" (38mm) thick Laminate worksurface with Square ABS edgeband.
- Matched veneer drawer fronts.
- Choice of drawer option:
 - Black Miterfold
 - Wood - English dovetailed Baltic Birch
- File drawer with an integrated file hanging system:
 - Letter size front-to-back filing
 - Legal size side-to-side filing
- File drawers have full extension slides.
- Horizontally routed finger-pulls.
- Optional back panel finish:
 - Non-veneer back (S) is designed for application where back of unit is not visible.
 - Veneer wood back (V) is designed for freestanding application where back of unit is visible.
- Non-veneer clear coat wireway scallop in top center of back panel.
- Optional 2" (51mm) black grommet centered in back of worksurface. Grommet specification includes a non-veneer clear coat wireway scallop.
- One lock including dual lock bar system standard per lateral file; each lateral file locks separately.
- Common key numbers in each credenza.
- Lock plug is available in black or chrome.
- Lock plug(s) and key(s) are shipped with random numbering unless they are specified "keyed-alike" or "master-keyed".
- Glides provide 2" (51mm) adjustment range.
- Credenza shell shipped unassembled, storage shipped assembled ready for field installation.

Specification Tip

- May use with a vertical storage unit of equal width.

To Order, Specify:

Laminate Top

- 1) Product number, including:

1 File Drawer Option:

- S** Standard
- W** Wood, add **\$180** list

2 Grommet Option:

- N** No Grommet
- Y** Grommet, add **\$109** list

3 Back Finish Option:

- S** Non-veneer
- V** Veneer, add **\$125** list

- 2) Wood finish for case and fronts.
- 3) Laminate worksurface color.
- 4) Edgeband trim color.
- 5) Trim color for lock plug.

Note: Upcharge for Premium Laminates **\$56** (list).

Tripoli — Credenzas with Lateral Files

	Height	Depth	Width	Number	Wood Finish Group			
					1	2	3	4
Credenza with Lateral Files — Wood Worksurface	Wood Top with Wood Edge							
	29 1/2"(749mm)	22"(559mm)	66"(1676mm)	TKZL-2266- SS	\$4811	\$4999	\$5187	\$5450
			72"(1829mm)	TKZL-2272- SS	4833	5029	5222	5495

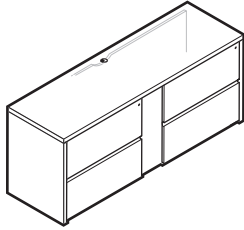

TKZL-1SSSYS

Features

- Includes worksurface, two lateral files, and filler strip.
- 1 1/2" (38mm) thick Wood Veneer worksurface with profiled edge (Square, Bevel, Chamfer or Radius) applied to user edge only.
- Matched veneer drawer fronts.
- Choice of drawer option:
 - Black miterfold
 - Wood - English dovetailed Baltic Birch
- File drawer with an integrated file hanging system:
 - Letter size front-to-back filing
 - Legal size side-to-side filing
- File drawers have full extension slides.
- Horizontally routed finger-pulls.
- Optional back panel finish:
 - Non-veneer back (S) is designed for application where back of unit is not visible.
 - Veneer wood back (V) is designed for freestanding application where back of unit is visible.
- Non-veneer clear coat wireway scallop in top center of back panel.
- Optional 2" (51mm) black grommet centered in back of worksurface. Grommet specification includes a non-veneer clear coat wireway scallop.
- One lock including dual lock bar system standard per lateral file; each lateral file locks separately.
- Common key numbers in each credenza.
- Lock plug is available in black or chrome.
- Lock plug(s) and key(s) are shipped with random numbering unless they are specified "keyed-alike" or "master-keyed".
- Glides provide 2" (51mm) adjustment range.
- Credenza shell shipped unassembled, storage shipped assembled ready for field installation.

Specification Tip

- May use with a vertical storage unit of equal width.

To Order, Specify:

Wood Top

- 1) Product number, including:

1 Edge Option:

1 Square

2 Bevel

3 Chamfer

4 Radius

2 File Drawer Option:

S Standard

W Wood, add \$180 list

3 Grommet Option:

N No Grommet

Y Grommet, add \$109 list

4 Back Finish Option:

S Non-Veneer

V Veneer, add \$125 list

- 2) Wood finish.

- 3) Trim color for lock plug.

Tripoli — Credenzas with Closed Storage

	Height	Depth	Width	Number	Wood Finish Group			
					1	2	3	4
Credenza with Closed Storage								
— Laminate Worksurface								

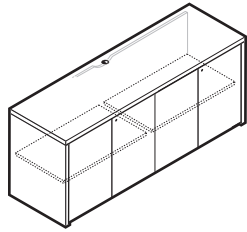

TJZC-JSYLS

Laminate Top with Edgeband (J)

29 1/2"(749mm)	22"(559mm)	66"(1676mm)	TJZC-2266-JS	■ ■ ■	\$3804	\$3949	\$4094	\$4296
		72"(1829mm)	TJZC-2272-JS	■ ■ ■	4022	4170	4320	4526
		78"(1981mm)	TJZC-2278-JS	■ ■ ■	4043	4194	4349	4559

Features

- Includes worksurface and two storage cabinets.
- 1 1/2"(38mm) thick Laminate worksurface with Square ABS edgeband.
- Matched veneer across storage cabinet doors.
- Two storage cabinets; each with touch latch doors and concealed hinges.
- One 3/4"(19mm) interior wood shelf in each storage cabinet with ±1 1/4"(32mm) adjustment range.
- Adjustable shelf depth sized to allow 1/2"(12.7mm) wireway at the rear of the cabinet.
- Optional back panel finish:
 - Non-veneer back (S) is designed for application where back of unit is not visible.
 - Veneer back (V) is designed for freestanding application where back of unit is visible.
- Non-veneer clear coat wireway scallop in top center of back panel.
- Optional 2"(51mm) black grommet centered in back of worksurface. Grommet specification includes a non-veneer clear coat wireway scallop.
- Common key numbers within each credenza.
- Locks are optional; each storage cabinet locks separately.
- Lock plug is available in black or chrome.
- Lock plug(s) and key(s) are shipped with random numbering unless they are specified "keyed-alike" or "master-keyed".
- Glides provide 2"(51mm) adjustment range.
- Credenza shell shipped unassembled, storage shipped assembled ready for field installation.

Specification Tips

- May use with a vertical storage unit of equal width.
- Interior storage clear dimensions:
 - Height: 25 5/16"(643mm)
 - Depth: 19 13/32"(492.9mm)
 - Width: 66" – 31 1/2"(800mm)
 - 72" – 34 1/2"(876.3mm)
 - 78" – 37 1/2"(952.5mm)

To Order, Specify:

Laminate Top

- 1) Product number, including:

1 Grommet Option:

- N No Grommet
- Y Grommet, add \$109 list

2 Lock Option:

- N No Lock
- L Lock, add \$208 list

3 Back Finish Option:

- S Non-Veneer
- V Veneer, add \$125 list

- 2) Wood finish for case and fronts.
- 3) Laminate worksurface color.
- 4) Edgeband trim color.
- 5) Trim color for optional lock plug.

Tripoli — Credenzas with Closed Storage

Credenza with Closed Storage — Wood Worksurface

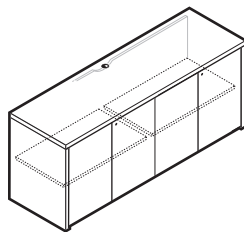

TKZC-1SYLS

Height	Depth	Width	Number	Wood Finish Group							
				1	2	3	4				
Wood Top with Wood Edge											
29 1/2"(749mm)	22"(559mm)	66"(1676mm)	TKZC-2266-	S				\$3882	\$4027	\$4172	\$4374
		72"(1829mm)	TKZC-2272-	S				4103	4251	4401	4607
		78"(1981mm)	TKZC-2278-	S				4125	4276	4431	4641

Features

- Includes work surface and two storage cabinets.
- 1 1/2"(38mm) thick Wood Veneer work surface with profiled edge (Square, Bevel, Chamfer or Radius) applied to user edge only.
- Matched veneer across storage cabinet doors.
- Two storage cabinets; each with touch latch doors and concealed hinges.
- One 3/4"(19mm) interior wood shelf in each storage cabinet with ± 1 1/4"(32mm) adjustment range.
- Adjustable shelf depth sized to allow 1/2"(12.7mm) wireway at the rear of the cabinet.
- Optional back panel finish:
 - Non-veneer back (S) is designed for application where back of unit is not visible.
 - Veneer back (V) is designed for freestanding application where back of unit is visible.
- Non-veneer clear coat wireway scallop in top center of back panel.
- Optional 2"(51mm) black grommet centered in back of work surface. Grommet specification includes a non-veneer clear coat wireway scallop.
- Common key numbers within each credenza.
- Locks are optional; each storage cabinet locks separately.
- Lock plug is available in black or chrome.
- Lock plug(s) and key(s) are shipped with random numbering unless they are specified "keyed-alike" or "master-keyed".
- Glides provide 2"(51mm) adjustment range.
- Credenza shell shipped unassembled, storage shipped assembled ready for field installation.

Specification Tips

- May use with a vertical storage unit of equal width.
- Interior storage clear dimensions:
 - Height: 25 5/16"(643mm)
 - Depth: 19 13/32"(492.9mm)
 - Width: 66" – 31 1/2"(800mm)
 - 72" – 34 1/2"(876.3mm)
 - 78" – 37 1/2"(952.5mm)

To Order, Specify:

Wood Top

- 1) Product number, including:

① Edge Option:

- 1 Square
- 2 Bevel
- 3 Chamfer
- 4 Radius

② Grommet Option:

- N No Grommet
- Y Grommet, add \$109 list

③ Lock Option:

- N No Lock
- L Lock, add \$208 list

④ Back Finish Option:

- S Non-Veneer
- V Veneer, add \$125 list

- 2) Wood finish.
- 3) Trim color for optional lock plug.

Tripoli — Credenza Shells

Credenza Shell — Laminate Top

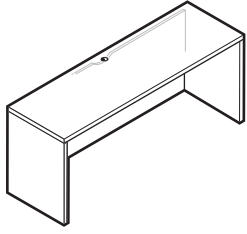

TJZF-JSYS

Height	Depth	Width	Number	Wood Finish Group				
				1	2	3	4	
Laminate Top with Edgeband (J)								
29 1/2"(749mm)	22"(559mm)	48"(1219mm)	TJZF-2248-JS	■	\$1563	\$1644	\$1723	\$1837
		54"(1372mm)	TJZF-2254-JS	■	1591	1674	1755	1871
		60"(1524mm)	TJZF-2260-JS	■	1618	1702	1784	1901
		66"(1676mm)	TJZF-2266-JS	■	1630	1714	1797	1915
		72"(1829mm)	TJZF-2272-JS	■	1645	1732	1819	1940
		78"(1981mm)	TJZF-2278-JS	■	1660	1750	1837	1958
		84"(2134mm)	TJZF-2284-JS	■	1757	1850	1937	2059
		90"(2286mm)	TJZF-2290-JS	■	1792	1888	1975	2097
		96"(2438mm)	TJZF-2296-JS	■	1818	1918	2004	2127

Features

- Includes worksurface and case.
- 1 1/2"(38mm) thick Laminate worksurface with Square ABS edgeband.
- Optional back panel finish:
 - Non-veneer back (S) is designed for application where back of unit is not visible.
 - Veneer back (V) is designed for freestanding application where back of unit is visible.
- Non-veneer clear coat wireway scallop in top center of modesty panel.
- Optional 2"(51mm) black grommet centered in back of worksurface. Grommet specification includes a non-veneer clear coat wireway scallop.
- Glides provide 2"(51mm) adjustment range.
- Shipped unassembled.

Specification Tips

- May be used with a vertical storage unit of equal width. See Vertical Storage Application Rules in Specification Guide.
- 21"(533mm) deep attached storage units may be specified.
- Credenza shells 84"(2134mm) and over require additional separately specified lower supporting storage cabinets.

To Order, Specify:

Laminate Top

- 1) Product number, including:

① Grommet Option:

- N** No Grommet
Y Grommet, add \$109 list

② Back Finish Option:

- S** Non-Veneer
V Veneer
 48" – 54", add \$84 list
 60" – 96", add \$125 list

- 2) Wood finish for case.
 3) Laminate worksurface color.
 4) Edgeband trim color.

Tripoli — Credenza Shells

Credenza Shell — Wood Top

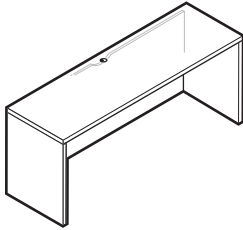

TKZF-1SYS

Height	Depth	Width	Number	Wood Finish Group			
				1	2	3	4
Wood Top with Wood Edge							
29 1/2"(749mm)	22"(559mm)	48"(1219mm)	TKZF-2248-	S			
		54"(1372mm)	TKZF-2254-	S			
		60"(1524mm)	TKZF-2260-	S			
		66"(1676mm)	TKZF-2266-	S			
		72"(1829mm)	TKZF-2272-	S			
		78"(1981mm)	TKZF-2278-	S			
		84"(2134mm)	TKZF-2284-	S			
		90"(2286mm)	TKZF-2290-	S			
		96"(2438mm)	TKZF-2296-	S			

Features

- Includes worksurface and case.
- 1 1/2"(38mm) thick Wood Veneer worksurface with profiled edge (Square, Bevel, Chamfer or Radius) applied to user edge only.
- Optional back panel finish:
 - Non-veneer back (S) is designed for application where back of unit is not visible.
 - Veneer back (V) is designed for freestanding application where back of unit is visible.
- Non-veneer clear coat wireway scallop in top center of modesty panel.
- Optional 2"(51mm) black grommet centered in back of worksurface. Grommet specification includes a non-veneer clear coat wireway scallop.
- Glides provide 2"(51mm) adjustment range.
- Shipped unassembled.

Specification Tips

- May be used with a vertical storage unit of equal width. See Vertical Storage Application Rules in Specification Guide.
- 21"(533mm) deep attached storage units may be specified.
- Credenza shells 84"(2134mm) and over require additional separately specified lower supporting storage cabinets.

To Order, Specify:**Wood Top**

- 1) Product number, including:

1 Edge Option:

- 1** Square
- 2** Bevel
- 3** Chamfer
- 4** Radius

2 Grommet Option:

- N** No Grommet
- Y** Grommet, add **\$109** list

3 Back Finish Option:

- S** Non-Veneer
- V** Veneer
 - 48" – 54", add **\$84** list
 - 60" – 96", add **\$125** list

- 2) Wood finish.

Tripoli — Vertical Storage Units with Solid Doors

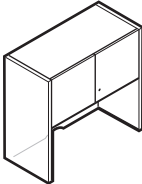
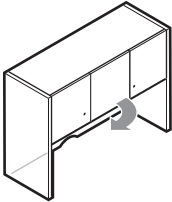
Vertical Storage Unit	Height	Depth	Width	Doors	Number	Wood Finish Group				
						1	2	3	4	
 <p>TKVL-LSNS TKVD-LSNS 31" and 37" widths</p>	Letter Depth									
	34 1/2"(876mm)	14 7/8"(377mm)	31"(787mm)	2	TKVL-3531-	SNS	\$2258	\$2345	\$2432	\$2537
			37"(940mm)	2	TKVL-3537-	SNS	2310	2402	2493	2603
			42"(1067mm)	3	TKVL-3542-	S S	2363	2460	2556	2672
			48"(1219mm)	3	TKVL-3548-	S S	2415	2517	2618	2740
			54"(1372mm)	3	TKVL-3554-	S S	2468	2575	2682	2810
			60"(1524mm)	4	TKVL-3560-	SNS	2520	2633	2745	2880
			66"(1676mm)	4	TKVL-3566-	SNS	2573	2691	2810	2952
			72"(1829mm)	4	TKVL-3572-	SNS	2625	2750	2874	3024
			78"(1981mm)	6	TKVL-3578-	SNS	2678	2809	2940	3097
			84"(2134mm)	6	TKVL-3584-	SNS	2730	2868	3005	3170
	 <p>TKVL-LSLS TKVD-LSLS 42", 48" and 54" widths (Left-hand single door swing shown)</p>	Legal Depth								
34 1/2"(876mm)		17 3/8"(441mm)	31"(787mm)	2	TKVD-3531-	SNS	\$2326	\$2413	\$2500	\$2605
			37"(940mm)	2	TKVD-3537-	SNS	2378	2470	2561	2671
			42"(1067mm)	3	TKVD-3542-	S S	2431	2528	2624	2740
			48"(1219mm)	3	TKVD-3548-	S S	2483	2585	2686	2808
			54"(1372mm)	3	TKVD-3554-	S S	2536	2643	2750	2878
			60"(1524mm)	4	TKVD-3560-	SNS	2588	2701	2813	2948
			66"(1676mm)	4	TKVD-3566-	SNS	2641	2759	2878	3020
			72"(1829mm)	4	TKVD-3572-	SNS	2693	2818	2942	3092
			78"(1981mm)	6	TKVD-3578-	SNS	2746	2877	3008	3165
			84"(2134mm)	6	TKVD-3584-	SNS	2798	2936	3073	3238
			90"(2286mm)	6	TKVD-3590-	SNS	2851	2995	3140	3313
		96"(2438mm)	6	TKVD-3596-	SNS	2903	3055	3206	3388	

TKVL-LSNS
TKVD-LSNS
60", 66" and 72" widths

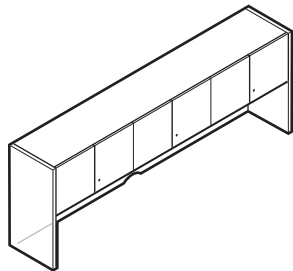

TKVL-LSNS
TKVD-LSNS
78", 84", 90" and 96" widths

Features

- Includes 2"(51mm) integrated light valance, vertical supports and attachment material.
- Non-veneer clear coat wireway scallop in bottom center of back panel.
- Choice of letter or legal depth.
- Back standard with non-veneer finish only.
- 42"(1067mm), 48"(1219mm) and 54"(1372mm) wide units available in choice of left or right door swing for single door.
- Optional locks available; each pair of doors and each single door locks separately.
- Same key numbers within each unit.
- Lock plug is available in black or chrome.
- Lock plug(s) and key(s) are shipped with random numbering unless they are specified "keyed-alike" or "master-keyed".
- 17 3/4"(451mm) clearance between top of worksurface and bottom of cabinet doors.
- Shipped assembled.

Specification Tips

- Designed to stack on equal width credenza, credenza shell, two-high storage cabinet or two-high lateral file. Refer to Vertical Storage Application Rules in Specification Guide.
- Accommodates separately specified tackboards and lighting accessories.
- Not designed for application where back is visible.
- Interior storage clear dimensions:
 - Height: 13"(330.2mm)
 - Letter Depth: 13.23"(336.1mm)
 - Legal Depth: 15.73"(399.6mm)

To Order, Specify:

- 1) Product number, including:

① Lock Option:

- N** No Lock
- L** Lock
 - 31" – 37", add \$104 list
 - 42" – 72", add \$208 list
 - 78" – 96", add \$312 list

② Single Door Swing Orientation

(42", 48" & 54" Wide Only):

- L** Left-hand
- R** Right-hand

- 2) Wood finish.

- 3) Trim color for optional lock plug.

Tripoli — Tackboards for Vertical Storage Units

	Height	Depth	Width	Number	Sections	Fabric Grade						
						A	B	C	D	E	F	G
Tackboards — Vertical Storage Units — Fabric	18 15/16"(481mm)	7/8"(22mm)	28"(711mm)	TTVD-1731	1	\$185	\$194	\$202	\$211	\$218	\$252	\$265
			34"(864mm)	TTVD-1737	1	195	205	213	222	230	265	279
			39"(991mm)	TTVD-1742	1	204	214	222	233	241	277	292
			45"(1143mm)	TTVD-1748	1	211	222	230	241	249	287	302
			51"(1295mm)	TTVD-1754	1	226	237	246	258	267	307	323
			57"(1448mm)	TTVD-1760	1	247	259	269	282	291	336	353
			63"(1600mm)	TTVD-1766	2	306	321	334	349	361	416	438
			69"(1753mm)	TTVD-1772	2	343	360	374	391	405	466	490
			75"(1905mm)	TTVD-1778	2	360	378	392	410	425	490	515
			81"(2057mm)	TTVD-1784	2	376	395	410	429	444	511	538
			87"(2210mm)	TTVD-1790	2	414	435	451	472	489	563	592
			93"(2362mm)	TTVD-1796	2	452	475	493	515	533	615	646

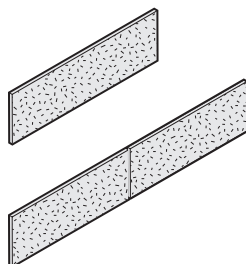

TTVD

Features

- Includes fabric covered tackboard(s) and attachment hardware.
- Tackboards 60"(1524mm) wide and less are shipped in one piece.
- Tackboards over 60"(1524mm) wide are shipped in two equal sized pieces.

To Order, Specify:

- 1) Product number.
- 2) Fabric color.

Specification Tips

- Designed to mount on back panel of vertical storage unit.
- Fabric is not railroaded as standard.

	Height	Depth	Width	Number	Sections	Fabric Grade						
						A	B	C	D	E	F	G
Tackboards — Vertical Storage Units — Fabric and Slat Rail	18 15/16"(481mm)	7/8"(22mm)	28"(711mm)	TTSV-1731	1	\$270	\$278	\$283	\$291	\$298	\$326	\$337
			34"(864mm)	TTSV-1737	1	294	303	309	318	325	356	368
			39"(991mm)	TTSV-1742	1	315	325	331	340	348	381	394
			45"(1143mm)	TTSV-1748	1	322	331	338	347	355	389	402
			51"(1295mm)	TTSV-1754	1	334	344	350	360	369	403	417
			57"(1448mm)	TTSV-1760	1	351	362	369	379	388	425	439
			63"(1600mm)	TTSV-1766	2	401	413	421	433	443	485	501
			69"(1753mm)	TTSV-1772	2	472	486	496	510	522	571	590
			75"(1905mm)	TTSV-1778	2	486	501	511	525	537	588	608
			81"(2057mm)	TTSV-1784	2	500	515	525	540	553	605	625
			87"(2210mm)	TTSV-1790	2	532	548	559	575	588	643	665
			93"(2362mm)	TTSV-1796	2	564	581	592	609	623	682	705

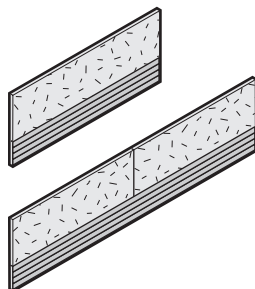

TTSV

Features

- Includes fabric covered tackboard(s) and attachment hardware.
- Tackboards 60"(1524mm) wide and less are shipped in one piece.
- Tackboards over 60"(1524mm) wide are shipped in two equal sized pieces.

To Order, Specify:

- 1) Product number.
- 2) Fabric color.
- 3) Trim color for slat rail.

Specification Tips

- Designed to mount on back panel of vertical storage unit.
- Fabric is not railroaded as standard.
- Accommodates separately specified slat tile accessories.

Tripoli — Overhead Storage Units with Solid Doors

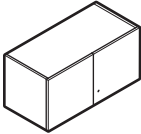
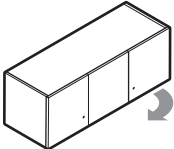
Overhead Storage Unit	Height	Depth	Width	Doors	Number	Wood Finish Group				
						①	②	1	2	3
 <p>UXOL-LSN UXOD-LSN 30", 31", 36" and 37" widths</p>	17"(432mm)	14 7/8" (377mm)	30"(762mm)	2	UXOL-1730-	SN	\$1457	\$1515	\$1574	\$1661
			31"(787mm)	2	UXOL-1731-	SN	1457	1515	1574	1661
			36"(914mm)	2	UXOL-1736-	SN	1573	1636	1699	1793
			37"(940mm)	2	UXOL-1737-	SN	1573	1636	1699	1793
			42"(1067mm)	3	UXOL-1742-	S	1689	1757	1824	1925
			48"(1219mm)	3	UXOL-1748-	S	1805	1877	1949	2058
			54"(1372mm)	3	UXOL-1754-	S	1920	1997	2074	2189
			60"(1524mm)	4	UXOL-1760-	SN	2036	2117	2199	2321
			66"(1676mm)	4	UXOL-1766-	SN	2152	2238	2324	2453
			72"(1829mm)	4	UXOL-1772-	SN	2266	2357	2447	2583
			78"(1981mm)	6	UXOL-1778-	SN	2382	2477	2573	2715
			84"(2134mm)	6	UXOL-1784-	SN	2499	2599	2699	2849
			90"(2286mm)	6	UXOL-1790-	SN	2616	2721	2825	2982
96"(2438mm)	6	UXOL-1796-	SN	2731	2840	2949	3113			
 <p>UXOL-LSL UXOD-LSL 42", 48" and 54" widths (Left-hand single door swing shown)</p>	17"(432mm)	17 3/8"(441mm)	30"(762mm)	2	UXOD-1730-	SN	\$1487	\$1546	\$1606	\$1695
			31"(787mm)	2	UXOD-1731-	SN	1487	1546	1606	1695
			36"(914mm)	2	UXOD-1736-	SN	1605	1669	1733	1830
			37"(940mm)	2	UXOD-1737-	SN	1605	1669	1733	1830
			42"(1067mm)	3	UXOD-1742-	S	1723	1792	1861	1964
			48"(1219mm)	3	UXOD-1748-	S	1842	1916	1894	2100
			54"(1372mm)	3	UXOD-1754-	S	1959	2037	2116	2233
			60"(1524mm)	4	UXOD-1760-	SN	2078	2284	2244	2369
			66"(1676mm)	4	UXOD-1766-	SN	2196	2404	2372	2503
			72"(1829mm)	4	UXOD-1772-	SN	2312	2528	2497	2636
			78"(1981mm)	6	UXOD-1778-	SN	2431	2652	2625	2771
			84"(2134mm)	6	UXOD-1784-	SN	2550	2776	2754	2907
			90"(2286mm)	6	UXOD-1790-	SN	2669	2989	2883	3043
96"(2438mm)	6	UXOD-1796-	SN	2782	2760	3010	3177			

UXOL-LSN
UXOD-LSN
60", 66" and 72" widths

UXOL-LSN
UXOD-LSN
78", 84", 90" and 96" widths

Features

- Includes storage cabinet(s) with 2"(51mm) integrated light valance and 4"(102mm) French cleat with anti-dislodgement feature.
- Choice of letter or legal depth.
- 42"(1067mm), 48"(1219mm) and 54"(1372mm) wide units available in choice of left or right door swing for single door.
- Optional locks available; each pair of doors and each single door lock separately.
- Same key numbers within each unit.
- Lock plug is available in black or chrome.
- Lock plug(s) and key(s) are shipped with random numbering unless they are specified "keyed-alike" or "master-keyed".
- Shipped assembled.

Specification Tips

- Accommodates separately specified tackboards and lighting accessories.
- Must be properly anchored to a structural wall.
- Anchors are not provided, must be field supplied.
- Interior storage clear dimensions:
 - Height: 13"(330.2mm)
 - Letter Depth: 13.23"(336.1mm)
 - Legal Depth: 15.73"(399.6mm)
- Product number shared with Masters Series and Vancouver one-high overhead storage units.

To Order, Specify:

- 1) Product number, including:

① Lock Option:

- N** No Lock
- L** Lock
 - 30" – 37", add \$104 list
 - 42" – 72", add \$208 list
 - 78" – 96", add \$312 list

② Single Door Swing Orientation

(42"48" & 54" Wide Only):

- L** Left-hand
- R** Right-hand

- 2) Wood finish.
- 3) Trim color for lock plug.

Tripoli — Tackboards for Overhead Storage Units

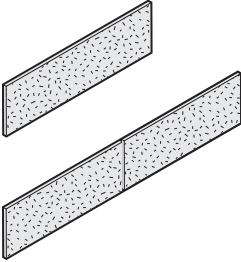
	Height	Depth	Width	Number	Sections	Fabric Grade						
						A	B	C	D	E	F	G
Tackboards — Overhead Storage Units — Fabric  TTWD	16 15/16"(430mm)	7/8"(22mm)	30"(762mm)	TTWD-1730	1	\$183	\$192	\$199	\$209	\$216	\$249	\$262
			31"(787mm)	TTWD-1731	1	185	194	202	211	218	252	265
			36"(914mm)	TTWD-1736	1	192	202	209	219	227	261	275
			37"(940mm)	TTWD-1737	1	195	205	213	222	230	265	279
			42"(1067mm)	TTWD-1742	1	204	214	222	233	241	277	292
			48"(1219mm)	TTWD-1748	1	211	222	230	241	249	287	302
			54"(1372mm)	TTWD-1754	1	226	237	246	258	267	307	323
			60"(1524mm)	TTWD-1760	2	247	259	269	282	291	336	353
			66"(1676mm)	TTWD-1766	2	306	321	334	349	361	416	438
			72"(1829mm)	TTWD-1772	2	343	360	374	391	405	466	490
			78"(1981mm)	TTWD-1778	2	360	378	392	410	425	490	515
			84"(2134mm)	TTWD-1784	2	376	395	410	429	444	511	538
			90"(2286mm)	TTWD-1790	2	414	435	451	472	489	563	592
		96"(2438mm)	TTWD-1796	2	452	475	493	515	533	615	646	

Features

- Includes fabric covered tackboard(s) and attachment hardware.
- Tackboards 60"(1524mm) wide and less are shipped in one piece.
- Tackboards over 60"(1524mm) wide are shipped in two equal sized pieces.

To Order, Specify:

- 1) Product number.
- 2) Fabric color.

Specification Tips

- Designed to mount on wall below equal width overhead storage unit.
- Fabric is not railroaded as standard.

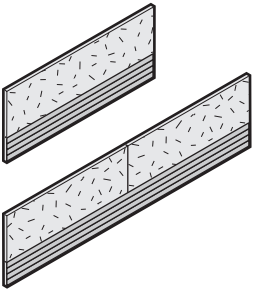
	Height	Depth	Width	Number	Sections	Fabric Grade						
						A	B	C	D	E	F	G
Tackboards — Overhead Storage Units — Fabric and Slat Rail  TTSW	16 15/16"(430mm)	7/8"(22mm)	30"(762mm)	TTSW-1730	1	\$266	\$274	\$279	\$287	\$293	\$321	\$332
			31"(787mm)	TTSW-1731	1	270	278	283	291	298	326	337
			36"(914mm)	TTSW-1736	1	274	282	287	295	302	331	342
			37"(940mm)	TTSW-1737	1	294	303	309	318	325	356	368
			42"(1067mm)	TTSW-1742	1	315	325	331	340	348	381	394
			48"(1219mm)	TTSW-1748	1	322	331	338	347	355	389	402
			54"(1372mm)	TTSW-1754	1	334	344	350	360	369	403	417
			60"(1524mm)	TTSW-1760	2	351	362	369	379	388	425	439
			66"(1676mm)	TTSW-1766	2	401	413	421	433	443	485	501
			72"(1829mm)	TTSW-1772	2	472	486	496	510	522	571	590
			78"(1981mm)	TTSW-1778	2	486	501	511	525	527	588	608
			84"(2134mm)	TTSW-1784	2	500	515	525	540	553	605	625
			90"(2286mm)	TTSW-1790	2	532	548	559	575	588	643	665
		96"(2438mm)	TTSW-1796	2	564	581	592	609	623	682	705	

Features

- Includes fabric covered tackboard(s) and attachment hardware.
- Tackboards 60"(1524mm) wide and less are shipped in one piece.
- Tackboards over 60"(1524mm) wide are shipped in two equal sized pieces.

To Order, Specify:

- 1) Product number.
- 2) Fabric color.
- 3) Trim color for slat rail.

Specification Tips

- Designed to mount on wall below equal width overhead storage unit.
- Fabric is not railroaded as standard.
- Accommodates separately specified slat tile accessories.

Tripoli — Reception Stations

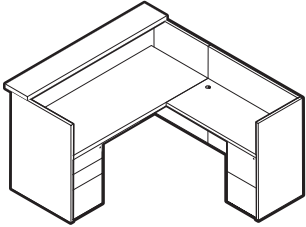
	Height	Depth	Width	Enclosure	Number	Wood Finish Group					
						1	2	3	4		
Reception Station L-Shaped — Wood 	44 1/2" (1130mm)	74 1/4" (1886mm)	74 1/4" (1886mm)	Enclosure	TKLR-8272-	SS	Y				
	29 1/2" (749mm)	29 1/8" (740mm)	72" (1829mm)	Desk							
	29 1/2" (749mm)	21 1/8" (537mm)	48" (1219mm)	Return							
	44 1/2" (1130mm)	82 3/8" (8238mm)	86 1/4" (2191mm)	Enclosure	TKLR-8284-	SS	Y				
	29 1/2" (749mm)	29 1/8" (740mm)	84" (2134mm)	Desk							
	29 1/2" (749mm)	21 1/8" (537mm)	48" (1219mm)	Return							

TKLR-1SS56YR
(Right-hand shown)

Features

- Includes gallery enclosure with countertop, two work surfaces, two pedestals, one grommet and attachment hardware.
- 1 1/2" (38mm) thick work surfaces in Wood Veneer finish and choice of profiled edge (Square, Bevel, Chamfer or Radius) applied to user sides only.
- Countertop depth is 11 1/2" (292mm).
- Countertop is 1 1/2" (38mm) thick with profiled edge both user and visitor sides.
- Choice of drawer option:
 - Black miterfold
 - Wood - English dovetailed Baltic birch
- Pedestals are 15 1/2" (394mm) wide.
- Box drawers with one black Polystyrene drawer divider per drawer and one black Polystyrene pencil tray per pedestal.
- File drawer with an integrated filing hanging system:
 - Letter size front-to-back filing
 - Legal size side-to-side filing
- Box and file drawers have full extension slides.
- Concealed finger-pulls with clear coat finish vertically routed in to MDF.
- One lock standard for each pedestal.
- Lock plug is available in black or chrome.
- Lock plugs and keys are shipped with random numbering unless they are specified "keyed-alike" or "master-keyed".
- Standard with 2" (51mm) black grommet oriented to connection end of return.
- Glides provide 2" (51mm) adjustment range.
- Reception shell shipped unassembled, pedestals shipped assembled ready for field installation.

To Order, Specify:

- 1) Product number, including:

1 Edge Option:

- 1 Square
- 2 Bevel
- 3 Chamfer
- 4 Radius

2 Storage Option:

- 56 One Box/Box/File and One File/File Black Miterfold
- ST One Box/Box/File and One File/File Wood, add \$150 list

3 Orientation:

- L Left-hand
- R Right-hand

- 2) Wood finish.
- 3) Trim color for lock plug.

Specification Tips

- Handed design (left or right) based on orientation of return when seated at main work surface.
- Accommodates separately specified center drawer.
- Specified edge profile is applied to both work surface and countertop.

Tackboards — Reception Station L-Shaped

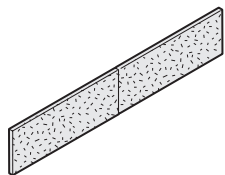

TKTR

Height	Depth	Width	Number	Fabric Grade						
				A	B	C	D	E	F	G
12 1/2" (318mm)	7/8" (22mm)	72" (1822mm)	TKTR-1272	\$306	\$315	\$321	\$330	\$338	\$370	\$383
		84" (2136mm)	TKTR-1284	360	371	378	389	398	435	450

Features

- Includes fabric covered tackboard(s) to mount between reception desk work surface and counter top.
- Tackboards are shipped in two equal width pieces.

To Order, Specify:

- 1) Product number.
- 2) Fabric color.

Specification Tip

- Fabric is directional rightway not directional railroad as standard.

Tripoli — Reception Stations

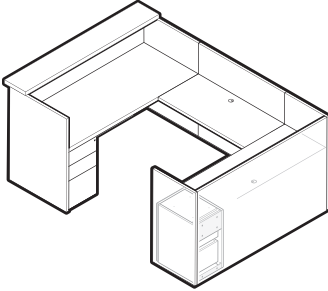
	Height	Depth	Width	Number	①	②	③	Wood Finish Group			
								1	2	3	4
Reception Station U-Shaped — Wood  TKUR-1SS56YR (Right-hand shown)	44 1/2"	103 1/2"	74 1/4"	Enclosure	TKUR-A472-	SS	Y	\$12351	\$12845	\$13339	\$14080
	29 1/2"	29 1/8"	72"	Desk							
	29 1/2"	21 1/8"	48"	Bridge							
	29 1/2"	21 1/8"	72"	Credenza							

Features

- Includes gallery enclosure with countertop, three worksurfaces, two pedestals, two grommets and attachment hardware.
- 1 1/2" (38mm) thick worksurfaces in Wood Veneer finish and choice of profiled edge (Square, Bevel, Chamfer or Radius) applied to user sides only.
- Countertop depth is 11 1/2" (292mm).
- Countertop is 1 1/2" (38mm) thick with profiled edge both user and visitor sides.
- Choice of drawer option:
 - Black miterfold
 - Wood - English dovetailed Baltic birch
- Pedestals are 15 1/2" (394mm) wide.
- Box drawers with one black Polystyrene drawer divider per drawer and one black Polystyrene pencil tray per pedestal.
- File drawer with an integrated filing hanging system:
 - Letter size front-to-back filing
 - Legal size side-to-side filing
- Box and file drawers have full extension slides.
- Concealed finger-pulls with clear coat finish vertically routed in to MDF.
- One lock standard for each pedestal.
- Lock plug is available in black or chrome.
- Lock plugs and keys are shipped with random numbering unless they are specified "keyed-alike" or "master-keyed".
- Standard with 2" (51mm) black grommet centered in back of bridge and credenza.
- Glides provide 2" (51mm) adjustment range.
- Reception shell shipped unassembled, pedestals shipped assembled ready for field installation.

Specification Tips

- Handed design (left or right) based on orientation of bridge when seated at main worksurface.
- Accommodates separately specified center drawer.
- Specified edge profile is applied to both worksurface and countertop.

To Order, Specify:

- 1) Product number, including:

① Edge Option:

- 1 Square
- 2 Bevel
- 3 Chamfer
- 4 Radius

② Storage Option:

- 56 One Box/Box/File and One File/File Black Miterfold
- ST One Box/Box/File and One File/File Wood, add \$150 list

③ Orientation:

- L Left-hand
- R Right-hand

- 2) Wood finish.
- 3) Trim color for lock plug.

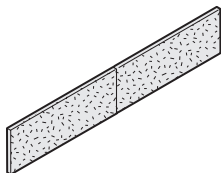
Tackboards — Reception Station U-Shaped

TKTR

Height	Depth	Width	Number	Fabric Grade						
				A	B	C	D	E	F	G
12 1/2" (318mm)	7/8" (22mm)	72" (1822mm)	TKTR-1272	\$306	\$315	\$321	\$330	\$338	\$370	\$383

Features

- Includes fabric covered tackboard(s) to mount between reception desk worksurface and counter top.
- Tackboards are shipped in two equal width pieces.

Specification Tip

- Fabric is directional rightway not directional railroad as standard.

To Order, Specify:

- 1) Product number.
- 2) Fabric color.

Tripoli — Attached Pedestals

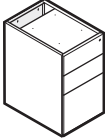
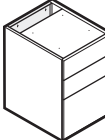
	Height	Depth	Width	Number ①	Wood Finish Group			
					1	2	3	4
Attached Pedestal								
Letter Width								
	28"(711mm)	21"(533mm)	15 1/2"(394mm)	TKPA-2821-■ NSS	\$1350	\$1395	\$1440	\$1504
		23"(584mm)		TKPA-2823-■ NSS	1350	1395	1440	1504
		29"(737mm)		TKPA-2829-■ NSS	1446	1494	1542	1611
Legal Width								
	28"(711mm)	21"(533mm)	18 3/4"(476mm)	TKPA-2821-■ NSS	\$1350	\$1395	\$1440	\$1504
		23"(584mm)		TKPA-2823-■ NSS	1350	1395	1440	1504

TKPA-5NSS

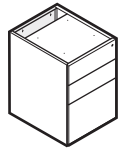

TKPA-8NSS

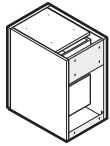

(Back view shown)

Features

- Includes non-veneer top, open back, 3/4"(19mm) thick end panels and attachment hardware.
- Tops of pedestals 21"(533mm) and deeper include a 3"(76mm) or greater horizontal wireway gap.
- 15 1/2"(394mm) letter width; 18 3/4"(476mm) legal width.
- Optional Box/Box/File or File/File configuration with choice of pedestal drawer option:
 - Black miterfold
 - Wood - English dovetailed Baltic Birch
- Box drawer with one black Polystyrene drawer divider per drawer and one black Polystyrene pencil tray per pedestal.
- File drawer with an integrated file hanging system
- Concealed finger-pulls with clear coat finish vertically routed into MDF.
- Box and file drawers have full extension slides.
- One lock standard per pedestal.
- Lock plug is available in black or chrome.
- Lock plug(s) and key(s) are shipped with random numbering unless they are specified "keyed-alike" or "master-keyed".
- Glides provide 2"(51mm) adjustment range.
- Shipped assembled.

Specification Tips

- 21"(533mm) deep pedestals for use under 22"(559mm) deep credenza shell or return.
- 23"(584mm) deep pedestal for 30"(762mm) deep and 36"(914mm) deep desk shells.
- 29"(737mm) deep pedestals for 36"(914mm) deep desk shells; legal width not available.

To Order, Specify:

- 1) Product number, including:

① Pedestal Drawer Option:

Letter Width
(21", 23", and 29" depths)

5 Box/Box/File Black Miterfold

S Box/Box/File Wood, add \$75 list

6 File/File Black Miterfold

T File/File Wood, add \$75 list

Legal Width (21" and 23" depths)

8 Box/Box/File Black Miterfold, add \$50 list

L Box/Box/File Wood, add \$125 list

9 File/File Black Miterfold, add \$50 list

M File/File Wood, add \$125 list

- 2) Wood finish.

- 3) Trim color for lock plug.

Filler Strip — Pedestal

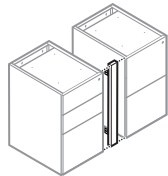

TKKP-S

	Height	Depth	Width	Number	Wood Finish Group			
					1	2	3	4
	27 3/4"(707mm)	1 1/2"(38mm)	2"(51mm)	TKKP-2802-S	\$23	\$26	\$29	\$33

Features

- Includes pedestal filler strip and attachment hardware.
- Field installation required.

Specification Tip

- Designed to create clearance to permit access to vertically routed finger-pulls of attached pedestals when specified with adjacent storage.

To Order, Specify:

- 1) Product number.
- 2) Wood finish.

Tripoli — Mobile Pedestals

	Height	Depth	Width	Number ①	Wood Finish Group			
					1	2	3	4
Mobile Pedestal	21 1/2"(547mm)	21"(533mm)	15 1/2"394(mm)	TKPM-2221-■ NSS	\$1372	\$1418	\$1463	\$1529

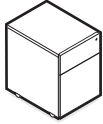

TKPM-4NSS

Features

- Includes veneer finished top, veneer finished back and casters.
- Box/File pedestal with choice of drawer option:
 - Black miterfold
 - Wood - English dovetailed Baltic Birch
- Pedestal 15 1/2"(394mm) wide.
- Box drawer with one black Polystyrene drawer divider per drawer and one black Polystyrene pencil tray per pedestal.
- File drawer includes hanging file system.
- Concealed finger-pulls with clear coat finish vertically routed into MDF.
- Box and file drawers have full extension slides.
- One lock standard per pedestal.
- Lock plug is available in black or chrome.
- Lock plug(s) and key(s) are shipped with random numbering unless they are specified "keyed-alike" or "master-keyed".
- Casters: four black swivel with front two locking.
- Pedestals shipped assembled; casters field installed.

To Order, Specify:

- 1) Product number, including:

① Pedestal Drawer Option:

- 4** Box/File Black Miterfold
 - R** Box/File Wood, add \$75 list
- 2) Wood finish.
- 3) Trim color for lock plug.

Tripoli — Attached Lateral File

Attached Lateral Files	Height	Depth	Width	Number ^①	Wood Finish Group			
					1	2	3	4
	28"(710mm)	21"(533mm)	30"(762mm)	TKFA-2130-N NSS	\$1631	\$1685	\$1740	\$1817
			36"(914mm)	TKFA-2136-N NSS	1980	2046	2112	2206

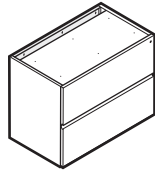

TKFA-NWNSS

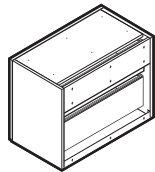

(Back view shown)

Features

- Includes non-veneer top, open back, and 3/4"(19mm) thick end panels.
- Choice of drawer option:
 - Black miterfold
 - Wood - English dovetailed Baltic Birch
- File drawer with an integrated file hanging system:
 - Letter size front-to-back filing
 - Legal size side-to-side filing
- Two file hanging bars included per file drawer.
- Horizontally routed finger-pulls.
- Top of lateral file includes a 3"(76mm) horizontal wireway gap.
- File drawers have full extension slides with integrated anti-tip interlock feature.
- One lock standard per lateral file; includes dual lock bar system.
- Lock plug is available in black or chrome.
- Lock plug(s) and key(s) are shipped with random numbering unless they are specified "keyed-alike" or "master-keyed".
- Glides provide 2"(51mm) adjustment range.
- Shipped assembled.

Specification Tip

- 21"(533mm) deep lateral file for use under 22"(559mm) deep credenza shell or return.

To Order, Specify:

- 1) Product number, including:

① File Drawer Option:

S Standard Black Miterfold

W Wood, add \$90 list

- 2) Wood finish.

- 3) Trim color for lock plug.

Tripoli — Freestanding Lateral Files

	Height	Depth	Width	Number	①	②	③	Wood Finish Group			
								1	2	3	4
Freestanding Lateral File — Two-High and Three-High — Laminate or Wood Top	Laminate Top with Edgeband (J)										
	29 1/2"(749mm)	22"(559mm)	31"(787mm)	TJF2-2231-J	■	NSS	■	\$1996	\$2063	\$2129	\$2224
			37"(940mm)	TJF2-2237-J	■	NSS	■	2154	2226	2298	2400
	43 1/8"(1099mm)	22"(559mm)	31"(787mm)	TJF3-2231-J	■	NSS	■	2518	2602	2686	2806
			37"(940mm)	TJF3-2237-J	■	NSS	■	2720	2811	2901	3031
	Wood Top with Wood Edge										
29 1/2"(749mm)	22"(559mm)	31"(787mm)	TKF2-2231-	■	■	NSS	■	\$2059	\$2128	\$2196	\$2294
		37"(940mm)	TKF2-2237-	■	■	NSS	■	2217	2291	2365	2470
43 1/8"(1099mm)	22"(559mm)	31"(787mm)	TKF3-2231-	■	■	NSS	■	2581	2667	2753	2876
		37"(940mm)	TKF3-2237-	■	■	NSS	■	2783	2876	2969	3101

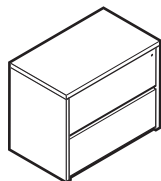
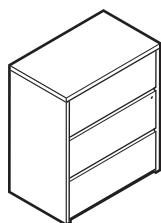
TJF2-JSNSSS
TKF2-1SNSSSTJF3-JSNSSS
TKF3-1SNSSS**Features**

- 1 1/2"(38mm) thick top in choice of finish: Laminate (with Square ABS edgeband) or Wood Veneer with profiled edge (Square, Bevel, Chamfer or Radius) applied to user edge only.
- Choice of drawer option:
 - Black miterfold
 - Wood - English dovetailed Baltic Birch
- File drawer with an integrated file hanging system:
 - Letter size front-to-back filing
 - Legal size side-to-side filing
- Two file hanging bars included per file drawer.
- Horizontally routed finger-pulls.
- Optional back panel finish:
 - Non-veneer back (S) is designed for application where back of unit is not visible.
 - Veneer wood back (V) is designed for freestanding application where back of unit is visible.
- File drawers have full extension slides with integrated anti-tip interlock feature.
- One lock standard per lateral file; includes dual lock bar system. Lock plug is available in black or chrome.
- Lock plug(s) and key(s) are shipped with random numbering unless they are specified "keyed-alike" or "master-keyed".
- Glides provide 2"(51mm) adjustment range.
- Shipped assembled.

Specification Tip

- Two-high lateral file can support a vertical storage unit of equal width.

To Order, Specify:**Laminate Top**

- 1) Product number, including:

② File Drawer Option:

- S** Standard Black Miterfold
- W** Wood, add \$90 list

③ Back Finish Option:

- S** Non-Veneer
- V** Veneer, add \$84 list

- 2) Wood finish for case and front.
- 3) Laminate top color.
- 4) Edgeband trim color.
- 5) Trim color for lock plug.

Note: Upcharge for Premium Laminates \$56 (list).

Wood Top

- 1) Product number, including:

① Edge Option:

- 1** Square
- 2** Bevel
- 3** Chamfer
- 4** Radius

② File Drawer Option:

- S** Standard Black Miterfold
- W** Wood, add \$90 list

③ Back Finish Option:

- S** Non-Veneer
- V** Veneer, add \$84 list

- 2) Wood finish.
- 3) Trim color for lock plug.

Tripoli — Freestanding Lateral Files/Attached Closed Storage

Freestanding Lateral File — Four-High — Wood

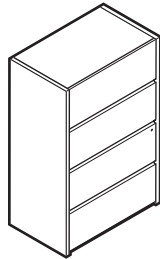

TKF4-NSNSSS

Height	Depth	Width	Number	Wood Finish Group				
				1	2	3	4	
Wood Top with Wood Edge								
56 3/4"(1441mm)	22"(559mm)	31"(787mm)	TKF4-2231-N	NSS	\$3192	\$3298	\$3405	\$3557
		37"(940mm)	TKF4-2237-N	NSS	3449	3564	3679	3843

Features

- Choice of drawer option:
 - Black miterfold
 - Wood - English dovetailed Baltic Birch
- File drawer with an integrated file hanging system:
 - Letter size front-to-back filing
 - Legal size side-to-side filing
- Two file hanging bars included per file drawer.
- Horizontally routed finger-pulls.
- Optional back panel finish:
 - Non-veneer back (S) is designed for application where back of unit is not visible.
 - Veneer wood back (V) is designed for freestanding application where back of unit is visible.
- File drawers have full extension slides with integrated anti-tip interlock feature.
- One lock standard per lateral file; includes dual lock bar system.
- Lock plug is available in black or chrome.
- Lock plug(s) and key(s) are shipped with random numbering unless they are specified "keyed-alike" or "master-keyed".
- Glides provide 2"(51mm) adjustment range.
- Shipped assembled.

To Order, Specify:

- 1) Product number, including:

① File Drawer Option:

- S** Standard Black Miterfold
- W** Wood, add \$90 list

② Back Finish Option:

- S** Non-Veneer
- V** Veneer, add \$84 list

- 2) Wood finish.
- 3) Trim color for lock plug.

Two-High Attached Storage Cabinet with Solid Doors

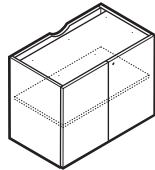

TKHA-NSNL

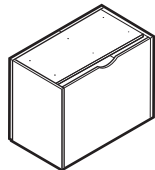

(Back view shown)

Height	Depth	Width	Number	Wood Finish Group				
				1	2	3	4	
28"(710mm)	21"(533mm)	30"(762mm)	TKHA-2130-NSN		\$1391	\$1461	\$1530	\$1628
		36"(914mm)	TKHA-2136-NSN		1491	1566	1640	1745

Features

- Includes storage cabinet with non-veneer top, touch latch doors, concealed hinges and attachment hardware.
- One 3/4"(19mm) adjustable shelf with ±1 1/4"(32mm) adjustment range.
- Adjustable shelf depth sized to allow 1/2"(12.7mm) wireway at the rear of the cabinet.
- Full height non-veneer back panel includes wireway centered in top edge.
- Optional locks available in black or chrome.
- Lock plug(s) and key(s) are shipped with random numbering unless they are specified "keyed-alike" or "master-keyed".
- Glides provide 1"(25mm) adjustment range.
- Shipped assembled.

To Order, Specify:

- 1) Product number, including:

① Lock Option:

- N** No Lock
- L** Lock, add \$104 list

- 2) Wood finish.
- 3) Trim color for optional plug.

Specification Tips

- 21"(533mm) deep storage cabinet for use under 22"(559mm) deep credenza shell or return.
- Interior storage clear dimensions:
 - Height: 25 5/16"(643mm)
 - Depth: 19 13/32"(492.9mm)
 - Width: 30" – 28 1/2"(723.9mm)
 - 36" – 34 1/2"(876.3mm)

Tripoli — Freestanding Closed Storage Cabinets

	Height	Depth	Width	Number	Wood Finish Group				
					1	2	3	4	
Two-High Storage Cabinet with Solid Doors — Laminate or Wood Top	Laminate Top with Edgeband (J)								
	29 1/2"(749mm)	22"(559mm)	31"(787mm)	TJH2-2231-JS		\$1882	\$1977	\$2075	\$2208
	Wood Top with Wood Edge								
	29 1/2"(749mm)	22"(559mm)	31"(787mm)	TKH2-2231-S		\$1920	\$2015	\$2113	\$2246

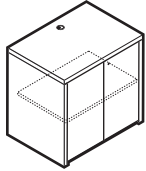
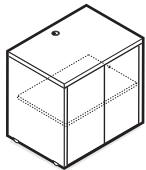
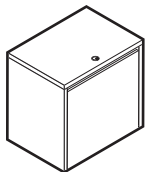
TJH2-JSYLG
TKH2-1SYLGTJH2-JSYLC
TKH2-1SYLC

(Back view shown)

Features

- Includes top, storage cabinet with touch latch doors, concealed hinges and attachment hardware.
- 1 1/2"(38mm) thick worksurface in choice of finish: Laminate (with Square ABS edgeband) or Wood Veneer with profiled edge (Square, Bevel, Chamfer or Radius) applied to user edge only.
- Veneer back with integrated 1 1/2"(38mm) high horizontal wireway.
- Optional 2"(51mm) black grommet centered in back of worksurface.
- One 3/4"(19mm) adjustable shelf with 1 1/4"(32mm) adjustment range.
- Adjustable shelf depth sized to allow 1/2"(12.7mm) wireway at the rear of the cabinet.
- Optional locks available in black or chrome.
- Lock plug(s) and key(s) are shipped with random numbering unless they are specified "keyed-alike" or "master-keyed".
- Optional glides provide 2"(51mm) adjustment range.
- Casters: four black swivel with front two locking.
- Shipped assembled.

Specification Tips

- Not for use with a vertical storage unit.
- Interior storage clear dimensions:
 - Height: 25 5/16"(643mm)
 - Depth: 19 13/32"(492.9mm)
 - Width: 30" – 28 1/2"(723.9mm)
36" – 34 1/2"(876.3mm)

To Order, Specify:

Laminate Top

- 1) Product number, including:

2 Grommet Option:

- N No Grommet
- Y Grommet, add \$109 list

3 Lock Option:

- N No Lock
- L Lock, add \$104 list

4 Glide or Caster Option:

- G Glides
- C Casters, add \$58 list

- 2) Wood finish for case and fronts.
- 3) Laminate top color.
- 4) Edgeband trim color.
- 5) Trim color for lock plug.

Note: Upcharge for Premium Laminates \$56 (list).

Wood Top

- 1) Product number, including:

1 Edge Option:

- 1 Square
- 2 Bevel
- 3 Chamfer
- 4 4 Radius

2 Grommet Option:

- N No Grommet
- Y Grommet, add \$109 list

3 Lock Option:

- N No Lock
- L Lock, add \$104 list

4 Glide or Caster Option:

- G Glides
- C Casters, add \$58 list

- 2) Wood finish.
- 3) Trim color for lock plug.

Tripoli — Utility Carts

	Height	Depth	Width	Number	Wood Finish Group			
					1	2	3	4
Utility Cart — Laminate or Wood Top	Laminate Top with Edgeband (J)							
	29 1/2"(749mm)	22"(559mm)	31"(787mm)	TJAC-2231-JS	\$1283	\$1348	\$1414	\$1506
	Wood Top with Wood Edge							
	29 1/2"(749mm)	22"(559mm)	31"(787mm)	TKAC-2231-S	\$1309	\$1374	\$1440	\$1532

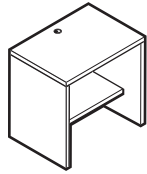
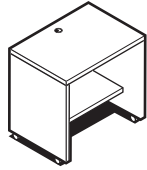
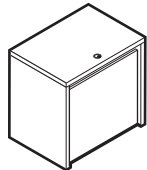
TJAC-JSYG
TKAC-1SYGTJAC-JSYC
TKAC-1SYC

(Back View Shown)

Features

- Includes top, case, and one fixed shelf.
- 1 1/2" (38mm) thick worksurface in choice of finish: Laminate (with Square ABS edgeband) or Wood Veneer with profiled edge (Square, Bevel, Chamfer or Radius) applied to user edge only.
- Fixed shelf is 1 1/2" (38mm) thick and 12" (305mm) deep.
- Veneer back with integrated 1 1/2" (38mm) high horizontal wireway under worksurface.
- Optional 2" (51mm) black grommet centered in back of worksurface.
- Optional glides provide 2" (51mm) adjustment range.
- Casters: four black swivel with front two locking.
- Shipped assembled.

Specification Tips

- Not for use with a vertical storage unit.
- Accommodates separately specified adjustable keyboard pad.

To Order, Specify:

Laminate Top

- 1) Product number, including:

② Grommet Option:

- N No Grommet
- Y Grommet, add \$109 list

③ Glide or Caster Option:

- G Glides
- C Casters, add \$58 list

- 2) Wood finish for case.
- 3) Laminate top color.
- 4) Edgeband trim color.

Note: Upcharge for Premium Laminates \$56 (list).

Wood Top

- 1) Product number, including:

① Edge Option:

- 1 Square
- 2 Bevel
- 3 Chamfer
- 4 Radius

② Grommet Option:

- N No Grommet
- Y Grommet, add \$109 list

③ Glide or Caster Option:

- G Glides
- C Casters, add \$58 list

- 2) Wood finish.

Tripoli — Wardrobe Cabinets

	Height	Depth	Width	Number	Wood Finish Group				
					1	2	3	4	
Attached Wardrobe Cabinet — 9 1/2" Wide — Wood	64"(1626mm)	22"(559mm)	9 1/2"(241mm)	TKJA-6410-NS	■ ■ ■	\$2382	\$2507	\$2632	\$2715

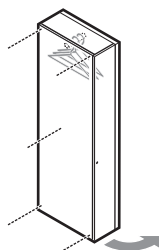

TKJA-NSSLR
(Right-hand with attachment face shown)

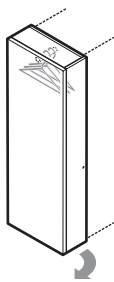

TKJA-NSSL
(Left-hand with non-attachment face shown)

Features

- Includes attached wardrobe cabinet with chrome coat rod, touch latch single door, concealed hinges and attachment hardware.
- Optional back panel finish:
 - Non-veneer back (S) is designed for application where back of unit is not visible.
 - Veneer wood back (V) is designed for freestanding application where back of unit is visible.
- Attachment side of wardrobe cabinet is non-veneer finish.
- Handed left (L) or right (R), opening away from attachment side.
- Optional locks available in black or chrome.
- Lock plug(s) and key(s) are shipped with random numbering unless they are specified "keyed-alike" or "master-keyed".
- Glides provide 1"(25mm) adjustment range.
- Shipped assembled.

Specification Tips

- Attached wardrobe cabinet must be connected to an adjacent 64"(1626mm) high combination unit or storage cabinet.
- Assembled unit consisting of attached wardrobe cabinet and another storage unit may not be moved assembled. Remove attached wardrobe cabinet prior to relocation.

To Order, Specify:

1) Product number, including:

1 Back Finish Option:

- S Non-Veneer
- V Veneer, add \$84 list

2 Lock Option:

- N No Lock
- L Lock, add \$104 list

3 Door Handing:

- L Left-hand
- R Right-hand

2) Wood finish.
3) Trim color for lock plug.

Freestanding Wardrobe Cabinet — 31" Wide — Wood

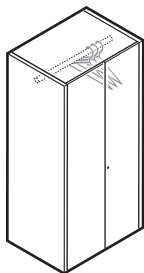

TKJC-NSSL

	Height	Depth	Width	Number	Wood Finish Group				
					1	2	3	4	
	64"(1626mm)	22"(559mm)	31"(787mm)	TKJC-6431-NS	■ ■	\$2741	\$2903	\$3067	\$3294

Features

- Includes wardrobe cabinet with chrome coat rod, touch latch single door, concealed hinges and attachment hardware.
- Optional back panel finish:
 - Non-veneer back (S) is designed for application where back of unit is not visible.
 - Veneer wood back (V) is designed for freestanding application where back of unit is visible.
- Optional locks available in black or chrome.
- Lock plug(s) and key(s) are shipped with random numbering unless they are specified "keyed-alike" or "master-keyed".
- Glides provide 1"(25mm) adjustment range.
- Shipped assembled.

To Order, Specify:

1) Product number, including:

1 Back Finish Option:

- S Non-Veneer
- V Veneer, add \$84 list

2 Lock Option:

- N No Lock
- L Lock, add \$104 list

2) Wood finish.
3) Trim color for lock plug.

Tripoli — Wardrobe and Storage Cabinets

	Height	Depth	Width	Number	Wood Finish Group				
					1	2	3	4	
Freestanding Wardrobe Cabinet — 16 1/2" Wide — Wood	64"(1626mm)	22"(559mm)	16 1/2"(419mm)	TKJC-6417-NS	■ ■ ■	\$2483	\$2586	\$2689	\$2830

Freestanding Wardrobe Cabinet — 16 1/2" Wide — Wood

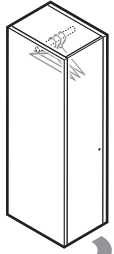
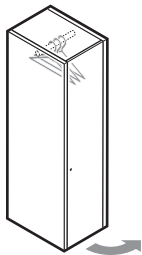
TKJC-NSSLL
(Left-hand shown)TKJC-NSSLR
(Right-hand shown)

Features

- Includes wardrobe cabinet with chrome coat rod, touch latch doors, concealed hinges and attachment hardware.
- Optional back panel finish:
 - Non-veneer back (S) is designed for application where back of unit is not visible.
 - Veneer wood back (V) is designed for freestanding application where back of unit is visible.
- Handed left (L) or right (R) by door opening direction.
- Optional locks available in black or chrome.
- Lock plug(s) and key(s) are shipped with random numbering unless they are specified "keyed-alike" or "master-keyed".
- Glides provide 1"(25mm) adjustment range.
- Shipped assembled.

To Order, Specify:

1) Product number, including:

1 Back Finish Option:

- S** Non-Veneer
- V** Veneer, add \$84 list

2 Lock Option:

- N** No Lock
- L** Lock, add \$104 list

3 Door Handing:

- L** Left-hand
- R** Right-hand

2) Wood finish.

3) Trim color lock plug.

Storage Cabinet — 16 1/2" Wide — Wood

	64"(1626mm)	22"(559mm)	16 1/2"(419mm)	TKHC-6417-NS	■ ■ ■	\$2973	\$3097	\$3221	\$3389
--	-------------	------------	----------------	--------------	-------	--------	--------	--------	--------

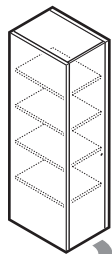
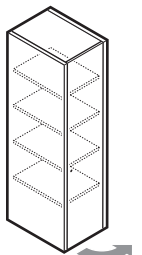
TKHC-NSSLL
(Left-hand shown)TKHC-NSSLR
(Right-hand shown)

Features

- Includes storage cabinet with four shelves, touch latch single door, concealed hinges and attachment hardware.
- One fixed shelf and three adjustable shelves with $\pm 1 \frac{1}{4}$ "(32mm) adjustment range.
- Fixed shelf in the second position from the bottom.
- Optional back panel finish:
 - Non-veneer back (S) is designed for application where back of unit is not visible.
 - Veneer wood back (V) is designed for freestanding application where back of unit is visible.
- Handed left (L) or right (R) by door opening direction.
- Optional locks available in black or chrome.
- Lock plug(s) and key(s) are shipped with random numbering unless they are specified "keyed-alike" or "master-keyed".
- Glides provide 1"(25mm) adjustment range.
- Shipped assembled.

To Order, Specify:

1) Product number, including:

1 Back Finish Option:

- S** Non-Veneer
- V** Veneer, add \$84 list

2 Lock Option:

- N** No Lock
- L** Lock, add \$104 list

3 Door Handing:

- L** Left-hand
- R** Right-hand

2) Wood finish.

3) Trim color for lock plug.

Tripoli — Combination Storage Cabinets

	Height	Depth	Width	Number	Wood Finish Group			
					1	2	3	4
Freestanding Wardrobe/ Storage Cabinet — Wood	64"(1626mm)	22"(559mm)	31"(787mm)	TKXC-6431-NS ■ ■	\$4069	\$4239	\$4409	\$4639

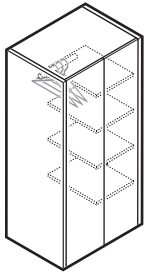

TKXC-NSSL

Features

- Includes wardrobe cabinet with chrome coat rod on left side, storage cabinet with four shelves on right side, touch latch doors, and concealed hinges.
- One fixed shelf and three adjustable shelves with $\pm 1 \frac{1}{4}$ "(32mm) adjustment range.
- Fixed shelf in the second position from the bottom.
- Optional back panel finish:
 - Non-veneer back (S) is designed for application where back of unit is not visible.
 - Veneer wood back (V) is designed for freestanding application where back of unit is visible.
- Optional locks available in black or chrome.
- Lock plug(s) and key(s) are shipped with random numbering unless they are specified "keyed-alike" or "master-keyed".
- Glides provide 1"(25mm) adjustment range.
- Shipped assembled.

To Order, Specify:

1) Product number, including:

1 Back Finish Option:

- S** Non-Veneer
- V** Veneer, add \$84 list

2 Lock Option:

- N** No Lock
- L** Lock, add \$104 list

2) Wood finish.
3) Trim color for lock plug.

Combination Unit — Wood

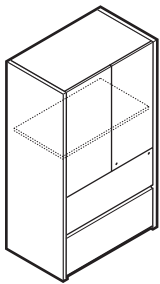

TKM5-NSNSSSL

	Height	Depth	Width	Number	Wood Finish Group			
					1	2	3	4
	64"(1626mm)	22"(559mm)	31"(787mm)	TKM5-6431-N ■ NSS ■ ■	\$4018	\$4220	\$4424	\$4704
			37"(940mm)	TKM5-6437-N ■ NSS ■ ■	4122	4345	4570	4881

Features

- Includes two-high lateral file drawers and storage cabinet with one adjustable shelf, touch latch doors and concealed hinges.
- Adjustable shelf has $\pm 1 \frac{1}{4}$ "(32mm) adjustment range.
- Choice of drawer option:
 - Black miterfold
 - Wood - English dovetailed Baltic Birch
- File drawer with an integrated file hanging system:
 - Letter size front-to-back filing
 - Legal size side-to-side filing
- Lateral file has horizontally routed finger-pulls.
- Optional back panel finish:
 - Non-veneer back (S) is designed for application where back of unit is not visible.
 - Veneer wood back (V) is designed for freestanding application where back of unit is visible.
- File drawers have full extension slides with integrated anti-tip interlock feature.
- One lock standard for lateral file includes dual lock bar system; optional lock available on upper storage cabinets.
- Common key numbers if optional lock selected.
- Lock plug available in black or chrome.
- Lock plug(s) and key(s) are shipped with random numbering unless they are specified "keyed-alike" or "master-keyed".
- Glides provide 1"(25mm) adjustment range.
- Shipped assembled.

To Order, Specify:

1) Product number, including:

1 File Drawer Option:

- S** Standard Black Miterfold
- W** Wood, add \$90 list

2 Back Finish Option:

- S** Non-Veneer
- V** Veneer, add \$84 list

3 Lock Option:

- N** No Lock
- L** Lock, add \$104 list

2) Wood finish.
3) Trim color for lock plug.

Specification Tip

- Interior storage clear dimensions:
 - Height: 35 $\frac{1}{8}$ "(892mm)
 - Depth: 20 $\frac{3}{8}$ "(518mm)
 - Width: 31" – 28 $\frac{5}{8}$ "(727mm)
37" – 34 $\frac{5}{8}$ "(879mm)

Tripoli — Bookcases

Bookcase — Two-High and Three-High — Laminate or Wood

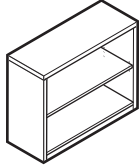
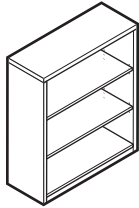
TJQL-JS
TKQL-1STJQL-JS
TKQL-1S

Height	Depth	Width	Number ①	Wood Finish Group			
				1	2	3	4
Letter Depth – Laminate Top with Edgeband (J)							
29 1/2"(749mm)	14"(356mm)	31"(787mm)	TJQL-3031-JS	\$1166	\$1205	\$1244	\$1299
		37"(940mm)	TJQL-3037-JS	1621	1675	1729	1806
43 1/8"(1095mm)	14"(356mm)	31"(787mm)	TJQL-4331-JS	\$1563	\$1615	\$1667	\$1742
		37"(940mm)	TJQL-4337-JS	2018	2085	2153	2249
Letter Depth – Wood Top with Wood Edge							
29 1/2"(749mm)	14"(356mm)	31"(787mm)	TKQL-3031-■ S	\$1229	\$1270	\$1311	\$1369
		37"(940mm)	TKQL-3037-■ S	1684	1740	1796	1876
43 1/8"(1095mm)	14"(356mm)	31"(787mm)	TKQL-4331-■ S	\$1626	\$1680	\$1734	\$1812
		37"(940mm)	TKQL-4337-■ S	2081	2150	2220	2319
Legal Depth – Laminate Top with Edgeband (J)							
29 1/2"(749mm)	16 1/2"(419mm)	31"(787mm)	TJQD-3031-JS	\$1227	\$1268	\$1309	\$1367
		37"(940mm)	TJQD-3037-JS	1705	1762	1819	1900
43 1/8"(1095mm)	16 1/2"(419mm)	31"(787mm)	TJQD-4331-JS	\$1644	\$1699	\$1754	\$1832
		37"(940mm)	TJQD-4337-JS	2122	2193	2263	2365
Legal Depth – Wood Top with Wood Edge							
29 1/2"(749mm)	16 1/2"(419mm)	31"(787mm)	TKQD-3031-■ S	\$1290	\$1333	\$1376	\$1437
		37"(940mm)	TKQD-3037-■ S	1768	1827	1886	1970
43 1/8"(1095mm)	16 1/2"(419mm)	31"(787mm)	TKQD-4331-■ S	\$1707	\$1764	\$1821	\$1902
		37"(940mm)	TKQD-4337-■ S	2185	2258	2331	2435

Features

- Includes choice of Letter or Legal depth bookcase with wood shelves:
 - Two-high includes one adjustable shelf.
 - Three-high includes two adjustable shelves.
- 1 1/2"(38mm) thick worksurface in choice of finish: Laminate (with Square ABS edgeband) or Wood Veneer with profiled edge (Square, Bevel, Chamfer or Radius) applied to the front edge of the top only.
- Adjustable shelf has ±1 1/4"(32mm) adjustment range.
- Non-veneer back.
- Glides provide 1"(25mm) adjustment range.
- Shipped assembled.

To Order, Specify:

Laminate Top

- 1) Product number.
- 2) Wood finish for case.
- 3) Laminate top color.
- 4) Edgeband trim color.

Wood Top

- 1) Product number, including:

① Edge Option:

- 1 Square
- 2 Bevel
- 3 Chamfer
- 4 Radius

- 2) Wood finish.

Tripoli — Bookcases

Height	Depth	Width	Number	Wood Finish Group			
				1	2	3	4
Bookcase — Four-High and 64" High — Wood							
Letter Depth							
55 5/16"(1405mm)	14"(356mm)	31"(787mm)	TKQL-5531-NS	\$2020	\$2087	\$2155	\$2251
		37"(940mm)	TKQL-5537-NS	2476	2559	2641	2759
64"(1626mm)	14"(356mm)	31"(787mm)	TKQL-6431-NS	\$2258	\$2333	\$2409	\$2516
		37"(940mm)	TKQL-6437-NS	2704	2794	2884	3013
Legal Depth							
55 5/16"(1405mm)	16 1/2"(356mm)	31"(787mm)	TKQD-5531-NS	\$2121	\$2192	\$2262	\$2363
		37"(940mm)	TKQD-5537-NS	2599	2686	2772	2896
64"(1626mm)	16 1/2"(356mm)	31"(787mm)	TKQD-6431-NS	\$2370	\$2449	\$2528	\$2641
		37"(940mm)	TKQD-6437-NS	2839	2934	3028	3163

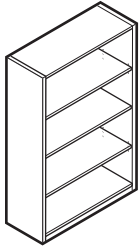

TKQL-NS

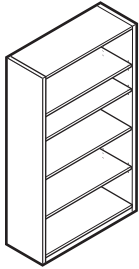

TKQL-NS

Features

- Includes choice of letter or legal depth bookcase with wood shelves:
 - Four-high includes three shelves; two adjustable.
 - 64"(1626mm) high includes four shelves; three adjustable.
- Adjustable shelf has $\pm 1 \frac{1}{4}$ "(32mm) adjustment range.
- Fixed shelf in the second position from the bottom.
- Non-veneer back.
- Glides provide 1"(25mm) adjustment range.
- Shipped assembled.

To Order, Specify:

- 1) Product number.
- 2) Wood finish.

Tripoli — Tables

	Height	Depth	Width	Number ①	Wood Finish Group			
					1	2	3	4
Table — Square Occasional — Wood	16"(406mm)	24"(610mm)	24"(610mm)	TKAS-2424-■ S	\$1426	\$1476	\$1526	\$1597
	21"(533mm)	30"(762mm)	30"(762mm)	TKAS-3030-■ S	1628	1685	1742	1823
	16"(406mm)	42"(1067mm)	42"(1067mm)	TKAS-4242-■ S	1670	1728	1787	1870

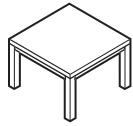

TKAS-1S

Features

- 1 1/2"(38mm) thick Wood Veneer top with profiled edge (Square, Bevel, Chamfer or Radius) applied to all edges.
- 1 3/4"(44mm) thick solid-wood legs and frame.
- Glides provide 1"(25mm) adjustment range.
- Shipped unassembled.

To Order, Specify:

- 1) Product number, including:

① Edge Option:

- 1 Square
- 2 Bevel
- 3 Chamfer
- 4 Radius

- 2) Wood finish.

	Height	Depth	Width	Number ①	Wood Finish Group			
					1	2	3	4
Table — Rectangle Occasional — Wood	21"(533mm)	22"(559mm)	30"(762mm)	TKAR-2230-■ S	\$1567	\$1622	\$1677	\$1755
	16"(406mm)	24"(610mm)	53"(1346mm)	TKAR-2453-■ S	1792	1855	1917	2007

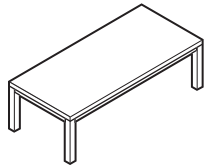

TKAR-1S

Features

- 1 1/2"(38mm) thick Wood Veneer top with profiled edge (Square, Bevel, Chamfer or Radius) applied to all edges.
- 1 3/4"(44mm) thick solid-wood legs and frame.
- Glides provide 1"(25mm) adjustment range.
- Shipped unassembled.

To Order, Specify:

- 1) Product number, including:

① Edge Option:

- 1 Square
- 2 Bevel
- 3 Chamfer
- 4 Radius

- 2) Wood finish.

	Height	Depth	Width	Number ①	Wood Finish Group			
					1	2	3	4
Table — Occasional Drum — Wood	21"(533mm)	18"(457mm)	18"(457mm)	TKAD-2118-S	\$ 949	\$ 982	\$1015	\$1063
		24"(610mm)	24"(610mm)	TKAD-2124-S	1096	1134	1173	1228

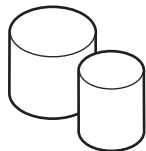

TKAD-S

Features

- Removable top with hollow cylinder (Wood Veneer).
- Shipped assembled.

To Order, Specify:

- 1) Product number.
- 2) Wood finish.

Tripoli — Accessories

	Height	Depth	Width	Number ①	Price
Center Drawer	1 7/8"(48mm)	17 1/2"(445mm)	24"(610mm)	UXCD-1824-■	\$369

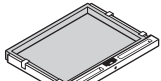

UXCD-L
Class RA

Features

- Center drawer includes attachment hardware.
- Hardwood front rail with routed pencil channels.
- Drawer body is black miterfold.
- Optional lock available in black or chrome.
- Lock plug(s) and key(s) are shipped with random numbering unless they are specified "keyed-alike" or "master-keyed".
- Field installation required.

To Order, Specify:

- 1) Product number, including:

① Lock Option:

- N No Lock
 - L Lock, add \$48 list
- 2) Wood finish.
 - 3) Trim color for lock plug.

Specification Tip

- For use under worksurface of single pedestal desk, double pedestal desk, convergent D-top, convergent P-top, desk shell, credenza shell and credenzas with pedestals.

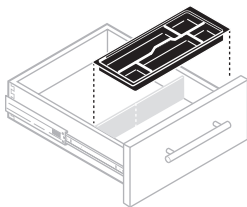
Pencil Tray

JPTA-6
Class FP – SIN 711-3;
Discount Group XII

Letter Width	Depth	Width	Number	Price
1 1/4"(32mm)	5 1/2"(140mm)	12 7/8"(327mm)	JPTA-6	\$25
Legal Width				
1 1/4"(32mm)	5 1/2"(140mm)	16 9/32"(414mm)	JPTA-9	\$28

Features

- Includes one black plastic tray.
- Suspends from sides of 6"(152mm) drawer and slides for drawer access.

To Order, Specify:

- 1) Product number.
(No finish specification required.)

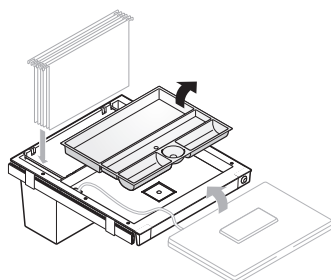
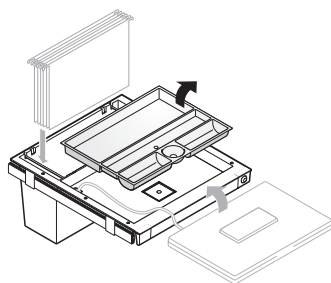
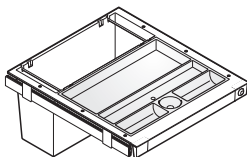
Pencil + Drawer

KUDP
Class YA – SIN 711-1;
Discount Group I

11"(279mm)	24"(610mm)	19 1/2"(495mm)	KUDP-2420 ■	\$254
------------	------------	----------------	-------------	-------

Features

- Multi-purpose drawer provides organization, hanging file along with laptop storage.
- Knock-outs at rear of drawer provide electronic charging access while contents are locked.
- Removable organizing tray.
- Thin profile maximizes knee clearance under front of drawer.
- Standard in black trim color with black locks.
- Standard with lock (shipped separately); "keyed-alike" and "master-keying" options available.

To Order, Specify:

- 1) Product number.
(No finish specification required.)

Specification Tip

- To be mounted below worksurfaces 24"(610mm) or deeper.
- Available on RUSH.

Tripoli — Accessories

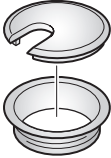
	Height	Inside Diameter	Outside Diameter	Number	Price
Grommet	5/8"(20mm)	1 3/4"(44mm)	2"(51mm)	UXAG-0002	\$9
	Features			To Order, Specify:	
	<ul style="list-style-type: none"> Includes one cover. Must be field-installed; requires 1 3/4"(44mm) field drilled hole. 			<ol style="list-style-type: none"> Product number. Trim color: black or chrome. 	
	Specification Tip			Note: \$27 upcharge (list) for chrome.	
	<ul style="list-style-type: none"> Available in black or satin chrome only. 				

UXAG-0002

Class RA – SIN 711-8;
Discount Group IX

Enhanced Power Module

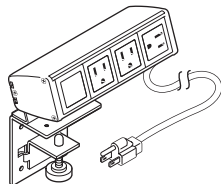

EUD1-1311V

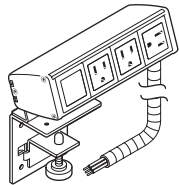

EUD1-C311V

Class YA – SIN 711-1;
Discount Group IX

Height	Width	Depth	Cord Length	Number	1	Price
With Plug						
3 1/2"(89mm)	6 3/4"(171mm)	3 1/2"(89mm) — 4 1/4"(108mm)	6'(1829mm)	EUD1-0000-1311V		\$270
			12'(3658mm)	EUD1-0000-1311W		\$310
Hardwire						
3 1/2"(89mm)	6 3/4"(171mm)	2 1/4"(57mm)	6'(1829mm)	EUD1-0000-C311V		\$320

Features

- Includes power module, mounting brackets and attachment hardware.
- Designed to deliver electrical and data access to the worksurface.
- Attaches to the back edge of the worksurface.
- Supplies three simplex outlets and multiple data jack adapters to accommodate most varieties of field supplied data jacks; also includes a blank data cover.
- Option of appliance power plug or hardwire application to connect to building power.
- Corded power module available with 15 amp - 6'(1829mm) or 12'(3658mm) long cord with plug.
- Hardwired power module available with 6'(1829mm) long flexible metal conduit feed with wires for hardwire application.
- Option of all black or anodized aluminum housing with white receptacles.

To Order, Specify:

- Product number, including:

1 Color Option:

- B** Black
- W** White

Specification Tips

- Accommodates worksurface thicknesses from 1 1/8"(29mm) to 2"(51mm).
- May be installed both above and below the worksurface.
- Accommodates tackboard or vertical storage unit back panel depth.
- For use with 120 volt 60 hertz power source only.
- Enhanced power module applications should be reviewed by local authorities (electrical inspector) prior to ordering.
- Requires field installation.

Tripoli — Accessories

	Description	Number	Price
Fixed Mount CPU Holder	Fixed Mount CPU Holder	KU1C-0000-N	\$90

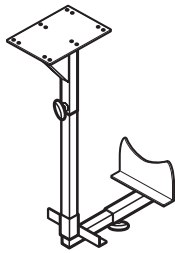

KU1C – Vertical

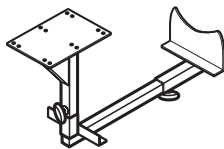

KU1C – Horizontal

Features

- Includes one fixed mount CPU holder.
- Mounts under tops in either vertical or horizontal position.
- Vertical Mount adjustment ranges:
 - Height adjustment for CPU: 15.5" to 20"
 - Width adjustment for CPU: 5.5" to 9.8"
 - Overall height adjustment: 17.5" to 22"
 - Overall width adjustment: 9.25" to 13.5"
- Horizontal Mount adjustment ranges:
 - Height adjustment for CPU: 7.3" to 11.3"
 - Width adjustment for CPU: 13.8" to 18.8"
 - Overall height adjustment: 9.25" to 13.5"
 - Overall width adjustment: 17.5" to 22.5"
- Control knobs allow adjustments as needed.
- Standard in supplier black.
- Field installed.

To Order, Specify:

- 1) Product number.
(No finish specification required.)

Specification Tips

- 85 lbs. maximum weight load.
- Fits under tops 18"(457mm) or deeper.
- Mounting Plate Size:
 - 5.35"(136mm) deep x 3.94"(100mm) wide.

	Description	Track Length	Number	Price
Adjustable CPU Holder	Adjustable Mount CPU Holder	17"(432mm)	KU2C-0000-N	\$130
	Adjustable Mount CPU Holder - Locking	17"(432mm)	KU2C-0000-L	\$220

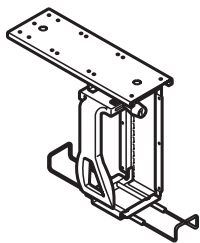

KU2C-L

Features

- Includes one adjustable mount CPU Holder with or without lock.
- Mounts under tops.
- CPU Holder mechanism 360° rotation dependent upon track location.
- Plastic side clamp with bumpers; control knob adjusts clamp.
- Adjustment Ranges:
 - Height: 13.5" to 22.5"
 - Width: 3.5" to 9.3"
 - Depth: 14.75" to 22.3"
- 17"(432mm) adjustable track with plastic glides.
- Locks cannot be retrofitted nor keyed-alike to match Haworth lock plugs or keys.
- Standard in supplier black textured paint.
- Field installed.

To Order, Specify:

- 1) Product number.
(No finish specification required.)

Specification Tips

- 85 lbs. maximum weight load.
- 17"(432mm) track fits under tops 18"(457mm) or deeper.

Tripoli — Work Tools

Jump Stuff Slat Tile Tools

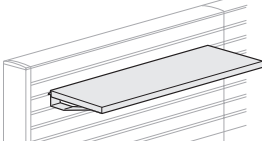
	Height	Depth	Width	Number	Price
 <p>D MSP</p>	1 3/4"(44mm)	6 1/4"(159mm)	18"(457mm)	DMSP-18	\$ 85
			24"(610mm)	DMSP-24	87
			30"(762mm)	DMSP-30	89
			36"(914mm)	DMSP-36	92
			42"(1067mm)	DMSP-42	97
			48"(1219mm)	DMSP-48	100

Features

- Includes shelf and brackets.
- Mounts on slat pad.
- Shelf thickness 3/4"(19mm)
- Designed for lightweight accessories.
- ◆ Available on RUSH.

To Order, Specify:

- 1) Product number.
- 2) Vinyl shelf color.
- 3) Trim color for bracket.

 <p>D TPT-3</p>	2 1/2"(64mm)	11 1/4"(286mm)	9"(229mm)	DTPT-3	\$65
---	--------------	----------------	-----------	--------	------

Features

- Includes phone shelf and bracket.
- Mounts on slat pad at 30° angle.
- Supports maximum of two reams (ten pounds/4.6 kilograms) of paper.
- ◆ Available on RUSH.

To Order, Specify:

- 1) Product number.
- 2) Translucent trim color.
- 3) Trim color for bracket.

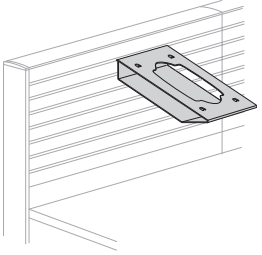
 <p>D TBS-3</p>	1 1/2"(38mm)	11"(279mm)	7 1/2"(191mm)	DTBS-3	\$40
---	--------------	------------	---------------	--------	------

Feature

- Used to convert DTPT-1 for mounting rail phone shelf to slat pad.
- ◆ Available on RUSH.

To Order, Specify:

- 1) Product number.
- 2) Trim color for bracket.

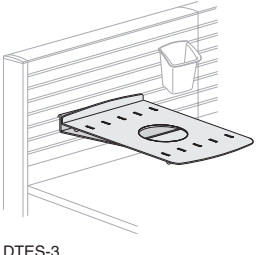
 <p>D TES-3</p>	1 3/4"(44mm)	11"(279mm)	8"(203mm)	DTES-3	\$45
---	--------------	------------	-----------	--------	------

Features

- Includes mounting bracket and personal shelf.
- Mounts on rail at 60° angle or horizontally.
- Can also be used as a horizontal freestanding tray.
- Supports maximum of two reams (ten pounds/4.6 kilograms) of paper.

To Order, Specify:

- 1) Product number.
- 2) Translucent trim color.
- 3) Trim color for bracket.

Tripoli — Work Tools

Jump Stuff Slat Tile Tools

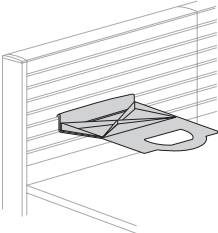
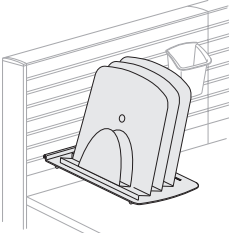
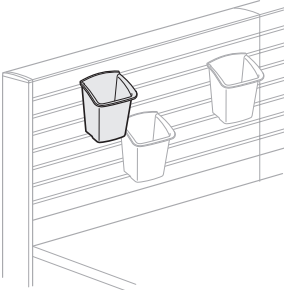
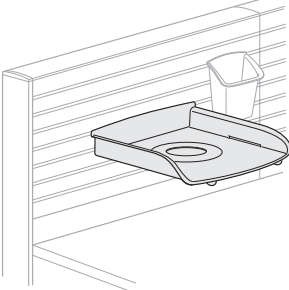
	Height	Depth	Width	Number	Price
Personal Shelf Bracket  DTAR-3				DTAR-3 ■	\$30
Feature <ul style="list-style-type: none"> Used in combination with DTPR-3 or DTES-3 for mounting rail personal shelf or paper sorter to slat pad. Available on RUSH. 				To Order, Specify: <ol style="list-style-type: none"> Product number. Translucent trim color. Trim color for bracket. 	
Paper Sorter  DTPR-3	9 1/4"(235mm)	11"(279mm)	9"-12"(229mm-305mm)	DTPR-3 ■	\$55
Features <ul style="list-style-type: none"> Includes three dividers, one shelf, and mounting bracket. Mounts on slat pad. Can also be used as a horizontal freestanding tray. Supports maximum of two reams (ten pounds/4.6 kilograms) of paper. Available on RUSH. 				To Order, Specify: <ol style="list-style-type: none"> Product number. Translucent trim color. Trim color for bracket. 	
Tool Cup  DTWC-2	5 1/2"(140mm)	3 1/2"(89mm)	4"(102mm)	DTWC-2 ■	\$17
Feature <ul style="list-style-type: none"> Mounts on rail and slat pad. Can also be used in freestanding applications. Available on RUSH. 				To Order, Specify: <ol style="list-style-type: none"> Product number. Translucent trim color. 	
Letter Tray  DTLT-2	2 1/2"(64mm)	12"(305mm)	10 1/2"(267mm)	DTLT-2 ■	\$20
Features <ul style="list-style-type: none"> Mounts on rail at 60° angle or horizontally. Mounts on slat pad horizontally. Can also be used in freestanding applications. Use Letter Tray Stacking Brackets (DTLS-2) to convert to stacking letter trays. Supports maximum of one ream (five pounds/2.3 kilograms) of paper. Available on RUSH. 				To Order, Specify: <ol style="list-style-type: none"> Product number. Translucent trim color. 	

Tripoli — Work Tools

Jump Stuff Slat Tile Tools

	Height	Depth	Width	Description	Number	Price
Waste Bin	15 1/2"(394mm)	12"(305mm)	13"(330mm)	Black	DTRB-1B	\$38
					DTRB-1	51

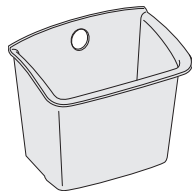

DTRB

Features

- Used in freestanding applications.
- Five gallon capacity.
- ◆ Available on RUSH.

To Order, Specify:

- 1) Product number.
- 2) Translucent trim color.

Letter Tray Stacking Kit	8"(203mm)	12"(305mm)	10 1/2"(267mm)		DTLS-2	\$52
---------------------------------	-----------	------------	----------------	--	--------	------

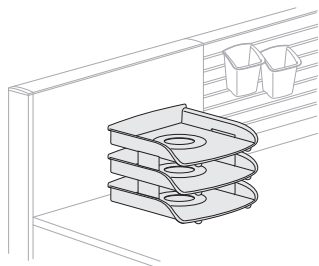

DTLS-2

Features

- Includes three letter trays and two stacking brackets.
- Used in freestanding applications.
- ◆ Available on RUSH.

To Order, Specify:

- 1) Product number.
- 2) Translucent trim color.

Letter Tray Stacking Bracket	2 1/4"(57mm)	5"(127mm)	9 1/2"(241mm)		DTSB-1	\$14
-------------------------------------	--------------	-----------	---------------	--	--------	------

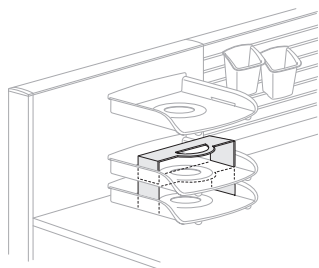

DTSB-1

Features

- Includes two stacking brackets.
- Used in freestanding applications.
- ◆ Available on RUSH.

To Order, Specify:

- 1) Product number.
- 2) Translucent trim color.

Tripoli — Work Tools

Jump Stuff Slat Tile Tools

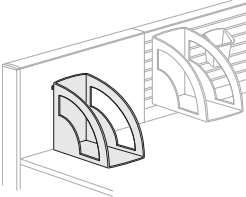
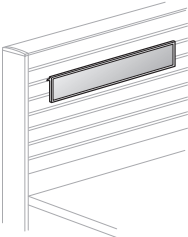
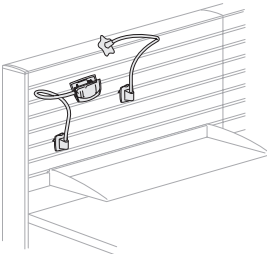
	Height	Depth	Width	Number	Price
Binder Bin  DTSB-3	12 1/2"(318mm)	10 1/2"(267mm)	6 1/2"(165mm)	DTSB-3 ■	\$41
Features <ul style="list-style-type: none"> • Mounts on slat pad. Can also be used in freestanding applications. • Bin accommodates two 3"(76mm) thick binders. ■ Available on RUSH. 					
To Order, Specify: <ol style="list-style-type: none"> 1) Product number. 2) Translucent trim color. 					
Tack Strip  DTTS-12 DTTS-24	2 1/2"(64mm)	1/2"(13mm)	12"(305mm) 24"(610mm)	DTTS-12 ■ DTTS-24 ■	\$24 29
Features <ul style="list-style-type: none"> • Mounts on slat pad. • Brown and black cork and rubber composite material. ■ Available on RUSH. 					
To Order, Specify: <ol style="list-style-type: none"> 1) Product number. 2) Trim color for bracket. 					
Gooseneck Kit  DTGK-3				DTGK-3 ■	\$52
Features <ul style="list-style-type: none"> • Includes two flex arms, two base clips, assortment of three tops (one grip clip, one round top, and one flower top) and two stick-on clips. • Mounts on slat pad to display miscellaneous notes/items or anywhere with stick-on clips. • Stick-on clips include double-sided tape. ■ Available on RUSH. 					
To Order, Specify: <ol style="list-style-type: none"> 1) Product number. 2) Translucent trim color. 					

Tripoli — Task Lighting

	Height	Depth	Width	Number	Price
Adaptable Electronic Ballast Task Light	1.375"(25mm)	4 1/4"(108mm)	24"(610mm)	LUTS-0024-16UEP	\$176
			30"(762mm)	LUTS-0030-16UEP	176
			42"(1067mm)	LUTS-0042-16UEP	192
			54"(1375mm)	LUTS-0054-16UEP	206

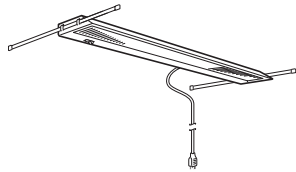

LUTS



Features

- Includes mounting brackets, black power cord, prismatic lens, low mercury content, and T-8 optic fluorescent lamp with 3500K cool temperature.
- Power cord is factory installed on right side; may be field-installed on the left-hand side.
- Six foot cord is standard. Nine foot cord is available as a specified option.
- Provides task lighting beneath shelves or overhead storage units.
- Available in charcoal only.
- **For use with 120 volt 60 hertz electrical systems only.**

Specification Tips

- **Task light under a vertical storage unit must be specified 6"(152mm) less than the vertical storage unit.**
- Task lights may not span across multiple units.
- Task lights may be adjusted front-to-back.
- If task light is less than the width of the unit to which it is attached, it may be adjusted side-to-side.
- Task light mounting brackets are included with task light.
- Not for use in daisy chain application.

To Order, Specify:

- 1) Product number.
(No finish specification required.)

Batwing Lens Specification:

To specify, replace **P** with **B** in the product number and add **\$16** list.

Example: LUTS-0030-16UEB

Chicago Specification:

To specify, replace **1** with **C** in the product number and add **\$74** list.

Example: LUTS-0030-C6UEP

Chicago Only: Plug includes 3 AMP resettable circuit breaker.

9' Cord Option:

To specify, replace **6** with **9** in the product number and add **\$32** list.

Example: LUTS-0030-19UEP

Tripoli — Task Lighting

	Height	Depth	Width	Number	Price
Adaptable Casegoods Electronic Ballast Task Light — Starter Light	1.375"(25mm)	4 1/4"(108mm)	42"(1067mm)	LUTR-0042-19UEP	\$243

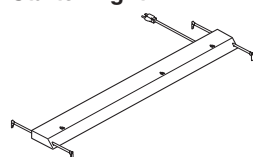

LUTR

**Features**

- Includes mounting brackets, black power cord, prismatic lens, low mercury content, and T-8 optic fluorescent lamp with 3500K cool temperature.
- Designed as starter task light for daisy chain applications.
- Power cord is factory installed on right side; may be field-installed on the left-hand side.
- Nine foot cord is standard.
- Provides task lighting beneath shelves or overhead storage units.
- Available in charcoal only.
- **For use with 120 volt 60 hertz electrical systems only.**

Specification Tips

- Task lights may be adjusted front-to-back.
- If task light is less than the width of the unit to which it is attached, it may be adjusted side-to-side.
- Task light mounting brackets are included with task light.
- A maximum of five task lights may be daisy chained together and must include a starter fixture.

To Order, Specify:

- 1) Product number.
(No finish specification required.)

Batwing Lens Specification:

To specify, replace **P** with **B** in the product number and add **\$16** list.

Example: LUTR-0042-19UEB

Adaptable Casegoods Electronic Ballast Task Light — Add-on Light	1.375"(25mm)	4 1/4"(108mm)	42"(1067mm)	LUTD-0042-11UEP	\$211
---	--------------	---------------	-------------	-----------------	-------

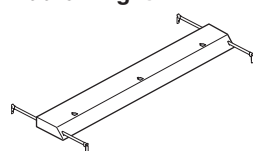

LUTD

**Features**

- Includes mounting brackets, black power cord, prismatic lens, low mercury content, and T-8 optic fluorescent lamp with 3500K cool temperature.
- Designed for daisy chain application to accommodate addition of add-on task light(s).
- Power cord is factory installed on right side; may be field-installed on the left-hand side.
- 15"(381mm) link cord is standard.
- Provides task lighting beneath shelves or overhead storage units.
- Available in charcoal only.
- **For use with 120 volt 60 hertz electrical systems only.**

Specification Tips

- Task lights may be adjusted front-to-back.
- If task light is less than the width of the unit to which it is attached, it may be adjusted side-to-side.
- Task light mounting brackets are included with task light.
- A maximum of five task lights may be daisy chained together and must include a starter fixture.
- Does not include a power plug.

To Order, Specify:

- 1) Product number.
(No finish specification required.)

Batwing Lens Specification:

To specify, replace **P** with **B** in the product number and add **\$16** list.

Example: LUTD-0042-11UEB

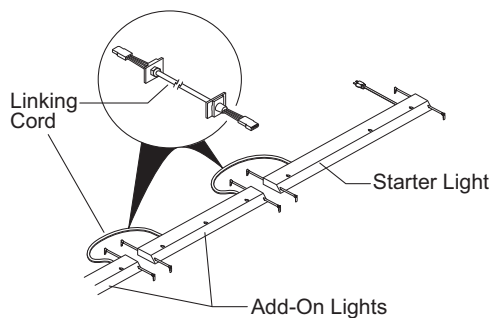

Tripoli — Task Lighting

	Base/Mount	Number	Price
LIM L	Freestanding Block	LLL1-0022-19FLC	\$525
	Freestanding Pivot	LLL2-0022-19FLC	475
	Freestanding Floor	LLL3-0022-19FLC	575
	Freestanding Add-On	LLLA-0022-19FLC	350

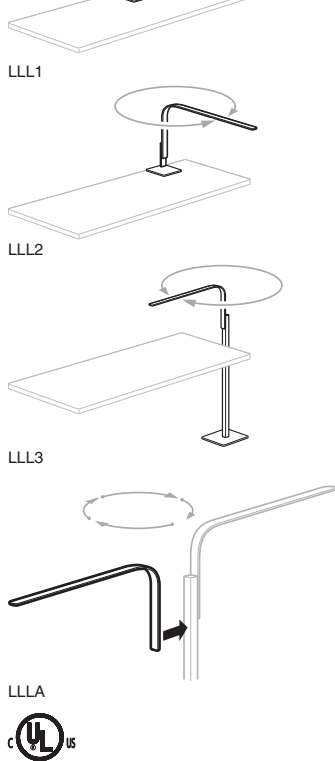







Features

- Includes base/mount, 22" arm with LED light with a clear lens, nine foot removable silvertone cord, and one wire management clip.
- Features two-stage light control with 3.0 watt and 7.3 watt selection.
- **For use with 120 volt 60 hertz electrical system.**
- Minor assembly required.
- All lights use magnets to attach to base or brackets.
- **Freestanding Block:**
 - Available in **Textured White, Textured Black and Brushed Aluminum.**
 - Arm rotates around magnetic connection between base and light arm.
 - Desk light adjustable height fixture range is 12" - 15.75" from desktop.
 - Base includes scratch-resistant bottom with cord management.
 - Can be used on any horizontal surface.
 - Freestanding block base size: 6.63"(168mm) height, 3"(76mm) width, 3.5"(89mm) depth.
- **Freestanding Pivot:**
 - Available in **Textured White and Textured Black.**
 - Desk pivot rotates 360° around the base.
 - Arm rotates around magnetic connection between base and light arm.
 - Pivot light does not have adjustable height.
 - Base includes scratch-resistant bottom.
 - Can be used on any horizontal surface.
 - Freestanding pivot base size: 5"(127mm) height, 4.5"(114mm) width, 5.5"(140mm) depth.
- **Freestanding Floor:**
 - Available in **Textured White and Textured Black.**
 - Arm rotates around magnetic connection between base and light arm.
 - Floor light adjustable height fixture range is 13" - 50.75" from floor.
 - Base includes scratch-resistant bottom.
 - Floor base size: 38"(965mm) height, 9"(229mm) width, 9"(229mm) depth.
- **Freestanding Add-On:**
 - Available in **Textured White, Textured Black and Brushed Aluminum.**

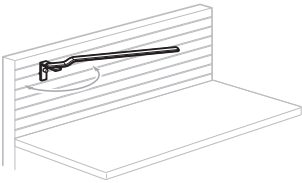
To Order, Specify:

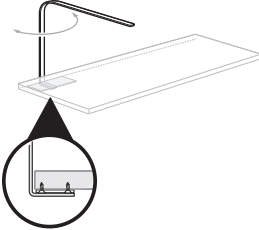
- 1) Product number.
- 2) Trim color:
Textured White TR-L2
Textured Black TR-L3
Brushed Aluminum, add \$25 list TR-L1

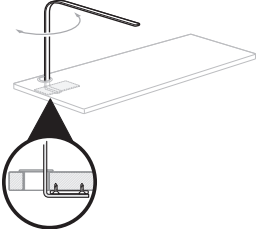
Tripoli — Task Lighting

	Base/Mount	Number	Price
 <p>LLM1</p> 	Slat	LLM1-0023-19MLC	\$375
	<p>Features</p> <ul style="list-style-type: none"> Includes base/mount, 23 1/4" arm with LED light with a clear lens, nine foot removable silvertone cord, and one wire management clip. Features two-stage light control with 3.0 watt and 7.3 watt selection. For use with 120 volt 60 hertz electrical system. Minor assembly required. All lights use magnets to attach to base or brackets. Slat: <ul style="list-style-type: none"> –Available in Textured White and Textured Black. –Rotates 180 degrees horizontally around the mount. –Slat Mount can be adjusted within the slat profiles. –Mount is scratch-resistant. –Can be used on any Haworth slat tile. –Slat Tile Bracket size: 3"(76mm) height, 1"(25mm) width, 3"(76mm) depth. Slat Mount comes with adjustable bracket and LED Light. LED Light is magnetically attached to the adjustable bracket. Magnetic attachment enables 180 degree arm rotation. Slat Mount can be adjusted within the slat profiles - hooks into the second bottom slat and can be adjusted to the top slat of the slat tiles. Arm rotates 180 degrees. Overall height ranges dependent on the mount. <p>To Order, Specify:</p> <ol style="list-style-type: none"> Product number. Trim color: <ul style="list-style-type: none"> Textured White TR-L2 Textured Black TR-L3 		
<p>LIM C</p>  <p>LLC1</p>   <p>LLC2</p> 	Worksurface Mount	LLC1-0022-19WLC	\$450
	Grommet Mount	LLC2-0022-19GLC	450
<p>Features</p> <ul style="list-style-type: none"> Includes base/mount, 22" arm with LED light with a clear lens, nine foot removable silvertone cord, and one wire management clip. Under shelf attachment bracket painted to compliment the LED light. Features two-stage light control with 3.0 watt and 7.3 watt selection. For use with 120 volt 60 hertz electrical system. Minor assembly required. All lights use magnets to attach to base or brackets. Worksurface Mount: <ul style="list-style-type: none"> – Available in Brushed Aluminum, Textured White, Textured Black. –Arm rotates at under worksurface attachment bracket. –Light does not have adjustable height. –Flat bracket is scratch-resistant. –Mount includes an 11" flat bracket. Grommet Mount: <ul style="list-style-type: none"> –Available in Brushed Aluminum, Textured White, Textured Black. –Arm rotates at under grommet attachment bracket. –Light does not have adjustable height. –Flat bracket is scratch-resistant. –Mount includes grommet configured flat brackets. <p>To Order, Specify:</p> <ol style="list-style-type: none"> Product number. Trim color: <ul style="list-style-type: none"> Textured White TR-L2 Textured Black TR-L3 Brushed Aluminum, add \$25 list TR-L1 			

Tripoli — Task Lighting

	Base/Mount	Units	Number	Price
LIM Hardware	Under Shelf Flat/Under Shelf Proud/Worksurface Bracket*	5	LLH3-0000	\$130
	Under Shelf Proud - Casegood Bracket	5	LLH4-0000	130
	Grommet Bracket	1	LLH5-0000	27
	Wire Management Clips	10	LLH6-0000	\$ 65

Features

- Hardware for use with LIM lights to provide additional attachment.
- Each bracket description correlates with the appropriate LIM light. Please use accordingly.
- For use if greater user adjustment is required.

***Same brackets used for Under Shelf Flat, Under Shelf Proud and Worksurface Mount C and Y LIM light applications.**

To Order, Specify:

- 1) Product number.
- 2) Trim color:
Textured White TR-L2
Textured Black TR-L3
Brushed Aluminum, add **\$25** list TR-L1

Tripoli — Finish Matrix

Wood Finish/Color Legend

Because of the natural properties of wood, variations of grain and finish color can be expected. Haworth carefully selects materials used in the manufacturing of products to ensure consistent and acceptable color.

Wood is susceptible to color change from exposure to UV rays. Haworth controls this by using surface finishes to reduce color change. However, change may be more evident in light-colored finishes.

Haworth wood products are available with either an EcoShield™ water-based finish or conversion varnish finish. EcoShield water-based and conversion varnish finished products are not designed to go together and are not recommended for use within the same space.

Tripoli has a water-based, UV cured EcoShield finish.

Wood Group	Veneer Type	Variety	Cutting Technique	Surface	Matching Technique	Grain Direction	Finish Name/Color	Specification Number
						Drawer/Door Front		
I								
II	Natural	Cherry	Plain Sliced	Open Pore	Book Rotate on Tops Slip Match All Other Surfaces	Vertical	Amber on Cherry	VC-CA1
							American on Cherry	VC-W23
							Classic on Cherry	VC-83
							Crown on Cherry	VC-W24
							Light Cherry	VC-W06
							Medium Cherry	VC-U
	Natural	Maple	Half-Round Cut	Open Pore	Book Rotate on Tops Slip Match All Other Surfaces	Vertical	Maple	VP-N
							Sand on Maple	VP-AD
	Natural	Oak	Plain Sliced	Open Pore	Book Rotate on Tops Slip Match All Other Surfaces	Vertical	Oak	VJ-W05
	Natural	Walnut	Plain Sliced	Open Pore	Book Rotate on Tops Slip Match All Other Surfaces	Vertical	Cordovan on Walnut	VR-W13
							Espresso on Walnut	VR-W15
							Mahogany Satin on Walnut	VR-W21
Naturally Walnut							VR-W12	
						Retro on Walnut	VR-W31	
III	Natural	Beech	Quarter Cut	Open Pore	Book Rotate on Tops Slip Match All Other Surfaces	Vertical	Beech	VT-W04
IV								

NOTE: No Price Group I or IV standard finishes are available for Tripoli.

Tripoli — Finish Matrix

	Worksurfaces	Edge Trim	Lock Plug & Grommet	Column Bases
Laminate – Solid				
Beige	H-34	HP-34		
Charcoal	H-8J	HP-8J		
Graphite	H-3J	HP-3J		
Grey Tone	H-62	HP-62		
Linen (Plaster)	H-WL	HP-WL		
Platinum (Grout)	H-3P	HP-3P		
Putty	H-AA	HP-AA		
Smoke	H-3E	HP-3E		
White Sand	H-LC	HP-LC		
Laminate – Patterned				
Barley Grain	H-AD	HP-AD		
Oats Grain	H-DA	HP-DA		
Wheat Grain	H-DE	HP-DE		
Owl Nest	H-EK	HP-EK		
Quail Nest	H-EC	HP-EC		
Rhea Nest	H-ED	HP-ED		
Robin Nest	H-EA	HP-EA		
Grey Spex	H-22	HP-22		
White Spex	H-21	HP-21		
Laminate – Wood Grain				
Amber Cherry	H-AM	HP-AM		
Maple	H-AD	HP-AD		
Medium Cherry	H-AE	HP-AE		
Laminate – Premium Wood Grain				
Brazilwood	H-KA	HP-KA		
Columbian Walnut	H-KG	HP-KG		
New Age Oak	H-KC	HP-KC		
River Cherry	H-KD	HP-KD		
Sanara	H-KE	HP-KE		
Williamsburg Cherry	H-KF	HP-KF		
Trim Colors				
Black			LR-BL	
Chrome			LR-BP	KR-V
Paint				
Beige				TR-R
Chalk				TR-AK
Charcoal				TR-K
Graphite				TR-J
Gray Tone				TR-G
Putty				TR-AA
Smoke				TR-E
Textured Paint				
Cement				TR-TY
Grout				TR-TG
Pitch				TR-TF
Plaster				TR-TW
Metallic Paint				
Champagne				TR-MC
Gunmetal				TR-MG
Silver				TR-LE

Tripoli — Fabrics/Color Legend

† Fabric pattern available on Start-it-UP at standard lead time.

- To obtain fabric samples contact your authorized Haworth dealer.
- Fabric part numbers shown in parenthesis can be used to order fabric only.

Ⓧ = Directional fabric

Ⓝ = Non-directional fabric

- Refer to the Surface Collection information on Haworth.com regarding fabric and finish availability.

Fabric Grade: A Ⓧ

HIGHLANDS

100% Recycled Polyester

L6-AG Glen
L6-AH Heather
L6-AL Loch
L6-AM Moor
L6-AP Peat
L6-AT Thatch

Fabric Grade: A Ⓧ

IOWA †

100% Recycled Polyester

FZ-10 Badger
FZ-6 Bixby
FZ-3 Bobwhite
FZ-2 Cedar Rock
FZ-11 Clear Lake
FZ-13 Emerson
FZ-7 Gar
FZ-9 Honeycreek
FZ-1 Manawa
FZ-5 Rice Lake
FZ-4 Trappers Bay
FZ-12 Walnut Woods
FZ-8 Wapello

Fabric Grade: A Ⓧ

POINT

100% Virgin Polyester

EE-0AG Compass
EE-0AC Decimal
EE-0AF Focal
EE-0AD Nib
EE-0AA Peak
EE-0AE Vertex

Fabric Grade: A Ⓧ

SAVOY †

**51% Virgin Polyester,
49% Recycled Polyester**

FJ-CC Apache
FJ-AD Balsam
FJ-AP Bisque
FJ-AE Blue Ridge
FJ-AA Blue Willow
FJ-CA Breaker
FJ-AR Chamois
FJ-AK Elephant
FJ-AL Glacier
FJ-AX Mango
FJ-AY Maya
FJ-AW Poplar
FJ-CD Raisen
FJ-AT Shallot
FJ-AM Stainless
FJ-AF Tempest

Fabric Grade: A Ⓧ

STRIAE †

100% Recycled Polyester

C1-AJ Beam
C1-AM Band
C1-AH Element
C1-AF Fillet
C1-AC Moonlight
C1-AE Ray
C1-AK Ribbon
C1-AD Straws
C1-AA Stream
C1-AL Trace

Fabric Grade: A Ⓧ

TACCATA †

100% Polyester

FL-AK Alpaca
FL-AD Confederate
FL-AH Dill
FL-AE Gherkin
FL-AP Harmonic
FL-AM Mercury
FL-AA Montego
FL-AF Morning Glory
FL-AR Opus
FL-AJ Sepia
FL-AL Smokewood
FL-AN Stone Mountain
FL-AT Timbre

Fabric Grade: A Ⓧ

TATAMI †

100% Polyester

W5-1 Agave
W5-2 Coir
W5-3 Geta
W5-4 Hemp
W5-5 Jute
W5-6 Kayar
W5-7 Kobe
W5-8 Saffron
W5-9 Sapporo
W5-10 Sisal
W5-12 Tabi
W5-11 Tesori

Fabric Grade: A Ⓝ

TELLURE

100% Polyester

3A-31 Aegean
3A-18 Black
3A-20 Burgundy
3A-40 Chocolate
3A-28 Dynamo
3A-22 Galaxy
3A-42 Geranium
3A-36 Grass
3A-35 Ivory
3A-23 Jodhpurs
3A-33 Miami
3A-19 Navy
3A-06 Nickel
3A-34 Ocean
3A-32 Sky
3A-38 Slate
3A-37 Spring
3A-39 Steel
3A-41 Sunflower
3A-43 Tomato

Fabric Grade: A Ⓧ

ZIG ZAG

100% Virgin Polyester

EF-0AA Chevron
EF-0AD Corkscrew
EF-0AC Ric Rac
EF-0AE Serpentine
EF-0AF Wiggle

Fabric Grade: B Ⓝ

BASKETWEAVE †

100% Recycled Polyester

F-7M Birch
F-6J French Blue

Fabric Grade: B Ⓧ

BISCOTTI †

100% Recycled Polyester

FN-AJ Atlantis
FN-AE Copper
FN-AW Curry
FN-AT Fig
FN-AL Fresco
FN-AX Icing
FN-AR Macaroon
FN-AF Maize
FN-AG Opal Gray
FN-AD Pesto
FN-AC Phoenician
FN-AH Sea Spray
FN-AA Shark
FN-AN Silver Ash
FN-AP Torte
FN-AM Wafer

Fabric Grade: B Ⓧ

CLASSIC

**82% Recycled Polyester,
18% Polyester**

L5-AA Musical
L5-AC Radio
L5-AD Drama
L5-AF Comedy
L5-AG Car
L5-AJ Art
L5-AH Design
L5-AS Song
L5-AT Movie

Fabric Grade: B Ⓧ

KIO †

100% Recycled Polyester

ZR-6 Bennett
ZR-8 Cascade
ZR-7 Crew
ZR-5 FUD
ZR-3 Jeanlin
ZR-1 Jib
ZR-11 Reeds Lake
ZR-13 Regatta
ZR-10 Sailor
ZR-2 Sentra
ZR-12 Smurf
ZR-9 TSJ
ZR-4 Yippi Kio

Fabric Grade: B Ⓧ

LANDSCAPE †

100% Recycled Polyester

C2-AD Estate
C2-AH Harvest
C2-AJ Panorama
C2-AF Parkland
C2-AC Photograph
C2-AE Seascape
C2-AA Vista

Fabric Grade: B Ⓝ

SENZA

100% Eco Intelligent Polyester

MBDC Technical Nutrient
R9-0AA Bare
R9-0AM Barefoot
R9-0AK Calm
R9-0AE Casual
R9-0AN Dare
R9-0AL Flirt
R9-0AF Natural
R9-0AG Surprise
R9-0AH Whisper

Fabric Grade: C Ⓧ

GLIMMER by Maharam

100% Polyester

2C-008 Acknowledge
2C-003 Allude
2C-002 Murmur
2C-007 Omen
2C-006 Reply
2C-004 Tidal
2C-005 Vibe
2C-001 Winter

Fabric Grade: C Ⓧ

MAYPOLE by Maharam

100% Polyester

2D-004 Reed
2D-003 Rush
2D-006 Sway
2D-001 Tone
2D-005 Twirl
2D-002 Waver

Tripoli — Fabrics/Color Legend

ALERT: These materials are current, however they are being considered for future obsolescence due to low volume.

Fabric Grade: A (d)

OHIO

100% Recycled Polyester

FQ-11 Blue Rock
 FQ-5 Crane Creek
 FQ-1 Dillon
 FQ-6 Erie
 FQ-9 Garfield
 FQ-4 Geneva
 FQ-2 Liberty
 FQ-7 Magee Marsh
 FQ-12 Maumee
 FQ-3 O.H. Ten
 FQ-10 Quail
 FQ-8 Sycamore

Fabric Grade: B (d)

VERONA

86% Polyester, 14% Olefin

SF-AL Argento
 SF-AP Ciao
 SF-AM Ferra
 SF-AJ Gesso
 SF-AA Lido
 SF-AR Luna
 SF-AC Mezzo
 SF-AN Piazza
 SF-AW Puzzo
 SF-AT Roma
 SF-AK Strada
 SF-AE Tosta

Fabric Grade: C (d)

POTTER

100% Recycled Polyester

W8-9 Clay
 W8-3 Coilpot
 W8-4 Earthenware
 W8-8 Glaze
 W8-10 Kick Wheel
 W8-6 Kiln
 W8-5 Slip
 W8-2 Sponge
 W8-1 Stoneware
 W8-7 Vessel

Fabric Grade: C (d)

MIRAGE

100% Recycled Polyester

C3-AF Aura
 C3-AE Dream
 C3-AC Ghost
 C3-AK Illusion
 C3-AJ Oasis
 C3-AH Pool
 C3-AD Reflection
 C3-AA Visage

Haworth+

For information on the Haworth+ alliance program, including images and product availability, please refer to: Haworth.com > Surface Collection > Haworth+ Library

Customer's Own Material (COM)

For general Customer's Own Material information including: processes and forms, please refer to: Haworth.com/surfaces > COM Section

For information on approved COM's, please refer to: Haworth.com/surfaces > COM Library

For information on Haworth+ Alliance Program, please refer to: Haworth.com/surfaces > Haworth+ Library

Tripoli — COM Yardage Requirements

Procedure

To determine if a COM fabric has been pre-approved for use on Haworth product, contact the **Haworth Inquiry Center** or <http://dNet.Haworth.com> or go to www.surfis.com.

If the fabric is approved, and the directional orientation (directional rightway, directional railroad, or non-directional) of the tested fabric has been confirmed, then refer to the appropriate column in the chart for yardage requirements.

Steps to follow to calculate fabric usage:

- 1) Identify product type and size.
- 2) Determine method in which fabric is to be cut (directional rightway, directional railroad or non-directional).
- 3) Determine fabric roll width.
- 4) Find corresponding fabric usage value from the table.
- 5) Calculate fabric required using the formula below:

Fabric usage = number of units x number of sides with fabric x fabric usage (from tables) + C (constant).

Constant

Product	C
Tackboards	1.5

- 6) Repeat steps 1-5 for each product type, size and fabric.
- 7) Add all values together to find total number of linear yards required for the order. Add the appropriate percentage shown below to the total yardage to accommodate fabric flaws, wrinkles and other imperfections.

Up to 500 yards	Add 10%
501 to 1000 yards	Add 5%
More than 1000 yards	Add 3%

Directional Rightway:

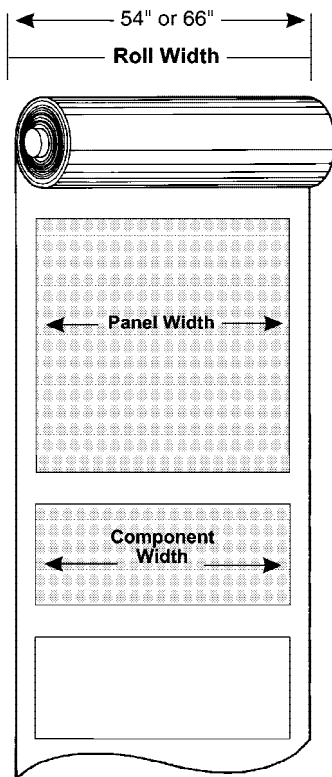

Directional Railroad:

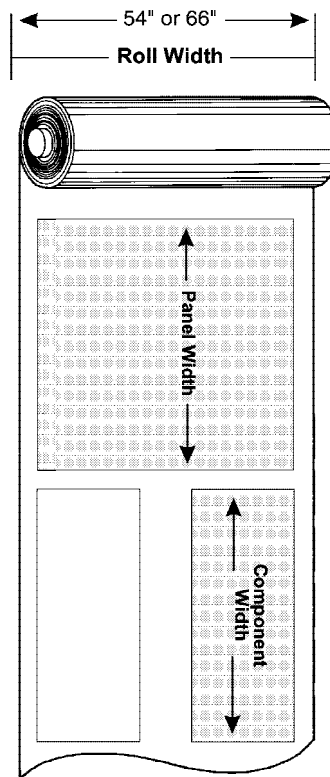

Non-Directional:

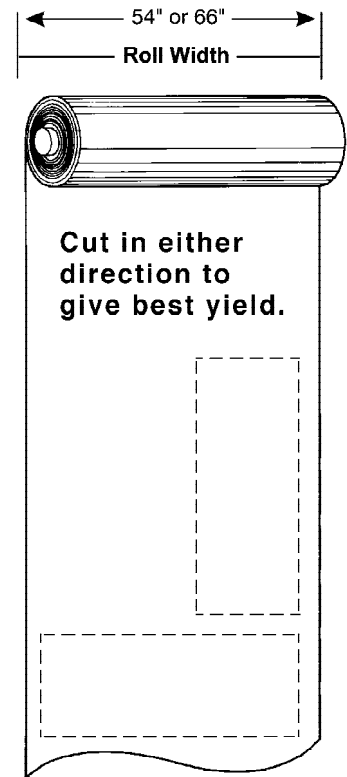

Tripoli — COM Yardage Requirements

Tripoli Tackboard Fabric Usage

Nominal (Inches)		66 Inch Roll (Linear Yards)			54 Inch Roll (Linear Yards)		
Height	Width	Directional	Railroad	Non-directional	Directional	Railroad	Non-directional
Fabric Tackboards for Vertical Storage Units							
16 15/16" _(430mm)	28" _(711mm)	0.367	0.551		0.367	0.551	
	34" _(864mm)	0.446	0.669		0.446	0.669	
	39" _(991mm)	0.512	0.767		0.512	0.767	
	45" _(1143mm)	0.590	0.885		0.590	0.885	
	51" _(1295mm)	0.669	1.004		0.669	1.004	
	57" _(1448mm)	0.748	1.122		N/A	N/A	
	63" _(1600mm)	0.826	1.240		N/A	N/A	
	69" _(1753mm)	0.905	1.358		N/A	N/A	
	75" _(1905mm)	0.984	1.476		N/A	N/A	
	81" _(2057mm)	1.063	1.594		N/A	N/A	
	87" _(2210mm)	1.141	1.712		N/A	N/A	
	93" _(2362mm)	1.220	1.830		N/A	N/A	
Fabric Tackboards with Slat Rail for Vertical Storage Units							
16 15/16" _(430mm)	28" _(711mm)	0.194	1.000		0.194	1.000	
	34" _(864mm)	0.236	1.333		0.236	1.333	
	39" _(991mm)	0.271	1.667		0.271	1.667	
	45" _(1143mm)	0.313	2.000		0.313	2.000	
	51" _(1295mm)	0.354	2.333		0.354	2.333	
	57" _(1448mm)	0.396	2.667		N/A	N/A	
	63" _(1600mm)	0.438	1.000		N/A	N/A	
	69" _(1753mm)	0.479	1.333		N/A	N/A	
	75" _(1905mm)	0.521	1.667		N/A	N/A	
	81" _(2057mm)	0.563	2.000		N/A	N/A	
	87" _(2210mm)	0.604	2.333		N/A	N/A	
	93" _(2362mm)	0.646	2.667		N/A	N/A	
Fabric Tackboards for Overhead Storage Units							
18 15/16" _(481mm)	30" _(762mm)	0.440	0.660		0.440	0.660	
	31" _(787mm)	0.454	0.682		0.454	0.682	
	36" _(914mm)	0.528	0.792		0.528	0.792	
	37" _(940mm)	0.542	0.814		0.542	0.814	
	42" _(1067mm)	0.616	0.924		0.616	0.924	
	48" _(1219mm)	0.704	1.056		0.704	1.056	
	54" _(1372mm)	0.792	1.188		N/A	N/A	
	60" _(1524mm)	0.880	1.319		N/A	N/A	
	66" _(1676mm)	0.968	1.451		N/A	N/A	
	72" _(1829mm)	1.056	1.583		N/A	N/A	
	78" _(1981mm)	1.144	1.715		N/A	N/A	
	84" _(2134mm)	1.231	1.847		N/A	N/A	
	90" _(2286mm)	1.319	1.979		N/A	N/A	
	96" _(2438mm)	1.407	2.111		N/A	N/A	

Tripoli — COM Yardage Requirements

Tripoli Tackboard Fabric Usage, (continued)

Nominal (Inches)		66 Inch Roll (Linear Yards)			54 Inch Roll (Linear Yards)		
Height	Width	Directional	Railroad	Non-directional	Directional	Railroad	Non-directional
Fabric Tackboards with Slat Rail for Overhead Storage Units							
18 15/16" _(481mm)	30" _(762mm)	0.255	0.382		0.255	0.382	
	31" _(787mm)	0.263	0.395		0.263	0.395	
	36" _(914mm)	0.306	0.458		0.306	0.458	
	37" _(940mm)	0.314	0.471		0.314	0.471	
	42" _(1067mm)	0.356	0.535		0.356	0.535	
	48" _(1219mm)	0.407	0.611		0.407	0.611	
	54" _(1372mm)	0.458	0.688		N/A	N/A	
	60" _(1524mm)	0.509	0.764		N/A	N/A	
	66" _(1676mm)	0.560	0.840		N/A	N/A	
	72" _(1829mm)	0.611	0.917		N/A	N/A	
	78" _(1981mm)	0.662	0.993		N/A	N/A	
	84" _(2134mm)	0.713	1.069		N/A	N/A	
	90" _(2286mm)	0.764	1.146		N/A	N/A	
	96" _(2438mm)	0.815	1.222		N/A	N/A	
Fabric Tackboards for Reception Stations							
12 1/2" _(318mm)	72" _(1829mm)	0.722	1.083		N/A	N/A	
	84" _(2134mm)	0.843	1.264		N/A	N/A	

Note: Tackboards over 60" (1524mm) wide are shipped in two equal pieces.

North American Terms of Sale

These Terms of Sale are part of a quotation, bid response, or other sales document issued by Haworth, Inc., Haworth, Ltd. (“Haworth”).

These Terms of Sale do not cover products manufactured in North America shipping to non-North American countries nor do they cover products manufactured in non-North American countries shipping to North America. For those terms of sale, please contact Haworth’s Global Trade and Compliance Department at 616.393.3000 or through Haworth.com.

A. Ordering Information

Haworth sells its products on the terms set forth in these standard Terms of Sale:

ORDERS MUST BE SUBMITTED IN WRITING OR ELECTRONICALLY (OrderLine) AS REPRESENTED BY A VALID PURCHASE ORDER, WHICH INCLUDES PRODUCT TOTAL.

An order is not binding upon Haworth until Haworth issues an order acknowledgment to the customer (the “Customer”), which will include price information and an anticipated shipping date.

1. Order Changes/Cancellations

For Specials, Customer’s Own Material (C.O.M.), finish matches, custom colors, custom products, Master lock and key orders, and RUSH orders, no changes or cancellations are allowed 24 hours after order placement. Standard lock orders (key schedules) cannot be changed if they fall within 2 weeks of the acknowledged ship date. All other products require approval for changes or cancellations. A change/cancellation fee may apply. Contact Order Services for applicable charges.

Ship-to addresses changed within five (5) business days of shipment will incur fees to cover administrative costs due to re-labeling of product and/or reconsignment fees with the carrier.

Order cancellations are complete annulments of orders. Order changes are the deletion of line items or a change in size, color, quantity, ship-to address, or scope of work. There is no penalty for additions; however, any change may cause the order or the line items affected to be rescheduled. Order changes involving additional product and services which increase the value must be accompanied by an amended Purchase Order or other document as agreed.

ALL CHANGES MUST BE IN WRITING, REGARDLESS OF THE (DOLLAR) VALUE. CHANGES ARE NOT BINDING UPON HAWORTH UNTIL HAWORTH ISSUES AN ACKNOWLEDGMENT OF THE CHANGE.

2. C.O.M. (Customer’s Own Material)

A Customer who requests a fabric, surface or finish material (C.O.M.) not in Haworth’s standard finish offering must first confirm

approval of or request new approval for the C.O.M.

Haworth will determine feasibility of the material for manufacturability. For a description of the procedure to submit C.O.M. samples, contact Haworth’s Order Services department. For testing information, see the C.O.M. section of the catalog, or call Haworth Order Services.

If Haworth agrees to use the C.O.M., (1) Haworth shall have no responsibility for the condition, quality, value, performance, physical properties, or any other aspect of the C.O.M.; and (2) Haworth shall have no liability for any damages, injuries, or losses to the Customer or to any third party that shall be caused by any C.O.M., and the Customer shall hold Haworth harmless for all such liability.

3. Valid/Complete Purchase Order

The following information is required in order to process an order with Haworth:

a. Customer Information

- i. **Sold To:** Legal name, complete address (if Haworth is to bill the end user, provide end user Purchase Order made out to Haworth, Inc., Haworth, Ltd.) and phone and fax number.
- ii. **Ship To:** Legal name and address.
- iii. **Purchase Order Number:** From the party Haworth will be billing.
- iv. **Authorized Signature:** All Purchase Orders must be signed by a duly authorized representative if a signature line is present. Electronically transmitted Purchase Orders will be accepted without a signature if dealer billed and the dealer has an electronic purchase payment agreement on file.
- v. **Contact Name and Phone Number:** Person Haworth should contact with any questions regarding the order.
- vi. **Shipping Contact:** Name and phone number of person to be contacted regarding shipping and delivery matters.
- vii. **Tagging Instructions:** This information will appear on all documentation received from Haworth including: cartons, acknowledgments, and invoices. Normally 1 tag is allowed per \$8,000.
- viii. **Price Agreement or National Sales Agreement Number**
- ix. **Product Total:** Net dollars.
- x. **Installation, Design, Project Management, and/or Service Fees**

b. Product Information

- i. **Quantity**
- ii. **Product Numbers**
- iii. **Colors**
- iv. **Specials:** Specify Inquiry and line number for new special products.

v. **Customer’s Own Material:** Order entry code, manufacturer, pattern, color, and who is ordering the C.O.M. fabric (Haworth, dealer or the Customer).

vi. **Approval Drawings:** An authorized signature by a duly authorized representative is required for shop drawings when applicable.

vii. A deposit may be required for custom materials.

c. Order Confirmation

All orders will be acknowledged.

B. Pricing Policies

1. Terms of Payment

Terms of payment and credit limits will be established based on financial information. Standard payment terms on open credit are net thirty (30) days from invoice date. Advance payments or other payment security may be required by Haworth. The account balance must be at or below the credit limit and current at all times (no past-due balances). Haworth reserves the right to delay or cancel any shipment to a Customer whose Haworth account balance is over the credit limit and/or past due. For walls and floors a deposit will be required.

2. Terms of Credit

Customer hereby authorizes Haworth to obtain such credit reports, financial information or other information as Haworth may request, including, without limitation, credit information from any financial institutions or others having a business relationship with the Customer. Customer hereby authorizes any credit references to answer Haworth’s inquiries and provide such credit information and documentation as Haworth may request.

The Customer hereby releases and holds Haworth harmless for any inconvenience whatsoever, caused by any temporary or permanent withdrawal or restriction of credit privileges hereunder, or the enforcement of any of the provisions contained in this paragraph.

3. Past-Due Charges

Past-due balances will be increased by a maximum of 1.5% per month, or 18% annually, without forfeit of Haworth’s right to immediate payment.

4. Applicable Prices

Prices and discounts are subject to change without notice or approval. In the event of an adjustment to pricing, National Sales Agreement (NSA) Customers will be notified in advance according to the terms of the NSA.

Applicable prices are those in effect at the time of the RECEIPT of an order; Haworth reserves the right to use the published pricing effective at the time of shipment, if the requested shipping date is more than 120 days after the order receipt date.

North American Terms of Sale

The price of any product sold to Customer by Haworth will be based upon the price for the products as follows:

<u>Destination</u>	<u>Price List ("Catalog")</u>
U.S.A.	U.S.A.
Canada	Canadian
Mexico	U.S.A.

5. Taxes

a. U.S.A.: Haworth prices do not include any sales, use or similar taxes. The Customer is responsible to remit directly to Haworth all such taxes when invoiced.

b. Canada: Prices listed in the Canadian catalogs include applicable customs duty. Prices do not include the Federal Goods and Services Tax or any provincial or other sales taxes. Any federal, provincial or other taxes or assessments based upon the sale or shipment of products or services sold applicable to the Customer at present or later imposed by federal, provincial or municipal agencies, shall be added and paid by the Customer.

c. Mexico: Prices listed in the U.S.A. catalogs do not include customs duty, value added or any other tax with respect to the sale, use, ownership, or value of any product or service provided by Haworth. Customer is responsible for all such taxes.

NOTE: For all countries a valid sales tax exemption certificate must be approved by and on file with Haworth prior to product shipment. Otherwise, sales tax will be due and payable to Haworth when such tax is invoiced to Customer.

6. Services

If, as a result of Customer request, the Haworth dealer or Haworth subsidiary provides planning/design services, storage, project management, special handling, set-up, installation and/or other services, the Customer will be charged at the local Haworth dealer/subsidiary's prevailing rates.

7. Termination by Haworth

Haworth may immediately terminate an order upon written notice in the event bankruptcy or insolvency proceedings are instituted by or against the Customer, or the Customer is adjudicated as bankrupt, becomes insolvent, makes an assignment for the benefit of creditors, or proposes or makes any arrangements for the liquidation of its debts, or a receiver or receiver and manager is appointed with respect to all or any part of the assets of the Customer.

C. Shipping and Delivery

Haworth will have the right to determine the method of shipment and routing of product.

This section does not apply to Haworth's TecCrete or TecFlor products. TecCrete and TecFlor are sold freight collect.

If, for any reason, a delivery has to be made to an intermediate location (i.e. a location other than the "Ship To" location noted on the order or ultimate end user location), all handling and re-delivery costs incurred would be at the Customer's expense.

1. U.S.A. - Contiguous

All deliveries will be F.O.B. (U.C.C./2-319) Haworth's manufacturing facilities or distribution centers. Freight charges will be prepaid by Haworth on all orders to locations within the continental United States. Customer bears all risk of loss or damage to the goods when they are placed on Haworth's means of transport.

2. U.S.A. - Non-contiguous (Alaska, Hawaii and Puerto Rico)

All deliveries will be CIF (U.C.C./2-320) (Cost of Goods, Insurance and Freight). Haworth's catalog prices include ocean freight and insurance to the port of the final destination. Haworth has the right to determine the carrier, method of shipment and routing. Haworth will contract with the insurer and provide minimal insurance coverage (CIF @ 110%) made payable to the Customer. Customer is responsible to obtain greater insurance if so desired.

Customer bears all risk of loss or damage to the goods when the goods are effectively at the disposal of the Customer on board the vessel at the named port of destination. Proof of delivery is a clean on board bill of lading. Customer will be responsible for all on-carriage from the receiving port to the final destination.

3. Canada

All deliveries will be F.O.B. Destination (U.C.C./2-319). Haworth's catalog prices include delivery to Customer's named place, not unloaded from any arriving means of transport. Customer bears all risk of loss or damage to the goods when they are delivered to the Customer's named facility not unloaded. Haworth will assume responsibility to file all freight claims with the carrier for any loss/damage which may occur while product is in transit, and will promptly repair or replace any damaged or lost product. Haworth requires the Customer to report all freight damage and/or loss to both the carrier and to Haworth.

NOTE: Under all shipping terms (U.S.A. and Canada), any additional expense resulting from Customer's request for expedited transportation, special services, packaging, handling, routing, and/or shipping method will be billed to Customer.

4. Mexico

All deliveries will be DAF (Delivered at Frontier) (ICC Incoterms 2000). Haworth's catalog prices include freight charges for normal surface transportation to a United States point of exportation within the 48 contiguous states. Haworth has the right to determine the carrier, method of shipment and routing.

Customer bears all risk of loss or damage to the goods when the goods are delivered to the named United States point of exportation. Haworth will provide customs clearance facilitation and arrangement of local delivery through an Authorized Dealer in Mexico, on a separately negotiated basis. Otherwise the Customer will be responsible for all customs clearance formalities and on-carriage from the United States point of exportation to the final destination in Mexico.

5. Ship Dates and Delay

If Haworth cannot ship products as scheduled due to causes beyond its reasonable control (such as casualty, labor disputes, or accident; inability to obtain necessary labor, material or transportation; or changes requested by the Customer), the ship date will be extended to compensate for the delay as determined by Haworth.

6. Delivery Shortages and Damage

Product shortages and damage must be noted on delivery receipts at the time of delivery and reported to the carrier for correction.

Claims against Haworth for shortages, errors, or damage must be made within three (3) days of the date of delivery or the Customer waives the right to make such a claim. Signed Bill of Ladings or Delivery Receipt must be sent in with claims.

7. Storage

Haworth may transfer product to storage at the Customer's risk and expense if the Customer is unable or unwilling to take delivery of product as originally scheduled. Upon such transfer to storage, the Customer assumes risk of loss. Haworth will invoice the Customer for storage fees and the Customer will make payments in accordance with Haworth's standard payment terms.

D. General Terms

1. Governing Law

For products purchased for delivery in the U.S. pursuant hereto, this Agreement shall be governed by and construed according to the laws of the State of Michigan. Where Products are purchased for delivery in Canada pursuant hereto, this Agreement shall be governed by and construed according to the laws of the Province of Alberta. In either case, the parties attorn to the exclusive jurisdiction of the courts of Michigan and Alberta, respectively for the purpose of hearing any disputes arising under this Agreement or with respect to any Products sold pursuant hereto, and agree that the provisions of the United Nations Convention on Contracts for the International Sale of Goods and any other provision or law which would have the effect of applying the laws of any jurisdiction other than Michigan or Alberta, as the case may be, shall be excluded.

North American Terms of Sale

2. Force Majeure

In the event that the performance of Customer or Haworth or its participating dealer assignee(s) would be prevented, restricted, interfered with or rendered commercially impracticable by reason of Force Majeure, then upon the giving of notice to the other parties, the party affected by the Force Majeure shall be excused from performing hereunder until the Force Majeure no longer prevents, restricts, interferes with, or renders such performance commercially impracticable.

“Force Majeure” shall mean: fire, explosion, breakdown of plant, epidemic, hailstorm, snow/ice storms en route, hurricane, tornado, cyclone, flood or power failure; war, revolution, civil or military disturbances, acts of public enemies, acts of terrorism, blockade or embargo; any law, order, proclamation, regulation, ordinance, demand or requirement of any applicable governmental authority or any subdivision, authority, or representative of any such government; labor difficulties, including without limitation, strikes, slowdowns, picketing or boycotts; or difficulties beyond Haworth’s reasonable control in obtaining necessary raw materials, labor, fuels and electric power, components or facilities, and any other circumstances beyond the control of the party affected.

3. Delays by Customer

Where Haworth has not received adequate site dimensions, Product specifications, shipping information, installation particulars or other information required by Haworth to permit the efficient manufacture of any Products, or where site conditions are not in accordance with the Installation Requirements set forth, or are not otherwise suitable to permit effective and efficient installation, the manufacture and/or delivery of Products may be delayed, and such event shall constitute a delay by the Customer. When manufacture, delivery or installation is delayed by the Customer or at the Customer’s request: (i) Haworth may, at its option, present the invoice for the full price of the Products to the Customer as then due and payable; (ii) the Customer shall pay to Haworth all reasonable storage, handling and other reasonable incidental expenses incurred by Haworth in connection with such delay; and (iii) the Customer shall bear all risk of loss or damage to the Products being held by Haworth for the Customer.

4. Use and Installation of Products

Haworth recommends that its products be installed by certified, qualified and approved installers according to Haworth’s written installation procedures. The Customer agrees to use Haworth products properly; not to remove or alter safety devices, warnings, or operation instructions placed on products by Haworth, and to instruct employees as to the proper care and use of the products according to printed instructions.

5. Warranty

Haworth’s standard North American Lifetime Warranty will apply as appropriate. All product line warranty specifics are available in each catalog or upon request.

E. Services

Service requests for design, installation, relocation, storage, etc. are handled by the local Haworth dealer on a separately negotiated basis. Contact the local Haworth dealer, affiliate or area sales office for more details.

Scope of Work - Design

Customer acknowledges that the Products to be manufactured or procured by Haworth in connection with the order are or may be custom manufactured for the Customer and that Haworth may be required to perform extensive work in relation to the design and specification of such Products. Where Customer requests that Haworth create as-built drawings or make more than two material revisions to any particular Product design or specification, Customer agrees that Haworth shall be entitled to invoice Customer with respect to such additional work on the basis of Haworth’s then prevailing rates for related design and specification services.

Installation Requirements

Where installation services are to be provided by Haworth, its Authorized Dealer or subcontractor, a document will be provided setting forth the scope of installation work to be performed (the “Scope of Work”) and the price to be charged therefore. Unless otherwise specified in the scope of work, Haworth’s installation services are limited to products sold by Haworth with the exception of lighting, under floor electrical and data.

General Conditions

(a) Sufficient time shall be allocated by the Customer following delivery of Products and prior to Customer’s occupation of the premises to allow the installation of all Products during conventional working hours, Monday through Friday, 7:30 a.m. to 4:30 p.m. Where sufficient time is not allocated and Haworth is required or requested to perform installation work outside of such times, overtime charges shall be charged at Haworth’s then prevailing rates. (b) Haworth shall be given free and exclusive access to: (i) a loading dock within 150’ of the freight elevator or hoist, which loading dock shall be of sufficient size to enable full-size tractor-trailer deliveries to the premises (where required by Haworth); (ii) a freight elevator or hoist of sufficient size and capacity to allow the efficient movement of the Products; (iii) an unobstructed and safe pathway to the area where Products are to be stored or staged; (iv) a secure storage / staging area; (v) convenient trash facilities; (vi) adequate lighting;

(vii) a work site that complies with applicable health and safety legislation. Where such areas and facilities are not available, Haworth shall be entitled to bill Customer for all amounts incurred by Haworth for double-handling, product movement, lifting, hoisting, trash removal and any other resulting charges. (c) The installation site shall be free and clear of existing furniture, debris, or other obstructions (including construction in progress) and shall otherwise be in the reasonable opinion of Haworth ready for installation of the Products. Any building where Products are to be installed shall be fully closed in, dry and protected from the natural elements, with temperatures between 40°F and 90°F (4°C and 32°C) and relative humidity not to exceed 70% at all times including receipt of products, during and after installation and shall be adequately heated and/or air-conditioned. Where unusual site conditions exist which impede or prevent the normal installation of any Products, applicable extra charges shall apply at prevailing rates. (d) Haworth’s installation pricing is based upon the installation occurring as one continuous delivery and installation project. Phased installation pricing shall be provided by Haworth on a case by case basis. (e) Electrical hardwiring, plumbing and mechanical work is not included and shall be the responsibility of the Customer. (f) Except as may be otherwise specifically indicated, installation pricing does not apply to projects where union labor is required. Where Haworth has provided installation pricing on the basis that non-union labor be utilized, and where Haworth is required to use union labor or it otherwise becomes impractical to use non-union labor, or where Haworth is required by law to use prevailing wages, Haworth shall be entitled to charge the Customer for any cost differential between the anticipated cost of non-union labor and the actual cost of utilizing union or prevailing wage labor. (g) Haworth shall not be responsible for obtaining permits.

Project / Site Conditions

Lateral load bracing is not included in the scope of Haworth’s work and shall not be performed by Haworth. In areas where Nexus™ or TecCrete flooring Products are to be installed by Haworth overhead construction must be completed prior to the commencement of such work to avoid damage to the panels and finishes. The existing subfloor must be smooth, mopped clean, free of moisture, dust, dirt and debris. Once installed, the access floor must be maintained in the same manner. The subfloor must have a maximum vertical elevation deviation of 0.375” (10mm) over a horizontal span of 10’-0” (3m), and without discontinuities in floor slope. For greater certainty, the scope of Haworth’s installation work in such areas shall not be deemed to include any work required to level such subfloor, remove protrusions, remove pre-existing floor coverings or adhesives, or any other work which

North American Terms of Sale

is required to remedy any conditions which may impede the efficient installation of Nexus™ flooring. Except as may be otherwise specifically indicated in the order, installation pricing for Nexus™ flooring Products and the Scope of Work in relation thereto shall not include any work required to remove and replace floor panels following their initial installation to provide tradespersons or others with access to the underpanel cable management cavity. In areas where movable walls are to be installed, all flooring (including carpeting) and ceiling components (including dropped ceiling grid components) shall be fully complete and ready for the installation of the movable wall products. Further, the existing floor (or other surface on which the movable wall panels are to be installed) shall have a maximum vertical deviation of 1.25" (30mm) and the dropped ceiling grid shall have a maximum vertical deviation of 0.375" (10mm) from the specifications to which such movable wall panels were designed and manufactured (collectively the "Permitted Tolerances"), and shall otherwise comply with any site condition assumptions made known to Haworth prior to the manufacture of such Products (the "Site Assumptions"). Where the Permitted Tolerances or Site Assumptions are not strictly adhered to or met, additional charges may be incurred in connection with site remediation and/or the modification or remanufacture of affected movable wall products, together with all resulting shipping and labor charges at Haworth's then prevailing rates for such Products and services.

Installation Change Orders

Where Customer requests work to be performed or materials to be provided which are not contemplated in the Scope of Work, or Customer otherwise requests Products or services not contemplated in the order (collectively "Extras"), prior to providing such Extras Haworth reserves the right to require the Customer to provide and sign a written Purchase Order or Change Order acceptable to Haworth describing the Extras and the amounts to be charged therefore, and the Customer agrees to pay such charges.

Entire Agreement

The order and this Agreement (including applicable Schedules) constitute the sole agreement between the parties and supercede any prior understanding or written or oral agreements between the parties (excluding National Sales Agreements). No waiver of any of the provisions of these Standard Terms and Conditions shall be binding on Haworth unless expressly agreed in writing.

Revision Date: December 1, 2009

Index

Products are listed alphabetically in this index by alpha-numeric prefix/suffix codes.

Product Code	Product Description	Page
DMSP	Tripoli — Work Tools — Mini Shelf	50
DTAR-3	Tripoli — Work Tools — Personal Shelf Bracket	51
DTBS-3	Tripoli — Work Tools — Phone Shelf Bracket	50
DTES-3	Tripoli — Work Tools — Personal Shelf	50
DTGK-3	Tripoli — Work Tools — Gooseneck Kit	53
DTLS-2	Tripoli — Work Tools — Letter Tray Stacking Kit	52
DTLT-2	Tripoli — Work Tools — Letter Tray	51
DTPR-3	Tripoli — Work Tools — Paper Sorter	51
DTPT-3	Tripoli — Work Tools — Phone Shelf	50
DTRB	Tripoli — Work Tools — Waste Bin	52
DTSB-1	Tripoli — Work Tools — Letter Tray Stacking Bracket	52
DTSB-3	Tripoli — Work Tools — Binder Bin	53
DTTS-12	Tripoli — Work Tools — Tack Strip	53
DTTS-24	Tripoli — Work Tools — Tack Strip	53
DTWC-2	Tripoli — Work Tools — Tool Cup	51
EUD1-1311V	Tripoli — Accessories — Enhanced Power Module	48
EUD1-C311V	Tripoli — Accessories — Enhanced Power Module	48
JPTA-6	Tripoli — Accessories — Pencil Tray	47
KU1C	Tripoli — Accessories — Fixed Mount CPU Holder	49
KU2C-L	Tripoli — Accessories — Adjustable CPU Holder	49
KUDP	Tripoli — Accessories — Pencil + Drawer	47
LLC1	Tripoli — Task Lighting — LIM C	57
LLC2	Tripoli — Task Lighting — LIM C	57
LLL1	Tripoli — Task Lighting — LIM L	56
LLL2	Tripoli — Task Lighting — LIM L	56
LLL3	Tripoli — Task Lighting — LIM L	56
LLLA	Tripoli — Task Lighting — LIM L	56
LLM1	Tripoli — Task Lighting — LIM Mounted	57
LUTD	Tripoli — Task Lighting — Adaptable Casegoods Electronic Ballast Task Light — Add-on Light	55
LUTR	Tripoli — Task Lighting — Adaptable Casegoods Electronic Ballast Task Light — Starter Light	55
LUTS	Tripoli — Task Lighting — Adaptable Electronic Ballast Task Light	54
TJAC-JSYC	Tripoli — Utility Carts — Laminate Top	40
TJAC-JSYG	Tripoli — Utility Carts — Laminate Top	40
TJBF-JSNNN	Tripoli — Bridges — Laminate Worksurface	14
TJBF-JSYFN	Tripoli — Bridges — Laminate Worksurface	14
TJBF-JSYNN	Tripoli — Bridges — Laminate Worksurface	14
TJBF-JSYQN	Tripoli — Bridges — Laminate Worksurface	14
TJCS-JSFT	Tripoli — Shells — Corner Shell — Laminate Worksurface	15
TJCS-JSQT	Tripoli — Shells — Corner Shell — Laminate Worksurface	15
TJDB-JSS56	Tripoli — Double Pedestal Desks — Bow Top Desk — Laminate Top	9
TJDF-JSS56	Tripoli — Double Pedestal Desks — Rectangular Top Desk — Laminate Top	8
TJF2-JSNSSS	Tripoli — Freestanding Lateral Files — Two-High — Laminate Top	37
TJF3-JSNSSS	Tripoli — Freestanding Lateral Files — Three-High — Laminate Top	37
TJH2-JSYLC	Tripoli — Freestanding Closed Storage Cabinets — Two-High Storage Cabinet with Solid Doors — Laminate Top	39
TJH2-JSYLG	Tripoli — Freestanding Closed Storage Cabinets — Two-High Storage Cabinet with Solid Doors — Laminate Top	39
TJND-JSNN	Tripoli — Attached Convergent D-Tops with Support Column — Laminate Top	11
TJNP-JSLN	Tripoli — Attached Convergent P-Tops with Support Column — Laminate Top	12
TJNP-JSRN	Tripoli — Attached Convergent P-Tops with Support Column — Laminate Top	12
TJQL-JS	Tripoli — Bookcases — Two-High and Three-High — Laminate	44
TJRS-JSYFLN	Tripoli — Returns with End Panel Support — Laminate Worksurface	16
TJRS-JSYQLN	Tripoli — Returns with End Panel Support — Laminate Worksurface	16

Index

<u>Product Code</u>	<u>Product Description</u>	<u>Page</u>
TJSB-JSS5N	Tripoli — Single Pedestal Desks – Bow Top Desk — Laminate Top	7
TJSF-JSS5N	Tripoli — Single Pedestal Desks – Rectangular Top Desk — Laminate Top	6
TJYF-JSNV	Tripoli — Desk Shells – Shell — Desk — Laminate Top	10
TJZC-JSYLS	Tripoli — Credenzas with Closed Storage — Laminate Worksurface	24
TJZF-JSYS	Tripoli — Credenza Shells — Laminate Top	26
TJZL-JSSSYS	Tripoli — Credenzas with Lateral Files — Laminate Worksurface	22
TJZP-JSS66YS	Tripoli — Credenzas with Pedestals — Laminate Worksurface	18
TJZS-JSS66YLS	Tripoli — Credenzas with Pedestals and Closed Storage — Laminate Worksurface	20
TKAC-1SYC	Tripoli — Utility Carts — Wood Top	40
TKAF-1SYG	Tripoli — Utility Carts — Wood Top	40
TKAD-S	Tripoli — Table — Occasional Drum — Wood	46
TKAR-1S	Tripoli — Table — Rectangle Occasional — Wood	46
TKAS-1S	Tripoli — Table — Square Occasional — Wood	46
TKBF-1SNNN	Tripoli — Bridges — Wood Worksurface	14
TKBF-1SYFN	Tripoli — Bridges — Wood Worksurface	14
TKBF-1SYNN	Tripoli — Bridges — Wood Worksurface	14
TKBF-1SYQN	Tripoli — Bridges — Wood Worksurface	14
TKCS-1SFT	Tripoli — Shells – Corner Shell — Wood Worksurface	15
TKCS-1SQT	Tripoli — Shells – Corner Shell — Wood Worksurface	15
TKDB-1SS56	Tripoli — Double Pedestal Desks – Bow Top Desk — Wood Top	9
TKDF-1SS56	Tripoli — Double Pedestal Desks – Rectangular Top Desk — Wood Top	8
TKES-S	Tripoli — Support Panels – End Panel	13
TKF2-1SNSSS	Tripoli — Freestanding Lateral Files – Two-High — Wood Top	37
TKF3-1SNSSS	Tripoli — Freestanding Lateral Files – Three-High — Wood Top	37
TKF4-1SNSSS	Tripoli — Freestanding Lateral Files – Four-High — Wood	38
TKFA-1NWNSS	Tripoli — Attached Lateral File	36
TKH2-1SYLC	Tripoli — Freestanding Closed Storage Cabinets – Two-High Storage Cabinet with Solid Doors — Wood Top	39
TKH2-1SYLG	Tripoli — Freestanding Closed Storage Cabinets – Two-High Storage Cabinet with Solid Doors — Wood Top	39
TKHA-1NSNL	Tripoli — Attached Closed Storage – Two-High Attached Storage Cabinet with Solid Doors	38
TKHC-1NSSL	Tripoli — Storage Cabinet — 16 1/2" Wide — Wood	42
TKHC-1NSSLR	Tripoli — Storage Cabinet — 16 1/2" Wide — Wood	42
TKJA-1NSSL	Tripoli — Attached Wardrobe Cabinet — 9 1/2" Wide — Wood	41
TKJA-1NSSLR	Tripoli — Attached Wardrobe Cabinet — 9 1/2" Wide — Wood	41
TKJC-1NSSL	Tripoli — Freestanding Wardrobe Cabinet — 31" Wide — Wood	41
TKJC-1NSSL	Tripoli — Freestanding Wardrobe Cabinet — 16 1/2" Wide — Wood	42
TKJC-1NSSLR	Tripoli — Freestanding Wardrobe Cabinet — 16 1/2" Wide — Wood	42
TKKP-S	Tripoli — Attached Pedestals – Filler Strip — Pedestal	34
TKLR-1SS56YR	Tripoli — Reception Stations – L-Shaped — Wood	32
TKM5-1NSNSSS	Tripoli — Combination Storage Cabinets – Combination Unit — Wood	43
TKND-1SNN	Tripoli — Attached Convergent D-Tops with Support Column — Wood Top	11
TKNP-1SLN	Tripoli — Attached Convergent P-Tops with Support Column — Wood Top	12
TKNP-1SRN	Tripoli — Attached Convergent P-Tops with Support Column — Wood Top	12
TKPA-1NSS	Tripoli — Attached Pedestals	34
TKPA-1NSS	Tripoli — Attached Pedestals	34
TKPM-1NSS	Tripoli — Mobile Pedestals	35
TKQL-1S	Tripoli — Bookcases – Two-High and Three-High — Wood	44
TKQL-1NS	Tripoli — Bookcases – Four-High and 64" High — Wood	45
TKRS-1SYFLN	Tripoli — Returns with End Panel Support — Wood Worksurface	17
TKRS-1SYQLN	Tripoli — Returns with End Panel Support — Wood Worksurface	17
TKSB-1SS5N	Tripoli — Single Pedestal Desks – Bow Top Desk — Wood Top	7
TKSF-1SS5N	Tripoli — Single Pedestal Desks – Rectangular Top Desk — Wood Top	6
TKTR	Tripoli — Reception Stations – Tackboards	32
TKTR	Tripoli — Reception Stations – Tackboards	33

Index

Product Code	Product Description	Page
TKUR-1SS56YR	Tripoli — Reception Stations – U-Shaped — Wood	33
TKVD-LSLS	Tripoli — Vertical Storage Units with Solid Doors	28
TKVD-LSNS	Tripoli — Vertical Storage Units with Solid Doors	28
TKVL-LSLS	Tripoli — Vertical Storage Units with Solid Doors	28
TKVL-LSNS	Tripoli — Vertical Storage Units with Solid Doors	28
TKXC-NSSL	Tripoli — Combination Storage Cabinets – Freestanding Wardrobe/ Storage Cabinet — Wood	43
TKYF-1SNV	Tripoli — Desk Shells – Shell — Desk — Wood Top	10
TKZC-1SYLS	Tripoli — Credenzas with Closed Storage — Wood Worksurface	25
TKZF-1SYS	Tripoli — Credenza Shells — Wood Top	27
TKZL-1SSSYS	Tripoli — Credenzas with Lateral Files — Wood Worksurface	23
TKZP-1SS66YS	Tripoli — Credenzas with Pedestals — Wood Worksurface	19
TKZS-1SS66YLS	Tripoli — Credenzas with Pedestals and Closed Storage — Wood Worksurface	21
TTSV	Tripoli — Tackboards for Vertical Storage Units — Fabric and Slat Rail	29
TTSW	Tripoli — Tackboards for Overhead Storage Units — Fabric and Slat Rail	31
TTVD	Tripoli — Tackboards for Vertical Storage Units — Fabric	29
TTWD	Tripoli — Tackboards for Overhead Storage Units — Fabric	31
UXAG-0002	Tripoli — Accessories – Grommet	48
UXCD-L	Tripoli — Accessories – Center Drawer	47
UXOD-LSL	Tripoli — Overhead Storage Units with Solid Doors	30
UXOD-LSN	Tripoli — Overhead Storage Units with Solid Doors	30
UXOL-LSL	Tripoli — Overhead Storage Units with Solid Doors	30
UXOL-LSN	Tripoli — Overhead Storage Units with Solid Doors	30
UXSS-S	Tripoli — Support Panels – Mid-Support Panel — Wood	13

Product Non-Obsolescence and Warranty Policy

(This North American Haworth Product Non-Obsolescence and Warranty Policy applies to products manufactured after October 31, 2010)

Haworth, Inc. or Haworth, Ltd., (each called "Haworth") will make a good faith effort to maintain product compatibility within our various generations of product platforms to provide our customers with spaces that adapt to change. Under our non-obsolescence policy, we commit to provide our customers with products of comparable function or operational characteristics for a term equal to the Applicable Warranty Period. Haworth fabrics and finishes must be updated periodically to maintain the market appeal of our products and respond to the demands and changing preferences of our customers. As a result, we or the manufacturer may discontinue some fabrics and finishes before expiration of the Applicable Warranty Period.

If a new product purchased or leased from Haworth or from an authorized Haworth dealer proves to be defective (as defined below) while the product is still in the possession of the initial purchaser or lessee and if they, within the Applicable Warranty Period, send notice of the defect to Haworth by electronic mail (ctop@haworth.com), then, except as provided below, Haworth will, at Haworth's option, either repair or replace the product, at Haworth's expense, or refund the purchase price of the product. Except as provided below, a product shall be considered "defective" if Haworth finds that it is defective in material or workmanship and if the defect materially impairs the value of the product to the purchaser or lessee. Applicable Warranty Periods are set forth below. Each Applicable Warranty Period begins on the day the product is manufactured, except that the Applicable Warranty Period for a flooring product begins when its installation is complete. If a product that the purchaser or lessee references in a notice of defect was not installed by a Haworth Certified installer and/or reconfigured by a Haworth-trained installer, then the product may not be considered defective and Haworth will not be obligated to repair or replace it or to refund its price.

ALL HAWORTH PRODUCTS ARE WARRANTED FOR 24 HOUR/7 DAYS USE EXCEPT AS NOTED*

PRODUCTS	APPLICABLE WARRANTY PERIOD
All Haworth products are warranted for except products, components and materials described below:	LIFETIME
Very and Zody Task Chair framework and mechanisms are warranted for persons up to 300 lbs for	Twelve Years
All other seating mechanisms* (excluding mechanisms in wood or wood framed chairs), electrical components, electrical accessories and fixed task lighting (excluding underfloor power), upholstery foam, seat and back mesh, seating glides and casters, stack chair frames, wall products and products that are at any time used in a classroom or educational environment (other than administrative areas) for except as limited or described below:	Ten Years
Wood or wood framed products and wood chairs including their mechanisms, gel arm caps, fabric scrims and fabrics rated (A) Heavy Duty under Association of Contract Textiles guidelines, leather, user-adjustable worksurface mechanisms, thermofused laminates, slow close mechanisms, ambient and flexible task lighting, horizontal glass or thermoplastic table assemblies and Jump Stuff products (other than Boogie Board (lifetime)) for	Five Years
Flooring products, including underfloor power (excluding factory-applied surfaces), plastic ultraviolet light color fastness and fabrics rated (a) General Contract under the Association of Contract Textiles guidelines for	Three Years
Products that are manufactured outside North America and sold into the North American market for	One to Five**
Non-standard Specials products, soft palm rest, mouse pad insert, translucent edge marring and factory-applied surfaces on flooring products for	One Year

Service parts used for warranty carry the remaining balance of the assembly's original warranty period.

*The Applicable Warranty Period for these products is single shift forty hour week. If used more than this, then the Applicable Warranty Period will be reduced in proportion to the increased usage. For example, if a chair is used an average of sixty hours per week, then the Applicable Warranty Period for the seating mechanism is six years, eight months instead of ten.

**The Applicable Warranty Period for each such product is specified in Haworth's price list for the product.

A product will not be considered to be defective, and Haworth will not repair, or replace it or refund its price if the product (1) is a consumable product, such as a lamp or light ballast; (2) is "Customer's Own Material" (i.e. material specified by the purchaser or lessee that is not a standard Haworth product offering, such as Haworth Alliance fabrics); (3) is not installed and used as recommended in Haworth's written specification, installation and user guides; (4) has been otherwise misused or suffered abusive damage or (5) is a product that is manufactured by a third-party supplier from whom Haworth purchases it for resale without incorporating it into Haworth products (in which case Haworth will assign to the purchaser or lessee any warranty that the manufacturer provides). A defect in materials or workmanship does not include damage to a product, or failure of a product to operate or perform properly or to maintain appearance, caused by (a) normal wear and tear; (b) an Act of God or transportation; (c) a product alteration made without Haworth's express written authorization; (d) the natural variation of color, grain or texture found in wood and leather; (e) the natural aging found in materials such as wood, fabric and leather which results in colors shifting during use; (f) dye lot variations in fabric, leather or wall covering or (g) the natural patina and "puddling" of leather during use.

EXCEPT AS STATED ABOVE, HAWORTH DOES NOT MAKE A WARRANTY AS TO ANY PRODUCT AND, IN PARTICULAR, DOES NOT MAKE A WARRANTY OF MERCHANTABILITY OR OF FITNESS FOR A PARTICULAR PURPOSE. Product repair or replacement or refund of the price, at Haworth's option, in accordance with this Policy, is the purchaser's or lessee's exclusive remedy for a product defect. Haworth shall not have tort liability with respect to a product, and Haworth shall not be liable for any consequential, economic, indirect, special, punitive or incidental damages arising from a product defect.

Released October 31, 2010

HAWORTH®

For more information call 800.344.2600 or 616.393.3000.

Haworth is a registered trademark of Haworth, Inc.

©Haworth, Inc. 2010 02.10 Item #1119

haworth.com | haworth-europe.com | haworth-asia.com