

CARRELS

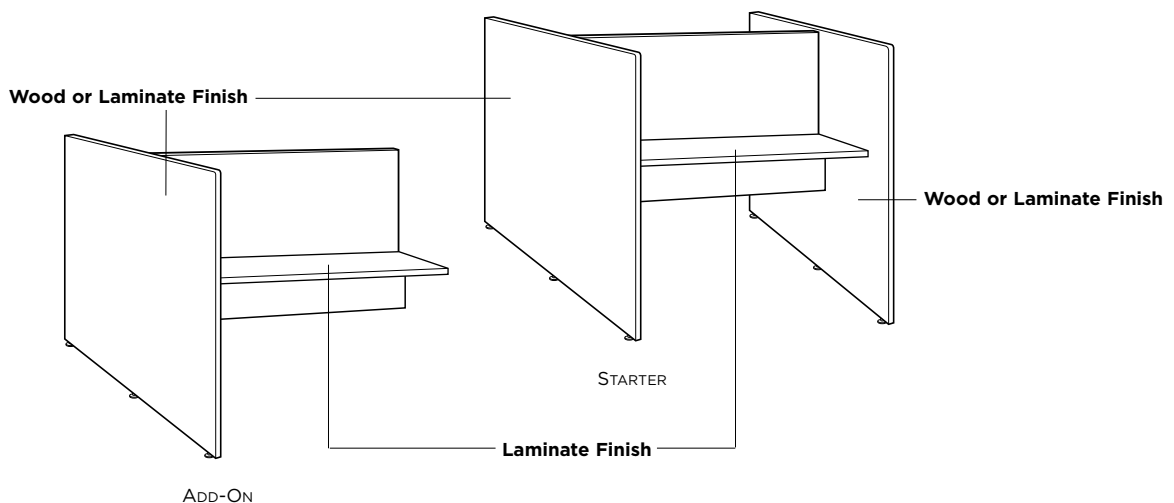

The Legacy Library System continues with the spirit of flexibility and modularity by offering Study Carrels, Computer Carrels and Patron Access Stations.

- Carrels are available in three different types for optimum patron use.
- Computer Carrels and Patron Access Stations feature convenient top-down wire management.
- Handsome end panels with durable worksurfaces ensure years of use.
- Height adjustable worksurfaces accommodate virtually any user.
- Single- or double-faced units allow for unlimited layout possibilities.
- Uses the starter/add-on system to enable space saving configurations.



SPECIFICATION INFORMATION

CARRELS

Legacy Carrels are available in both starter and add-on units in order to easily construct any length range. The Legacy Carrels are also offered in single- and double-faced configurations. Each panel has 1" leg leveling glides that screw into pre-threaded metal inserts. Sized at 48" high and 30" deep for single-faced, and 60" deep for double-faced.

Measurements for 36"W Study and Computer Carrels and Patron Access Stations:

- Each wood veneer starter unit including hardware measures 37¹/₈"W and add-on unit including hardware measures 36¹/₁₆"W.
- Each laminate starter unit including hardware measures 37³/₁₆"W and add-on unit including hardware measures 36³/₃₂"W.

Measurements for 48"W Computer Carrels:

- Each wood veneer starter unit including hardware measures 49¹/₈"W and add-on unit including hardware measures 48¹/₁₆"W.
- Each laminate starter unit including hardware measures 49³/₁₆"W and add-on unit including hardware measures 48³/₃₂"W.

Measurements for End-Of-Run Patron Access Stations:

- Each wood veneer or laminate unit including hardware measures 23"W or 27"W.

Wood Carrels:

Legacy upright panels are constructed of 1" thick, 45 lb. density, industrial grade particle board covered on both sides with veneer. Bull-nosed edge treatments are constructed using solid hardwood, FAS select or better. Single-faced panels have a ⁹/₁₆" radius top front corner and 90 degree back to fit flush against a wall. Double-faced units have a ⁹/₁₆" radius top front and back corners.

Laminate Carrels:

Legacy upright panels are constructed of 1" thick, 45 lb. density industrial grade, particle board covered on both sides with a .050" thick high-pressure laminate. Edge treatments are constructed using a 3mm T-Mold edge. Single-faced panels have a ⁹/₁₆" radius top front corner and 90 degree back to fit flush against a wall. Double-faced units have a ⁹/₁₆" radius top front and back corners.

Back Panels for Wood Carrels:

Back Panels are constructed of 1" thick, 45 lb. density, industrial grade particle board on both sides with veneer and a solid ³/₈" thick, hardwood edge treatment.

Back Panels for Laminate Carrels:

Back Panels are constructed of 1" thick, 45 lb. density industrial grade particle board on both sides with .050" thick high-pressure laminate, and a 3mm T-Mold edge.

Work Surfaces for Wood Carrels:

Work Surfaces are attached using a specially designed, 14-gauge steel bracket that allows you to set the work surface at either 26¹/₂" or 29" high. 32" high ADA heights is available. The Patron Access Station's work surface is at 39" stand up height. Work surface is 1" thick, 45 lb. density, industrial grade particle board covered with .050" thick high-pressure, laminate surface. The Computer Carrel work surface is also supported by a 9-gauge steel stiffener.

Top Dimensions:

- **Study Carrel:** 35"W x 1"H x 26"D
- **Patron Access Station:** 34"W x 1"H x 26"D
- **Computer Carrel:** 47"W x 1"H x 26"D

Work Surfaces for Laminate Carrels:

Work Surfaces are attached using a specially designed, 14-gauge steel bracket that allows you to set the work surface at either 26¹/₂" or 29" high. 32" high ADA heights is available. The Patron Access Station's work surface is at 39" stand up height. Tabletop is 1" thick, 45 lb. density industrial grade particle board covered with .050" thick high-pressure laminate surface, and a 3mm T-Mold edge. The Computer Carrel work surface is also supported by a 9-gauge steel stiffener.

Top Dimensions:

- **Study Carrel:** 35"W x 1"H x 26"D
- **Patron Access Station:** 34"W x 1"H x 26"D
- **Computer Carrel:** 47"W x 1"H x 26"D

Reference Shelf for Wood Carrels:

(standard only on the Study Carrel): Reference Shelf is 8" deep and constructed using 1" thick, industrial grade particle board and .050" thick high-pressure laminate. The solid hardwood edge banding finishes the shelf. The shelf is fixed at 5" below the top of the carrel.

Reference Shelf for Laminate Carrels:

(standard only on the Study Carrel): Reference Shelf is 8" deep and constructed using 1" thick, industrial grade particle board and .050" thick high-pressure laminate. 3mm T-Mold edge finishes the shelf. The shelf is fixed at 5" below the top of the carrel.

Cord Management:







(standard only on the Computer and Patron Access Carrels): Cord Management includes a cover, which measures 5" deep x 34³/₃₂" wide for the Patron Access Station and the 36" wide Computer Carrel or 46³/₃₂" wide for the Computer Carrel, with a flush mounted brass key lock located in the center for security. The extra large cord management tray is constructed using 18-gauge steel and measures 8³/₄" high x 4¹/₂" deep. The back brace is also made out of 18-gauge steel and has 30 degree lip for attaching a 6-outlet surge protected power strip.

Tilt Monitor Stand:

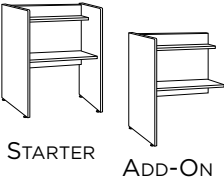
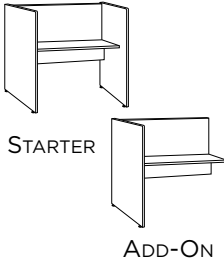
The Tilt Monitor Stand is angled 18 degrees, constructed from 14-gauge steel and has four non-skid/non-mar rubber feet. For use with single- and double-faced Patron Access Stations. Finished in durable powder paint.

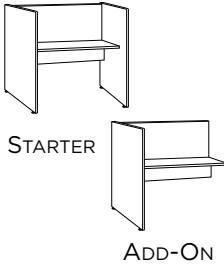
Dimensions: 20"W x 14¹¹/₁₆"D x ³/₄"H front, 5"H back

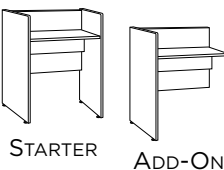
SINGLE-FACED CARRELS

PRODUCT	WOOD MODEL #	LAMINATE MODEL #	DESCRIPTION	WORK SURFACE HEIGHT
STUDY CARRELS				
 <p>STARTER ADD-ON</p>	LSSCS-__	LAMSSCS-__	30"D x 36"W x 48"H, Starter	26½" or 29"
	LSSCA-__	LAMSSCA-__	30"D x 35"W x 48"H, Add-on	26½" or 29"
	LSSC32S-__	LAMSSC32S-__	30"D x 36"W x 48"H, Starter	32"
	LSSC32A-__	LAMSSC32A-__	30"D x 35"W x 48"H, Add-on	32"
COMPUTER CARRELS				
 <p>STARTER ADD-ON</p>	LS36CCS-__	LAMS36CCS-__	30"D x 36"W x 48"H, Starter	26½" or 29"
	LS36CCA-__	LAMS36CCA-__	30"D x 35"W x 48"H, Add-on	26½" or 29"
	LS36CC32S-__	LAMS36CC32S-__	30"D x 36"W x 48"H, Starter	32"
	LS36CC32A-__	LAMS36CC32A-__	30"D x 35"W x 48"H, Add-on	32"
 <p>TIP: 36"W Computer Carrels are perfect for solo use when working with a teacher or another student is not required. Due to the narrow size, there is not much room left for additional work space after the computer is in place.</p>				
COMPUTER CARRELS				
 <p>STARTER ADD-ON</p>	LSCOS-__	LAMSCOS-__	30"D x 48"W x 48"H, Starter	26½" or 29"
	LSCOA-__	LAMSCOA-__	30"D x 47"W x 48"H, Add-on	26½" or 29"
	LSCO32S-__	LAMSCO32S-__	30"D x 48"W x 48"H, Starter	32"
	LSCO32A-__	LAMSCO32A-__	30"D x 47"W x 48"H, Add-on	32"
 <p>TIP: 48"W Computer Carrels are perfect when a patron or student needs to work with a teacher or additional person. This wide design leaves plenty of room for additional work surface.</p>				
PATRON ACCESS STATIONS				
 <p>STARTER ADD-ON</p>	LSPASS-__	LAMSPASS-__	30"D x 36"W x 48"H, Starter	39"
	LSPASA-__	LAMSPASA-__	30"D x 35"W x 48"H, Add-on	39"
END-OF-RUN STATION				
	LS23PASS-__	LAMS23PASS-__	30"D x 23"W x 48"H, for use with 10"D Double-Faced Shelving Unit	39"
	LS27PASS-__	LAMS27PASS-__	30"D x 27"W x 48"H, for use with 12"D Double-Faced Shelving Unit	39"

Bretford's Carrels come in three different styles: Study Carrels, Computer Carrels and Patron Access Stations. Each one was designed to best suit the type of work done at the unit. Study Carrels feature a shelf for placing books and study materials. Computer Carrels feature an open work space for accommodating computer equipment. Patron Access Stations are at stand-up height to provide for walk-up access.

Computer Carrels and Patron Access Stations come with a cord management bin for organizing cords and wires from computer equipment.

The End-Of-Run Patron Access Station fits perfectly at the end of 10"D or 12"D Double-Faced Shelving Units for a great walk-up station. End-Of-Run Station is only available as a stand-alone unit (no add-on unit available).

HOW TO ORDER **Wood** CARRELS:



Example: Single-Faced Wood Patron Access Station - Starter; Raven Paint; Folkstone Grey Laminate; Medium Cherry Veneer



DOUBLE-FACED CARRELS

PRODUCT	WOOD MODEL #	LAMINATE MODEL #	DESCRIPTION	WORK SURFACE HEIGHT
---------	-----------------	---------------------	-------------	---------------------------

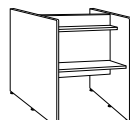
STUDY CARRELS

 STARTER  ADD-ON	LDSCS-__	LAMDSCS-__	60"D x 36"W x 48"H, Starter	26 1/2" or 29"
	LDSCA-__	LAMDSCA-__	60"D x 35"W x 48"H, Add-on	26 1/2" or 29"
	LDSC32S-__	LAMDSC32S-__	60"D x 36"W x 48"H, Starter	32"
	LDSC32A-__	LAMDSC32A-__	60"D x 35"W x 48"H, Add-on	32"

Bretford's Carrels also come in double-faced units to provide a dedicated computer area in your library. Each style of carrel is available in the double-face design.

Computer Carrels and Patron Access Stations come with a cord management bin for organizing cords and wires from computer equipment.

COMPUTER CARRELS

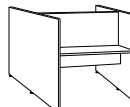
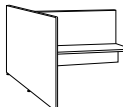
 STARTER  ADD-ON	LD36CCS-__	LAMD36CCS-__	60"D x 36"W x 48"H, Starter	26 1/2" or 29"
	LD36CCA-__	LAMD36CCA-__	60"D x 35"W x 48"H, Add-on	26 1/2" or 29"
	LD36CC32S-__	LAMD36CC32S-__	60"D x 36"W x 48"H, Starter	32"
	LD36CC32A-__	LAMD36CC32A-__	60"D x 35"W x 48"H, Add-on	32"



TIP: 36"W Computer Carrels are perfect for solo use when working with a teacher or another student is not required. Due to the narrow size, there is not much room left for additional work space after the computer is in place.

COMPUTER CARRELS

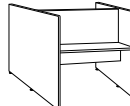
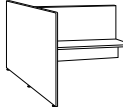
 STARTER  ADD-ON	LDCOS-__	LAMDCOS-__	60"D x 48"W x 48"H, Starter	26 1/2" or 29"
	LDCOA-__	LAMDCOA-__	60"D x 47"W x 48"H, Add-on	26 1/2" or 29"
	LDCO32S-__	LAMDCO32S-__	60"D x 48"W x 48"H, Starter	32"
	LDCO32A-__	LAMDCO32A-__	60"D x 47"W x 48"H, Add-on	32"



TIP: 48"W Computer Carrels are perfect when a patron or student needs to work with a teacher or additional person. This wide design leaves plenty of room for additional work surface.

PATRON ACCESS STATIONS

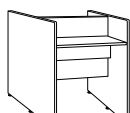
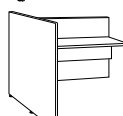
 STARTER  ADD-ON	LDPASS-__	LAMDPASS-__	60"D x 36"W x 48"H, Starter	39"
	LDPASA-__	LAMDPASA-__	60"D x 35"W x 48"H, Add-on	39"

TILT MONITOR STAND



LTMS-__ Tilt Monitor Stand

HOW TO ORDER LAMINATE CARRELS:

Example: Double-Faced 36"W Laminated Computer Carrel - Add-on; Anthracite Paint; Folkstone Grey Laminated; Anthracite Trim

LAMD36CCA AN 8Q A

Model Number Paint Color Laminated Trim