

Parley®

Table Solutions for Learning Environments



*a roll model when you need it*

The **Parley**® mobile tables can slide together to form any learning environment, then flip and nest out of the way when more space is needed.

This contemporary table line features power distribution, data routing, and is available in a variety of sizes, colors, materials and finishes. Pair the **Parley** table with one of our stack or task chairs and you'll have a dynamic solution that can be reconfigured at a moment's notice.



*be secure in your knowledge*

The **Parley**<sup>®</sup> stationary table solution is perfect for learning environments that require tables and chairs supporting computer-assisted learning. A classroom layout that requires limited reconfiguration but needs flexible capabilities is ideal for the **Parley** tables.

**Parley** stationary or mobile classroom tables are compatible with other American Seating table lines, such as **Focus**<sup>™</sup>.



*in a class of its own*

**Parley** table solutions make the grade by delivering superior ergonomic comfort, advanced technology accommodations, durable construction and long-lasting value.

**Parley** is ideal for classrooms and training rooms, media centers and learning labs, conference centers, libraries or anywhere a high technology table solution is needed.



## options for all environments



Pop-up power and data access has two power outlets and two data openings.

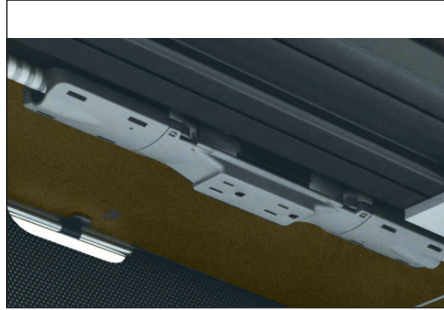

The **Parley**® table offering can provide a 4-wire/2-circuit, 20-amp power distribution system with all UL listed components.

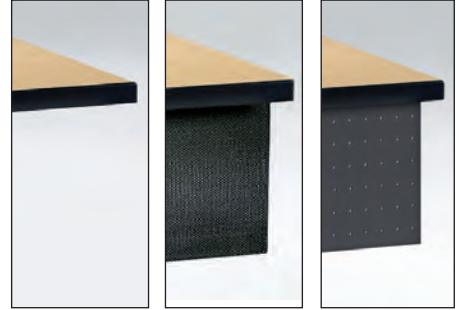

**Parley** tables are available with or without modesty panels. Full width, mesh modesty panels also available for mobile tables. Metal modesty panels available on stationary classroom tables with various perforated holes or dimple patterns.

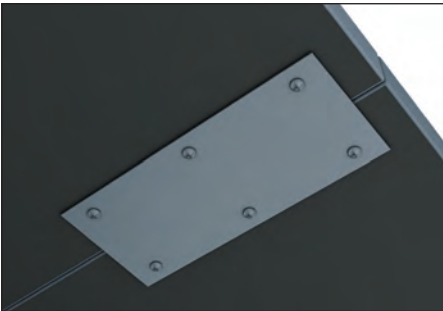

Connectors are available to join stationary tables together for secure positioning. A temporary linking device is available on mobile tables so they can be set in rows.

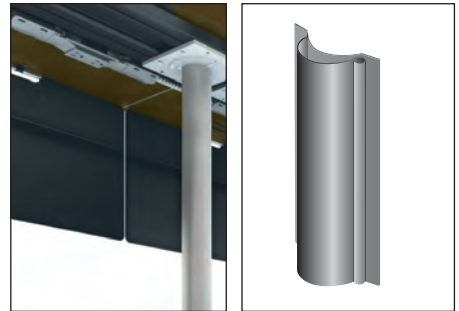

Wire management options are available for both mobile and stationary table systems – either in the mesh modesty for mobile tables, or in an attachment for both systems.



A CPU holder is available on stationary tables to support computer needs.



Manual height adjustable hand crank stationary tables are designed to meet A.D.A. requirements.



3" lockable casters are standard on the mobile tables.



An easy access flip-top release mechanism is available on the mobile table. Flip motion is away from user for enhanced safety and ergonomics.

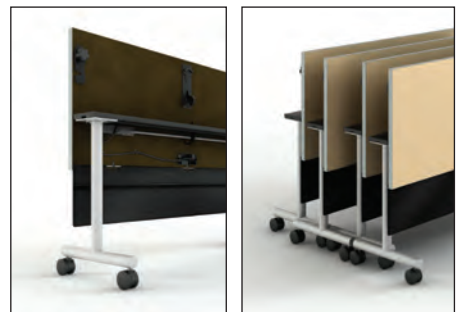

Pull the flip-top release mechanism just under the front edge of the work surface to allow the mobile table to fold up and away from the user on a full-length hinge. The modesty panel hinges separately to maintain a vertical position when in use or stored. Two tables nest within 25¼"; add 7¼" per additional table.

## Edge profiles

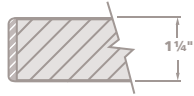

3MM  
polypropylene  
edge E

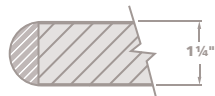

3"  
radius PVC E

## Table base colors

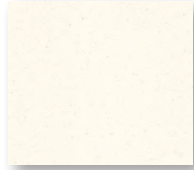

A Pearl E

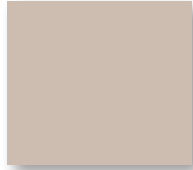

Beige E



G Grey Taupe E



W Platinum E

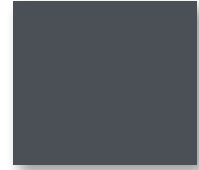

Y Steel Grey E



H Black E

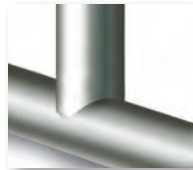

E Silver Nickel E



Chrome E\*

\* Non-standard paint colors and chrome are available at an up-charge. Please speak with your American Seating representative for pricing. See finish brochure for laminate and edge color offerings.

## Parley stationary tables

18" x 36", 42", 48", 60", 66", 72"  
20" x 36", 42", 48", 60", 66", 72"  
24" x 36", 42", 48", 60", 66", 72"  
30" x 36", 42", 48", 60", 66", 72"

## A.D.A. stationary tables

20" x 42"  
24" x 42"  
30" x 42"

## Parley mobile tables

Table surfaces are available with 18", 20", 24" and 30" deep surfaces, and can be 36", 48", 60" and 72" long.

Since 1886, American Seating has set the standard for product design, durability and comfort. Today, we remain committed to exceeding the expectations of our customers. Our achievements serve as the platform for new and innovative products that continue to be the benchmark of our industry.

 **AMERICAN SEATING**  
A History of Innovative > **SOLUTIONS**

401 American Seating Center  
Grand Rapids, MI 49504-4499  
Phone 616-732-6600 800-748-0268  
FAX 616-732-6401  
americans seating.com



 American Seating is committed to lessening our impact on the planet through responsible stewardship of our environment.

American Seating and Parley are registered trademarks of American Seating Co.  
Form No. A-PCTT-10 ©2010 American Seating Company Litho in USA



This is printed on FSC certified paper.