

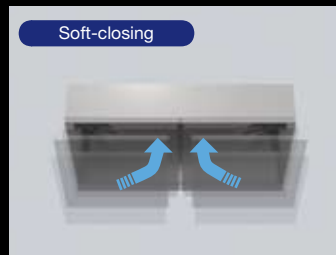

MonoFlat LIN-X hinge™

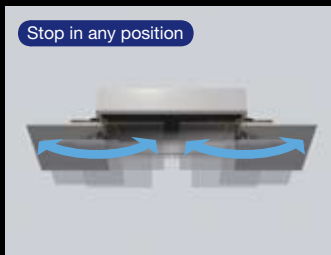

MONOFLAT LIN-X HINGE PAT

LIN-X450 / LIN-X600

Item No.	LIN-X450	LIN-X600
Door Width	400 ~ 500mm (15-3/4" ~ 19-11/16")	550 ~ 650mm (21-21/32" ~ 25-19/32")
Door Height	600 ~ 2400mm (23-5/8" ~ 94-1/2")	
Door Thickness	15~24mm (19/32" ~ 61/64")	
Door Weight	*Max 17kg (37.4lbs)	*Max 24kg (52.8lbs)

*Max door weight will vary depending on number of hinges used.

- **Lateral Swing Mechanism**
Allows doors to swing out laterally in a small radius, ideal for tight front space application.
- **Full Access to Cabinet**
Door will not get in the way when fully opened providing full access to the cabinet.
- **Free Swing & Soft-close**
- **Easy Installation**
Designed for standard 32 system mounting, with snap-on hinge.
- **4-Way Adjustable**
3-way adjustable like concealed hinges and also with parallel adjustment.
- **Various Applications**
Can be used in single or double door configuration. Ideal for cabinets in kitchen, bathroom, laundry room etc.
*For overlay use.

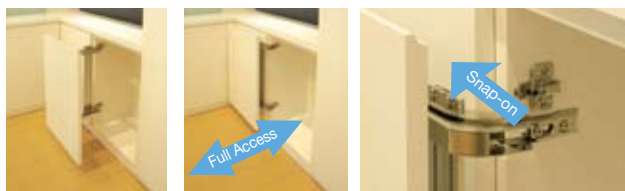

• Easy access full opening
Ideal for wall / base cabinet, corner use etc.

• Easy installation

Lateral Swing Mechanism

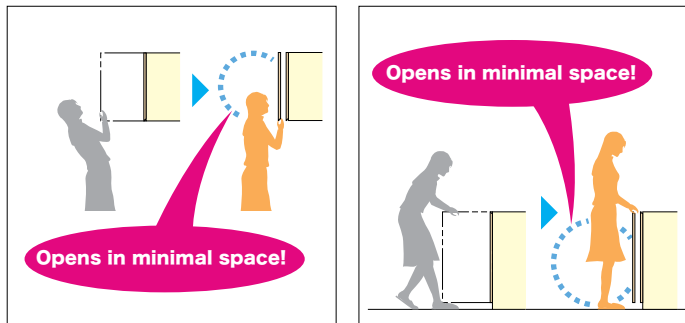

Ideal for tight front space application

Can be Opened from Various Points

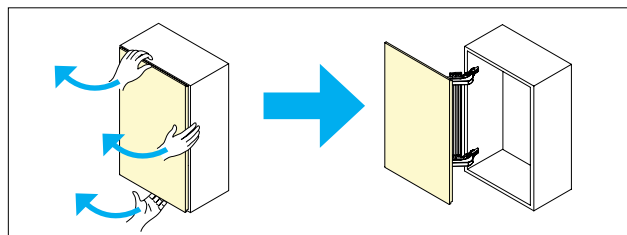

Please note handle position before installation.
Handle may interfere with hinge.

4Way Adjustment

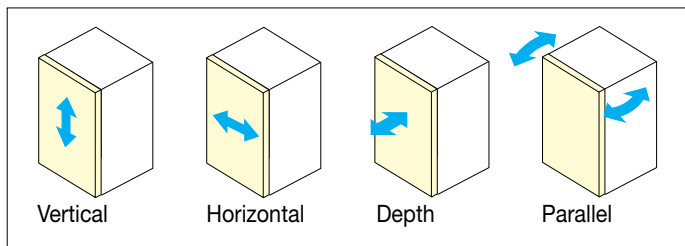

Various Applications

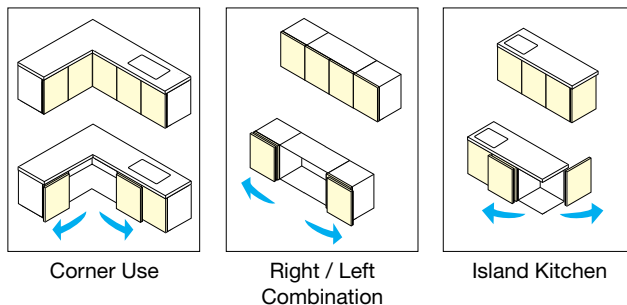

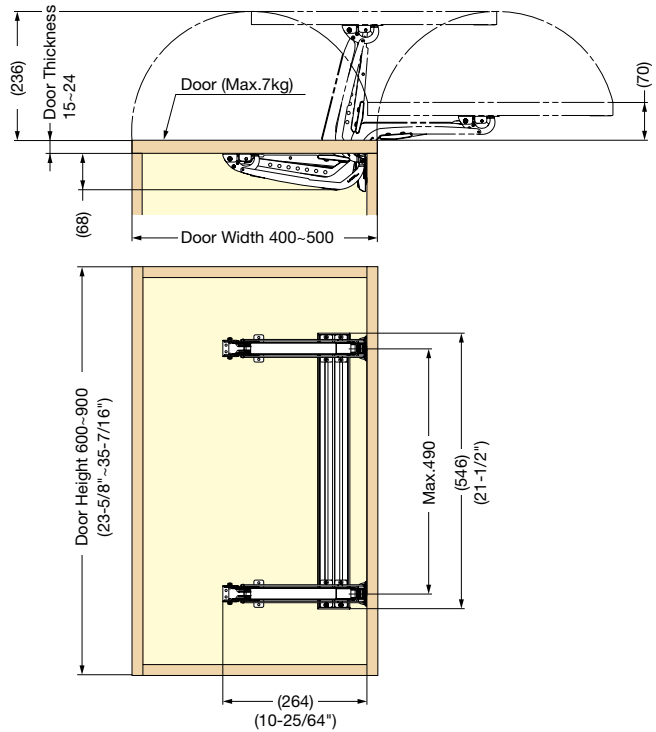
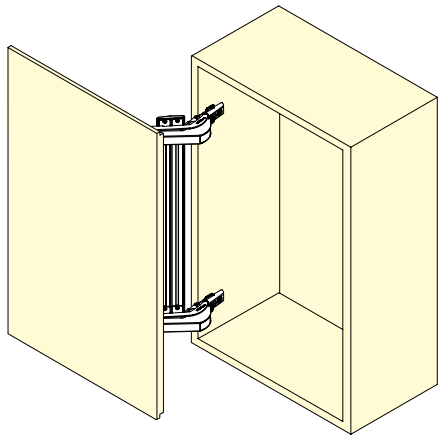

Door Width	400 ~ 500mm (15-3/4" ~ 19-11/16")
Door Height	600 ~ 900mm (23-5/8" ~ 35-7/16")
Door Thickness	15 ~ 24mm (19/32" ~ 61/64")
Door Weight	Max. 7kg (15.4lbs) / Door

*Can be used on heavier / taller doors by adding hinge arms.
Please see page 12 for details.

Item No.	Overlay	Material	Finish
LIN-X450	19mm (3/4")	Steel / Aluminum	Nickel / Anodized
LIN-X450+5	14mm (35/64")		



- *Parts included: •Hinge Body: 2pcs •Connecting Bar: 1pc
•Mounting plate: 2pcs •Cover Cap: 2pcs



■ LIN-X450 PAT Individual Parts for Tall / Heavy Doors

Door Width	400 ~ 500mm (15-3/4" ~ 19-11/16")
Door Height	600 ~ 2400mm (23-5/8" ~ 94-1/2")
Door Thickness	15 ~ 24mm (19/32" ~ 61/64")
Door Weight	Max. 17kg (37.4lbs)

Ordering Info

Use corresponding letter in below table, and see "Parts Breakdown Table" for parts to be ordered.

Door Height	Door Weight				Connecting Bar / Cover Cap
	~ 15.5lbs (~ 7.0kg)	15.6 ~ 23.0lbs (7.1 ~ 10.5kg)	23.1 ~ 31lbs (10.6 ~ 14.0kg)	31.1 ~ 37.4lbs (14.1 ~ 17.0kg)	
23-5/8" ~ 35-7/16" (600 ~ 900mm)	LIN-X450 Standard Set Connecting Bar & Cover included	B			LIN-X450-L540 1pc LIN-X450C 2pcs
35-7/16" ~ 47-1/4" (901 ~ 1200mm)	A	B	C		LIN-X450-L840 1pc LIN-X450C 2pcs
47-1/4" ~ 59-3/64" (1201 ~ 1500mm)	A	B	C	D	LIN-X450-L1140 1pc LIN-X450C 2pcs
59-3/64" ~ 70-7/8" (1501 ~ 1800mm)	B	B	C	D	LIN-X450-L1140 1pc LIN-X450C 2pcs
70-7/8" ~ 82-11/16" (1801 ~ 2100mm)	B	B	C	D	LIN-X450-L1740 1pc LIN-X450C 2pcs
82-11/16" ~ 94-1/2" (2101 ~ 2400mm)	C	C	C	D	LIN-X450-L2040 1pc LIN-X450C 2pcs

Parts Breakdown Table

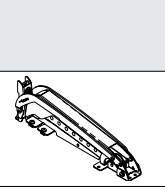
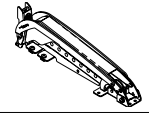
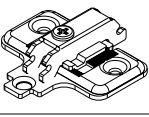
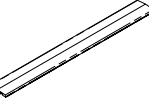
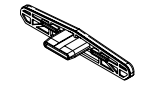
Item Number	Description		Qty Required			
			A	B	C	D
LIN-X450ACD	Single Arm (with Damper)		2	3	3	3
LIN-X450A	Single Arm (without Damper)		-	-	1	2
230-P4W-32T (for 19mm overlay) or 230-P4W-32T+5 (for 14mm overlay)	Mounting Plate		2	3	4	5
LIN-X450-L540	Connecting Bar L=540MM		See table above			
LIN-X450-L840	Connecting Bar L=840MM					
LIN-X450-L1140	Connecting Bar L=1140MM					
LIN-X450-L1440	Connecting Bar L=1440MM					
LIN-X450-L1740	Connecting Bar L=1740MM					
LIN-X450-L2040	Connecting Bar L=2040MM					
LIN-X450C	End Cap for Connecting Bar		See table above			

Example: 36"H×18"W, 16lbs door. Item number and quantity required.

LIN-X450ACD 3pcs
 230-P4W-32T 3pcs
 LIN-X450-L840 1pcs
 LIN-X450C 2pcs

■ Door Preparation

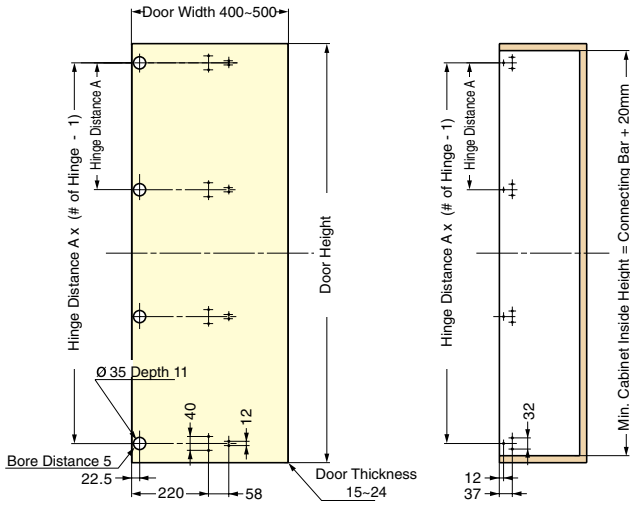

Hinge in middle should be positioned at or equally distributed from center of door.

■ Cabinet Preparation

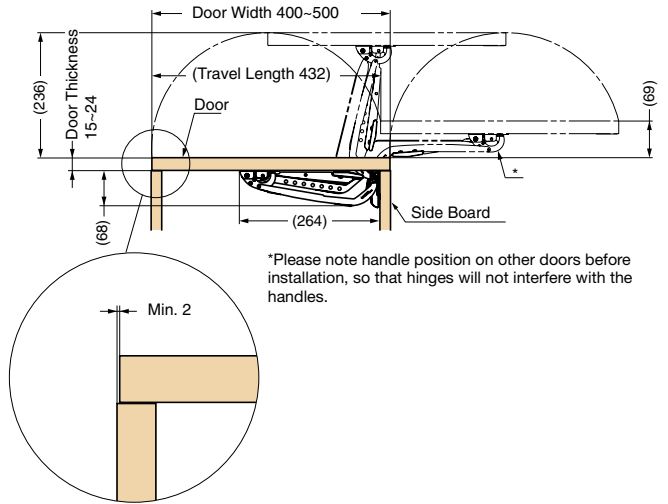

■ Hinge Distance A

# of Hinges	Length of Connecting Bar (mm)					
	540	840	1140	1440	1740	2040
2 pcs	490	790	1090	-	-	-
3 pcs	245	395	545	695	845	-
4 pcs	-	263.3	363.3	463.3	563.3	663.3
5 pcs	-	-	272.5	347.5	422.5	497.5

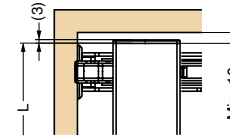

■ Hinge Arm

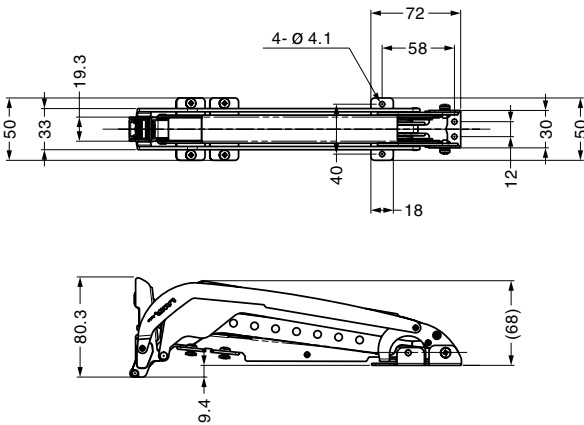

■ Mounting Plate (230-P4W-32T)

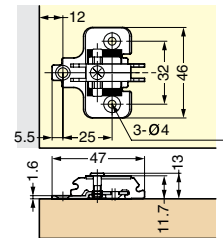

■ Connecting Bar

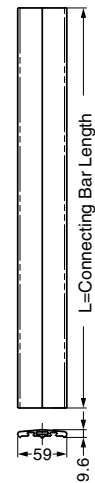

■ Cup Cover

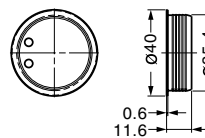

■ Bar End Cap

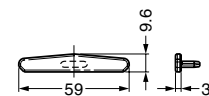

MONOFLAT LIN-X 600

In case of using 4 hinge arms.

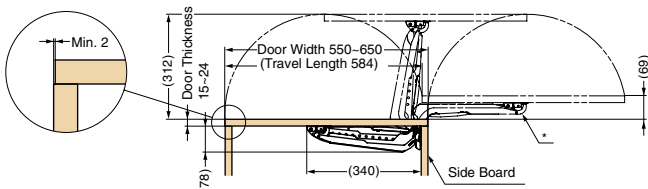
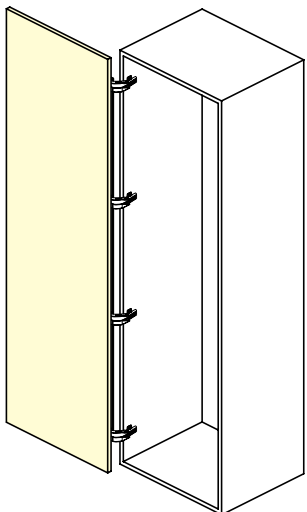

Please note handle position on other doors before installation, so that hinges will not interfere with the handles.

Door Width	550 ~ 650mm (21-21/32" ~ 25-19/32")
Door Height	600 ~ 2400mm (23-5/8" ~ 94-1/2")
Door Thickness	15 ~ 24mm (19/32 ~ 61/64")
Door Weight	MAX. 24kg (52.8lbs)

*Max door weight will vary depending on number of hinges used.

- **Lateral Swing Mechanism**
Allows doors to swing out laterally in a small radius, ideal for tight front space application.
- **Full Access to Cabinet**
Door will not get in the way when fully opened providing full access to the cabinet.
- **Free Swing & Soft-close**
- **Easy Installation**
Designed for standard 32 system mounting, with snap-on hinge.
- **4-Way Adjustable**
3-way adjustable like concealed hinges and also with parallel adjustment.
- **Various Applications**
Can be used in single or double door configuration. Ideal for cabinets in kitchen, bathroom, laundry room etc.
*For overlay use.

LIN-X600 PAT Basic Standard Kit

Door Width	550 ~ 650mm (21-21/32" ~ 25-19/32")
Door Height	600 ~ 900mm (23-5/8" ~ 35-7/16")
Door Thickness	15 ~ 24mm (19/32 ~ 61/64")
Door Weight	MAX. 9kg (19.8lbs)

Item No.	Overlay	Material	Finish
LIN-X600	19mm (3/4")	Steel, Aluminum	Nickel, Anodized

Included Parts: 2 each of Hinge Arms, Mounting Plates, Cup Covers, Bar End Caps and 1 Connecting Bar.

■ Hinge Arm

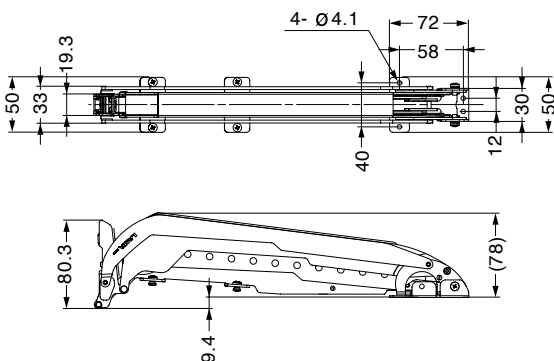

■ Mounting Plate (230-P4W-32T)

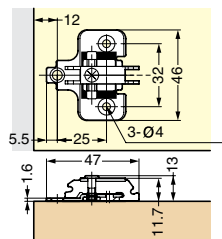

■ Connecting Bar

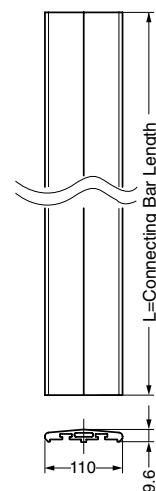

■ Cup Cover

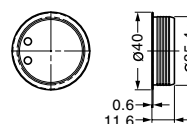

■ Bar End Cap

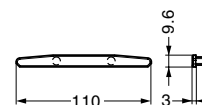

LIN-X600 PAT Individual Parts for Tall / Heavy Doors

Door Width	550 ~ 650mm (21-21/32" ~ 25-19/32")
Door Height	600 ~ 2400mm (23-5/8" ~ 94-1/2")
Door Thickness	15 ~ 24mm (19/32" ~ 61/64")
Door Weight	Max. 24kg (52.8lbs)

Ordering Info

Use corresponding letter in below table, and see "Parts Breakdown Table" for parts to be ordered.

Door Height	Door Weight					Connecting Bar / Cover Cap
	~ 19.9lbs (~ 9.0kg)	20.0 ~ 26.5lbs (9.1 ~ 12.0kg)	26.6 ~ 35.4lbs (12.1 ~ 16.0kg)	35.5 ~ 44.2lbs (16.1 ~ 20.0kg)	44.3 ~ 52.8lbs (20.1 ~ 24.0kg)	
23-5/8" ~ 35-7/16" (600 ~ 900mm)	LIN-X600 Standard Set Connecting Bar & Cover included	B				LIN-X60-L540 1pc LIN-X60C 2pcs
35-7/16" ~ 47-1/4" (901 ~ 1200mm)		B	B			LIN-X60-L840 1pc LIN-X60C 2pcs
47-1/4" ~ 59-3/64" (1201 ~ 1500mm)		B	B	C		LIN-X60-L1140 1pc LIN-X60C 2pcs
59-3/64" ~ 70-7/8" (1501 ~ 1800mm)		B	B	C	D	LIN-X60-L1140 1pc LIN-X60C 2pcs
70-7/8" ~ 82-11/16" (1801 ~ 2100mm)		B	B	C	D	LIN-X60-L1740 1pc LIN-X60C 2pcs
82-11/16" ~ 94-1/2" (2101 ~ 2400mm)			C	C	D	LIN-X60-L2040 1pc LIN-X60C 2pcs

Parts Breakdown Table

Item Number	Description	Image	Qty Required			
			A	B	C	D
LIN-X600ACD	Single Arm (with Damper)		2	3	3	3
LIN-X600A	Single Arm (without Damper)		-	-	1	2
230-P4W-32T (for 19mm overlay)	Mounting Plate		2	3	4	5
LIN-X60-L540	Connecting Bar L=540MM		See table above			
LIN-X60-L840	Connecting Bar L=840MM					
LIN-X60-L1140	Connecting Bar L=1140MM					
LIN-X60-L1440	Connecting Bar L=1440MM					
LIN-X60-L1740	Connecting Bar L=1740MM					
LIN-X60-L2040	Connecting Bar L=2040MM					
LIN-X60C	End Cap for Connecting Bar		See table above			

Door Preparation

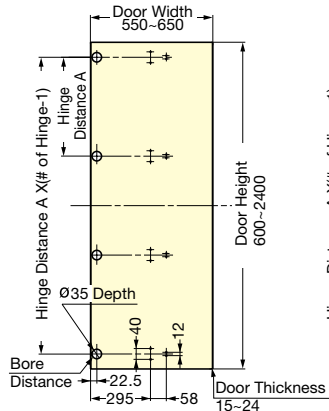

Cabinet Preparation

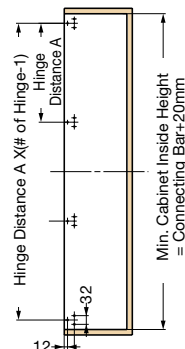

Hinge Distance A

# of Hinges	Length of Connecting Bar (mm)					
	540	840	1140	1440	1740	2040
2 pcs	490	790	-	-	-	-
3 pcs	245	395	545	695	845	-
4 pcs	-	-	363.3	463.3	563.3	663.3
5 pcs	-	-	-	347.5	422.5	497.5