



Multiple Motion Door System

MultiMo FLAT®

MULTIPLE MOTION DOOR SYSTEM (For Wooden Doors) PAT

MFS-W

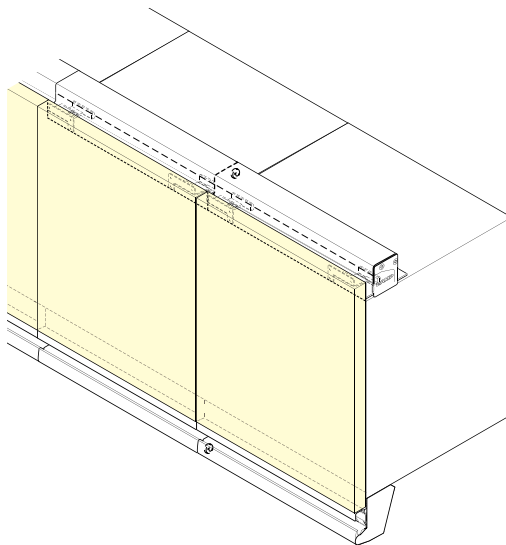

Door Width	297mm, 447mm, 597mm or 897mm (11-11/16", 17-5/8", 23-1/2" or 35-5/16")
Door Height	300 ~ 900mm (11-13/16" ~ 35-7/16")
Door Thickness	15 ~ 23mm (19/32" ~ 29/32")
Door Weight	2 ~ 8kg (4.4 ~ 17.6lbs) / Door

- **Flush Door Surface**
All doors will be "flush" against others when in closed position. Provides sleek appearance compared to ordinary off-set sliding doors.
 - **Interchangeable Door Position**
Opened doors can slide and close at any unoccupied position.
 - **Multiple Doors in One Line**
Multiple doors can be added by connecting multiple sliding units.
 - **Soft & Smooth Movement**
Equipped with damper for soft and smooth closing movement.
 - **Minimal Hardware Space**
Ideal for shallow cabinets, hardware requires only 100mm (approx. 4") of depths.
- *Recommended using on 3 or more doors for interchangeable door feature.
*Minimum door height is twice of door width.
*Please see page 6 for glass door version.
(Cannot be used together with glass version on one cabinet.)

Interchangeable Door Position (3 doors or more)

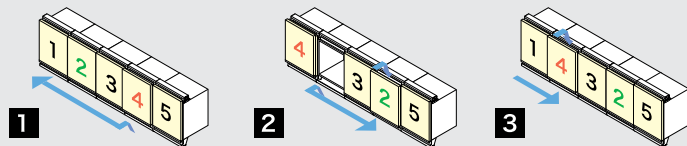

Door Opening Example

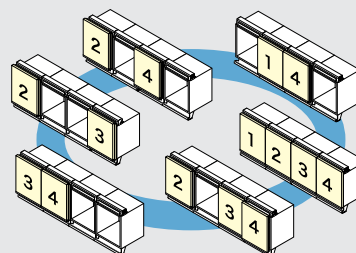

Provides various opening patterns. By adding more doors, the more opening patterns will be possible.

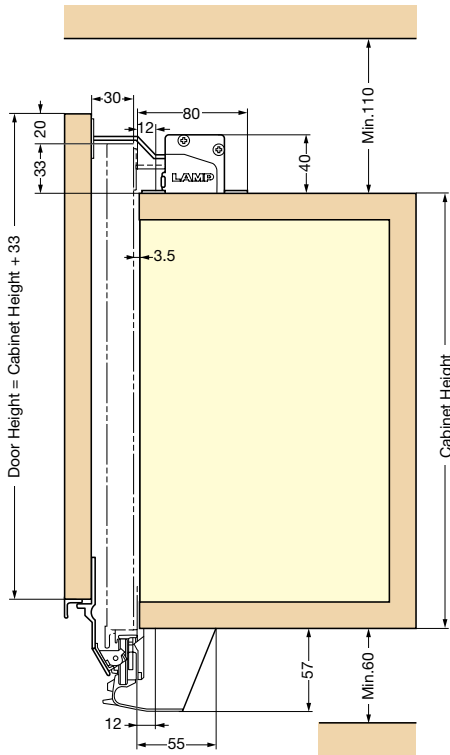

•Door Width 297mm, 447mm

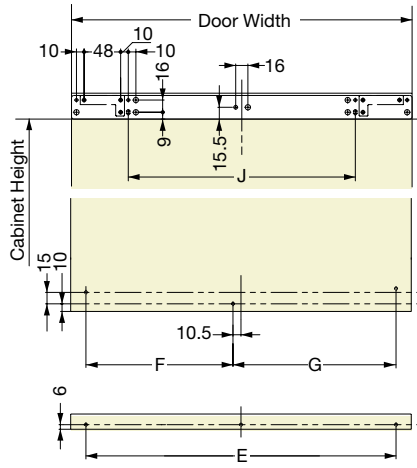

•Door Width 597mm, 897mm

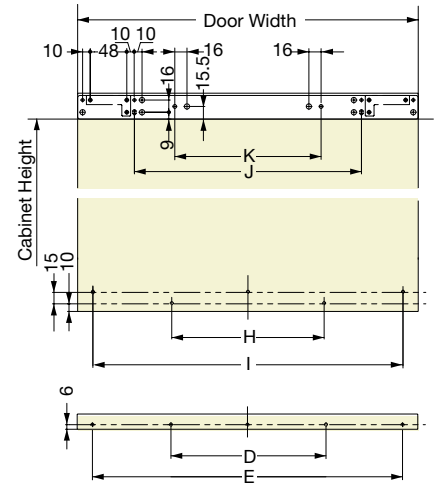

Door Width	D	E	F	G	H	I	J	K
297	-	257	118	139	-	-	148	-
447	-	407	193	214	-	-	298	-
597	278.5	557	-	-	300	557	448	200
897	428.5	857	-	-	400	857	748	300

•Top Panel

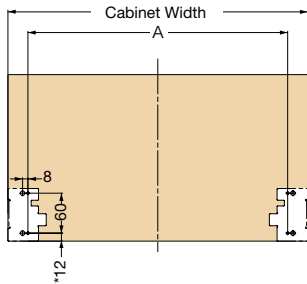

Cabinet Width	A
300	240
450	390
600	540
900	840

•Bottom Panel (Cabinet Width 300mm, 450mm)

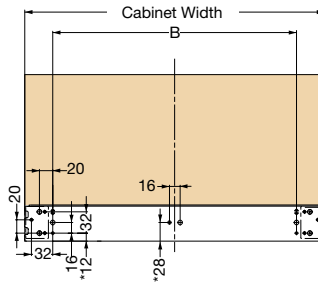

Cabinet Width	B
300	216
450	366

•Bottom Panel (Cabinet Width 600mm, 900mm)

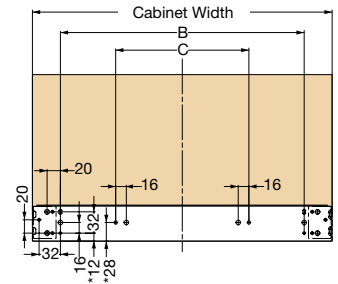

Cabinet Width	B	C
600	516	200
900	816	300

* When using gaskets on cabinet thicker than 3mm, subtract "gasket thickness - 3mm" from the * marked dimensions.

Item No.	Each Cabinet Width	Door Width	Door Weight / Door
MFS-W300/S2	300mm (11-13/16")	297mm (11-11/16")	2~3kg (4.4 ~ 6.6lbs)
MFS-W450/S2	450mm (17-23/32")	447mm (17-5/8")	2~3kg (4.4 ~ 6.6lbs)
MFS-W450/S3	450mm (17-23/32")	447mm (17-5/8")	3~4kg (6.6 ~ 8.8lbs)
MFS-W600/S3	600mm (23-5/8")	597mm (23-1/2")	3~4kg (6.6 ~ 8.8lbs)
MFS-W600/S4	600mm (23-5/8")	597mm (23-1/2")	4~5kg (8.8 ~11.0lbs)
MFS-W600/S5	600mm (23-5/8")	597mm (23-1/2")	5~6kg (11.0 ~13.2lbs)
MFS-W900/S5	900mm (35-7/16")	897mm (35-5/16")	5~6kg (11.0 ~13.2lbs)
MFS-W900/S6	900mm (35-7/16")	897mm (35-5/16")	6~7kg (13.2 ~15.4lbs)
MFS-W900/S7	900mm (35-7/16")	897mm (35-5/16")	7~8kg (15.4 ~17.6lbs)

Item No.	Description
MFS-ED	End Cap Set*

*1 pair of MFS-ED required per cabinet, not per door

MFS-W Ordering Info:

Designed for cabinet with minimum 2 doors. Each set contains hardware for one door only. To order, please reference the total cabinet width, the number of doors that will be in the cabinet, and the set required (MFS-W_ _ _ /S_), for example:
1 cabinet 94" wide w/ 4 doors (23 1/2" ea, 12lbs./door), order as MFS-W600/S5 qty 4 each MFS-ED qty 1 pair



Multiple Motion Door System

MultiMo FLAT[®]



MULTIPLE MOTION DOOR SYSTEM (For Glass Doors) PAT

MFS-G

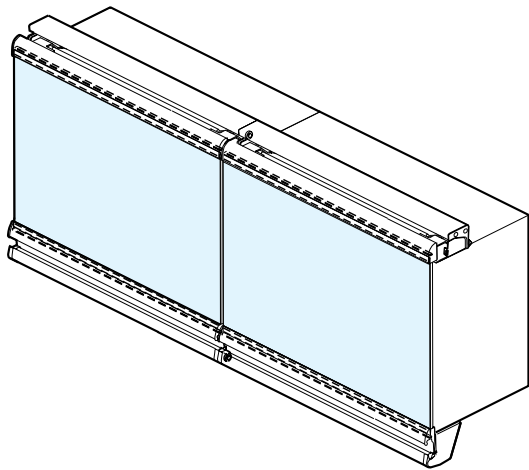

Door Width	295mm, 445mm, 595mm or 895mm (11-5/8", 17-1/2", 23-7/16" or 35-1/4")
Door Height	300 ~ 900mm (11-13/16" ~ 35-7/16")
Door Thickness	5mm (13/64")
Door Weight	1.3 ~ 6.7kg (2.9 ~ 14.7lbs) / Glass

- **Flush Door Surface**
All doors will be "flush" against others when in closed position. Provides sleek appearance compared to ordinary off-set sliding doors.
- **Interchangeable Door Position**
Opened doors can slide and close at any unoccupied position.
- **Multiple Doors in One Line**
Multiple doors can be added by connecting multiple sliding units.
- **Soft & Smooth Movement**
Equipped with damper for soft and smooth closing movement.
- **Minimal Hardware Space**
Ideal for shallow cabinets, hardware requires only 100mm (approx. 4") of depths.

*Recommended using on 3 or more doors for interchangeable door feature.

*Maximum door height is twice of door width.

*Please see page 4 for wooden door version.

(Cannot be used together with wooden version on one cabinet.)

*Tempered glass recommended.

*For glass door assembly, Silicon caulk or double-sided tape (3M VHB recommended) is required. (Not included.)

Interchangeable Door Position (3 doors or more)

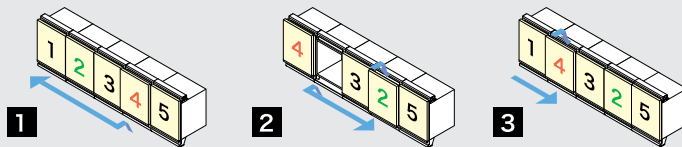

Door Opening Example

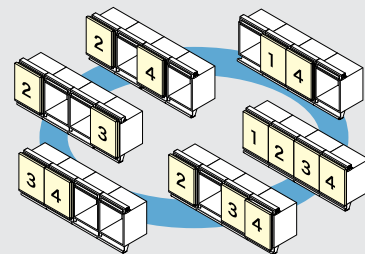

Provides various opening patterns. By adding more doors, the more opening patterns will be possible.

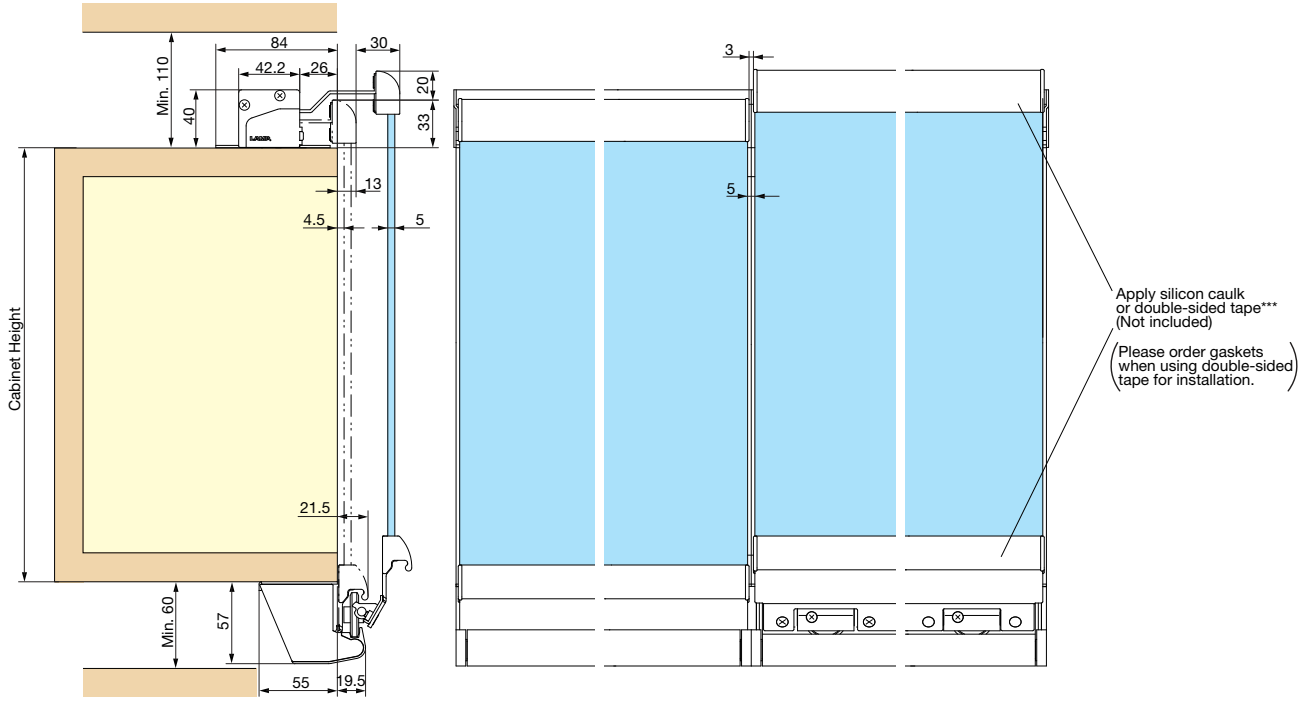

Glass Height = Cabinet Height + 18.5mm

•Top Panel

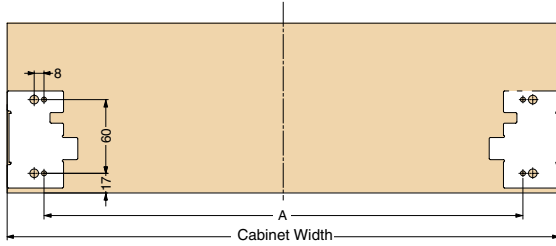

•Bottom Panel

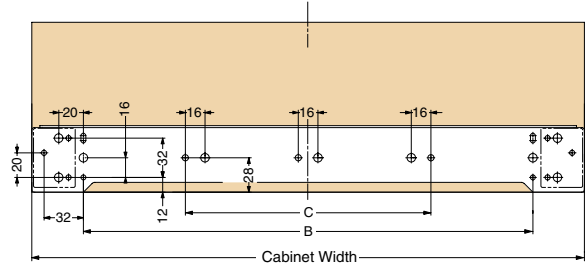

Cabinet Width	A
300	240
450	390
600	540
900	840

Cabinet Width	B	C
300	216	-
450	366	-
600	516	200
900	816	300

Item No.	Each Cabinet Width	Glass Width	Door Weight / Door
MFS-G300/S2	300mm (11-13/16")	295mm (11-5/8")	1.5 ~ 2.4kg (3.3 ~ 5.3lbs)
MFS-G450/S2	450mm (17-23/32")	445mm (17-1/2")	1.3 ~ 2.2kg (2.9 ~ 4.8lbs)
MFS-G450/S3	450mm (17-23/32")	445mm (17-1/2")	2.3 ~ 3.2kg (5.1 ~ 7.0lbs)
MFS-G600/S3	600mm (23-5/8")	595mm (23-7/16")	2.1 ~ 3.0kg (4.6 ~ 6.6lbs)
MFS-G600/S4	600mm (23-5/8")	595mm (23-7/16")	3.1 ~ 4.0kg (6.8 ~ 8.8lbs)
MFS-G600/S5	600mm (23-5/8")	595mm (23-7/16")	4.1 ~ 5.0kg (9.0 ~11.0lbs)
**MFS-G900/S5	900mm (35-7/16")	895mm (35-1/4")	3.8 ~ 4.7kg (8.4 ~10.3lbs)
**MFS-G900/S6	900mm (35-7/16")	895mm (35-1/4")	4.8 ~ 5.7kg (10.6 ~12.5lbs)
**MFS-G900/S7	900mm (35-7/16")	895mm (35-1/4")	5.8 ~ 6.7kg (12.8 ~14.7lbs)

MFS-G Ordering Info:

Designed for cabinet with minimum 2 doors.
 Each set contains hardware for one door only.
 To order, please reference the total cabinet width, the number of doors that will be in the cabinet, and the set required (MFS-G_ _ _ /S_), for example:
 1 cabinet 94" wide w/ 4 doors
 (23-1/2" ea, 12lbs./door),
 order as MFS-G600/S5 qty 4 each MFS-ED qty 1 pair

***Please order gaskets when using double-sided tape for installation.

Optional Gasket

Item No.	Door Width
MFS-PK300	295mm (11-5/8")
MFS-PK450	445mm (17-1/2")
MFS-PK600	595mm (23-7/16")
MFS-PK900	895mm (35-1/4")

Item No.	Description
MFS-ED	End Cap Set*

*1 pair of MFS-ED required per cabinet, not per door
 **Special order item

*1 set of gasket required per door, when using double sided-tape for door assembly.

MONOFLAT DOOR SERIES



MonoFlat **FAD™**

FAD-5

Door Weight: Max.5kg (11lbs)
Please see P9 for details



MonoFlat **LIN-X hinge™**

LIN-X450 / 600

Door Weight: Max.17~24kg (37~53lbs)
Please see P10~15 for details



MonoFlat **FAD™**

FAD-20

Door Weight: Max.20kg (44lbs)
Please see P16~17 for details



MonoFlat **FAD™**

FAD-44 / 44L

Door Weight: Max.35kg (77lbs)
Please see P18~19 for details

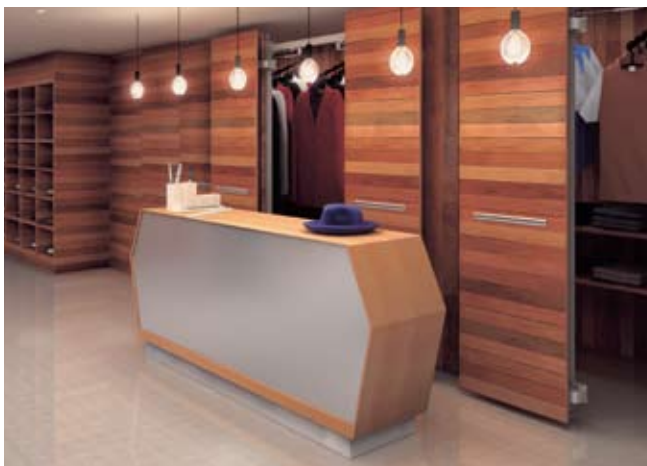

MonoFlat **FAD™**

FAD-54 / 54L

Door Weight: Max.35kg (77lbs)
Please see P20~21 for details



MonoFlat **UNISON™**

MFU

Door Weight: Max.30kg (66lbs)
Please see P22~23 for details