



**CARE AND MAINTENANCE
ADJUSTMENTS**

To help maintain the long life of this product and the freshness of its appearance, we suggest the following guidelines.

UPHOLSTERY

Fabric. Brush or vacuum regularly to prevent an accumulation of dust. Water based stains can be treated with a cool, mild detergent solution. Oil based stains require a dry cleaning product used according to manufacturer's instructions. Fabrics treated for fire retardancy must be dry cleaned only. Do not use water or preparations containing water. We recommend periodic professional dry cleaning.

Leather. Clean with mild detergent and water solution. Do not use polishes, oils or saddle soap. The natural oils are sealed in and buffing with a soft cloth is all the polishing needed.

Simulated Leather. Clean periodically with a mild detergent and rinse well. Air dry.

BASES, FRAMES, ARM FINISHES

Powder Coat Colors. Clean with liquid detergent, rinse and dry with a soft cloth.

Polyurethane Arms. Clean with a soft, damp cloth.

Adjustable Mechanisms. Do not lubricate any of the adjustable mechanisms of the chair.

CASTERS

Hard wheel casters are supplied for use on carpeted surfaces only. The use of hard wheel casters on hard surfaces, such as a mat or vinyl floor, will reduce chair stability. Soft wheel casters are available. Casters should be kept clean of carpet fibers. Casters never require lubrication.

Introducing Kart® chair, the first ergonomic task chair with the storage capability of a stacking chair. The 4-star base allows Kart chairs to “nest” horizontally. The unique plastic bumper on the base protects the chairs from wear and chipping when pushed around and into each other.

You've never seen a chair with moves like this. Please take a few moments to understand how the Kart chair folds and nests and how to adjust the chair to your personal requirements. It's easy to do.

Folding Seat...fold the seat up and the chair automatically rises to the nesting position.

Seat Height...adjust the chair so that when you are seated, your feet are flat on the floor and you feel no pressure under your thighs.

Tilt Tension...adjust so that when you lean back, you feel only slight resistance and you are supported in any position of the tilt range.

Forward Back Lock...engage to lock backrest in an upright position.

Seat Swivel...360° swivel motion for easy movement—locked in nesting position when the seat is folded up.

Optional Leash...a convenient, easy way to steer a “nest” of chairs.

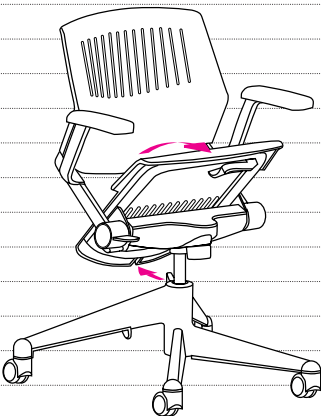

Seat Adjustment

TO UNFOLD: Simply pull the seat down.

Height adjustment may only be made when the seat is locked into full sitting position.

Seat Swivel

360° swivel motion—this movement is locked when in nesting mode (seat up and engaged with base).

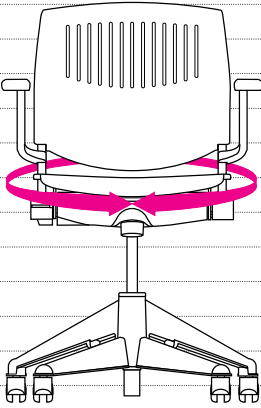
**Folding Lever**

TO FOLD: Pull the lever under the seat toward the front of the chair and tip the seat up. As the seat releases, the pneumatic lift activates and pushes the chair to its full height position.

TO LOCK: Spin the chair until the seat engages with the base tooth.

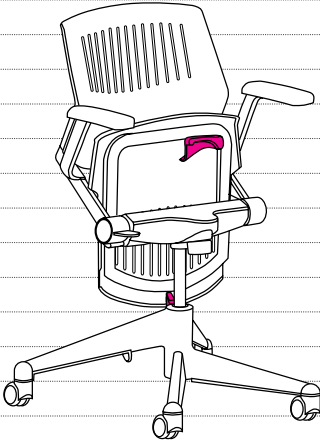

Now the chair can be steered and nested with other Kart chairs.

Optional Leash

Stored in a pouch under the seat. Attach the leash to the tilt tension knob of the first chair in the nest. Place the leash over the tops of the chair backs and pull the nested chairs to storage.

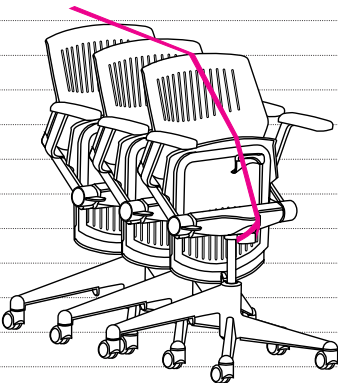

Pneumatic Height Adjustment

TO LOWER: Apply weight to seat, pull lever on the right and release at desired height.

TO RAISE: Lift your weight slightly and pull the lever on the right, releasing it at the desired height.

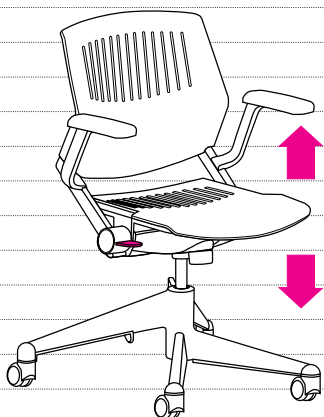
**Tilt Tension**

TO LOOSEN TENSION: Turn control knob counterclockwise.

TO TIGHTEN TENSION: Turn control knob clockwise

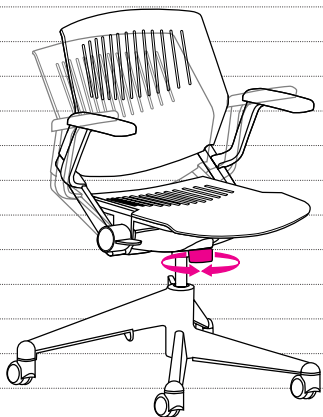
**Forward Back Lock**

TO LOCK: Lean forward, pull triangular knob out until it stops. The back is locked into an upright position with a slight comfortable flex.

TO RELEASE: Lean forward, push triangular knob in for full reclining flex.

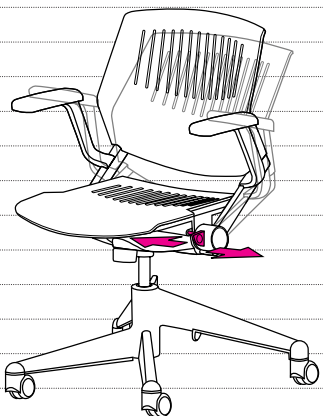

Kart is a registered trademark of Vecta. Patents pending.

©1998, 2002 Vecta® A Steelcase company

Vecta

P.O. Box 534013

Grand Prairie, TX 75053

972 641 2860