

# Outlook Jarrah

**Outlook Jarrah seating**

is designed for patient rooms and high traffic public waiting and reception areas. Seating can stand alone or be grouped into ganged configurations.

**Seat and back cushion** are fully upholstered.

**Arm caps on Jarrah seating** are standard in solid maple.

**Oval legs on Jarrah seating** are steel and available in black or silver paint.

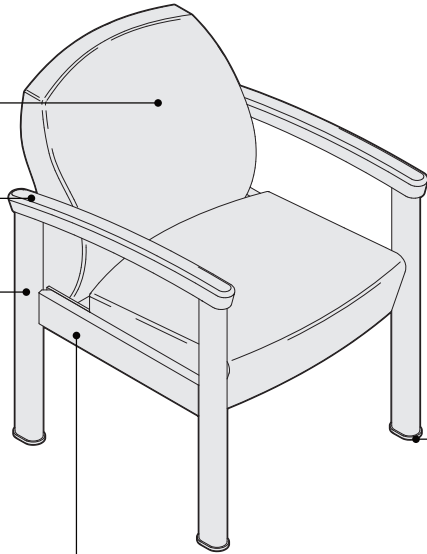

**Side stretcher** is standard in solid maple.

**Floor glide inserts** are inserted into the standard hollow glide to allow for easier movement of the chair and are available as an option.

**Product Details**

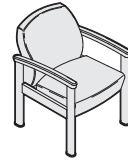

**Jarrah seating** has oval steel legs with wood stretcher and solid maple arm caps.

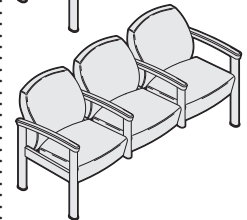
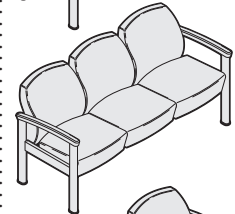
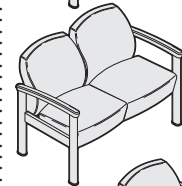
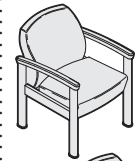

**Stand-alone units** are available in one-, two- and three-seat versions. Units are available with or without intermediate arms. Armless versions are available.

**Add-on units** are available in one-, two- and three-seat versions. Ganging ability is available on the left, right and both sides of each unit. Units are available with arms. Armless single-seat versions are available.

**Actual Dimensions**

▶ See page 170

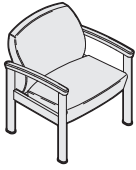

**24"W seats** are available on single seat arm chairs only.

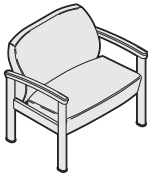

**Bariatric seating** is available in 30" and 40 1/2" seat widths and can be specified as stand-alone or add-on units. Ganging ability on add-on units, is available on the left, right or both sides of each unit. All bariatric seating have arms.

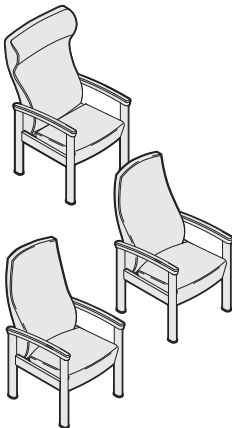

**High back patient seating** is available in three styles – with flared back, tapered back, and straight back. All high back chairs have arms and are available as stand-alone units only.

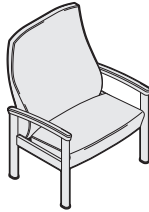

**High back seating with tapered back** is available in a bariatric version.

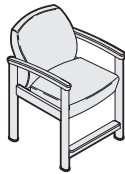

**Easy access seating** is available as stand-alone units. Jarrah chairs have a 24" seat height and include a foot rest.

**Glider** allows the seat to glide back and forth to soothe the user. Available on single units with two arms.

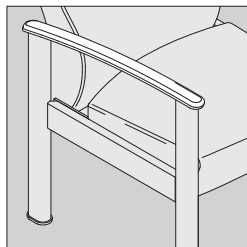

**Plastisol arm caps** are available as an option. Plastisol arm caps are offered in black, taupe and graphite.

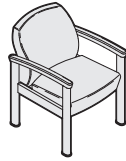

**Additional back heights of 4" or 12 1/2" higher** are available as an option on the standard back height tandem.

**Wallsaver legs** are available as an option.

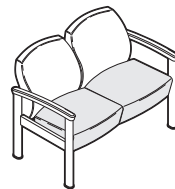

**Different fabrics** can be specified on the seat and back. On tandem units, the back fabric will be consistent throughout the whole unit as shown above. Contrasting fabric deviating from this standard needs to be processed through Specials.

**Moisture barrier** is available as an option on seat only.

**When wallsaver legs** are specified with glider (SG models), the backrest may make contact with the wall when glider is in motion.

**Connections**

**Ganging ability** links chairs in the field for permanent connection.

**Related Products**

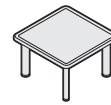

**Outlook Tables**  
▶ See page 236

**Surface Materials**

**All Nurture seating with standard upholstery fabrics** comply with the State of California Technical Bulletin 117.

**Seat and back**

- Fabric
- Fabric with moisture barrier (option on seat only)

**Arm caps**

- Maple wood
- Plastisol (option)

**Oval legs**

- 7207 Black
- 4855 Silver

**Glides**

- Black only

**Programs & Services**

**Outlook Jarrah seating components** ship separately for field assembly.

Outlook Jarrah, continued

Actual Dimensions						
Features	Overall Depth	Width	Height	Seat Width	Height	Arm Height
<b>Single-Seat Chairs</b>						
Stand-alone arm chairs	27"	24"	32½"	20¼"	18"	26"
Add-on arm chairs	27"	22¼"	32½"	20¼"	18"	26"
Stand-alone armless chairs	27"	24"	32½"	20¼"	18"	N.A.
<b>Single-Seat Chairs—Wide Versions</b>						
Stand-alone arm chairs	27"	28"	32½"	24"	18"	26"
<b>Two-Seat Chairs</b>						
Stand-alone arm chairs with center arm	27"	45¾"	32½"	20¼"	18"	26"
Add-on arm chairs with center arm	27"	44"	32½"	20¼"	18"	26"
Stand-alone arm chairs without center arm	27"	44"	32½"	40½"	18"	26"
Add-on arm chairs without center arm	27"	42¼"	32½"	40½"	18"	26"
<b>Three-Seat Chairs</b>						
Stand-alone arm chairs with center arms	27"	67¾"	32½"	20¼"	18"	26"
Add-on arm chairs with center arms	27"	66"	32½"	20¼"	18"	26"
Stand-alone arm chairs without center arms	27"	64¼"	32½"	60¾"	18"	26"
Add-on arm chairs without center arms	27"	62½"	32½"	60¾"	18"	26"
<b>Bariatric Chairs</b>						
30"W stand-alone arm chairs	27"	34"	32½"	30"	18"	26"
30"W add-on arm chairs	27"	32¼"	32½"	30"	18"	26"
40½"W stand-alone arm chairs	27"	44"	32½"	40½"	18"	26"
40½"W add-on arm chairs	27"	42¼"	32½"	40½"	18"	26"
<b>High-Back Patient Chairs</b>						
High-back patient chairs	30"	24"	45"	20¼"	18"	26"
30"W bariatric high-back patient chairs	30"	34"	45"	30"	18"	26"
<b>Easy Access Chair</b>						
Arm chairs	27"	24"	38½"	20¼"	24"	32"



# Outlook Jarrah

## Single-Seat Chairs

With Arms and Armless

Tip: Add the appropriate suffix to the style number for connector or leg options.

Tip: Left and right determined when facing the unit.

	Standard Includes	Required to Specify
▶ Need help? Product details, page 168	<ul style="list-style-type: none"> <li>• Seat and back: fabric</li> <li>• Arm caps, if selected: wood</li> <li>• Oval legs: paint</li> <li>• Glides: black</li> </ul>	<p>1 Style number with appropriate series number and leg connector suffix, if selected</p> <p><b>L</b> Left legs or connector <b>R</b> Right legs or connector <b>LR</b> Left and right connectors</p> <p>2 Fabric color number for seat and back</p> <p>3 Wood color number for side stretcher and arm caps</p> <p>4 Paint color number for oval legs</p> <p>5 Options, if selected (see below)</p> <p>▶ See <i>Surface Materials</i>, page 691.</p>

Tip: Different fabrics for the seat and back can be specified. If the fabrics are in different price groups, calculate list price by adding the two price groups together and dividing by two.

	Options	U.S. Price	Required to Specify
<b>Surface Materials</b>	<b>Moisture barrier</b>		
	• Moisture barrier	+\$ 83	Specify with <i>moisture barrier</i> .
	<b>Fire code seating</b>		
	• CAL 133	+\$188	Add suffix <b>F</b> to the style number.
	<b>Plastisol arm cap</b>		
	• Arm cap	+\$ 42 per cap	Specify with <i>plastisol arm caps</i> and select plastic color number.
<b>Higher Back</b>	• 4" higher back	+\$ 36	Specify with <i>4" higher back</i> .
	• 12½" higher back	+\$ 68	Specify with <i>12½" higher back</i> .
<b>Wallsaver Legs</b>	• Wallsaver legs	+\$104	Specify with <i>wallsaver legs</i> .
<b>Glider</b>	• Glider on stand-alone arm chairs	+\$416	Add suffix <b>SG</b> to the style number.
<b>Floor Glide Inserts</b>	• Floor glide inserts	No cost	Specify with <i>floor glide inserts</i> .
<b>Related Product</b>	• Outlook Tables		▶ Page 238

### Specification Information

#### Stand Alone



SC2210

#### U.S. Base Prices

Style Number	Fabric Price Group 1	Fabric Price Group 2	Fabric Price Group 3	Fabric Price Group 4	Fabric Price Group 5	Fabric Price Group 6	Fabric Price Group 7	Fabric Price Group 8	Fabric Price Group 9	Fabric Price Group 10	COM
--------------	----------------------	----------------------	----------------------	----------------------	----------------------	----------------------	----------------------	----------------------	----------------------	-----------------------	-----

#### Stand-Alone Arm Chair

SC2210	\$932	\$984	\$1036	\$1078	\$1120	\$1150	\$1192	\$1254	\$1338	\$1390	\$964
--------	-------	-------	--------	--------	--------	--------	--------	--------	--------	--------	-------

▶ Specification Information, continued on next page

► Specification Information, continued from previous page

**Specification Information**

**With Left Connector**

**With Right Connector**

**With Left and Right Connectors**



SC2210L



SC2210R



SC2210LR

**U.S. Base Prices**

Style Number	Fabric Price Group 1	Fabric Price Group 2	Fabric Price Group 3	Fabric Price Group 4	Fabric Price Group 5	Fabric Price Group 6	Fabric Price Group 7	Fabric Price Group 8	Fabric Price Group 9	Fabric Price Group 10	COM
--------------	----------------------	----------------------	----------------------	----------------------	----------------------	----------------------	----------------------	----------------------	----------------------	-----------------------	-----

**Stand-Alone Arm Chairs with Connectors**

SC2210__	\$932	\$984	\$1036	\$1078	\$1120	\$1150	\$1192	\$1254	\$1338	\$1390	\$964
----------	-------	-------	--------	--------	--------	--------	--------	--------	--------	--------	-------

**Add-On End-of-Run with Left Legs**

**Add-On End-of-Run with Right Legs**



SC2211L



SC2211R

**Add-On End-of-Run Arm Chairs**

SC2211__	\$778	\$830	\$ 882	\$ 924	\$ 966	\$ 996	\$1038	\$1100	\$1184	\$1236	\$810
----------	-------	-------	--------	--------	--------	--------	--------	--------	--------	--------	-------

**Add-On Continuous-Run with Left Legs**

**Add-On Continuous-Run with Right Legs**



SC2212L



SC2212R

**Add-On Continuous-Run Arm Chairs**

SC2212__	\$778	\$830	\$ 882	\$ 924	\$ 966	\$ 996	\$1038	\$1100	\$1184	\$1236	\$810
----------	-------	-------	--------	--------	--------	--------	--------	--------	--------	--------	-------

► Specification Information, continued on next page



**For Canadian Pricing**

Multiply U.S. Price by the Canadian price factor.

► See page 1 for details.

Outlook Jarrah, continued

► Specification Information, continued from previous page

**Specification Information**

**Stand Alone**



SC2213

**U.S. Base Prices**

Style Number	Fabric Price Group 1	Fabric Price Group 2	Fabric Price Group 3	Fabric Price Group 4	Fabric Price Group 5	Fabric Price Group 6	Fabric Price Group 7	Fabric Price Group 8	Fabric Price Group 9	Fabric Price Group 10	COM
--------------	----------------------	----------------------	----------------------	----------------------	----------------------	----------------------	----------------------	----------------------	----------------------	-----------------------	-----

**Stand-Alone Armless Chair**

SC2213	\$842	\$894	\$946	\$988	\$1030	\$1060	\$1102	\$1164	\$1248	\$1300	\$874
--------	-------	-------	-------	-------	--------	--------	--------	--------	--------	--------	-------

**With Left Connector**

**With Right Connector**

**With Left and Right Connectors**



SC2213L



SC2213R



SC2213LR

**Stand-Alone Armless Chairs with Connectors**

SC2213_	\$842	\$894	\$946	\$988	\$1030	\$1060	\$1102	\$1164	\$1248	\$1300	\$874
---------	-------	-------	-------	-------	--------	--------	--------	--------	--------	--------	-------



**For Canadian Pricing**

Multiply U.S. Price by the Canadian price factor.

► See page 1 for details.

## Single-Seat Chair—24" Wide Version

With Arms

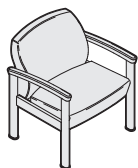

*Tip: Different fabrics for the seat and back can be specified. If the fabrics are in different price groups, calculate list price by adding the two price groups together and dividing by two.*

Standard Includes	Required to Specify
-------------------	---------------------

- |  |  |   |
|--|--|---|
| <ul style="list-style-type: none"> <li>▶ Need help? Product details, page 169</li> </ul> | <ul style="list-style-type: none"> <li>• Seat and back: fabric</li> <li>• Arm caps: wood</li> <li>• Oval legs: paint</li> <li>• Glides: black</li> </ul> | <ol style="list-style-type: none"> <li>1 Style number</li> <li>2 Fabric color number for seat and back</li> <li>3 Wood color number for side stretcher and arm caps</li> <li>4 Paint color number for oval legs</li> <li>5 Options, if selected (see below)</li> </ol> <p>▶ See <i>Surface Materials</i>, page 691.</p> |
|--|--|---|

Options	U.S. Price	Required to Specify
---------	------------	---------------------

<b>Surface Materials</b>	<b>Moisture barrier</b>		
	• Moisture barrier	+\$ 83	Specify with <i>moisture barrier</i> .
	<b>Fire code seating</b>		
	• CAL 133	+\$188	Add suffix <b>F</b> to the style number.
	<b>Plastisol arm cap</b>		
	• Arm cap	+\$ 84	Specify with <i>plastisol arm caps</i> and select plastic color number.
<b>Higher Back</b>	• 4" higher back	+\$ 36	Specify with <i>4" higher back</i> .
	• 12½" higher back	+\$ 68	Specify with <i>12½" higher back</i> .
<b>Wallsaver Legs</b>	• Wallsaver legs	+\$104	Specify with <i>wallsaver legs</i> .
<b>Floor Glide Inserts</b>	• Floor glide inserts	No cost	Specify with <i>floor glide inserts</i> .
<b>Related Product</b>	• Outlook Tables		▶ Page 238

### Specification Information

Style Number	U.S. Base Prices										COM
	Fabric Price	Fabric Price	Fabric Price	Fabric Price	Fabric Price	Fabric Price	Fabric Price	Fabric Price	Fabric Price	Fabric Price	
	Group 1	Group 2	Group 3	Group 4	Group 5	Group 6	Group 7	Group 8	Group 9	Group 10	

## Stand-Alone Arm Chair—24" Wide Version

<b>SC2210W</b>	\$1025	\$1083	\$1141	\$1185	\$1233	\$1267	\$1313	\$1381	\$1473	\$1531	\$1057
----------------	--------	--------	--------	--------	--------	--------	--------	--------	--------	--------	--------



#### For Canadian Pricing

Multiply U.S. Price by the Canadian price factor.

▶ See page 1 for details.

Outlook Jarrah, continued

**Two-Seat Chairs**

With Arms

*Tip: Add the appropriate suffix to the style number for connector or leg options.*

*Tip: Left and right determined when facing the unit.*

	Standard Includes	Required to Specify
<p>► Need help? Product details, page 168</p> <ul style="list-style-type: none"> <li>• Seat and back: fabric</li> <li>• Arm caps: wood</li> <li>• Oval legs: paint</li> <li>• Glides: black</li> </ul>	<p>1 Style number with appropriate series number and leg connector suffix, if selected</p> <ul style="list-style-type: none"> <li><b>L</b> Left legs or connector</li> <li><b>R</b> Right legs or connector</li> <li><b>LR</b> Left and right connectors</li> </ul> <p>2 Fabric color number for seat and back</p> <p>3 Wood color number for side stretcher and arm caps</p> <p>4 Paint color number for oval legs</p> <p>5 Options, if selected (see below)</p> <p>► See <i>Surface Materials</i>, page 691.</p>	

*Tip: Different fabrics for the seat and back can be specified. If the fabrics are in different price groups, calculate list price by adding the two price groups together and dividing by two.*

	Options	U.S. Price	Required to Specify
<b>Surface Materials</b>	<b>Moisture barrier</b>	+\$166	Specify with <i>moisture barrier</i> .
	<b>Fire code seating</b>		
	• CAL 133	+\$376	Add suffix <b>F</b> to the style number.
<b>Higher Back</b>	<b>Plastisol arm cap</b>		
	• Arm cap	+\$ 42 per cap	Specify with <i>plastisol arm caps</i> and select plastic color number.
<b>Wallsaver Legs</b>	• 4" higher back	+\$ 72	Specify with <i>4" higher back</i> .
	• 12½" higher back	+\$136	Specify with <i>12½" higher back</i> .
<b>Floor Glide Inserts</b>	• Wallsaver legs	+\$104	Specify with <i>wallsaver legs</i> .
<b>Related Product</b>	• Floor glide inserts	No cost	Specify with <i>floor glide inserts</i> .
	• Outlook Tables		► Page 238

**Specification Information**

**Stand Alone**



SC2223

**U.S. Base Prices**

Style Number	Fabric Price Group 1	Fabric Price Group 2	Fabric Price Group 3	Fabric Price Group 4	Fabric Price Group 5	Fabric Price Group 6	Fabric Price Group 7	Fabric Price Group 8	Fabric Price Group 9	Fabric Price Group 10	COM
--------------	----------------------	----------------------	----------------------	----------------------	----------------------	----------------------	----------------------	----------------------	----------------------	-----------------------	-----

**Two-Seat Stand-Alone Arm Chair with Center Arms**

<b>SC2223</b>	\$1589	\$1693	\$1797	\$1881	\$1963	\$2025	\$2109	\$2233	\$2401	\$2505	\$1621
---------------	--------	--------	--------	--------	--------	--------	--------	--------	--------	--------	--------

► Specification Information, continued on next page



**For Canadian Pricing**

Multiply U.S. Price by the Canadian price factor.

► See page 1 for details.

► Specification Information, continued from previous page

**Specification Information**

**With Left Connector      With Right Connector      With Left and Right Connectors**



SC2223L



SC2223R



SC2223LR

**U.S. Base Prices**

Style Number	Fabric Price Group 1	Fabric Price Group 2	Fabric Price Group 3	Fabric Price Group 4	Fabric Price Group 5	Fabric Price Group 6	Fabric Price Group 7	Fabric Price Group 8	Fabric Price Group 9	Fabric Price Group 10	COM
--------------	----------------------	----------------------	----------------------	----------------------	----------------------	----------------------	----------------------	----------------------	----------------------	-----------------------	-----

**Two-Seat Stand-Alone Arm Chairs with Center Arms with Connectors**

<b>SC2223</b> __	\$1589	\$1693	\$1797	\$1881	\$1963	\$2025	\$2109	\$2233	\$2401	\$2505	\$1621
------------------	--------	--------	--------	--------	--------	--------	--------	--------	--------	--------	--------

**Add-On End-of-Run with Left Legs**

**Add-On End-of-Run with Right Legs**



SC2224L



SC2224R

**Two-Seat Add-On End-of-Run Chairs with Center Arm**

<b>SC2224</b> __	\$1437	\$1541	\$1645	\$1729	\$1811	\$1873	\$1957	\$2081	\$2249	\$2353	\$1469
------------------	--------	--------	--------	--------	--------	--------	--------	--------	--------	--------	--------

**Add-On Continuous-Run with Left Legs**

**Add-On Continuous-Run with Right Legs**



SC2225L



SC2225R

**Two-Seat Add-On Continuous-Run Arm Chairs with Center Arm**

<b>SC2225</b> __	\$1437	\$1541	\$1645	\$1729	\$1811	\$1873	\$1957	\$2081	\$2249	\$2353	\$1469
------------------	--------	--------	--------	--------	--------	--------	--------	--------	--------	--------	--------

► Specification Information, continued on next page



**For Canadian Pricing**

Multiply U.S. Price by the Canadian price factor.

► See page 1 for details.

Outlook Jarrah, continued

► Specification Information, continued from previous page

**Specification Information**

**Stand Alone**



SC2220

**U.S. Base Prices**

Style Number	Fabric Price Group 1	Fabric Price Group 2	Fabric Price Group 3	Fabric Price Group 4	Fabric Price Group 5	Fabric Price Group 6	Fabric Price Group 7	Fabric Price Group 8	Fabric Price Group 9	Fabric Price Group 10	COM
--------------	----------------------	----------------------	----------------------	----------------------	----------------------	----------------------	----------------------	----------------------	----------------------	-----------------------	-----

**Two-Seat Stand-Alone Arm Chair without Center Arm**

<b>SC2220</b>	\$1504	\$1608	\$1712	\$1796	\$1878	\$1940	\$2024	\$2148	\$2316	\$2420	\$1536
---------------	--------	--------	--------	--------	--------	--------	--------	--------	--------	--------	--------

**With Left Connector**

**With Right Connector**

**With Left and Right Connectors**



SC2220L



SC2220R

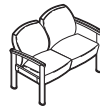

SC2220LR

**Two-Seat Stand-Alone Arm Chairs without Center Arm with Connectors**

<b>SC2220__</b>	\$1504	\$1608	\$1712	\$1796	\$1878	\$1940	\$2024	\$2148	\$2316	\$2420	\$1536
-----------------	--------	--------	--------	--------	--------	--------	--------	--------	--------	--------	--------

**Add-On End-of-Run with Left Legs**

**Add-On End-of-Run with Right Legs**



SC2221L



SC2221R

**Two-Seat Add-On End-of-Run Arm Chairs without Center Arm**

<b>SC2221__</b>	\$1358	\$1462	\$1566	\$1650	\$1732	\$1794	\$1878	\$2002	\$2170	\$2274	\$1390
-----------------	--------	--------	--------	--------	--------	--------	--------	--------	--------	--------	--------

**Add-On Continuous-Run with Left Legs**

**Add-On Continuous-Run with Right Legs**



SC2222L

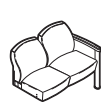

SC2222R

**Two-Seat Add-On Continuous-Run Arm Chairs without Center Arm**

<b>SC2222__</b>	\$1358	\$1462	\$1566	\$1650	\$1732	\$1794	\$1878	\$2002	\$2170	\$2274	\$1390
-----------------	--------	--------	--------	--------	--------	--------	--------	--------	--------	--------	--------



**For Canadian Pricing**

Multiply U.S. Price by the Canadian price factor.

► See page 1 for details.



Outlook Jarrah, continued

**Three-Seat Chairs**

With Arms

*Tip: Add the appropriate suffix to the style number for connector or leg options.*

*Tip: Left and right determined when facing the unit.*

	Standard Includes	Required to Specify
<p>▶ Need help? Product details, page 168</p>	<ul style="list-style-type: none"> <li>• Seat and back: fabric</li> <li>• Arm caps: wood</li> <li>• Oval legs: paint</li> <li>• Glides: black only</li> </ul>	<p>1 Style number with appropriate series number and leg connector suffix, if selected</p> <ul style="list-style-type: none"> <li><b>L</b> Left legs or connector</li> <li><b>R</b> Right legs or connector</li> <li><b>LR</b> Left and right connectors</li> </ul> <p>2 Fabric color number for seat and back</p> <p>3 Wood color number for side stretcher and arm caps</p> <p>4 Paint color number for oval legs</p> <p>5 Options, if selected (see below)</p> <p>▶ See <i>Surface Materials</i>, page 691.</p>

*Tip: Different fabrics for the seat and back can be specified. If the fabrics are in different price groups, calculate list price by adding the two price groups together and dividing by two.*

	Options	U.S. Price	Required to Specify
<b>Surface Materials</b>	<b>Moisture barrier</b>	+\$249	Specify <i>with moisture barrier</i> .
	<b>Fire code seating</b>		
	• CAL 133	+\$470	Add suffix <b>F</b> to the style number.
	<b>Plastisol arm cap</b>		
	• Arm cap	+\$ 42 per cap	Specify <i>with plastisol arm caps</i> and select plastic color number.
<b>Higher Back</b>	• 4" higher back	+\$108	Specify <i>with 4" higher back</i> .
	• 12½" higher back	+\$204	Specify <i>with 12½" higher back</i> .
<b>Wallsaver Legs</b>	• Wallsaver legs	+\$104	Specify <i>with wallsaver legs</i> .
<b>Floor Glide Inserts</b>	• Floor glide inserts	No cost	Specify <i>with floor glide inserts</i> .
<b>Related Product</b>	• Outlook Tables		▶ Page 238

**Specification Information**

**Stand Alone**



SC2233

**U.S. Base Prices**

Style Number	U.S. Base Prices										COM
	Fabric Price Group 1	Fabric Price Group 2	Fabric Price Group 3	Fabric Price Group 4	Fabric Price Group 5	Fabric Price Group 6	Fabric Price Group 7	Fabric Price Group 8	Fabric Price Group 9	Fabric Price Group 10	

**Three-Seat Stand-Alone Arm Chair with Center Arms**

<b>SC2233</b>	\$2271	\$2427	\$2583	\$2707	\$2833	\$2927	\$3051	\$3239	\$3487	\$3643	\$2303
---------------	--------	--------	--------	--------	--------	--------	--------	--------	--------	--------	--------

▶ **Specification Information, continued on next page**



**For Canadian Pricing**

Multiply U.S. Price by the Canadian price factor.

▶ See page 1 for details.

► Specification Information, continued from previous page

**Specification Information**

**With Left Connector**

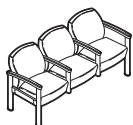

SC2233L

**With Right Connector**



SC2233R

**With Left and Right Connectors**



SC2233LR

**U.S. Base Prices**

Style Number	Fabric Price Group 1	Fabric Price Group 2	Fabric Price Group 3	Fabric Price Group 4	Fabric Price Group 5	Fabric Price Group 6	Fabric Price Group 7	Fabric Price Group 8	Fabric Price Group 9	Fabric Price Group 10	COM
--------------	----------------------	----------------------	----------------------	----------------------	----------------------	----------------------	----------------------	----------------------	----------------------	-----------------------	-----

**Three-Seat Stand-Alone Arm Chairs with Center Arms with Connectors**

<b>SC2233</b> __	\$2271	\$2427	\$2583	\$2707	\$2833	\$2927	\$3051	\$3239	\$3487	\$3643	\$2303
------------------	--------	--------	--------	--------	--------	--------	--------	--------	--------	--------	--------

**Add-On End-of-Run with Left Legs**



SC2234L

**Add-On End-of-Run with Right Legs**



SC2234R

**Three-Seat Add-On End-of-Run Arm Chairs with Center Arm**

<b>SC2234</b> __	\$2124	\$2280	\$2436	\$2560	\$2686	\$2780	\$2904	\$3092	\$3340	\$3496	\$2156
------------------	--------	--------	--------	--------	--------	--------	--------	--------	--------	--------	--------

**Add-On Continuous-Run with Left Legs**



SC2235L

**Add-On Continuous-Run with Right Legs**



SC2235R

**Three-Seat Add-On Continuous-Run Arm Chairs with Center Arm**

<b>SC2235</b> __	\$2124	\$2280	\$2436	\$2560	\$2686	\$2780	\$2904	\$3092	\$3340	\$3496	\$2156
------------------	--------	--------	--------	--------	--------	--------	--------	--------	--------	--------	--------

► Specification Information, continued on next page

 **For Canadian Pricing**  
 Multiply U.S. Price by the Canadian price factor.  
 ► See page 1 for details.

Outlook Jarrah, continued

► Specification Information, continued from previous page

**Specification Information**

**Stand Alone**



SC2230

**U.S. Base Prices**

Style Number	Fabric Price Group 1	Fabric Price Group 2	Fabric Price Group 3	Fabric Price Group 4	Fabric Price Group 5	Fabric Price Group 6	Fabric Price Group 7	Fabric Price Group 8	Fabric Price Group 9	Fabric Price Group 10	COM
--------------	----------------------	----------------------	----------------------	----------------------	----------------------	----------------------	----------------------	----------------------	----------------------	-----------------------	-----

**Three-Seat Stand-Alone Arm Chair without Center Arm**

<b>SC2230</b>	\$2107	\$2263	\$2419	\$2543	\$2669	\$2763	\$2887	\$3075	\$3323	\$3479	\$2139
---------------	--------	--------	--------	--------	--------	--------	--------	--------	--------	--------	--------

**With Left Connector**

**With Right Connector**

**With Left and Right Connectors**

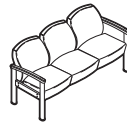

SC2230L

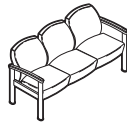

SC2230R

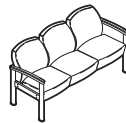

SC2230LR

**Three-Seat Stand-Alone Arm Chairs without Center Arm with Connectors**

<b>SC2230_</b>	\$2107	\$2263	\$2419	\$2543	\$2669	\$2763	\$2887	\$3075	\$3323	\$3479	\$2139
----------------	--------	--------	--------	--------	--------	--------	--------	--------	--------	--------	--------

**Add-On End-of-Run with Left Legs**

**Add-On End-of-Run with Right Legs**



SC2231L



SC2231R

**Three-Seat Add-On End-of-Run Arm Chairs without Center Arm**

<b>SC2231_</b>	\$1957	\$2113	\$2269	\$2393	\$2519	\$2613	\$2737	\$2925	\$3173	\$3329	\$1989
----------------	--------	--------	--------	--------	--------	--------	--------	--------	--------	--------	--------

► Specification Information, continued on next page



**For Canadian Pricing**

Multiply U.S. Price by the Canadian price factor.

► See page 1 for details.

► Specification Information, continued from previous page

**Specification Information**

**Add-On Continuous-Run with Left Legs**



SC2232L

**Add-On Continuous-Run with Right Legs**



SC2232R

**U.S. Base Prices**

Style Number	Fabric Price Group 1	Fabric Price Group 2	Fabric Price Group 3	Fabric Price Group 4	Fabric Price Group 5	Fabric Price Group 6	Fabric Price Group 7	Fabric Price Group 8	Fabric Price Group 9	Fabric Price Group 10	COM
--------------	----------------------	----------------------	----------------------	----------------------	----------------------	----------------------	----------------------	----------------------	----------------------	-----------------------	-----

**Three-Seat Add-On Continuous-Run Arm Chairs without Center Arm**

SC2232	\$1957	\$2113	\$2269	\$2393	\$2519	\$2613	\$2737	\$2925	\$3173	\$3329	\$1989
--------	--------	--------	--------	--------	--------	--------	--------	--------	--------	--------	--------

Families of Seating



**For Canadian Pricing**

Multiply U.S. Price by the Canadian price factor.

► See page 1 for details.

## Bariatric Seating

### With Arms

Tip: Add the appropriate suffix to the style number for connector or leg options.

Tip: Left and right determined when facing the unit.

	Standard Includes	Required to Specify
<p>► Need help? Product details, page 169</p>	<ul style="list-style-type: none"> <li>• Seat and back: fabric</li> <li>• Arm caps: wood</li> <li>• Oval legs: paint</li> <li>• Glides: black</li> </ul>	<p>1 Style number with appropriate series number and leg connector suffix, if selected</p> <ul style="list-style-type: none"> <li><b>L</b> Left legs or connector</li> <li><b>R</b> Right legs or connector</li> <li><b>LR</b> Left and right connectors</li> </ul> <p>2 Fabric color number for seat and back</p> <p>3 Wood color number for side stretcher and arm caps</p> <p>4 Paint color number for oval legs</p> <p>5 Options, if selected (see below)</p> <p>► See <i>Surface Materials</i>, page 691.</p>

Tip: Different fabrics for the seat and back can be specified. If the fabrics are in different price groups, calculate list price by adding the two price groups together and dividing by two.

	Options	U.S. Price	Required to Specify
<b>Surface Materials</b>	<b>Moisture barrier</b>	+\$ 83	Specify with <i>moisture barrier</i> .
	<b>Fire code seating</b>		
	• CAL 133	+\$282	Add suffix <b>F</b> to the style number.
<b>Higher Back</b>	<b>Plastisol arm cap</b>		
	• Arm cap	+\$ 42 per cap	Specify with <i>plastisol arm caps</i> and select plastic color number.
<b>Wallsaver Legs</b>	• 4" higher back on 30"W bariatric chairs only	+\$ 36	Specify with <i>4" higher back</i> .
<b>Wallsaver Legs</b>	• Wallsaver legs	+\$104	Specify with <i>wallsaver legs</i> .
<b>Floor Glide Inserts</b>	• Floor glide inserts	No cost	Specify with <i>floor glide inserts</i> .
<b>Related Product</b>	• Outlook Tables		► Page 238

## Specification Information

### Stand Alone



SC2260

#### U.S. Base Prices

Style Number	Fabric Price Group 1	Fabric Price Group 2	Fabric Price Group 3	Fabric Price Group 4	Fabric Price Group 5	Fabric Price Group 6	Fabric Price Group 7	Fabric Price Group 8	Fabric Price Group 9	Fabric Price Group 10	COM

### 30"W Stand-Alone Arm Chair

<b>SC2260</b>	\$1162	\$1242	\$1318	\$1380	\$1442	\$1490	\$1554	\$1646	\$1772	\$1848	\$1194
---------------	--------	--------	--------	--------	--------	--------	--------	--------	--------	--------	--------

► Specification Information, continued on next page



#### For Canadian Pricing

Multiply U.S. Price by the Canadian price factor.

► See page 1 for details.

► Specification Information, continued from previous page

**Specification Information**

**With Left Connector**



SC2260L

**With Right Connector**



SC2260R

**With Left and Right Connectors**



SC2260LR

**U.S. Base Prices**

Style Number	Fabric Price Group 1	Fabric Price Group 2	Fabric Price Group 3	Fabric Price Group 4	Fabric Price Group 5	Fabric Price Group 6	Fabric Price Group 7	Fabric Price Group 8	Fabric Price Group 9	Fabric Price Group 10	COM
--------------	----------------------	----------------------	----------------------	----------------------	----------------------	----------------------	----------------------	----------------------	----------------------	-----------------------	-----

**30"W Stand-Alone Arm Chairs with Connectors**

SC2260__	\$1162	\$1242	\$1318	\$1380	\$1442	\$1490	\$1554	\$1646	\$1772	\$1848	\$1194
----------	--------	--------	--------	--------	--------	--------	--------	--------	--------	--------	--------

**Add-On End-of-Run with Left Legs**



SC2261L

**Add-On End-of-Run with Right Legs**



SC2261R

**30"W Add-On End-of-Run Arm Chairs**

SC2261__	\$ 998	\$1078	\$1154	\$1216	\$1278	\$1326	\$1390	\$1482	\$1608	\$1684	\$1030
----------	--------	--------	--------	--------	--------	--------	--------	--------	--------	--------	--------

**Add-On Continuous-Run with Left Legs**



SC2262L

**Add-On Continuous-Run with Right Legs**



SC2262R

**30"W Add-On Continuous-Run Arm Chairs**

SC2262__	\$ 998	\$1078	\$1154	\$1216	\$1278	\$1326	\$1390	\$1482	\$1608	\$1684	\$1030
----------	--------	--------	--------	--------	--------	--------	--------	--------	--------	--------	--------

► Specification Information, continued on next page



**For Canadian Pricing**

Multiply U.S. Price by the Canadian price factor.

► See page 1 for details.

Outlook Jarrah, continued

► Specification Information, continued from previous page

**Specification Information**

**Stand Alone**



SC2265

**U.S. Base Prices**

Style Number	Fabric Price Group 1	Fabric Price Group 2	Fabric Price Group 3	Fabric Price Group 4	Fabric Price Group 5	Fabric Price Group 6	Fabric Price Group 7	Fabric Price Group 8	Fabric Price Group 9	Fabric Price Group 10	COM
--------------	----------------------	----------------------	----------------------	----------------------	----------------------	----------------------	----------------------	----------------------	----------------------	-----------------------	-----

**40 1/2"W Stand-Alone Arm Chair**

<b>SC2265</b>	\$1817	\$1921	\$2025	\$2109	\$2191	\$2253	\$2337	\$2461	\$2629	\$2733	\$1849
---------------	--------	--------	--------	--------	--------	--------	--------	--------	--------	--------	--------

**With Left Connector**

**With Right Connector**

**With Left and Right Connectors**



SC2265L



SC2265R



SC2265LR

**40 1/2"W Stand-Alone Arm Chairs with Connectors**

<b>SC2265_</b>	\$1817	\$1921	\$2025	\$2109	\$2191	\$2253	\$2337	\$2461	\$2629	\$2733	\$1849
----------------	--------	--------	--------	--------	--------	--------	--------	--------	--------	--------	--------

**Add-On End-of-Run with Left Legs**

**Add-On End-of-Run with Right Legs**



SC2266L

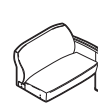

SC2266R

**40 1/2"W Add-On End-of-Run Arm Chairs**

<b>SC2266_</b>	\$1640	\$1744	\$1848	\$1932	\$2014	\$2076	\$2160	\$2284	\$2452	\$2556	\$1672
----------------	--------	--------	--------	--------	--------	--------	--------	--------	--------	--------	--------

► Specification Information, continued on next page



**For Canadian Pricing**

Multiply U.S. Price by the Canadian price factor.

► See page 1 for details.

► Specification Information, continued from previous page

**Specification Information**

**Add-On Continuous-Run with Left Legs**



SC2267L

**Add-On Continuous-Run with Right Legs**



SC2267R

**U.S. Base Prices**

Style Number	Fabric Price Group 1	Fabric Price Group 2	Fabric Price Group 3	Fabric Price Group 4	Fabric Price Group 5	Fabric Price Group 6	Fabric Price Group 7	Fabric Price Group 8	Fabric Price Group 9	Fabric Price Group 10	COM
--------------	----------------------	----------------------	----------------------	----------------------	----------------------	----------------------	----------------------	----------------------	----------------------	-----------------------	-----

**40 1/2"W Add-On Continuous-Run Arm Chairs**

<b>SC2267__</b>	\$1640	\$1744	\$1848	\$1932	\$2014	\$2076	\$2160	\$2284	\$2452	\$2556	\$1672
-----------------	--------	--------	--------	--------	--------	--------	--------	--------	--------	--------	--------

Families of Seating



**For Canadian Pricing**

Multiply U.S. Price by the Canadian price factor.

► See page 1 for details.

## High-Back Patient Chairs

With Arms

	Standard Includes	Required to Specify
▶ Need help? Product details, page 169	<ul style="list-style-type: none"> <li>• Seat and back: fabric</li> <li>• Arm caps: wood</li> <li>• Oval legs: paint</li> <li>• Glides: black</li> </ul>	<ol style="list-style-type: none"> <li>1 Style number</li> <li>2 Fabric color number for seat and back</li> <li>3 Wood color number for side stretcher and arm caps</li> <li>4 Paint color number for oval legs</li> <li>5 Options, if selected (see below)</li> </ol> <p>▶ See <i>Surface Materials</i>, page 691.</p>

*Tip: Different fabrics for the seat and back can be specified. If the fabrics are in different price groups, calculate list price by adding the two price groups together and dividing by two.*

	Options	U.S. Price	Required to Specify
<b>Surface Materials</b>	<b>Moisture barrier</b>		
	• Moisture barrier	+\$ 83	Specify with moisture barrier.
	<b>Fire code seating</b>		
	• CAL 133	+\$188	Add suffix <b>F</b> to the style number.
	<b>Plastisol arm cap</b>		
	• Arm cap	+\$ 84	Specify with plastisol arm caps and select plastic color number.
<b>Wallsaver Legs</b>	• Wallsaver legs	+\$104	Specify with wallsaver legs.
<b>Glider</b>	• Glider on stand-alone arm chairs	+\$416	Add suffix <b>SG</b> to the style number.
<b>Floor Glide Inserts</b>	• Floor glide inserts	No cost	Specify with floor glide inserts.
<b>Related Product</b>	• Outlook Tables		▶ Page 238

### Specification Information

#### Flared Back



#### U.S. Base Prices

Style Number	U.S. Base Prices										COM
	Fabric Price Group 1	Fabric Price Group 2	Fabric Price Group 3	Fabric Price Group 4	Fabric Price Group 5	Fabric Price Group 6	Fabric Price Group 7	Fabric Price Group 8	Fabric Price Group 9	Fabric Price Group 10	

### High-Back Patient Chair

<b>SC2283</b>	\$1017	\$1083	\$1149	\$1201	\$1253	\$1291	\$1343	\$1421	\$1525	\$1589	\$1049
---------------	--------	--------	--------	--------	--------	--------	--------	--------	--------	--------	--------

▶ Specification Information, continued on next page



#### For Canadian Pricing

Multiply U.S. Price by the Canadian price factor.

▶ See page 1 for details.

► Specification Information, continued from previous page

**Specification Information**

**Tapered Back**



**U.S. Base Prices**

Style Number	Fabric Price Group 1	Fabric Price Group 2	Fabric Price Group 3	Fabric Price Group 4	Fabric Price Group 5	Fabric Price Group 6	Fabric Price Group 7	Fabric Price Group 8	Fabric Price Group 9	Fabric Price Group 10	COM
--------------	----------------------	----------------------	----------------------	----------------------	----------------------	----------------------	----------------------	----------------------	----------------------	-----------------------	-----

**High-Back Patient Chair**

SC2285	\$1017	\$1083	\$1149	\$1201	\$1253	\$1291	\$1343	\$1421	\$1525	\$1589	\$1049
--------	--------	--------	--------	--------	--------	--------	--------	--------	--------	--------	--------

**Straight Back**



**High-Back Patient Chair**

SC2286	\$1017	\$1089	\$1161	\$1219	\$1275	\$1319	\$1375	\$1463	\$1577	\$1647	\$1049
--------	--------	--------	--------	--------	--------	--------	--------	--------	--------	--------	--------

Families of Seating



**For Canadian Pricing**

Multiply U.S. Price by the Canadian price factor.

► See page 1 for details.

### Bariatric High-Back Patient Chair

With Arms and Tapered Back

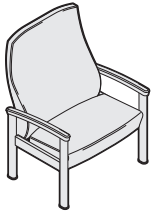

*Tip: Different fabrics for the seat and back can be specified. If the fabrics are in different price groups, calculate list price by adding the two price groups together and dividing by two.*

Standard Includes	Required to Specify
-------------------	---------------------

- |  |  |   |
|--|--|---|
| <ul style="list-style-type: none"> <li>▶ Need help? Product details, page 169</li> </ul> | <ul style="list-style-type: none"> <li>• Seat and back: fabric</li> <li>• Arm caps: wood</li> <li>• Oval legs: paint</li> <li>• Glides: black</li> </ul> | <ol style="list-style-type: none"> <li>1 Style number</li> <li>2 Fabric color number for seat and back</li> <li>3 Wood color number for side stretcher and arm caps</li> <li>4 Paint color number for oval legs</li> <li>5 Options, if selected (see below)</li> </ol> <p>▶ See <i>Surface Materials</i>, page 691.</p> |
|--|--|---|

Options	U.S. Price	Required to Specify
---------	------------	---------------------

<b>Surface Materials</b>	<ul style="list-style-type: none"> <li>• <b>Moisture barrier</b></li> <li>• Moisture barrier</li> <li>• <b>Fire code seating</b></li> <li>• CAL 133</li> </ul>	<p style="text-align: right;">+\$ 83</p> <p style="text-align: right;">+\$282</p>	<p>Specify <i>with moisture barrier</i>.</p> <p>Add suffix <b>F</b> to the style number.</p>
	<ul style="list-style-type: none"> <li>• <b>Plastisol arm cap</b></li> <li>• Arm cap</li> </ul>	<p style="text-align: right;">+\$ 84</p>	<p>Specify <i>with plastisol arm caps</i> and select plastic color number.</p>
<b>Wallsaver Legs</b>	<ul style="list-style-type: none"> <li>• Wallsaver legs</li> </ul>	<p style="text-align: right;">+\$104</p>	<p>Specify <i>with wallsaver legs</i>.</p>
<b>Floor Glide Inserts</b>	<ul style="list-style-type: none"> <li>• Floor glide inserts</li> </ul>	<p style="text-align: right;">No cost</p>	<p>Specify <i>with floor glide inserts</i>.</p>
<b>Related Product</b>	<ul style="list-style-type: none"> <li>• Outlook Tables</li> </ul>		<p>▶ Page 238</p>

#### Specification Information

Style Number	U.S. Base Prices										COM
	Fabric Price Group 1	Fabric Price Group 2	Fabric Price Group 3	Fabric Price Group 4	Fabric Price Group 5	Fabric Price Group 6	Fabric Price Group 7	Fabric Price Group 8	Fabric Price Group 9	Fabric Price Group 10	
	<b>SC2295</b>	\$1273	\$1365	\$1457	\$1529	\$1601	\$1655	\$1729	\$1839	\$1985	



**For Canadian Pricing**

Multiply U.S. Price by the Canadian price factor.

▶ See page 1 for details.

## Easy Access Chair

With Arms

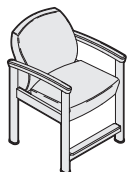

*Tip: Different fabrics for the seat and back can be specified. If the fabrics are in different price groups, calculate list price by adding the two price groups together and dividing by two.*

Standard Includes	Required to Specify
-------------------	---------------------

- |  |   |   |
|--|---|---|
| <ul style="list-style-type: none"> <li>▶ Need help? Product details, page 169</li> </ul> | <ul style="list-style-type: none"> <li>• Seat and back: fabric</li> <li>• Arm caps: wood</li> <li>• Oval legs: black paint</li> <li>• Glides: black only</li> </ul> | <ol style="list-style-type: none"> <li>1 Style number</li> <li>2 Fabric color number for seat and back</li> <li>3 Wood color number for side stretcher and arm caps</li> <li>4 Paint color number for oval legs</li> <li>5 Options, if selected (see below)</li> </ol> <p>▶ See <i>Surface Materials</i>, page 691.</p> |
|--|---|---|

Options	U.S. Price	Required to Specify
---------	------------	---------------------

<b>Surface Materials</b> <ul style="list-style-type: none"> <li>• <b>Moisture barrier</b></li> <li>• Moisture barrier</li> <li>• <b>Fire code seating</b></li> <li>• CAL 133</li> </ul>	<ul style="list-style-type: none"> <li>+\$ 83</li> <li>+\$188</li> </ul>	<p>Specify with <i>moisture barrier</i>.</p> <p>Add suffix <b>F</b> to the style number.</p>
<ul style="list-style-type: none"> <li>• <b>Plastisol arm cap</b></li> <li>• Arm cap</li> </ul>	<ul style="list-style-type: none"> <li>+\$ 84</li> </ul>	<p>Specify with <i>plastisol arm caps</i> and select plastic color number.</p>
<b>Floor Glide Inserts</b> <ul style="list-style-type: none"> <li>• Floor glide inserts</li> </ul>	<ul style="list-style-type: none"> <li>No cost</li> </ul>	<p>Specify with <i>floor glide inserts</i>.</p>
<b>Related Product</b> <ul style="list-style-type: none"> <li>• Outlook Tables</li> </ul>		<p>▶ Page 238</p>

### Specification Information

Style Number	U.S. Base Prices										COM
	Fabric Price Group 1	Fabric Price Group 2	Fabric Price Group 3	Fabric Price Group 4	Fabric Price Group 5	Fabric Price Group 6	Fabric Price Group 7	Fabric Price Group 8	Fabric Price Group 9	Fabric Price Group 10	
<b>SC2207</b>	\$1163	\$1215	\$1267	\$1309	\$1351	\$1381	\$1423	\$1485	\$1569	\$1621	\$1195



**For Canadian Pricing**  
 Multiply U.S. Price by the Canadian price factor.  
 ▶ See page 1 for details.

# Freestanding Tables

**Freestanding Tables**

are available to coordinate with multiple seating lines.

**Top** has a 1" thick wood core with a high-pressure laminate surface.

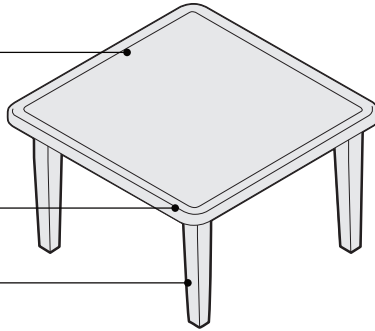

**Edge** is either maple wood or 3 mm plastic.

**Legs** are available in four styles to coordinate with multiple seating lines. Tapered leg style coordinates with Sequoia, Empress, and Nikko seating lines. Curved leg style coordinates with the Hawthorne and Linden seating lines and the metal leg style coordinates with the Jarrah seating line. The oval leg style offers an additional aesthetic option.

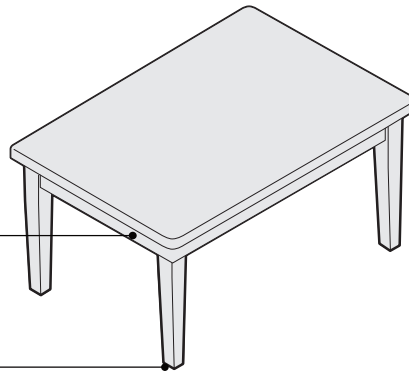

**Apron**, on select freestanding tables, is maple wood.

**Glides** are standard on legs.

**Actual Dimensions**

Features	Overall Depth	Width	Height
<b>Freestanding Tables—Wood or Plastic Edge</b>			
Square	18", 26"	18", 26"	16" or 21"
Rectangle	18", 20", or 22"	24", 32", or 48"	16" or 21"

**Product Details**

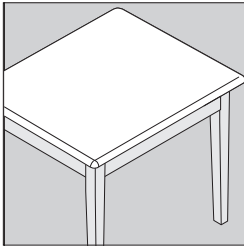

Metal (Jarrah)

**Metal legs** complement the Jarrah seating line.

**Wood edge** is a 1" thick bullnose.

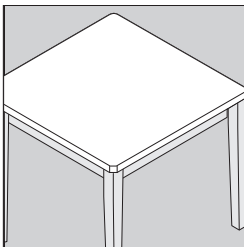

Tapered (Sequoia)

**Tapered legs** are maple wood construction and complement the Sequoia, Empress, and Nikko seating lines.

**Plastic edge** features a 3 mm radius.

*Tip: The plastic edge will match standard laminate tops. A black plastic edge will be used on tables with non-standard laminate tops.*



Curved (Hawthorne)

**Curved Legs** are maple wood construction and complement the Hawthorne and Linden seating lines.

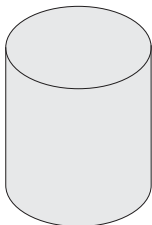

**Drum table** is available in two sizes. It has a High-Pressure Laminate top surface and body.



Oval

**Oval Legs** are maple wood construction and can be used with multiple seating lines as another aesthetic option.

**Surface Materials**

**Table top**  
 • High-Pressure Laminate

**Edge**  
 • Maple wood  
 • Plastic

**Legs**  
 • Maple wood

**Table apron, if selected**  
 • Maple wood

**Attachment brackets on interconnecting table**  
 • Black only

**Glides**  
 • Black nylon only

**Shipping**

**Tables** are shipped unassembled and require field assembly of legs.

# Freestanding Tables

## Freestanding Tables with Wood Edge

Standard Includes	Required to Specify
<ul style="list-style-type: none"> <li>▶ Need help? Product details, page 312</li> </ul>	<ul style="list-style-type: none"> <li>• Top: High-Pressure Laminate</li> <li>• Edge: maple wood to match top</li> <li>• Legs: wood or paint (if metal leg selected)</li> <li>• Attachment brackets: black only</li> <li>• Glides: black nylon</li> </ul>
	<ul style="list-style-type: none"> <li>1 Style number</li> <li>2 Laminate color number for top</li> <li>3 Paint color for legs, if metal leg selected</li> <li>▶ See <i>Surface Materials</i>, page 691.</li> </ul>

Specification Information				
• Dimensions			• Style	• U.S.
D	W	H	Number	Price

### Square Tables with Metal Legs

26"	26"	16"	<b>HTM262616W</b>	\$880
26"	26"	21"	<b>HTM262621W</b>	\$880

### Square Tables with Tapered Legs

18"	18"	21"	<b>HTT181821W</b>	\$627
26"	26"	16"	<b>HTT262616W</b>	\$701
26"	26"	21"	<b>HTT262621W</b>	\$701

### Square Tables with Curved Legs

26"	26"	16"	<b>HTC262616W</b> <span style="color: red;">X4/12</span>	\$880
26"	26"	21"	<b>HTC262621W</b>	\$880

### Square Tables with Oval Legs

26"	26"	21"	<b>HTV262621W</b> <span style="color: red;">X4/12</span>	\$701
-----	-----	-----	--	-------

▶ **Specification Information, continued on next page**

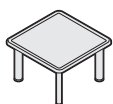

Tip: Metal leg tables complement Jarrah seating line.

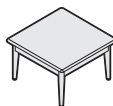

Tip: Tapered leg tables complement Sequoia, Nikko, and Empress seating lines.

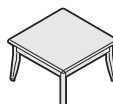

Tip: Curved leg tables complement Hawthorne and Linden seating lines.

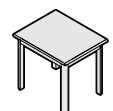

#### For Canadian Pricing

Multiply U.S. Price by the Canadian price factor.

▶ See page 1 for details.

X4/12 = Last order entry  
April 15, 2012

► Specification Information, continued from previous page

**Specification Information**

Dimensions			Style	U.S.
D	W	H	Number	Price

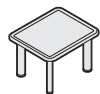

**Rectangular Tables with Metal Legs**

20"	24"	16"	<b>HTM242016W</b> <span style="color: red;">X4/12</span>	\$ 701
20"	24"	21"	<b>HTM242021W</b>	\$ 701
22"	32"	16"	<b>HTM322216W</b> <span style="color: red;">X4/12</span>	\$ 901
18"	48"	16"	<b>HTM481816W</b>	\$1024

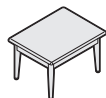

**Rectangular Tables with Tapered Legs**

20"	24"	16"	<b>HTT242016W</b> <span style="color: red;">X4/12</span>	\$ 627
20"	24"	21"	<b>HTT242021W</b>	\$ 627
22"	32"	16"	<b>HTT322216W</b> <span style="color: red;">X4/12</span>	\$ 722
18"	48"	16"	<b>HTT481816W</b>	\$ 769

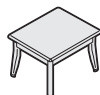

**Rectangular Tables with Curved Legs**

20"	24"	16"	<b>HTC242016W</b> <span style="color: red;">X4/12</span>	\$ 701
20"	24"	21"	<b>HTC242021W</b>	\$ 701
22"	32"	16"	<b>HTC322216W</b> <span style="color: red;">X4/12</span>	\$ 901
18"	48"	16"	<b>HTC481816W</b>	\$1024

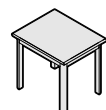

**Rectangular Tables with Oval Legs**

20"	24"	21"	<b>HTV242021W</b> <span style="color: red;">X4/12</span>	\$ 627
18"	48"	16"	<b>HTV481816W</b> <span style="color: red;">X4/12</span>	\$ 842



**Round Tables with Oval Legs**

24"dia		21"	<b>HTV24R21W</b> <span style="color: red;">X4/12</span>	\$ 786
--------	--	-----	---	--------



**Round Tables with Tapered Legs**

24"dia		21"	<b>HTT24R21W</b>	\$ 701
--------	--	-----	------------------	--------

Families of Seating

 **For Canadian Pricing**  
 Multiply U.S. Price by the  
 Canadian price factor.  
 ► See page 1 for details.

X4/12 = Last order entry  
 April 15, 2012

Freestanding Tables, continued

**Freestanding Tables with Plastic Edge**

Standard Includes	Required to Specify
<ul style="list-style-type: none"> <li>▶ Need help? Product details, page 312</li> <li>• Top: High-Pressure Laminate</li> <li>• Edge: plastic to match</li> <li>• Legs: wood or paint (if metal leg selected)</li> <li>• Glides: black nylon</li> </ul>	<ul style="list-style-type: none"> <li>1 Style number</li> <li>2 Laminate color number for top</li> <li>3 Paint color for legs, if metal selected</li> <li>▶ See <i>Surface Materials</i>, page 691.</li> </ul>

**Specification Information**

Dimensions			Style	U.S.
D	W	H	Number	Price

**Square Tables with Metal Legs**

26"	26"	16"	<b>HTM262616P</b>	\$640
26"	26"	21"	<b>HTM262621P</b>	\$640

**Square Tables with Tapered Legs**

26"	26"	16"	<b>HTT262616P</b>	\$640
26"	26"	21"	<b>HTT262621P</b>	\$640

**Square Tables with Curved Legs**

26"	26"	16"	<b>HTC262616P</b> <span style="color: red;">X4/12</span>	\$640
26"	26"	21"	<b>HTC262621P</b>	\$640

**Rectangular Tables with Metal Legs**

20"	24"	16"	<b>HTM242016P</b> <span style="color: red;">X4/12</span>	\$531
20"	24"	21"	<b>HTM242021P</b>	\$531
22"	32"	16"	<b>HTM322216P</b> <span style="color: red;">X4/12</span>	\$653
18"	48"	16"	<b>HTM481816P</b>	\$781

**Rectangular Tables with Tapered Legs**

20"	24"	16"	<b>HTT242016P</b> <span style="color: red;">X4/12</span>	\$531
20"	24"	21"	<b>HTT242021P</b>	\$531
22"	32"	16"	<b>HTT322216P</b> <span style="color: red;">X4/12</span>	\$653
18"	48"	16"	<b>HTT481816P</b>	\$781

**Rectangular Tables with Curved Legs**

20"	24"	16"	<b>HTC242016P</b> <span style="color: red;">X4/12</span>	\$531
20"	24"	21"	<b>HTC242021P</b>	\$531
22"	32"	16"	<b>HTC322216P</b> <span style="color: red;">X4/12</span>	\$653
18"	48"	16"	<b>HTC481816P</b>	\$781

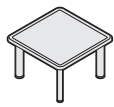

Tip: Metal leg tables complement Jarrah seating line.

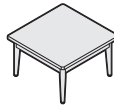

Tip: Tapered leg tables complement Sequoia, Nikko, and Empress seating lines.

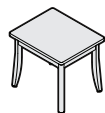
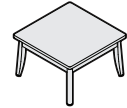

X4/12 = Last order entry  
April 15, 2012

## Drum Table

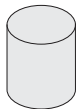

Standard Includes		Required to Specify
<ul style="list-style-type: none"> <li>▶ Need help? Product details, page 312</li> </ul>	<ul style="list-style-type: none"> <li>• Top: High-Pressure Laminate</li> <li>• Edge: plastic to match</li> </ul>	<ul style="list-style-type: none"> <li>1 Style number</li> <li>2 Laminate color number for top</li> <li>▶ See <i>Surface Materials</i>, page 691.</li> </ul>

Specification Information			
Dimensions		Style	U.S.
D	H	Number	Price
18"	18"	<b>SC27DT18D</b>	\$431
24"	18"	<b>SC27DT24D</b>	\$569
:	:	:	:

Families of Seating



**For Canadian Pricing**  
 Multiply U.S. Price by the Canadian price factor.  
 ▶ See page 1 for details.

---

# Surface Materials

<b>Nurture Surface Materials</b>	<b>692</b>
Color Availability Matrix for Nurture Casegoods	<b>694</b>
Color Availability Matrix for Nurture Seating and Tables	<b>696</b>
Recommended Worksurface Edge Finishes	<b>700</b>
<b>Steelcase Seating Surface Materials</b>	<b>701</b>
<b>Steelcase Wood Seating Surface Materials</b>	<b>702</b>
<b>Turnstone Seating Surface Materials</b>	<b>703</b>
<b>Visual Worktools Surface Materials</b>	<b>704</b>
<b>Upholstery and Color Numbers</b>	<b>706</b>
<b>Nurture Graded-In Programs</b>	
Acrylic Panel	<b>708</b>
Solid Surface	<b>708</b>
Upholstery	<b>709</b>
Fabric Application Direction Guidelines	<b>712</b>

# Nurture Surface Materials

**This listing** includes all the surface material choices that are available for the Nurture products in this specification guide.

## Resources

For more information about Nurture surface materials or to get surface material samples, contact Nurture at 1.800.342.8562.

Materials and colors are not available on every product. Refer to the Color Availability Matrices before specifying.

## Plastisol/Urethane

6059 Sterling Dark  
6161 Graphite  
6162 Taupe  
6205 Black

## Paint

4750 Champagne Metallic  
4798 Sterling  
4799 Platinum Metallic  
4851 Wheat  
4853 Cream  
4854 Graphite  
4855 Silver  
7207 Black  
7225 Sand  
7237 Slate  
7238 Fieldstone  
7239 Midnight  
7241 Arctic White  
7243 Seagull

## Metal

Polished Chrome  
Brushed Stainless Steel  
Nickel Steel

## Wood

### Veneer

3402 Clear Cherry  
3412 Natural Cherry **E**  
3416 Light Cherry (W-15)  
3422 Medium Cherry  
3456 Clear on Ash  
3457 Almond on Ash  
3458 Samba on Ash  
3459 Cognac on Ash  
3460 Dark Rum on Ash  
3461 Shiraz on Ash  
3462 Flamenco on Ash  
3522 Clear Maple  
3572 Amber Maple  
3575 Sugarloaf Maple  
3576 Almond Cherry  
3577 Samba Cherry  
3578 Cognac Cherry  
3579 Dark Rum Cherry  
3580 Shiraz Cherry  
3581 Flamenco Cherry  
3592 Blonde on Maple  
3602 Desert Oak  
3620 English Oak (W-20)  
3730 Mahogany (W-45)  
3772 Medium Mahogany on Walnut  
3970 Ebony (W-60)

## Laminate

### Laminate

2570 Sugarloaf Maple  
2571 Almond Cherry  
2572 Samba Cherry  
2573 Cognac Cherry  
2574 Dark Rum Cherry  
2575 Shiraz Cherry  
2576 Flamenco Cherry

### Steelcase High-Pressure Laminate

Applies to:

- Cura Tables
- Exchange Tables
- Folio Worksurfaces
- Malibu Tables
- Neighbor Tables
- Progeny Tables
- Rave Tables
- Sieste Tables
- Sine Tables
- Sonata Tops
- Sync

## Fiber Laminate

2850 Vanadium Fiber  
2851 Rhyme Fiber  
2852 Tungsten Fiber  
2854 Vellum Fiber  
2859 Novell Fiber  
2860 Granite Fiber  
2861 Coconut Fiber  
2862 Stucco Fiber

## Micro Laminate

2920 Marl Micro  
2921 Gypsum Micro  
2922 Clay Micro  
2923 Shadow Micro

## Patina Laminate

2870 Blonde Bronze Patina  
2871 Blackened Bronze Patina  
2873 Instant Iron Patina

## Solid Laminate

2722 Cream **E**  
2730 Arctic White  
2746 Black  
2759 Warm White **E**  
2766 Warm Brown V1  
2782 Grey V1  
2811 Mist **E**  
2883 Seagull  
2884 Milk  
2885 Dune

## Speckle Laminate

2820 Coffee Speckle  
2822 Woodrose Speckle  
2823 Driftwood Speckle  
2824 Smoke Speckle  
2825 Vanadium Speckle

## Woodgrain Laminate

2409 Clear Maple  
2410 Graphite Walnut  
2412 Natural Cherry  
2422 Medium Cherry  
2511 Winter on Maple  
2538 Clear Walnut  
2539 Warm Oak  
2592 Blonde on Maple  
2714 Natural Walnut  
2772 Medium Mahogany on Walnut **E**

## Turnstone Laminate Collection

A selection of laminates and edge bands in this collection are available on Steelcase brand products. This collection is available with standard leadtimes and supported like standard laminates to help make ordering easy. Please see the Turnstone section of [in2.steelcase.com](http://in2.steelcase.com) for swatching information.

2535 Virginia Walnut  
2536 Blackwood  
2612 Marbled Maple  
2614 Chocolate Walnut  
2615 Marbled Cherry

## Open Line Laminate (OLL)

Open Line laminates are available at an additional \$64 (U.S.) per surface, plus the cost of the laminate.

Example:

4' x 8' sheet = 32 square feet  
32 square feet x \$1.10 = \$35.20 (U.S.) per sheet  
Laminate costs vary by supplier. The cost of the laminate will be added to your invoice as a separate line on the acknowledgement.

Applies to:

- Exchange tables
- Folio Laminate worksurfaces
- Opus
- Sonata
- Jenny
- Sync

This service allows you to order non-standard laminate at an additional fee per unit. See the specification pages for upcharge information.

**When processing orders for Open Line Laminate on Opus or Sonata**, specify 2902 in the laminate finish field and enter the OLL manufacturer information.

**Edge bands** must also be specified and will incur an \$83 upcharge.

6131 White  
6132 Grey  
6133 Folkstone  
6134 Northsea  
6135 Shadow  
6136 Nubian Brown  
6137 Black

## When processing orders for Open Line Laminate

**on Jenny, Exchange tables, Folio Laminate Worksurfaces, and Sync**, specify 2900 in the laminate finish field and enter the OLL manufacturer information.

**Edge bands** must also be specified using the plastic edge band offering.

## Thermoform

2030 Arctic White  
2031 Seagull  
2032 Dune  
2065 Sugarloaf Maple  
2066 Almond Cherry  
2068 Cognac Cherry  
2069 Dark Rum Cherry  
2070 Shiraz Cherry  
2071 Flamenco Cherry  
2072 Samba Cherry  
6775 Sand

## Solid Surface

Applies to:

- Folio Worksurfaces
- Leela
- Senza
- Sonata
- Sync
- Tava

## Price Group A

2975 Bisque

## Price Group B

2973 Linen

## Price Group C

2972 Antarctica  
2974 Canvas

**E** = Established

**Plastic Edge Band**

- 6013 Sugarloaf Maple
- 6014 Almond Cherry
- 6021 Samba Cherry
- 6022 Cognac Cherry
- 6023 Dark Rum Cherry
- 6024 Shiraz Cherry
- 6025 Flamenco Cherry

Applies to:

- Cura tables
- Exchange tables
- Folio Worksurfaces
- Sync

- 6000 Black
- 6001 Coffee
- 6034 Natural Cherry
- 6036 Medium Cherry
- 6037 Winter on Maple
- 6038 Blonde on Maple
- 6041 Natural Walnut
- 6052 Milk
- 6053 Seagull
- 6231 Graphite Walnut
- 6237 Clear Maple
- 6242 Virginia Walnut
- 6243 Blackwood
- 6245 Clear Walnut
- 6246 Warm Oak
- 6249 Platinum Solid
- 6615 Grey Value 5
- 6619 Ice **E**
- 6631 Cream
- 6635 Dawn **E**
- 6636 Mist
- 6654 Sand
- 6655 Warm White
- 6676 Marbled Maple
- 6677 Chocolate Walnut
- 6678 Marbled Cherry
- 6694 Slate
- 6695 Midnight
- 6697 Fog

**Fusion**

Applies to:

- Sonata island modules

**Price Group 1**

- 6526 Mulberry Tissue

**Price Group 3**

- 6523 Desert Stalk

**Price Group 4**

- 6525 Sheer Leaf Medium

**Soft Pulls**

- 6000 Black

**E** = Established

**Markerboard**

Applies to:

- Opus wardrobe cabinet with sliding door only
- White

**Urethane**

Applies to:

- Verge seat
- 6688 Non metallic steel

**CuraNet**

Applies to:

- Cura
- 5081 Ash (Silver Grey)  
5083 Lily Pad (Moss)  
5085 Ebony (Black)  
5086 Camel  
5087 Cocoa  
5088 Aquamarine

**Promessa**

Applies to:

- Cura
- UL81 Ash  
UL83 Lily Pad  
UL85 Ebony  
UL86 Camel  
UL87 Cocoa  
UL88 Aquamarine

**Upholstery**

- ▶ See page 706 for a complete listing of upholstery colors and numbers

**California 133 Option**

Nurture offers Fire Code Seating Modifications (FCS) on nearly all seating models. The most rigorous fire codes in the nation have been developed in California, and the Steelcase FCS modification is designed to meet those codes. Fire Code Seating (FCS) indicates that a product is constructed to meet the strict fire code requirements of high public occupancy areas such as hospitals, theaters, meeting rooms, and lobbies. The FCS standards will meet both the State of California Home Furnishings Technical Bulletin 133 (CAL TB 133) and Boston Fire Code (BFC). Boston adopted the California Home Furnishing Technical Bulletin CAL TB 133 test standard in 1992.

CAL 133 is specified using an "F" suffix. When an "F" suffix is available, it means that these models have been tested and certified using approved fabrics. A complete list of approved fabrics are listed on the COM website at [www.Steelcase.com](http://www.Steelcase.com)

If a specific chair/fabric combination has not been tested, an actual burn test can be performed on the product in the specified fabric. The cost of the test is \$700 (net). Please allow a minimum of six weeks for the production of the chair and the completion of the test.

# Color Availability Matrix for Nurture Casegoods

## Legend

- = Not available
- = Available
- = Available with exceptions
- ▶ See specification pages for details.

		Veneer						Laminate								Solid Surface						
		3575	3576	3577	3578	3579	3580	3581	2570	2571	2572	2573	2574	2575	2576	2730	2883	2885	2972	2973	2974	2975
		Sugarloaf Maple	Almond Cherry	Samba Cherry	Cognac Cherry	Dark Rum Cherry	Shiraz Cherry	Flamenco Cherry	Sugarloaf Maple	Almond Cherry	Samba Cherry	Cognac Cherry	Dark Rum Cherry	Shiraz Cherry	Flamenco Cherry	Arctic White	Seagull	Dune	Antarctica	Linen	Canvas	Bisque
<b>Ainsley</b>		■	■	■	■	■	■	■	■	■	■	■	■	■	■	■	■	■	■	■	■	■
<b>Davenport</b>		•	•	•	•	•	•	•	■	■	■	■	■	■	■	■	■	■	■	■	■	■
<b>Exchange Table</b>	Base	•	•	•	•	•	•	•	•	•	•	•	•	•	•	•	•	•	•	•	•	•
	Table Top*	•	•	•	•	•	•	•	■	■	■	■	■	■	■	■	■	■	■	■	■	■
<b>Folio</b>	Cabinets	•	•	•	•	•	•	•	■	■	■	■	■	■	■	■	■	■	■	■	■	■
	Laminate Worksurfaces*	•	•	•	•	•	•	•	■	■	■	■	■	■	■	■	■	■	■	■	■	■
	Solid Surface Worksurfaces	•	•	•	•	•	•	•	•	•	•	•	•	•	•	•	•	•	■	■	■	■
<b>Opus</b>	Cabinets	•	•	•	•	•	•	•	■	■	■	■	■	■	■	■	■	■	■	■	■	■
	Door pulls, table rails, and coat hooks	•	•	•	•	•	•	•	•	•	•	•	•	•	•	•	•	•	•	•	•	•
<b>Park</b>		•	•	•	•	•	•	•	■	■	■	■	■	■	■	■	■	■	■	■	■	■
<b>Senza</b>		■	■	■	■	■	■	■	■	■	■	■	■	■	■	■	■	■	■	■	■	■
<b>Sonata*</b>	Cabinets	•	•	•	•	•	•	•	■	■	■	■	■	■	■	■	■	■	■	■	■	■
	Rails, drawer/door pulls, and coat hooks	•	•	•	•	•	•	•	•	•	•	•	•	•	•	•	•	•	•	•	•	•
<b>Sync*</b>		•	•	•	•	•	•	•	■	■	■	■	■	■	■	■	■	■	■	■	■	■
<b>Viridian</b>		•	•	•	•	•	•	•	•	•	•	•	•	•	•	•	•	•	•	•	•	•
<b>Waldorf</b>		■	■	■	■	■	■	■	•	•	•	•	•	•	•	•	•	•	•	•	•	•
<b>Overbed Tables</b>		•	•	•	•	•	•	•	■	■	■	■	■	■	■	■	■	■	■	■	■	■
<b>Headboards/Footboards</b>		■	■	■	■	■	■	■	■	■	■	■	■	■	■	■	■	■	■	■	■	■

\*Exchange table tops, Folio worksurfaces, Sonata tops, and Sync table tops are available in all Steelcase laminates.

▶ See page 701



# Color Availability Matrix for Nurture Seating and Tables

## Legend

- = Not available
- = Available
- = Available with exceptions
- ▶ See specification pages for details.

		Veneer																									
		3402	3412	3416	3422	3456	3457	3458	3459	3460	3461	3462	3522	3572	3575	3576	3577	3578	3579	3580	3581	3592	3602	3620	3730	3772	3970
		Clear Cherry	Natural Cherry <sup>E</sup>	Light Cherry (W-15)	Medium Cherry	Clear on Ash	Almond on Ash	Samba on Ash	Cognac on Ash	Dark Rum on Ash	Shiraz on Ash	Flamenco on Ash	Clear Maple	Amber Maple	Sugarloaf Maple	Almond Cherry	Samba Cherry	Cognac Cherry	Dark Rum Cherry	Shiraz Cherry	Flamenco Cherry	Blonde on Maple	Desert Oak	English Oak (W-20)	Mahogany (W-45)	Medium Mahogany on Walnut	Ebony (W-60)
<b>Amaris</b>	Legs	•	•	•	•	•	•	•	•	•	•	•	•	•	•	•	•	•	•	•	•	•	•	•	•	•	•
	Arm Caps	•	•	•	•	•	•	•	•	•	•	•	•	•	•	•	•	•	•	•	•	•	•	•	•	•	•
<b>Asana</b>		•	•	•	•	•	•	•	•	•	•	•	•	•	•	•	•	•	•	•	•	•	•	•	•	•	•
<b>Aspekt</b>	Seating Frame	•	•	•	•	•	•	•	•	•	•	•	•	•	•	•	•	•	•	•	•	•	•	•	•	•	•
	Arm Caps	•	•	•	•	•	•	•	•	•	•	•	•	•	•	•	•	•	•	•	•	•	•	•	•	•	•
	Table Legs	•	•	•	•	•	•	•	•	•	•	•	•	•	•	•	•	•	•	•	•	•	•	•	•	•	•
	Table Top	•	•	•	•	•	•	•	•	•	•	•	•	•	•	•	•	•	•	•	•	•	•	•	•	•	•
<b>Cura</b>	Arm Caps	•	•	•	•	•	•	•	•	•	•	•	•	•	•	•	•	•	•	•	•	•	•	•	•	•	•
	Frame	•	•	•	•	•	•	•	•	•	•	•	•	•	•	•	•	•	•	•	•	•	•	•	•	•	•
	Table Top*	•	•	•	•	•	•	•	•	•	•	•	•	•	•	•	•	•	•	•	•	•	•	•	•	•	•
<b>Cypress</b>		•	•	•	•	•	•	•	•	•	•	•	•	•	•	•	•	•	•	•	•	•	•	•	•	•	•
<b>Empress</b>	Lounge Frame	•	•	•	•	•	•	•	•	•	•	•	•	•	•	•	•	•	•	•	•	•	•	•	•	•	•
	Lounge Arm Caps	•	•	•	•	•	•	•	•	•	•	•	•	•	•	•	•	•	•	•	•	•	•	•	•	•	•
<b>Flex Back</b>		•	•	•	•	•	•	•	•	•	•	•	•	•	•	•	•	•	•	•	•	•	•	•	•	•	•
<b>Flute</b>		•	•	•	•	•	•	•	•	•	•	•	•	•	•	•	•	•	•	•	•	•	•	•	•	•	•
<b>Hawthorne</b>	Seating	•	•	•	•	•	•	•	•	•	•	•	•	•	•	•	•	•	•	•	•	•	•	•	•	•	•
<b>Jarrah</b>	Side Trim Panel	•	•	•	•	•	•	•	•	•	•	•	•	•	•	•	•	•	•	•	•	•	•	•	•	•	•
	Seating Legs	•	•	•	•	•	•	•	•	•	•	•	•	•	•	•	•	•	•	•	•	•	•	•	•	•	•
	Arm Caps	•	•	•	•	•	•	•	•	•	•	•	•	•	•	•	•	•	•	•	•	•	•	•	•	•	•
<b>Leela</b>	Arm Caps	•	•	•	•	•	•	•	•	•	•	•	•	•	•	•	•	•	•	•	•	•	•	•	•	•	•
	Legs	•	•	•	•	•	•	•	•	•	•	•	•	•	•	•	•	•	•	•	•	•	•	•	•	•	•
	Table Top	•	•	•	•	•	•	•	•	•	•	•	•	•	•	•	•	•	•	•	•	•	•	•	•	•	•
<b>Linden</b>	Seating Base	•	•	•	•	•	•	•	•	•	•	•	•	•	•	•	•	•	•	•	•	•	•	•	•	•	•
	Arm Caps	•	•	•	•	•	•	•	•	•	•	•	•	•	•	•	•	•	•	•	•	•	•	•	•	•	•
<b>Loria</b>		•	•	•	•	•	•	•	•	•	•	•	•	•	•	•	•	•	•	•	•	•	•	•	•	•	•
<b>Kami</b>		•	•	•	•	•	•	•	•	•	•	•	•	•	•	•	•	•	•	•	•	•	•	•	•	•	•
<b>Malibu</b>	Seating	■	■	■	■	•	•	•	•	•	•	•	■	■	■	■	■	■	■	■	■	■	■	■	■	■	■
	Tables*	■	■	■	■	•	•	•	•	•	•	•	■	■	■	■	■	■	■	■	■	■	■	■	■	■	■
<b>Malibu Too</b>		■	■	■	■	•	•	•	•	•	•	■	■	■	■	■	■	■	■	■	■	■	■	■	■	■	■
<b>Mineral</b>	Arm Caps	•	•	•	•	•	•	•	•	•	•	•	•	•	•	•	•	•	•	•	•	•	•	•	•	•	•
<b>Mitra</b>	Seating Frame	•	•	•	•	•	•	•	•	•	•	•	•	•	•	•	•	•	•	•	•	•	•	•	•	•	•
	Arm Caps	•	•	•	•	•	•	•	•	•	•	•	•	•	•	•	•	•	•	•	•	•	•	•	•	•	•
	Table Legs and Bases	•	•	•	•	•	•	•	•	•	•	•	•	•	•	•	•	•	•	•	•	•	•	•	•	•	•
	Table Top	•	•	•	•	•	•	•	•	•	•	•	•	•	•	•	•	•	•	•	•	•	•	•	•	•	•

- <sup>E</sup> = Established
- \* Also available in Steelcase Laminates.
- ▶ See page 701



Color Availability Matrix for Nurture Seating and Tables, continued

**Legend**

- = Not available
- = Available
- = Available with exceptions
- ▶ See specification pages for details.

		Veneer	3402	3412	3416	3422	3456	3457	3458	3459	3460	3461	3462	3522	3572	3575	3576	3577	3578	3579	3580	3581	3592	3602	3620	3730	3772	3970
			Clear Cherry	Natural Cherry <b>E</b>	Light Cherry (W-15)	Medium Cherry	Clear on Ash	Almond on Ash	Samba on Ash	Cognac on Ash	Dark Rum on Ash	Shiraz on Ash	Flamenco on Ash	Clear Maple	Amber Maple	Sugarloaf Maple	Almond Cherry	Samba Cherry	Cognac Cherry	Dark Rum Cherry	Shiraz Cherry	Flamenco Cherry	Blonde on Maple	Desert Oak	English Oak (W-20)	Mahogany (W-45)	Medium Mahogany on Walnut	Ebony (W-60)
<b>Neighbor</b>	Frames	•	•	•	•	•	•	•	•	•	•	•	•	•	•	•	•	•	•	•	•	•	•	•	•	•	•	•
	Arm Cap	■	■	■	■	•	•	•	•	•	•	•	•	■	■	■	■	■	■	■	■	■	■	■	■	■	■	■
	Table Top*	■	■	■	■	•	•	•	•	•	•	•	•	■	■	■	■	■	■	■	■	■	■	■	■	■	■	■
<b>Nikko</b>	Seating Frame	•	•	•	•	•	•	•	•	•	•	•	•	•	•	■	■	■	■	■	■	■	•	•	•	•	•	•
	Arm Caps	•	•	•	•	•	•	•	•	•	•	•	•	•	•	■	■	■	■	■	■	■	•	•	•	•	•	•
<b>Orchid</b>		•	•	•	•	•	•	•	•	•	•	•	•	•	•	■	■	■	■	■	■	■	•	•	•	•	•	•
<b>Progeny</b>	Frame	■	■	■	■	•	•	•	•	•	•	•	•	■	■	■	■	■	■	■	■	■	■	■	■	■	■	■
	Arm Cap	■	■	■	■	•	•	•	•	•	•	•	•	■	■	■	■	■	■	■	■	■	■	■	■	■	■	■
	Table Top*	■	■	■	■	•	•	•	•	•	•	•	•	■	■	■	■	■	■	■	■	■	■	■	■	■	■	■
<b>Rave</b>	Arm Caps and Frame	■	■	■	■	•	•	•	•	•	•	•	•	■	■	■	■	■	■	■	■	■	■	■	■	■	■	■
	Tables*	■	■	■	■	•	•	•	•	•	•	•	•	■	■	■	■	■	■	■	■	■	■	■	■	■	■	■
<b>Sequoia</b>	Seating Frame	•	•	•	•	•	•	•	•	•	•	•	•	•	•	■	■	■	■	■	■	■	•	•	•	•	•	•
	Arm Caps	•	•	•	•	•	•	•	•	•	•	•	•	•	•	■	■	■	■	■	■	■	•	•	•	•	•	•
	Table Tops	•	•	•	•	•	•	•	•	•	•	•	•	•	•	•	•	•	•	•	•	•	•	•	•	•	•	•
<b>Sieste</b>	Arm Caps	■	■	■	■	•	•	•	•	•	•	•	•	■	■	■	■	■	■	■	■	■	■	■	■	■	■	■
	Legs	■	■	■	■	•	•	•	•	•	•	•	•	■	■	■	■	■	■	■	■	■	■	■	■	■	■	■
	Table Top*	■	■	■	■	•	•	•	•	•	•	•	•	■	■	■	■	■	■	■	■	■	■	■	■	■	■	■
<b>Sieste Sleeper</b>		■	■	■	■	•	•	•	•	•	•	•	•	■	■	■	■	■	■	■	■	■	■	■	■	■	■	■
<b>Sine</b>	Seating and Table Frame	•	•	•	•	•	•	•	•	•	•	•	•	•	•	•	•	•	•	•	•	•	•	•	•	•	•	•
	Table Top*	•	•	•	•	•	•	•	•	•	•	•	•	•	•	•	•	•	•	•	•	•	•	•	•	•	•	•
<b>Slumber Day Bed</b>		•	•	•	•	•	•	•	•	•	•	•	•	•	•	•	•	•	•	•	•	•	•	•	•	•	•	•
<b>Sorrel</b>	Seating Frame and Arm Caps	•	•	•	•	•	•	•	•	•	•	•	•	•	•	•	•	•	•	•	•	•	•	•	•	•	•	•
	Seating Backs	•	•	•	•	•	•	•	•	•	•	•	•	•	•	■	■	■	■	■	■	■	•	•	•	•	•	•
	Table Legs	•	•	•	•	•	•	•	•	•	•	•	•	•	•	•	•	•	•	•	•	•	•	•	•	•	•	•
	Table Tops	•	•	•	•	•	•	•	•	•	•	•	•	•	•	•	•	•	•	•	•	•	•	•	•	•	•	•
<b>Tava</b>	Arm and Legs	•	•	•	•	■	■	■	■	■	■	■	■	•	•	•	•	•	•	•	•	•	•	•	•	•	•	•
	Bench Body and Table Tops	•	•	•	•	•	•	•	•	•	•	•	•	•	•	•	•	•	•	•	•	•	•	•	•	•	•	•
<b>Traditional Lounge</b>		•	•	•	•	•	•	•	•	•	•	•	•	•	•	■	■	■	■	■	■	■	•	•	•	•	•	•
<b>X-tenz Sleeper</b>	Arm Caps	•	•	•	•	•	•	•	•	•	•	•	•	•	•	■	■	■	■	■	■	■	•	•	•	•	•	•
	Frame	•	•	•	•	•	•	•	•	•	•	•	•	•	•	•	•	•	•	•	•	•	•	•	•	•	•	•
<b>Verge</b>		•	•	•	•	•	•	•	•	•	•	•	•	•	•	•	•	•	•	•	•	•	•	•	•	•	•	•
<b>Freestanding and Interconnecting Tables</b>																												
	Table Top	•	•	•	•	•	•	•	•	•	•	•	•	•	•	•	•	•	•	•	•	•	•	•	•	•	•	•
	Metal Legs	•	•	•	•	•	•	•	•	•	•	•	•	•	•	•	•	•	•	•	•	•	•	•	•	•	•	•
	Wood Legs	•	•	•	•	•	•	•	•	•	•	•	•	•	•	■	■	■	■	■	■	■	•	•	•	•	•	•

**E** = Established  
 \* Also available in Steelcase Laminates.  
 ▶ See page 701



# Recommended Worksurface Edge Finishes

## Recommended Edge Colors

### Edges

The recommended edge color will complement the laminate color you specify. Edge color is specified separately.

Steelcase Laminate Color	Recommended 3 mm Edge Color
--------------------------	-----------------------------

Fiber	
<b>2850</b> Vanadium Fiber	<b>6654</b> Sand
<b>2851</b> Rhyme Fiber	<b>6631</b> Cream
<b>2852</b> Tungsten Fiber	<b>6636</b> Mist
<b>2854</b> Vellum Fiber	<b>6655</b> Warm White
<b>2859</b> Novell Fiber	<b>6001</b> Coffee
<b>2860</b> Granite Fiber	<b>6000</b> Black
<b>2861</b> Coconut Fiber	<b>6654</b> Sand
<b>2862</b> Stucco Fiber	<b>6053</b> Seagull

Micro	
<b>2920</b> Marl Micro	<b>6053</b> Seagull
<b>2921</b> Gypsum Micro	<b>6654</b> Sand
<b>2922</b> Clay Micro	<b>6654</b> Sand
<b>2923</b> Shadow Micro	<b>6249</b> Platinum Solid

Patina	
<b>2870</b> Blonde Bronze Patina	<b>6654</b> Sand
<b>2871</b> Blackened Bronze Patina	<b>6615</b> Grey Value 5
<b>2873</b> Instant Iron Patina	<b>6615</b> Grey Value 5

Solid	
<b>2722</b> Cream <b>E</b>	<b>6631</b> Cream
<b>2730</b> Arctic White	<b>6697</b> Fog
<b>2746</b> Black	<b>6000</b> Black
<b>2759</b> Warm White <b>E</b>	<b>6655</b> Warm White
<b>2811</b> Mist <b>E</b>	<b>6636</b> Mist
<b>2883</b> Seagull	<b>6053</b> Seagull
<b>2884</b> Milk	<b>6052</b> Milk
<b>2885</b> Dune	<b>6654</b> Sand

Speckle	
<b>2820</b> Coffee Speckle	<b>6631</b> Cream
<b>2822</b> Woodrose Speckle	<b>6635</b> Dawn <b>E</b>
<b>2823</b> Driftwood Speckle	<b>6631</b> Cream
<b>2824</b> Smoke Speckle	<b>6636</b> Mist
<b>2825</b> Vanadium Speckle	<b>6619</b> Ice <b>E</b>

Woodgrain	
<b>2409</b> Clear Maple	<b>6237</b> Clear Maple
<b>2410</b> Graphite Walnut	<b>6231</b> Graphite Walnut
<b>2412</b> Natural Cherry	<b>6034</b> Natural Cherry
<b>2422</b> Medium Cherry	<b>6036</b> Medium Cherry
<b>2511</b> Winter on Maple	<b>6037</b> Winter on Maple
<b>2538</b> Clear Walnut	<b>6245</b> Clear Walnut
<b>2539</b> Warm Oak	<b>6246</b> Warm Oak
<b>2592</b> Blonde on Maple	<b>6038</b> Blonde on Maple
<b>2714</b> Natural Walnut	<b>6041</b> Natural Walnut
<b>2772</b> Medium Mahogany on Walnut <b>E</b>	<b>6045</b> Medium Mahogany on Walnut <b>E</b>

Nurture Laminate Color	Recommended 3 mm Edge Color
------------------------	-----------------------------

Fiber	
<b>2570</b> Sugarloaf Maple	<b>6013</b> Sugarloaf Maple
<b>2571</b> Almond Cherry	<b>6014</b> Almond Cherry
<b>2572</b> Samba Cherry	<b>6021</b> Samba Cherry
<b>2573</b> Cognac Cherry	<b>6022</b> Cognac Cherry
<b>2574</b> Dark Rum Cherry	<b>6023</b> Dark Rum Cherry
<b>2575</b> Shiraz Cherry	<b>6024</b> Shiraz Cherry
<b>2576</b> Flamenco Cherry	<b>6025</b> Flamenco Cherry

**E** = Established

**This listing** includes all the surface material choices that are available for the products in this specification guide.

## Resources

For more information about surface materials, refer to the following resources:

**Additional surface materials specification tools** are available to assist you in the specification process—the Surface Materials Binders.

## Surface Materials Binders

- Surface Materials Reference Manual
- A complete set of swatch cards for hard surfaces, vertical surface fabrics, and seating upholstery

Materials and colors are not available on every product. Refer to the Color Availability and Upholstery Matrices before specifying.

## Plastic

- 6009 Arctic White
- 6059 Sterling Dark Solid
- 6205 Black
- 6206 Burgundy
- 6249 Platinum Solid
- 6250 Coffee
- 6256 Graphite
- 6259 Midnight
- 6268 Navy
- 6296 Sterling
- 6301 Aegean
- 6302 Baltic
- 6303 Pomegranate
- 6332 Citron
- 6333 Picasso
- 6334 Flash
- 6335 Wasabi
- 6336 Jazz
- 6337 Element
- 6338 Chili

## Seating Coating

- 7000 Black
- 7005 Coffee
- 7011 Graphite

## Paint

- 0835 Black
- 4799 Platinum Metallic
- 7239 Midnight

**E** = Established

## Metal

- 8046 Polished Aluminum
- 9201 Polished Chrome

## Laminate

- 2406 Clear Cherry
- 2409 Clear Maple
- 2410 Graphite Walnut
- 2412 Natural Cherry
- 2422 Medium Cherry
- 2511 Winter on Maple
- 2538 Clear Walnut
- 2539 Warm Oak
- 2714 Natural Walnut
- 2722 Cream
- 2730 Arctic White
- 2746 Black
- 2759 Warm White
- 2772 Medium Mahogany on Walnut **E**
- 2811 Mist
- 2883 Seagull
- 2884 Milk
- 2885 Dune

## Elmosoft Leather

- L110 Maritime Blue
- L111 Midnight Blue
- L112 Ebony
- L113 Gunmetal
- L114 Mica
- L115 Dove Grey
- L116 Plum Pleasure
- L122 Truffle
- L128 Red Birch
- L132 Violet
- L133 Espresso
- L134 Ruby
- L135 Scarlet
- L136 Claret
- L137 Cabernet
- L138 Bourbon
- L139 Cinder
- L140 Garnet
- L143 Pecan
- L144 Chamois
- L145 Palomino
- L146 Russet
- L147 Saddle
- L148 Goldstone
- L150 Ivory
- L151 White
- L709 Sugar
- L710 Lava
- L711 Parchment
- L712 Buff
- L713 Sand
- L714 Maize
- L715 Camel
- L716 Khaki
- L717 Cameo
- L718 Mushroom
- L719 Taupe
- L720 Fawn
- L721 Rock
- L722 Desert
- L723 Storm
- L724 Mist
- L725 Teal
- L726 Celadon
- L727 Egyptian Blue
- L728 Bright Blue
- L729 Aquarium
- L730 Hunter
- L731 Fern
- L732 Edamame
- L733 Moss
- L734 Key Lime
- L735 Creamsicle
- L736 Lemon
- L737 Sunshine
- L738 Drama
- L739 Byzantium
- L740 Dazzle
- L741 Fuchsia
- L742 Flamingo

## 3D Knit

- 5064 Licorice
- 5065 Coconut
- 5066 Malt
- 5067 Root Beer
- 5090 Wasabi
- 5091 Maya Blue
- 5092 Graphite
- 5093 Nickel
- 5094 Tangerine
- 5095 Scarlet
- 5096 Turmeric
- 5097 Concord
- 5098 Blue Jay
- 5099 Basil

## Upholstery

▶ See page 706 for a complete listing of upholstery colors and numbers.

▶ Check the COM database for specific product and fabric approvals.

# Steelcase Wood Seating Surface Materials

**This listing** includes all the surface material choices that are available for the Steelcase Wood Seating products in this specification guide.

## Resources

For more information about surface materials, refer to the following resources:

**Additional surface materials specification tools** are available to assist you in the specification process—the Surface Materials Binders.

## Surface Materials Binders

- include:
- Surface Materials Reference Manual
  - A complete set of swatch cards for hard surfaces, vertical surface fabrics, and seating upholstery

## Metal

- 4798 Sterling Metallic
- 7026 Nickel
- 7207 Black
- 8046 Polished Aluminum
- 9201 Polished Chrome

## Paint

- 0835 Black
- 4799 Platinum Metallic
- 7207 Black

## Wood

▶ See *Color Availability Matrix for Wood Seating in Surface Materials Reference Manual for color availability by product line.*

*Tip: The wood used in the construction of chairs is either maple or European beech. Wood finishes applied to maple or beech will match the color of stains applied to oak, walnut, or cherry, but will not have the same natural grain.*

- 3062 Graphite Walnut
- 3402 Clear Cherry
- 3412 Natural Cherry **E**
- 3422 Medium Cherry
- 3522 Clear Maple\*
- 3572 Amber on Maple
- 3592 Blonde on Maple
- 3602 Desert Oak
- 3612 Warm Oak
- 3692 Espresso Oak
- 3702 Clear Walnut
- 3712 Natural Walnut
- 3722 Dark Mahogany on Walnut
- 3752 Medium Walnut
- 3762 Dark Walnut
- 3772 Medium Mahogany on Walnut

*\*To ensure an understanding of the color ranges and characteristic variations of natural veneer, a sign-off sheet is required prior to orders being accepted for this clear-coat finish. The sign-off sheet is available through Steelcase advertising stock. Form number 05-0001370.*

**Customiz stain** is a service that allows you to create your own stain color. Minimum order quantities, per unit up-charges, and a one-time customer processing fee apply.

▶ See the *Surface Materials Reference Manual* for more information.

## Upholstery

▶ See page 706 for a complete listing of upholstery colors and numbers.

▶ Check the COM database for specific product and fabric approvals.

**E** = Established

► For Surface Materials matrices for all Turnstone product lines, see *Surface Materials Reference Manual*.

## Paint

Applies to:

- Scoop
- 4799 Platinum Metallic
- 7207 Black

Applies to:

- Jenny tablet arm
- 7207 Black

## Plastic

Applies to:

- Jenny tablet arm
- Jenny end table
- Jenny coffee table
- 6205 Black

Applies to:

- Scoop
- 6618 White
- 6682 Cobblestone

Applies to:

- Jenny end table edge band
- Jenny coffee table edge band
- 6000 Black
- 6009 Arctic White
- 6034 Natural Cherry **E**
- 6037 Winter on Maple
- 6053 Seagull
- 6234 Clear Cherry
- 6242 Virginia Walnut
- 6243 Blackwood
- 6245 Clear Walnut
- 6246 Warm Oak
- 6636 Mist
- 6654 Sand
- 6676 Marbled Maple
- 6677 Chocolate Walnut
- 6678 Marbled Cherry
- 6689 Brushed Silver

## Laminate

### Low-Pressure Laminate

Applies to:

- Jenny tablet arm
- Jenny end table
- Jenny coffee table
- 247L Black Version 2 LPL
- 25L1 Winter on Maple LPL
- 25L5 Virginia Walnut LPL
- 25L6 Blackwood LPL
- 25L8 Clear Walnut LPL
- 25L9 Warm Oak LPL
- 262L Marbled Maple LPL
- 264L Chocolate Walnut LPL
- 267L Marbled Cherry Version 2 LPL
- 26L1 Natural Cherry Version 2 LPL
- 2L03 Brushed Silver LPL
- 2L30 Arctic White LPL
- 2L50 Vanadium Fiber LPL
- 2L52 Tungsten Fiber LPL
- 2L83 Seagull LPL
- 2L85 Dune LPL

### High-Pressure Laminate

Applies to:

- Jenny tablet arm
- Jenny end table
- Jenny coffee table
- 2406 Clear Cherry
- 2412 Natural Cherry Version 2 HPL
- 2503 Brushed Silver HPL
- 2511 Winter on Maple HPL
- 2535 Virginia Walnut HPL
- 2536 Blackwood HPL
- 2538 Clear Walnut HPL
- 2539 Warm Oak HPL
- 2612 Marbled Maple HPL
- 2614 Chocolate Walnut HPL
- 2615 Marbled Cherry Version 2 HPL
- 2730 Arctic White HPL
- 2746 Black HPL
- 2850 Vanadium Fiber HPL
- 2852 Tungsten Fiber HPL
- 2883 Seagull HPL
- 2885 Dune HPL

*Note: Some wood veneer finishes and woodgrain laminates share the same name. Because of the difference in materials, veneers and laminates of the same name are not an exact match but do coordinate with each other.*

## Wood

Applies to:

- Jenny wood legs
- Jenny wood arm
- 3412 Natural Cherry **E**
- 3522 Clear Maple
- 3762 Dark Walnut

*Tip: Due to natural variations in wood, finished products may vary in color, texture and grain.*

## Turnstone Leather

T802 Black  
T803 Port  
L305 Brown Leather

## Upholstery

► See *Surface Materials Reference Manual* for a complete listing of upholstery colors and numbers.

► Check the COM database for specific product and fabric approvals.

**E** = Established

# Visual Worktools Surface Materials

**This listing** includes all surface material and/or finish choices applicable to Premium Whiteboards and Tackboards, and Contractor Series. Not all surface material and/or finish choices are available on all products. Please refer to the Finish Matrices.

► For surface materials matrices, see the *Visual Worktools Specification Guide*.

## Paint

### Price Group 2

- 0835 Black **E**
- 4750 Champagne Metallic
- 4798 Sterling Metallic
- 4799 Platinum Metallic

## Metal Paint

### Price Group 2

- 8043 Clear Anodized Aluminum
- 8044 Black Anodized Aluminum

## Wood

### Wood Trim Finishes

The wood finish is an open pore, high gloss finish on maple, cherry, or walnut. Colors match current Steelcase wood finishes in color only and do not match the Steelcase finish in sheen.

- 3412 FC/OP Natural Cherry **E**
- 3422 FC/OP Medium Cherry
- 3572 FC/OP Amber on Maple
- 3592 FC/OP Blonde on Maple
- 3712 FC/OP Natural Walnut on Walnut
- 3772 FC/OP Medium Mahogany on Walnut

## Markerboard Surface

Markerboards are standard in white high-gloss 7655 e<sup>3</sup> environmental ceramicsteel. Optional screenprint patterns are available to provide a guide for writing or drawing. See below for patterns.

### Standard:

- 7655 High Gloss White

### Optional Screenprint on e<sup>3</sup> environmental ceramicsteel:

- 7656 2" Circular Dot Pattern
- 7657 2" Grid Pattern
- 7658 Music Staff Lines

## Vertical Surface Fabric

### Fabric Tackboard Surfaces

Tackboard surfaces are available in select Steelcase and Designtex fabrics; pricing for Designtex and Steelcase fabrics is determined by a grading program. All fabrics are applied railroaded, i.e. salvages parallel to floor.

### Price Group 1

#### Abacus **E**

- P122 Entasis
- P123 Portico
- P124 Opus
- P125 Cusp
- P126 Artifact
- P129 Atlas

#### Bariolage

- G220 Etude
- G221 Andante
- G226 Cantata
- G227 Adagio
- G233 Melody
- G234 Ballata
- G235 Sonata

## Designtex Graded-In Program

For additional information and fabric samples, contact your local Designtex sales representative at 1.800.221.1540.

The following fabrics are part of the program formerly known as Designtex Graded-In. These patterns can be ordered through the Select Surfaces order fulfill model.

► See *Surface Materials Reference Manual* for complete Select Surfaces ordering information.

### Price Group 2

- Brunswick - 6307
- Solara - 4101

### Price Group 3

- Foxtrot - 6375
- Sumo - 6499

### Price Group 4

- Rivergrass - 2690

### Price Group COM (Customer's Own Material)

#### Fabric Approval and Yardage

To confirm whether a particular COM material has already been tested for use on a specific Steelcase product or to determine actual yardage requirements:

- Visit [www.steelcase.com](http://www.steelcase.com)

#### For additional information regarding Customer's Own Material, call

1.888.STEELCASE (1.888.783.3522) or send an e-mail to [lineone@steelcase.com](mailto:lineone@steelcase.com).

**E** = Established



# Upholstery and Color Numbers

## Upholstery

Not all fabrics are available on all products. See the COM database for specific product and fabric availability.

## Price Group 1

### Buzz2

- 5F01 Camel **E**
- 5F03 Tomato
- 5F04 Red **E**
- 5F05 Burgundy
- 5F06 Sky **E**
- 5F07 Blue
- 5F08 Navy
- 5F10 Grape **E**
- 5F11 Eggplant **E**
- 5F15 Stone
- 5F16 Grey
- 5F17 Black
- 5G50 Dunegrass
- 5G51 Sable
- 5G52 Barley
- 5G53 Sunrise
- 5G54 Carrot
- 5G55 Pumpkin
- 5G56 Timber
- 5G57 Rouge
- 5G58 Chocolate
- 5G59 Meadow
- 5G60 Ivy
- 5G61 Cyan
- 5G62 Atlantic
- 5G63 Crocus
- 5G64 Alpine
- 5G65 Tornado

### Jacks

- 5B61 Taupe
- 5B63 Camel
- 5B64 Pewter
- 5B66 Plum
- 5B70 Midnight

### Link

- 5A20 Burgundy
- 5A21 Rust
- 5A23 Green
- 5A24 Blue
- 5A25 Navy
- 5A26 Purple
- 5A27 Black
- 5A28 Ocean
- 5A29 Lichen
- 5A30 Chamois

## Playground

- 5F28 Claret
- 5F29 Chile
- 5F30 Amber
- 5F31 Nut
- 5F32 Blade
- 5F33 Stone
- 5F34 Sky
- 5F35 Navy
- 5F36 Huckleberry
- 5F37 Charcoal

## Seating Vinyl

- 5801 Topaz
- 5805 Foggy Night
- 5809 Black
- 5810 Forest
- 5812 Navy
- 5813 Currant
- 5814 Leaf
- 5815 Seaside
- 5817 Pebble
- 5818 Spice
- 5819 Thistle
- 5820 Coffee
- 5822 Iris

## Price Group 2

### Cogent: Connect

- 5S15 Coconut
- 5S16 Turmeric
- 5S17 Tangerine
- 5S18 Scarlet
- 5S19 Concord
- 5S20 Maya Blue
- 5S21 Blue Jay
- 5S22 Basil
- 5S23 Wasabi
- 5S24 Nickel
- 5S25 Graphite
- 5S26 Licorice
- 5S27 Malt
- 5S28 Root Beer
- 5S93 Blueprint
- 5S94 Lizard
- 5S95 Sailor
- 5S96 Quicksilver
- 5S97 Nugget
- 5S98 Canary
- 5S99 Lipstick

### Cogent: Geode Seating

- 5S46 Bark
- 5S47 Coal
- 5S48 Smoke
- 5S49 Cobalt
- 5S50 Ink
- 5S51 Shamrock
- 5S52 Pear
- 5S53 Berry
- 5S54 Mandarin
- 5S55 Sunset
- 5S56 Citrus
- 5S57 Thunder

## Cogent: Geode Vertical

- 5S31 Pebble
- 5S32 Canyon
- 5S33 Honey
- 5S34 Ice
- 5S35 Slate
- 5S36 Cement
- 5S37 Rock
- 5S38 Oyster
- 5S39 Buff
- 5S40 Toast
- 5S41 Sesame
- 5S42 Ecru
- 5S43 Dove

## Cogent: Trails

- 5S29 Bronzite
- 5S30 Amethyst
- 5S84 Jasper
- 5S85 Agate
- 5S86 Lapis
- 5S87 Malachite
- 5S88 Quartz
- 5S89 Carnelian
- 5S90 Tiger Eye
- 5S91 Travertine
- 5S92 Topaz

## Cricket

- 5A84 Plum
- 5A85 Camel
- 5A86 Charcoal
- 5A87 Black
- 5A90 Currant
- 5A91 Spearmint
- 5A92 Sky
- 5A93 Midnight
- 5A95 Ocean
- 5A96 Forest

## Crosswalk

- 5F48 Beech
- 5F49 Moon
- 5F50 Berry
- 5F51 Admiral Blue
- 5F52 Moss
- 5F53 Persimmon
- 5F54 Bittersweet
- 5F55 Midnight
- 5F56 Poppy

## Nitelights

- 5F58 Hazelnut
- 5F59 Burgundy
- 5F60 Cherry
- 5F61 Earth
- 5F62 Shore
- 5F63 Moss
- 5F64 Sea
- 5F65 Regal Blue
- 5F66 Stone
- 5F67 Moon

## Regis2

- 5F18 Black
- 5F24 Pacific
- 5F26 Cherry
- 5F27 Navy

## Spyder

- 5B00 Orchid **E**
- 5B01 Foggy Night **E**
- 5B04 Peri **E**
- 5B05 Merlot **E**
- 5B06 Dove **E**
- 5B07 Sage **E**
- 5B09 Topaz **E**
- 5B11 Currant **E**
- 5B12 Lichen **E**

## Zoe2

- 5C90 Eggplant
- 5C91 Aloe
- 5C92 Fiddle
- 5C93 Patina
- 5C94 Peacock
- 5C95 Rain
- 5C96 Grey Flannel
- 5C97 Pebble
- 5C98 Cymbal
- 5C99 Fiesta

## Price Group 3

### Cogent: Tides

- 5S71 Butter
- 5S72 Snow
- 5S73 Celery
- 5S74 Wicker
- 5S75 Pool
- 5S76 Cloud
- 5S77 Grass
- 5S78 Clay
- 5S79 Hyacinth
- 5S80 Jet
- 5S81 Doe
- 5S82 Boysenberry
- 5S83 Night

## Hampstead

- B351 Blue Green V4 **E**
- B359 Blue Blue  
Green V5 **E**
- B366 Blue Blue Violet  
V4 **E**
- B369 Blue Blue Violet  
V5 **E**
- B377 Violet V5  
(Low Intensity) **E**
- B389 Red Red  
Violet V5 **E**
- B395 Grey V5 **E**
- B399 Black
- B406 Windflower **E**
- B413 Shale **E**
- B423 Clementine
- B424 Butter Cream
- B425 Iris
- B426 Sapphire
- B427 Turquoise
- B428 Navy
- B429 Charcoal
- B430 Spa
- B431 Plum
- B432 Cocoa
- B433 Cork
- B434 Stone
- B435 Metal
- B436 Peridot
- B437 Cactus
- B438 Sycamore
- B439 Candy Apple

## Price Group 5

### Bo Peep

- 5G66 Pita
- 5G67 Bone
- 5G68 Safari
- 5G69 Brown Sugar
- 5G70 Chocolate Chip
- 5G71 Candlelight
- 5G72 Honey Mustard
- 5G73 Marmalade
- 5G74 Picnic
- 5G75 Pinot
- 5G76 Bloom
- 5G77 Grapevine
- 5G78 Firefly
- 5G79 Artichoke
- 5G80 Serpent
- 5G81 Carolina
- 5G82 Blue Bonnet
- 5G83 Nautical
- 5G84 Gravel
- 5G85 Sharkskin
- 5G86 Kohl

## Price Group 6

### Brisa

- BR01 Black Onyx
- BR04 Truffle
- BR06 Ash
- BR07 Sage
- BR08 Celery
- BR09 Sterling Blue
- BR10 Night Navy
- BR11 Cambridge Blue
- BR12 Abyss
- BR13 Canyon
- BR14 Pompeian Red
- BR15 Salsa
- BR16 Cinnabar
- BR17 Aztec
- BR18 New Sand
- BR19 Cream
- BR20 White
- BR21 Moccasin
- BR22 Buckskin
- BR23 Prairie

## Leather Price Group

- L107 Black
- L202 Dusk
- L203 Bottle
- L207 Mahogany
- L220 Soapstone
- L221 Rocky
- L224 Plum
- L500 Camel
- L503 Navy
- L507 Vineyard

**E** = Established

**Select Surfaces  
Designtex**

For additional information and fabric samples, contact your local Designtex sales representative at 1.800.221.1540.

The following fabrics are part of the program formerly known as Designtex Graded-In. These patterns can be ordered through the Select Surfaces order fulfillment model. These materials are available on Steelcase and Nurture brand products.  
▶ See *Surface Materials Reference Manual* for complete Select Surfaces ordering information.

**Price Group 2 -  
Finish Code 59DB**

Bee - 4975  
Ludington - 3285  
Sandpiper - 3313

**Price Group 3 -  
Finish Code 59DC**

Boyne - 3280  
Crossroads - 2895  
Great Lakes - 3282  
Lagoon - 4977  
Prairie - 2552  
Rocket - 2693

**Price Group 4 -  
Finish Code 59DD**

Astrid - 2747  
At Ease - 3309  
Bolzano - 3412  
Bunta - 3360  
Candor - 3306  
Closed Loop - 2550  
Easy Going - 3305  
Free & Easy - 3316  
Glen Arbor - 3283  
Gujarat - 3357  
Introvert - 2879  
Kalanga - 3359  
Leland - 3281  
Matter of Fact - 3356  
Metta - 2681  
No Frills - 3318  
Nonchalant - 3307  
Omar Seating - 2865  
Sari - 3361  
Sarong - 3358  
Saugatuck - 3284  
To The Point - 3308  
Topiary - 2897  
Well Rounded - 3317

**Price Group 5 -  
Finish Code 59DE**

Abex - 2072  
Appleseed - 2682  
Brooch - 2762  
Café - 2789  
Caillou - 2778  
Cascadia - 2733  
Crossover - 2683  
Fonte - 2796  
Halos - 2899  
Kabuki - 2794  
Metaphor - 2877  
Protect - 2852  
Salon - 2797  
Surface - 2787  
Sustain - 2851  
Synchronize - 2876  
Tailored Stripe - 2763  
Terrasse - 2795  
V - 2957

**Price Group 6 -  
Finish Code 59DF**

Acacia - 2843  
Agave - 2847  
Alistair - 2992  
Allure - 2756  
Amaranth w/o Crypton - 2855u  
Amuse - 2767  
Arlington - 2724  
Banda - 3227  
Barnsbury - 2726  
Bottle Bank - 2869  
Cassava - 2838  
Chicory - 2993  
Circolo - 3229  
Converge - 2873  
Copa - 2641  
Coupe - H245  
Dahlia - 2995  
Décor - H244  
Dot to Dot - 2691  
Downtown - 2029  
Epiphany - 2734  
Faconne - 2764  
Friendly Faux w/Knit Backing - 2008  
Griglia - 3231  
Hula Hoop - 3297  
Kenaf - 2859  
Kenaf w/o Crypton - 2859u  
Klange - 2741  
Knockabout - 3326  
Laureate - 2774  
Palace - H254  
Pivot - 3374  
Pueblo - 2844  
Quintessence - 3347  
React - 2861  
Rice - 2858  
Rough & Ready - 2016  
Salvage - 2867  
Seed - 2839  
Senna - 2848  
Sequence - 2742  
Sock Hop - 3298  
Soda Pop - 2868  
Square - 2788  
Swing Set - 2421  
Tangent - 2875  
Tartan - 2994  
Teddy - H236  
Terrain - 2846  
Transpose - 2874  
Tumbleweed - 2845

**Price Group 7 -  
Finish Code 59DG**

Amaranth - 2855  
Baratto - 3266  
Battista - 2718  
Beam - 2785  
Bon Bon - 2749  
Calm - 2768  
Cestino - 3270  
Chakin - 7146  
Coperta - 3228  
Drive-In - 3299  
Dwell - 2850  
Faux Sure w/Knit Backing - 3351  
Flux - 3239  
Fuse w/Knit Backing - 3362  
Garden Key - 3252  
Inertia - 3235  
Juxtaposition - 2744  
Kaleidoscope - 2863  
Lorien - H201  
Minuet - 2656  
Oscillate - 3238  
Point - 2783  
Razor Stripe - 2857  
Samba - 2654  
Samba Otra Vez - 2885  
Spiro - 3237  
Sundance - 3278  
Uptown - 2024  
Yoruba - 3333  
Ziggurat - 2827

**Price Group 8 -  
Finish Code 59DH**

Biba - H216  
Chandelier - 7354  
Circumference - 2884  
Facets - 7350  
Honor Plus - 2547  
Hue - 2710  
Maglia - 3233  
Nexus - 3236  
Polygon - 2883  
Thumbnail Sketch - 2841  
Titanium - 2842  
Torsade - 7358  
Valanka - 3279  
Wire - 2743

**Price Group 9 -  
Finish Code 59DJ**

Bangles - 7352  
Belvedere - 3275  
Gotham - 2390  
Gramercy - 2599  
Hofburg - 3276  
Yorkshire - 2771

**Price Group 10 -  
Finish Code 59DK**

Chalet - 3290  
Kanthas - H238  
Links - 7353  
Lolland - 3263  
Metamorphosis w/Knit Backing - 3367  
Migration w/Knit Backing - 3373  
Shimmering Tide w/Knit Backing - 3369  
Tumble Stones w/Knit Backing - 3371  
Wood Work w/Knit Backing - 3372

**Price Group  
COM/COL  
(Customer's Own  
Material/Leather)**

**Fabric Approval and  
Yardage**

To confirm whether a particular COM material has already been tested for use on a specific Steelcase or Nurture product or to determine actual yardage requirements:  
• Visit [www.steelcase.com](http://www.steelcase.com)

**For additional information regarding Customer's Own Material**, call 1.888.STEELCASE (1.888.783.3522) or send an e-mail to [lineone@steelcase.com](mailto:lineone@steelcase.com).

**For Nurture products**, call 1.800.342.8562.

# Nurture Graded-In Programs

## Nurture Graded-In Program: Acrylic Panel

A collection of acrylic panels are available as part of a Graded-In Program. The collection is from the Designtex Fusion offering.

These acrylic panels are Graded-In for the Sonata product only. The collection on these pages is not Graded-In for other Steel-case brands or product lines.

To order these acrylic panels, enter the finish code which corresponds with the acrylic panel price group.

Price Group	Finish Code
1	65DA
2	65DB
3	65DC
4	65DD

Then enter the acrylic panel information in the Special Acrylic Panel Information pop up window. If prompted, enter the finish code DSGNTX0002 based on the acrylic panel supplier.

## Designtex

### Fusion Offering

#### Price Group 1

Blueberry  
Bluestone  
Bubblegum  
Canary  
Candy Apple  
Etch  
Grape  
Key Lime  
Lemon  
Periwinkle  
Plum  
Red  
Sea  
Searchlight  
Slate  
Tangerine  
White  
White Dot  
White Rain  
White Ribbon

#### Price Group 2

Berry Grid  
Bone Linen  
Cloud Grid  
Espresso Sketch  
Flame Sketch  
Flannel Linen  
Granny Smith Grid  
Grapefruit Grid  
Halo  
Honey Sketch  
Ice Sketch  
Noir Linen  
Orange Grid  
Pistachio Sketch  
Reef Linen  
Scarlet Sketch  
Sky Grid  
Tiki Stalk  
Windowbox

#### Price Group 3

Kenya Rush  
Ogee  
Prairie Stalk  
Savannah Rush  
Straws

#### Price Group 4

Coil  
Convection  
Desert Stalk 50% More  
Drink Tray  
Fingerprints  
Grassland  
Green Sheer Leaf  
Illumination  
Large Sheer Leaf  
Maroon Sheer Leaf  
Plain  
Rock Candy  
Sapphire Rock Candy  
Small Sheer Leaf  
Toffee Sheer Leaf  
Underwood

## Nurture Graded-In Program: Solid Surface

A collection of solid surfaces are available as part of a Graded-In Program. The collection is from the Corian solid surface offering.

These solid surfaces are Graded-In for the Folio, Sonata, Sync, Senza, Tava, and Leela products only. The collection on these pages is not Graded-In for other Steelcase brands or product lines.

To order these solid surfaces, enter the finish code which corresponds with the solid surface price group.

Price Group	Finish Code
A	29DA
B	29DB
C	29DC
D	29DD
E	29DE

Then enter the solid surface information in the Special Solid Surface Information pop up window. If prompted, enter the finish code CORIAN0001 based on the solid surface supplier.

## Corian

### Solid Surface Offering

#### Price Group A

Glacier White

#### Price Group B

Abalone  
Aurora  
Cameo White  
Canyon  
Cobalt  
Flint  
Maui  
Mojave  
Moss  
Platinum  
Sahara  
Sand  
Sandstone  
Savannah  
Silt  
Tarragon  
Vanilla

#### Price Group C

Acorn  
Adobe  
Bethany  
Blue Crush  
Blue Pebble  
Canyon Trail  
Cocoa Brown  
Cottage Lane  
Doeskin  
Fossil  
Granola  
Gray Fieldstone  
Gray Pebble  
Mardi Gras  
Matterhorn  
Medea  
Mosaic  
Night Sky  
Oat  
Pine  
Riviera  
Sage Graystone  
Shale  
Silver Birch  
Stone Harbor  
Suede  
Willow

#### Price Group D

Anthracite  
Azurite  
Bronze Patina  
Bronzite  
Concrete  
Copperite  
Designer White  
Dove  
Fawn  
Graphic Blue  
Green Tea  
Hot  
Lilac  
Mandarin  
Nocturne  
Olivite  
Pompeii Red  
Raffia  
Rice Paper  
Serene Sage  
Silverite  
Sun  
Tranquil  
Venaro White  
Whisper  
White Jasmine

#### Price Group E

Aqualite  
Arctic Blueberry  
Arctic Ice  
Arctic Lime  
Arctic Mint  
Arctic Strawberry  
Aztec Gold  
Blueberry Ice  
Burled Beach  
Chamois  
Cinnabar  
Cirrus White  
Clam Shell  
Earth  
Ecu  
Elderberry  
Glacier Ice  
Graylite  
Jasmine  
Juniper  
Lava Rock  
Lime Ice  
Mint Ice  
Natural Gray  
Rain Cloud  
Rosemary  
Saffron  
Sagebrush  
Sandalwood  
Slate  
Sonora  
Sorrel  
Strawberry Ice  
Thyme  
Tumbleweed  
Verde  
Witch Hazel

**Nurture Graded-In Program: Upholstery**

A collection of textiles are available as part of a Graded-In Program. The collection from the leading suppliers in the market consists of high-performance textiles that meet the demands of healthcare environments. Note that not all fabrics can be applied to all seating products. Refer to the Steelcase COM database for the most current application information.

To order these fabrics, enter the finish code which corresponds with the fabric price group.

Price Group	Finish Code
2	59DB
3	59DC
4	59DD
5	59DE
6	59DF
7	59DG
8	59DH
9	59DJ
10	59DK

Then enter the fabric information in the Special Fabric Information pop up window. Enter the appropriate finish code from the list below, based on the fabric supplier.

Supplier	Finish Code
Architex	ARCHTX0001
ArcCom	ARCCOM0001
CF Stinson	CFSTIN0001
DesignTex	DSGNTX0001
Maharam	MAHARA0001
Momentum	MOMENT0001
Ultrafabrics	ULTRAF0001

Fabric application direction must be specified.

► See page 712 for *Fabric Application Direction Guidelines* to ensure fabric is specified in the correct direction.

**Architex**

**Price Group 5**

Daytona  
Linen

**Price Group 6**

Ellipse  
Joy  
Matrix  
Radius

**Price Group 7**

Animal  
Authentec  
Daybreak  
Hyde  
Patent  
Sprig  
Tegan  
Tibet  
Vanish  
Voila

**Price Group 8**

Bonnie  
Delight  
Easton  
Fish Out Of Water  
Kenga  
Mabel  
Pick Up Sticks  
Ruth  
Sarah  
Spellbound  
Thrive  
Your Bird Can Sing

**Price Group 9**

Bamboo Mate  
Brook  
Burst  
Follow Me  
Morin  
Nili  
Ripples

**Price Group 10**

Pelle

**Arc-Com**

Arc-Com graded-in fabrics can only be used on Nurture brand products.

**Price Group 4**

Duchess  
Illusion  
Lancaster

**Price Group 5**

Alamo  
Cassio  
Durango  
Frontier  
Gatsby  
Pebble Beach  
Shimmer  
Silver Birch  
Strata  
Terra

**Price Group 6**

Allegra  
Bravo  
Checkmate  
Chit-Chat  
Etch  
Fireflies  
Gem  
Grand Central  
Grassland  
Hopscotch  
Jing  
Leonardo  
Lotus  
Matrix  
Palatine  
Panache  
Pinpoint  
Sierra  
Silverado  
South Street  
Suede Sensation  
Sylvan  
Tribeca  
Vibrato  
Willow

**Price Group 7**

Abacus  
Aline  
Aruba  
Ashanti  
Bauble  
Beat Box  
Bourbon Street  
Broadway  
Bronco  
Cadence  
Carnival  
Dorset  
Eclipse  
Élan  
Grammercy Park  
Hemisphere  
Hydro  
Iguana  
Intaglio  
Iron Gate  
Link  
Mirage  
Moon Beam  
Mystique  
Notting Hill  
Pinball  
Pong  
Quadrant  
Rhythm  
Savannah  
Stonehenge  
Sublime  
Symphony  
Trio  
Vibe  
Whirlwind  
Wonderland

**Price Group 8**

Bounce  
Bubbly  
Circuit  
Diamond Derby  
Espirit  
Flora  
Forsythia  
Gamble  
Heirloom  
Jardin  
Kalahari  
Kendo  
Kensington  
Lily Pond  
Masquerade  
Nikko  
Oasis  
Piazza  
Posh  
Radiant  
Riviera  
Royal Garden  
Salsa  
Seagrass  
Sherwood  
Spotlight  
Spring  
Strand-It  
Tango  
Tatami  
Tuscany  
Victoria  
Volley  
Yoyo

**Price Group 9**

Francesca Wool  
Francesca Wool II  
Groovy  
Juliet  
Sagrada  
Uptown  
Wind Chime

**Price Group 10**

Fantasia  
Far Out

**CF Stinson**

**Price Group 3**

Laredo  
Rally

**Price Group 4**

Avant  
Bistro  
Checkmate  
Cumulus  
Moccasin  
Naugasoft  
Oxford  
Rialto  
Shantung  
Simplicity  
Symphony Classic  
Whisper  
Ziggy

**Price Group 5**

Chroma  
Cirque  
Dash  
Geomet  
Liquid  
Matrix  
Napa  
Raffia  
Southampton  
Tendrill  
Tessuto  
Whitney

**Price Group 6**

Persuasion  
In The Round w/Stakleen  
Script  
Snuggle  
Sundance w/Stakleen

**Price Group 7**

Adirondack  
Aspen  
Banyan  
Bali  
Bari  
Beeline  
Block Party  
Bower  
Capreni  
Carat  
Catwalk  
Couplet  
Cozy  
Crush  
Dodgeball  
Eli  
Equinox  
Folio  
Hands On  
Martini  
Match Point  
Mingle  
Olympus  
Over Under (By Patty Madden)  
Petals  
Pinstripe  
Raquette  
Rivera  
Silverado W/Agion  
Spandrel  
Sterling W/Agion  
Straight And Narrow  
Tweed  
Twist  
Vibe  
Wink W/Agion  
Ybor

**Price Group 8**

Balance Beam  
Cinnamon Blossom  
Colden  
Courtyard  
Eclipse  
Flutter  
Geodesic  
Hoopla  
Labyrinth  
Lucky Charm  
Panache  
Skyline  
Sumatran Palm  
Sunburst  
Vintage  
Wired

**Price Group 9**

Chi w/Agion  
Daddy-O w/Agion  
Good Fortune w/Agion  
Haiku w/Agion  
Jam Session w/Agion  
Jump w/Agion  
Now & Zen w/Agion  
Tatami w/Agion  
True Path w/Agion  
Tuscan Lattice  
Umbrian Stripe  
Up Tempo w/Agion  
Zen Garden w/Agion

**Price Group 10**

Double Time w/Agion  
Glisten  
In The Groove w/Agion  
Mesa  
Tuscan Garden  
Tuscan Hills  
Umbrian Landscape  
Umbrian Rain  
Umbrian Village  
Verve w/Agion  
Volterra-Hc

**Designtex**

**Price Group 4**

Bolzano  
Kalanga  
Metta  
Parga  
Rondine  
Sorano  
Spandau  
Tarascon

**Price Group 5**

Alcazar  
Annex  
Avenza  
Breena  
Figure Eight  
Florin  
Inside Edge  
Leafette  
Lino  
Pianta  
Prism  
Rumeli  
Skylark

**Price Group 6**

Acacia  
Agave  
Alistair  
Amuse  
Anello  
Arlington  
Banda  
Barnsbury  
Bounce  
Cassava  
Chicory  
Circolo  
Copa  
Dahlia  
Dot To Dot  
Downtown  
Drawing Straws  
Friendly Faux  
Griglia  
Gujarat  
Hula Hoop  
Kenaf  
Lindos  
Pueblo  
Quintessence  
Rice  
Seed  
Senna  
Swing Set  
Tartan  
Terrain  
Tumbleweed  
Vinca

**Price Group 7**

Alemanya  
Alkai  
Amaranth  
Basket Weaver  
Bon Bon  
Bossa Nova  
Calm  
Clovis  
Coperta  
Details  
Dodge Ball  
Dodge Ball Too  
Faux Sure  
Flux  
Four Square  
Inertia  
Jungle Gym  
Line Item  
Mena  
Minuet  
Oscillate  
Pasa Doble  
Pattino  
Prana  
Samba  
Samba Otra Vez  
See Saw  
Spiro  
Sprocket  
Tinos  
Tupi  
Uptown  
Widget

**Price Group 8**

Boreas  
Honor Plus  
Maglia  
Nexus  
Southside

**Price Group 10**

Journey

**Maharam**

**Maharam graded-in fabrics** can only be used on Nurture brand products.

**Price Group 5**

Article  
Ledger

**Price Group 6**

Candid  
Chime  
Flicker  
Lariat  
Petal  
Quick  
Reverie

**Price Group 7**

Align  
Alloy  
Assemblage  
Beside  
Bop  
Chance  
Corner  
Crush  
Current  
Double Check  
Kernel  
Scuba  
Trait  
Wafer

**Price Group 8**

Akimbo  
Box  
Comment  
Dart  
Decode  
Floret  
Intertwine  
Scout  
Venn  
Verse

**Price Group 10**

Chenille Cord

**Momentum**

**Momentum graded-in fabrics** can only be used on Nurture brand products.

**Price Group 3**

Cashmere

**Price Group 4**

Array  
Crete  
Fleck  
Sublime  
Tatami

**Price Group 5**

Bravo  
Crypton Suede  
Echo  
Evoke  
Foray  
Jolt  
Max  
Smart Suede  
Tact

**Price Group 6**

Brea  
Clue  
Crux  
Icon  
Kinetic  
Lumiere  
Paragon  
Query  
Radiate  
Rio  
Topanga  
Tweed  
Viva  
Zoom

**Price Group 7**

Amenity  
Bandwidth  
Delmonico  
Feliz  
Frolic  
Huntington  
Hyphen  
Jax  
Jest  
Locale  
Maxim  
Narration  
Premise  
Schmooze  
Sway  
Telegram

**Price Group 8**

Ardour  
Calabasas  
Catalogue  
Charade  
Inhabit  
Pomona  
Recollection  
Soma

**Price Group 9**

Effloresce  
Emanate

**Ultrafabrics**

**Price Group 6**

Ultraleather

**Price Group 7**

Promessa

# Fabric Application Direction Guidelines

## What is the issue?

Some textiles are simple and look the same regardless of how you apply them to a product. Other fabrics are patterned, textured, or have luster that will have a distinctly different appearance applied in a different direction on a chair. Because of these differences, and the fact that there are limits to how some fabrics can be applied to Nurture products, it is important to understand fabric application direction when ordering a product to avoid being disappointed.

## Talking about direction

Fabrics come on rolls. The long yarns that run down the length of the roll are called the “warp” yarns. These yarns are used to define the direction you are viewing the fabric as it is applied to a chair. Fabric directionality is determined by how the fabric comes off the roll.



It is NOT determined by the way the pattern looks on the product. For example, the image below shows the fabric applied warped horizontal although the stripes appear vertical.

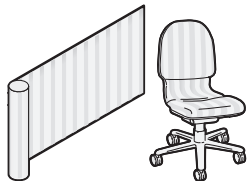

## Terminology

Steelcase uses the terms warped horizontal and warped vertical. There are other terms within the industry that are used that have the same meaning:

- Warped horizontal is also referred to as:
  - railroaded or across roll
- Warped vertical is also referred to as:
  - woven way, down roll, or top out

## Why is it important?

Dealers must specify fabric application direction when ordering COMs and Nurture Graded-In fabrics. We require the dealer to specify the direction because we do not know which way customers want to see a pattern on the furniture. Therefore, it is critical to know how the pattern is run on the roll to ensure that Nurture builds and ships each order to the customer’s expectation each and every time.

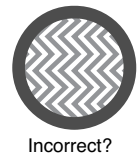

## How do I know which way the fabric comes off the roll?

Most textile companies will swatch their fabrics in a warp vertical (woven way, down roll) direction. Some exceptions might be made to address patterns especially with stripes. Typically, when a fabric is swatched in a warp horizontal (railroad or across roll) direction, the direction is noted on the swatch card or fabric sample. If in doubt of a fabric direction, we encourage you to contact the textile vendor for clarification.

## Vinyl

Vinyl generally only passes on Nurture product in a horizontal or across roll direction. This is due to physical properties of the material. If a vinyl is applied in the opposite direction, too much stretch in the material can compromise the overall aesthetics of the final upholstery. If a patterned vinyl is being specified and the vinyl must be run in a vertical direction, pre-approval must be arranged through Nurture. Nurture will consider the request and a decision will be made based on the specific vinyl and product combination. Contact Nurture’s Customer Care line.

## Required Action Steps before Specifying

1. Verify by using Steelcase’s COM website that the fabric is approved on the product.
2. Verify the direction that the fabric can be applied. Occasionally a fabric is only approved in one direction.
3. Confirm with the customer how they want the fabric to look on the furniture.
4. Confirm using the swatch card or vendor’s website the direction the sample is shown.
5. Now you’re ready to place the order.