

Sine

Sine tandem and beam seating is designed to be used in high-traffic areas. Tables are available to complement the chairs.

Back is upholstered and is separate from the seat. It is available with a concave or convex top edge.

Frame is constructed with steel for structural integrity. It has a powdercoat paint finish that is corrosion resistant.

Adjustable nylon glides are standard on legs.

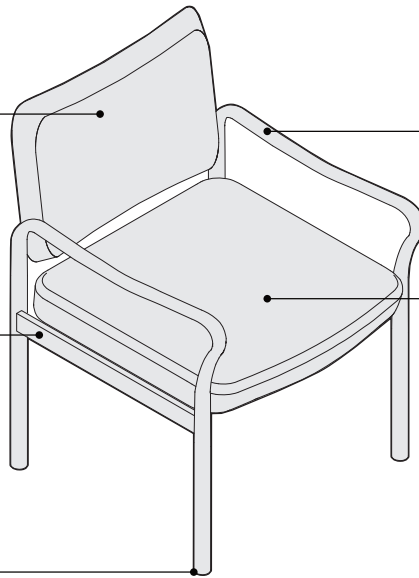

Arms are open and made of urethane-covered steel. Multi-seat units are available with or without intermediate arms.

Seat is upholstered. It features UltraFlex webbing, which is a suspension system that distributes weight evenly over the entire seating surface to provide more comfort for the user.

Product Details

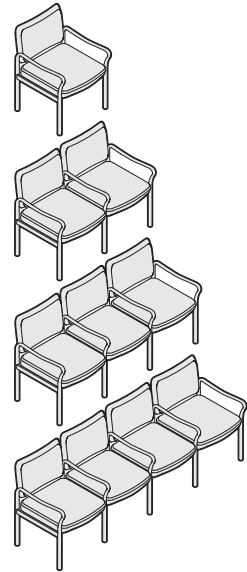

Tandem chair is available as a single unit or in two-, three-, or four-seat units. The multi-seat units are available with or without the intermediate arms.

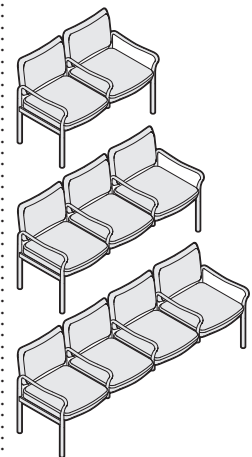

Beam seating is available in two-, three-, or four-seat units with open arms. The multi-seat units are available with or without the intermediate arms.

Actual Dimensions

▶ See page 286

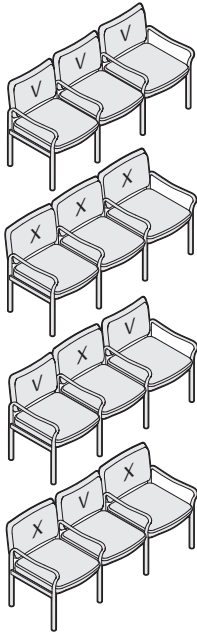

Seat back is available with concave or convex detail. The back style can be uniform (VVV or XXX) or mixed (VXV or XVX) to form a scalloped appearance on multi-seat units.

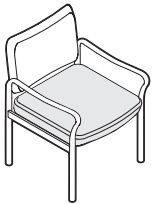

Different fabrics can be specified on the seat and back.

Moisture barrier is available as an option on the chair seat.

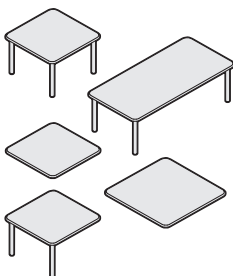

Tables are available in freestanding and ganging models.

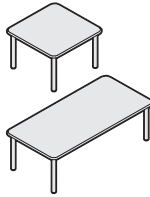

Freestanding tables are available in square and rectangular shapes. Both shapes are available with metal legs to coordinate with the chairs.

Connections

Ganging tables are available in end-of-run, corner, or square center models that are connected between chairs. End-of-run and corner tables have metal legs. Attaching hardware is included.

Wiring & Cabling

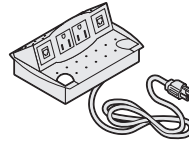

Interport power/data module can be installed on table tops. The module top is located in the center and flips up to access two electrical outlets and two data ports.

Surface Materials

All Nurture seating with standard upholstery fabrics comply with the State of California Technical Bulletin 117.

Frame

- Powdercoat paint

Arms

- Urethane coating

Seat and back

- Fabric
 - Fabric with moisture barrier (option on seat only)
- Tip: Certain fabrics and vinyl will appear loose with comfort wrinkles when upholstered. Moisture barrier option may cause additional puddling on seat depending on the specified fabric.*

Adjustable glides

- Nylon

Table legs

- Powdercoat paint

Table top

- Laminate with specifiable T-mold edge band

Sine, continued

Actual Dimensions									
Features	Overall Depth	Width	Height	Seat Depth	Width	Height	Concave Back Height from Seat	Convex Back Height from Seat	Arm Height
Tandem chair	25½"	24½"	33¾"	19"	20½"	18¼"	15½"	17¾"	25¾"
Two-seat tandem	25½"	47"	33¾"	19"	20½"	18¼"	15½"	17¾"	25¾"
Three-seat tandem	25½"	69½"	33¾"	19"	20½"	18¼"	15½"	17¾"	25¾"
Four-seat tandem	25½"	92"	33¾"	19"	20½"	18¼"	15½"	17¾"	25¾"
Two-seat beam	25½"	47"	33¾"	19"	20½"	18¼"	15½"	17¾"	25¾"
Three-seat beam	25½"	69½"	33¾"	19"	20½"	18¼"	15½"	17¾"	25¾"
Four-seat beam	25½"	92"	33¾"	19"	20½"	18¼"	15½"	17¾"	25¾"
Freestanding square table	22"	22¾"	14½"	N.A.	N.A.	N.A.	N.A.	N.A.	N.A.
Freestanding rectangular table	22"	46½"	14½"	N.A.	N.A.	N.A.	N.A.	N.A.	N.A.
Ganging corner table	28"	28"	14½"	N.A.	N.A.	N.A.	N.A.	N.A.	N.A.
Ganging end-of-run table	22"	22¾"	14½"	N.A.	N.A.	N.A.	N.A.	N.A.	N.A.
Ganging square center table	22"	22¾"	14½"	N.A.	N.A.	N.A.	N.A.	N.A.	N.A.

Sine

Tandem Chairs

Standard Includes	Required to Specify
<ul style="list-style-type: none"> ▶ Need help? Product details, page 284 • Frame and legs: paint • Open arms: urethane to match paint • Seat and back: fabric • Nylon glides 	<ul style="list-style-type: none"> 1 Style number 2 Paint color number for frame and legs 3 Fabric color number for seat and back 4 Options, if selected (see below) ▶ See <i>Surface Materials</i>, page 691.

Tip: Different fabrics for the seat and back can be specified. If the fabrics are in different price groups, calculate list price by adding the two price groups together and dividing by two.

Options	U.S. Price	Required to Specify
Surface Materials <ul style="list-style-type: none"> • Moisture barrier • Fire code seating • Single-seat tandem chairs • Two-seat tandem chairs • Three-seat tandem chairs • Four-seat tandem chairs 	<ul style="list-style-type: none"> • Moisture barrier +\$104 per seat • Fire code seating +\$188 • Single-seat tandem chairs +\$376 • Two-seat tandem chairs +\$470 • Three-seat tandem chairs +\$470 • Four-seat tandem chairs +\$658 	<ul style="list-style-type: none"> Specify with <i>moisture barrier</i>. Add suffix F to the style number. Add suffix F to the style number. Add suffix F to the style number. Add suffix F to the style number.

Specification Information											
U.S. Base Prices											
Style Number	Fabric Price Group 1	Fabric Price Group 2	Fabric Price Group 3	Fabric Price Group 4	Fabric Price Group 5	Fabric Price Group 6	Fabric Price Group 7	Fabric Price Group 8	Fabric Price Group 9	Fabric Price Group 10	COM

Note: X=Convex
V=Concave



Tandem Chair

Convex Back

HN198X	\$ 899	\$ 939	\$ 979	\$1009	\$1041	\$1063	\$1095	\$1143	\$1205	\$1243	\$ 951
---------------	--------	--------	--------	--------	--------	--------	--------	--------	--------	--------	--------

Concave Back

HN198V	\$ 899	\$ 939	\$ 979	\$1009	\$1041	\$1063	\$1095	\$1143	\$1205	\$1243	\$ 951
---------------	--------	--------	--------	--------	--------	--------	--------	--------	--------	--------	--------

Two-Seat Tandem Chairs

With Intermediate Arm

HN1982XX	\$1745	\$1825	\$1901	\$1963	\$2025	\$2073	\$2137	\$2229	\$2355	\$2431	\$1797
-----------------	--------	--------	--------	--------	--------	--------	--------	--------	--------	--------	--------

HN1982XV	\$1745	\$1825	\$1901	\$1963	\$2025	\$2073	\$2137	\$2229	\$2355	\$2431	\$1797
-----------------	--------	--------	--------	--------	--------	--------	--------	--------	--------	--------	--------

HN1982VV	\$1745	\$1825	\$1901	\$1963	\$2025	\$2073	\$2137	\$2229	\$2355	\$2431	\$1797
-----------------	--------	--------	--------	--------	--------	--------	--------	--------	--------	--------	--------

HN1982VX	\$1745	\$1825	\$1901	\$1963	\$2025	\$2073	\$2137	\$2229	\$2355	\$2431	\$1797
-----------------	--------	--------	--------	--------	--------	--------	--------	--------	--------	--------	--------

Without Intermediate Arm

HN1982SXX	\$1681	\$1761	\$1837	\$1899	\$1961	\$2009	\$2073	\$2165	\$2291	\$2367	\$1733
------------------	--------	--------	--------	--------	--------	--------	--------	--------	--------	--------	--------

HN1982SXV	\$1681	\$1761	\$1837	\$1899	\$1961	\$2009	\$2073	\$2165	\$2291	\$2367	\$1733
------------------	--------	--------	--------	--------	--------	--------	--------	--------	--------	--------	--------

HN1982SVV	\$1681	\$1761	\$1837	\$1899	\$1961	\$2009	\$2073	\$2165	\$2291	\$2367	\$1733
------------------	--------	--------	--------	--------	--------	--------	--------	--------	--------	--------	--------

HN1982SVX	\$1681	\$1761	\$1837	\$1899	\$1961	\$2009	\$2073	\$2165	\$2291	\$2367	\$1733
------------------	--------	--------	--------	--------	--------	--------	--------	--------	--------	--------	--------

▶ **Specification Information, continued on next page**



For Canadian Pricing
Multiply U.S. Price by the Canadian price factor.
▶ See page 1 for details.

► Specification Information, continued from previous page

Specification Information

Note: X=Convex
V=Concave

Style Number	U.S. Base Prices										COM
	Fabric Price Group 1	Fabric Price Group 2	Fabric Price Group 3	Fabric Price Group 4	Fabric Price Group 5	Fabric Price Group 6	Fabric Price Group 7	Fabric Price Group 8	Fabric Price Group 9	Fabric Price Group 10	

Three-Seat Tandem Chairs

With Intermediate Arm

HN1983XXX	\$2473	\$2591	\$2709	\$2801	\$2895	\$2965	\$3059	\$3199	\$3387	\$3503	\$2525
HN1983XVX	\$2473	\$2591	\$2709	\$2801	\$2895	\$2965	\$3059	\$3199	\$3387	\$3503	\$2525
HN1983VVV	\$2473	\$2591	\$2709	\$2801	\$2895	\$2965	\$3059	\$3199	\$3387	\$3503	\$2525
HN1983VXV	\$2473	\$2591	\$2709	\$2801	\$2895	\$2965	\$3059	\$3199	\$3387	\$3503	\$2525

Without Intermediate Arm

HN1983SXXX	\$2328	\$2446	\$2564	\$2656	\$2750	\$2820	\$2914	\$3054	\$3242	\$3358	\$2380
HN1983SXVX	\$2328	\$2446	\$2564	\$2656	\$2750	\$2820	\$2914	\$3054	\$3242	\$3358	\$2380
HN1983SVVV	\$2328	\$2446	\$2564	\$2656	\$2750	\$2820	\$2914	\$3054	\$3242	\$3358	\$2380
HN1983SVXV	\$2328	\$2446	\$2564	\$2656	\$2750	\$2820	\$2914	\$3054	\$3242	\$3358	\$2380

Four-Seat Tandem Chairs

With Intermediate Arm

HN1984XXXX	☒11/11	\$3178	\$3334	\$3490	\$3614	\$3740	\$3834	\$3958	\$4146	\$4394	\$4550	\$3230
HN1984XVXV	☒11/11	\$3178	\$3334	\$3490	\$3614	\$3740	\$3834	\$3958	\$4146	\$4394	\$4550	\$3230
HN1984VVVV	☒11/11	\$3178	\$3334	\$3490	\$3614	\$3740	\$3834	\$3958	\$4146	\$4394	\$4550	\$3230
HN1984VXVX	☒11/11	\$3178	\$3334	\$3490	\$3614	\$3740	\$3834	\$3958	\$4146	\$4394	\$4550	\$3230

Without Intermediate Arm

HN1984SXXX	☒11/11	\$2964	\$3120	\$3276	\$3400	\$3526	\$3620	\$3744	\$3932	\$4180	\$4336	\$3016
HN1984SXVX	☒11/11	\$2964	\$3120	\$3276	\$3400	\$3526	\$3620	\$3744	\$3932	\$4180	\$4336	\$3016
HN1984SVVV	☒11/11	\$2964	\$3120	\$3276	\$3400	\$3526	\$3620	\$3744	\$3932	\$4180	\$4336	\$3016
HN1984SVXV	☒11/11	\$2964	\$3120	\$3276	\$3400	\$3526	\$3620	\$3744	\$3932	\$4180	\$4336	\$3016

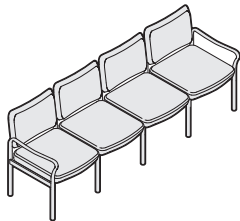
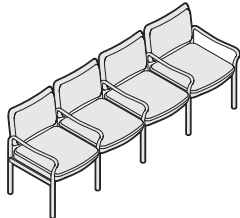
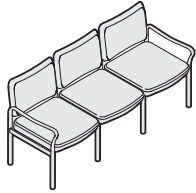
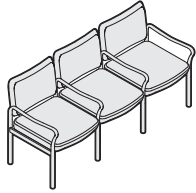

Families of Seating

 **For Canadian Pricing**
Multiply U.S. Price by the Canadian price factor.
► See page 1 for details.

☒11/11 = Last order entry
November 20, 2011

Beam Chairs

Standard Includes	Required to Specify
<ul style="list-style-type: none"> ▶ Need help? Product details, page 284 • Frame and legs: paint • Open arms: urethane to match paint • Seat and back: fabric • Nylon glides 	<ol style="list-style-type: none"> 1 Style number 2 Paint color number for frame and legs 3 Fabric color number for seat and back 4 Options, if selected (see below) <p>▶ See <i>Surface Materials</i>, page 691.</p>

Tip: Different fabrics for the seat and back can be specified. If the fabrics are in different price groups, calculate list price by adding the two price groups together and dividing by two.

Options	U.S. Price	Required to Specify
Surface Materials <ul style="list-style-type: none"> • Moisture barrier • Fire code seating • Two-seat beam chairs • Three-seat beam chairs • Four-seat beam chairs 	<ul style="list-style-type: none"> +\$104 per seat +\$376 +\$470 +\$658 	<p>Specify with <i>moisture barrier</i>.</p> <p>Add suffix F to the style number.</p> <p>Add suffix F to the style number.</p> <p>Add suffix F to the style number.</p>

Specification Information											
U.S. Base Prices											
Style Number	Fabric Price	Fabric Price	Fabric Price	Fabric Price	Fabric Price	Fabric Price	Fabric Price	Fabric Price	Fabric Price	Fabric Price	COM
	Group 1	Group 2	Group 3	Group 4	Group 5	Group 6	Group 7	Group 8	Group 9	Group 10	

Note: X=Convex
V=Concave

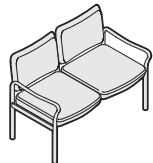

Two-Seat Beam Chairs

With Intermediate Arm

HN1992XX	\$1777	\$1857	\$1933	\$1995	\$2057	\$2105	\$2169	\$2261	\$2387	\$2463	\$1829
HN1992XV	\$1777	\$1857	\$1933	\$1995	\$2057	\$2105	\$2169	\$2261	\$2387	\$2463	\$1829
HN1992VV	\$1777	\$1857	\$1933	\$1995	\$2057	\$2105	\$2169	\$2261	\$2387	\$2463	\$1829
HN1992VX	\$1777	\$1857	\$1933	\$1995	\$2057	\$2105	\$2169	\$2261	\$2387	\$2463	\$1829

Without Intermediate Arm

HN1992SXX	\$1689	\$1769	\$1845	\$1907	\$1969	\$2017	\$2081	\$2173	\$2299	\$2375	\$1741
HN1992SXV	\$1689	\$1769	\$1845	\$1907	\$1969	\$2017	\$2081	\$2173	\$2299	\$2375	\$1741
HN1992SVV	\$1689	\$1769	\$1845	\$1907	\$1969	\$2017	\$2081	\$2173	\$2299	\$2375	\$1741
HN1992SVX	\$1689	\$1769	\$1845	\$1907	\$1969	\$2017	\$2081	\$2173	\$2299	\$2375	\$1741

▶ **Specification Information, continued on next page**



For Canadian Pricing
Multiply U.S. Price by the Canadian price factor.
▶ See page 1 for details.

► Specification Information, continued from previous page

Specification Information

Note: X=Convex
V=Concave

Style Number	U.S. Base Prices										COM
	Fabric Price	Fabric Price	Fabric Price	Fabric Price	Fabric Price	Fabric Price	Fabric Price	Fabric Price	Fabric Price	Fabric Price	
	Group 1	Group 2	Group 3	Group 4	Group 5	Group 6	Group 7	Group 8	Group 9	Group 10	

Three-Seat Beam Chairs

With Intermediate Arm

HN1993XXX	\$2560	\$2678	\$2796	\$2888	\$2982	\$3052	\$3146	\$3286	\$3474	\$3590	\$2612
HN1993XVX	\$2560	\$2678	\$2796	\$2888	\$2982	\$3052	\$3146	\$3286	\$3474	\$3590	\$2612
HN1993VVV	\$2560	\$2678	\$2796	\$2888	\$2982	\$3052	\$3146	\$3286	\$3474	\$3590	\$2612
HN1993VXV	\$2560	\$2678	\$2796	\$2888	\$2982	\$3052	\$3146	\$3286	\$3474	\$3590	\$2612

Without Intermediate Arm

HN1993SXXX	\$2400	\$2518	\$2636	\$2728	\$2822	\$2892	\$2986	\$3126	\$3314	\$3430	\$2452
HN1993SXVX	\$2400	\$2518	\$2636	\$2728	\$2822	\$2892	\$2986	\$3126	\$3314	\$3430	\$2452
HN1993SVVV	\$2400	\$2518	\$2636	\$2728	\$2822	\$2892	\$2986	\$3126	\$3314	\$3430	\$2452
HN1993SVXV	\$2400	\$2518	\$2636	\$2728	\$2822	\$2892	\$2986	\$3126	\$3314	\$3430	\$2452

Four-Seat Beam Chairs

With Intermediate Arm

HN1994XXXX X11/11	\$3350	\$3506	\$3662	\$3786	\$3912	\$4006	\$4130	\$4318	\$4566	\$4722	\$3402
HN1994XVXV X11/11	\$3350	\$3506	\$3662	\$3786	\$3912	\$4006	\$4130	\$4318	\$4566	\$4722	\$3402
HN1994VVVV X11/11	\$3350	\$3506	\$3662	\$3786	\$3912	\$4006	\$4130	\$4318	\$4566	\$4722	\$3402
HN1994VXVX X11/11	\$3350	\$3506	\$3662	\$3786	\$3912	\$4006	\$4130	\$4318	\$4566	\$4722	\$3402

Without Intermediate Arm

HN1994SXXX X11/11	\$3119	\$3275	\$3431	\$3555	\$3681	\$3775	\$3899	\$4087	\$4335	\$4491	\$3171
HN1994SXVX X11/11	\$3119	\$3275	\$3431	\$3555	\$3681	\$3775	\$3899	\$4087	\$4335	\$4491	\$3171
HN1994SVVV X11/11	\$3119	\$3275	\$3431	\$3555	\$3681	\$3775	\$3899	\$4087	\$4335	\$4491	\$3171
HN1994SVXV X11/11	\$3119	\$3275	\$3431	\$3555	\$3681	\$3775	\$3899	\$4087	\$4335	\$4491	\$3171

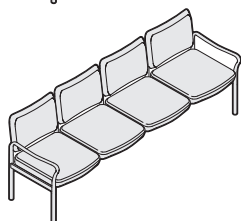
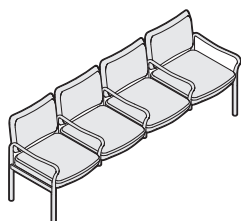
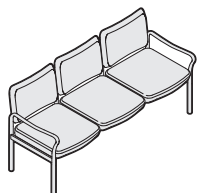
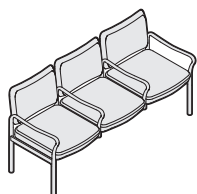

Families of Seating

 **For Canadian Pricing**
Multiply U.S. Price by the Canadian price factor.
► See page 1 for details.

X11/11 = Last order entry
November 20, 2011

Freestanding Tables

Standard Includes		Required to Specify
<ul style="list-style-type: none"> ▶ Need help? Product details, page 285 	<ul style="list-style-type: none"> • Top: laminate with T-mold edge band • Edge band: plastic • Legs: paint • Nylon glides 	<ol style="list-style-type: none"> 1 Style number 2 Laminate color for top 3 Plastic color number for edge band 4 Paint color for legs 5 Options, if selected (see below) <ul style="list-style-type: none"> ▶ See <i>Surface Materials</i>, page 691.

Options	U.S. Price	Required to Specify
Wiring & Cabling 11/11 • Interport power/data module	+\$274	Specify with interport power/data module.

Tip: Power module will be located in the center on square tables and off-center on rectangular tables.

Specification Information				
Dimensions			Style	U.S.
D	W	H	Number	Base Price

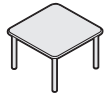

Freestanding Square Table

22"	22 ³ / ₈ "	14 ¹ / ₂ "	HN19T1	\$519
-----	----------------------------------	----------------------------------	---------------	-------

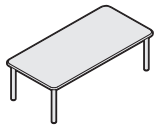

Freestanding Rectangular Table

22"	46 ¹ / ₁₆ "	14 ¹ / ₂ "	HN19T2	\$706
-----	-----------------------------------	----------------------------------	---------------	-------



For Canadian Pricing
 Multiply U.S. Price by the Canadian price factor.
 ▶ See page 1 for details.

11/11 = Last order entry
 November 20, 2011

Ganging Tables

Standard Includes	Required to Specify
<ul style="list-style-type: none"> Need help? Product details, page 285 Top: laminate with T-mold edge band Edge band: plastic Legs, if selected: paint Nylon glides 	<ol style="list-style-type: none"> Style number Laminate color for top Plastic color number for edge band Paint color for legs, if selected Options, if selected (see below) <p>▶ See <i>Surface Materials</i>, page 691.</p>

Options	U.S. Price	Required to Specify
Wiring & Cabling ❏11/11 • Interport power/data module	+\$274	Specify with <i>interport power/data module</i> .

Tip: Power module is not available on ganging corner table units.

Specification Information				
Dimensions			Style Number	U.S. Base Price
D	W	H		

Ganging End-of-Run Center Table for Tandem Chairs

22"	22 ³ / ₈ "	14 ¹ / ₂ "	HN19TTER ❏11/11	\$484
:	:	:	:	:

Ganging End-of-Run Center Table for Beam Chairs

22"	22 ³ / ₈ "	14 ¹ / ₂ "	HN19TBER ❏11/11	\$484
:	:	:	:	:

Ganging Square Center Table for Tandem Chairs

22"	22 ³ / ₈ "	14 ¹ / ₂ "	HN19TTSG	\$519
:	:	:	:	:

Ganging Square Center Table for Beam Chairs

22"	22 ³ / ₈ "	14 ¹ / ₂ "	HN19TBSG	\$519
:	:	:	:	:

Ganging Corner Table for Tandem Chairs

28"	28"	14 ¹ / ₂ "	HN19TTCG	\$639
:	:	:	:	:

Ganging Corner Table for Beam Chairs

28"	28"	14 ¹ / ₂ "	HN19TBCG	\$639
:	:	:	:	:

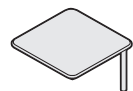
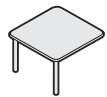
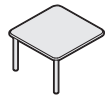

 **For Canadian Pricing**
 Multiply U.S. Price by the Canadian price factor.
 ▶ See page 1 for details.

❏11/11 = Last order entry
 November 20, 2011

Surface Materials

Nurture Surface Materials	692
Color Availability Matrix for Nurture Casegoods	694
Color Availability Matrix for Nurture Seating and Tables	696
Recommended Worksurface Edge Finishes	700
Steelcase Seating Surface Materials	701
Steelcase Wood Seating Surface Materials	702
Turnstone Seating Surface Materials	703
Visual Worktools Surface Materials	704
Upholstery and Color Numbers	706
Nurture Graded-In Programs	
Acrylic Panel	708
Solid Surface	708
Upholstery	709
Fabric Application Direction Guidelines	712

Nurture Surface Materials

This listing includes all the surface material choices that are available for the Nurture products in this specification guide.

Resources

For more information about Nurture surface materials or to get surface material samples, contact Nurture at 1.800.342.8562.

Materials and colors are not available on every product. Refer to the Color Availability Matrices before specifying.

Plastisol/Urethane

6059 Sterling Dark
6161 Graphite
6162 Taupe
6205 Black

Paint

4750 Champagne Metallic
4798 Sterling
4799 Platinum Metallic
4851 Wheat
4853 Cream
4854 Graphite
4855 Silver
7207 Black
7225 Sand
7237 Slate
7238 Fieldstone
7239 Midnight
7241 Arctic White
7243 Seagull

Metal

Polished Chrome
Brushed Stainless Steel
Nickel Steel

Wood

Veneer

3402 Clear Cherry
3412 Natural Cherry **E**
3416 Light Cherry (W-15)
3422 Medium Cherry
3456 Clear on Ash
3457 Almond on Ash
3458 Samba on Ash
3459 Cognac on Ash
3460 Dark Rum on Ash
3461 Shiraz on Ash
3462 Flamenco on Ash
3522 Clear Maple
3572 Amber Maple
3575 Sugarloaf Maple
3576 Almond Cherry
3577 Samba Cherry
3578 Cognac Cherry
3579 Dark Rum Cherry
3580 Shiraz Cherry
3581 Flamenco Cherry
3592 Blonde on Maple
3602 Desert Oak
3620 English Oak (W-20)
3730 Mahogany (W-45)
3772 Medium Mahogany on Walnut
3970 Ebony (W-60)

Laminate

Laminate

2570 Sugarloaf Maple
2571 Almond Cherry
2572 Samba Cherry
2573 Cognac Cherry
2574 Dark Rum Cherry
2575 Shiraz Cherry
2576 Flamenco Cherry

Steelcase High-Pressure Laminate

Applies to:

- Cura Tables
- Exchange Tables
- Folio Worksurfaces
- Malibu Tables
- Neighbor Tables
- Progeny Tables
- Rave Tables
- Sieste Tables
- Sine Tables
- Sonata Tops
- Sync

Fiber Laminate

2850 Vanadium Fiber
2851 Rhyme Fiber
2852 Tungsten Fiber
2854 Vellum Fiber
2859 Novell Fiber
2860 Granite Fiber
2861 Coconut Fiber
2862 Stucco Fiber

Micro Laminate

2920 Marl Micro
2921 Gypsum Micro
2922 Clay Micro
2923 Shadow Micro

Patina Laminate

2870 Blonde Bronze Patina
2871 Blackened Bronze Patina
2873 Instant Iron Patina

Solid Laminate

2722 Cream **E**
2730 Arctic White
2746 Black
2759 Warm White **E**
2766 Warm Brown V1
2782 Grey V1
2811 Mist **E**
2883 Seagull
2884 Milk
2885 Dune

Speckle Laminate

2820 Coffee Speckle
2822 Woodrose Speckle
2823 Driftwood Speckle
2824 Smoke Speckle
2825 Vanadium Speckle

Woodgrain Laminate

2409 Clear Maple
2410 Graphite Walnut
2412 Natural Cherry
2422 Medium Cherry
2511 Winter on Maple
2538 Clear Walnut
2539 Warm Oak
2592 Blonde on Maple
2714 Natural Walnut
2772 Medium Mahogany on Walnut **E**

Turnstone Laminate Collection

A selection of laminates and edge bands in this collection are available on Steelcase brand products. This collection is available with standard leadtimes and supported like standard laminates to help make ordering easy. Please see the Turnstone section of in2.steelcase.com for swatching information.

2535 Virginia Walnut
2536 Blackwood
2612 Marbled Maple
2614 Chocolate Walnut
2615 Marbled Cherry

Open Line Laminate (OLL)

Open Line laminates are available at an additional \$64 (U.S.) per surface, plus the cost of the laminate.

Example:

4' x 8' sheet = 32 square feet
32 square feet x \$1.10 = \$35.20 (U.S.) per sheet
Laminate costs vary by supplier. The cost of the laminate will be added to your invoice as a separate line on the acknowledgement.

Applies to:

- Exchange tables
- Folio Laminate worksurfaces
- Opus
- Sonata
- Jenny
- Sync

This service allows you to order non-standard laminate at an additional fee per unit. See the specification pages for upcharge information.

When processing orders for Open Line Laminate on Opus or Sonata, specify 2902 in the laminate finish field and enter the OLL manufacturer information.

Edge bands must also be specified and will incur an \$83 upcharge.

6131 White
6132 Grey
6133 Folkstone
6134 Northsea
6135 Shadow
6136 Nubian Brown
6137 Black

When processing orders for Open Line Laminate

on Jenny, Exchange tables, Folio Laminate Worksurfaces, and Sync, specify 2900 in the laminate finish field and enter the OLL manufacturer information.

Edge bands must also be specified using the plastic edge band offering.

Thermoform

2030 Arctic White
2031 Seagull
2032 Dune
2065 Sugarloaf Maple
2066 Almond Cherry
2068 Cognac Cherry
2069 Dark Rum Cherry
2070 Shiraz Cherry
2071 Flamenco Cherry
2072 Samba Cherry
6775 Sand

Solid Surface

Applies to:

- Folio Worksurfaces
- Leela
- Senza
- Sonata
- Sync
- Tava

Price Group A

2975 Bisque

Price Group B

2973 Linen

Price Group C

2972 Antarctica
2974 Canvas

E = Established

Plastic Edge Band

- 6013 Sugarloaf Maple
- 6014 Almond Cherry
- 6021 Samba Cherry
- 6022 Cognac Cherry
- 6023 Dark Rum Cherry
- 6024 Shiraz Cherry
- 6025 Flamenco Cherry

Applies to:

- Cura tables
- Exchange tables
- Folio Worksurfaces
- Sync

- 6000 Black
- 6001 Coffee
- 6034 Natural Cherry
- 6036 Medium Cherry
- 6037 Winter on Maple
- 6038 Blonde on Maple
- 6041 Natural Walnut
- 6052 Milk
- 6053 Seagull
- 6231 Graphite Walnut
- 6237 Clear Maple
- 6242 Virginia Walnut
- 6243 Blackwood
- 6245 Clear Walnut
- 6246 Warm Oak
- 6249 Platinum Solid
- 6615 Grey Value 5
- 6619 Ice **E**
- 6631 Cream
- 6635 Dawn **E**
- 6636 Mist
- 6654 Sand
- 6655 Warm White
- 6676 Marbled Maple
- 6677 Chocolate Walnut
- 6678 Marbled Cherry
- 6694 Slate
- 6695 Midnight
- 6697 Fog

Fusion

Applies to:

- Sonata island modules

Price Group 1

- 6526 Mulberry Tissue

Price Group 3

- 6523 Desert Stalk

Price Group 4

- 6525 Sheer Leaf Medium

Soft Pulls

- 6000 Black

E = Established

Markerboard

Applies to:

- Opus wardrobe cabinet with sliding door only
- White

Urethane

Applies to:

- Verge seat
- 6688 Non metallic steel

CuraNet

Applies to:

- Cura
- 5081 Ash (Silver Grey)
5083 Lily Pad (Moss)
5085 Ebony (Black)
5086 Camel
5087 Cocoa
5088 Aquamarine

Promessa

Applies to:

- Cura
- UL81 Ash
UL83 Lily Pad
UL85 Ebony
UL86 Camel
UL87 Cocoa
UL88 Aquamarine

Upholstery

- ▶ See page 706 for a complete listing of upholstery colors and numbers

California 133 Option

Nurture offers Fire Code Seating Modifications (FCS) on nearly all seating models. The most rigorous fire codes in the nation have been developed in California, and the Steelcase FCS modification is designed to meet those codes. Fire Code Seating (FCS) indicates that a product is constructed to meet the strict fire code requirements of high public occupancy areas such as hospitals, theaters, meeting rooms, and lobbies. The FCS standards will meet both the State of California Home Furnishings Technical Bulletin 133 (CAL TB 133) and Boston Fire Code (BFC). Boston adopted the California Home Furnishing Technical Bulletin CAL TB 133 test standard in 1992.

CAL 133 is specified using an "F" suffix. When an "F" suffix is available, it means that these models have been tested and certified using approved fabrics. A complete list of approved fabrics are listed on the COM website at www.Steelcase.com

If a specific chair/fabric combination has not been tested, an actual burn test can be performed on the product in the specified fabric. The cost of the test is \$700 (net). Please allow a minimum of six weeks for the production of the chair and the completion of the test.

Color Availability Matrix for Nurture Casegoods

Legend

- = Not available
- = Available
- = Available with exceptions
- ▶ See specification pages for details.

		Veneer						Laminate								Solid Surface						
		3575	3576	3577	3578	3579	3580	3581	2570	2571	2572	2573	2574	2575	2576	2730	2883	2885	2972	2973	2974	2975
		Sugarloaf Maple	Almond Cherry	Samba Cherry	Cognac Cherry	Dark Rum Cherry	Shiraz Cherry	Flamenco Cherry	Sugarloaf Maple	Almond Cherry	Samba Cherry	Cognac Cherry	Dark Rum Cherry	Shiraz Cherry	Flamenco Cherry	Arctic White	Seagull	Dune	Antarctica	Linen	Canvas	Bisque
Ainsley		■	■	■	■	■	■	■	■	■	■	■	■	■	■	•	•	•	•	•	•	•
Davenport		•	•	•	•	•	•	•	■	■	■	■	■	■	■	•	•	•	•	•	•	•
Exchange Table	Base	•	•	•	•	•	•	•	•	•	•	•	•	•	•	•	•	•	•	•	•	•
	Table Top*	•	•	•	•	•	•	•	■	■	■	■	■	■	■	■	■	■	•	•	•	•
Folio	Cabinets	•	•	•	•	•	•	•	■	■	■	■	■	■	■	■	■	■	•	•	•	•
	Laminate Worksurfaces*	•	•	•	•	•	•	•	■	■	■	■	■	■	■	■	■	■	•	•	•	•
	Solid Surface Worksurfaces	•	•	•	•	•	•	•	•	•	•	•	•	•	•	•	•	•	■	■	■	■
Opus	Cabinets	•	•	•	•	•	•	•	■	■	■	■	■	■	■	•	•	•	•	•	•	•
	Door pulls, table rails, and coat hooks	•	•	•	•	•	•	•	•	•	•	•	•	•	•	•	•	•	•	•	•	•
Park		•	•	•	•	•	•	•	■	■	■	■	■	■	■	■	■	■	•	•	•	•
Senza		■	■	■	■	■	■	■	■	■	■	■	■	■	■	•	•	•	■	■	■	■
Sonata*	Cabinets	•	•	•	•	•	•	•	■	■	■	■	■	■	■	•	•	•	■	■	■	■
	Rails, drawer/door pulls, and coat hooks	•	•	•	•	•	•	•	•	•	•	•	•	•	•	•	•	•	•	•	•	•
Sync*		•	•	•	•	•	•	•	■	■	■	■	■	■	■	■	■	■	■	■	■	■
Viridian		•	•	•	•	•	•	•	•	•	•	•	•	•	•	•	•	•	•	•	•	•
Waldorf		■	■	■	■	■	■	■	•	•	•	•	•	•	•	•	•	•	•	•	•	•
Overbed Tables		•	•	•	•	•	•	•	■	■	■	■	■	■	■	•	•	•	•	•	•	•
Headboards/Footboards		■	■	■	■	■	■	■	■	■	■	■	■	■	■	•	•	•	•	•	•	•

*Exchange table tops, Folio worksurfaces, Sonata tops, and Sync table tops are available in all Steelcase laminates.

▶ See page 701

Color Availability Matrix for Nurture Seating and Tables

Legend

- = Not available
- = Available
- = Available with exceptions
- ▶ See specification pages for details.

		Veneer																										
		3402	3412	3416	3422	3456	3457	3458	3459	3460	3461	3462	3522	3572	3575	3576	3577	3578	3579	3580	3581	3592	3602	3620	3730	3772	3970	
		Clear Cherry	Natural Cherry ^E	Light Cherry (W-15)	Medium Cherry	Clear on Ash	Almond on Ash	Samba on Ash	Cognac on Ash	Dark Rum on Ash	Shiraz on Ash	Flamenco on Ash	Clear Maple	Amber Maple	Sugarloaf Maple	Almond Cherry	Samba Cherry	Cognac Cherry	Dark Rum Cherry	Shiraz Cherry	Flamenco Cherry	Blonde on Maple	Desert Oak	English Oak (W-20)	Mahogany (W-45)	Medium Mahogany on Walnut	Ebony (W-60)	
Amaris	Legs	•	•	•	•	•	•	•	•	•	•	•	•	•	•	•	•	•	•	•	•	•	•	•	•	•	•	
	Arm Caps	•	•	•	•	•	•	•	•	•	•	•	•	•	•	•	•	•	•	•	•	•	•	•	•	•	•	•
Asana		•	•	•	•	•	•	•	•	•	•	•	•	•	•	•	•	•	•	•	•	•	•	•	•	•	•	•
Aspekt	Seating Frame	•	•	•	•	•	•	•	•	•	•	•	•	•	•	•	•	•	•	•	•	•	•	•	•	•	•	•
	Arm Caps	•	•	•	•	•	•	•	•	•	•	•	•	•	•	•	•	•	•	•	•	•	•	•	•	•	•	•
	Table Legs	•	•	•	•	•	•	•	•	•	•	•	•	•	•	•	•	•	•	•	•	•	•	•	•	•	•	•
	Table Top	•	•	•	•	•	•	•	•	•	•	•	•	•	•	•	•	•	•	•	•	•	•	•	•	•	•	•
Cura	Arm Caps	•	•	•	•	•	•	•	•	•	•	•	•	•	•	•	•	•	•	•	•	•	•	•	•	•	•	•
	Frame	•	•	•	•	•	•	•	•	•	•	•	•	•	•	•	•	•	•	•	•	•	•	•	•	•	•	•
	Table Top*	•	•	•	•	•	•	•	•	•	•	•	•	•	•	•	•	•	•	•	•	•	•	•	•	•	•	•
Cypress		•	•	•	•	•	•	•	•	•	•	•	•	•	•	•	•	•	•	•	•	•	•	•	•	•	•	•
Empress	Lounge Frame	•	•	•	•	•	•	•	•	•	•	•	•	•	•	•	•	•	•	•	•	•	•	•	•	•	•	•
	Lounge Arm Caps	•	•	•	•	•	•	•	•	•	•	•	•	•	•	•	•	•	•	•	•	•	•	•	•	•	•	•
Flex Back		•	•	•	•	•	•	•	•	•	•	•	•	•	•	•	•	•	•	•	•	•	•	•	•	•	•	•
Flute		•	•	•	•	•	•	•	•	•	•	•	•	•	•	•	•	•	•	•	•	•	•	•	•	•	•	•
Hawthorne	Seating	•	•	•	•	•	•	•	•	•	•	•	•	•	•	•	•	•	•	•	•	•	•	•	•	•	•	•
Jarrah	Side Trim Panel	•	•	•	•	•	•	•	•	•	•	•	•	•	•	•	•	•	•	•	•	•	•	•	•	•	•	•
	Seating Legs	•	•	•	•	•	•	•	•	•	•	•	•	•	•	•	•	•	•	•	•	•	•	•	•	•	•	•
	Arm Caps	•	•	•	•	•	•	•	•	•	•	•	•	•	•	•	•	•	•	•	•	•	•	•	•	•	•	•
Leela	Arm Caps	•	•	•	•	•	•	•	•	•	•	•	•	•	•	•	•	•	•	•	•	•	•	•	•	•	•	•
	Legs	•	•	•	•	•	•	•	•	•	•	•	•	•	•	•	•	•	•	•	•	•	•	•	•	•	•	•
	Table Top	•	•	•	•	•	•	•	•	•	•	•	•	•	•	•	•	•	•	•	•	•	•	•	•	•	•	•
Linden	Seating Base	•	•	•	•	•	•	•	•	•	•	•	•	•	•	•	•	•	•	•	•	•	•	•	•	•	•	•
	Arm Caps	•	•	•	•	•	•	•	•	•	•	•	•	•	•	•	•	•	•	•	•	•	•	•	•	•	•	•
Loria		•	•	•	•	•	•	•	•	•	•	•	•	•	•	•	•	•	•	•	•	•	•	•	•	•	•	•
Kami		•	•	•	•	•	•	•	•	•	•	•	•	•	•	•	•	•	•	•	•	•	•	•	•	•	•	•
Malibu	Seating	■	■	■	■	•	•	•	•	•	•	•	•	•	•	•	•	•	•	•	•	•	•	•	•	•	•	•
	Tables*	■	■	■	■	•	•	•	•	•	•	•	•	•	•	•	•	•	•	•	•	•	•	•	•	•	•	•
Malibu Too		■	■	■	■	•	•	•	•	•	•	•	•	•	•	•	•	•	•	•	•	•	•	•	•	•	•	•
Mineral	Arm Caps	•	•	•	•	•	•	•	•	•	•	•	•	•	•	•	•	•	•	•	•	•	•	•	•	•	•	•
Mitra	Seating Frame	•	•	•	•	•	•	•	•	•	•	•	•	•	•	•	•	•	•	•	•	•	•	•	•	•	•	•
	Arm Caps	•	•	•	•	•	•	•	•	•	•	•	•	•	•	•	•	•	•	•	•	•	•	•	•	•	•	•
	Table Legs and Bases	•	•	•	•	•	•	•	•	•	•	•	•	•	•	•	•	•	•	•	•	•	•	•	•	•	•	•
	Table Top	•	•	•	•	•	•	•	•	•	•	•	•	•	•	•	•	•	•	•	•	•	•	•	•	•	•	•

- ^E = Established
- * Also available in Steelcase Laminates.
- ▶ See page 701

Color Availability Matrix for Nurture Seating and Tables, continued

Legend

- = Not available
- = Available
- = Available with exceptions
- ▶ See specification pages for details.

		Veneer																									
		3402	3412	3416	3422	3456	3457	3458	3459	3460	3461	3462	3522	3572	3575	3576	3577	3578	3579	3580	3581	3592	3602	3620	3730	3772	3970
		Clear Cherry	Natural Cherry E	Light Cherry (W-15)	Medium Cherry	Clear on Ash	Almond on Ash	Samba on Ash	Cognac on Ash	Dark Rum on Ash	Shiraz on Ash	Flamenco on Ash	Clear Maple	Amber Maple	Sugarloaf Maple	Almond Cherry	Samba Cherry	Cognac Cherry	Dark Rum Cherry	Shiraz Cherry	Flamenco Cherry	Blonde on Maple	Desert Oak	English Oak (W-20)	Mahogany (W-45)	Medium Mahogany on Walnut	Ebony (W-60)
Neighbor	Frames	•	•	•	•	•	•	•	•	•	•	•	•	•	•	•	•	•	•	•	•	•	•	•	•	•	•
	Arm Cap	■	■	■	■	•	•	•	•	•	•	•	■	■	■	■	■	■	■	■	■	■	■	■	■	■	■
	Table Top*	■	■	■	■	•	•	•	•	•	•	•	■	■	■	■	■	■	■	■	■	■	■	■	■	■	■
Nikko	Seating Frame	•	•	•	•	•	•	•	•	•	•	•	•	•	■	■	■	■	■	■	■	•	•	•	•	•	•
	Arm Caps	•	•	•	•	•	•	•	•	•	•	•	•	•	■	■	■	■	■	■	■	•	•	•	•	•	•
Orchid		•	•	•	•	•	•	•	•	•	•	•	•	•	■	■	■	■	■	■	■	•	•	•	•	•	•
Progeny	Frame	■	■	■	■	•	•	•	•	•	•	•	■	■	■	■	■	■	■	■	■	■	■	■	■	■	■
	Arm Cap	■	■	■	■	•	•	•	•	•	•	•	■	■	■	■	■	■	■	■	■	■	■	■	■	■	■
	Table Top*	■	■	■	■	•	•	•	•	•	•	•	■	■	■	■	■	■	■	■	■	■	■	■	■	■	■
Rave	Arm Caps and Frame	■	■	■	■	•	•	•	•	•	•	•	■	■	■	■	■	■	■	■	■	■	■	■	■	■	■
	Tables*	■	■	■	■	•	•	•	•	•	•	•	■	■	■	■	■	■	■	■	■	■	■	■	■	■	■
Sequoia	Seating Frame	•	•	•	•	•	•	•	•	•	•	•	•	•	■	■	■	■	■	■	■	•	•	•	•	•	•
	Arm Caps	•	•	•	•	•	•	•	•	•	•	•	•	•	■	■	■	■	■	■	■	•	•	•	•	•	•
	Table Tops	•	•	•	•	•	•	•	•	•	•	•	•	•	•	•	•	•	•	•	•	•	•	•	•	•	•
Sieste	Arm Caps	■	■	■	■	•	•	•	•	•	•	•	■	■	■	■	■	■	■	■	■	■	■	■	■	■	■
	Legs	■	■	■	■	•	•	•	•	•	•	•	■	■	■	■	■	■	■	■	■	■	■	■	■	■	■
	Table Top*	■	■	■	■	•	•	•	•	•	•	•	■	■	■	■	■	■	■	■	■	■	■	■	■	■	■
Sieste Sleeper		■	■	■	■	•	•	•	•	•	•	•	■	■	■	■	■	■	■	■	■	■	■	■	■	■	■
Sine	Seating and Table Frame	•	•	•	•	•	•	•	•	•	•	•	•	•	•	•	•	•	•	•	•	•	•	•	•	•	•
	Table Top*	•	•	•	•	•	•	•	•	•	•	•	•	•	•	•	•	•	•	•	•	•	•	•	•	•	•
Slumber Day Bed		•	•	•	•	•	•	•	•	•	•	•	•	•	•	•	•	•	•	•	•	•	•	•	•	•	•
Sorrel	Seating Frame and Arm Caps	•	•	•	•	•	•	•	•	•	•	•	•	•	•	•	•	•	•	•	•	•	•	•	•	•	•
	Seating Backs	•	•	•	•	•	•	•	•	•	•	•	•	•	■	■	■	■	■	■	■	•	•	•	•	•	•
	Table Legs	•	•	•	•	•	•	•	•	•	•	•	•	•	•	•	•	•	•	•	•	•	•	•	•	•	•
	Table Tops	•	•	•	•	•	•	•	•	•	•	•	•	•	•	•	•	•	•	•	•	•	•	•	•	•	•
Tava	Arm and Legs	•	•	•	•	■	■	■	■	■	■	■	•	•	•	•	•	•	•	•	•	•	•	•	•	•	•
	Bench Body and Table Tops	•	•	•	•	•	•	•	•	•	•	•	•	•	•	•	•	•	•	•	•	•	•	•	•	•	•
Traditional Lounge		•	•	•	•	•	•	•	•	•	•	•	•	•	■	■	■	■	■	■	■	•	•	•	•	•	•
X-tenz Sleeper	Arm Caps	•	•	•	•	•	•	•	•	•	•	•	•	•	■	■	■	■	■	■	■	•	•	•	•	•	•
	Frame	•	•	•	•	•	•	•	•	•	•	•	•	•	•	•	•	•	•	•	•	•	•	•	•	•	•
Verge		•	•	•	•	•	•	•	•	•	•	•	•	•	•	•	•	•	•	•	•	•	•	•	•	•	•
Freestanding and Interconnecting Tables																											
	Table Top	•	•	•	•	•	•	•	•	•	•	•	•	•	•	•	•	•	•	•	•	•	•	•	•	•	•
	Metal Legs	•	•	•	•	•	•	•	•	•	•	•	•	•	•	•	•	•	•	•	•	•	•	•	•	•	•
	Wood Legs	•	•	•	•	•	•	•	•	•	•	•	•	•	■	■	■	■	■	■	■	•	•	•	•	•	•

E = Established
 * Also available in Steelcase Laminates.
 ▶ See page 701

Recommended Worksurface Edge Finishes

Recommended Edge Colors

Edges

The recommended edge color will complement the laminate color you specify. Edge color is specified separately.

Steelcase Laminate Color	Recommended 3 mm Edge Color
--------------------------	-----------------------------

Fiber	
2850 Vanadium Fiber	6654 Sand
2851 Rhyme Fiber	6631 Cream
2852 Tungsten Fiber	6636 Mist
2854 Vellum Fiber	6655 Warm White
2859 Novell Fiber	6001 Coffee
2860 Granite Fiber	6000 Black
2861 Coconut Fiber	6654 Sand
2862 Stucco Fiber	6053 Seagull

Micro	
2920 Marl Micro	6053 Seagull
2921 Gypsum Micro	6654 Sand
2922 Clay Micro	6654 Sand
2923 Shadow Micro	6249 Platinum Solid

Patina	
2870 Blonde Bronze Patina	6654 Sand
2871 Blackened Bronze Patina	6615 Grey Value 5
2873 Instant Iron Patina	6615 Grey Value 5

Solid	
2722 Cream E	6631 Cream
2730 Arctic White	6697 Fog
2746 Black	6000 Black
2759 Warm White E	6655 Warm White
2811 Mist E	6636 Mist
2883 Seagull	6053 Seagull
2884 Milk	6052 Milk
2885 Dune	6654 Sand

Speckle	
2820 Coffee Speckle	6631 Cream
2822 Woodrose Speckle	6635 Dawn E
2823 Driftwood Speckle	6631 Cream
2824 Smoke Speckle	6636 Mist
2825 Vanadium Speckle	6619 Ice E

Woodgrain	
2409 Clear Maple	6237 Clear Maple
2410 Graphite Walnut	6231 Graphite Walnut
2412 Natural Cherry	6034 Natural Cherry
2422 Medium Cherry	6036 Medium Cherry
2511 Winter on Maple	6037 Winter on Maple
2538 Clear Walnut	6245 Clear Walnut
2539 Warm Oak	6246 Warm Oak
2592 Blonde on Maple	6038 Blonde on Maple
2714 Natural Walnut	6041 Natural Walnut
2772 Medium Mahogany on Walnut E	6045 Medium Mahogany on Walnut E

Nurture Laminate Color	Recommended 3 mm Edge Color
------------------------	-----------------------------

Fiber	
2570 Sugarloaf Maple	6013 Sugarloaf Maple
2571 Almond Cherry	6014 Almond Cherry
2572 Samba Cherry	6021 Samba Cherry
2573 Cognac Cherry	6022 Cognac Cherry
2574 Dark Rum Cherry	6023 Dark Rum Cherry
2575 Shiraz Cherry	6024 Shiraz Cherry
2576 Flamenco Cherry	6025 Flamenco Cherry

E = Established

This listing includes all the surface material choices that are available for the products in this specification guide.

Resources

For more information about surface materials, refer to the following resources:

Additional surface materials specification tools are available to assist you in the specification process—the Surface Materials Binders.

Surface Materials Binders

- Surface Materials Reference Manual
- A complete set of swatch cards for hard surfaces, vertical surface fabrics, and seating upholstery

Materials and colors are not available on every product. Refer to the Color Availability and Upholstery Matrices before specifying.

Plastic

- 6009 Arctic White
- 6059 Sterling Dark Solid
- 6205 Black
- 6206 Burgundy
- 6249 Platinum Solid
- 6250 Coffee
- 6256 Graphite
- 6259 Midnight
- 6268 Navy
- 6296 Sterling
- 6301 Aegean
- 6302 Baltic
- 6303 Pomegranate
- 6332 Citron
- 6333 Picasso
- 6334 Flash
- 6335 Wasabi
- 6336 Jazz
- 6337 Element
- 6338 Chili

Seating Coating

- 7000 Black
- 7005 Coffee
- 7011 Graphite

Paint

- 0835 Black
- 4799 Platinum Metallic
- 7239 Midnight

E = Established

Metal

- 8046 Polished Aluminum
- 9201 Polished Chrome

Laminate

- 2406 Clear Cherry
- 2409 Clear Maple
- 2410 Graphite Walnut
- 2412 Natural Cherry
- 2422 Medium Cherry
- 2511 Winter on Maple
- 2538 Clear Walnut
- 2539 Warm Oak
- 2714 Natural Walnut
- 2722 Cream
- 2730 Arctic White
- 2746 Black
- 2759 Warm White
- 2772 Medium Mahogany on Walnut **E**
- 2811 Mist
- 2883 Seagull
- 2884 Milk
- 2885 Dune

Elmosoft Leather

- L110 Maritime Blue
- L111 Midnight Blue
- L112 Ebony
- L113 Gunmetal
- L114 Mica
- L115 Dove Grey
- L116 Plum Pleasure
- L122 Truffle
- L128 Red Birch
- L132 Violet
- L133 Espresso
- L134 Ruby
- L135 Scarlet
- L136 Claret
- L137 Cabernet
- L138 Bourbon
- L139 Cinder
- L140 Garnet
- L143 Pecan
- L144 Chamois
- L145 Palomino
- L146 Russet
- L147 Saddle
- L148 Goldstone
- L150 Ivory
- L151 White
- L709 Sugar
- L710 Lava
- L711 Parchment
- L712 Buff
- L713 Sand
- L714 Maize
- L715 Camel
- L716 Khaki
- L717 Cameo
- L718 Mushroom
- L719 Taupe
- L720 Fawn
- L721 Rock
- L722 Desert
- L723 Storm
- L724 Mist
- L725 Teal
- L726 Celadon
- L727 Egyptian Blue
- L728 Bright Blue
- L729 Aquarium
- L730 Hunter
- L731 Fern
- L732 Edamame
- L733 Moss
- L734 Key Lime
- L735 Creamsicle
- L736 Lemon
- L737 Sunshine
- L738 Drama
- L739 Byzantium
- L740 Dazzle
- L741 Fuchsia
- L742 Flamingo

3D Knit

- 5064 Licorice
- 5065 Coconut
- 5066 Malt
- 5067 Root Beer
- 5090 Wasabi
- 5091 Maya Blue
- 5092 Graphite
- 5093 Nickel
- 5094 Tangerine
- 5095 Scarlet
- 5096 Turmeric
- 5097 Concord
- 5098 Blue Jay
- 5099 Basil

Upholstery

▶ See page 706 for a complete listing of upholstery colors and numbers.

▶ Check the COM database for specific product and fabric approvals.

Steelcase Wood Seating Surface Materials

This listing includes all the surface material choices that are available for the Steelcase Wood Seating products in this specification guide.

Resources

For more information about surface materials, refer to the following resources:

Additional surface materials specification tools are available to assist you in the specification process—the Surface Materials Binders.

Surface Materials Binders

- include:
- Surface Materials Reference Manual
 - A complete set of swatch cards for hard surfaces, vertical surface fabrics, and seating upholstery

Metal

- 4798 Sterling Metallic
- 7026 Nickel
- 7207 Black
- 8046 Polished Aluminum
- 9201 Polished Chrome

Paint

- 0835 Black
- 4799 Platinum Metallic
- 7207 Black

Wood

▶ See *Color Availability Matrix for Wood Seating in Surface Materials Reference Manual for color availability by product line.*

Tip: The wood used in the construction of chairs is either maple or European beech. Wood finishes applied to maple or beech will match the color of stains applied to oak, walnut, or cherry, but will not have the same natural grain.

- 3062 Graphite Walnut
- 3402 Clear Cherry
- 3412 Natural Cherry **E**
- 3422 Medium Cherry
- 3522 Clear Maple*
- 3572 Amber on Maple
- 3592 Blonde on Maple
- 3602 Desert Oak
- 3612 Warm Oak
- 3692 Espresso Oak
- 3702 Clear Walnut
- 3712 Natural Walnut
- 3722 Dark Mahogany on Walnut
- 3752 Medium Walnut
- 3762 Dark Walnut
- 3772 Medium Mahogany on Walnut

**To ensure an understanding of the color ranges and characteristic variations of natural veneer, a sign-off sheet is required prior to orders being accepted for this clear-coat finish. The sign-off sheet is available through Steelcase advertising stock. Form number 05-0001370.*

Customiz stain is a service that allows you to create your own stain color. Minimum order quantities, per unit up-charges, and a one-time customer processing fee apply.

▶ See the *Surface Materials Reference Manual* for more information.

Upholstery

▶ See page 706 for a complete listing of upholstery colors and numbers.

▶ Check the COM database for specific product and fabric approvals.

E = Established

► For Surface Materials matrices for all Turnstone product lines, see *Surface Materials Reference Manual*.

Paint

Applies to:

- Scoop
- 4799 Platinum Metallic
- 7207 Black

Applies to:

- Jenny tablet arm
- 7207 Black

Plastic

Applies to:

- Jenny tablet arm
- Jenny end table
- Jenny coffee table
- 6205 Black

Applies to:

- Scoop
- 6618 White
- 6682 Cobblestone

Applies to:

- Jenny end table edge band
- Jenny coffee table edge band
- 6000 Black
- 6009 Arctic White
- 6034 Natural Cherry **E**
- 6037 Winter on Maple
- 6053 Seagull
- 6234 Clear Cherry
- 6242 Virginia Walnut
- 6243 Blackwood
- 6245 Clear Walnut
- 6246 Warm Oak
- 6636 Mist
- 6654 Sand
- 6676 Marbled Maple
- 6677 Chocolate Walnut
- 6678 Marbled Cherry
- 6689 Brushed Silver

Laminate

Low-Pressure Laminate

Applies to:

- Jenny tablet arm
- Jenny end table
- Jenny coffee table
- 247L Black Version 2 LPL
- 25L1 Winter on Maple LPL
- 25L5 Virginia Walnut LPL
- 25L6 Blackwood LPL
- 25L8 Clear Walnut LPL
- 25L9 Warm Oak LPL
- 262L Marbled Maple LPL
- 264L Chocolate Walnut LPL
- 267L Marbled Cherry Version 2 LPL
- 26L1 Natural Cherry Version 2 LPL
- 2L03 Brushed Silver LPL
- 2L30 Arctic White LPL
- 2L50 Vanadium Fiber LPL
- 2L52 Tungsten Fiber LPL
- 2L83 Seagull LPL
- 2L85 Dune LPL

High-Pressure Laminate

Applies to:

- Jenny tablet arm
- Jenny end table
- Jenny coffee table
- 2406 Clear Cherry
- 2412 Natural Cherry Version 2 HPL
- 2503 Brushed Silver HPL
- 2511 Winter on Maple HPL
- 2535 Virginia Walnut HPL
- 2536 Blackwood HPL
- 2538 Clear Walnut HPL
- 2539 Warm Oak HPL
- 2612 Marbled Maple HPL
- 2614 Chocolate Walnut HPL
- 2615 Marbled Cherry Version 2 HPL
- 2730 Arctic White HPL
- 2746 Black HPL
- 2850 Vanadium Fiber HPL
- 2852 Tungsten Fiber HPL
- 2883 Seagull HPL
- 2885 Dune HPL

Note: Some wood veneer finishes and woodgrain laminates share the same name. Because of the difference in materials, veneers and laminates of the same name are not an exact match but do coordinate with each other.

Wood

Applies to:

- Jenny wood legs
- Jenny wood arm
- 3412 Natural Cherry **E**
- 3522 Clear Maple
- 3762 Dark Walnut

Tip: Due to natural variations in wood, finished products may vary in color, texture and grain.

Turnstone Leather

T802 Black
T803 Port
L305 Brown Leather

Upholstery

► See *Surface Materials Reference Manual* for a complete listing of upholstery colors and numbers.

► Check the COM database for specific product and fabric approvals.

E = Established

Visual Worktools Surface Materials

This listing includes all surface material and/or finish choices applicable to Premium Whiteboards and Tackboards, and Contractor Series. Not all surface material and/or finish choices are available on all products. Please refer to the Finish Matrices.

► For surface materials matrices, see the *Visual Worktools Specification Guide*.

Paint

Price Group 2

- 0835 Black **E**
- 4750 Champagne Metallic
- 4798 Sterling Metallic
- 4799 Platinum Metallic

Metal Paint

Price Group 2

- 8043 Clear Anodized Aluminum
- 8044 Black Anodized Aluminum

Wood

Wood Trim Finishes

The wood finish is an open pore, high gloss finish on maple, cherry, or walnut. Colors match current Steelcase wood finishes in color only and do not match the Steelcase finish in sheen.

- 3412 FC/OP Natural Cherry **E**
- 3422 FC/OP Medium Cherry
- 3572 FC/OP Amber on Maple
- 3592 FC/OP Blonde on Maple
- 3712 FC/OP Natural Walnut on Walnut
- 3772 FC/OP Medium Mahogany on Walnut

Markerboard Surface

Markerboards are standard in white high-gloss 7655 e³ environmental ceramicsteel. Optional screenprint patterns are available to provide a guide for writing or drawing. See below for patterns.

Standard:

- 7655 High Gloss White

Optional Screenprint on e³ environmental ceramicsteel:

- 7656 2" Circular Dot Pattern
- 7657 2" Grid Pattern
- 7658 Music Staff Lines

Vertical Surface Fabric

Fabric Tackboard Surfaces

Tackboard surfaces are available in select Steelcase and Designtex fabrics; pricing for Designtex and Steelcase fabrics is determined by a grading program. All fabrics are applied railroaded, i.e. salvages parallel to floor.

Price Group 1

Abacus **E**

- P122 Entasis
- P123 Portico
- P124 Opus
- P125 Cusp
- P126 Artifact
- P129 Atlas

Bariolage

- G220 Etude
- G221 Andante
- G226 Cantata
- G227 Adagio
- G233 Melody
- G234 Ballata
- G235 Sonata

Designtex Graded-In Program

For additional information and fabric samples, contact your local Designtex sales representative at 1.800.221.1540.

The following fabrics are part of the program formerly known as Designtex Graded-In. These patterns can be ordered through the Select Surfaces order fulfill model.

► See *Surface Materials Reference Manual* for complete Select Surfaces ordering information.

Price Group 2

- Brunswick - 6307
- Solara - 4101

Price Group 3

- Foxtrot - 6375
- Sumo - 6499

Price Group 4

- Rivergrass - 2690

Price Group COM (Customer's Own Material)

Fabric Approval and Yardage

To confirm whether a particular COM material has already been tested for use on a specific Steelcase product or to determine actual yardage requirements:

- Visit www.steelcase.com

For additional information regarding Customer's Own Material, call

1.888.STEELCASE (1.888.783.3522) or send an e-mail to lineone@steelcase.com.

E = Established

Upholstery and Color Numbers

Upholstery

Not all fabrics are available on all products. See the COM database for specific product and fabric availability.

Price Group 1

Buzz2

5F01 Camel **E**
 5F03 Tomato
 5F04 Red **E**
 5F05 Burgundy
 5F06 Sky **E**
 5F07 Blue
 5F08 Navy
 5F10 Grape **E**
 5F11 Eggplant **E**
 5F15 Stone
 5F16 Grey
 5F17 Black
 5G50 Dunegrass
 5G51 Sable
 5G52 Barley
 5G53 Sunrise
 5G54 Carrot
 5G55 Pumpkin
 5G56 Timber
 5G57 Rouge
 5G58 Chocolate
 5G59 Meadow
 5G60 Ivy
 5G61 Cyan
 5G62 Atlantic
 5G63 Crocus
 5G64 Alpine
 5G65 Tornado

Jacks

5B61 Taupe
 5B63 Camel
 5B64 Pewter
 5B66 Plum
 5B70 Midnight

Link

5A20 Burgundy
 5A21 Rust
 5A23 Green
 5A24 Blue
 5A25 Navy
 5A26 Purple
 5A27 Black
 5A28 Ocean
 5A29 Lichen
 5A30 Chamois

Playground

5F28 Claret
 5F29 Chile
 5F30 Amber
 5F31 Nut
 5F32 Blade
 5F33 Stone
 5F34 Sky
 5F35 Navy
 5F36 Huckleberry
 5F37 Charcoal

Seating Vinyl

5801 Topaz
 5805 Foggy Night
 5809 Black
 5810 Forest
 5812 Navy
 5813 Currant
 5814 Leaf
 5815 Seaside
 5817 Pebble
 5818 Spice
 5819 Thistle
 5820 Coffee
 5822 Iris

Price Group 2

Cogent: Connect

5S15 Coconut
 5S16 Turmeric
 5S17 Tangerine
 5S18 Scarlet
 5S19 Concord
 5S20 Maya Blue
 5S21 Blue Jay
 5S22 Basil
 5S23 Wasabi
 5S24 Nickel
 5S25 Graphite
 5S26 Licorice
 5S27 Malt
 5S28 Root Beer
 5S93 Blueprint
 5S94 Lizard
 5S95 Sailor
 5S96 Quicksilver
 5S97 Nugget
 5S98 Canary
 5S99 Lipstick

Cogent: Geode Seating

5S46 Bark
 5S47 Coal
 5S48 Smoke
 5S49 Cobalt
 5S50 Ink
 5S51 Shamrock
 5S52 Pear
 5S53 Berry
 5S54 Mandarin
 5S55 Sunset
 5S56 Citrus
 5S57 Thunder

Cogent: Geode Vertical

5S31 Pebble
 5S32 Canyon
 5S33 Honey
 5S34 Ice
 5S35 Slate
 5S36 Cement
 5S37 Rock
 5S38 Oyster
 5S39 Buff
 5S40 Toast
 5S41 Sesame
 5S42 Ecru
 5S43 Dove

Cogent: Trails

5S29 Bronzite
 5S30 Amethyst
 5S84 Jasper
 5S85 Agate
 5S86 Lapis
 5S87 Malachite
 5S88 Quartz
 5S89 Carnelian
 5S90 Tiger Eye
 5S91 Travertine
 5S92 Topaz

Cricket

5A84 Plum
 5A85 Camel
 5A86 Charcoal
 5A87 Black
 5A90 Currant
 5A91 Spearmint
 5A92 Sky
 5A93 Midnight
 5A95 Ocean
 5A96 Forest

Crosswalk

5F48 Beech
 5F49 Moon
 5F50 Berry
 5F51 Admiral Blue
 5F52 Moss
 5F53 Persimmon
 5F54 Bittersweet
 5F55 Midnight
 5F56 Poppy

Nitelights

5F58 Hazelnut
 5F59 Burgundy
 5F60 Cherry
 5F61 Earth
 5F62 Shore
 5F63 Moss
 5F64 Sea
 5F65 Regal Blue
 5F66 Stone
 5F67 Moon

Regis2

5F18 Black
 5F24 Pacific
 5F26 Cherry
 5F27 Navy

Spyder

5B00 Orchid **E**
 5B01 Foggy Night **E**
 5B04 Peri **E**
 5B05 Merlot **E**
 5B06 Dove **E**
 5B07 Sage **E**
 5B09 Topaz **E**
 5B11 Currant **E**
 5B12 Lichen **E**

Zoe2

5C90 Eggplant
 5C91 Aloe
 5C92 Fiddle
 5C93 Patina
 5C94 Peacock
 5C95 Rain
 5C96 Grey Flannel
 5C97 Pebble
 5C98 Cymbal
 5C99 Fiesta

Price Group 3

Cogent: Tides

5S71 Butter
 5S72 Snow
 5S73 Celery
 5S74 Wicker
 5S75 Pool
 5S76 Cloud
 5S77 Grass
 5S78 Clay
 5S79 Hyacinth
 5S80 Jet
 5S81 Doe
 5S82 Boysenberry
 5S83 Night

Hampstead

B351 Blue Green V4 **E**
 B359 Blue Blue
 Green V5 **E**
 B366 Blue Blue Violet
 V4 **E**
 B369 Blue Blue Violet
 V5 **E**
 B377 Violet V5
 (Low Intensity) **E**
 B389 Red Red
 Violet V5 **E**
 B395 Grey V5 **E**
 B399 Black
 B406 Windflower **E**
 B413 Shale **E**
 B423 Clementine
 B424 Butter Cream
 B425 Iris
 B426 Sapphire
 B427 Turquoise
 B428 Navy
 B429 Charcoal
 B430 Spa
 B431 Plum
 B432 Cocoa
 B433 Cork
 B434 Stone
 B435 Metal
 B436 Peridot
 B437 Cactus
 B438 Sycamore
 B439 Candy Apple

Price Group 5

Bo Peep

5G66 Pita
 5G67 Bone
 5G68 Safari
 5G69 Brown Sugar
 5G70 Chocolate Chip
 5G71 Candlelight
 5G72 Honey Mustard
 5G73 Marmalade
 5G74 Picnic
 5G75 Pinot
 5G76 Bloom
 5G77 Grapevine
 5G78 Firefly
 5G79 Artichoke
 5G80 Serpent
 5G81 Carolina
 5G82 Blue Bonnet
 5G83 Nautical
 5G84 Gravel
 5G85 Sharkskin
 5G86 Kohl

Price Group 6

Brisa

BR01 Black Onyx
 BR04 Truffle
 BR06 Ash
 BR07 Sage
 BR08 Celery
 BR09 Sterling Blue
 BR10 Night Navy
 BR11 Cambridge Blue
 BR12 Abyss
 BR13 Canyon
 BR14 Pompeian Red
 BR15 Salsa
 BR16 Cinnabar
 BR17 Aztec
 BR18 New Sand
 BR19 Cream
 BR20 White
 BR21 Moccasin
 BR22 Buckskin
 BR23 Prairie

Leather Price Group

L107 Black
 L202 Dusk
 L203 Bottle
 L207 Mahogany
 L220 Soapstone
 L221 Rocky
 L224 Plum
 L500 Camel
 L503 Navy
 L507 Vineyard

E = Established

**Select Surfaces
Designtex**

For additional information and fabric samples, contact your local Designtex sales representative at 1.800.221.1540.

The following fabrics are part of the program formerly known as Designtex Graded-In. These patterns can be ordered through the Select Surfaces order fulfillment model. These materials are available on Steelcase and Nurture brand products.
▶ See *Surface Materials Reference Manual* for complete Select Surfaces ordering information.

**Price Group 2 -
Finish Code 59DB**

Bee - 4975
Ludington - 3285
Sandpiper - 3313

**Price Group 3 -
Finish Code 59DC**

Boyne - 3280
Crossroads - 2895
Great Lakes - 3282
Lagoon - 4977
Prairie - 2552
Rocket - 2693

**Price Group 4 -
Finish Code 59DD**

Astrid - 2747
At Ease - 3309
Bolzano - 3412
Bunta - 3360
Candor - 3306
Closed Loop - 2550
Easy Going - 3305
Free & Easy - 3316
Glen Arbor - 3283
Gujarat - 3357
Introvert - 2879
Kalanga - 3359
Leland - 3281
Matter of Fact - 3356
Metta - 2681
No Frills - 3318
Nonchalant - 3307
Omar Seating - 2865
Sari - 3361
Sarong - 3358
Saugatuck - 3284
To The Point - 3308
Topiary - 2897
Well Rounded - 3317

**Price Group 5 -
Finish Code 59DE**

Abex - 2072
Appleseed - 2682
Brooch - 2762
Café - 2789
Caillou - 2778
Cascadia - 2733
Crossover - 2683
Fonte - 2796
Halos - 2899
Kabuki - 2794
Metaphor - 2877
Protect - 2852
Salon - 2797
Surface - 2787
Sustain - 2851
Synchronize - 2876
Tailored Stripe - 2763
Terrasse - 2795
V - 2957

**Price Group 6 -
Finish Code 59DF**

Acacia - 2843
Agave - 2847
Alistair - 2992
Allure - 2756
Amaranth w/o Crypton - 2855u
Amuse - 2767
Arlington - 2724
Banda - 3227
Barnsbury - 2726
Bottle Bank - 2869
Cassava - 2838
Chicory - 2993
Circolo - 3229
Converge - 2873
Copa - 2641
Coupe - H245
Dahlia - 2995
Décor - H244
Dot to Dot - 2691
Downtown - 2029
Epiphany - 2734
Faconne - 2764
Friendly Faux w/Knit Backing - 2008
Griglia - 3231
Hula Hoop - 3297
Kenaf - 2859
Kenaf w/o Crypton - 2859u
Klange - 2741
Knockabout - 3326
Laureate - 2774
Palace - H254
Pivot - 3374
Pueblo - 2844
Quintessence - 3347
React - 2861
Rice - 2858
Rough & Ready - 2016
Salvage - 2867
Seed - 2839
Senna - 2848
Sequence - 2742
Sock Hop - 3298
Soda Pop - 2868
Square - 2788
Swing Set - 2421
Tangent - 2875
Tartan - 2994
Teddy - H236
Terrain - 2846
Transpose - 2874
Tumbleweed - 2845

**Price Group 7 -
Finish Code 59DG**

Amaranth - 2855
Baratto - 3266
Battista - 2718
Beam - 2785
Bon Bon - 2749
Calm - 2768
Cestino - 3270
Chakin - 7146
Coperta - 3228
Drive-In - 3299
Dwell - 2850
Faux Sure w/Knit Backing - 3351
Flux - 3239
Fuse w/Knit Backing - 3362
Garden Key - 3252
Inertia - 3235
Juxtaposition - 2744
Kaleidoscope - 2863
Lorien - H201
Minuet - 2656
Oscillate - 3238
Point - 2783
Razor Stripe - 2857
Samba - 2654
Samba Otra Vez - 2885
Spiro - 3237
Sundance - 3278
Uptown - 2024
Yoruba - 3333
Ziggurat - 2827

**Price Group 8 -
Finish Code 59DH**

Biba - H216
Chandelier - 7354
Circumference - 2884
Facets - 7350
Honor Plus - 2547
Hue - 2710
Maglia - 3233
Nexus - 3236
Polygon - 2883
Thumbnail Sketch - 2841
Titanium - 2842
Torsade - 7358
Valanka - 3279
Wire - 2743

**Price Group 9 -
Finish Code 59DJ**

Bangles - 7352
Belvedere - 3275
Gotham - 2390
Gramercy - 2599
Hofburg - 3276
Yorkshire - 2771

**Price Group 10 -
Finish Code 59DK**

Chalet - 3290
Kanthas - H238
Links - 7353
Lolland - 3263
Metamorphosis w/Knit Backing - 3367
Migration w/Knit Backing - 3373
Shimmering Tide w/Knit Backing - 3369
Tumble Stones w/Knit Backing - 3371
Wood Work w/Knit Backing - 3372

**Price Group
COM/COL
(Customer's Own
Material/Leather)**

**Fabric Approval and
Yardage**

To confirm whether a particular COM material has already been tested for use on a specific Steelcase or Nurture product or to determine actual yardage requirements:
• Visit www.steelcase.com

For additional information regarding Customer's Own Material, call 1.888.STEELCASE (1.888.783.3522) or send an e-mail to lineone@steelcase.com.

For Nurture products, call 1.800.342.8562.

Nurture Graded-In Programs

Nurture Graded-In Program: Acrylic Panel

A collection of acrylic panels are available as part of a Graded-In Program. The collection is from the Designtex Fusion offering.

These acrylic panels are Graded-In for the Sonata product only. The collection on these pages is not Graded-In for other Steel-case brands or product lines.

To order these acrylic panels, enter the finish code which corresponds with the acrylic panel price group.

Price Group	Finish Code
1	65DA
2	65DB
3	65DC
4	65DD

Then enter the acrylic panel information in the Special Acrylic Panel Information pop up window. If prompted, enter the finish code DSGNTX0002 based on the acrylic panel supplier.

Designtex

Fusion Offering

Price Group 1

Blueberry
Bluestone
Bubblegum
Canary
Candy Apple
Etch
Grape
Key Lime
Lemon
Periwinkle
Plum
Red
Sea
Searchlight
Slate
Tangerine
White
White Dot
White Rain
White Ribbon

Price Group 2

Berry Grid
Bone Linen
Cloud Grid
Espresso Sketch
Flame Sketch
Flannel Linen
Granny Smith Grid
Grapefruit Grid
Halo
Honey Sketch
Ice Sketch
Noir Linen
Orange Grid
Pistachio Sketch
Reef Linen
Scarlet Sketch
Sky Grid
Tiki Stalk
Windowbox

Price Group 3

Kenya Rush
Ogee
Prairie Stalk
Savannah Rush
Straws

Price Group 4

Coil
Convection
Desert Stalk 50% More
Drink Tray
Fingerprints
Grassland
Green Sheer Leaf
Illumination
Large Sheer Leaf
Maroon Sheer Leaf
Plain
Rock Candy
Sapphire Rock Candy
Small Sheer Leaf
Toffee Sheer Leaf
Underwood

Nurture Graded-In Program: Solid Surface

A collection of solid surfaces are available as part of a Graded-In Program. The collection is from the Corian solid surface offering.

These solid surfaces are Graded-In for the Folio, Sonata, Sync, Senza, Tava, and Leela products only. The collection on these pages is not Graded-In for other Steelcase brands or product lines.

To order these solid surfaces, enter the finish code which corresponds with the solid surface price group.

Price Group	Finish Code
A	29DA
B	29DB
C	29DC
D	29DD
E	29DE

Then enter the solid surface information in the Special Solid Surface Information pop up window. If prompted, enter the finish code CORIAN0001 based on the solid surface supplier.

Corian

Solid Surface Offering

Price Group A

Glacier White

Price Group B

Abalone
Aurora
Cameo White
Canyon
Cobalt
Flint
Maui
Mojave
Moss
Platinum
Sahara
Sand
Sandstone
Savannah
Silt
Tarragon
Vanilla

Price Group C

Acorn
Adobe
Bethany
Blue Crush
Blue Pebble
Canyon Trail
Cocoa Brown
Cottage Lane
Doeskin
Fossil
Granola
Gray Fieldstone
Gray Pebble
Mardi Gras
Matterhorn
Medea
Mosaic
Night Sky
Oat
Pine
Riviera
Sage Graystone
Shale
Silver Birch
Stone Harbor
Suede
Willow

Price Group D

Anthracite
Azurite
Bronze Patina
Bronzite
Concrete
Copperite
Designer White
Dove
Fawn
Graphic Blue
Green Tea
Hot
Lilac
Mandarin
Nocturne
Olivite
Pompeii Red
Raffia
Rice Paper
Serene Sage
Silverite
Sun
Tranquil
Venaro White
Whisper
White Jasmine

Price Group E

Aqualite
Arctic Blueberry
Arctic Ice
Arctic Lime
Arctic Mint
Arctic Strawberry
Aztec Gold
Blueberry Ice
Burled Beach
Chamois
Cinnabar
Cirrus White
Clam Shell
Earth
Ecu
Elderberry
Glacier Ice
Graylite
Jasmine
Juniper
Lava Rock
Lime Ice
Mint Ice
Natural Gray
Rain Cloud
Rosemary
Saffron
Sagebrush
Sandalwood
Slate
Sonora
Sorrel
Strawberry Ice
Thyme
Tumbleweed
Verde
Witch Hazel

Nurture Graded-In Program: Upholstery

A collection of textiles are available as part of a Graded-In Program. The collection from the leading suppliers in the market consists of high-performance textiles that meet the demands of healthcare environments. Note that not all fabrics can be applied to all seating products. Refer to the Steelcase COM database for the most current application information.

To order these fabrics, enter the finish code which corresponds with the fabric price group.

Price Group	Finish Code
2	59DB
3	59DC
4	59DD
5	59DE
6	59DF
7	59DG
8	59DH
9	59DJ
10	59DK

Then enter the fabric information in the Special Fabric Information pop up window. Enter the appropriate finish code from the list below, based on the fabric supplier.

Supplier	Finish Code
Architex	ARCHTX0001
ArcCom	ARCCOM0001
CF Stinson	CFSTIN0001
DesignTex	DSGNTX0001
Maharam	MAHARA0001
Momentum	MOMENT0001
Ultrafabrics	ULTRAF0001

Fabric application direction must be specified.

► See page 712 for *Fabric Application Direction Guidelines* to ensure fabric is specified in the correct direction.

Architex

Price Group 5

Daytona
Linen

Price Group 6

Ellipse
Joy
Matrix
Radius

Price Group 7

Animal
Authentec
Daybreak
Hyde
Patent
Sprig
Tegan
Tibet
Vanish
Voila

Price Group 8

Bonnie
Delight
Easton
Fish Out Of Water
Kenga
Mabel
Pick Up Sticks
Ruth
Sarah
Spellbound
Thrive
Your Bird Can Sing

Price Group 9

Bamboo Mate
Brook
Burst
Follow Me
Morin
Nili
Ripples

Price Group 10

Pelle

Arc-Com

Arc-Com graded-in fabrics can only be used on Nurture brand products.

Price Group 4

Duchess
Illusion
Lancaster

Price Group 5

Alamo
Cassio
Durango
Frontier
Gatsby
Pebble Beach
Shimmer
Silver Birch
Strata
Terra

Price Group 6

Allegra
Bravo
Checkmate
Chit-Chat
Etch
Fireflies
Gem
Grand Central
Grassland
Hopscotch
Jing
Leonardo
Lotus
Matrix
Palatine
Panache
Pinpoint
Sierra
Silverado
South Street
Suede Sensation
Sylvan
Tribeca
Vibrato
Willow

Price Group 7

Abacus
Aline
Aruba
Ashanti
Bauble
Beat Box
Bourbon Street
Broadway
Bronco
Cadence
Carnival
Dorset
Eclipse
Élan
Grammercy Park
Hemisphere
Hydro
Iguana
Intaglio
Iron Gate
Link
Mirage
Moon Beam
Mystique
Notting Hill
Pinball
Pong
Quadrant
Rhythm
Savannah
Stonehenge
Sublime
Symphony
Trio
Vibe
Whirlwind
Wonderland

Price Group 8

Bounce
Bubbly
Circuit
Diamond Derby
Espirit
Flora
Forsythia
Gamble
Heirloom
Jardin
Kalahari
Kendo
Kensington
Lily Pond
Masquerade
Nikko
Oasis
Piazza
Posh
Radiant
Riviera
Royal Garden
Salsa
Seagrass
Sherwood
Spotlight
Spring
Strand-It
Tango
Tatami
Tuscany
Victoria
Volley
Yoyo

Price Group 9

Francesca Wool
Francesca Wool II
Groovy
Juliet
Sagrada
Uptown
Wind Chime

Price Group 10

Fantasia
Far Out

CF Stinson

Price Group 3

Laredo
Rally

Price Group 4

Avant
Bistro
Checkmate
Cumulus
Moccasin
Naugasoft
Oxford
Rialto
Shantung
Simplicity
Symphony Classic
Whisper
Ziggy

Price Group 5

Chroma
Cirque
Dash
Geomet
Liquid
Matrix
Napa
Raffia
Southampton
Tendrill
Tessuto
Whitney

Price Group 6

Persuasion
In The Round w/Stakleen
Script
Snuggle
Sundance w/Stakleen

Price Group 7

Adirondack
Aspen
Banyan
Bali
Bari
Beeline
Block Party
Bower
Capreni
Carat
Catwalk
Couplet
Cozy
Crush
Dodgeball
Eli
Equinox
Folio
Hands On
Martini
Match Point
Mingle
Olympus
Over Under (By Patty Madden)
Petals
Pinstripe
Raquette
Rivera
Silverado W/Agion
Spandrel
Sterling W/Agion
Straight And Narrow
Tweed
Twist
Vibe
Wink W/Agion
Ybor

Price Group 8

Balance Beam
Cinnamon Blossom
Colden
Courtyard
Eclipse
Flutter
Geodesic
Hoopla
Labyrinth
Lucky Charm
Panache
Skyline
Sumatran Palm
Sunburst
Vintage
Wired

Price Group 9

Chi w/Agion
Daddy-O w/Agion
Good Fortune w/Agion
Haiku w/Agion
Jam Session w/Agion
Jump w/Agion
Now & Zen w/Agion
Tatami w/Agion
True Path w/Agion
Tuscan Lattice
Umbrian Stripe
Up Tempo w/Agion
Zen Garden w/Agion

Price Group 10

Double Time w/Agion
Glisten
In The Groove w/Agion
Mesa
Tuscan Garden
Tuscan Hills
Umbrian Landscape
Umbrian Rain
Umbrian Village
Verve w/Agion
Volterra-Hc

Designtex

Price Group 4

Bolzano
Kalanga
Metta
Parga
Rondine
Sorano
Spandau
Tarascon

Price Group 5

Alcazar
Annex
Avenza
Breena
Figure Eight
Florin
Inside Edge
Leafette
Lino
Pianta
Prism
Rumeli
Skylark

Price Group 6

Acacia
Agave
Alistair
Amuse
Anello
Arlington
Banda
Barnsbury
Bounce
Cassava
Chicory
Circolo
Copa
Dahlia
Dot To Dot
Downtown
Drawing Straws
Friendly Faux
Griglia
Gujarat
Hula Hoop
Kenaf
Lindos
Pueblo
Quintessence
Rice
Seed
Senna
Swing Set
Tartan
Terrain
Tumbleweed
Vinca

Price Group 7

Alemanya
Alkai
Amaranth
Basket Weaver
Bon Bon
Bossa Nova
Calm
Clovis
Coperta
Details
Dodge Ball
Dodge Ball Too
Faux Sure
Flux
Four Square
Inertia
Jungle Gym
Line Item
Mena
Minuet
Oscillate
Pasa Doble
Pattino
Prana
Samba
Samba Otra Vez
See Saw
Spiro
Sprocket
Tinos
Tupi
Uptown
Widget

Price Group 8

Boreas
Honor Plus
Maglia
Nexus
Southside

Price Group 10

Journey

Maharam

Maharam graded-in fabrics can only be used on Nurture brand products.

Price Group 5

Article
Ledger

Price Group 6

Candid
Chime
Flicker
Lariat
Petal
Quick
Reverie

Price Group 7

Align
Alloy
Assemblage
Beside
Bop
Chance
Corner
Crush
Current
Double Check
Kernel
Scuba
Trait
Wafer

Price Group 8

Akimbo
Box
Comment
Dart
Decode
Floret
Intertwine
Scout
Venn
Verse

Price Group 10

Chenille Cord

Momentum

Momentum graded-in fabrics can only be used on Nurture brand products.

Price Group 3

Cashmere

Price Group 4

Array
Crete
Fleck
Sublime
Tatami

Price Group 5

Bravo
Crypton Suede
Echo
Evoke
Foray
Jolt
Max
Smart Suede
Tact

Price Group 6

Brea
Clue
Crux
Icon
Kinetic
Lumiere
Paragon
Query
Radiate
Rio
Topanga
Tweed
Viva
Zoom

Price Group 7

Amenity
Bandwidth
Delmonico
Feliz
Frolic
Huntington
Hyphen
Jax
Jest
Locale
Maxim
Narration
Premise
Schmooze
Sway
Telegram

Price Group 8

Ardour
Calabasas
Catalogue
Charade
Inhabit
Pomona
Recollection
Soma

Price Group 9

Effloresce
Emanate

Ultrafabrics

Price Group 6

Ultraleather

Price Group 7

Promessa

Fabric Application Direction Guidelines

What is the issue?

Some textiles are simple and look the same regardless of how you apply them to a product. Other fabrics are patterned, textured, or have luster that will have a distinctly different appearance applied in a different direction on a chair. Because of these differences, and the fact that there are limits to how some fabrics can be applied to Nurture products, it is important to understand fabric application direction when ordering a product to avoid being disappointed.

Talking about direction

Fabrics come on rolls. The long yarns that run down the length of the roll are called the “warp” yarns. These yarns are used to define the direction you are viewing the fabric as it is applied to a chair. Fabric directionality is determined by how the fabric comes off the roll.



It is NOT determined by the way the pattern looks on the product. For example, the image below shows the fabric applied warped horizontal although the stripes appear vertical.

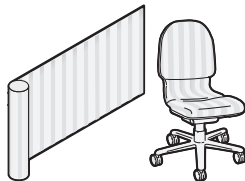

Terminology

Steelcase uses the terms warped horizontal and warped vertical. There are other terms within the industry that are used that have the same meaning:

- Warped horizontal is also referred to as:
 - railroaded or across roll
- Warped vertical is also referred to as:
 - woven way, down roll, or top out

Why is it important?

Dealers must specify fabric application direction when ordering COMs and Nurture Graded-In fabrics. We require the dealer to specify the direction because we do not know which way customers want to see a pattern on the furniture. Therefore, it is critical to know how the pattern is run on the roll to ensure that Nurture builds and ships each order to the customer’s expectation each and every time.



How do I know which way the fabric comes off the roll?

Most textile companies will swatch their fabrics in a warp vertical (woven way, down roll) direction. Some exceptions might be made to address patterns especially with stripes. Typically, when a fabric is swatched in a warp horizontal (railroad or across roll) direction, the direction is noted on the swatch card or fabric sample. If in doubt of a fabric direction, we encourage you to contact the textile vendor for clarification.

Vinyl

Vinyl generally only passes on Nurture product in a horizontal or across roll direction. This is due to physical properties of the material. If a vinyl is applied in the opposite direction, too much stretch in the material can compromise the overall aesthetics of the final upholstery. If a patterned vinyl is being specified and the vinyl must be run in a vertical direction, pre-approval must be arranged through Nurture. Nurture will consider the request and a decision will be made based on the specific vinyl and product combination. Contact Nurture’s Customer Care line.

Required Action Steps before Specifying

1. Verify by using Steelcase’s COM website that the fabric is approved on the product.
2. Verify the direction that the fabric can be applied. Occasionally a fabric is only approved in one direction.
3. Confirm with the customer how they want the fabric to look on the furniture.
4. Confirm using the swatch card or vendor’s website the direction the sample is shown.
5. Now you’re ready to place the order.