

# Ovals

AD3510-I

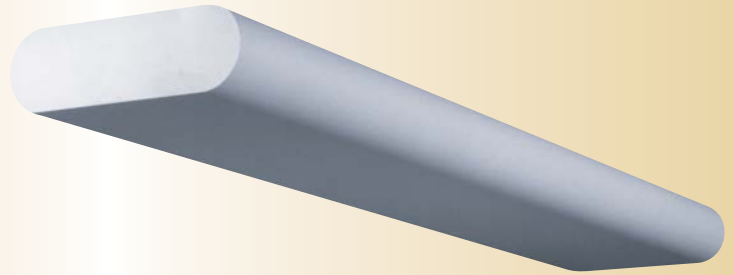
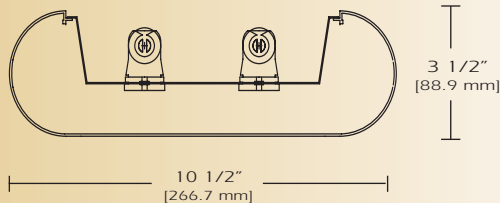

**TYPE** \_\_\_\_\_

**FEATURES**

The AD3510 oval aluminum luminaire is distinguished by its low profile and contemporary design. This high quality luminaire is suitable for most lighting systems and can be mounted to suit any project. The highly efficient design produces a uniform indirect light distribution. The AD3510 is ideal where style quality and performance applications apply.

**SPECIFICATIONS**

**Housing:** One piece heavy gauge extruded aluminum 6063T5 alloy welded construction forming a 3 1/2" x 10 1/2" oval profile. Finished end caps are welded to housing with no exposed hardware or knockouts.

**Reflector:** Die formed 20-gauge cold rolled steel minimum 90% reflectivity finished in high gloss baked white enamel.

**Electrical:** Ballast is electronic, high power factor, thermally protected class P, sound rated A, with less than 20% total harmonic distortion. The minimum number of ballasts will be used unless otherwise specified.

**Mounting:** Standard installation is an adjustable self-locking aircraft assembly 48" x 3/32" in diameter with 5" canopy. One 1/4 SJT straight 54" cord is supplied with each power feed. Standard pendants are available in 24" lengths. See Accessories for additional mounting.

**Finish:** Fixture housing and steel components are finished in baked white enamel applied over a five-stage pretreatment process.

**Lamps:** Fixtures are provided for use with two or three 32 watt T8 lamps or 54 watt T5 HO lamps. (Supplied by Others)

**Certification:** Luminaires are U. L. Listed, C. S. A. certified and are Union Made in the United States of America I.B.E.W.

**ORDERING GUIDE**

MODEL NO.	DIRECTION	LAMPS	MOUNTING	LENGTH	FINISH	VOLTAGE	OPTIONS
<b>AD3510</b>	<b>I</b>	<b>232T8</b> <b>332T8</b> <b>254T5 HO</b> <b>354T5 HO</b>	<b>AC</b> = Cable <b>PD</b> = Pendant	<b>4</b> = 4 ft <b>8</b> = 8 ft	<b>W</b> = White <b>CC</b> = Custom Color	<b>120v</b> <b>277v</b>	<b>See Options Below</b>
	<b>I</b> =Indirect	<b>O</b> =Other Specify	See Accessories	for other, please enter row length (eg. 48=48ft)			

Example: **AD-3510-I-232T8-AC-4-W-120V**

Example: AD-3510 indirect for two 32 watt T8 lamps including two 48 inch aircraft cables and power feed four foot fixture finished in baked white enamel 120v electronic ballast less than 20% total harmonic distortion.

**OPTIONS**

- E10=** Electronic ballast, high power factor, thermally protected class P, sound rated A, < 10% total harmonic distortion
- DIM=** Dimming Ballast
- EPC=** Emergency Battery Pack
- EMC=** Emergency Circuit
- TCW=** Two Circuit Wiring
- TDW=** Tandem Wiring
- OTH=** See Accessories for other options available

# Ovals

AD3510-1

LINEAR SECTIONS AND SUSPENSION LOCATION

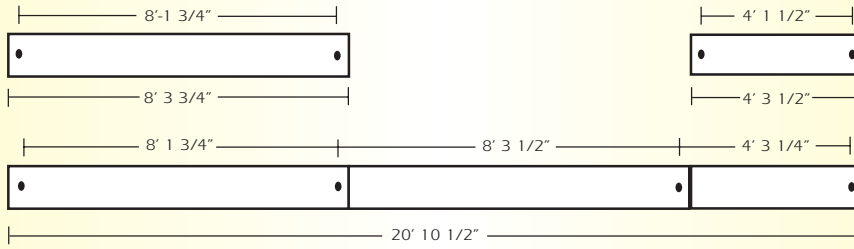

**CORNERS** Corners and fixture extensions are custom fabricated to precise dimensions. Please indicate the specific requirements on the layout

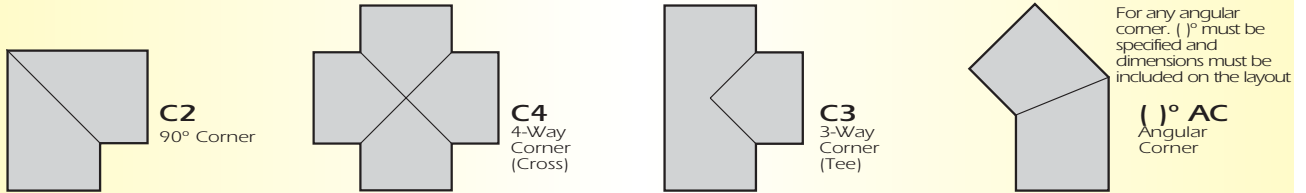

For any pattern, a layout must accompany the order.

INSTALLATION PREPARATION

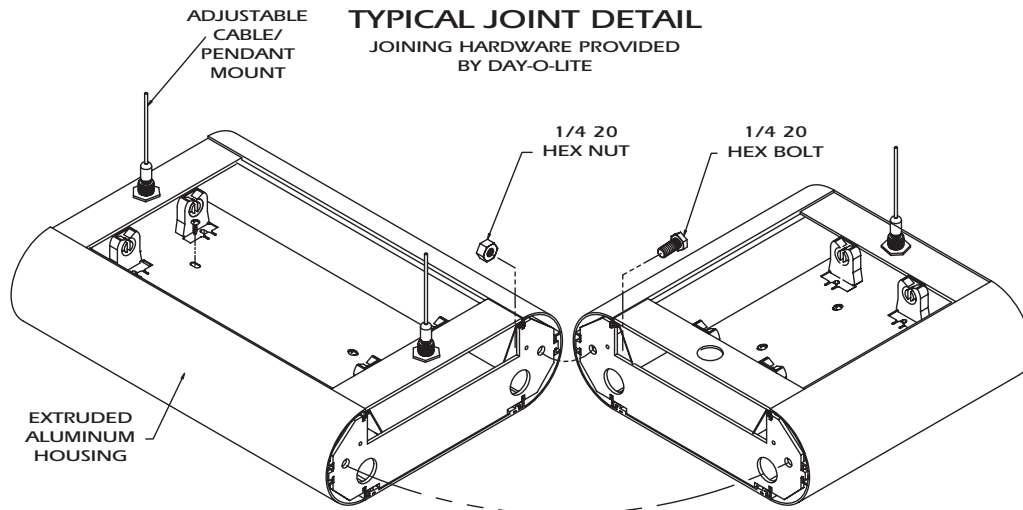

PHOTOMETRY

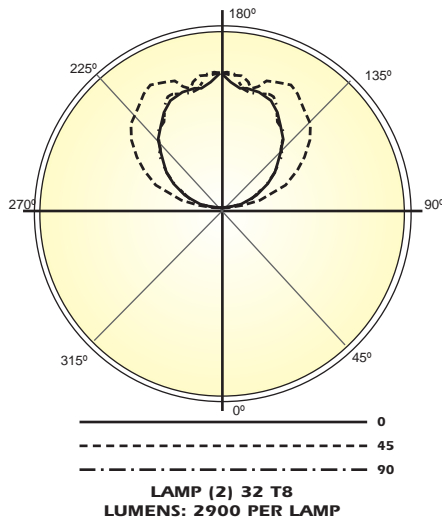

**Candela Distribution:**

Vert. Angle	0	22.5	45	67.5	90
90	8.93	17.8	26.4	28.1	24.0
95	76.9	127	140	143	139
100	179	268	325	338	342
105	286	416	490	526	532
110	385	521	618	680	703
115	487	619	766	811	852
120	599	723	865	960	969
125	698	810	960	1058	1095
130	779	872	1022	1169	1204
135	875	982	1117	1219	1285
140	981	1035	1185	1274	1319
145	1043	1111	1238	1327	1385
150	1141	1200	1305	1392	1444
155	1215	1245	1324	1387	1406
160	1236	1237	1296	1358	1376
165	1255	1339	1298	1348	1273
170	1242	1281	1312	1326	1358
175	1280	1363	1340	1299	1373
180	1386	1386	1386	1386	1386

**Optical Distribution:**  
100% Indirect

**Coefficients of Utilization - Zonal Cavity Method:**

pfc = 0.20

	.8	.7	.5	.3	.1	0												
pcc	.8	.7	.5	.3	.1	0												
pw	.7	.5	.3	.1	.5	.3	.1	0										
RCR																		
0	80	80	80	68	68	68	46	46	46	26	26	26	8	8	8	0		
1	73	69	66	64	62	59	57	55	40	39	38	23	22	22	7	7	7	0
2	66	60	56	52	56	52	48	45	35	33	31	20	19	18	6	6	6	0
3	60	53	47	43	51	45	41	37	31	28	26	18	16	15	5	5	5	0
4	55	47	40	36	47	40	35	31	27	24	22	16	14	13	5	4	4	0
5	50	41	35	30	42	35	30	26	24	21	18	14	12	11	4	4	3	0
6	46	37	30	26	39	31	26	22	21	18	16	12	10	9	4	3	3	0
7	42	33	27	22	36	28	23	19	19	16	14	11	9	8	3	3	2	0
8	39	29	23	19	33	25	20	17	17	14	12	10	8	7	3	2	2	0
9	36	26	21	17	31	23	18	15	16	12	10	9	7	6	3	2	2	0
10	33	24	18	15	28	21	16	13	14	11	9	8	6	5	2	2	1	0

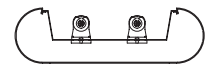

**Total Luminaire Optical Efficiency = 84.4%**