

Installation Instructions

Lippert® Soap/Shampoo Caddy

Please read all instructions
before installing products.

fig.1

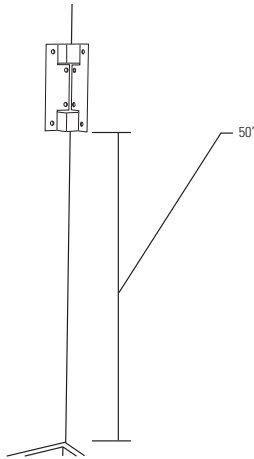

Location:

Install the soap/shampoo caddy in the corner of new or existing showers and tub surrounds over Lippert panels, ceramic tile or other solid surface materials.

Required tools:

Tape measure, screwdriver, $\frac{3}{8}$ " electric drill, $\frac{5}{32}$ " drill bit (wood studs) or $\frac{3}{8}$ " drill bit metal stud)

1. Determine the corner where the caddy will be installed. Position the hanger bracket about 50" from the bottom of the bracket to the floor of the tub or shower. See Figure 1.

fig.2

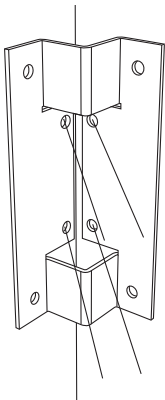

Wood Stud Installation

- a. Use the 4 inner holes closest to the inside corner of the bracket as guide. Drill $\frac{5}{32}$ " holes through the wall surface at a 45° angle. DO NOT drill into studs (screws are self tapping). See Figure 2.
- b. Drive the screws into the wood studs and securely attach the hanger bracket. See Figure 3.
- c. If there are no studs in the corner or the screws are not seated firmly into the wood, follow the metal stud installation procedure.

fig.3

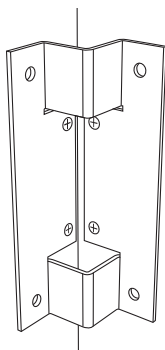

IPC.730/REV.1

Installation Instructions

Lippert® Soap/Shampoo Caddy

Please read all instructions
before installing products.

fig.4

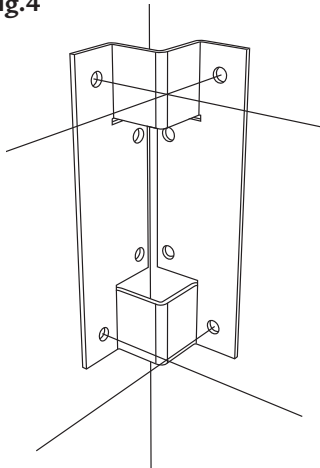

Metal stud installation

- Use the 4 outer holes as a guide. Drill 1/8" pilot holes at each hole location. See Figure 4.
- Remove the bracket and drill 3/8" holes through the wall at each pilot hole location.
- Install anchors and tighten until the small gasket breaks. See Figure 5.
- Remove screws from anchors, position bracket in place and re-install the screws, tighten until secure. Over tightening will cause threads to strip. See Figure 6.

fig.5

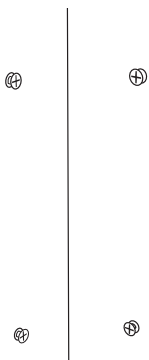
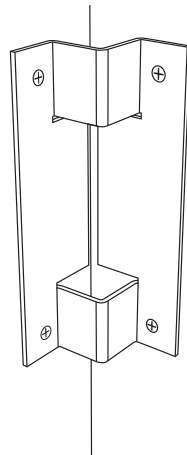

fig.6



- Apply a bead of adhesive sealant to each of the back edges. Keep adhesive 1 1/4" from the edges. See Figure 7.
- Slide the caddy into position over the bracket making certain that the hanger interlocks with the wall bracket. See Figure 8.
- Caulk the perimeter of the caddy and clean-up with denatured alcohol and paper towels. Allow caulk and adhesive to cure for 12 hours before using. See Figure 9.

fig.7

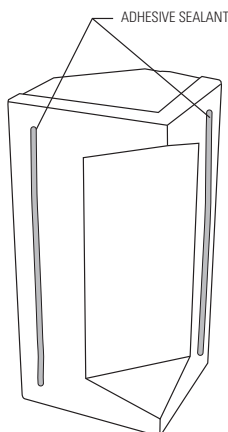

fig.8

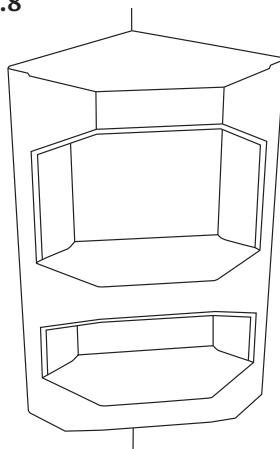

fig.9

