

Seating Specification Guide

What's New?

Spec News is available on in2.steelcase.com. Go to *Specification Guides-AdStock*, under *Sales Resources/Sales Marketing Materials*, and download the current release's Spec News.

Availability

Electronic price list updated with release 174.E (U.S.) and 143.E (Canada), dated February 20, 2012.

Transitional products in this specification guide are **maintained for existing customers only** and are likely to be phased out over time. These products are indicated with a **T**. Products that are scheduled to be culled are indicated with an **X**, followed by the last order entry date.

► For a list of all trademarks, refer to the last page of this specification guide.

This specification guide contains multiple Steelcase and Turnstone product lines

which are designed into one specification guide for your convenience. Note that each product may be subject to different pricing terms and conditions.



For Canadian Pricing

Calculate in the following order to avoid rounding errors:

- Multiply the base price and each option by 1.03.
- Round each to the nearest dollar.
- Add base and options for total list price.

Statement of Line 2

Basics of Ergonomic Seating 9

Basics of Adjustability 10

Additional Resources 15

Work Chairs

Leap 462 Series 17

Think 465 Series 39

Amia 482 Series 63

Reply 466 Series 79

Jersey Series 93

Leap 464 Series WorkLounge 105

Siento 499 Series 113

Cachet 487 Series 121

Protégé 433 Series 137

Criterion 453 Series 149

Drive 461 Series 167

Collaborative Seating

cobi 434 Series 177

i2i 416 Series 187

node 480 Series 195

Multi-Use Chairs

Reply 466 Series 79

Jersey Series 93

Cachet 487 Series 121

Protégé 433 Series 137

Ally 463 Series 203

Player 475 Series 209

Move 490 Series 221

Snodgrass 474 Series 237

Stackable Chairs

Max-Stacker 472 Series 243

Max-Stacker II 473 Series 253

Surface Materials 263

Turnstone 1.0 277

Resources 327

Statement of Line

Work Chairs

Leap 462 Series



Work Chairs with Upholstery on Back and Seat



Work Chairs with 3D Knit on Back and Upholstery on Seat

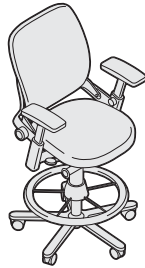

Stools with Upholstery on Back and Seat

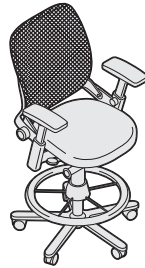

Stools with 3D Knit on Back and Upholstery on Seat



Plus Work Chairs with Upholstery on Back and Seat



Plus Work Chairs with 3D Knit on Back and Upholstery on Seat

Understanding
▶ Pages 18–23
Specifying
▶ Pages 24–26

Think 465 Series



Work Chairs with 3D Knit Back



Work Chairs with Standard or Sewn Upholstery



Stools with 3D Knit Back



Stools with Standard or Sewn Upholstery

Understanding
▶ Pages 40–45
Specifying
▶ Pages 46–61

Amia 482 Series



Work Chairs with Standard or Sewn Upholstery



Work Chairs with 3D Knit Back



Stools with Standard or Sewn Upholstery



Stools with 3D Knit Back

Understanding
▶ Pages 64–69
Specifying
▶ Page 70–78

Work Chairs, continued

Reply 466 Series



Work Chair with mesh back



Work Chair with standard or sewn upholstery

Understanding
 ▶ Pages 80–85
 Specifying
 ▶ Pages 86–87

Jersey Series



Work Chairs

Understanding
 ▶ Pages 94–99
 Specifying
 ▶ Pages 100–103

Leap 464 Series WorkLounge



Ribbon Back Frame WorkLounge

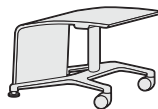

Ottoman

Understanding
 ▶ Pages 106–109
 Specifying
 ▶ Pages 110–111

Siento



High-Back Desk Chair with Fixed T-Arms



High-Back Desk Chair with Enclosed Arms



High-Back Desk Chair with Adjustable T-Arms



Mid-Back Desk Chair with Fixed T-Arms



Mid-Back Desk Chair with Enclosed Arms



Mid-Back Desk Chair with Adjustable T-Arms

Understanding
 ▶ Pages 114–115
 Specifying
 ▶ Pages 116–119

Work Chairs, continued

Cachet 487 Series



Swivel-Base
Work Chairs



Swivel-Base
Stools

Understanding
▶ Pages 122–125
Specifying
▶ Pages 126–135

Protégé 433 Series



Work Chairs
with arms



Work Chairs
without arms

Understanding
▶ Pages 138–141
Specifying
▶ Pages 142–148

Criterion 453 Series



High-Back
Work Chairs



Mid-Back
Work Chairs



High-Back
Stools



Mid-Back
Stools



Plus High-Back
Work Chairs

Understanding
▶ Pages 150–155
Specifying
▶ Pages 156–165

Drive 461 Series



Full-Back
Work Chairs

Understanding
▶ Pages 168–173
Specifying
▶ Pages 174–175

Collaborative Chairs

cobi 434 Series

Understanding
▶ Pages 178–181
Specifying
▶ Pages 182–185



Collaborative
Chair with Arms



Collaborative
Chair without Arms

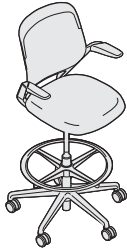

Collaborative
Stool with Arms

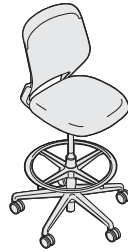

Collaborative
Stool without Arms

i2i 416 Series

Understanding
▶ Pages 188–191
Specifying
▶ Page 192



Collaborative
Chair



Collaborative
Chair with Tablet Arm

node 480 Series

Understanding
▶ Pages 196–199
Specifying
▶ Pages 200–202

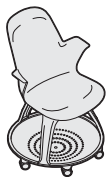

Collaborative
Chair

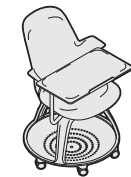

Collaborative Chair with
Personal Worksurface



Collaborative Chair
with Swivel-Base



Collaborative Stool
with Swivel-Base

Multi-Use Chairs

Reply Series

Understanding
 ▶ Pages 80–85
 Specifying
 ▶ Pages 86–91



Leg-Base Multi-Use Chair with Mesh Back with Arms



Leg-Base Multi-Use Chair with Mesh Back without Arms



Leg-Base Multi-Use Chair with Standard Upholstery with Arms



Leg-Base Multi-Use Chair with Standard Upholstery without Arms



Sled-Base Multi-Use Chair with Mesh Back with Arms



Sled-Base Multi-Use Chair with Mesh Back without Arms



Sled-Base Multi-Use Chair with Standard Upholstery with Arms



Sled-Base Multi-Use Chair with Standard Upholstery without Arms

*Chairs are available with casters.

Jersey Series

Understanding
 ▶ Pages 94–99
 Specifying
 ▶ Pages 100–103



Multi-Use Chair with Arms



Multi-Use Chair without Arms



Multi-Use Chair with Arms and with Casters

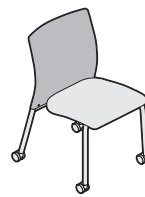

Multi-Use Chair without Arms and with Casters

Cachet 487 Series

Understanding
 ▶ Pages 122–125
 Specifying
 ▶ Pages 126–135



Leg-Base Multi-Use Chairs without Arms



Leg-Base Multi-Use Chairs with Flip-Up Arms

Protégé 433 Series

Understanding
 ▶ Pages 138–141
 Specifying
 ▶ Pages 142–148



Multi-Use Chairs with arms



Multi-Use Chairs without arms



Sled-Base Multi-Use Chairs

Multi-Use Chairs, continued

Ally 463 Series

Understanding
 ▶ Pages 204–207
 Specifying
 ▶ Page 208



Sled-Base
 Multi-Use Chair
 with Arms



Sled-Base
 Multi-Use Chair
 without Arms

Player 475 Series

Understanding
 ▶ Pages 210–213
 Specifying
 ▶ Pages 214–220



Leg-Base*
 Multi-Use Chairs
 without Arms



Leg-Base*
 Multi-Use Chairs
 with Arms



Sled-Base
 Multi-Use Chairs
 without Arms



Sled-Base
 Multi-Use Chairs
 with Arms



Stool with Arms



Stool
 without Arms

*Player leg-base chair models also stack.

Move 490 Series

Understanding
 ▶ Pages 222–225
 Specifying
 ▶ Pages 226–235



Multi-Use Chairs
 without Arms



Multi-Use Chairs
 without Arms
 with Casters



Multi-Use Chairs
 with Arms



Multi-Use Chairs
 with Arms and
 Casters



Stool
 without Arms



Stool
 without Arms
 with Casters



Stool
 with Arms



Stool with Arms
 with Casters

Multi-Use Chairs, continued

Snodgrass 474 Series



Multi-Use Chairs
with Open Back
with Arms



Multi-Use Chairs
with Open Back
Armless

- Understanding
- ▶ Pages 238–241
- Specifying
- ▶ Page 242

Stackable Chairs

Max-Stacker 472 Series



Stackable Chairs

- Understanding
- ▶ Pages 244–247
- Specifying
- ▶ Pages 248–251

Max-Stacker II 473 Series



Stackable Chairs

- Understanding
- ▶ Pages 254–257
- Specifying
- ▶ Pages 258–261

Basics of Ergonomic Seating

Proper ergonomic seating can help workers perform more efficiently and avoid muscle and eye strain.

Neck is straight or slightly forward.

Shoulders are relaxed so arms hang naturally.

Back has full contact with the backrest (sit all the way back in your chair).

Elbows and forearms can rest comfortably on the arms of your chair, or on worksurfaces that are used for writing, paperwork, and other tasks.

Lower back fits into curved lumbar support.

Tension is adjusted so backrest tilts easily, yet provides smooth, even support.

If worksurfaces and keyboard support are not height-adjustable, raise your chair's seat height to achieve the appropriate relationship to your tasks. If this leaves your feet dangling above the floor, use a Details footrest.

Call Details, 1.800.833.0411, or your Steelcase dealer, for additional information or price list.

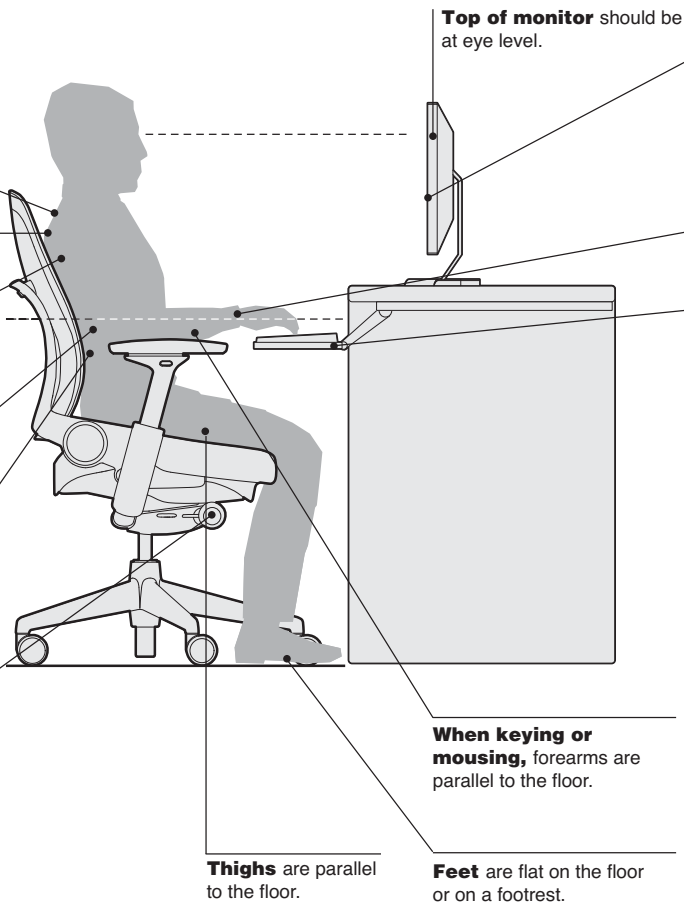

Top of monitor should be at eye level.

Screen is 20 to 30 inches from the eyes.

Screen is at eye level slightly lower and directly in front of worker so head is not turned.

Wrists should be straight when keying or mousing, not bent up or down.

Keyboard is at elbow height.

ANSI/BIFMA is the American National Standards Institute/Business and Institutional Furniture Manufacturer's Association. All Steelcase furniture meets or exceeds ANSI/BIFMA standards for structural quality. The following work chairs are tested and warranted for users 300 pounds and under: Leap, Siento, Criterion, Think, Amia, Drive, Jersey, and Protégé. Collaborative chairs tested and warranted for users 300 pounds and under are: cobii, i2i, and node. Multi-use chairs tested and warranted for users 300 pounds and under are: Move, Player, and Jersey. All Steelcase Seating products also follow the ergonomic guidelines established in BIFMA G1-2002.

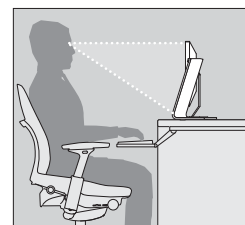

Keep frequently viewed objects, such as a VDT or source document, at or below the horizontal line of sight. Arrange display screen and documents to be equidistant from your eyes.

CAUTION

Do not stand on this product. Use only as intended.

Regularly inspect for damaged or broken parts and loose fasteners (screws, etc.). If any of these conditions exist, remove from service immediately. Repairs are to be made using only factory authorized parts and methods. Hard wheel casters must be used on carpeted surfaces only. Use on hard surfaces, including floor mats, will affect chair stability. For information on furniture which requires service, call Steelcase toll free at 1.888.783.3522.

Failure to follow these instructions could result in property damage or personal injury.

Basics of Adjustability

Steelcase chairs offer varying levels of adjustability to meet the needs of many types of users. Adjustable chairs may offer one or more of these features:

Mechanisms



Natural-glide feature causes the seat to slide forward as the user reclines, keeping the user within his or her vision and reach zone (462, 464).



Advanced swivel-tilt feature incorporates a no front-rise design that allows the seat to remain level even when the user leans back (453, 433).



Synchro-tilt feature means the chair back and seat are synchronized to move in a 2:1 ratio. When the user leans back, the seat rises only half as much, allowing the user's feet to remain flat on the floor (499, 461, 466, 482, Jersey).



Weight-activated feature allows for an amount of recline resistance that is directly proportional to the user's weight. The natural-glide feature keeps the user within vision and reach zone (434, 465).



Balanced Action Rocker (BAR) mechanism allows users to recline as the seat flexes. BAR relies on physics to let any user, regardless of posture, height, or weight, find the most comfortable position (487).



Dual-swivel feature allows the back and seat to swivel independently as well as together (416).



360°-swivel feature allows micromovement to stay engaged at fixed height (480).

Seat Adjustments



Pneumatic height adjustment allows the user to remain seated while adjusting the seat height by way of a control button or lever (all work chairs).



Passive seat edge angle allows front edge of seat to drop down while seat angle remains unchanged (462, 499, 465, 482).



Seat angle adjustment allows the user to change the angle of the seat to a forward position (453, 461, Jersey).



Seat depth adjustment allows the user to slide the seat forward or back (462, 453, 461, 465, 466, 482, Jersey).

Back Adjustments



Lumbar height affords additional lower back support. Grasp lumbar handles and slide up or down to adjust (462, 453, 461, 465, 466, 482).



Lower back firmness changes the amount of firmness user feels in lower back (462, 464).



Upper back tension feature provides an increasing amount of force that increases as the user reclines (462, 464).



Back tension adjustment allows the user to control the amount of resistance felt when leaning back in the chair (all chairs except 462, 499, 465, 466, 487).



Your Preference back control includes four settings—weight-activated, boosted, mid-stop, and upright—that allow for personal preference and work styles (465).



Headrest adjustment allows the user to support head and neck in upright or reclined posture (464, 465).



Variable back stop allows the user to lock the back upright or to preset the range of recline (462, 453, 464).



Upright back lock allows the user to lock the backrest in a full upright position or release it for full recline (499, 461, 433, 466, 482, Jersey).



Multi-position back lock allows users to recline the back to the desired angle and lock it in place (466).



Arm pivot adjustments allows the user to position arm rests as appropriate for the task being performed (462, 453, 461, 465, 466, 482, Jersey).

Other Features



Foot ring height can be adjusted up or down for user comfort. Cannot be done from seated position (434, 462, 453, 465, 482, 487).



Back height adjustment allows the user to raise or lower the chair back (453, 466).



Arm depth adjustment allows users to get closer to their work by chair arms moving out of the way (462, 465, 466, 482).

Arm Adjustments



Arm height adjustment allows the user to move the arms up or down independently (462, 453, 461, 465, 466, 482, Jersey).



Arm width adjustment allows the user to move the arms in or out independently (462, 453, 461, 465, 482, Jersey).

Basics of Adjustability, continued

Work Chair Adjustability Features						
	Leap 462 Series ▶ Page 17	Leap Plus 462 Series ▶ Page 17	Leap 464 Series WorkLounge ▶ Page 105	Siento 499 Series ▶ Page 113	Criterion 453 Series ▶ Page 149	Criterion Plus 453 Series ▶ Page 149
Mechanisms						
Natural glide	•	•	•			
Weight-activated						
Advanced swivel-tilt					•	•
Synchro-tilt				•		
Seat Adjustments						
Pneumatic height	•	•	•	•	•	•
Passive seat edge angle	•			•		
Seat angle		•			•	•
Seat depth	•	•			•	•*
Back Adjustments						
Lumbar height	•	•			•	•
Lower back firmness	•	•	•		•	
Upper back tension	•	•	•			
Back tension				•	•	•
Variable back stop	•	•	•		•	
Upright back lock	•	•	•			•
Multi-position back lock						
Back height					•	•
Arm Adjustments						
Arm height	•	•			•	•
Arm width	•	•			•	•
Arm pivot	•	•			•	
Arm depth	•	•				
Other Features						
Foot ring height (stool)	•				•	
Headrest	•		•	•*		

*See product understanding pages for additional details.

Work Chair Adjustability Features

	Think 465 Series ▶ Page 39	Amia 482 Series ▶ Page 63	Reply 466 Series ▶ Page 79	Drive 461 Series ▶ Page 167	Jersey Series ▶ Page 93
Mechanisms					
Natural glide					
Weight-activated	●				
Advanced swivel-tilt					
Synchro-tilt		●	●	●	●
Seat Adjustments					
Pneumatic height	●	●	●	●	●
Passive seat edge angle	●	●			
Seat angle				●	●
Seat depth	●	●	●	●	●
Back Adjustments					
Lumbar height	●	●	●*	●	
Lower back firmness					
Upper back tension					
Back tension	●	●	●	●	●
Variable back stop	●				
Upright back lock	●	●	●	●	●
Multi-position back lock			●		
Back height			●*		
Arm Adjustments					
Arm height	●	●	●	●	●
Arm width	●	●		●	●
Arm pivot	●	●	●	●	●
Arm depth	●	●	●		
Other Features					
Foot ring height (stool)	●	●			
Headrest	●				

*See product understanding pages for additional details.

Collaborative/Multi-Use Adjustability Features					
	Protégé 433 Series ▶ Page 137	Cachet 487 Series ▶ Page 121	cobi 434 Series ▶ Page 177	i2i 416 Series ▶ Page 187	node 480 Series ▶ Page 195
Mechanisms					
Advanced swivel-tilt	•				
Balanced Action Rocker (BAR)		•			
Weight-activated			•		
Dual-swivel				•	
360° swivel					•
Seat Adjustments					
Pneumatic height	•	•	•		
Back Adjustments					
Back tension	•				
Upright back lock	•				
Self adjusting		•	•	•	

Steelcase seating is supported with an array of informational materials, tools, and software to help you plan efficiently.

Product brochures and planning tools can be ordered through your Steelcase area office by calling 1.800.784.0358 or through the Steelcase Marketing Communications Web site at in2.steelcase.com.

Printed Materials

Surface Materials Reference Manual

This publication provides:

- An explanation of the surface materials and their categories
- "Available on" matrices
- Vertical surface fabric and seating upholstery selection listing
- Technical data for surface materials
- Surface material care and cleaning instructions

Planning Tools

Quick Ship and Delivery Guide

This handbook describes all Steelcase, Turnstone, Details, and Coalesse products that are available for Rapid2 (ships in 2 days), Rapid5 (ships in 5-7 days), Express12 (12-day delivery), or Coalesse Rapid10 (ships in 10 days).

Computer Tools



Product Info

Electronic versions of this and many other specification guides in Acrobat PDF (Portable Document Format) allow you to scan, search, and print any page on virtually any computer. You can access these files at the Steelcase.com Web site or My Sales Online at in2.Steelcase.com.

Electronic Catalog

Accurate sales quotations and purchase orders for Steelcase products are created with specification software that uses Steelcase Electronic Catalog data. Use the data to specify and price style numbers and options for every Steelcase product. The data is updated bimonthly by Steelcase and provided to software programs including: the Hedberg Business System, SmartTools – Steelcase's design and specification software (for more information on SmartTools, please email SmartTools@steelcase.com), the ProjectMatrix Project-Symbols libraries, as well as 20-20 CAP Studio.

Furniture Symbol Graphic Data

Steelcase creates 2D and 3D furniture symbols (with attributes) for planning and initially specifying Steelcase products. This data is incorporated into several add-on software packages that work in either a Microstation or an AutoCAD drafting environment.

More Information

For more information about these and other software tools to help you plan effective work environments, email fsi@steelcase.com.

Seating Product Training

Basic training for Steelcase seating products is available as part of the Building Product Muscle (BPM) curriculum on the Steelcase University Web site at in2.steelcase.com.

The course and accompanying tool, called "isit", provide an overview of the most popular Steelcase Inc. seating products, their positioning, statement of line, features and advantages, key competitors, pricing, application, spec tips, and photos. It also covers the basics of the consultative approach to selling seating and provides printable job aids for ongoing performance support.

Support

Steelcase Capabilities

Steelcase products are distributed, installed, and serviced through a network of more than 600 dealers worldwide. Steelcase is also represented with offices and corporate showrooms in 26 U.S. cities, 4 Canadian cities, and in France, Germany, Great Britain, and Japan. Every Steelcase product meets our exceptionally high standards of quality and durability and comes with the Steelcase assurance of excellence in service.

For assistance,

please call your local dealer, the Steelcase Solutions Resource Team, or the Steelcase Solutions Fulfillment Team at 1.888.STEELCASE (1.888.783.3522) or send an email to lineone@steelcase.com.

Call the Steelcase Solutions Resource Team prior to placing an order, when working on a bid, or when you need information about product applications and specifications.

Call the Steelcase Solutions Fulfillment Team if you have submitted an order to Steelcase and you need to speak to your Solutions Fulfillment Team Representative about the order. Also call if you have any post-shipment quality or warranty concerns or service parts questions.

Outside the U.S.A., Canada, Mexico, Puerto Rico, and the U.S. Virgin Islands, call 1.616.247.2500.

For information about Steelcase, the name of your nearest Steelcase dealer, or for product literature, call 1.800.333.9939 or visit our Web site: www.steelcase.com.



Understanding and Specifying Leap 462 Series Work Chairs

Work Chairs

Highly adjustable task seating offers maximum personalization for people who sit most of the day performing repetitive tasks. By making a series of simple adjustments, you can customize the chair to your body, preferences, and tasks. These chairs provide continuous, stable, task-oriented comfort, and can be quickly adjusted to support you in upright, forward, and reclining work postures.

- Leap 462 Series
- Leap 464 Series WorkLounge
- Criterion 453 Series
- Think 465 Series
- Amia 482 Series
- Reply 466 Series
- Drive 461 Series
- Jersey Series

Adjustability Features

- See page 12 for a comparison to other chairs.

	Leap 462 Series	Leap Plus
--	--------------------------------	----------------------

Mechanisms

Natural glide	●	●
---------------	---	---

Seat Adjustments

Pneumatic height	●	●
------------------	---	---

Passive seat edge angle	●	
-------------------------	---	--

Seat depth	●	●
------------	---	---

Back Adjustments

Lumbar height	●	●
---------------	---	---

Lower back firmness	●	●
---------------------	---	---

Upper back tension	●	●
--------------------	---	---

Variable back stop	●	●
--------------------	---	---

Arm Adjustments

Arm height	●	●
------------	---	---

Arm width	●	●
-----------	---	---

Arm pivot	●	●
-----------	---	---

Arm depth	●	●
-----------	---	---

Other Features

Foot ring height (stool)	●	
--------------------------	---	--

Product Details

Leap 462 Series	18
Leap Upholstery	21
Dimensions	22

Specifying

Value Package

Work Chair	24
------------	-----------

Work Chairs

Upholstery on Back and Seat	26
3D Knit on Back with Upholstery on Seat	28

Stools

Upholstery on Back and Seat	30
3D Knit on Back with Upholstery on Seat	32

Plus Work Chairs

Plus Work Chair with Upholstery on Back and Seat	34
Plus Work Chair with 3D Knit on Back and Upholstery on Seat	36

Leap 462 Series

Leap is a high performance chair for customers who place the highest value on ergonomics, health, and productivity.

Outer back and outer seat are plastic.

LiveBack moves with the shape of the user's spine as sitting positions change.

Lumbar height adjusts 5" to provide additional lower back support. It is standard on all chairs, but may be omitted.

Arm height can adjust independently within a 4" range to help relieve upper back and shoulder fatigue.

Seat depth adjusts within a 3" range to accommodate users of varying leg lengths. Seat depth is standard on all models.

Five-arm base is available in plastic or polished aluminum.

Casters have hard, dual-wheels that roll smoothly on carpets. They are 2½" for increased mobility. Soft, dual-wheel casters are available for use on hard floors or chair mats. Stools are standard with 2" hard casters. Soft casters are available as an option.

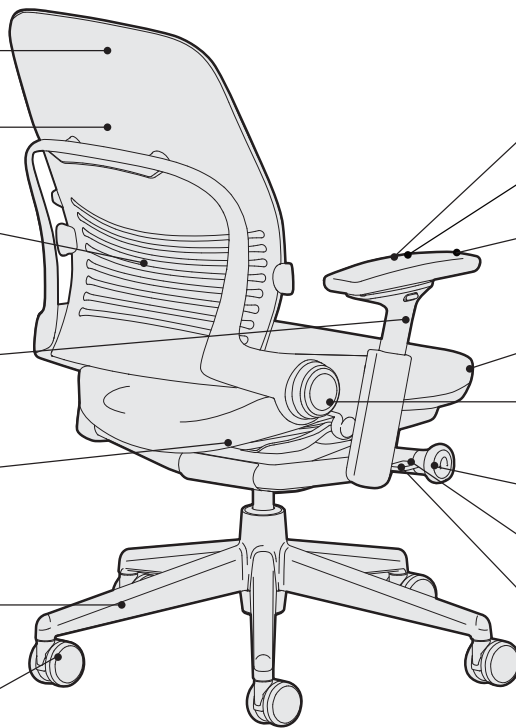

Arm depth can retract 3" to allow user to get closer to worksurface and into tight corners.

Arm width can adjust 4½" overall to provide forearm support.

Arm caps can pivot 30° in and out to accommodate individual user preferences.

Passive seat edge angle allows the front edge of the seat to flex 1½" to relieve pressure under the user's thighs.

Lower back firmness changes the amount of firmness user feels in lower back. Requires only two complete turns.

Upper back force requires only five complete turns and accommodates a broader range of users by allowing user to change the rate of increase in force as the user reclines.

Variable back stop with five positions is standard.

Seat height adjusts within a 5" range with a pneumatic adjustment mechanism. A 7" range is available as an option. Stools have an 8" range.

Product Details

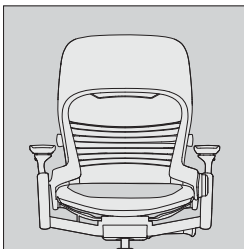

Parallel slats in back shell provide extensive flexibility to allow back to conform to individual users.

Leap Plus offers the benefits and functionality of the standard Leap chair, including LiveBack Technology, to users weighing up to 500 pounds.

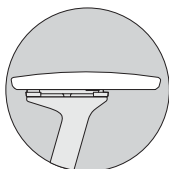

Rectilinear arms with soft caps are standard.

Models are standard with adjustable seats that include seat depth and passive seat edge angle.

Adjustability instructions are included with every chair. Fully adjustable arm models include instructions under the arm cap. Instructions can also be found at steelcase.com

Controls under the seat include tactile braille designators.

Adjustment Features

Seat Adjustments

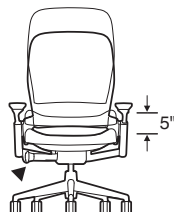

Seat height adjusts pneumatically. To lower, hold handle up while seated. To raise, hold handle up and keep your weight off the chair. Range of adjustability is 5", from 15½"H to 20½"H, and is standard on work chairs. A 7" range of adjustability (17"H to 24"H) is available as an option. Stools are standard with an 8" range of adjustability (22"H to 30"H).



Seat edge flexes 1½", relieving pressure under the user's thighs. This feature is standard on all work chairs and stools.

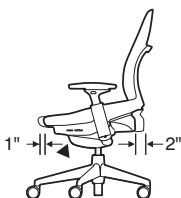

Seat depth adjusts 3" (15¾"-18¾") by pulling handle up. Slide seat forward or back to accommodate various leg lengths. Release handle to lock. This feature is standard on work chairs and stools. Seat depth adjustment range for Leap Plus is 2" (16¾"-18¾").

Back Adjustments

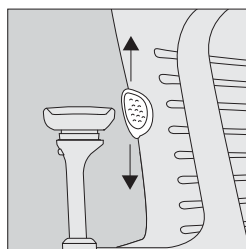

Lumbar height adjusts 5" (5¼" to 10¼" from seat, 6½" to 11½" on Plus chairs) by grabbing exposed tabs and sliding the lumbar support up or down. This feature is standard on work chairs and stools, but may be omitted.



Lower back firmness adjusts by turning knob two complete turns. Forward increases firmness. Backward decreases firmness. This feature is standard on work chairs and stools.

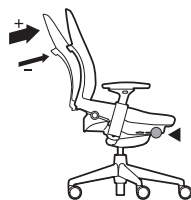

Upper back force adjusts by turning knob five complete turns. Turn knob forward to increase rate of tension; backward to decrease. This feature is standard on work chairs and stools.

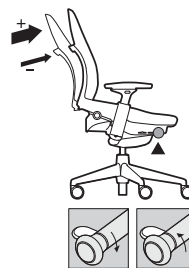

Variable back stop. Rotate handle up or down to set recline angle. Lean back to desired back angle. Five stops are available. This feature is standard on work chairs and stools. *Tip: To stop in upright position, remove weight from back and rotate lever up.*

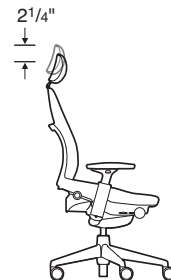

Headrest (option) adjusts 2¼" vertically and adds 6¾" to 9" to the overall height. Plastic shell on the headrest is available in black only. Upholstery is available to match the seat material or black vinyl only. Headrest is not available on stools, Plus models, or when the fire code option (FCS) is selected.

Arm Adjustments

Rectilinear height-, width-, pivot-, and depth-adjustable arms come standard on all arm models of chairs and stools.

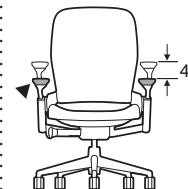

Arm height adjusts independently within a range of 4" (7"-11" from the seat, 7¼"-11¼" on Plus models). Push button on outside and under arm cap in while moving arms up or down. Releasing buttons locks arms in position.

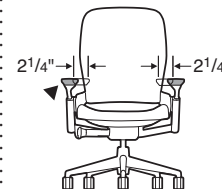

Arm width adjusts 2¼" each independently on chairs with this option. Grasp arm and move in or out.

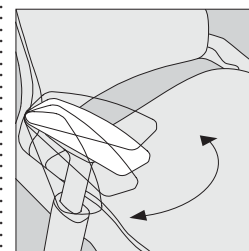

Arms pivot in and out 30° independently on models with adjustable-width arms. Grasp arm and push front to left or right.

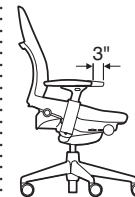

Arm depth adjusts approximately 3" to enable user to get closer to worksurface.

Other Features

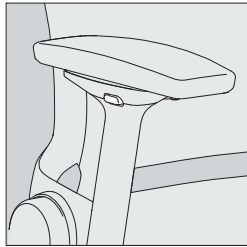

Height-only adjustable arm is also available and adjusts 4".



Armless models are also available.

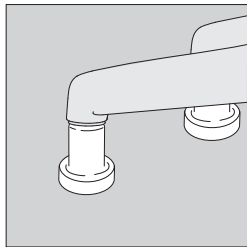

Glides are available as an option, except on chairs with polished aluminum package. Glides ship with chair or stool for field installation and maintain same height as casters.

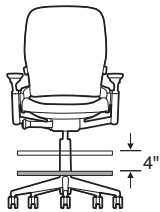

Foot ring height on stools adjusts by first lifting ring and rotating it counter-clockwise to unlock. Then raise or lower ring up to 4" to desired position before rotating it clockwise to lock.

Soft-wheel casters for hard floors are available for specific applications.

Surface Materials

▶ See surface materials on page 264 for specific availability or refer to the *Surface Materials Reference Manual* for further information.

Upholstery

- Fabric
- Fabric with soil-retardant treatment (option)
- 3D Knit (back only)
- Leather
- Elmosoft leather
- Vinyl
- COM
- COV

Hard components

(ribbon back frame, outer back, arm retainer, and base)

- 6205 Black
- 6249 Platinum
- 6259 Midnight

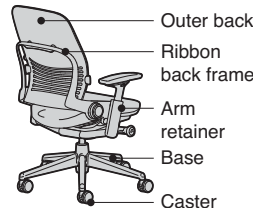

Polished aluminum package is available on black chairs only. Polished aluminum is applied to ribbon back frame, base, and casters. Stools, armless chairs, and Plus models are not available with this package.

Arms

- Black only

Column and foot ring on stools

- 7207 Black only

All Steelcase seating with standard upholstery fabrics complies with requirements of the State of California Technical Bulletin 117. All standard seating is labeled to be in compliance with California 117.

Programs & Services

▶ See the *Surface Materials Reference Manual* for further detail about programs and services offered for seating.

The Customer's Own Material (COM) Program

offers the opportunity for customers to select fabrics that are not offered through the standard Steelcase surface materials program for use on Steelcase products. Through the COM program, Steelcase will test your materials for application on Steelcase products. Once approved, you can place your order. Steelcase will facilitate the entire ordering process and give you a production schedule. Steelcase will order the COM fabric directly from the textile manufacturer. For up-to-date information regarding fabric test results for all COM fabrics and details regarding yardage requirements for most Seating lines, visit the COM Web site. To locate the COM Web site:

- Visit www.steelcase.com

Soil retardants are treatments that provide long-term soil and stain resistance to a fabric without affecting the shade or the integrity of the fabric. The following Steelcase Textiles are available pre-treated with soil retardant. (You do not need to select the soil-retardant option for these fabrics and incur the upcharge.)

- Jacks
- Link
- Spyder

For information on soil retardant fabrics on Select Surfaces, please refer to the *Surface Materials Reference Manual*.

Soil-retardant treatment is available on all other seating fabrics at an additional upcharge per seating unit. To order this option, please select "Soil-Retardant Treatment" under "Optional Accessories."

For soil-retardant treatment on COMs, please select "Soil-Retardant Treatment" under "Optional Accessories." Minimums or additional yardage may be required. Please contact the vendor directly for specific information.

Extended lead times may be necessary for this service.

Contact your Steelcase Solutions Fulfillment Team Representative at 1.888.STEELCASE (1.888.783.3522) or send an email to lineone@steelcase.com.

Fire Codes

▶ See pages 270–271 for upholstery fabrics available for use with FCS modification.

Steelcase offers Fire Code Seating modification (FCS) on nearly all seating models. The most rigorous fire codes in the nation have been developed in California, and the Steelcase FCS modification is designed to meet those codes. Fire Code Seating (FCS) indicates that a product is constructed to meet the strict fire code requirements of high public occupancy areas such as theaters, meeting rooms, and lobbies. The FCS standards will meet both the State of California Home Furnishing Technical Bulletin 133 (Cal TB 133) and Boston Fire Code (BFC). Boston adopted the California Home Furnishing Technical Bulletin TB 133 test standard in 1992.

Local codes may have special requirements for upholstery.

Resources

Printed Materials

- ▶ Leap Brochure (05-0002313)
- ▶ Leap White Paper Packets (S11019)
- ▶ Work Effectiveness Study White Papers available on in2.steelcase.com
- ▶ Leap Quick Reference Pocket Card (08-0000117)
- ▶ Leap User Guide available on www.steelcase.com
- ▶ Innovation Seating Brochure (04-0011870)
- ▶ Humantech Case Study (03-0003715)
- ▶ Leap Productivity and Health Impact Study (03-0003716)
- ▶ Model sales conversation available on in2.steelcase.com
- ▶ Why Leap (S11014)
- ▶ Leap Development Story (S11124)
- ▶ Alive Seating Booklet (07-0006467)
- ▶ Leap Alive Seating Print Ad (06-0001566)
- ▶ A New Day (03-0003362)

Audiovisual Materials

- ▶ Interactive User Guide available on www.steelcase.com
- ▶ Leap mini-site (download) available on in2.steelcase.com or viewable on www.steelcase.com.
- ▶ Alive seating video (download) available on in2.steelcase.com (sales tools > seating).

Dimensions

▶ Page 22

What Is It?

Fabric, leather, or vinyl-covered back and seat, 3D Knit back.

Fabric

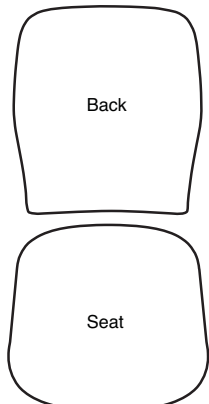

Leather, Vinyl, and Select Fabrics

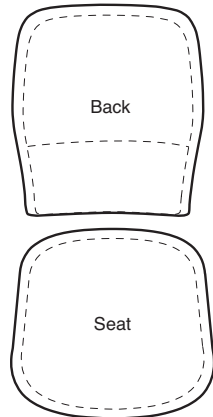

3D Knit Back

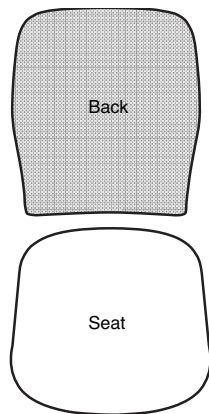

Stitched seams are included on the back cushion and seat cushion of the following:

- Leather
- Customer's Own Leather (COL)
- Vinyl
- Customer's Own Vinyl (COV)
- Select Customer's Own Material (COM)

Pattern alignment at the lumbar seam cannot be guaranteed.

3D Knit back is made up of three layers: the 3D Knit, a solid fabric that matches the 3D Knit color, and the polyester cushion that provides exceptional comfort. The seat on these models can be specified with cogent connect fabric colors to match the 3D Knit color, or in any other material.

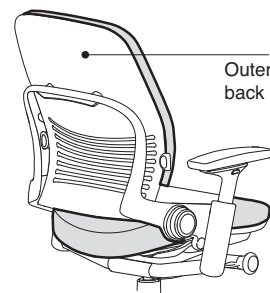

Plastic outer back is fully exposed.

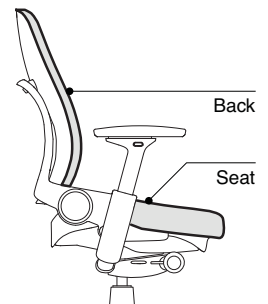

Seat and back cushions can be removed and replaced if damaged.

Dimensions

Leap 462 Series

• Features	• Overall Depth	Width	Height	• Seat Depth	• Functional Seat Depth	• Seat Width	• Seat Height from Floor	• Back Width	• Back Height from Seat
------------	-----------------	-------	--------	--------------	-------------------------	--------------	--------------------------	--------------	-------------------------

Leap 462 Series

Work Chairs

Adjustable Seat Depth	21 ³ / ₄ " to 24 ³ / ₄ "	27"	38 ¹ / ₂ " to 43 ¹ / ₂ "	19"	15 ³ / ₄ " to 18 ³ / ₄ "	19 ¹ / ₄ "	15 ¹ / ₂ " to 20 ¹ / ₂ "	18"	25"
-----------------------	--	-----	--	-----	--	----------------------------------	--	-----	-----

Stools

Adjustable Seat Depth	21 ³ / ₄ " to 24 ³ / ₄ "	27"	46" to 54"	19"	15 ³ / ₄ " to 18 ³ / ₄ "	19 ¹ / ₄ "	22" to 30"	18"	25"
-----------------------	--	-----	------------	-----	--	----------------------------------	------------	-----	-----

Plus Work Chairs

Adjustable Seat Depth	21 ³ / ₄ " to 24 ³ / ₄ "	31 ³ / ₄ "	38 ³ / ₄ " to 42 ¹ / ₂ "	20 ¹ / ₂ "	16 ³ / ₄ " to 18 ³ / ₄ "	22 ³ / ₄ "	15 ¹ / ₂ " to 19 ¹ / ₂ "	20"	24 ¹ / ₂ "
-----------------------	--	----------------------------------	--	----------------------------------	--	----------------------------------	--	-----	----------------------------------

Dimensions were measured with BIFMA CMD (chair-measuring device).

****Arm width adjustment** is 15"–20" (19³/₄"–24³/₄" for Leap Plus). Arm pivot adjustment adds 2¹/₄" to the minimum width providing a total of 12³/₄"–20" of width between the arms.

• Back Lumbar Height	• Lumbar Flex Zone	• Width Between Arms	• Arm to Floor	• Arm Height from Seat	• Arm Cap Pivot Range	• Seat Pan Angle	• Angle Between Seat and Back	• Headrest Height Adjustment Range
Work Chairs								
5 1/4" to 10 1/4"	5 1/4" to 10 1/4"	12 3/4" to 20"***	22" to 31"	7" to 11"	30°	-1° to 3°	96° to 120°	2 1/4"
Stools								
5 1/4" to 10 1/4"	5 1/4" to 10 1/4"	12 3/4" to 20"***	29" to 41"	7" to 11"	30°	-1° to 3°	96° to 120°	N.A.
Plus Work Chairs								
6 1/2" to 11 1/2"	11 1/4" to 16 1/4"	17 1/2" to 24 3/4"***	22" to 30"	7 1/4" to 11 1/4"	30"	0° to 4°	97° to 114°	N.A.

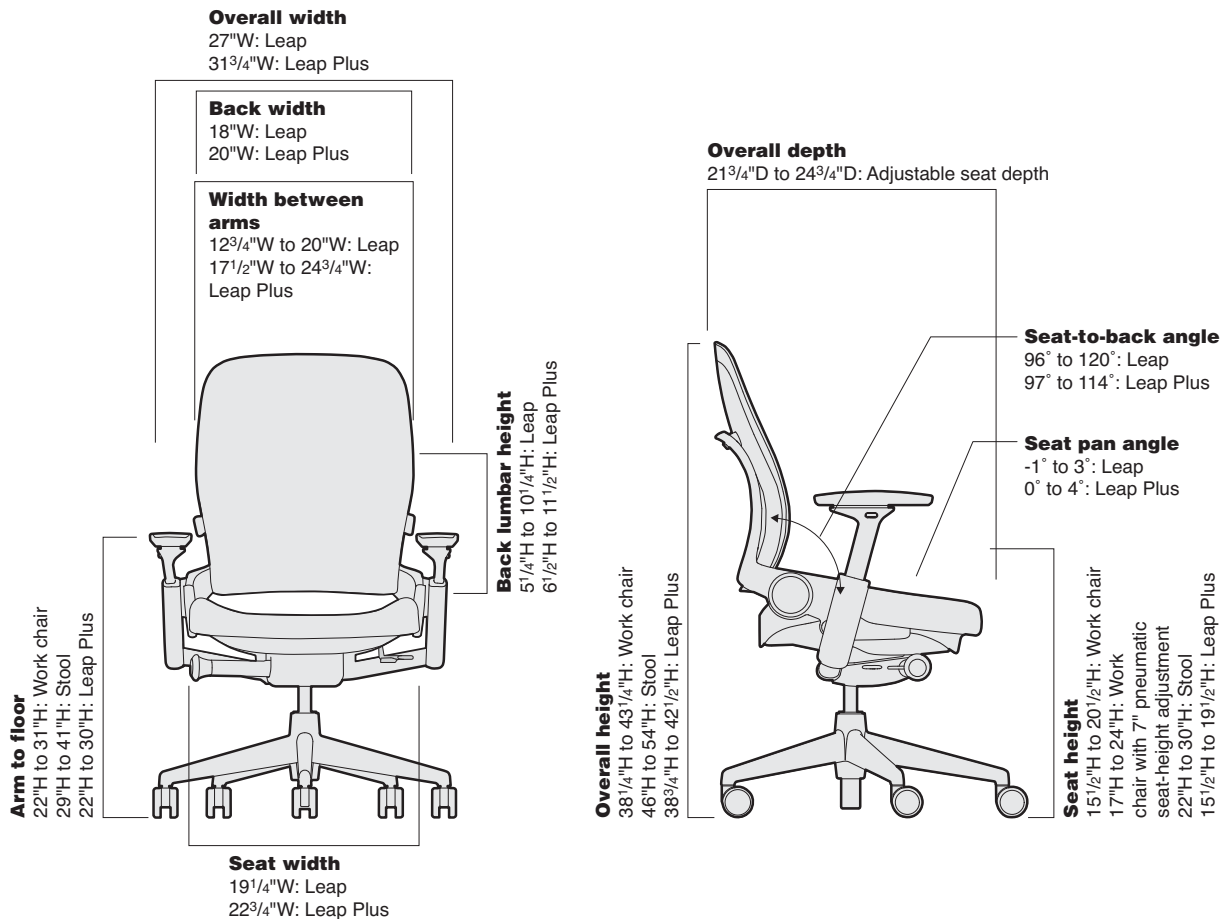

Leap 462 Series Value Package Work Chair



Tip: Leap value package work chair offers Leap chair features at a lower price than when selected individually.

Standard Includes	Required to Specify
<ul style="list-style-type: none"> • Upper back force • 5" pneumatic seat-height adjustment • Variable back stop • Lower back firmness • Rectilinear independent height-, width-, pivot- and depth-adjustable arms: black plastic • 3" seat depth adjustment • Passive seat edge angle • Adjustable lumbar • Frame, seat shell, outer back, and five-arm base: black plastic only • Standard upholstery design: Buzz2 fabric only • 2½"-diameter, hard-composition, dual-wheel casters: black 	<ul style="list-style-type: none"> 1 Style number 2 Buzz2 fabric color number for upholstery on seat and back ▶ See <i>Surface Materials</i>, page 264.

Specification Information	
• Style Number	• U.S. Price
LEAPV2	\$1325

▶ Detailed dimensions, page 22



For Canadian Pricing
 Multiply U.S. Price by the Canadian price factor.
 ▶ See page 1 for details.

Leap 462 Series Work Chairs

Upholstery on Back and Seat



	Standard Includes	Required to Specify
<p>▶ Need help? Product details, page 18</p>	<ul style="list-style-type: none"> • Upper back force • 5" pneumatic seat-height adjustment • Variable back stop • Lower back firmness • Rectilinear independent height-, width-, pivot-, and depth-adjustable arms and soft arm caps, if selected: black plastic • Frame, seat shell, outer back, and five-arm base: plastic • 3" seat depth adjustment • Passive seat edge angle • Adjustable lumbar • Standard upholstery design: fabric price group 1 • 2 1/2"-diameter, hard-composition, dual-wheel casters: black 	<ol style="list-style-type: none"> 1 Style number 2 Plastic color for frame, seat shell, outer back, and base 3 Fabric color number for upholstery on seat and back 4 Options, if selected (see below) <p>▶ See <i>Surface Materials</i>, page 264.</p>

	Options	U.S. Price	Required to Specify
Surface Materials	<p>Upholstery</p> <ul style="list-style-type: none"> • Fabric price group 1 • Fabric price group 2 • Fabric price group 3 • Fabric price group 4 • Fabric price group 5 • Fabric price group 6 • Fabric price group 7 • Fabric price group 8 • Fabric price group 9 • Fabric price group 10 • Customer's Own Material (COM) <p>• Customer's Own Material (COM-Sewn)</p> <ul style="list-style-type: none"> • Steelcase leather upholstery • Elmosoft leather upholstery <ul style="list-style-type: none"> • Steelcase vinyl • Customer's Own Leather (COL) • Customer's Own Vinyl (COV) <p>• Fire Code Seating (FCS)</p> <ul style="list-style-type: none"> • Soil-retardant treatment applied to upholstery fabric <p>Polished aluminum package</p> <ul style="list-style-type: none"> • Polished aluminum package on chairs with arms and 6205 Black frame finish <p>Platinum</p> <ul style="list-style-type: none"> • On frame, base, arm retainer, and outer back 	<p>No cost</p> <p>+\$ 22</p> <p>+\$ 43</p> <p>+\$ 59</p> <p>+\$ 75</p> <p>+\$ 92</p> <p>+\$107</p> <p>+\$134</p> <p>+\$166</p> <p>+\$187</p> <p>No cost</p> <p>+\$ 68</p> <p>+\$623</p> <p>+\$720</p> <p>+\$ 68</p> <p>+\$311</p> <p>+\$ 68</p> <p>+\$ 64</p> <p>+\$ 21</p> <p>+\$422</p> <p>+\$ 78</p> <p>-\$ 82</p> <p>-\$254</p> <p>+\$ 52</p> <p>+\$208</p> <p>-\$ 52</p>	<p>Specify fabric color number.</p> <p>Specify fabric color number.</p> <p>Specify fabric color number.</p> <p>Specify fabric color number.</p> <p>Specify fabric color number.</p> <p>Specify fabric color number.</p> <p>Specify fabric color number.</p> <p>Specify fabric color number.</p> <p>Specify fabric color number.</p> <p>▶ See <i>Surface Materials Reference Manual</i> to specify.</p> <p>Add suffix S to the style number and specify fabric number.</p> <p>Add suffix S to the style number and specify leather color number.</p> <p>Add suffix S to the style number and specify Elmosoft leather color number.</p> <p>Add suffix S to the style number and specify vinyl color number.</p> <p>Add suffix S to the style number and specify leather color number.</p> <p>Add suffix S to the style number and specify vinyl color number.</p> <p>Add suffix F to the style number.</p> <p>Specify <i>with soil-retardant treatment</i>.</p> <p>Add suffix C to the style number.</p> <p>Specify <i>with 6249 Platinum</i>.</p> <p>Specify <i>with height-adjustable arms</i>.</p> <p>Specify <i>without arms</i>.</p> <p>Specify <i>with 7" pneumatic seat-height adjustment</i>.</p> <p>Specify <i>with headrest</i>.</p> <p>Specify <i>without lumbar</i>.</p>
Arms	<ul style="list-style-type: none"> • Height-adjustable arms, soft arm caps • Armless 	<p>-\$ 82</p> <p>-\$254</p>	<p>Specify <i>with height-adjustable arms</i>.</p> <p>Specify <i>without arms</i>.</p>
Seat Height	<ul style="list-style-type: none"> • 7" pneumatic seat-height adjustment 	<p>+\$ 52</p>	<p>Specify <i>with 7" pneumatic seat-height adjustment</i>.</p>
Headrest	<ul style="list-style-type: none"> • Headrest 	<p>+\$208</p>	<p>Specify <i>with headrest</i>.</p>
Lumbar	<ul style="list-style-type: none"> • Without lumbar 	<p>-\$ 52</p>	<p>Specify <i>without lumbar</i>.</p>

▶ Options, continued on next page

Tip: Select COMs require sewn application with an additional upcharge. Specify with an **S** suffix.

Tip: Always add suffixes in alphabetical order when specifying options to Leap seating.

Tip: Fire Code Seating (FCS) option is available with certain upholstery fabric choices only.
▶ Pages 270–271

Tip: Glides are not available on chairs with polished aluminum package.

▶ Detailed dimensions, page 22

Tip: Plastic shell on headrest is available in black only.



For Canadian Pricing
Multiply U.S. Price by the Canadian price factor.
▶ See page 1 for details.

► Options, continued from previous page

	Options	U.S. Price	Required to Specify
Casters	• Soft, dual-wheel casters for use on hard floors	+\$21	Specify <i>with soft casters</i> .
Glides	• Glides: plastic	+\$21	Specify <i>with glides</i> .

Specification Information



• Style • Number	• U.S. • Base • Price
46216179	\$1388



For Canadian Pricing
Multiply U.S. Price by the
Canadian price factor.
► See page 1 for details.

Leap 462 Series Work Chairs

3D Knit on Back with Upholstery on Seat



► Need help?
Product details,
page 18

Standard Includes

- Upper back force
- 5" pneumatic seat-height adjustment
- Variable back stop
- Lower back firmness
- Rectilinear independent height-, width-, pivot-, and depth-adjustable arms and soft arm caps, if selected:
- black plastic
- Frame, seat shell, outer back, and five-arm base: plastic
- 3" seat depth adjustment
- Passive seat edge angle
- Adjustable lumbar
- 3D Knit on back only
- Standard upholstery design on seat: Fabric price group 1
- 2½"-diameter, hard-composition, dual-wheel casters: black

Required to Specify

- 1 Style number
 - 2 Plastic color for frame, seat shell, outer back, and base
 - 3 3D Knit color for back
 - 4 Fabric color number for upholstery on seat
 - 5 Options, if selected (see below)
- See *Surface Materials*, page 264.

*Tip: Select COMs require sewn application with an additional upcharge. Specify with an **S** suffix.*

Tip: Always add suffixes in alphabetical order when specifying options to Leap seating.

Tip: Fire Code Seating (FCS) option is available with certain upholstery fabric choices only.

► Pages 270–271

Tip: Glides are not available on chairs with polished aluminum package.

► Detailed dimensions,
page 22

Tip: Plastic shell on headrest is available in black only.



For Canadian Pricing
Multiply U.S. Price by the Canadian price factor.

► See page 1 for details.

	Options	U.S. Price	Required to Specify
Surface Materials	Upholstery		
	• Fabric price group 1	No cost	Specify fabric color number.
	• Fabric price group 2	+\$ 10	Specify fabric color number.
	• Fabric price group 3	+\$ 22	Specify fabric color number.
	• Fabric price group 4	+\$ 30	Specify fabric color number.
	• Fabric price group 5	+\$ 37	Specify fabric color number.
	• Fabric price group 6	+\$ 46	Specify fabric color number.
	• Fabric price group 7	+\$ 54	Specify fabric color number.
	• Fabric price group 8	+\$ 68	Specify fabric color number.
	• Fabric price group 9	+\$ 83	Specify fabric color number.
	• Fabric price group 10	+\$ 95	Specify fabric color number.
	• Customer's Own Material (COM)	No cost	► See <i>Surface Materials Reference Manual</i> to specify.
	• Customer's Own Material (COM-Sewn)	+\$ 36	Add suffix S to the style number and specify fabric number.
	• Steelcase leather upholstery	+\$311	Add suffix S to the style number and specify leather color number.
• Elmosoft leather upholstery	+\$358	Add suffix S to the style number and specify Elmosoft leather color number.	
• Steelcase vinyl	+\$ 36	Add suffix S to the style number and specify vinyl color number.	
• Customer's Own Leather (COL)	+\$155	Add suffix S to the style number and specify leather color number.	
• Customer's Own Vinyl (COV)	+\$ 36	Add suffix S to the style number and specify vinyl color number.	
• Fire Code Seating (FCS)	+\$ 64	Add suffix F to the style number.	
• Soil-retardant treatment applied to upholstery fabric	+\$ 21	Specify <i>with soil-retardant treatment</i> .	
	Polished aluminum package		
• Polished aluminum package on chairs with arms and 6205 Black frame finish	+\$422		Add suffix C to the style number.
	Platinum		
• On frame, base, arm retainer, and outer back	+\$ 78		Specify <i>with 6249 Platinum</i> .
Arms	• Height-adjustable arms, soft arm caps	–\$ 82	Specify <i>with height-adjustable arms</i> .
	• Armless	–\$254	Specify <i>without arms</i> .
Seat Height	• 7" pneumatic seat-height adjustment	+\$ 52	Specify <i>with 7" pneumatic seat-height adjustment</i> .
Headrest	• Headrest	+\$208	Specify <i>with headrest</i> .

► Options, continued on next page

► Options, continued from previous page

	Options	U.S. Price	Required to Specify
Lumbar	• Without lumbar	-\$52	Specify <i>without lumbar</i> .
Casters	• Soft, dual-wheel casters for use on hard floors	+\$21	Specify <i>with soft casters</i> .
Glides	• Glides: plastic	+\$21	Specify <i>with glides</i> .

Specification Information



• Style Number	• U.S. Base Price
46216189	\$1440
:	:



For Canadian Pricing
Multiply U.S. Price by the Canadian price factor.
► See page 1 for details.

Leap 462 Series Stools

Upholstery on Back and Seat

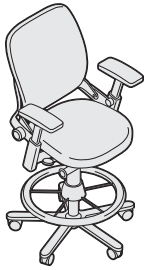

► Need help?
Product details,
page 18

Standard Includes

- Upper back force
- 8" pneumatic seat-height adjustment
- Variable back stop
- Lower back firmness
- Passive seat edge angle
- Rectilinear independent height-, width-, pivot-, and depth-adjustable arms and soft arm caps, if selected:
black plastic
- Frame, seat shell, outer back, and five-arm base:
plastic
- 3" seat depth adjustment
- Column and 4" adjustable foot ring: black
- Standard upholstery design: fabric price group 1
- 2"-diameter, hard-composition, dual-wheel casters: black

Required to Specify

- 1 Style number
 - 2 Plastic color for frame, seat shell, outer back, and base
 - 3 Fabric color number for upholstery on seat and back
 - 4 Options, if selected (see below)
- See *Surface Materials*, page 264.

*Tip: Select COMs require sewn application with an additional upcharge. Specify with an **S** suffix.*

Tip: Always add suffixes in alphabetical order when specifying options to Leap seating.

Tip: Fire Code Seating (FCS) option is available with certain upholstery fabric choices only.

► Pages 270–271

	Options	U.S. Price	Required to Specify
Surface Materials	Upholstery		
	• Fabric price group 1	No cost	Specify fabric color number.
	• Fabric price group 2	+\$ 22	Specify fabric color number.
	• Fabric price group 3	+\$ 43	Specify fabric color number.
	• Fabric price group 4	+\$ 59	Specify fabric color number.
	• Fabric price group 5	+\$ 75	Specify fabric color number.
	• Fabric price group 6	+\$ 92	Specify fabric color number.
	• Fabric price group 7	+\$107	Specify fabric color number.
	• Fabric price group 8	+\$134	Specify fabric color number.
	• Fabric price group 9	+\$166	Specify fabric color number.
	• Fabric price group 10	+\$187	Specify fabric color number.
	• Customer's Own Material (COM)	No cost	► See <i>Surface Materials Reference Manual</i> to specify.
	• Customer's Own Material (COM-Sewn)	+\$ 68	Add suffix S to the style number and specify fabric number.
• Steelcase leather upholstery	+\$623	Add suffix S to the style number and specify leather color number.	
• Elmosoft leather upholstery	+\$720	Add suffix S to the style number and specify Elmosoft leather color number.	
• Steelcase vinyl	+\$ 68	Add suffix S to the style number and specify vinyl color number.	
• Customer's Own Leather (COL)	+\$311	Add suffix S to the style number and specify leather color number.	
• Customer's Own Vinyl (COV)	+\$ 68	Add suffix S to the style number and specify vinyl color number.	
• Fire Code Seating (FCS)	+\$ 64	Add suffix F to the style number.	
• Soil-retardant treatment applied to upholstery fabric	+\$ 21	Specify <i>with soil-retardant treatment</i> .	
	Platinum		
	• On frame, base, arm retainer, and outer back	+\$ 78	Specify <i>with 6249 Platinum</i> .
Arms	• Height-adjustable arms, soft arm caps	–\$ 82	Specify <i>with height-adjustable arms</i> .
	• Armless	–\$254	Specify <i>without arms</i> .
Lumbar	• Without lumbar	–\$ 52	Specify <i>without lumbar</i> .
Casters	• Soft, dual-wheel casters for use on hard floors	+\$ 21	Specify <i>with soft casters</i> .
Glides	• Glides: plastic	+\$ 21	Specify <i>with glides</i> .

► Detailed dimensions,
page 22



For Canadian Pricing

Multiply U.S. Price by the Canadian price factor.

► See page 1 for details.

Specification Information



• Style Number	• U.S. Base Price
46267179	\$1600



For Canadian Pricing
 Multiply U.S. Price by the
 Canadian price factor.
 ▶ See page 1 for details.

Leap 462 Series Stools

3D Knit on Back with Upholstery on Seat



Standard Includes		Required to Specify
<ul style="list-style-type: none"> ▶ Need help? Product details, page 18 	<ul style="list-style-type: none"> • Upper back force • 8" pneumatic seat-height adjustment • Variable back stop • Lower back firmness • Passive seat edge angle • Rectilinear independent height-, width-, pivot-, and depth-adjustable arms and soft arm caps, if selected: black plastic • Frame, seat shell, outer back, and five-arm base: plastic • Column and 4" adjustable foot ring: black • 3D Knit on back only • 3" seat depth adjustment • Adjustable lumbar • Standard upholstery design on seat: fabric price group 1 • 2"-diameter, hard-composition, dual-wheel casters: black 	<ol style="list-style-type: none"> 1 Style number 2 Plastic color for frame, seat shell, outer back, and base 3 3D Knit color for back 4 Fabric color number for upholstery on seat 5 Options, if selected (see below) <ul style="list-style-type: none"> ▶ See <i>Surface Materials</i>, page 264.

	Options	U.S. Price	Required to Specify
Surface Materials	Upholstery		
	• Fabric price group 1	No cost	Specify fabric color number.
	• Fabric price group 2	+\$ 10	Specify fabric color number.
	• Fabric price group 3	+\$ 22	Specify fabric color number.
	• Fabric price group 4	+\$ 30	Specify fabric color number.
	• Fabric price group 5	+\$ 37	Specify fabric color number.
	• Fabric price group 6	+\$ 46	Specify fabric color number.
	• Fabric price group 7	+\$ 54	Specify fabric color number.
	• Fabric price group 8	+\$ 68	Specify fabric color number.
	• Fabric price group 9	+\$ 83	Specify fabric color number.
	• Fabric price group 10	+\$ 95	Specify fabric color number.
	• Customer's Own Material (COM)	No cost	▶ See <i>Surface Materials Reference Manual</i> to specify.
	• Customer's Own Material (COM-Sewn)	+\$ 36	Add suffix S to the style number and specify fabric number.
	• Steelcase leather upholstery	+\$311	Add suffix S to the style number and specify leather color number.
• Elmosoft leather upholstery	+\$358	Add suffix S to the style number and specify Elmosoft leather color number.	
• Steelcase vinyl	+\$ 36	Add suffix S to the style number and specify vinyl color number.	
• Customer's Own Leather (COL)	+\$155	Add suffix S to the style number and specify leather color number.	
• Customer's Own Vinyl (COV)	+\$ 36	Add suffix S to the style number and specify vinyl color number.	
• Fire Code Seating (FCS)	+\$ 64	Add suffix F to the style number.	
• Soil-retardant treatment applied to upholstery fabric	+\$ 21	Specify <i>with soil-retardant treatment</i> .	
	Platinum		
	• On frame, base, arm retainer, and outer back	+\$ 78	Specify <i>with 6249 Platinum</i> .
Arms	• Height-adjustable arms, soft arm caps	-\$ 82	Specify <i>with height-adjustable arms</i> .
	• Armless	-\$254	Specify <i>without arms</i> .
Lumbar	• Without lumbar	-\$ 52	Specify <i>without lumbar</i> .
Casters	• Soft, dual-wheel casters for use on hard floors	+\$ 21	Specify <i>with soft casters</i> .
Glides	• Glides: plastic	+\$ 21	Specify <i>with glides</i> .

Tip: Select COMs require sewn application with an additional upcharge. Specify with an **S** suffix.

Tip: Always add suffixes in alphabetical order when specifying options to Leap seating.

Tip: Fire Code Seating (FCS) option is available with certain upholstery fabric choices only.

▶ Pages 270–271

▶ Detailed dimensions, page 22



For Canadian Pricing

Multiply U.S. Price by the Canadian price factor.

▶ See page 1 for details.

Specification Information



• Style Number	• U.S. Base Price
46267189	\$1652



For Canadian Pricing
 Multiply U.S. Price by the
 Canadian price factor.
 ▶ See page 1 for details.

Leap Plus 462 Series Work Chairs

Upholstery on Back and Seat



► Need help?
Product details,
page 18

Standard Includes

- Upper back force
- 4" pneumatic seat-height adjustment
- Variable back stop
- Lower back firmness
- Rectilinear independent height-, width-, pivot-, and depth-adjustable arms and soft arm caps, if selected: black plastic
- Frame, seat shell, outer back, and five-arm base: plastic
- 2" seat depth adjustment
- Adjustable lumbar
- Standard upholstery design: fabric price group 1
- 2½"-diameter, hard-composition, dual-wheel casters: black

Required to Specify

- 1 Style number
 - 2 Plastic color for frame, seat shell, outer back, and base
 - 3 Fabric color number for upholstery on seat and back
 - 4 Options, if selected (see below)
- See *Surface Materials*, page 264.

	Options	U.S. Price	Required to Specify
Surface Materials	Upholstery		
	• Fabric price group 1	No cost	Specify fabric color number.
	• Fabric price group 2	+\$ 22	Specify fabric color number.
	• Fabric price group 3	+\$ 43	Specify fabric color number.
	• Fabric price group 4	+\$ 59	Specify fabric color number.
	• Fabric price group 5	+\$ 75	Specify fabric color number.
	• Fabric price group 6	+\$ 92	Specify fabric color number.
	• Fabric price group 7	+\$107	Specify fabric color number.
	• Fabric price group 8	+\$134	Specify fabric color number.
	• Fabric price group 9	+\$166	Specify fabric color number.
	• Fabric price group 10	+\$187	Specify fabric color number.
	• Customer's Own Material (COM)	No cost	► See <i>Surface Materials Reference Manual</i> to specify.
	• Customer's Own Material (COM-Sewn)	+\$ 68	Add suffix S to the style number and specify fabric number.
	• Steelcase leather upholstery	+\$623	Add suffix S to the style number and specify leather color number.
	• Elmosoft leather upholstery	+\$720	Add suffix S to the style number and specify Elmosoft leather color number.
• Steelcase vinyl	+\$ 68	Add suffix S to the style number and specify vinyl color number.	
• Customer's Own Leather (COL)	+\$311	Add suffix S to the style number and specify leather color number.	
• Customer's Own Vinyl (COV)	+\$ 68	Add suffix S to the style number and specify vinyl color number.	
• Fire Code Seating (FCS)	+\$ 64	Add suffix F to the style number.	
• Soil-retardant treatment applied to upholstery fabric	+\$ 21	Specify <i>with soil-retardant treatment</i> .	
	Platinum		
	• On frame, base, arm retainer, and outer back	+\$ 78	Specify <i>with 6249 Platinum</i> .
Arms	• Height-adjustable arms, soft arm caps	-\$ 82	Specify <i>with height-adjustable arms</i> .
	• Armless	-\$254	Specify <i>without arms</i> .
Seat Height	• 5" pneumatic seat-height adjustment	+\$ 52	Specify <i>with 5" pneumatic seat-height adjustment</i> .
Lumbar	• Without lumbar	-\$ 52	Specify <i>without lumbar</i> .
Casters	• Soft, dual-wheel casters for use on hard floors	+\$ 21	Specify <i>with soft casters</i> .
Glides	• Glides: plastic	+\$ 21	Specify <i>with glides</i> .

*Tip: Select COMs require sewn application with an additional upcharge. Specify with an **S** suffix.*

Tip: Always add suffixes in alphabetical order when specifying options to Leap seating.

Tip: Fire Code Seating (FCS) option is available with certain upholstery fabric choices only.

► Pages 270–271

► Detailed dimensions, page 22

 **For Canadian Pricing**
Multiply U.S. Price by the Canadian price factor.
► See page 1 for details.

Specification Information



•Style •Number	•U.S. •Base •Price
46296179	\$2088



For Canadian Pricing
Multiply U.S. Price by the
Canadian price factor.
▶ See page 1 for details.

Leap Plus 462 Series Work Chairs

3D Knit on Back with Upholstery on Seat



► Need help?
Product details,
page 18

Standard Includes

- Upper back force
- 4" pneumatic seat-height adjustment
- Variable back stop
- Lower back firmness
- Rectilinear independent height-, width-, pivot-, and depth-adjustable arms and soft arm caps, if selected:
- black plastic
- Frame, seat shell, outer back, and five-arm base: plastic
- 2" seat depth adjustment
- Adjustable lumbar
- 3D Knit on back only
- Standard upholstery design on seat: Fabric price group 1
- 2½"-diameter, hard-composition, dual-wheel casters: black

Required to Specify

- 1 Style number
 - 2 Plastic color for frame, seat shell, outer back, and base
 - 3 3D Knit color for back
 - 4 Fabric color number for upholstery on seat
 - 5 Options, if selected (see below)
- See *Surface Materials*, page 264.

*Tip: Select COMs require sewn application with an additional upcharge. Specify with an **S** suffix.*

Tip: Always add suffixes in alphabetical order when specifying options to Leap seating.

Tip: Fire Code Seating (FCS) option is available with certain upholstery fabric choices only.

► Pages 270–271

	Options	U.S. Price	Required to Specify
Surface Materials	Upholstery		
	• Fabric price group 1	No cost	Specify fabric color number.
	• Fabric price group 2	+\$ 10	Specify fabric color number.
	• Fabric price group 3	+\$ 22	Specify fabric color number.
	• Fabric price group 4	+\$ 30	Specify fabric color number.
	• Fabric price group 5	+\$ 37	Specify fabric color number.
	• Fabric price group 6	+\$ 46	Specify fabric color number.
	• Fabric price group 7	+\$ 54	Specify fabric color number.
	• Fabric price group 8	+\$ 68	Specify fabric color number.
	• Fabric price group 9	+\$ 83	Specify fabric color number.
	• Fabric price group 10	+\$ 95	Specify fabric color number.
	• Customer's Own Material (COM)	No cost	► See <i>Surface Materials Reference Manual</i> to specify.
	• Customer's Own Material (COM-Sewn)	+\$ 36	Add suffix S to the style number and specify fabric number.
• Steelcase leather upholstery	+\$311	Add suffix S to the style number and specify leather color number.	
• Elmosoft leather upholstery	+\$358	Add suffix S to the style number and specify Elmosoft leather color number.	
• Steelcase vinyl	+\$ 36	Add suffix S to the style number and specify vinyl color number.	
• Customer's Own Leather (COL)	+\$155	Add suffix S to the style number and specify leather color number.	
• Customer's Own Vinyl (COV)	+\$ 36	Add suffix S to the style number and specify vinyl color number.	
• Fire Code Seating (FCS)	+\$ 64	Add suffix F to the style number.	
• Soil-retardant treatment applied to upholstery fabric	+\$ 21	Specify with <i>soil-retardant treatment</i> .	
	Platinum		
	• On frame, base, arm retainer, and outer back	+\$ 78	Specify with <i>6249 Platinum</i> .
Arms	• Height-adjustable arms, soft arm caps	–\$ 82	Specify with <i>height-adjustable arms</i> .
	• Armless	–\$254	Specify <i>without arms</i> .
Seat Height	• 5" pneumatic seat-height adjustment	+\$ 52	Specify with <i>5" pneumatic seat-height adjustment</i> .
Lumbar	• Without lumbar	–\$ 52	Specify <i>without lumbar</i> .
Casters	• Soft, dual-wheel casters for use on	+\$ 21	Specify with <i>soft casters</i>
Glides	• Glides: plastic	+\$ 21	Specify with <i>glides</i> .

► Detailed dimensions,
page 22



For Canadian Pricing

Multiply U.S. Price by the Canadian price factor.

► See page 1 for details.

Specification Information



•Style Number	•U.S. Base Price
46296189	\$2140



For Canadian Pricing
Multiply U.S. Price by the
Canadian price factor.
▶ See page 1 for details.



Understanding and Specifying Think 465 Series Work Chairs

Product Details

Think 465 Series	40
Dimensions	44

Specifying

Work Chairs with Arms

3D Knit with Standard Upholstery on Seat	46
3D Knit with Sewn Upholstery on Seat	47
Standard Upholstery	48
Sewn Upholstery	49

Work Chairs, Armless

3D Knit with Standard Upholstery on Seat	50
3D Knit with Sewn Upholstery on Seat	51
Standard Upholstery	52
Sewn Upholstery	53

Stools with Arms

3D Knit with Standard Upholstery on Seat	54
3D Knit with Sewn Upholstery on Seat	55
Standard Upholstery	56
Sewn Upholstery	57

Stools, Armless

3D Knit with Standard Upholstery on Seat	58
3D Knit with Sewn Upholstery on Seat	59
Standard Upholstery	60
Sewn Upholstery	61

Work Chairs

Highly adjustable task seating offers maximum personalization for people who sit most of the day performing repetitive tasks. By making a series of simple adjustments, you can customize the chair to your body, preferences, and tasks. These chairs provide continuous, stable, task-oriented comfort, and can be quickly adjusted to support you in upright, forward, and reclining work postures.

- Leap 462 Series
- Leap 464 Series WorkLounge
- Criterion 453 Series
- Think 465 Series
- Amia 482 Series
- Reply 466 Series
- Drive 461 Series
- Jersey Series

Adjustability Features

► See page 12 for a comparison to other chairs. **Think 465 Series**

Mechanisms

Weight-activated ●

Seat Adjustments

Pneumatic height ●

Passive seat edge angle ●

Seat depth ●

Back Adjustments

Lumbar height ●

Arm Adjustments

Arm depth ●

Arm height ●

Arm pivot ●

Arm width ●

Other Features

Foot ring height (stool) ●

Think 465 Series

Think is for performance based customers who are seeking a progressive aesthetic, intuitive ease of use, and the strongest environmental attributes.

Back frame and seat shell are plastic.

Arm caps can pivot independently 30° in and 30° out to accommodate individual user preferences.

Lumbar height adjusts over 4 1/4" to provide additional lower back support and is available as an option.

Your Preference back control provides four settings for the user's personal preference and work style.

Seat height adjusts within a 5" range with a pneumatic adjustment mechanism. A 4" range is available as an option. Stools have a 10" range.

Casters have hard, dual-wheels that roll smoothly on carpets. They are 2 1/2" for increased mobility. Soft, dual-wheel roll-control casters are available as an option for use on hard floors or chair mats.

Arm width adjusts 4 1/2" overall to support forearms in neutral position.

Arm height can adjust independently within a 4" range to help relieve upper back and shoulder fatigue.

Arm depth can retract 3" to allow user to get closer to the worksurface and into tight corners.

Passive seat edge angle allows the front edge of the seat to flex 1 1/2" to relieve pressure under the user's thighs.

Seat depth adjusts within a 2" range to accommodate users of varying leg lengths.

Five-arm base is available in plastic or polished aluminum.

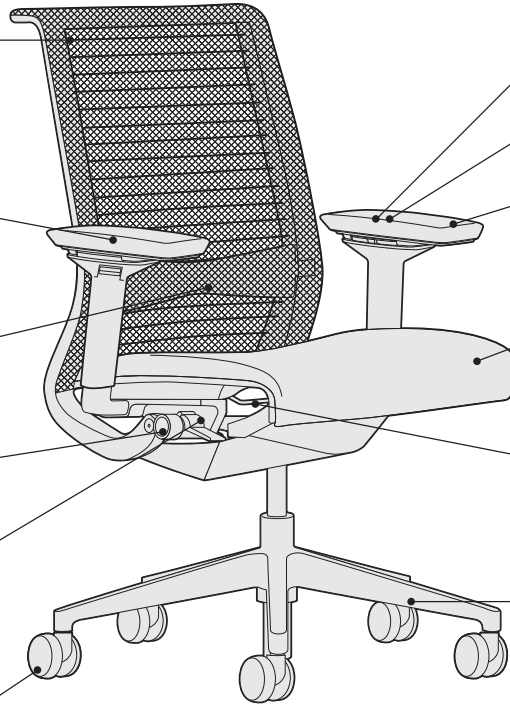

Product Details

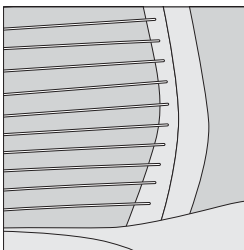

Your Profile seat and back have flexors that dynamically and independently follow the movements of the user.

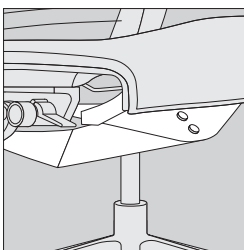

Weight-activated mechanism with a natural fluid motion keeps users oriented to their work.



Your Preference back control has four settings that allow for the user's personal preference and work style.

Chairs are available without arms, with fixed arms, or with height-, width-, pivot-, and depth-adjustable arms.

Cartoned request on your dealer purchase order force Think chairs to ship knocked down with the chair back separated from the base and mechanism. This allows for shipment in a smaller carton. Assembly by a qualified dealer installer is required. Assembly instructions are included. This does not apply to Think stools.

Uncartoned request on your dealer purchase order force Think chairs to ship fully assembled.

Resources

Adjustability instructions are included with every chair.

Seat Adjustments

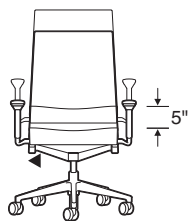

Seat height adjusts pneumatically. To lower, hold handle up while seated. To raise, hold handle up and keep your weight off the chair. Standard range of adjustability is 5" from 16"H to 21"H. A 4" range of adjustability (15"H to 19"H) is available as an option. A 10" range of adjustability (22³/₄"H to 32³/₄"H) is available on stools.

Passive seat edge angle relieves pressure under the user's thighs. The combination of seat flexors with a passive front seat edge helps properly support the angle of the user's leg and thigh without compromising pelvic support. The front seat edge angle flexes 1¹/₂".

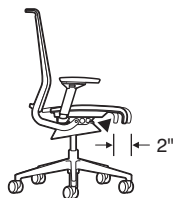

Seat depth adjusts 2" (15"-17") by pulling handle up. Slide seat forward or back to accommodate various leg lengths. Release handle to lock.

Back Adjustments

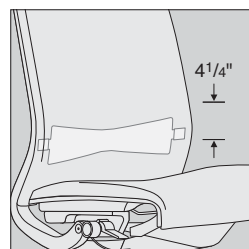

Lumbar height adjusts 4¹/₄" (6" to 10¹/₄" from seat) by grabbing exposed tabs and sliding the lumbar support up or down. Available as an option on work chairs and stools.

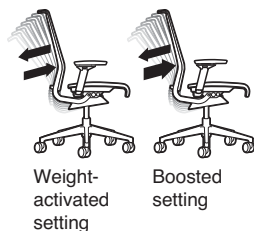

Weight-activated setting

Boosted setting



Mid-stop recline setting

Upright setting

Your Preference control has four settings: (1) weight-activated setting; (2) boosted setting that has approximately 20% more resistance than your body is providing; (3) mid-stop recline setting; and (4) an upright setting.

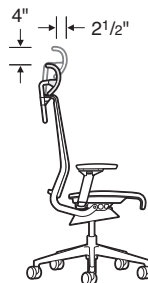

Headrest (option) adjusts 4" vertically and 2¹/₂" horizontally (front to back) to support the head and neck of the user in both upright and recline postures. Whether ordered initially or at a later date, the headrest ships in its own carton and must be field installed.

Arm Adjustments

Height-, width-, pivot-, and depth-adjustable arms come standard on all arm models of chairs. Fixed arms are an option. Also available armless.

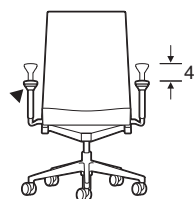

Arm height adjusts independently within a range of 4" (7"-11" from the seat). Push button on outside and under arm cap in while moving arms up or down. Releasing buttons locks arms in position.

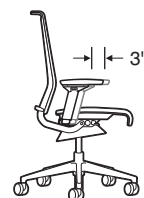

Arm depth adjusts by sliding arm caps back 3". Friction-fit mechanism keeps arms in position.

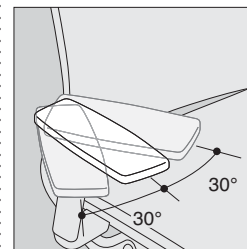

Arms pivot independently, 30° inward and outward.

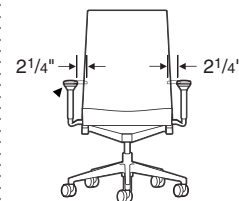

Arm width can be adjusted 2¹/₄" each, 4¹/₂" overall. Grasp arm cap and move in or out.

Other Features

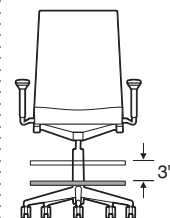

Foot ring height on stools adjusts by first lifting ring and rotating it counter-clockwise to unlock. Then raise or lower ring to desired position before rotating it clockwise to lock. The foot ring has a diameter of 20".

Soft dual-wheel roll-control casters feature an internal brake that activates when the chair is not under load to reduce shifting when user stands up.

Surface Materials

► See surface materials on page 264 for specific availability or refer to the *Surface Materials Reference Manual* for further information.

Upholstery

- Fabric
- Fabric with soil-retardant treatment (option)
- 3D Knit (back only)
- Elmosoft leather
- Leather
- Vinyl

Enclosed back

- Black
- Platinum

Hard components

Chair (frame, seat shell, base, and arm uprights)

- 6205 Black
- 6249 Platinum

Chair (headrest and arm pads)

- 6205 Black

Stool (frame, seat shell, base, and arm uprights)

- 6205 Black
- 6249 Platinum

Stool (headrest, pneumatic column, and footring)

- 6205 Black

Polished aluminum base is optional on select models.

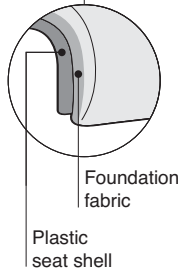

Standard-upholstery uses foundation fabric (which is a default of the specified plastic color). It is partially visible on the sides of the seat and back cushions.

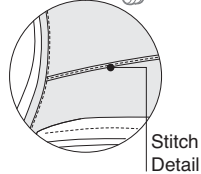

Sewn-upholstery models feature a stitch detail on the sides of the seat and back cushions, and across the lumbar region of the back cushion.

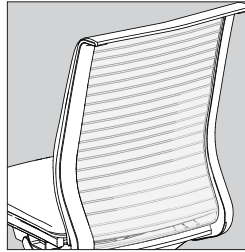

Standard Back

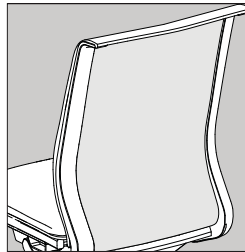

Enclosed Back

Enclosed back features a flexible nylon textile which conceals the flexors on the back. Enclosed back color defaults to match frame finish.

All Steelcase seating with standard upholstery fabrics complies with requirements of the State of California Technical Bulletin 117. All standard seating is labeled to be in compliance with California 117.

Programs & Services

► See *Surface Materials Reference Manual* for further detail about programs and services offered for seating.

The Customer's Own Material (COM)

Program offers the opportunity for customers to select fabrics that are not offered through the standard Steelcase surface materials program for use on Steelcase products. Through the COM program, Steelcase will test your materials for application on Steelcase products. Once approved, you can place your order. Steelcase will facilitate the entire ordering process and give you a production schedule. Steelcase will order the COM fabric directly from the textile manufacturer. For up-to-date information regarding fabric test results for all COM fabrics and details regarding yardage requirements for most seating lines, visit the COM Web site. To locate the COM Web site:

- Visit www.steelcase.com

Soil retardants are treatments that provide long-term soil and stain resistance to a fabric without affecting the shade or the integrity of the fabric. The following Steelcase Textiles are available pre-treated with soil retardant. (You do not need to select the soil-retardant option for these fabrics and incur the upcharge.)

- Jacks
- Link
- Spyder

For information on soil retardant fabrics on Select Surfaces, please refer to the *Surface Materials Reference Manual*.

Soil-retardant treatment is available on all other seating fabrics at an additional upcharge per seating unit. To order this option, please select "Soil-Retardant Treatment" under "Optional Accessories."

For soil-retardant treatment on COMs, please select "Soil-Retardant Treatment" under "Optional Accessories." Minimums or additional yardage may be required. Please contact the vendor directly for specific information.

Extended lead times may be necessary for this service.

Contact your Steelcase Solutions Fulfillment Team Representative at 1.888.STEELCASE (1.888.783.3522) or send an email to lineone@steelcase.com.

Fire Codes

► See pages 270–271 for upholstery fabrics available for use with FCS modification.

Steelcase offers Fire Code Seating modification (FCS) on nearly all seating models. The most rigorous fire codes in the nation have been developed in California, and the Steelcase FCS modification is designed to meet those codes. Fire Code Seating (FCS) indicates that a product is constructed to meet the strict fire code requirements of high public occupancy areas such as theaters, meeting rooms, and lobbies. The FCS standards will meet both the State of California Home Furnishing Technical Bulletin 133 (Cal TB 133) and Boston Fire Code (BFC). Boston adopted the California Home Furnishing Technical Bulletin TB 133 test standard in 1992.

Local codes may have special requirements for upholstery.

Dimensions

▶ Page 44

Resources

Printed Materials

- ▶ Think Product Brochure (07-0006344)
- ▶ Think Environmental Brochure (04-0011852) (PDF only)
- ▶ Think Environmental Product Declaration (EPD) (04-0012421) (PDF only)
- ▶ Think Hang Tag (04-0011853) (PDF only)
- ▶ Think National Ad Reprint (04-0011856)
- ▶ Alive Seating Booklet (07-0006467)
- ▶ Think Customer Story (08-0000158)
- ▶ Innovation Seating Brochure (04-0011870)
- ▶ Model sales conversation available on in2.steelcase.com (PDF only)
- ▶ A New Day (03-0003362)

Audiovisual Materials

- ▶ Think Design Story—Video (04-0011845)
- ▶ Think Design Story—DVD (04-0011846)
- ▶ Think Model Sales Presentation—DVD (04-0012577)
- ▶ Think Model Sales Presentation—VHS (04-0012578)
- ▶ Think Model Sales Presentation—audio CD (04-0012579)
- ▶ Interactive User Guide available on www.steelcase.com
- ▶ Alive seating video (download) available on in2.steelcase.com (sales tools > seating).

Dimensions

Think 465 Series

Features	Overall Depth	Width	Height	Seat Depth	Functional Seat Depth	Seat Width	Seat Height from Floor	Back Width	Back Height from Seat	Lumbar Height from Seat
----------	---------------	-------	--------	------------	-----------------------	------------	------------------------	------------	-----------------------	-------------------------

Think 465 Series

Chairs

Arms	23" to 25"	27"	37 ¹ / ₈ " to 41 ³ / ₄ "	18 ¹ / ₂ "	15" to 17"	19 ³ / ₄ "	16" to 21" (15" to 19" optional)	19"	22 ³ / ₄ "	6" to 10 ¹ / ₄ "
Without Arms	23" to 25"	27"	37 ¹ / ₈ " to 41 ³ / ₄ "	18 ¹ / ₂ "	15" to 17"	19 ³ / ₄ "	16" to 21" (15" to 19" optional)	19"	22 ³ / ₄ "	6" to 10 ¹ / ₄ "

Stools

Arms	23" to 25"	27"	43 ³ / ₄ " to 53 ¹ / ₂ "	18 ¹ / ₂ "	15" to 17"	19 ³ / ₄ "	22 ³ / ₄ " to 32 ³ / ₄ "	19"	22 ³ / ₄ "	6" to 10 ¹ / ₄ "
Without Arms	23" to 25"	27"	43 ³ / ₄ " to 53 ¹ / ₂ "	18 ¹ / ₂ "	15" to 17"	19 ³ / ₄ "	22 ³ / ₄ " to 32 ³ / ₄ "	19"	22 ³ / ₄ "	6" to 10 ¹ / ₄ "

*Arms may be tool-adjusted inward 1" to accommodate the user's preference.

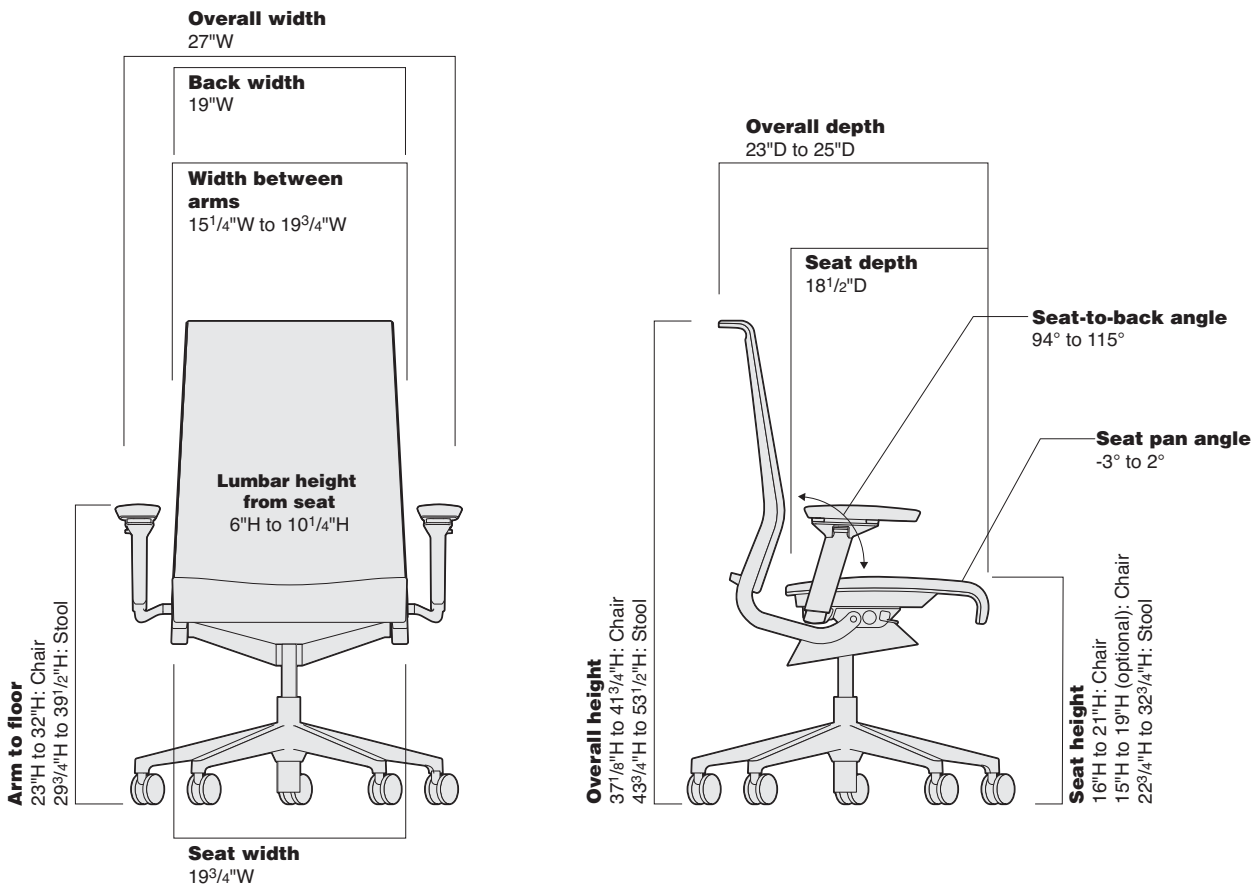

• Width • Between • Adjustable • Arms	• Width • Between • Fixed • Arms	• Arm • to • Floor	• Arm • Height • from • Seat	• Arm • Height • from Seat • for Fixed • Arms	• Arm Cap • Pivot • Range	• Angle • Between • Seat and • Back	• Seat • Pan • Angle	• Headrest • Height • Adjustment • Range	• Headrest • Depth • Adjustment • Range
Chairs									
15¼" to 19¾"	19"*	23" to 32"	7" to 11"	10½"	30° inward, 30° outward	94° to 115°	-3° to 2°	4"	2½"
N.A.	N.A.	N.A.	N.A.	N.A.	N.A.	94° to 115°	-3° to 2°	4"	2½"
Stools									
15¼" to 19¾"	19"*	29¾" to 39½"	7" to 11"	10½"	30° inward, 30° outward	94° to 115°	-3° to 2°	4"	2½"
N.A.	N.A.	N.A.	N.A.	N.A.	N.A.	94° to 115°	-3° to 2°	4"	2½"

*Arms may be tool-adjusted inward 1" to accommodate the user's preference.

Think 465 Series Work Chairs

With Arms, 3D Knit with Standard Upholstery on Seat



Standard Includes		Required to Specify
<ul style="list-style-type: none"> ▶ Need help? Product details, page 40 	<ul style="list-style-type: none"> • 5" pneumatic seat-height adjustment (16"–21") • Your Preference control • Passive seat edge angle • Frame, seat shell, and five-arm plastic base • 2" seat depth adjustment • Height-, width-, pivot-, and depth-adjustable arms • 3D Knit on back • Standard upholstery design on seat: fabric price group 1 • 2½"-diameter, hard-composition, dual-wheel casters: black 	<ol style="list-style-type: none"> 1 Style number 2 Plastic color for frame, seat shell, and base 3 3D Knit color for back 4 Fabric color number for upholstery on seat 5 Options, if selected (see below) <ul style="list-style-type: none"> ▶ See <i>Surface Materials</i>, page 264.

Options	U.S. Price	Required to Specify	
Surface Materials Upholstery <ul style="list-style-type: none"> • Fabric price group 1 • Fabric price group 2 • Fabric price group 3 • Fabric price group 4 • Fabric price group 5 • Fabric price group 6 • Fabric price group 7 • Fabric price group 8 • Fabric price group 9 • Fabric price group 10 • Customer's Own Material (COM) • Fire Code Seating (FCS) • Soil-retardant treatment applied to upholstery fabric Platinum <ul style="list-style-type: none"> • On frame, base, and arm retainer 	<ul style="list-style-type: none"> No cost +\$ 10 +\$ 22 +\$ 30 +\$ 37 +\$ 46 +\$ 54 +\$ 68 +\$ 83 +\$ 95 No cost +\$ 32 +\$ 21 	<ul style="list-style-type: none"> Specify fabric color number. Specify fabric color number. Specify fabric color number. Specify fabric color number. Specify fabric color number. Specify fabric color number. Specify fabric color number. Specify fabric color number. Specify fabric color number. Specify fabric color number. ▶ See <i>Surface Materials Reference Manual</i>. Add suffix F to the style number. Specify <i>with soil-retardant treatment</i>. 	
Arms	<ul style="list-style-type: none"> • Fixed arms 	<ul style="list-style-type: none"> –\$ 89 	<ul style="list-style-type: none"> Specify <i>with fixed arms</i>.
Base	<ul style="list-style-type: none"> • Polished aluminum base 	<ul style="list-style-type: none"> +\$130 	<ul style="list-style-type: none"> Specify <i>with aluminum base</i>.
Seat Height	<ul style="list-style-type: none"> • 4" pneumatic seat-height adjustment (15"–19") 	<ul style="list-style-type: none"> +\$ 52 	<ul style="list-style-type: none"> Specify <i>with 4" pneumatic seat-height adjustment</i>.
Headrest	<ul style="list-style-type: none"> • Headrest 	<ul style="list-style-type: none"> +\$156 	<ul style="list-style-type: none"> Specify <i>with headrest</i>.
Lumbar Height	<ul style="list-style-type: none"> • 4¼" travel for additional lumbar support 	<ul style="list-style-type: none"> +\$ 52 	<ul style="list-style-type: none"> Specify <i>with adjustable lumbar height</i>.
Enclosed Back	<ul style="list-style-type: none"> • Enclosed back 	<ul style="list-style-type: none"> +\$ 88 	<ul style="list-style-type: none"> Specify <i>with enclosed back</i>.
Casters	<ul style="list-style-type: none"> • Soft, dual-wheel roll-control casters for use on hard floors 	<ul style="list-style-type: none"> +\$ 21 	<ul style="list-style-type: none"> Specify <i>with soft roll-control casters</i>.

Specification Information

Style Number	U.S. Base Price
46543100	\$1089

▶ Detailed dimensions, page 44



For Canadian Pricing
 Multiply U.S. Price by the Canadian price factor.
 ▶ See page 1 for details.

Think 465 Series Work Chairs

With Arms, 3D Knit with Sewn Upholstery on Seat

Think 465 Series
Work Chairs



Standard Includes		Required to Specify
<ul style="list-style-type: none"> ▶ Need help? Product details, page 40 	<ul style="list-style-type: none"> • 5" pneumatic seat-height adjustment (16"-21") • Your Preference control • Passive seat edge angle • Frame, seat shell, and five-arm plastic base • 2" seat depth adjustment • Height-, width-, pivot-, and depth-adjustable arms • 3D Knit on back • Sewn upholstery design on seat: fabric price group 1 • 2½"-diameter, hard-composition, dual-wheel casters: black 	<ol style="list-style-type: none"> 1 Style number 2 Plastic color for frame, seat shell, and base 3 3D Knit color for back 4 Fabric color number for upholstery on seat 5 Options, if selected (see below) <ul style="list-style-type: none"> ▶ See <i>Surface Materials</i>, page 264.

Tip: Fire Code Seating (FCS) option is not available on 3D Knit models with lumbar height or enclosed back option.

▶ See pages 270–271 for upholstery fabric choices.

Options	U.S. Price	Required to Specify
Surface Materials Upholstery <ul style="list-style-type: none"> • Fabric price group 1 • Fabric price group 2 • Fabric price group 3 • Fabric price group 4 • Fabric price group 5 • Fabric price group 6 • Fabric price group 7 • Fabric price group 8 • Fabric price group 9 • Fabric price group 10 • Steelcase leather upholstery • Elmosoft leather upholstery • Customer's Own Material (COM), Customer's Own Vinyl (COV), or Customer's Own Leather (COL) • Fire Code Seating (FCS) • Soil-retardant treatment applied to upholstery fabric 	No cost +\$ 10 +\$ 22 +\$ 30 +\$ 37 +\$ 46 +\$ 54 +\$ 68 +\$ 83 +\$ 95 +\$150 +\$173 No cost +\$ 32 +\$ 21	Specify fabric color number. Specify fabric color number. Specify fabric color number. Specify fabric color number. Specify fabric color number. Specify fabric color number. Specify fabric color number. Specify fabric color number. Specify fabric color number. Specify fabric color number. Specify leather color number. Specify Elmosoft leather color number. ▶ See <i>Surface Materials Reference Manual</i> . Add suffix F to the style number. Specify with <i>soil-retardant treatment</i> .
Platinum <ul style="list-style-type: none"> • On frame, base, and arm retainer 	+\$ 78	Specify with <i>6249 Platinum</i> .
Arms <ul style="list-style-type: none"> • Fixed arms 	–\$ 89	Specify with <i>fixed arms</i> .
Base <ul style="list-style-type: none"> • Polished aluminum base 	+\$130	Specify with <i>aluminum base</i> .
Seat Height <ul style="list-style-type: none"> • 4" pneumatic seat-height adjustment (15"–19") 	+\$ 52	Specify with <i>4" pneumatic seat-height adjustment</i> .
Headrest <ul style="list-style-type: none"> • Headrest 	+\$156	Specify with <i>headrest</i> .
Lumbar Height <ul style="list-style-type: none"> • 4¼" travel for additional lumbar support 	+\$ 52	Specify with <i>adjustable lumbar height</i> .
Enclosed Back <ul style="list-style-type: none"> • Enclosed back 	+\$ 88	Specify with <i>enclosed back</i> .
Casters <ul style="list-style-type: none"> • Soft, dual-wheel roll-control casters for use on hard floors 	+\$ 21	Specify with <i>soft roll-control casters</i> .

Specification Information

Style Number	U.S. Base Price
46542100	\$1125

▶ Detailed dimensions, page 44



For Canadian Pricing
Multiply U.S. Price by the Canadian price factor.
▶ See page 1 for details.

Think 465 Series Work Chairs

With Arms, Standard Upholstery



Standard Includes		Required to Specify
<ul style="list-style-type: none"> ▶ Need help? Product details, page 40 	<ul style="list-style-type: none"> • 5" pneumatic seat-height adjustment (16"–21") • Your Preference™ control • Passive seat edge angle • Frame, seat shell, and five-arm plastic base • 2" seat depth adjustment • Height-, width-, pivot-, and depth-adjustable arms • Standard upholstery design: fabric price group 1 • 2½"-diameter, hard-composition, dual-wheel casters: black 	<ol style="list-style-type: none"> 1 Style number 2 Plastic color for frame, seat shell, and base 3 Fabric color number for upholstery on seat and back 4 Options, if selected (see below) <ul style="list-style-type: none"> ▶ See <i>Surface Materials</i>, page 264.

	Options	U.S. Price	Required to Specify
Surface Materials	Upholstery		
	• Fabric price group 1	No cost	Specify fabric color number.
	• Fabric price group 2	+\$ 22	Specify fabric color number.
	• Fabric price group 3	+\$ 43	Specify fabric color number.
	• Fabric price group 4	+\$ 59	Specify fabric color number.
	• Fabric price group 5	+\$ 75	Specify fabric color number.
	• Fabric price group 6	+\$ 92	Specify fabric color number.
	• Fabric price group 7	+\$107	Specify fabric color number.
	• Fabric price group 8	+\$134	Specify fabric color number.
	• Fabric price group 9	+\$166	Specify fabric color number.
	• Fabric price group 10	+\$187	Specify fabric color number.
	• Customer's Own Material (COM)	No cost	▶ See <i>Surface Materials Reference Manual</i> .
	• Fire Code Seating (FCS)	+\$ 64	Add suffix F to the style number.
	• Soil-retardant treatment applied to upholstery fabric	+\$ 21	Specify with soil-retardant treatment.
	Platinum		
	• On frame, base, and arm retainer	+\$ 78	Specify with 6249 Platinum.
Arms	• Fixed arms	–\$ 89	Specify with fixed arms.
Base	• Polished aluminum base	+\$130	Specify with aluminum base.
Seat Height	• 4" pneumatic seat-height adjustment (15"–19")	+\$ 52	Specify with 4" pneumatic seat-height adjustment.
Headrest	• Headrest	+\$156	Specify with headrest.
Lumbar Height	• 4¼" travel for additional lumbar support	+\$ 52	Specify with adjustable lumbar height.
Enclosed Back	• Enclosed back	+\$ 88	Specify with enclosed back.
Casters	• Soft, dual-wheel roll-control casters for use on hard floors	+\$ 21	Specify with soft roll-control casters.

Tip: Fire Code Seating (FCS) option is not available on models with enclosed back option.

▶ See pages 270–271 for upholstery fabric choices.

Specification Information

Style Number	U.S. Base Price
46540100	\$1037

▶ Detailed dimensions, page 44



For Canadian Pricing

Multiply U.S. Price by the Canadian price factor.

▶ See page 1 for details.

Think 465 Series Work Chairs

With Arms, Sewn Upholstery

Think 465 Series
Work Chairs



Standard Includes		Required to Specify
<ul style="list-style-type: none"> ▶ Need help? Product details, page 40 	<ul style="list-style-type: none"> • 5" pneumatic seat-height adjustment (16"–21") • Your Preference™ control • Passive seat edge angle • Frame, seat shell, and five-arm plastic base • 2" seat depth adjustment • Height-, width-, pivot-, and depth-adjustable arms • Sewn upholstery design: fabric price group 1 • 2½"-diameter, hard-composition, dual-wheel casters: black 	<ol style="list-style-type: none"> 1 Style number 2 Plastic color for frame, seat shell, and base 3 Fabric color number for upholstery on seat and back 4 Options, if selected (see below) <ul style="list-style-type: none"> ▶ See <i>Surface Materials</i>, page 264.

Options	U.S. Price	Required to Specify
Surface Materials	Upholstery	
	<ul style="list-style-type: none"> • Fabric price group 1 • Fabric price group 2 • Fabric price group 3 • Fabric price group 4 • Fabric price group 5 • Fabric price group 6 • Fabric price group 7 • Fabric price group 8 • Fabric price group 9 • Fabric price group 10 • Steelcase leather upholstery • Elmosoft leather upholstery • Steelcase vinyl • Customer's Own Material (COM) • Customer's Own Vinyl (COV) • Customer's Own Leather (COL) • Fire Code Seating (FCS) • Soil-retardant treatment applied to upholstery fabric 	<ul style="list-style-type: none"> Specify fabric color number. Specify fabric color number. Specify fabric color number. Specify fabric color number. Specify fabric color number. Specify fabric color number. Specify fabric color number. Specify fabric color number. Specify fabric color number. Specify fabric color number. Specify leather color number. Specify Elmosoft leather color number. Specify vinyl color number. ▶ See <i>Surface Materials Reference Manual</i>. Specify vinyl color number. Specify leather color number. Add suffix F to the style number. Specify with soil-retardant treatment.
	Platinum	
	<ul style="list-style-type: none"> • On frame, base, and arm retainer 	<ul style="list-style-type: none"> Specify with 6249 Platinum.
Arms	<ul style="list-style-type: none"> • Fixed arms 	<ul style="list-style-type: none"> Specify with fixed arms.
Base	<ul style="list-style-type: none"> • Polished aluminum base 	<ul style="list-style-type: none"> Specify with aluminum base.
Seat Height	<ul style="list-style-type: none"> • 4" pneumatic seat-height adjustment (15"–19") 	<ul style="list-style-type: none"> Specify with 4" pneumatic seat-height adjustment.
Headrest	<ul style="list-style-type: none"> • Headrest 	<ul style="list-style-type: none"> Specify with headrest.
Lumbar Height	<ul style="list-style-type: none"> • 4¼" travel for additional lumbar support 	<ul style="list-style-type: none"> Specify with adjustable lumbar height.
Enclosed Back	<ul style="list-style-type: none"> • Enclosed back 	<ul style="list-style-type: none"> Specify with enclosed back.
Casters	<ul style="list-style-type: none"> • Soft, dual-wheel roll-control casters for use on hard floors 	<ul style="list-style-type: none"> Specify with soft roll-control casters.

Tip: Always add suffixes in alphabetical order when specifying options to Think seating.

Tip: Fire Code Seating (FCS) option is not available on models with enclosed back option.

▶ See pages 270–271 for upholstery fabric choices.

Specification Information

Style Number	U.S. Base Price
46541100S	\$1105

▶ Detailed dimensions, page 44



For Canadian Pricing

Multiply U.S. Price by the Canadian price factor.

▶ See page 1 for details.

Think 465 Series Work Chairs

Armless, 3D Knit with Standard Upholstery on Seat



Standard Includes		Required to Specify
<ul style="list-style-type: none"> ▶ Need help? Product details, page 40 	<ul style="list-style-type: none"> • 5" pneumatic seat-height adjustment (16"–21") • Your Preference control • Passive seat edge angle • Frame, seat shell, and five-arm plastic base • 2" seat depth adjustment • 3D Knit on back • Standard upholstery design on seat: fabric price group 1 • 2½"-diameter, hard-composition, dual-wheel casters: black 	<ol style="list-style-type: none"> 1 Style number 2 Plastic color for frame, seat shell, and base 3 3D Knit color for back 4 Fabric color number for upholstery on seat 5 Options, if selected (see below) <ul style="list-style-type: none"> ▶ See <i>Surface Materials</i>, page 264.

Tip: Fire Code Seating (FCS) option is not available on 3D Knit models with lumbar height or enclosed back option.

▶ See pages 270–271 for upholstery fabric choices.

Options	U.S. Price	Required to Specify
Surface Materials Upholstery <ul style="list-style-type: none"> • Fabric price group 1 • Fabric price group 2 • Fabric price group 3 • Fabric price group 4 • Fabric price group 5 • Fabric price group 6 • Fabric price group 7 • Fabric price group 8 • Fabric price group 9 • Fabric price group 10 • Customer's Own Material (COM) • Fire Code Seating (FCS) • Soil-retardant treatment applied to upholstery fabric Platinum <ul style="list-style-type: none"> • On frame, base, and arm retainer 	<ul style="list-style-type: none"> No cost +\$ 10 +\$ 22 +\$ 30 +\$ 37 +\$ 46 +\$ 54 +\$ 68 +\$ 83 +\$ 95 No cost +\$ 32 +\$ 21 	<ul style="list-style-type: none"> Specify fabric color number. Specify fabric color number. Specify fabric color number. Specify fabric color number. Specify fabric color number. Specify fabric color number. Specify fabric color number. Specify fabric color number. Specify fabric color number. Specify fabric color number. ▶ See <i>Surface Materials Reference Manual</i>. Add suffix F to the style number. Specify with soil-retardant treatment.
Base <ul style="list-style-type: none"> • Polished aluminum base 	+\$130	Specify with aluminum base.
Seat Height <ul style="list-style-type: none"> • 4" pneumatic seat-height adjustment (15"–19") 	+\$ 52	Specify with 4" pneumatic seat-height adjustment.
Headrest <ul style="list-style-type: none"> • Headrest 	+\$156	Specify with headrest.
Lumbar Height <ul style="list-style-type: none"> • 4¼" travel for additional lumbar support 	+\$ 52	Specify with adjustable lumbar height.
Enclosed Back <ul style="list-style-type: none"> • Enclosed back 	+\$ 88	Specify with enclosed back.
Casters <ul style="list-style-type: none"> • Soft, dual-wheel roll-control casters for use on hard floors 	+\$ 21	Specify with soft roll-control casters.

Specification Information	
Style Number	U.S. Base Price
46543000	\$860

▶ Detailed dimensions, page 44



For Canadian Pricing
 Multiply U.S. Price by the Canadian price factor.
 ▶ See page 1 for details.

Think 465 Series Work Chairs

Armless, 3D Knit with Sewn Upholstery on Seat

Think 465 Series
Work Chairs



Standard Includes		Required to Specify
<ul style="list-style-type: none"> ▶ Need help? Product details, page 40 	<ul style="list-style-type: none"> • 5" pneumatic seat-height adjustment (16"–21") • Your Preference control • Passive seat edge angle • Frame, seat shell, and five-arm plastic base • 2" seat depth adjustment • 3D Knit on back • Sewn upholstery design on seat: fabric price group 1 • 2½"-diameter, hard-composition, dual-wheel casters: black 	<ol style="list-style-type: none"> 1 Style number 2 Plastic color for frame, seat shell, and base 3 3D Knit color for back 4 Fabric color number for upholstery on seat 5 Options, if selected (see below) <ul style="list-style-type: none"> ▶ See <i>Surface Materials</i>, page 264.

	Options	U.S. Price	Required to Specify
Surface Materials	Upholstery		
	• Fabric price group 1	No cost	Specify fabric color number.
	• Fabric price group 2	+\$ 10	Specify fabric color number.
	• Fabric price group 3	+\$ 22	Specify fabric color number.
	• Fabric price group 4	+\$ 30	Specify fabric color number.
	• Fabric price group 5	+\$ 37	Specify fabric color number.
	• Fabric price group 6	+\$ 46	Specify fabric color number.
	• Fabric price group 7	+\$ 54	Specify fabric color number.
	• Fabric price group 8	+\$ 68	Specify fabric color number.
	• Fabric price group 9	+\$ 83	Specify fabric color number.
	• Fabric price group 10	+\$ 95	Specify fabric color number.
	• Steelcase leather upholstery	+\$150	Specify leather color number.
	• Elmosoft leather upholstery	+\$173	Specify Elmosoft leather color number.
• Customer's Own Material (COM), Customer's Own Vinyl (COV), or Customer's Own Leather (COL)	No cost	▶ See <i>Surface Materials Reference Manual</i> .	
• Fire Code Seating (FCS)	+\$ 32	Add suffix F to the style number.	
• Soil-retardant treatment applied to upholstery fabric	+\$ 21	Specify with soil-retardant treatment.	
	Platinum		
	• On frame, base, and arm retainer	+\$ 78	Specify with 6249 Platinum.
Base	• Polished aluminum base	+\$130	Specify with aluminum base.
Seat Height	• 4" pneumatic seat-height adjustment (15"–19")	+\$ 52	Specify with 4" pneumatic seat-height adjustment.
Headrest	• Headrest	+\$156	Specify with headrest.
Lumbar Height	• 4¼" travel for additional lumbar support	+\$ 52	Specify with adjustable lumbar height.
Enclosed Back	• Enclosed back	+\$ 88	Specify with enclosed back.
Casters	• Soft, dual-wheel roll-control casters for use on hard floors	+\$ 21	Specify with soft roll-control casters.

Tip: Fire Code Seating (FCS) option is not available on 3D Knit models with lumbar height or enclosed back option.

▶ See pages 270–271 for upholstery fabric choices.

Specification Information

Style Number	U.S. Base Price
46542000	\$896

▶ Detailed dimensions, page 44



For Canadian Pricing

Multiply U.S. Price by the Canadian price factor.

▶ See page 1 for details.

Think 465 Series Work Chairs

Armless, Standard Upholstery



Tip: Fire Code Seating (FCS) option is not available on models with enclosed back option.

▶ See pages 270–271 for upholstery fabric choices.

Standard Includes		Required to Specify
▶ Need help? Product details, page 40	<ul style="list-style-type: none"> • 5" pneumatic seat-height adjustment (16"–21") • Your Preference™ control • Passive seat edge angle • Frame, seat shell, and five-arm plastic base • 2" seat depth adjustment • Standard upholstery design: fabric price group 1 • 2½"-diameter, hard-composition, dual-wheel casters: black 	<ol style="list-style-type: none"> 1 Style number 2 Plastic color for frame, seat shell, and base 3 Fabric color number for upholstery on seat and back 4 Options, if selected (see below) <p>▶ See <i>Surface Materials</i>, page 264.</p>

	Options	U.S. Price	Required to Specify
Surface Materials	Upholstery		
	• Fabric price group 1	No cost	Specify fabric color number.
	• Fabric price group 2	+\$ 22	Specify fabric color number.
	• Fabric price group 3	+\$ 43	Specify fabric color number.
	• Fabric price group 4	+\$ 59	Specify fabric color number.
	• Fabric price group 5	+\$ 75	Specify fabric color number.
	• Fabric price group 6	+\$ 92	Specify fabric color number.
	• Fabric price group 7	+\$107	Specify fabric color number.
	• Fabric price group 8	+\$134	Specify fabric color number.
	• Fabric price group 9	+\$166	Specify fabric color number.
	• Fabric price group 10	+\$187	Specify fabric color number.
	• Customer's Own Material (COM)	No cost	▶ See <i>Surface Materials Reference Manual</i> .
	• Fire Code Seating (FCS)	+\$ 64	Add suffix F to the style number.
• Soil-retardant treatment applied to upholstery fabric	+\$ 21	Specify <i>with soil-retardant treatment</i> .	
	Platinum		
	• On frame, base, and arm retainer	+\$ 78	Specify <i>with 6249 Platinum</i> .
Base	• Polished aluminum base	+\$130	Specify <i>with aluminum base</i> .
Seat Height	• 4" pneumatic seat-height adjustment (15"–19")	+\$ 52	Specify <i>with 4" pneumatic seat-height adjustment</i> .
Headrest	• Headrest	+\$156	Specify <i>with headrest</i> .
Lumbar Height	• 4¼" travel for additional lumbar support	+\$ 52	Specify <i>with adjustable lumbar height</i> .
Enclosed Back	• Enclosed back	+\$ 88	Specify <i>with enclosed back</i> .
Casters	• Soft, dual-wheel roll-control casters for use on hard floors	+\$ 21	Specify <i>with soft roll-control casters</i> .

Specification Information	
Style Number	U.S. Base Price
46540000	\$808
.	.

▶ Detailed dimensions, page 44



For Canadian Pricing

Multiply U.S. Price by the Canadian price factor.

▶ See page 1 for details.

Think 465 Series Work Chairs

Armless, Sewn Upholstery

Think 465 Series
Work Chairs



Standard Includes		Required to Specify
<ul style="list-style-type: none"> ▶ Need help? Product details, page 40 	<ul style="list-style-type: none"> • 5" pneumatic seat-height adjustment (16"–21") • Your Preference™ control • Passive seat edge angle • Frame, seat shell, and five-arm plastic base • 2" seat depth adjustment • Sewn upholstery design: fabric price group 1 • 2½"-diameter, hard-composition, dual-wheel casters: black 	<ol style="list-style-type: none"> 1 Style number 2 Plastic color for frame, seat shell, and base 3 Fabric color number for upholstery on seat and back 4 Options, if selected (see below) <ul style="list-style-type: none"> ▶ See <i>Surface Materials</i>, page 264.

Options	U.S. Price	Required to Specify
Surface Materials Upholstery <ul style="list-style-type: none"> • Fabric price group 1 • Fabric price group 2 • Fabric price group 3 • Fabric price group 4 • Fabric price group 5 • Fabric price group 6 • Fabric price group 7 • Fabric price group 8 • Fabric price group 9 • Fabric price group 10 • Steelcase leather upholstery • Elmosoft leather upholstery • Steelcase vinyl • Customer's Own Material (COM) • Customer's Own Vinyl (COV) • Customer's Own Leather (COL) • Fire Code Seating (FCS) • Soil-retardant treatment applied to upholstery fabric 	<ul style="list-style-type: none"> No cost +\$ 22 +\$ 43 +\$ 59 +\$ 75 +\$ 92 +\$107 +\$134 +\$166 +\$187 +\$294 +\$340 No cost No cost No cost +\$ 64 +\$ 21 	<ul style="list-style-type: none"> Specify fabric color number. Specify fabric color number. Specify fabric color number. Specify fabric color number. Specify fabric color number. Specify fabric color number. Specify fabric color number. Specify fabric color number. Specify fabric color number. Specify fabric color number. Specify leather color number. Specify Elmosoft leather color number. Specify vinyl color number. <ul style="list-style-type: none"> ▶ See <i>Surface Materials Reference Manual</i>. Specify vinyl color number. Specify leather color number. Add suffix F to the style number. Specify with soil-retardant treatment.
Platinum <ul style="list-style-type: none"> • On frame, base, and arm retainer 	<ul style="list-style-type: none"> +\$ 78 	<ul style="list-style-type: none"> Specify with 6249 Platinum.
Base <ul style="list-style-type: none"> • Polished aluminum base 	<ul style="list-style-type: none"> +\$130 	<ul style="list-style-type: none"> Specify with aluminum base.
Seat Height <ul style="list-style-type: none"> • 4" pneumatic seat-height adjustment (15"–19") 	<ul style="list-style-type: none"> +\$ 52 	<ul style="list-style-type: none"> Specify with 4" pneumatic seat-height adjustment.
Headrest <ul style="list-style-type: none"> • Headrest 	<ul style="list-style-type: none"> +\$156 	<ul style="list-style-type: none"> Specify with headrest.
Lumbar Height <ul style="list-style-type: none"> • 4¼" travel for additional lumbar support 	<ul style="list-style-type: none"> +\$ 52 	<ul style="list-style-type: none"> Specify with adjustable lumbar height.
Enclosed Back <ul style="list-style-type: none"> • Enclosed back 	<ul style="list-style-type: none"> +\$ 88 	<ul style="list-style-type: none"> Specify with enclosed back.
Casters <ul style="list-style-type: none"> • Soft, dual-wheel roll-control casters for use on hard floors 	<ul style="list-style-type: none"> +\$ 21 	<ul style="list-style-type: none"> Specify with soft roll-control casters.

Tip: Always add suffixes in alphabetical order when specifying options to Think seating.

Tip: Fire Code Seating (FCS) option is not available on models with enclosed back option.

▶ See pages 270–271 for upholstery fabric choices

Specification Information

Style Number	U.S. Base Price
46541000S	\$876

46541000S \$876

▶ Detailed dimensions, page 44



For Canadian Pricing

Multiply U.S. Price by the Canadian price factor.

▶ See page 1 for details.

Think 465 Series Stool

With Arms, 3D Knit with Standard Upholstery on Seat



	Standard Includes	Required to Specify
▶ Need help? Product details, page 40	<ul style="list-style-type: none"> • 10" pneumatic seat-height adjustment (22³/₄"–32³/₄") • Your Preference control • Passive seat edge angle • Frame, seat shell, and five-arm painted aluminum base • 2" seat depth adjustment • Height-, width-, pivot-, and depth-adjustable arms • Column and adjustable foot ring: black • 3D Knit on back • Standard upholstery design on seat: fabric price group 1 • 2½"-diameter, hard-composition, dual-wheel casters: black 	<ol style="list-style-type: none"> 1 Style number 2 Plastic color for frame, seat shell, and base 3 3D Knit color for back 4 Fabric color number for upholstery on seat 5 Options, if selected (see below) <p>▶ See <i>Surface Materials</i>, page 264.</p>

	Options	U.S. Price	Required to Specify
Surface Materials	Upholstery		
	• Fabric price group 1	No cost	Specify fabric color number.
	• Fabric price group 2	+\$ 10	Specify fabric color number.
	• Fabric price group 3	+\$ 22	Specify fabric color number.
	• Fabric price group 4	+\$ 30	Specify fabric color number.
	• Fabric price group 5	+\$ 37	Specify fabric color number.
	• Fabric price group 6	+\$ 46	Specify fabric color number.
	• Fabric price group 7	+\$ 54	Specify fabric color number.
	• Fabric price group 8	+\$ 68	Specify fabric color number.
	• Fabric price group 9	+\$ 83	Specify fabric color number.
• Fabric price group 10	+\$ 95	Specify fabric color number.	
• Customer's Own Material (COM)	No cost	▶ See <i>Surface Materials Reference Manual</i> .	
• Fire Code Seating (FCS)	+\$ 32	Add suffix F to the style number.	
• Soil-retardant treatment applied to upholstery fabric	+\$ 21	Specify <i>with soil-retardant treatment</i> .	
	Platinum		
	• On frame, base, and arm retainer	+\$ 78	Specify <i>with 6249 Platinum</i> .
Arms	• Fixed arms	–\$ 89	Specify <i>with fixed arms</i> .
Base	• Polished aluminum base	+\$130	Specify <i>with aluminum base</i> .
Headrest	• Headrest	+\$156	Specify <i>with headrest</i> .
Lumbar Height	• 4¼" travel for additional lumbar support	+\$ 52	Specify <i>with adjustable lumbar height</i> .
Enclosed Back	• Enclosed back	+\$ 88	Specify <i>with enclosed back</i> .
Casters	• Soft, dual-wheel roll-control casters for use on hard floors	+\$ 21	Specify <i>with soft roll-control casters</i> .

Tip: Fire Code Seating (FCS) option is not available on 3D Knit models with lumbar height or enclosed back option.

▶ See pages 270–271 for upholstery fabric choices.

Specification Information

• Style Number	• U.S. Base Price
46533100	\$1312

▶ Detailed dimensions, page 44



For Canadian Pricing

Multiply U.S. Price by the Canadian price factor.

▶ See page 1 for details.

Think 465 Series Stool

Think 465 Series Stool

With Arms, 3D Knit with Sewn Upholstery on Seat



Standard Includes		Required to Specify
<ul style="list-style-type: none"> ▶ Need help? Product details, page 40 	<ul style="list-style-type: none"> • 10" pneumatic seat-height adjustment (22³/₄"–32³/₄" • Your Preference control • Passive seat edge angle • Frame, seat shell, and five-arm painted aluminum base • 2" seat depth adjustment • Height-, width-, pivot-, and depth-adjustable arms • Column and adjustable foot ring: black • 3D Knit on back • Sewn upholstery design on seat: fabric price group 1 • 2½"-diameter, hard-composition, dual-wheel casters: black 	<ol style="list-style-type: none"> 1 Style number 2 Plastic color for frame, seat shell, and base 3 3D Knit color for back 4 Fabric color number for upholstery on seat 5 Options, if selected (see below) <ul style="list-style-type: none"> ▶ See <i>Surface Materials</i>, page 264.

Tip: Fire Code Seating (FCS) option is not available on 3D Knit models with lumbar height or enclosed back option.

▶ See pages 270–271 for upholstery fabric choices.

Options	U.S. Price	Required to Specify
Surface Materials	Upholstery	
<ul style="list-style-type: none"> • Fabric price group 1 • Fabric price group 2 • Fabric price group 3 • Fabric price group 4 • Fabric price group 5 • Fabric price group 6 • Fabric price group 7 • Fabric price group 8 • Fabric price group 9 • Fabric price group 10 • Steelcase leather upholstery • Elmosoft leather upholstery • Customer's Own Material (COM), Customer's Own Vinyl (COV), or Customer's Own Leather (COL) • Fire Code Seating (FCS) • Soil-retardant treatment applied to upholstery fabric 	No cost +\$ 10 +\$ 22 +\$ 30 +\$ 37 +\$ 46 +\$ 54 +\$ 68 +\$ 83 +\$ 95 +\$150 +\$173 No cost +\$ 32 +\$ 21	Specify fabric color number. Specify fabric color number. Specify fabric color number. Specify fabric color number. Specify fabric color number. Specify fabric color number. Specify fabric color number. Specify fabric color number. Specify fabric color number. Specify leather color number. Specify Elmosoft leather color number. ▶ See <i>Surface Materials Reference Manual</i> . Add suffix F to the style number. Specify <i>with soil-retardant treatment</i> .
	Platinum	
	<ul style="list-style-type: none"> • On frame, base, and arm retainer 	+\$ 78 Specify <i>with 6249 Platinum</i> .
Arms	<ul style="list-style-type: none"> • Fixed arms 	–\$ 89 Specify <i>with fixed arms</i> .
Base	<ul style="list-style-type: none"> • Polished aluminum base 	+\$130 Specify <i>with aluminum base</i> .
Headrest	<ul style="list-style-type: none"> • Headrest 	+\$156 Specify <i>with headrest</i> .
Lumbar Height	<ul style="list-style-type: none"> • 4¼" travel for additional lumbar support 	+\$ 52 Specify <i>with adjustable lumbar height</i> .
Enclosed Back	<ul style="list-style-type: none"> • Enclosed back 	+\$ 88 Specify <i>with enclosed back</i> .
Casters	<ul style="list-style-type: none"> • Soft, dual-wheel roll-control casters for use on hard floors 	+\$ 21 Specify <i>with soft roll-control casters</i> .

Specification Information	
Style Number	U.S. Base Price
46532100	\$1348

▶ Detailed dimensions, page 44



For Canadian Pricing
 Multiply U.S. Price by the Canadian price factor.
 ▶ See page 1 for details.

Think 465 Series Stool

With Arms, Standard Upholstery



Standard Includes		Required to Specify
<ul style="list-style-type: none"> ▶ Need help? Product details, page 40 	<ul style="list-style-type: none"> • 10" pneumatic seat-height adjustment (22³/₄"–32³/₄") • Your Preference control • Passive seat edge angle • Frame, seat shell, and five-arm painted aluminum base • 2" seat depth adjustment • Height-, width-, pivot-, and depth-adjustable arms • Column and adjustable foot ring: black • Standard upholstery design: fabric price group 1 • 2½"-diameter, hard-composition, dual-wheel casters: black 	<ol style="list-style-type: none"> 1 Style number 2 Plastic color for frame, seat shell, and base 3 Fabric color number for upholstery on seat and back 4 Options, if selected (see below) <ul style="list-style-type: none"> ▶ See <i>Surface Materials</i>, page 264.

Tip: Fire Code Seating (FCS) option is not available on models with enclosed back option.

▶ See pages 270–271 for upholstery fabric choices.

Options	U.S. Price	Required to Specify
Surface Materials <ul style="list-style-type: none"> • Upholstery • Fabric price group 1 • Fabric price group 2 • Fabric price group 3 • Fabric price group 4 • Fabric price group 5 • Fabric price group 6 • Fabric price group 7 • Fabric price group 8 • Fabric price group 9 • Fabric price group 10 • Customer's Own Material (COM) • Fire Code Seating (FCS) • Soil-retardant treatment applied to upholstery fabric 	No cost +\$ 22 +\$ 43 +\$ 59 +\$ 75 +\$ 92 +\$107 +\$134 +\$166 +\$187 No cost +\$ 64 +\$ 21	Specify fabric color number. Specify fabric color number. Specify fabric color number. Specify fabric color number. Specify fabric color number. Specify fabric color number. Specify fabric color number. Specify fabric color number. Specify fabric color number. Specify fabric color number. Specify fabric color number. ▶ See <i>Surface Materials Reference Manual</i> . Add suffix F to the style number. Specify with soil-retardant treatment.
Platinum <ul style="list-style-type: none"> • On frame, base, and arm retainer 	+\$ 78	Specify with 6249 Platinum.
Arms <ul style="list-style-type: none"> • Fixed arms 	–\$ 89	Specify with fixed arms.
Base <ul style="list-style-type: none"> • Polished aluminum base 	+\$130	Specify with aluminum base.
Headrest <ul style="list-style-type: none"> • Headrest 	+\$156	Specify with headrest.
Lumbar Height <ul style="list-style-type: none"> • 4¼" travel for additional lumbar support 	+\$ 52	Specify with adjustable lumbar height.
Enclosed Back <ul style="list-style-type: none"> • Enclosed back 	+\$ 88	Specify with enclosed back.
Casters <ul style="list-style-type: none"> • Soft, dual-wheel roll-control casters for use on hard floors 	+\$ 21	Specify with soft roll-control casters.

Specification Information	
Style Number	U.S. Base Price
46530100	\$1260

▶ Detailed dimensions, page 44



For Canadian Pricing

Multiply U.S. Price by the Canadian price factor.

▶ See page 1 for details.

Think 465 Series Stool

With Arms, Sewn Upholstery

Think 465 Series Stool



▶ Need help?
Product details,
page 40

Standard Includes

- 10" pneumatic seat-height adjustment (22³/₄"–32³/₄")
- Your Preference control
- Passive seat edge angle
- Frame, seat shell, and five-arm painted aluminum base
- 2" seat depth adjustment
- Height-, width-, pivot-, and depth-adjustable arms
- Column and adjustable foot ring: black
- Sewn upholstery design: fabric price group 1
- 2¹/₂"-diameter, hard-composition, dual-wheel casters: black

Required to Specify

- 1 Style number
 - 2 Plastic color for frame, seat shell, and base
 - 3 Fabric color number for upholstery on seat and back
 - 4 Options, if selected (see below)
- ▶ See *Surface Materials*, page 264.

Tip: Always add suffixes in alphabetical order when specifying options to Think seating.

Tip: Fire Code Seating (FCS) option is not available on models with enclosed back option.

▶ See pages 270–271 for upholstery fabric choices.

	Options	U.S. Price	Required to Specify
Surface Materials	Upholstery		
	• Fabric price group 1	No cost	Specify fabric color number.
	• Fabric price group 2	+\$ 22	Specify fabric color number.
	• Fabric price group 3	+\$ 43	Specify fabric color number.
	• Fabric price group 4	+\$ 59	Specify fabric color number.
	• Fabric price group 5	+\$ 75	Specify fabric color number.
	• Fabric price group 6	+\$ 92	Specify fabric color number.
	• Fabric price group 7	+\$107	Specify fabric color number.
	• Fabric price group 8	+\$134	Specify fabric color number.
	• Fabric price group 9	+\$166	Specify fabric color number.
	• Fabric price group 10	+\$187	Specify fabric color number.
	• Steelcase leather upholstery	+\$294	Specify leather color number.
	• Elmosoft leather upholstery	+\$340	Specify Elmosoft leather color number.
	• Steelcase vinyl	No cost	Specify vinyl color number.
• Customer's Own Material (COM)	No cost	▶ See <i>Surface Materials Reference Manual</i> .	
• Customer's Own Vinyl (COV)	No cost	Specify vinyl color number.	
• Customer's Own Leather (COL)	No cost	Specify leather color number.	
• Fire Code Seating (FCS)	+\$ 64	Add suffix F to the style number.	
• Soil-retardant treatment applied to upholstery fabric	+\$ 21	Specify with <i>soil-retardant treatment</i> .	
	Platinum		
	• On frame, base, and arm retainer	+\$ 78	Specify with <i>6249 Platinum</i> .
Arms	• Fixed arms	–\$ 89	Specify with <i>fixed arms</i> .
Base	• Polished aluminum base	+\$130	Specify with <i>aluminum base</i> .
Headrest	• Headrest	+\$156	Specify with <i>headrest</i> .
Lumbar Height	• 4 ¹ / ₄ " travel for additional lumbar support	+\$ 52	Specify with <i>adjustable lumbar height</i> .
Enclosed Back	• Enclosed back	+\$ 88	Specify with <i>enclosed back</i> .
Casters	• Soft, dual-wheel roll-control casters for use on hard floors	+\$ 21	Specify with <i>soft roll-control casters</i> .

Specification Information

Style Number	U.S. Base Price
46531100S	\$1328

▶ Detailed dimensions, page 44

 **For Canadian Pricing**
Multiply U.S. Price by the Canadian price factor.
▶ See page 1 for details.

Think 465 Series Stool

Armless, 3D Knit with Standard Upholstery on Seat



Standard Includes		Required to Specify
<ul style="list-style-type: none"> ▶ Need help? Product details, page 40 	<ul style="list-style-type: none"> • 10" pneumatic seat-height adjustment (22³/₄"–32³/₄") • Your Preference control • Passive seat edge angle • Frame, seat shell, and five-arm painted aluminum base • 2" seat depth adjustment • Column and adjustable foot ring: black • 3D Knit on back • Standard upholstery design on seat: fabric price group 1 • 2½"-diameter, hard-composition, dual-wheel casters: black 	<ul style="list-style-type: none"> 1 Style number 2 Plastic color for frame, seat shell, and base 3 3D Knit color for back 4 Fabric color number for upholstery on seat 5 Options, if selected (see below) ▶ See <i>Surface Materials</i>, page 264.

Options		U.S. Price	Required to Specify
Surface Materials	Upholstery		
	• Fabric price group 1	No cost	Specify fabric color number.
	• Fabric price group 2	+\$ 10	Specify fabric color number.
	• Fabric price group 3	+\$ 22	Specify fabric color number.
	• Fabric price group 4	+\$ 30	Specify fabric color number.
	• Fabric price group 5	+\$ 37	Specify fabric color number.
	• Fabric price group 6	+\$ 46	Specify fabric color number.
	• Fabric price group 7	+\$ 54	Specify fabric color number.
	• Fabric price group 8	+\$ 68	Specify fabric color number.
	• Fabric price group 9	+\$ 83	Specify fabric color number.
	• Fabric price group 10	+\$ 95	Specify fabric color number.
	• Customer's Own Material (COM)	No cost	▶ See <i>Surface Materials Reference Manual</i> .
	• Fire Code Seating (FCS)	+\$ 32	Add suffix F to the style number.
• Soil-retardant treatment applied to upholstery fabric	+\$ 21	Specify with <i>soil-retardant treatment</i> .	
	Platinum		
	• On frame, base, and arm retainer	+\$ 78	Specify with <i>6249 Platinum</i> .
Base	• Polished aluminum base	+\$130	Specify with <i>aluminum base</i> .
Headrest	• Headrest	+\$156	Specify with <i>headrest</i> .
Lumbar Height	• 4¼" travel for additional lumbar support	+\$ 52	Specify with <i>adjustable lumbar height</i> .
Enclosed Back	• Enclosed back	+\$ 88	Specify with <i>enclosed back</i> .
Casters	• Soft, dual-wheel roll-control casters for use on hard floors	+\$ 21	Specify with <i>soft roll-control casters</i> .

Tip: Fire Code Seating (FCS) option is not available on 3D Knit models with lumbar height or enclosed back option.

▶ See pages 270–271 for upholstery fabric choices.

Specification Information

Style Number	U.S. Base Price
46533000	\$1083

▶ Detailed dimensions, page 44



For Canadian Pricing

Multiply U.S. Price by the Canadian price factor.

▶ See page 1 for details.

Think 465 Series Stool

Think 465 Series Stool

Armless, 3D Knit with Sewn Upholstery on Seat



	Standard Includes	Required to Specify
▶ Need help? Product details, page 40	<ul style="list-style-type: none"> • 10" pneumatic seat-height adjustment (22³/₄"–32³/₄") • Your Preference control • Passive seat edge angle • Frame, seat shell, and five-arm painted aluminum base • 2" seat depth adjustment • Column and adjustable foot ring: black • 3D Knit on back • Sewn upholstery design on seat: fabric price group 1 • 2½"-diameter, hard-composition, dual-wheel casters: black 	<ol style="list-style-type: none"> 1 Style number 2 Plastic color for frame, seat shell, and base 3 3D Knit color for back 4 Fabric color number for upholstery on seat 5 Options, if selected (see below) <p>▶ See <i>Surface Materials</i>, page 264.</p>

Tip: Fire Code Seating (FCS) option is not available on 3D Knit models with lumbar height or enclosed back option.

▶ See pages 270–271 for upholstery fabric choices.

	Options	U.S. Price	Required to Specify
Surface Materials	Upholstery <ul style="list-style-type: none"> • Fabric price group 1 • Fabric price group 2 • Fabric price group 3 • Fabric price group 4 • Fabric price group 5 • Fabric price group 6 • Fabric price group 7 • Fabric price group 8 • Fabric price group 9 • Fabric price group 10 • Steelcase leather upholstery • Elmosoft leather upholstery • Customer's Own Material (COM), Customer's Own Vinyl (COV), or Customer's Own Leather (COL) • Fire Code Seating (FCS) • Soil-retardant treatment applied to upholstery fabric Platinum <ul style="list-style-type: none"> • On frame, base, and arm retainer 	No cost +\$ 10 +\$ 22 +\$ 30 +\$ 37 +\$ 46 +\$ 54 +\$ 68 +\$ 83 +\$ 95 +\$150 +\$173 No cost +\$ 32 +\$ 21 +\$ 78	Specify fabric color number. Specify fabric color number. Specify fabric color number. Specify fabric color number. Specify fabric color number. Specify fabric color number. Specify fabric color number. Specify fabric color number. Specify fabric color number. Specify fabric color number. Specify leather color number. Specify Elmosoft leather color number. ▶ See <i>Surface Materials Reference Manual</i> . Add suffix F to the style number. Specify with <i>soil-retardant treatment</i> . Specify with <i>6249 Platinum</i> .
Base	<ul style="list-style-type: none"> • Polished aluminum base 	+\$130	Specify with <i>aluminum base</i> .
Headrest	<ul style="list-style-type: none"> • Headrest 	+\$156	Specify with <i>headrest</i> .
Lumbar Height	<ul style="list-style-type: none"> • 4¼" travel for additional lumbar support 	+\$ 52	Specify with <i>adjustable lumbar height</i> .
Enclosed Back	<ul style="list-style-type: none"> • Enclosed back 	+\$ 88	Specify with <i>enclosed back</i> .
Casters	<ul style="list-style-type: none"> • Soft, dual-wheel roll-control casters for use on hard floors 	+\$ 21	Specify with <i>soft roll-control casters</i> .

Specification Information

Style Number	U.S. Base Price
46532000	\$1119
:	:

▶ Detailed dimensions, page 44



For Canadian Pricing

Multiply U.S. Price by the Canadian price factor.

▶ See page 1 for details.

Think 465 Series Stool

Armless, Standard Upholstery



Standard Includes		Required to Specify
<ul style="list-style-type: none"> ▶ Need help? Product details, page 40 	<ul style="list-style-type: none"> • 10" pneumatic seat-height adjustment (22³/₄"–32³/₄" • Your Preference control • Passive seat edge angle • Frame, seat shell, and five-arm painted aluminum base • 2" seat depth adjustment • Column and adjustable foot ring: black • Standard upholstery design: fabric price group 1 • 2½"-diameter, hard-composition, dual-wheel casters: black 	<ol style="list-style-type: none"> 1 Style number 2 Plastic color for frame, seat shell, and base 3 Fabric color number for upholstery on seat and back 4 Options, if selected (see below) <ul style="list-style-type: none"> ▶ See <i>Surface Materials</i>, page 264.

Options	U.S. Price	Required to Specify
Surface Materials Upholstery <ul style="list-style-type: none"> • Fabric price group 1 • Fabric price group 2 • Fabric price group 3 • Fabric price group 4 • Fabric price group 5 • Fabric price group 6 • Fabric price group 7 • Fabric price group 8 • Fabric price group 9 • Fabric price group 10 • Customer's Own Material (COM) • Fire Code Seating (FCS) • Soil-retardant treatment applied to upholstery fabric 	<ul style="list-style-type: none"> No cost +\$ 22 +\$ 43 +\$ 59 +\$ 75 +\$ 92 +\$107 +\$134 +\$166 +\$187 No cost +\$ 64 +\$ 21 	<ul style="list-style-type: none"> Specify fabric color number. Specify fabric color number. Specify fabric color number. Specify fabric color number. Specify fabric color number. Specify fabric color number. Specify fabric color number. Specify fabric color number. Specify fabric color number. Specify fabric color number. ▶ See <i>Surface Materials Reference Manual</i>. Add suffix F to the style number. Specify with soil-retardant treatment.
Platinum <ul style="list-style-type: none"> • On frame, base, and arm retainer 	<ul style="list-style-type: none"> +\$ 78 	<ul style="list-style-type: none"> Specify with 6249 Platinum.
Base <ul style="list-style-type: none"> • Polished aluminum base 	<ul style="list-style-type: none"> +\$130 	<ul style="list-style-type: none"> Specify with aluminum base.
Headrest <ul style="list-style-type: none"> • Headrest 	<ul style="list-style-type: none"> +\$156 	<ul style="list-style-type: none"> Specify with headrest.
Lumbar Height <ul style="list-style-type: none"> • 4¼" travel for additional lumbar support 	<ul style="list-style-type: none"> +\$ 52 	<ul style="list-style-type: none"> Specify with adjustable lumbar height.
Enclosed Back <ul style="list-style-type: none"> • Enclosed back 	<ul style="list-style-type: none"> +\$ 88 	<ul style="list-style-type: none"> Specify with enclosed back.
Casters <ul style="list-style-type: none"> • Soft, dual-wheel roll-control casters for use on hard floors 	<ul style="list-style-type: none"> +\$ 21 	<ul style="list-style-type: none"> Specify with soft roll-control casters.

Tip: Fire Code Seating (FCS) option is not available on models with enclosed back option.

▶ See pages 270–271 for upholstery fabric choices.

Specification Information	
Style Number	U.S. Base Price
46530000	\$1031

▶ Detailed dimensions, page 44



For Canadian Pricing

Multiply U.S. Price by the Canadian price factor.

▶ See page 1 for details.

Think 465 Series Stool

Think 465 Series Stool

Armless, Sewn Upholstery



Tip: Always add suffixes in alphabetical order when specifying options to Think seating.

Tip: Fire Code Seating (FCS) option is not available on models with enclosed back option.

▶ See pages 270–271 for upholstery fabric choices.

Standard Includes	Required to Specify
<ul style="list-style-type: none"> ▶ Need help? Product details, page 40 • 10" pneumatic seat-height adjustment (22³/₄"–32³/₄") • Your Preference control • Passive seat edge angle • Frame, seat shell, and five-arm painted aluminum base • 2" seat depth adjustment • Column and adjustable foot ring: black • Sewn upholstery design: fabric price group 1 • 2½"-diameter, hard-composition, dual-wheel casters: black 	<ol style="list-style-type: none"> 1 Style number 2 Plastic color for frame, seat shell, and base 3 Fabric color number for upholstery on seat and back 4 Options, if selected (see below) <p>▶ See <i>Surface Materials</i>, page 264.</p>

Options	U.S. Price	Required to Specify																																									
<table border="0"> <tr> <td>Surface Materials</td> <td> <ul style="list-style-type: none"> • Fabric price group 1 • Fabric price group 2 • Fabric price group 3 • Fabric price group 4 • Fabric price group 5 • Fabric price group 6 • Fabric price group 7 • Fabric price group 8 • Fabric price group 9 • Fabric price group 10 • Steelcase leather upholstery • Elmosoft leather upholstery • Steelcase vinyl • Customer's Own Material (COM) • Customer's Own Vinyl (COV) • Customer's Own Leather (COL) • Fire Code Seating (FCS) • Soil-retardant treatment applied to upholstery fabric </td> <td> <ul style="list-style-type: none"> No cost +\$ 22 +\$ 43 +\$ 59 +\$ 75 +\$ 92 +\$107 +\$134 +\$166 +\$187 +\$294 +\$340 No cost No cost No cost +\$ 64 +\$ 21 </td> <td> <ul style="list-style-type: none"> Specify fabric color number. Specify fabric color number. Specify fabric color number. Specify fabric color number. Specify fabric color number. Specify fabric color number. Specify fabric color number. Specify fabric color number. Specify fabric color number. Specify fabric color number. Specify leather color number. Specify Elmosoft leather color number. Specify vinyl color number. <p>▶ See <i>Surface Materials Reference Manual</i>. Specify vinyl color number. Specify leather color number. Add suffix F to the style number. Specify <i>with soil-retardant treatment</i>.</p> </td> </tr> <tr> <td>Upholstery</td> <td></td> <td></td> </tr> <tr> <td>Platinum</td> <td></td> <td></td> </tr> <tr> <td> <ul style="list-style-type: none"> • On frame, base, and arm retainer </td> <td>+\$ 78</td> <td>Specify <i>with 6249 Platinum</i>.</td> </tr> <tr> <td>Base</td> <td></td> <td></td> </tr> <tr> <td> <ul style="list-style-type: none"> • Polished aluminum base </td> <td>+\$130</td> <td>Specify <i>with aluminum base</i>.</td> </tr> <tr> <td>Headrest</td> <td></td> <td></td> </tr> <tr> <td> <ul style="list-style-type: none"> • Headrest </td> <td>+\$156</td> <td>Specify <i>with headrest</i>.</td> </tr> <tr> <td>Lumbar Height</td> <td></td> <td></td> </tr> <tr> <td> <ul style="list-style-type: none"> • 4¼" travel for additional lumbar support </td> <td>+\$ 52</td> <td>Specify <i>with adjustable lumbar height</i>.</td> </tr> <tr> <td>Enclosed Back</td> <td></td> <td></td> </tr> <tr> <td> <ul style="list-style-type: none"> • Enclosed back </td> <td>+\$ 88</td> <td>Specify <i>with enclosed back</i>.</td> </tr> <tr> <td>Casters</td> <td></td> <td></td> </tr> <tr> <td> <ul style="list-style-type: none"> • Soft, dual-wheel roll-control casters for use on hard floors </td> <td>+\$ 21</td> <td>Specify <i>with soft roll-control casters</i>.</td> </tr> </table>	Surface Materials	<ul style="list-style-type: none"> • Fabric price group 1 • Fabric price group 2 • Fabric price group 3 • Fabric price group 4 • Fabric price group 5 • Fabric price group 6 • Fabric price group 7 • Fabric price group 8 • Fabric price group 9 • Fabric price group 10 • Steelcase leather upholstery • Elmosoft leather upholstery • Steelcase vinyl • Customer's Own Material (COM) • Customer's Own Vinyl (COV) • Customer's Own Leather (COL) • Fire Code Seating (FCS) • Soil-retardant treatment applied to upholstery fabric 	<ul style="list-style-type: none"> No cost +\$ 22 +\$ 43 +\$ 59 +\$ 75 +\$ 92 +\$107 +\$134 +\$166 +\$187 +\$294 +\$340 No cost No cost No cost +\$ 64 +\$ 21 	<ul style="list-style-type: none"> Specify fabric color number. Specify fabric color number. Specify fabric color number. Specify fabric color number. Specify fabric color number. Specify fabric color number. Specify fabric color number. Specify fabric color number. Specify fabric color number. Specify fabric color number. Specify leather color number. Specify Elmosoft leather color number. Specify vinyl color number. <p>▶ See <i>Surface Materials Reference Manual</i>. Specify vinyl color number. Specify leather color number. Add suffix F to the style number. Specify <i>with soil-retardant treatment</i>.</p>	Upholstery			Platinum			<ul style="list-style-type: none"> • On frame, base, and arm retainer 	+\$ 78	Specify <i>with 6249 Platinum</i> .	Base			<ul style="list-style-type: none"> • Polished aluminum base 	+\$130	Specify <i>with aluminum base</i> .	Headrest			<ul style="list-style-type: none"> • Headrest 	+\$156	Specify <i>with headrest</i> .	Lumbar Height			<ul style="list-style-type: none"> • 4¼" travel for additional lumbar support 	+\$ 52	Specify <i>with adjustable lumbar height</i> .	Enclosed Back			<ul style="list-style-type: none"> • Enclosed back 	+\$ 88	Specify <i>with enclosed back</i> .	Casters			<ul style="list-style-type: none"> • Soft, dual-wheel roll-control casters for use on hard floors 	+\$ 21	Specify <i>with soft roll-control casters</i> .
Surface Materials	<ul style="list-style-type: none"> • Fabric price group 1 • Fabric price group 2 • Fabric price group 3 • Fabric price group 4 • Fabric price group 5 • Fabric price group 6 • Fabric price group 7 • Fabric price group 8 • Fabric price group 9 • Fabric price group 10 • Steelcase leather upholstery • Elmosoft leather upholstery • Steelcase vinyl • Customer's Own Material (COM) • Customer's Own Vinyl (COV) • Customer's Own Leather (COL) • Fire Code Seating (FCS) • Soil-retardant treatment applied to upholstery fabric 	<ul style="list-style-type: none"> No cost +\$ 22 +\$ 43 +\$ 59 +\$ 75 +\$ 92 +\$107 +\$134 +\$166 +\$187 +\$294 +\$340 No cost No cost No cost +\$ 64 +\$ 21 	<ul style="list-style-type: none"> Specify fabric color number. Specify fabric color number. Specify fabric color number. Specify fabric color number. Specify fabric color number. Specify fabric color number. Specify fabric color number. Specify fabric color number. Specify fabric color number. Specify fabric color number. Specify leather color number. Specify Elmosoft leather color number. Specify vinyl color number. <p>▶ See <i>Surface Materials Reference Manual</i>. Specify vinyl color number. Specify leather color number. Add suffix F to the style number. Specify <i>with soil-retardant treatment</i>.</p>																																								
Upholstery																																											
Platinum																																											
<ul style="list-style-type: none"> • On frame, base, and arm retainer 	+\$ 78	Specify <i>with 6249 Platinum</i> .																																									
Base																																											
<ul style="list-style-type: none"> • Polished aluminum base 	+\$130	Specify <i>with aluminum base</i> .																																									
Headrest																																											
<ul style="list-style-type: none"> • Headrest 	+\$156	Specify <i>with headrest</i> .																																									
Lumbar Height																																											
<ul style="list-style-type: none"> • 4¼" travel for additional lumbar support 	+\$ 52	Specify <i>with adjustable lumbar height</i> .																																									
Enclosed Back																																											
<ul style="list-style-type: none"> • Enclosed back 	+\$ 88	Specify <i>with enclosed back</i> .																																									
Casters																																											
<ul style="list-style-type: none"> • Soft, dual-wheel roll-control casters for use on hard floors 	+\$ 21	Specify <i>with soft roll-control casters</i> .																																									

Specification Information	
Style Number	U.S. Base Price
46531000S	\$1099
:	:
:	:

▶ Detailed dimensions, page 44



For Canadian Pricing

Multiply U.S. Price by the Canadian price factor.

▶ See page 1 for details.



Understanding and Specifying Amia 482 Series Work Chairs

Product Details

Amia 482 Series	64
Amia Upholstery	67
Dimensions	68

Specifying

Work Chairs

Sewn Leather Upholstery on Back, Seat, and Arm Caps	70
Upholstery on Back and Seat	72
3D Knit on Back with Upholstery on Seat	74

Stools

Upholstery on Back and Seat	76
3D Knit on Back with Upholstery on Seat	78

Work Chairs

Highly adjustable task seating offers maximum personalization for people who sit most of the day performing repetitive tasks. By making a series of simple adjustments, you can customize the chair to your body, preferences, and tasks. These chairs provide continuous, stable, task-oriented comfort, and can be quickly adjusted to support you in upright, forward, and reclining work postures.

- Leap 462 Series
- Leap 464 Series WorkLounge
- Criterion 453 Series
- Think 465 Series
- Amia 482 Series
- Reply 466 Series
- Drive 461 Series
- Jersey Series

Adjustability Features

▶ See page 12 for a comparison to other chairs. **Amia 482 Series**

Mechanisms

Syncrotilt ●

Seat Adjustments

Pneumatic height ●

Passive seat edge angle ●

Seat depth ●

Back Adjustments

Lumbar height ●

Back tension ●

Back lock ●

Arm Adjustments

Arm height ●

Arm width ●

Arm pivot ●

Arm depth ●

Other Features

Foot ring height (stool) ●

Amia 482 Series

Amia is for customers that value Alive seating principles and want a good ergonomic chair at a value price point.

Outer back and outer seat are plastic. Fully upholstered outer back is available.

LiveLumbar system offers a dialed in spring force in the lumbar region that actively supports the lower back.

Arm height can adjust independently within a 4" range to help relieve upper back and shoulder fatigue.

Seat depth adjusts within a 3" range. Seat depth is standard on all models.

Five-arm base is standard.

Casters have hard, dual-wheels that roll smoothly on carpets. They are 2½" for increased mobility. Soft, dual-wheel casters are available for use on hard floors or chair mats. Stools are standard with 2" hard casters. Soft casters are available as an option.

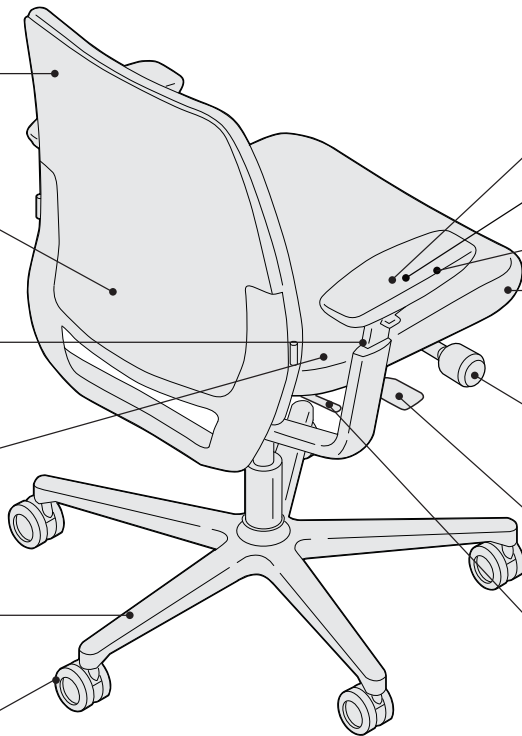

Arm depth can be adjusted approximately 3", enabling individuals to get closer to their work.

Arm width can adjust 4½" overall to provide forearm support.

Arm caps can pivot 30° in and out to accommodate individual user preferences.

Passive seat edge angle allows the front edge of the seat to flex 1½", relieving pressure behind the thighs.

Back tension accommodates a broader range of users by allowing user to change the rate of increase, or decrease, in force as the user reclines.

Seat height adjusts within a 5" range with a pneumatic adjustment mechanism. Stools have an 8" range.

Upright back lock allows the user to lock the back in a full upright position, or release it for full-tilt motion.

Product Details

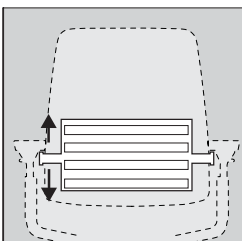

LiveLumbar system allows the user to experience continuous back support with dialed in spring force that can be adjusted to match the users anatomy.

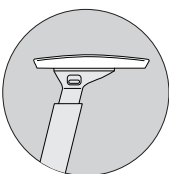

Rectilinear arms with soft caps are standard.

Models are standard with adjustable seats that include seat depth and passive seat edge angle.

Adjustability instructions are included with every chair. Instructions can also be found at steelcase.com

Cartoned request on your dealer purchase order force Amia chairs to ship knocked down with the chair back separated from the base and mechanism. This allows for shipment in a smaller carton. Assembly by a qualified dealer installer is required. Assembly instructions are included. This does not apply to Amia stools.

Uncartoned request on your dealer purchase order force Amia chairs to ship fully assembled.

Adjustment Features

Seat Adjustments

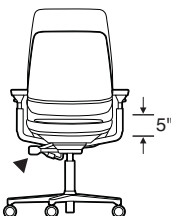

Seat height adjusts pneumatically. To lower, hold handle up while seated. To raise, hold handle up and keep your weight off the chair. Range of adjustability is 5", from 16"H to 21"H, and is standard on work chairs. A lower range of adjustability (15"H to 19"H) is available as an option. A higher range of adjustability (17"H to 24"H) is available as an option. An 8" range of adjustability (23"H to 31"H) is available on stools.

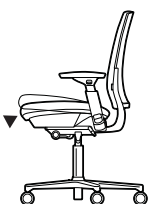

Seat edge flexes, relieving pressure under the user's thighs. The front flexes 1 1/2". This feature is standard on all work chairs and stools.

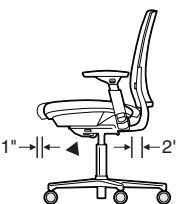

Seat depth adjusts 3" (15 1/2"-18 1/2") by pulling handle up. Slide seat forward or back to accommodate various leg lengths. Release handle to lock. This feature is standard on work chairs and stools.

Back Adjustments

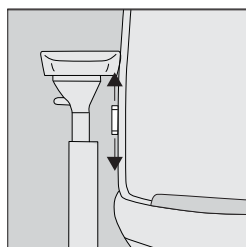

Lumbar height adjusts 3 3/4" (6 1/4" to 10" from seat) by grabbing exposed tabs and sliding the lumbar support up or down. This feature is standard on work chairs and stools.



Back tension adjusts by turning knob forward to increase back tension, backward to decrease back tension. This feature is standard on work chairs and stools.



Upright back lock. To release, lean forward and pull toward back. To lock, lean forward and push toward front.

Arm Adjustments

Rectilinear height-, width-, pivot-, and depth-adjustable arms come standard on all arm models of chairs and stools.

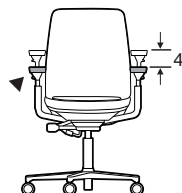

Arm height adjusts independently within a range of 4" (7"-11" from the seat). Push button on outside and under arm cap in while moving arms up or down. Releasing buttons locks arms in position.

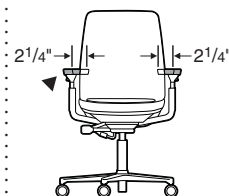

Arm width adjusts 2 1/4" each independently on chairs with this option. Grasp arm and move in or out.

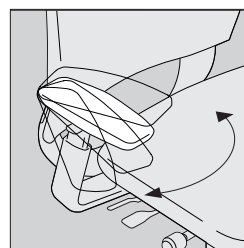

Arms pivot in and out 30° independently on models with adjustable-width arms. Grasp arm and push front to left or right.



Arm depth adjusts approximately 3" to enable user to get closer to worksurface.

Other Features

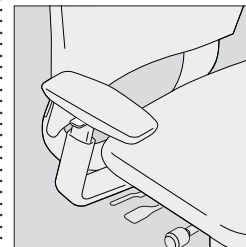

Height-only adjustable arm is also available and adjusts 4".



Armless models are also available.

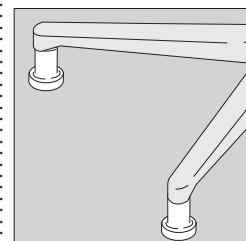

Glides are available as an option. Glides ship with chair or stool for field installation and maintain same height as casters.

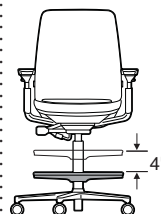

Foot ring height on stools adjusts by first lifting ring and rotating it counter-clockwise to unlock. Then raise or lower ring up to 4" to desired position before rotating it clockwise to lock. The foot ring has a diameter of 20".

Soft-wheel casters for hard floors are available for specific applications.

Surface Materials

▶ See surface materials on page 264 for specific availability or refer to the *Surface Materials Reference Manual* for further information.

Upholstery

- Fabric
- Fabric with soil-retardant treatment (option)
- 3D Knit (back only)
- Leather
- Vinyl

Hard components

(back frame, outer back, arm retainer, and base)

- 6205 Black
- 6249 Platinum

Outer Back

- Plastic color to match monochromatic color of other hard components
- Fully upholstered

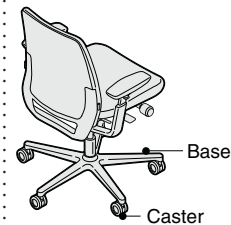

Polished aluminum base and casters

are available on chairs only. Polished aluminum casters approved to 225 pounds only. Stools are not available with this base.

Arm Caps

- Black
- Leather

Column and foot ring on stools

- 7207 Black only

All Steelcase seating with standard upholstery fabrics

complies with requirements of the State of California Technical Bulletin 117. All standard seating is labeled to be in compliance with California 117.

Programs & Services

▶ See the *Surface Materials Reference Manual* for further detail about programs and services offered for seating.

The Customer's Own Material (COM) Program

offers the opportunity for customers to select fabrics that are not offered through the standard Steelcase surface materials program for use on Steelcase products. Through the COM program, Steelcase will test your materials for application on Steelcase products. Once approved, you can place your order. Steelcase will facilitate the entire ordering process and give you a production schedule. Steelcase will order the COM fabric directly from the textile manufacturer. For up-to-date information regarding fabric test results for all COM fabrics and details regarding yardage requirements for most Seating lines, visit the COM Web site. To locate the COM Web site:

- Visit www.steelcase.com

Soil retardants are treatments that provide long-term soil and stain resistance to a fabric without affecting the shade or the integrity of the fabric. The following Steelcase Textiles are available pre-treated with soil retardant. (You do not need to select the soil-retardant option for these fabrics and incur the upcharge.)

- Jacks
- Link
- Spyder

For information on soil retardant fabrics on Select Surfaces, please refer to the *Surface Materials Reference Manual*.

Soil-retardant treatment is available on all other seating fabrics at an additional upcharge per seating unit. To order this option, please select "Soil-Retardant Treatment" under "Optional Accessories."

For soil-retardant treatment on COMs, please select "Soil-Retardant Treatment" under "Optional Accessories." Minimums or additional yardage may be required. Please contact the vendor directly for specific information.

Soil-retardant treatment is available on all other seating fabrics at an additional upcharge per seating unit. To order this option, please select "Soil-Retardant Treatment" under "Optional Accessories."

For soil-retardant treatment on COMs, please select "Soil-Retardant Treatment" under "Optional Accessories." Minimums or additional yardage may be required. Please contact the vendor directly for specific information.

Extended lead times may be necessary for this service.

Contact your Steelcase Solutions Fulfillment Team Representative at 1.888.STEELCASE (1.888.783.3522) or send an email to lineone@steelcase.com.

Fire Codes

▶ See pages 270–271 for upholstery fabrics available for use with FCS modification.

Steelcase offers Fire Code Seating modification (FCS) on nearly all seating models. The most rigorous fire codes in the nation have been developed in California, and the Steelcase FCS modification is designed to meet those codes. Fire Code Seating (FCS) indicates that a product is constructed to meet the strict fire code requirements of high public occupancy areas such as theaters, meeting rooms, and lobbies. The FCS standards will meet both the State of California Home Furnishing Technical Bulletin 133 (Cal TB 133) and Boston Fire Code (BFC). Boston adopted the California Home Furnishing Technical Bulletin TB 133 test standard in 1992.

Local codes may have special requirements for upholstery.

Dimensions

▶ Page 68

Resources

Printed Materials

- ▶ Amia Brochure (05-0002313)
- ▶ Amia Quick Reference Pocket Card
- ▶ Amia User Guide
- ▶ Innovation Seating Brochure (04-0011870)
- ▶ Alive Seating

Computer Tools

- ▶ Interactive User Guide available on www.steelcase.com
- ▶ Amia DVD

What Is It?

Fabric, leather, or vinyl-covered back and seat, 3D Knit back

Fabric

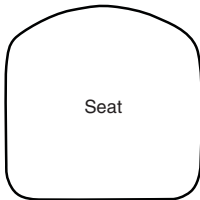
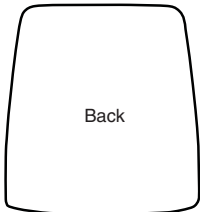

3D Knit Back

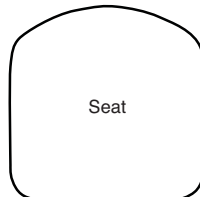
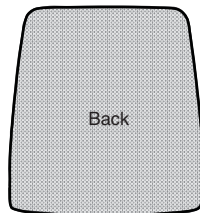

3D Knit back is made up of three layers: the 3D Knit, a solid fabric that matches the 3D Knit color, and the polyester cushion that provides exceptional comfort. The seat on these models can be specified to match the 3D Knit color or in any other material.

Leather, Vinyl, and Select Fabrics

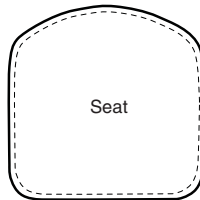
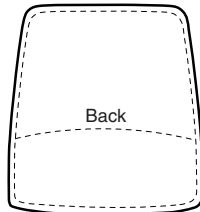

Stitched seams are included on the back cushion and seat cushion of the following:

- Leather
- Elmosoft leather
- Customer's Own Leather (COL)
- Vinyl
- Customer's Own Vinyl (COV)
- Select Customer's Own Material (COM)
- Select Fabrics

Pattern alignment at the lumbar seam cannot be guaranteed.

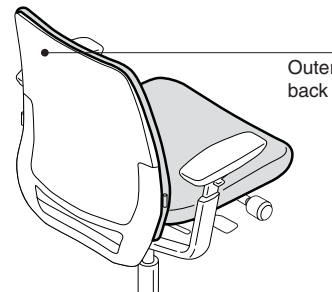
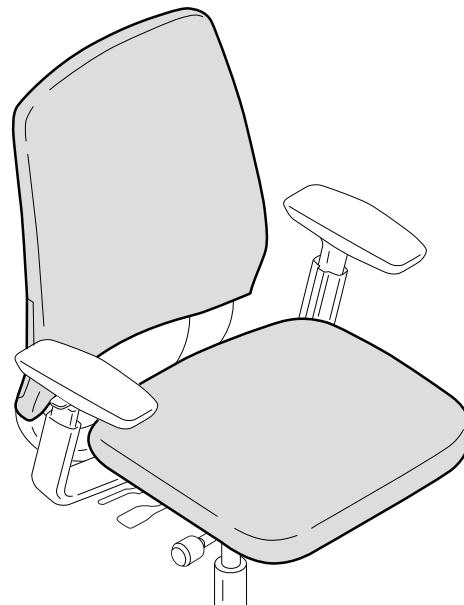

Plastic outer back is fully exposed. Fully upholstered outer back is available.

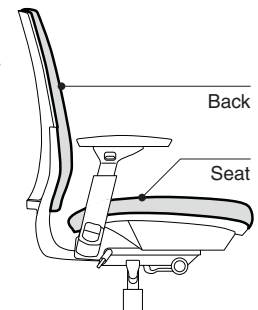

Seat and back cushions can be removed and replaced if damaged.

Dimensions

Amia 482 Series

Features	Overall Depth	Width	Height	Seat Depth	Functional Seat Depth	Seat Width	Seat Height from Floor	Back Width	Back Height from Seat
----------	---------------	-------	--------	------------	-----------------------	------------	------------------------	------------	-----------------------

Amia 482 Series

Work Chairs

Adjustable Seat Depth	21 ³ / ₄ " to 24 ³ / ₄ "	26 ⁵ / ₈ "	37 ¹ / ₄ " to 42 ¹ / ₂ "	18 ¹ / ₂ "	15 ¹ / ₂ " to 18 ¹ / ₂ "	19 ³ / ₈ "	16" to 21"	18 ⁷ / ₈ "	25"
-----------------------	--	----------------------------------	--	----------------------------------	--	----------------------------------	------------	----------------------------------	-----

Stools

Adjustable Seat Depth	21 ³ / ₄ " to 24 ³ / ₄ "	26 ⁵ / ₈ "	44 ¹ / ₄ " to 52 ¹ / ₂ "	18 ¹ / ₂ "	15 ¹ / ₂ " to 18 ¹ / ₂ "	19 ³ / ₈ "	23" to 31"	18 ⁷ / ₈ "	25"
-----------------------	--	----------------------------------	--	----------------------------------	--	----------------------------------	------------	----------------------------------	-----

Dimensions were measured with BIFMA CMD (chair-measuring device).

Arm width adjustment

is 15"–19¹/₂". Arm pivot adjustment adds 2³/₄" to the width providing a total of 12¹/₄"–20¹/₂" of width between the arms.

• Back Lumbar Height	• Lumbar Flex Zone	• Width Between Arms	• Arm to Floor	• Arm Height from Seat	• Arm Cap Pivot Range	• Seat Pan Angle	• Angle Between Seat and Back
Work Chairs							
6¼" to 10"	5¼" to 10¼"	15" to 19½"	22" to 32¼"	7" to 11"	30°	-3° to 3°	100° to 120°
Stools							
6¼" to 10"	5¼" to 10¼"	15" to 19½"	30" to 38"	7" to 11"	30°	-3° to 3°	100° to 120°

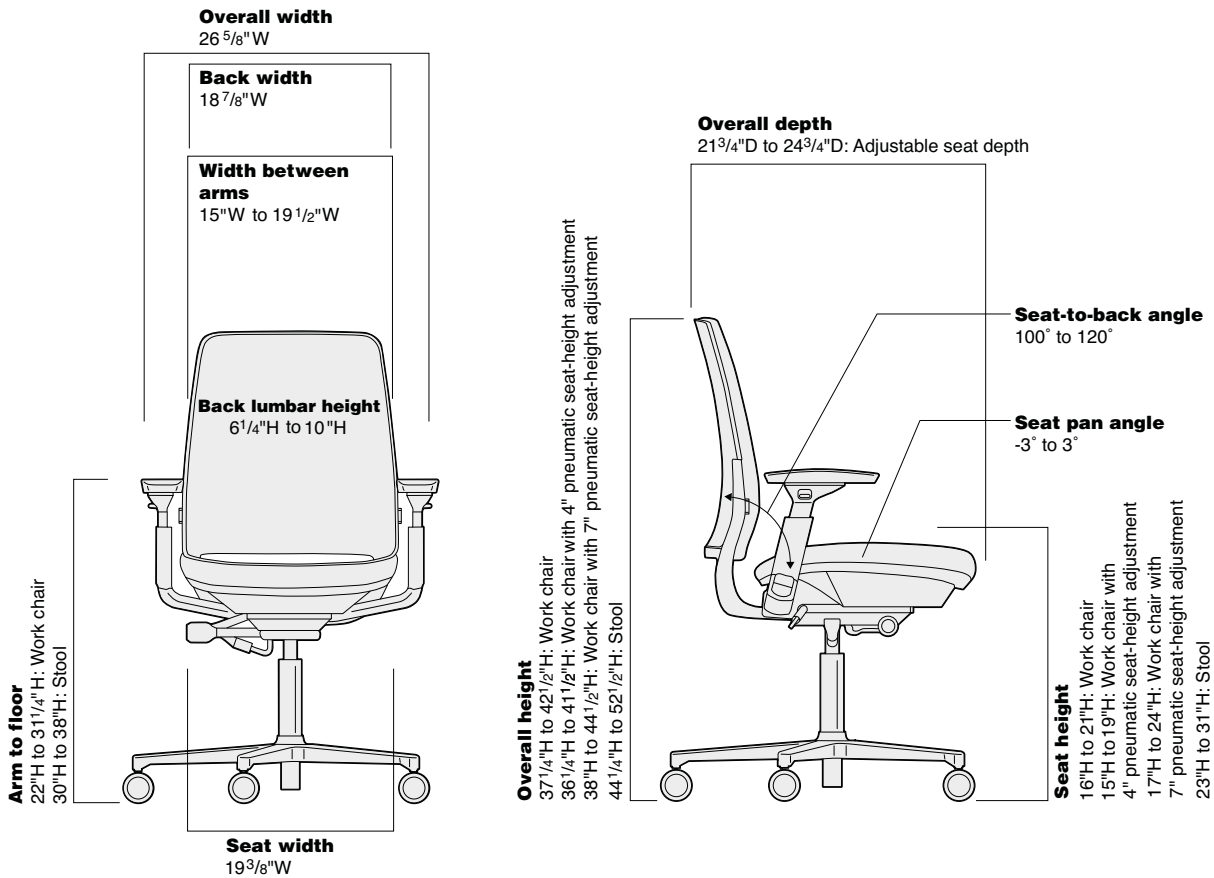

Amia 482 Series Work Chair

Sewn Leather Upholstery on Back, Seat, and Arm Caps



Standard Includes		Required to Specify
<p>▶ Need help? Product details, page 64</p>	<ul style="list-style-type: none"> • Synchro-tilt mechanism • 5" pneumatic seat-height adjustment • Upright back lock • Rectilinear independent height-, width-, pivot-, and depth-adjustable arms • Frame and arms: platinum • 3" seat depth adjustment • Five-arm base: polished aluminum • Passive seat edge angle • Adjustable lumbar • Fully-upholstered outer back, seat, and arm caps: Leather • Sewn upholstery design • 2½"-diameter, hard-composition, dual-wheel casters: polished aluminum 	<ol style="list-style-type: none"> 1 Style number 2 Leather color number for upholstery on back, seat, and arm caps 3 Options, if selected (see below) <p>▶ See <i>Surface Materials</i>, page 264.</p>

Tip: Always add suffixes in alphabetical order when specifying options to Amia seating.

Tip: Fire Code Seating (FCS) option is available with certain upholstery fabric choices only.
▶ Page 270-271

Tip: Plastic base available with plastic casters only.

Tip: Polished aluminum casters are available on a polished aluminum base only.

	Options	U.S. Price	Required to Specify
Surface Materials	Upholstery		
	• Elmosoft leather upholstery	+\$ 73	Specify Elmosoft leather color number.
	• Customer's Own Leather (COL)	No cost	Specify leather color number.
	• Fire Code Seating (FCS)	+\$ 64	Add suffix F to the style number.
	• Soil-retardant treatment applied to upholstery fabric	+\$ 21	Specify <i>with soil-retardant treatment</i> .
	Frame and Arms		
	• Black plastic	-\$ 78	Specify <i>with 6205 Black</i> .
Base	• Plastic base	-\$182	Specify <i>with plastic base</i> .
Arms	• Height-adjustable arms, soft arm caps	-\$ 78	Specify <i>with height-adjustable arms</i> .
Seat Height	• 4" pneumatic seat-height adjustment	+\$ 52	Specify <i>with 4" pneumatic seat-height adjustment</i> .
	• 7" pneumatic seat-height adjustment	+\$ 52	Specify <i>with 7" pneumatic seat-height adjustment</i> .
Casters	Polished aluminum base		
	• Soft, dual-wheel casters for use on hard floors: polished aluminum	+\$ 21	Specify <i>with soft polished aluminum casters</i> .
	• Hard, dual-wheel casters for use on soft floors: plastic	-\$ 52	Specify <i>with hard plastic casters</i> .
	• Soft, dual-wheel casters for use on hard floors: plastic	-\$ 31	Specify <i>with soft plastic casters</i> .
	Plastic base		
	• Soft, dual-wheel casters for use on hard floors: plastic	+\$ 21	Specify <i>with soft plastic casters</i> .
Glides	Polished aluminum base		
	• Glides: plastic	-\$ 31	Specify <i>with glides</i> .
	Plastic base		
	• Glides: plastic	+\$ 21	Specify <i>with glides</i> .

Specification Information	
• Style Number	• U.S. Base Price
4821410LS	\$1883

For Canadian Pricing
Multiply U.S. Price by the Canadian price factor.
▶ See page 1 for details.

▶ Detailed dimensions, page 68

Amia 482 Series Work Chairs

Upholstery on Back and Seat



Standard Includes	Required to Specify
<ul style="list-style-type: none"> ▶ Need help? Product details, page 64 • Synchro-tilt mechanism • 5" pneumatic seat-height adjustment • Upright back lock • Rectilinear independent height-, width-, pivot-, and depth-adjustable arms and soft arm caps: black plastic • Frame, seat shell, outer back, and five-arm base: plastic • 3" seat depth adjustment • Passive seat edge angle • Adjustable lumbar • Standard upholstery design: fabric price group 1 • 2½"-diameter, hard-composition, dual-wheel casters: black 	<ol style="list-style-type: none"> 1 Style number 2 Plastic color for frame, seat shell, outer back, and base 3 Fabric color number for upholstery on seat and back 4 Options, if selected (see below) <ul style="list-style-type: none"> ▶ See <i>Surface Materials</i>, page 264.

Surface Materials	Options	U.S. Price	Required to Specify
	Upholstery <ul style="list-style-type: none"> • Fabric price group 1 • Fabric price group 2 • Fabric price group 3 • Fabric price group 4 • Fabric price group 5 • Fabric price group 6 • Fabric price group 7 • Fabric price group 8 • Fabric price group 9 • Fabric price group 10 • Customer's Own Material (COM) 	<ul style="list-style-type: none"> No cost +\$ 22 +\$ 43 +\$ 59 +\$ 75 +\$ 92 +\$107 +\$134 +\$166 +\$187 No cost 	<ul style="list-style-type: none"> Specify fabric color number. Specify fabric color number. Specify fabric color number. Specify fabric color number. Specify fabric color number. Specify fabric color number. Specify fabric color number. Specify fabric color number. Specify fabric color number. Specify fabric color number. ▶ See <i>Surface Materials Reference Manual</i> to specify.
	<ul style="list-style-type: none"> • Steelcase leather upholstery • Elmosoft leather upholstery • Sewn upholstery • Steelcase vinyl • Customer's Own Leather (COL) • Customer's Own Vinyl (COV) • Fire Code Seating (FCS) • Soil-retardant treatment applied to upholstery fabric 	<ul style="list-style-type: none"> +\$317 +\$365 +\$ 68 +\$ 68 +\$ 68 +\$ 68 +\$ 64 +\$ 21 	<ul style="list-style-type: none"> Add suffix S to the style number and specify leather color number. Add suffix S to the style number and specify Elmosoft leather color number. Add suffix S to the style number. Add suffix S to the style number and specify vinyl color number. Add suffix S to the style number and specify leather color number. Add suffix S to the style number and specify vinyl color number. Add suffix F to the style number. Specify <i>with soil-retardant treatment</i>.
	Fully upholstered <ul style="list-style-type: none"> • Fabric fully upholstered outer back • Steelcase leather fully upholstered outer back • Elmosoft leather fully upholstered outer back • Sewn upholstery • Customer's Own Leather (COL) fully upholstered outer back 	<ul style="list-style-type: none"> +\$114 +\$589 +\$661 +\$182 +\$182 	<ul style="list-style-type: none"> Add suffix U to the style number. Add suffix SU to the style number and specify leather color number. Add suffix SU to the style number and specify Elmosoft leather color number. Add suffix SU to the style number. Add suffix SU to the style number. ▶ See <i>Surface Materials Reference Manual</i> to specify.
	Platinum <ul style="list-style-type: none"> • On frame, base, arm retainer, and outer back 	<ul style="list-style-type: none"> +\$ 78 	<ul style="list-style-type: none"> Specify <i>with 6249 Platinum</i>.

Tip: Always add suffixes in alphabetical order when specifying options to Amia seating.

Tip: Fire Code Seating (FCS) option is available with certain upholstery fabric choices only. ▶ Pages 270–271

▶ Detailed dimensions, page 68

▶ Options, continued on next page



For Canadian Pricing
Multiply U.S. Price by the Canadian price factor.
▶ See page 1 for details.

► Options, continued from previous page

	Options	U.S. Price	Required to Specify
Base	• Polished aluminum base	+\$130	Specify with polished aluminum base.
Arms	• Height-adjustable arms, soft arm caps	-\$ 78	Specify with height-adjustable arms.
	• Armless	-\$182	Specify without arms.
Seat Height	• 4" pneumatic seat-height adjustment	+\$ 52	Specify with 4" pneumatic seat-height adjustment.
	• 7" pneumatic seat-height adjustment	+\$ 52	Specify with 7" pneumatic seat-height adjustment.
Casters	• Soft, dual-wheel casters for use on hard floors	+\$ 21	Specify with soft casters.
	• Hard, polished aluminum casters on polished aluminum base for use on soft floors	+\$ 52	Specify with hard polished aluminum casters.
	• Soft, polished aluminum casters on polished aluminum base for use on hard floors	+\$ 73	Specify with soft polished aluminum casters.
Glides	• Glides: plastic	+\$ 21	Specify with glides.

Specification Information

Style Number	U.S. Base Price
4821410	\$925



 **For Canadian Pricing**
Multiply U.S. Price by the Canadian price factor.
► See page 1 for details.

Amia 482 Series Work Chairs

3D Knit on Back with Upholstery on Seat



Standard Includes		Required to Specify
<ul style="list-style-type: none"> ▶ Need help? Product details, page 64 	<ul style="list-style-type: none"> • Synchro-tilt mechanism • 5" pneumatic seat-height adjustment • Upright back lock • Rectilinear independent height-, width-, pivot-, and depth-adjustable arms and soft arm caps: black plastic • Frame, seat shell, outer back, and five-arm base: plastic • 3" seat depth adjustment • Passive seat edge angle • Adjustable lumbar • 3D Knit on back only • Standard upholstery design on seat: fabric price group 1 • 2½"-diameter, hard-composition, dual-wheel casters: black 	<ol style="list-style-type: none"> 1 Style number 2 Plastic color for frame, seat shell, outer back, and base 3 3D Knit color for back 4 Fabric color number for upholstery on seat 5 Options, if selected (see below) <ul style="list-style-type: none"> ▶ See <i>Surface Materials</i>, page 264.

	Options	U.S. Price	Required to Specify
Surface Materials	Upholstery		
	• Fabric price group 1	No cost	Specify fabric color number.
	• Fabric price group 2	+\$ 10	Specify fabric color number.
	• Fabric price group 3	+\$ 22	Specify fabric color number.
	• Fabric price group 4	+\$ 30	Specify fabric color number.
	• Fabric price group 5	+\$ 37	Specify fabric color number.
	• Fabric price group 6	+\$ 46	Specify fabric color number.
	• Fabric price group 7	+\$ 54	Specify fabric color number.
	• Fabric price group 8	+\$ 68	Specify fabric color number.
	• Fabric price group 9	+\$ 83	Specify fabric color number.
• Fabric price group 10	+\$ 95	Specify fabric color number.	
• Customer's Own Material (COM)	No cost	▶ See <i>Surface Materials Reference Manual</i> to specify.	
• Steelcase leather upholstery	+\$156	Add suffix S to the style number and specify leather color number.	
• Elmosoft leather upholstery	+\$180	Add suffix S to the style number and specify Elmosoft leather color number.	
• Sewn upholstery	+\$ 31	Add suffix S to the style number.	
• Steelcase vinyl	+\$ 31	Add suffix S to the style number and specify vinyl color number.	
• Customer's Own Leather (COL)	+\$ 31	Add suffix S to the style number and specify leather color number.	
• Customer's Own Vinyl (COV)	+\$ 31	Add suffix S to the style number and specify vinyl color number.	
• Fire Code Seating (FCS)	+\$ 64	Add suffix F to the style number.	
• Soil-retardant treatment applied to upholstery fabric	+\$ 21	Specify <i>with soil-retardant treatment</i> .	
	Platinum		
	• On frame, base, arm retainer, and outer back	+\$ 78	Specify <i>with 6249 Platinum</i> .
Base	• Polished aluminum base	+\$130	Specify <i>with polished aluminum base</i> .
Arms	• Height-adjustable arms, soft arm caps	-\$ 78	Specify <i>with height-adjustable arms</i> .
	• Armless	-\$182	Specify <i>without arms</i> .
Seat Height	• 4" pneumatic seat-height adjustment	+\$ 52	Specify <i>with 4" pneumatic seat-height adjustment</i> .
	• 7" pneumatic seat-height adjustment	+\$ 52	Specify <i>with 7" pneumatic seat-height adjustment</i> .

Tip: Sewn detail, if selected, is on the seat only.

Tip: Fire Code Seating (FCS) option is available with certain upholstery fabric choices only.

▶ Pages 270–271

▶ Detailed dimensions, page 68

▶ Options, continued on next page



For Canadian Pricing

Multiply U.S. Price by the Canadian price factor.

▶ See page 1 for details.

► **Options, continued from previous page**

	Options	U.S. Price	Required to Specify
Casters	• Soft, dual-wheel casters for use on hard floors	+\$ 21	Specify <i>with soft casters</i> .
	• Hard, polished aluminum casters on polished aluminum base for use on soft floors	+\$ 52	Specify <i>with hard polished aluminum casters</i> .
	• Soft, polished aluminum casters on polished aluminum base for use on hard floors	+\$ 73	Specify <i>with soft polished aluminum casters</i> .
Glides	• Glides: plastic	+\$ 21	Specify <i>with glides</i> .

Specification Information

Style Number	U.S. Base Price
4821418	\$977



Amia 482 Series

 **For Canadian Pricing**
Multiply U.S. Price by the Canadian price factor.
► See page 1 for details.

Amia 482 Series Stool

Upholstery on Back and Seat



	Standard Includes	Required to Specify
<p>▶ Need help? Product details, page 64</p>	<ul style="list-style-type: none"> • Synchro-tilt mechanism • 8" pneumatic seat-height adjustment • Upright back lock • Passive seat edge angle • Rectilinear independent height-, width-, pivot-, and depth-adjustable arms and soft arm caps: black plastic • Frame, seat shell, outer back, and five-arm base: plastic • 3" seat depth adjustment • Column and 4" adjustable foot ring: black • Standard upholstery design: fabric price group 1 • 2"-diameter, hard-composition, dual-wheel casters: black • Adjustable lumbar 	<ol style="list-style-type: none"> 1 Style number 2 Plastic color for frame, seat shell, outer back, and base 3 Fabric color number for upholstery on seat and back 4 Options, if selected (see below) <p>▶ See <i>Surface Materials</i>, page 264.</p>

	Options	U.S. Price	Required to Specify
Surface Materials	Upholstery		
	<ul style="list-style-type: none"> • Fabric price group 1 • Fabric price group 2 • Fabric price group 3 • Fabric price group 4 • Fabric price group 5 • Fabric price group 6 • Fabric price group 7 • Fabric price group 8 • Fabric price group 9 • Fabric price group 10 • Customer's Own Material (COM) 	<ul style="list-style-type: none"> No cost +\$ 22 +\$ 43 +\$ 59 +\$ 75 +\$ 92 +\$107 +\$134 +\$166 +\$187 No cost 	<ul style="list-style-type: none"> Specify fabric color number. Specify fabric color number. Specify fabric color number. Specify fabric color number. Specify fabric color number. Specify fabric color number. Specify fabric color number. Specify fabric color number. Specify fabric color number. Specify fabric color number. Specify fabric color number. <p>▶ See <i>Surface Materials Reference Manual</i> to specify.</p>
	<ul style="list-style-type: none"> • Steelcase leather upholstery • Elmosoft leather upholstery • Sewn upholstery • Steelcase vinyl • Customer's Own Leather (COL) • Customer's Own Vinyl (COV) • Fire Code Seating (FCS) • Soil-retardant treatment applied to upholstery fabric 	<ul style="list-style-type: none"> +\$317 +\$365 +\$ 68 +\$ 68 +\$ 68 +\$ 68 +\$ 64 +\$ 21 	<ul style="list-style-type: none"> Add suffix S to the style number and specify leather color number. Add suffix S to the style number and specify Elmosoft leather color number. Add suffix S to the style number. Add suffix S to the style number and specify vinyl color number. Add suffix S to the style number and specify leather color number. Add suffix S to the style number and specify vinyl color number. Add suffix F to the style number. Specify <i>with soil-retardant treatment</i>.
	Fully upholstered		
	<ul style="list-style-type: none"> • Fabric fully upholstered outer back • Steelcase leather fully upholstered outer back • Elmosoft leather fully upholstered outer back • Sewn upholstery • Customer's Own Leather (COL) fully upholstered outer back 	<ul style="list-style-type: none"> +\$114 +\$589 +\$661 +\$182 +\$182 	<ul style="list-style-type: none"> Add suffix U to the style number. Add suffix SU to the style number and specify leather color number. Add suffix SU to the style number and specify Elmosoft leather color number. Add suffix SU to the style number. Add suffix SU to the style number. <p>▶ See <i>Surface Materials Reference Manual</i> to specify.</p>
	Platinum		
	<ul style="list-style-type: none"> • On frame, base, arm retainer, and outer back 	<ul style="list-style-type: none"> +\$ 78 	<ul style="list-style-type: none"> Specify <i>with 6249 Platinum</i>.

Tip: Always add suffixes in alphabetical order when specifying options to Amia seating.

Tip: Fire Code Seating (FCS) option is available with certain upholstery fabric choices only.
▶ Pages 270–271

▶ Detailed dimensions, page 68

▶ Options, continued on next page

 **For Canadian Pricing**
Multiply U.S. Price by the Canadian price factor.
▶ See page 1 for details.

► **Options, continued from previous page**

	Options	U.S. Price	Required to Specify
Arms	• Height-adjustable arms, soft arm caps	-\$ 78	Specify <i>with height-adjustable arms</i> .
	• Armless	-\$182	Specify <i>without arms</i> .
Casters	• Soft, dual-wheel casters for use on hard floors	+\$ 21	Specify <i>with soft casters</i> .
Glides	• Glides: plastic	+\$ 21	Specify <i>with glides</i> .

Specification Information

Style Number	U.S. Base Price
4827410	\$1099



For Canadian Pricing
 Multiply U.S. Price by the Canadian price factor.
 ► See page 1 for details.

Amia 482 Series Stool

3D Knit on Back with Upholstery on Seat



Standard Includes		Required to Specify
<ul style="list-style-type: none"> ▶ Need help? Product details, page 64 	<ul style="list-style-type: none"> • Synchro-tilt mechanism • 8" pneumatic seat-height adjustment • Upright back lock • Passive seat edge angle • Rectilinear independent height-, width-, pivot-, and depth-adjustable arms and soft arm caps: black plastic • Frame, seat shell, outer back, and five-arm base: plastic • 3" seat depth adjustment • Column and 4" adjustable foot ring: black • 3D Knit on back only • Standard upholstery design on seat: fabric price group 1 • 2"-diameter, hard-composition, dual-wheel casters: black • Adjustable lumbar 	<ol style="list-style-type: none"> 1 Style number 2 Plastic color for frame, seat shell, outer back, and base 3 3D Knit color for back 4 Fabric color number for upholstery on seat 5 Options, if selected (see below) <ul style="list-style-type: none"> ▶ See <i>Surface Materials</i>, page 264.

Options	U.S. Price	Required to Specify
Surface Materials		
Upholstery <ul style="list-style-type: none"> • Fabric price group 1 • Fabric price group 2 • Fabric price group 3 • Fabric price group 4 • Fabric price group 5 • Fabric price group 6 • Fabric price group 7 • Fabric price group 8 • Fabric price group 9 • Fabric price group 10 • Customer's Own Material (COM) 	No cost +\$ 10 +\$ 22 +\$ 30 +\$ 37 +\$ 46 +\$ 54 +\$ 68 +\$ 83 +\$ 95 No cost	Specify fabric color number. Specify fabric color number. Specify fabric color number. Specify fabric color number. Specify fabric color number. Specify fabric color number. Specify fabric color number. Specify fabric color number. Specify fabric color number. Specify fabric color number. Specify fabric color number. ▶ See <i>Surface Materials Reference Manual</i> to specify. Add suffix S to the style number and specify leather color number. Add suffix S to the style number and specify Elmosoft leather color number. Add suffix S to the style number. Add suffix S to the style number and specify vinyl color number. Add suffix S to the style number and specify leather color number. Add suffix S to the style number and specify vinyl color number. Add suffix F to the style number. Specify <i>with soil-retardant treatment</i> .
<ul style="list-style-type: none"> • Steelcase leather upholstery • Elmosoft leather upholstery 	+\$156 +\$180	
<ul style="list-style-type: none"> • Sewn upholstery • Steelcase vinyl 	+\$ 31 +\$ 31	
<ul style="list-style-type: none"> • Customer's Own Leather (COL) • Customer's Own Vinyl (COV) 	+\$ 31 +\$ 31	
<ul style="list-style-type: none"> • Fire Code Seating (FCS) • Soil-retardant treatment applied to upholstery fabric 	+\$ 64 +\$ 21	
Platinum <ul style="list-style-type: none"> • On frame, base, arm retainer, and outer back 	+\$ 78	Specify <i>with 6249 Platinum</i> .

Tip: Sewn detail, if selected, is on the seat only.

Tip: Fire Code Seating (FCS) option is available with certain upholstery fabric choices only.
 ▶ Pages 270–271

Arms <ul style="list-style-type: none"> • Height-adjustable arms, soft arm caps • Armless 	–\$ 78 –\$182	Specify <i>with height-adjustable arms</i> . Specify <i>without arms</i> .
Casters <ul style="list-style-type: none"> • Soft, dual-wheel casters for use on hard floors 	+\$ 21	Specify <i>with soft casters</i> .
Glides <ul style="list-style-type: none"> • Glides: plastic 	+\$ 21	Specify <i>with glides</i> .

Specification Information	
Style Number	U.S. Base Price
4827418	\$1151

▶ Detailed dimensions, page 68

 **For Canadian Pricing**
 Multiply U.S. Price by the Canadian price factor.
 ▶ See page 1 for details.

Understanding and Specifying Reply 466 Series Work Chairs

Product Details

Reply 466 Series	80
Dimensions	84

Specifying

Swivel-Base Work Chairs	86
Leg-Base Multi-Use Chairs	88
Sled-Base Multi-Use Chairs	90

Work Chairs

Highly adjustable task seating offers maximum personalization for people who sit most of the day performing repetitive tasks. By making a series of simple adjustments, you can customize the chair to your body, preferences, and tasks. These chairs provide continuous, stable, task-oriented comfort, and can be quickly adjusted to support you in upright, forward, and reclining work postures.

- Leap 462 Series
- Leap 464 Series WorkLounge
- Criterion 453 Series
- Think 465 Series
- Amia 482 Series
- Reply 466 Series
- Drive 461 Series
- Jersey Series

Adjustability Features

▶ See page 12 for a comparison to other chairs. **Reply 466 Series**

Mechanisms

Synchro-tilt ●

Seat Adjustments

Pneumatic height ●

Seat depth ●

Back Adjustments

Back height ●

Lumbar height ●

Multi-position back lock ●

Arm Adjustments

Arm depth ●

Arm height ●

Arm pivot ●

Reply 466 Series

Reply is a complete family of comfortable, budget-friendly chairs that are as nice to look at as they are to sit in. Reply can take on whatever your workday brings.

Back frame and seat shell are plastic.

Back height adjustment on upholstered chairs allows you to raise or lower chair back from a seated position to support your lower back.

Five-arm base is plastic, a polished aluminum base is available as an option.



Lumbar height adjusts 4" to provide additional lower back support and is available as an option on mesh back chairs only.

Arm depth can retract 3" to allow user to get closer to the worksurface and into tight corners.

Arm height can adjust independently within a 3³/₄" range to help relieve upper back and shoulder fatigue.

Arm caps can pivot independently 18° in and 4° out to accommodate individual user preferences.

Multi-position back lock allows user to lock the backrest in multiple positions.

Seat depth adjusts within a 1¹/₂" range to accommodate users of varying leg lengths.

Seat height adjusts within a 5" range with a pneumatic adjustment mechanism.

Tilt tension adjustment allows you to control the amount of resistance needed for reclining.

Casters have hard, dual-wheels that roll smoothly on carpets. They are 2¹/₂" for increased mobility. Soft, dual-wheel casters are available as an option for use on hard floors or chair mats.

Dual-wheel with roll-control casters may be used on soft and hard flooring surfaces.

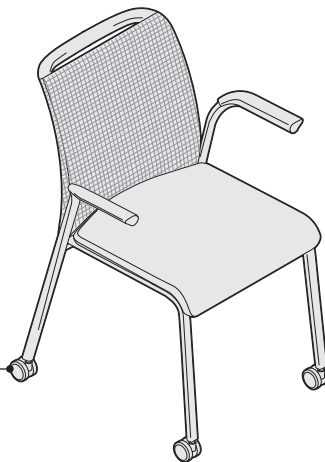

Back handle on mesh back chairs provides a convenient handhold to easily move the chair.

Arms, when specified, have a textured plastic arm cap.

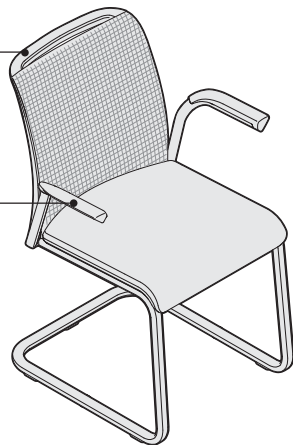

Plastic glides are standard. Optional soft glides are available.

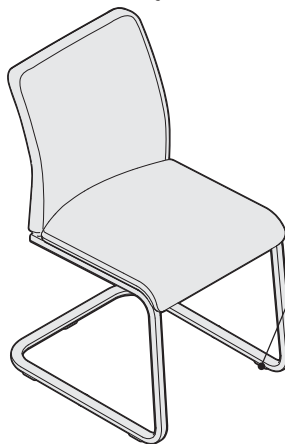

Product Details

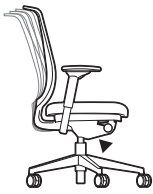

Synchro-tilt mechanism with a natural fluid motion on work chairs keeps users oriented to their work.

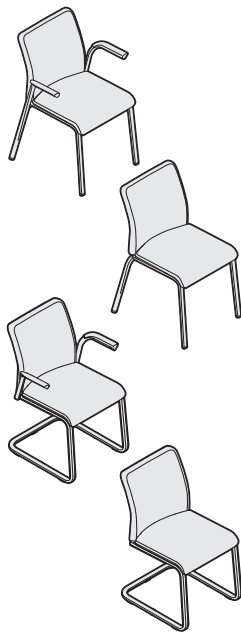

Fixed-height multi-use chairs are available with or without arms.

Cartoned shipment of Reply work chairs is standard. Reply work chairs ship knocked down in a single carton consisting of four components: back, seat and mechanism, base, and pneumatic. This allows for shipment in a smaller carton. Leg-base multi-use chairs ship two to a carton, when applicable. Assembly by a qualified dealer installer is required for work chairs. Assembly instructions are included. No additional tools are required for assembly.

Stacking density for leg-base multi-use chairs is six on the floor. Arms and casters do not impact the ability to stack.

Adjustment Features

Adjustability instructions are included with every swivel-base chair. Instructions can also be found at www.steelcase.com.

Seat Adjustments

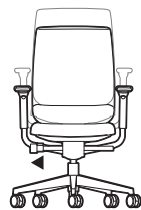

Seat height adjusts pneumatically. To lower, hold handle up while seated. To raise, hold handle up and keep your weight off the chair. Range of adjustability is 5", from 16"H to 21"H.

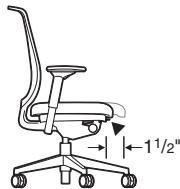

Seat depth adjusts 1 1/2" by pulling handle up. Slide seat forward or back to accommodate various leg lengths. Release handle to lock. Seat depth is a standard feature on work chairs.

Back Adjustments

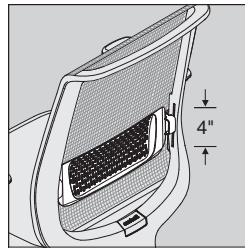

Lumbar height adjusts 4" (6" to 10" from seat) by grabbing exposed tabs and sliding the lumbar support up or down. Available as an option on mesh work chairs only.



Variable back lock (4 positions)

Multiple position back lock allows users to recline the back to the desired angle and lock it in place. To lock, recline to desired angle and push back lock handle down. To release, lean forward, lift the handle and apply pressure to the back to disengage the lock.

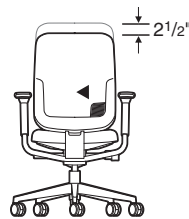

Back height adjusts 2 1/2" (23"-25 1/2") by pressing and holding the control button on the right side of the back, and sliding the back support up or down. Release the control button to lock. This feature is standard on work chairs with upholstered (non-mesh) backs only.



Back tension adjusts by turning knob forward to increase back tension, backward to decrease back tension. This feature is standard on all work chairs.

Arm Adjustments

Height-, pivot-, and depth-adjustable arms are available as an option on Reply task chairs.

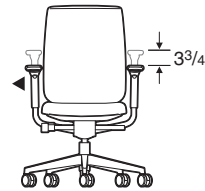

Arm height adjusts independently within a range of 3 3/4" (7 1/2"-11 1/4" from the seat). Push button on outside and under arm cap in while moving arms up or down. Releasing buttons locks arms in position.

Height-only adjustable arm is also available and adjusts 3 3/4".

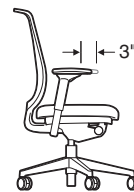

Arm depth adjusts approximately 3" to enable user to get closer to worksurface.

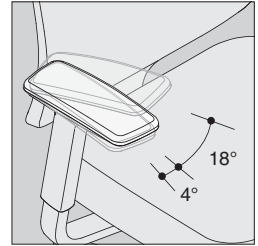

Arms pivot 18° inward and 4° outward on models with adjustable pivot arms. Grasp arm and push front to left or right.

Other Features

Soft-wheel casters for hard floors on work chairs are available for specific applications.

Dual-wheel roll-control casters for use on soft and hard flooring surfaces come standard on leg-base multi-use chairs when specified with casters.

Hard glides come standard on multi-use chairs when specified with glides. Soft glides are available as an option.

Surface Materials

► See surface materials on page 264 for specific availability or refer to the *Surface Materials Reference Manual* for further information.

Upholstery

- Fabric
- Fabric with soil-retardant treatment (option)
- Mesh (back only)
- Leather
- Elmosoft leather
- Vinyl

Hard components

Chair with swivel-base (frame, outer back, arm cap assembly, and mechanism)

- 6205 Black

Chair with swivel-base (arm tube and base)

- 6205 Black
- 6249 Platinum
- Polished aluminum (base only)

Chair with multi-use leg-base (outer back, and arm caps)

- 6205 Black

Chair with leg-base or sled-base (metal frame)

- 4799 Platinum
- 7207 Black

Casters

- 6205 Black

Glides

Chair with multi-use leg-base

- 6205 Black

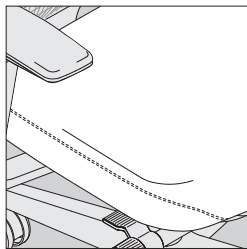

Sewn-upholstery models feature a stitch detail on the sides of the seat and back cushions. Task chairs have an additional stitch across the lumbar region of the back cushion.

Swivel-Base Models

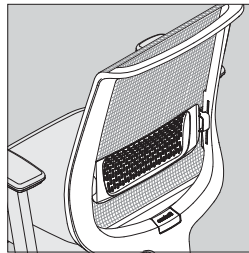

Mesh back on swivel-base models are available with a height-adjustable lumbar option to enhance back support.

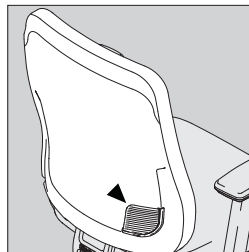

Upholstered back on swivel-base models feature a back-height adjustment that allows you to raise or lower the chair back from a seated position to support your lower back.

Leg-Base and Sled-Base Models

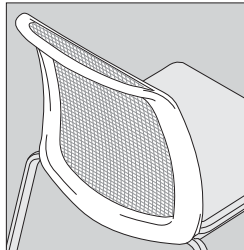

Mesh back frame with handle on leg-base models provides a convenient handhold to easily move the chair.

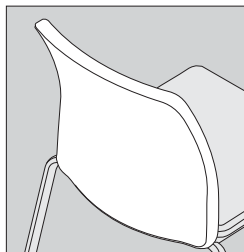

Upholstered back rest on leg-base models features a plastic outer shell.

All Steelcase seating with standard upholstery fabrics complies with requirements of the State of California Technical Bulletin 117. All standard seating is labeled to be in compliance with California 117.

Programs & Services

► See *Surface Materials Reference Manual* for further detail about programs and services offered for seating.

The Customer's Own Material (COM)

Program offers the opportunity for customers to select fabrics that are not offered through the standard Steelcase surface materials program for use on Steelcase products. Through the COM program, Steelcase will test your materials for application on Steelcase products. Once approved, you can place your order. Steelcase will facilitate the entire ordering process and give you a production schedule. Steelcase will order the COM fabric directly from the textile manufacturer. For up-to-date information regarding fabric test results for all COM fabrics and details regarding yardage requirements for most Seating lines, visit the COM Web site. To locate the COM Web site:

- Visit www.steelcase.com

Soil retardants are treatments that provide long-term soil and stain resistance to a fabric without affecting the shade or the integrity of the fabric. The following Steelcase Textiles are available pre-treated with soil retardant. (You do not need to select the soil-retardant option for these fabrics and incur the upcharge.)

- Jacks
- Link
- Spyder

For information on soil retardant fabrics on Select Surfaces, please refer to the *Surface Materials Reference Manual*.

Soil-retardant treatment is available on all other seating fabrics at an additional upcharge per seating unit. To order this option, please select "Soil-Retardant Treatment" under "Optional Accessories."

For soil-retardant treatment on COMs, please select "Soil-Retardant Treatment" under "Optional Accessories." Minimums or additional yardage may be required. Please contact the vendor directly for specific information.

Extended lead times may be necessary for this service.

Contact your Steelcase Solutions Fulfillment Team Representative at 1.888.STEELCASE (1.888.783.3522) or send an email to lineone@steelcase.com.

Steelcase fire code seating (FCS) is not available on Reply seating.

Local codes may have special requirements for upholstery.

Dimensions

► Page 84

Resources

Printed materials

► Reply Product Brochure (10-0002941)

Dimensions

Reply 466 Series

Features	Overall Depth	Width	Height	Seat Depth	Functional Seat Depth	Seat Width	Seat Height from Floor	Back Width	Back Height from Seat	Lumbar Height from Seat
----------	---------------	-------	--------	------------	-----------------------	------------	------------------------	------------	-----------------------	-------------------------

Reply 466 Series

Swivel-Base Work Chairs

Mesh Back	24" to 25"	26"	37 ³ / ₄ " to 42 ³ / ₄ "	16 ⁷ / ₈ "	16 ¹ / ₂ " to 18"	18 ¹ / ₂ "	16" to 21"	17 ¹ / ₂ "	22 ⁵ / ₈ "	6" to 10"
Upholstered Back and Seat	21 ¹ / ₈ " to 22 ¹ / ₂ "	26"	39 ¹ / ₄ " to 46 ³ / ₄ "	16 ⁷ / ₈ "	15 ¹ / ₂ " to 17"	18 ¹ / ₂ "	16" to 21"	17 ¹ / ₂ "	23 ¹ / ₄ " to 25 ³ / ₄ "	N.A.

Leg-Base Multi-Use Chairs

Mesh Back	23"	23 ¹ / ₄ "*	34"***	17 ¹ / ₂ "	16"	17 ³ / ₄ "	19"***	16 ¹ / ₂ "	17"	9 ¹ / ₂ "
Upholstered	23"	23 ¹ / ₄ "*	33"***	17 ¹ / ₂ "	17"	17 ³ / ₄ "	19"***	16 ³ / ₄ "	17"	8"

Sled-Base Multi-Use Chairs

Mesh Back	23 ¹ / ₂ "	23 ¹ / ₄ "	33 ¹ / ₂ "	17 ¹ / ₂ "	16"	17 ³ / ₄ "	18 ¹ / ₂ "	16 ¹ / ₂ "	17"	9 ¹ / ₂ "
Upholstered	23 ¹ / ₂ "	23 ¹ / ₄ "	32 ¹ / ₂ "	17 ¹ / ₂ "	17"	17 ³ / ₄ "	18 ¹ / ₂ "	16 ³ / ₄ "	17"	8"

*Armless models are 1¹/₄" narrower.

**Dimension is ¹/₂" less when specified with glides.

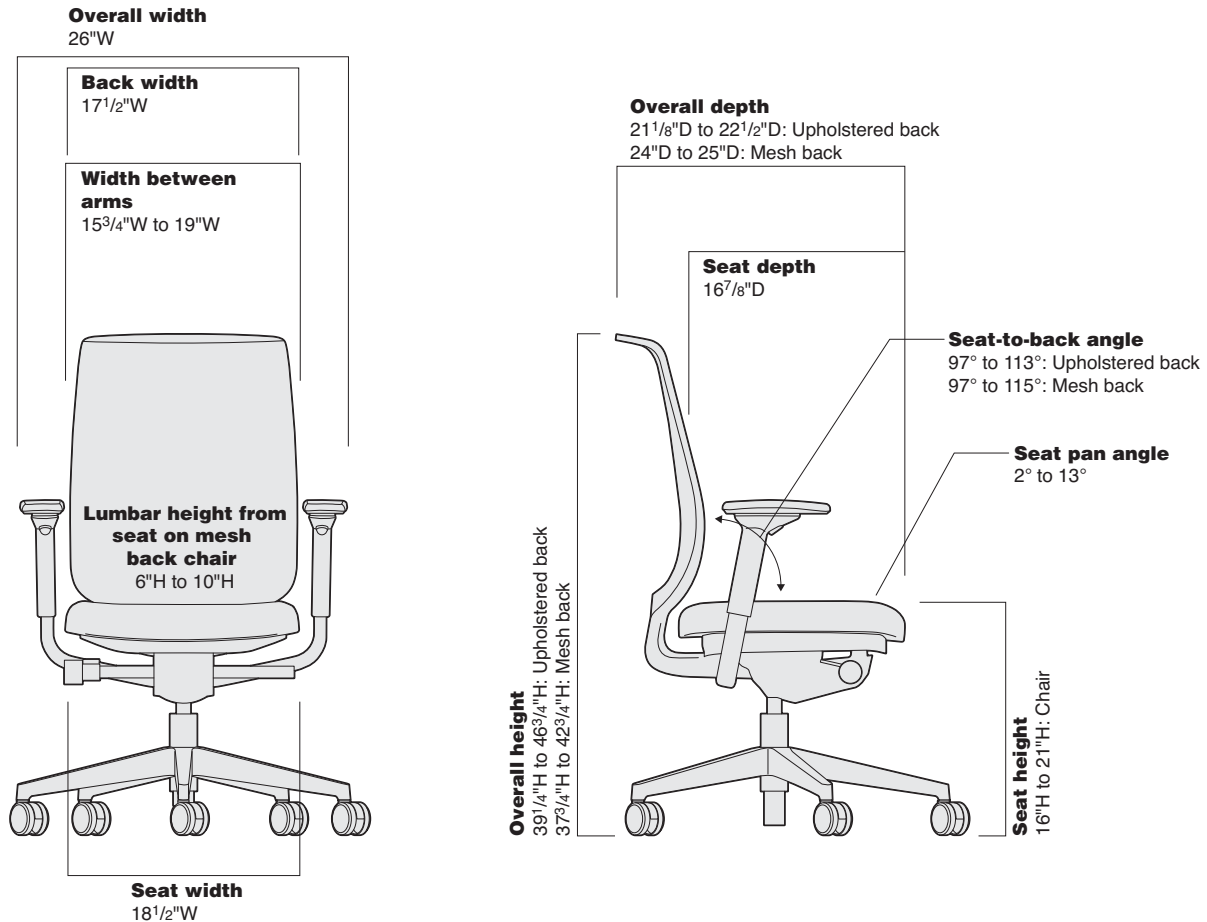

• Width • Between • Arms	• Arm • Height • to Floor	• Arm • Height • from • Seat	• Arm Cap • Pivot • Range	• Angle • Between • Seat and • Back	• Seat • Pan • Angle
--------------------------------	---------------------------------	---------------------------------------	---------------------------------	--	----------------------------

Swivel-Base Work Chairs

15¾" to 19"	23¼" to 32"	7¼" to 11"	18° inward, 4° outward	97° to 115°	2° to 13°
15¾" to 19"	23¼" to 32"	7¼" to 11"	18° inward, 4° outward	97° to 113°	2° to 13°

Leg-Base Multi-Use Chairs

19½"	26¾ ^{***}	9"	N.A.	98°	6°
19½"	26¾ ^{***}	9"	N.A.	98°	6°

Sled-Base Multi-Use Chairs

19½"	26¼"	9"	N.A.	98°	6°
19½"	26¼"	9"	N.A.	98°	6°

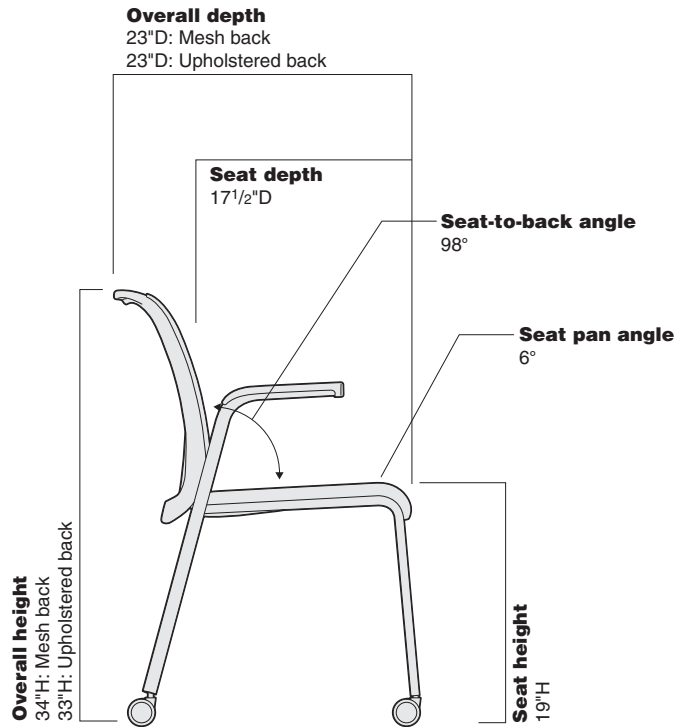
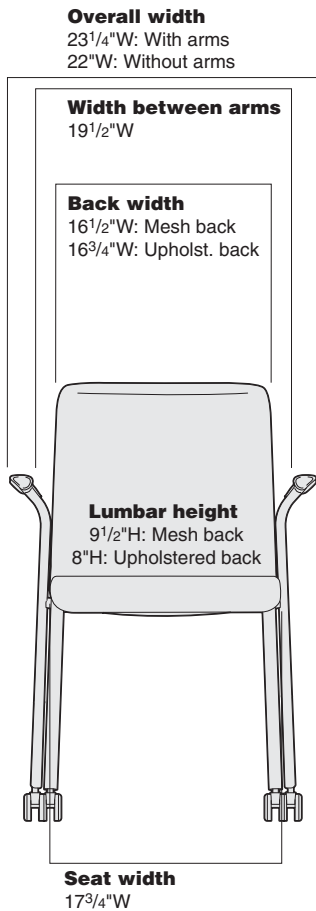

Reply 466 Series Swivel-Base Work Chairs

Mesh Back with Standard Upholstery on Seat



Tip: Arms are not included with Reply unless you specify one of the arm options.

Tip: Always add suffixes in alphabetical order when specifying options to Reply seating.

Tip: Outer back, mechanism, and optional arm cap assembly are available in 6205 Black only.

Standard Includes		Required to Specify
<ul style="list-style-type: none"> ▶ Need help? Product details, page 80 	<ul style="list-style-type: none"> • Synchro-tilt mechanism • 5" pneumatic seat-height adjustment (16"-21") • Multi-position back lock • Outer back, seat shell, and five-arm plastic base: plastic • 1½" seat depth adjustment • Mesh on back • Standard upholstery design on seat: fabric price group 1 • 2½"-diameter, hard-composition, dual-wheel casters: black 	<ol style="list-style-type: none"> 1 Style number 2 Plastic color number for base, and arm tube; if specified 3 Mesh color number for back 4 Fabric color number for upholstery on seat 5 Options, if selected (see below) <p>▶ See <i>Surface Materials</i>, page 264.</p>

Options	U.S. Price	Required to Specify
Surface Materials <ul style="list-style-type: none"> • Fabric price group 1 • Fabric price group 2 • Fabric price group 3 • Fabric price group 4 • Fabric price group 5 • Fabric price group 6 • Fabric price group 7 • Fabric price group 8 • Fabric price group 9 • Fabric price group 10 • Customer's Own Material (COM) 	<ul style="list-style-type: none"> No cost +\$ 10 +\$ 22 +\$ 30 +\$ 37 +\$ 46 +\$ 54 +\$ 68 +\$ 83 +\$ 95 No cost 	<ul style="list-style-type: none"> Specify fabric color number. Specify fabric color number. Specify fabric color number. Specify fabric color number. Specify fabric color number. Specify fabric color number. Specify fabric color number. Specify fabric color number. Specify fabric color number. Specify fabric color number. ▶ See <i>Surface Materials Reference Manual</i> to specify. Add suffix S to the style number and specify leather color number. Add suffix S to the style number and specify Elmosoft leather color number. Add suffix S to the style number. Add suffix S to the style number and specify vinyl color number. Add suffix S to the style number and specify leather color number. Add suffix S to the style number and specify vinyl color number. Specify <i>with soil-retardant treatment</i>.
<ul style="list-style-type: none"> • Steelcase leather upholstery • Elmosoft leather upholstery 	<ul style="list-style-type: none"> +\$156 +\$182 	
<ul style="list-style-type: none"> • Sewn upholstery • Steelcase vinyl 	<ul style="list-style-type: none"> +\$ 36 +\$ 36 	
<ul style="list-style-type: none"> • Customer's Own Leather (COL) • Customer's Own Vinyl (COV) 	<ul style="list-style-type: none"> +\$ 36 +\$ 36 	
<ul style="list-style-type: none"> • Soil-retardant treatment applied to upholstery fabric 	<ul style="list-style-type: none"> +\$ 21 	
Platinum <ul style="list-style-type: none"> • On base and arm tube 	<ul style="list-style-type: none"> +\$ 78 	<ul style="list-style-type: none"> Specify <i>with 4799 Platinum</i>.
Arms <ul style="list-style-type: none"> • Height-adjustable arms, soft arm caps • Height-, pivot-, depth-adjustable arms 	<ul style="list-style-type: none"> +\$ 88 +\$130 	<ul style="list-style-type: none"> Specify <i>with height-adjustable arms</i>. Specify <i>with height-, pivot-, depth-adjustable arms</i>.
Base <ul style="list-style-type: none"> • Polished aluminum base 	<ul style="list-style-type: none"> +\$130 	<ul style="list-style-type: none"> Specify <i>with aluminum base</i>.
Lumbar Height <ul style="list-style-type: none"> • 4" travel for additional lumbar support 	<ul style="list-style-type: none"> +\$ 36 	<ul style="list-style-type: none"> Specify <i>with adjustable lumbar height</i>.
Casters <ul style="list-style-type: none"> • Soft, dual-wheel casters for use on hard floors 	<ul style="list-style-type: none"> +\$ 21 	<ul style="list-style-type: none"> Specify <i>with soft casters</i>.

Specification Information	
Style Number	U.S. Base Price
466160MT	\$660

▶ Detailed dimensions, page 84

 **For Canadian Pricing**
Multiply U.S. Price by the Canadian price factor.
▶ See page 1 for details.

Reply 466 Series Swivel-Base Work Chairs

Standard Upholstery on Back and Seat

Reply 466 Series
Swivel-Base Work Chairs



Tip: Arms are not included with Reply unless you specify one of the arm options.

Tip: Always add suffixes in alphabetical order when specifying options to Reply seating.

Tip: Outer back, mechanism, and optional arm cap assembly are available in 6205 Black only.

Standard Includes	Required to Specify
<ul style="list-style-type: none"> ▶ Need help? Product details, page 80 • Synchro-tilt mechanism • 5" pneumatic seat-height adjustment (16"-21") • Multi-position back lock • Outer back, seat shell, and five-arm plastic base: plastic • 1½" seat depth adjustment • 2¼" back-height adjustment • Standard upholstery design on back and seat: fabric price group 1 • 2½"-diameter, hard-composition, dual-wheel casters: black 	<ol style="list-style-type: none"> 1 Style number 2 Plastic color number for base, and arm tube; if specified 3 Fabric color number for upholstery on back and seat 4 Options, if selected (see below) <p>▶ See <i>Surface Materials</i>, page 264.</p>

Options	U.S. Price	Required to Specify
Surface Materials Upholstery <ul style="list-style-type: none"> • Fabric price group 1 • Fabric price group 2 • Fabric price group 3 • Fabric price group 4 • Fabric price group 5 • Fabric price group 6 • Fabric price group 7 • Fabric price group 8 • Fabric price group 9 • Fabric price group 10 • Customer's Own Material (COM) <ul style="list-style-type: none"> • Steelcase leather upholstery • Elmosoft leather upholstery • Sewn upholstery • Steelcase vinyl • Customer's Own Leather (COL) • Customer's Own Vinyl (COV) • Fire Code Seating (FCS) • Soil-retardant treatment applied to upholstery fabric 	No cost +\$ 22 +\$ 43 +\$ 59 +\$ 75 +\$ 92 +\$107 +\$134 +\$166 +\$187 No cost +\$312 +\$364 +\$ 68 +\$ 68 +\$ 68 +\$ 68 +\$ 64 +\$ 21	Specify fabric color number. Specify fabric color number. Specify fabric color number. Specify fabric color number. Specify fabric color number. Specify fabric color number. Specify fabric color number. Specify fabric color number. Specify fabric color number. Specify fabric color number. ▶ See <i>Surface Materials Reference Manual</i> to specify. Add suffix S to the style number and specify leather color number. Add suffix S to the style number and specify Elmosoft leather color number. Add suffix S to the style number. Add suffix S to the style number and specify vinyl color number. Add suffix S to the style number and specify leather color number. Add suffix S to the style number and specify vinyl color number. Add suffix F to the style number. Specify <i>with soil-retardant treatment</i> .
Platinum <ul style="list-style-type: none"> • On base, and arm tube 	+\$ 78	Specify <i>with 4799 Platinum</i> .
Arms <ul style="list-style-type: none"> • Height-adjustable arms, soft arm caps • Height-, pivot-, depth-adjustable arms 	+\$ 88 +\$130	Specify <i>with height-adjustable arms</i> . Specify <i>with height-, pivot-, depth-adjustable arms</i> .
Base <ul style="list-style-type: none"> • Polished aluminum base 	+\$130	Specify <i>with aluminum base</i> .
Casters <ul style="list-style-type: none"> • Soft, dual-wheel casters for use on hard floors 	+\$ 21	Specify <i>with soft casters</i> .

Specification Information	
Style Number	U.S. Base Price
466160MP	\$629

▶ Detailed dimensions, page 84



For Canadian Pricing
Multiply U.S. Price by the Canadian price factor.
▶ See page 1 for details.

Reply 466 Series Leg-Base Multi-Use Chairs

Mesh Back with Standard Upholstery on Seat

Standard Includes		Required to Specify
<ul style="list-style-type: none"> ▶ Need help? Product details, page 80 	<ul style="list-style-type: none"> • Frame: paint • Mesh on back • Standard upholstery design on seat: fabric price group 1 • Arm caps, if selected: black 	<ol style="list-style-type: none"> 1 Style number 2 Paint color number for metal frame, and arms; if specified 3 Mesh color number for back 4 Fabric color number for upholstery on seat 5 Options, if selected (see below) <ul style="list-style-type: none"> ▶ See <i>Surface Materials</i>, page 264.

Options	U.S. Price	Required to Specify
Surface Materials		
Upholstery		
• Fabric price group 1	No cost	Specify fabric color number.
• Fabric price group 2	+\$ 10	Specify fabric color number.
• Fabric price group 3	+\$ 22	Specify fabric color number.
• Fabric price group 4	+\$ 30	Specify fabric color number.
• Fabric price group 5	+\$ 37	Specify fabric color number.
• Fabric price group 6	+\$ 46	Specify fabric color number.
• Fabric price group 7	+\$ 54	Specify fabric color number.
• Fabric price group 8	+\$ 68	Specify fabric color number.
• Fabric price group 9	+\$ 83	Specify fabric color number.
• Fabric price group 10	+\$ 95	Specify fabric color number.
• Customer's Own Material (COM)	No cost	▶ See <i>Surface Materials Reference Manual</i> to specify.
• Steelcase leather upholstery	+\$156	Add suffix S to the style number and specify leather color number.
• Elmosoft leather upholstery	+\$182	Add suffix S to the style number and specify Elmosoft leather color number.
• Sewn upholstery	+\$ 36	Add suffix S to the style number.
• Steelcase vinyl	+\$ 36	Add suffix S to the style number and specify vinyl color number.
• Customer's Own Leather (COL)	+\$ 36	Add suffix S to the style number and specify leather color number.
• Customer's Own Vinyl (COV)	+\$ 36	Add suffix S to the style number and specify vinyl color number.
• Soil-retardant treatment applied to upholstery fabric	+\$ 21	Specify <i>with soil-retardant treatment</i> .
Frame		
• Platinum on frame	+\$ 52	Specify <i>with 4799 Platinum frame</i> .
Casters		
• Dual-wheel roll-control casters	+\$ 45	Specify <i>with dual-wheel roll-control casters</i> .
Glides		
• Hard glides for use on carpeted floors	No cost	Specify <i>with hard glides</i> .
• Soft glides for use on non-carpeted floors	+\$ 6	Specify <i>with soft glides</i> .

Tip: Always add suffixes in alphabetical order when specifying options to Reply seating.

Tip: Casters or glides must be selected to complete specification of chair.

Specification Information

With Arms		Without Arms	
Style Number	U.S. Base Price	Style Number	U.S. Base Price
466452MT	\$519	466450MT	\$467



▶ Detailed dimensions, page 84

 **For Canadian Pricing**
Multiply U.S. Price by the Canadian price factor.
▶ See page 1 for details.

Reply 466 Series Leg-Base Multi-Use Chairs

Standard Upholstery on Back and Seat

Reply 466 Series Leg-Base
Multi-Use Chairs

Standard Includes		Required to Specify
<ul style="list-style-type: none"> ▶ Need help? Product details, page 80 	<ul style="list-style-type: none"> • Frame: paint • Standard upholstery design on seat and back: fabric price group 1 • Arm caps, if selected: black 	<ol style="list-style-type: none"> 1 Style number 2 Paint color number for metal frame, and arms; if specified 3 Fabric color number for upholstery on seat and back 4 Options, if selected (see below) <ul style="list-style-type: none"> ▶ See <i>Surface Materials</i>, page 264.

Options	U.S. Price	Required to Specify
Surface Materials		
Upholstery <ul style="list-style-type: none"> • Fabric price group 1 • Fabric price group 2 • Fabric price group 3 • Fabric price group 4 • Fabric price group 5 • Fabric price group 6 • Fabric price group 7 • Fabric price group 8 • Fabric price group 9 • Fabric price group 10 • Customer's Own Material (COM) 	No cost +\$ 22 +\$ 43 +\$ 59 +\$ 75 +\$ 92 +\$107 +\$134 +\$166 +\$187 No cost	Specify fabric color number. Specify fabric color number. Specify fabric color number. Specify fabric color number. Specify fabric color number. Specify fabric color number. Specify fabric color number. Specify fabric color number. Specify fabric color number. Specify fabric color number. Specify fabric color number. ▶ See <i>Surface Materials Reference Manual</i> to specify.
<ul style="list-style-type: none"> • Steelcase leather upholstery • Elmosoft leather upholstery • Sewn upholstery • Steelcase vinyl • Customer's Own Leather (COL) • Customer's Own Vinyl (COV) • Fire Code Seating (FCS) • Soil-retardant treatment applied to upholstery fabric 	+\$312 +\$364 +\$ 68 +\$ 68 +\$ 68 +\$ 68 +\$ 64 +\$ 21	Add suffix S to the style number and specify leather color number. Add suffix S to the style number and specify Elmosoft leather color number. Add suffix S to the style number. Add suffix S to the style number and specify vinyl color number. Add suffix S to the style number and specify leather color number. Add suffix S to the style number and specify vinyl color number. Add suffix F to the style number. Specify <i>with soil-retardant treatment</i> .
Frame <ul style="list-style-type: none"> • Platinum on frame 	+\$ 52	Specify <i>with 4799 Platinum frame</i> .
Casters <ul style="list-style-type: none"> • Dual-wheel roll-control casters 	+\$ 45	Specify <i>with dual-wheel roll-control casters</i> .
Glides <ul style="list-style-type: none"> • Hard glides for use on carpeted floors • Soft glides for use on non-carpeted floors 	No cost +\$ 6	Specify <i>with hard glides</i> . Specify <i>with soft glides</i> .

Tip: Always add suffixes in alphabetical order when specifying options to Reply seating.

Tip: Casters or glides must be selected to complete specification of chair.

Specification Information

With Arms		Without Arms	
Style Number	U.S. Base Price	Style Number	U.S. Base Price
466452MH	\$467	466450MH	\$415

▶ Detailed dimensions, page 84

 **For Canadian Pricing**
Multiply U.S. Price by the Canadian price factor.
▶ See page 1 for details.

Reply 466 Series Sled-Base Multi-Use Chairs

Mesh Back with Standard Upholstery on Seat

Standard Includes		Required to Specify
<ul style="list-style-type: none"> ▶ Need help? Product details, page 80 	<ul style="list-style-type: none"> • Frame: paint • Mesh on back • Standard upholstery design on seat: fabric price group 1 • Arm caps, if selected: black 	<ol style="list-style-type: none"> 1 Style number 2 Paint color number for metal frame, and arms; if specified 3 Mesh color number for back 4 Fabric color number for upholstery on seat 5 Options, if selected (see below) <ul style="list-style-type: none"> ▶ See <i>Surface Materials</i>, page 264.

Options	U.S. Price	Required to Specify
Surface Materials		
Upholstery		
• Fabric price group 1	No cost	Specify fabric color number.
• Fabric price group 2	+\$ 10	Specify fabric color number.
• Fabric price group 3	+\$ 22	Specify fabric color number.
• Fabric price group 4	+\$ 30	Specify fabric color number.
• Fabric price group 5	+\$ 37	Specify fabric color number.
• Fabric price group 6	+\$ 46	Specify fabric color number.
• Fabric price group 7	+\$ 54	Specify fabric color number.
• Fabric price group 8	+\$ 68	Specify fabric color number.
• Fabric price group 9	+\$ 83	Specify fabric color number.
• Fabric price group 10	+\$ 95	Specify fabric color number.
• Customer's Own Material (COM)	No cost	▶ See <i>Surface Materials Reference Manual</i> to specify.
• Steelcase leather upholstery	+\$156	Add suffix S to the style number and specify leather color number.
• Elmosoft leather upholstery	+\$182	Add suffix S to the style number and specify Elmosoft leather color number.
• Sewn upholstery	+\$ 36	Add suffix S to the style number.
• Steelcase vinyl	+\$ 36	Add suffix S to the style number and specify vinyl color number.
• Customer's Own Leather (COL)	+\$ 36	Add suffix S to the style number and specify leather color number.
• Customer's Own Vinyl (COV)	+\$ 36	Add suffix S to the style number and specify vinyl color number.
• Soil-retardant treatment applied to upholstery fabric	+\$ 21	Specify <i>with soil-retardant treatment</i> .
Frame		
• Platinum on frame	+\$ 52	Specify <i>with 4799 Platinum frame</i> .
Glides		
• Hard glides for use on carpeted floors	No cost	Specify <i>with hard glides</i> .
• Soft glides for use on non-carpeted floors	+\$ 6	Specify <i>with soft glides</i> .

Tip: Always add suffixes in alphabetical order when specifying options to Reply seating.

Tip: Glides must be selected to complete specification of the chair.

Specification Information

With Arms		Without Arms	
Style Number	U.S. Base Price	Style Number	U.S. Base Price
466482MT	\$550	466480MT	\$498

▶ Detailed dimensions, page 84



For Canadian Pricing
Multiply U.S. Price by the Canadian price factor.
▶ See page 1 for details.

Reply 466 Series Sled-Base Multi-Use Chairs

Standard Upholstery on Back and Seat

Reply 466 Series Sled-Base
Multi-Use Chairs

Standard Includes		Required to Specify
<ul style="list-style-type: none"> ▶ Need help? Product details, page 80 	<ul style="list-style-type: none"> • Frame: paint • Standard upholstery design on seat and back: fabric price group 1 • Arm caps, if selected: black 	<ol style="list-style-type: none"> 1 Style number 2 Paint color number for metal frame, and arms; if specified 3 Fabric color number for upholstery on seat and back 4 Options, if selected (see below) <ul style="list-style-type: none"> ▶ See <i>Surface Materials</i>, page 264.

Options	U.S. Price	Required to Specify	
Surface Materials	Upholstery		
<ul style="list-style-type: none"> • Fabric price group 1 • Fabric price group 2 • Fabric price group 3 • Fabric price group 4 • Fabric price group 5 • Fabric price group 6 • Fabric price group 7 • Fabric price group 8 • Fabric price group 9 • Fabric price group 10 • Customer's Own Material (COM) 	<ul style="list-style-type: none"> No cost +\$ 22 +\$ 43 +\$ 59 +\$ 75 +\$ 92 +\$107 +\$134 +\$166 +\$187 No cost 	<ul style="list-style-type: none"> Specify fabric color number. Specify fabric color number. Specify fabric color number. Specify fabric color number. Specify fabric color number. Specify fabric color number. Specify fabric color number. Specify fabric color number. Specify fabric color number. Specify fabric color number. ▶ See <i>Surface Materials Reference Manual</i> to specify. 	
<ul style="list-style-type: none"> • Steelcase leather upholstery • Elmosoft leather upholstery • Sewn upholstery • Steelcase vinyl • Customer's Own Leather (COL) • Customer's Own Vinyl (COV) • Fire Code Seating (FCS) • Soil-retardant treatment applied to upholstery fabric 	<ul style="list-style-type: none"> +\$312 +\$364 +\$ 68 +\$ 68 +\$ 68 +\$ 68 +\$ 64 +\$ 21 	<ul style="list-style-type: none"> Add suffix S to the style number and specify leather color number. Add suffix S to the style number and specify Elmosoft leather color number. Add suffix S to the style number. Add suffix S to the style number and specify vinyl color number. Add suffix S to the style number and specify leather color number. Add suffix S to the style number and specify vinyl color number. Add suffix F to the style number. Specify <i>with soil-retardant treatment</i>. 	
Frame	<ul style="list-style-type: none"> • Platinum on frame 	<ul style="list-style-type: none"> +\$ 52 Specify <i>with 4799 Platinum frame</i>. 	
Glides	<ul style="list-style-type: none"> • Hard glides for use on carpeted floors • Soft glides for use on non-carpeted floors 	<ul style="list-style-type: none"> No cost +\$ 6 	<ul style="list-style-type: none"> Specify <i>with hard glides</i>. Specify <i>with soft glides</i>.

Tip: Always add suffixes in alphabetical order when specifying options to Reply seating.

Tip: Glides must be selected to complete specification of the chair.

Specification Information

With Arms		Without Arms	
Style Number	U.S. Base Price	Style Number	U.S. Base Price
466482MH	\$498	466480MH	\$446

▶ Detailed dimensions, page 84

 **For Canadian Pricing**
Multiply U.S. Price by the Canadian price factor.
▶ See page 1 for details.



Understanding and Specifying Jersey Series Work Chair

Product Details

Jersey Series	94
Dimensions	98

Specifying

Value Package Work Chair	100
Swivel-Base Work Chairs	101
Leg-Base Multi-Use Chairs	102

Work Chairs

Highly adjustable task seating offers maximum personalization for people who sit most of the day performing repetitive tasks. By making a series of simple adjustments, you can customize the chair to your body, preferences, and tasks. These chairs provide continuous, stable, task-oriented comfort, and can be quickly adjusted to support you in upright, forward, and reclining work postures.

- Leap 462 Series
- Leap 464 Series
- WorkLounge
- Criterion 453 Series
- Think 465 Series
- Amia 482 Series
- Reply 466 Series
- Drive 461 Series
- Jersey Series

Adjustability Features

▶ See page 12 for a comparison to other chairs.

Jersey Series

Mechanisms

Synchro-tilt ●

Seat Adjustments

Pneumatic height ●

Seat angle ●

Seat depth ●

Back Adjustments

Back tension ●

Upright back lock ●

Arm Adjustments

Arm height ●

Arm width ●

Arm pivot ●

Jersey Series

Jersey features a double mesh back in a unique ergonomic “S” shape to conform to each user for comfort and support.

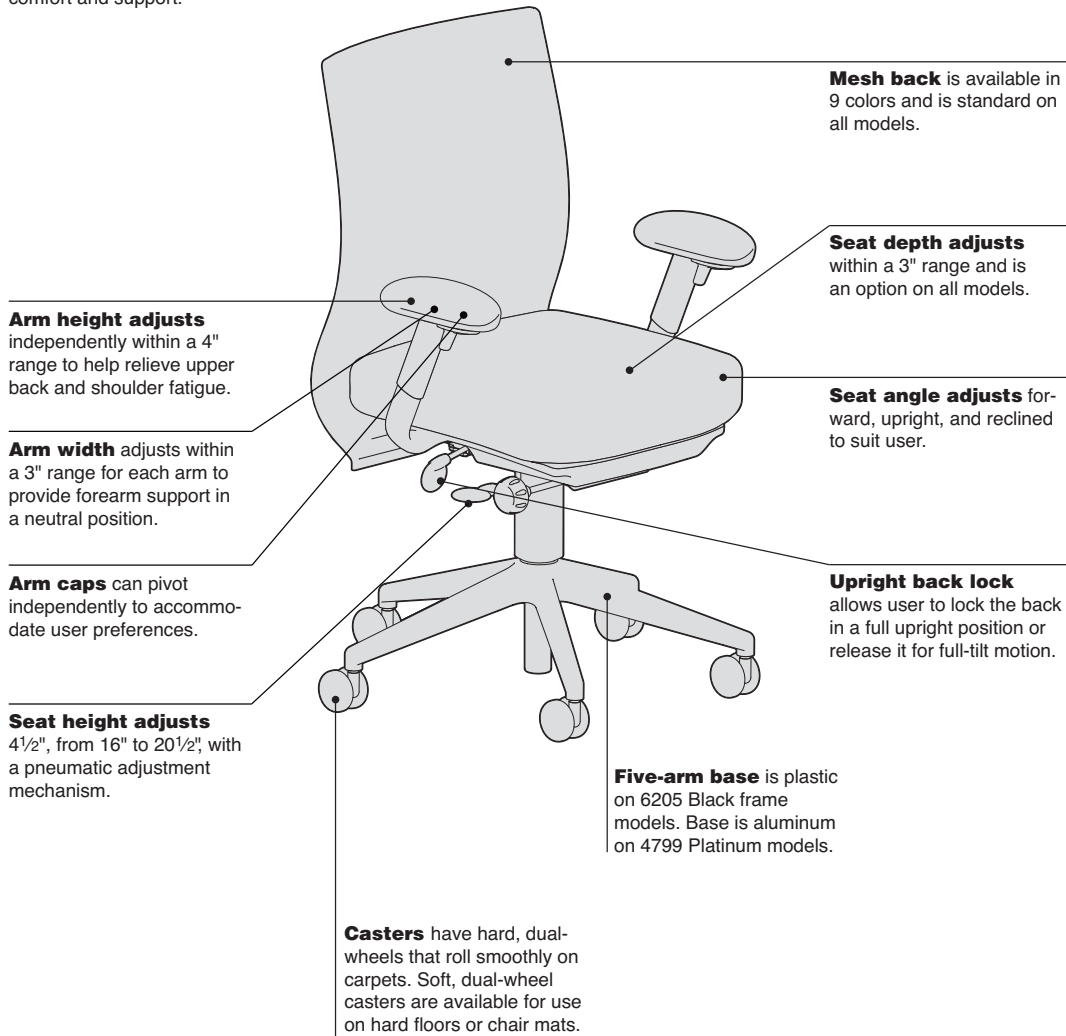

Product Details



Jersey work chairs are available armless, with fixed arms, with height and maintenance width-adjustable arms, and with height-, width-, and pivot-adjustable arms.

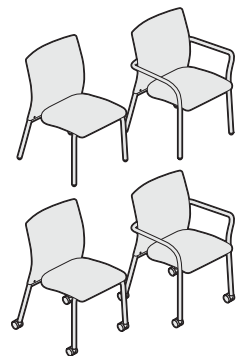

Multi-use chairs are available with or without arms and with or without casters.

Arm cap styles depend on the arm adjustment selected.

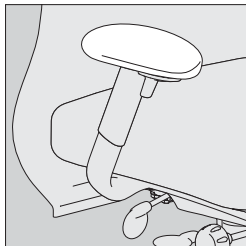

Arm cap on height-, width-, and pivot-adjustable arms.

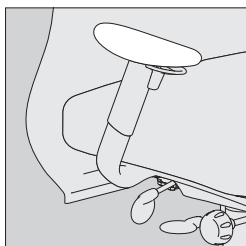

Arm cap on fixed and height and maintenance-width-adjustable arms.

Stackability for the Jersey guest chair is four high on the floor. Models with arms are 24 $\frac{1}{4}$ "W x 28 $\frac{1}{2}$ "D x 42 $\frac{1}{2}$ "H. Models without arms are 20 $\frac{5}{8}$ "W x 28 $\frac{1}{2}$ "D x 42 $\frac{1}{2}$ "H. If stacking dimensions are intended for an enclosure, add 2" to the width and depth, and 1" to the height for clearance.

Adjustment Features

Seat Adjustments

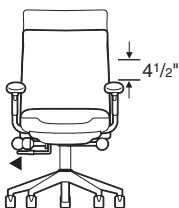

Seat height adjusts pneumatically.

To raise chair, lift body weight up, and pull lever up. To lower chair, remain seated and pull lever up.



Seat angle adjustment.

Pull lever back and hold, shift seat to desired angle, and release lever to lock.

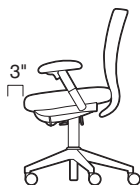

Seat depth adjustment.

Pull lever forward and hold, shift seat forward or back, and release lever to lock.

Back Adjustments



Back tension adjustment.

To decrease tension, turn counterclockwise. To increase tension, turn clockwise.



Upright back lock.

To release, lean forward and pull toward back. To lock, lean forward and push toward front.

Arm Adjustments



Arm height.

Pull trigger up and hold, pull arm up or push down, and release trigger to lock.

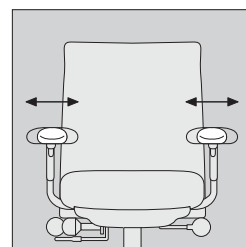

Arm width on rounded telescoping height, width, and pivot arm.

Grasp arm caps and move in or out. Arm will stay where positioned.

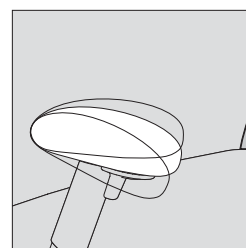

Arms pivot independently.

Grasp arm and push from front to left or right.

Maintenance arm width adjustment.

Loosen and remove screws, slide arm bracket in. Replace and tighten screws.

Surface Materials

► See surface materials on page 264 for specific availability or refer to the *Surface Materials Reference Manual* for further information.

Upholstery

- Mesh on back standard
- Fabric or leather on seat

Hard components

- (base, arms, plastic arm caps, outer seat)
- Black

Platinum frame

- (base and arm uprights) available as an option

Arms

- Black

All Steelcase seating with standard upholstery fabrics

complies with requirements of the State of California Technical Bulletin 117. All standard seating is labeled to be in compliance with California 117.

Programs & Services

▶ See the *Surface Materials Reference Manual* for further detail about programs and services offered for seating.

The Customer's Own Material (COM) Program

offers the opportunity for customers to select fabrics that are not offered through the standard Steelcase surface materials program for use on Steelcase products. Through the COM program, Steelcase will test your materials for application on Steelcase products. Once approved, you can place your order. Steelcase will facilitate the entire ordering process and give you a production schedule. Steelcase will order the COM fabric directly from the textile manufacturer. For up-to-date information regarding fabric test results for all COM fabrics and details regarding yardage requirements for most Seating lines, visit the COM Web site. To locate the COM Web site:

- Visit www.steelcase.com

Dimensions

▶ Page 98

Resources

Printed Materials

▶ Jersey Brochure (04-0000161)

Computer Tools

▶ User Guide available on www.steelcase.com

Shipping

Jersey chairs are cartoned assembled only. Uncartoned shipments are not available.

Dimensions

Jersey Series

• Features	• Overall Depth	Width	Height	• Functional Seat Depth	• Seat Width	• Seat Height from Floor	• Back Width	• Back Height from Seat
------------	-----------------	-------	--------	-------------------------	--------------	--------------------------	--------------	-------------------------

Jersey Series

Work Chairs

Pneumatic	25"	26 ¹ / ₄ "	35 ¹ / ₂ "–40"	17"*	20"	16"–20 ¹ / ₂ "	20"	18"
-----------	-----	----------------------------------	--------------------------------------	------	-----	--------------------------------------	-----	-----

Multi-Use Chairs

4-Leg with Arms	24"	24"	32 ¹ / ₄ "	17"	17 ¹ / ₂ "	17 ¹ / ₂ "	19"	15 ¹ / ₂ "
4-Leg Armless	24"	17 ¹ / ₂ "	32 ¹ / ₄ "	17"	17 ¹ / ₂ "	17 ¹ / ₂ "	19"	15 ¹ / ₂ "

*Models with seat depth adjustment measures 16³/₄"–20".

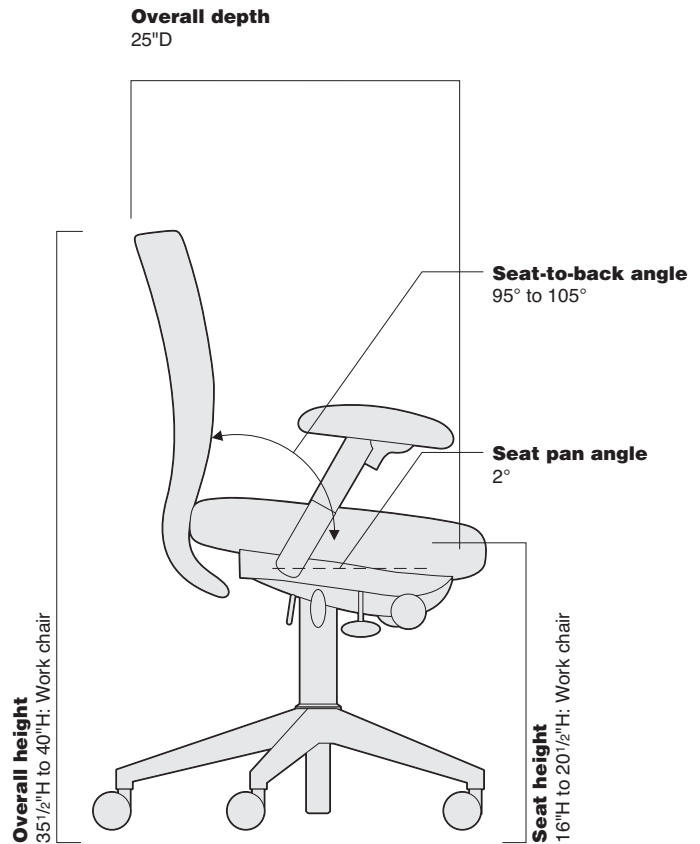
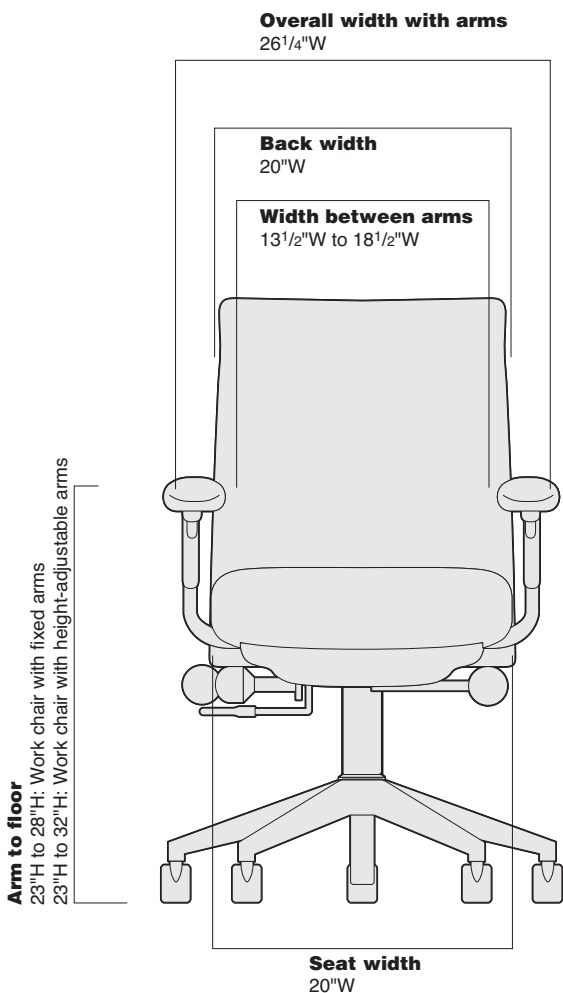

• Width • Between • Arms	• Arm to • Floor • Fixed • Arm	• Arm to • Floor • Height Adj • Arm	• Arm • Height • from Seat • Fixed Arm	• Arm • Height • from Seat • Adj-Height • Arm	• Arm Cap • Pivot • Range	• Seat • Pan • Angle	• Angle • Between • Seat and • Back
--------------------------------	---	--	---	---	---------------------------------	----------------------------	--

Work Chairs

13½"-18½"	23"-28"	23"-32"	9"	7"-11"	30°	2°	95°-105°
-----------	---------	---------	----	--------	-----	----	----------

Multi-Use Chairs

21⅝"	25½"	N.A.	7½"	N.A.	N.A.	2°	N.A.
N.A.	N.A.	N.A.	N.A.	N.A.	N.A.	N.A.	N.A.

Jersey Series Value Package Work Chair

Black Mesh on Back with Buzz2 Fabric on Seat
Black Plastic Finish on Frame



Tip: This value package allows you to obtain the pre-selected features at a lower price than if specifying as a standard model number.

Tip: Options or substitutions are not available on this value package.

Standard Includes		Required to Specify
-------------------	--	---------------------

- | | | |
|---|---|--|
| <ul style="list-style-type: none"> ▶ Need help? Product details, page 94 | <ul style="list-style-type: none"> • Deluxe synchro-tilt mechanism: provides seat depth and seat angle • Pneumatic seat-height adjustment • Upright back lock • Tilt tension • Back: T084 Black mesh • Seat: Buzz2 fabric • Height-, width-, and pivot-adjustable arms • Frame: black plastic • Hard dual-wheel casters: black | <ul style="list-style-type: none"> 1 Style number 2 Buzz2 fabric color number ▶ See <i>Surface Materials</i>, page 264. |
|---|---|--|

Specification Information	
Style Number	U.S. Price

JERSEYV	\$939
----------------	-------

▶ Detailed dimensions, page 98



For Canadian Pricing

Multiply U.S. Price by the Canadian price factor.

▶ See page 1 for details.



Standard Includes		Required to Specify
<ul style="list-style-type: none"> ▶ Need help? Product details, page 94 	<ul style="list-style-type: none"> • Synchro-tilt mechanism • Pneumatic height adjustment • Upright back lock • Tilt tension • Back: mesh • Seat: fabric • Five-arm base: reinforced black plastic • Hard dual-wheel casters: black 	<ol style="list-style-type: none"> 1 Style number 2 Mesh color number for back 3 Fabric color number for seat 4 Options, if selected (see below) <ul style="list-style-type: none"> ▶ See <i>Surface Materials</i>, page 264.

Tip: Leather, Elmosoft leather, COL, vinyl, and COV materials require a **S** suffix.

Options	U.S. Price	Required to Specify
Surface Materials <ul style="list-style-type: none"> • Jersey black fabric • Fabric price group 1 • Fabric price group 2 • Fabric price group 3 • Fabric price group 4 • Fabric price group 5 • Fabric price group 6 • Fabric price group 7 • Fabric price group 8 • Fabric price group 9 • Fabric price group 10 • Jersey black leather • Steelcase leather upholstery • Elmosoft leather upholstery • Steelcase vinyl • Customer's Own Material (COM) • Customer's Own Vinyl (COV) • Customer's Own Leather (COL) 	<ul style="list-style-type: none"> No cost No cost +\$ 10 +\$ 22 +\$ 30 +\$ 37 +\$ 46 +\$ 54 +\$ 68 +\$ 83 +\$ 95 +\$ 87 +\$150 +\$173 No cost No cost No cost 	<ul style="list-style-type: none"> Specify with 5011. Specify fabric color number. Specify fabric color number. Specify fabric color number. Specify fabric color number. Specify fabric color number. Specify fabric color number. Specify fabric color number. Specify fabric color number. Specify fabric color number. Specify fabric color number. Add suffix S to the style number and specify with L225. Add suffix S to the style number and specify leather color number. Add suffix S to the style number and specify Elmosoft leather color number. Add suffix S to the style number and specify vinyl color number. ▶ See <i>Surface Materials Reference Manual</i>. Add suffix S to the style number and specify vinyl color number. Add suffix S to the style number and specify leather color number.
Frame and Base <ul style="list-style-type: none"> • 4799 Platinum frame with aluminum base 	<ul style="list-style-type: none"> +\$ 78 	<ul style="list-style-type: none"> Specify with 4799 Platinum.
Seating Mechanism <ul style="list-style-type: none"> • Deluxe synchro-tilt mechanism: provides seat depth and seat angle 	<ul style="list-style-type: none"> +\$ 83 	<ul style="list-style-type: none"> Specify with deluxe synchro-tilt mechanism.
Fixed-Height Arms <ul style="list-style-type: none"> • Fixed-height, maintenance width-adjustable arms 	<ul style="list-style-type: none"> +\$ 93 	<ul style="list-style-type: none"> Specify with fixed-height, maintenance width-adjustable arms.
Height-Adjustable Arms <ul style="list-style-type: none"> • Height- and maintenance width-adjustable arms 	<ul style="list-style-type: none"> +\$114 	<ul style="list-style-type: none"> Specify with height- and maintenance width-adjustable arms.
Height-, Width-, and Pivot-Adjustable Arms <ul style="list-style-type: none"> • Height-, width-, and pivot-adjustable arms 	<ul style="list-style-type: none"> +\$134 	<ul style="list-style-type: none"> Specify with height-, width-, and pivot-adjustable arms.
Casters <ul style="list-style-type: none"> • Soft dual-wheel casters for use on hard floors 	<ul style="list-style-type: none"> +\$ 21 	<ul style="list-style-type: none"> Specify with soft casters.

Tip: Arms, if specified, will match frame color (7207 Black standard, 4799 Platinum optional).

▶ Detailed dimensions, page 98

For Canadian Pricing
 Multiply U.S. Price by the Canadian price factor.
 ▶ See page 1 for details.

Specification Information	
Style Number	U.S. Base Price
TS38301	\$781

Jersey Series

Jersey Series Multi-Use Chairs

Multi-Use Chair, Fabric, with Glides

Standard Includes	Required to Specify
<ul style="list-style-type: none"> ▶ Need help? Product details, page 94 • Back: mesh • Seat: fabric • Arms, if selected: black • Steel four-leg frame: black • Glides: black plastic • Stacks four high 	<ul style="list-style-type: none"> 1 Style number 2 Mesh color number for back 3 Fabric color number for seat 4 Options, if selected (see below) ▶ See <i>Surface Materials</i>, page 264.

Tip: Arms, if specified, will match frame color (7207 Black standard, 4799 Platinum optional).

Tip: Leather, Elmosoft leather, COL, vinyl, and COV materials require a **S** suffix.

Options	U.S. Price	Required to Specify									
<table border="0"> <tr> <td style="vertical-align: top;">Surface Materials</td> <td> <ul style="list-style-type: none"> • Jersey black fabric • Fabric price group 1 • Fabric price group 2 • Fabric price group 3 • Fabric price group 4 • Fabric price group 5 • Fabric price group 6 • Fabric price group 7 • Fabric price group 8 • Fabric price group 9 • Fabric price group 10 • Jersey black leather </td> <td> <ul style="list-style-type: none"> No cost No cost +\$ 10 +\$ 22 +\$ 30 +\$ 37 +\$ 46 +\$ 54 +\$ 68 +\$ 83 +\$ 95 +\$ 87 </td> <td> <ul style="list-style-type: none"> Specify with 5011. Specify fabric color number. Specify fabric color number. Specify fabric color number. Specify fabric color number. Specify fabric color number. Specify fabric color number. Specify fabric color number. Specify fabric color number. Specify fabric color number. Specify fabric color number. Add suffix S to the style number and specify with L225. Add suffix S to the style number and specify leather color number. Add suffix S to the style number and specify Elmosoft leather color number. Add suffix S to the style number and specify vinyl color number. ▶ See <i>Surface Materials Reference Manual</i>. Add suffix S to the style number and specify vinyl color number. Add suffix S to the style number and specify leather color number. </td> </tr> <tr> <td></td> <td> <ul style="list-style-type: none"> • Steelcase leather upholstery • Elmosoft leather upholstery • Steelcase vinyl • Customer's Own Material (COM) • Customer's Own Vinyl (COV) • Customer's Own Leather (COL) </td> <td> <ul style="list-style-type: none"> +\$150 +\$173 No cost No cost No cost </td> </tr> <tr> <td>Frame</td> <td> <ul style="list-style-type: none"> • 4799 Platinum aluminum frame </td> <td> <ul style="list-style-type: none"> +\$ 52 </td> <td> <ul style="list-style-type: none"> Specify with 4799 Platinum. </td> </tr> </table>	Surface Materials	<ul style="list-style-type: none"> • Jersey black fabric • Fabric price group 1 • Fabric price group 2 • Fabric price group 3 • Fabric price group 4 • Fabric price group 5 • Fabric price group 6 • Fabric price group 7 • Fabric price group 8 • Fabric price group 9 • Fabric price group 10 • Jersey black leather 	<ul style="list-style-type: none"> No cost No cost +\$ 10 +\$ 22 +\$ 30 +\$ 37 +\$ 46 +\$ 54 +\$ 68 +\$ 83 +\$ 95 +\$ 87 	<ul style="list-style-type: none"> Specify with 5011. Specify fabric color number. Specify fabric color number. Specify fabric color number. Specify fabric color number. Specify fabric color number. Specify fabric color number. Specify fabric color number. Specify fabric color number. Specify fabric color number. Specify fabric color number. Add suffix S to the style number and specify with L225. Add suffix S to the style number and specify leather color number. Add suffix S to the style number and specify Elmosoft leather color number. Add suffix S to the style number and specify vinyl color number. ▶ See <i>Surface Materials Reference Manual</i>. Add suffix S to the style number and specify vinyl color number. Add suffix S to the style number and specify leather color number. 		<ul style="list-style-type: none"> • Steelcase leather upholstery • Elmosoft leather upholstery • Steelcase vinyl • Customer's Own Material (COM) • Customer's Own Vinyl (COV) • Customer's Own Leather (COL) 	<ul style="list-style-type: none"> +\$150 +\$173 No cost No cost No cost 	Frame	<ul style="list-style-type: none"> • 4799 Platinum aluminum frame 	<ul style="list-style-type: none"> +\$ 52 	<ul style="list-style-type: none"> Specify with 4799 Platinum.
Surface Materials	<ul style="list-style-type: none"> • Jersey black fabric • Fabric price group 1 • Fabric price group 2 • Fabric price group 3 • Fabric price group 4 • Fabric price group 5 • Fabric price group 6 • Fabric price group 7 • Fabric price group 8 • Fabric price group 9 • Fabric price group 10 • Jersey black leather 	<ul style="list-style-type: none"> No cost No cost +\$ 10 +\$ 22 +\$ 30 +\$ 37 +\$ 46 +\$ 54 +\$ 68 +\$ 83 +\$ 95 +\$ 87 	<ul style="list-style-type: none"> Specify with 5011. Specify fabric color number. Specify fabric color number. Specify fabric color number. Specify fabric color number. Specify fabric color number. Specify fabric color number. Specify fabric color number. Specify fabric color number. Specify fabric color number. Specify fabric color number. Add suffix S to the style number and specify with L225. Add suffix S to the style number and specify leather color number. Add suffix S to the style number and specify Elmosoft leather color number. Add suffix S to the style number and specify vinyl color number. ▶ See <i>Surface Materials Reference Manual</i>. Add suffix S to the style number and specify vinyl color number. Add suffix S to the style number and specify leather color number. 								
	<ul style="list-style-type: none"> • Steelcase leather upholstery • Elmosoft leather upholstery • Steelcase vinyl • Customer's Own Material (COM) • Customer's Own Vinyl (COV) • Customer's Own Leather (COL) 	<ul style="list-style-type: none"> +\$150 +\$173 No cost No cost No cost 									
Frame	<ul style="list-style-type: none"> • 4799 Platinum aluminum frame 	<ul style="list-style-type: none"> +\$ 52 	<ul style="list-style-type: none"> Specify with 4799 Platinum. 								

Specification Information

Style Number	U.S. Base Price

With Arms

TS38304	\$483
----------------	-------



Without Arms

TS38305	\$444
----------------	-------



▶ Detailed dimensions, page 98

Multi-Use Chair, Fabric, with Casters

Tip: Arms, if specified, will match frame color (7207 Black standard, 4799 Platinum optional).

Standard Includes		Required to Specify
<ul style="list-style-type: none"> ▶ Need help? Product details, page 94 	<ul style="list-style-type: none"> • Back: mesh • Seat: fabric • Arms, if selected: black • Steel four-leg frame: black • Hard dual-wheel casters: black • Stacks four high 	<ul style="list-style-type: none"> 1 Style number 2 Mesh color number for back 3 Fabric color number for seat 4 Options, if selected (see below) ▶ See <i>Surface Materials</i>, page 264.

Tip: Leather, Elmosoft leather, COL, vinyl, and COV materials require a **S** suffix.

Options	U.S. Price	Required to Specify
Surface Materials		
Seat Upholstery		
• Jersey black fabric	No cost	Specify with 5011.
• Fabric price group 1	No cost	Specify fabric color number.
• Fabric price group 2	+\$ 10	Specify fabric color number.
• Fabric price group 3	+\$ 22	Specify fabric color number.
• Fabric price group 4	+\$ 30	Specify fabric color number.
• Fabric price group 5	+\$ 37	Specify fabric color number.
• Fabric price group 6	+\$ 46	Specify fabric color number.
• Fabric price group 7	+\$ 54	Specify fabric color number.
• Fabric price group 8	+\$ 68	Specify fabric color number.
• Fabric price group 9	+\$ 83	Specify fabric color number.
• Fabric price group 10	+\$ 95	Specify fabric color number.
• Jersey black leather	+\$ 87	Add suffix S to the style number and specify with L225.
• Steelcase leather upholstery	+\$150	Add suffix S to the style number and specify leather color number.
• Elmosoft leather upholstery	+\$173	Add suffix S to the style number and specify Elmosoft leather color number.
• Steelcase vinyl	No cost	Add suffix S to the style number and specify vinyl color number.
• Customer's Own Material (COM)	No cost	▶ See <i>Surface Materials Reference Manual</i> .
• Customer's Own Vinyl (COV)	No cost	Add suffix S to the style number and specify vinyl color number.
• Customer's Own Leather (COL)	No cost	Add suffix S to the style number and specify leather color number.
Frame		
• 4799 Platinum aluminum frame	+\$ 52	Specify with 4799 Platinum.
Casters		
• Soft dual-wheel casters for use on hard floors	+\$ 21	Specify with soft casters.

▶ Detailed dimensions, page 98

Specification Information

Style Number	U.S. Base Price
.....

With Arms

TS38308	\$529
.....

Without Arms

TS38309	\$493
.....





Understanding and Specifying Leap 464 Series WorkLounge Work Chairs

Product Details

Leap 464 Series WorkLounge	106
Dimensions	108

Specifying

WorkLounge and Ottoman	110
------------------------	-----

Work Chairs

Highly adjustable task seating offers maximum personalization for people who sit most of the day performing repetitive tasks. By making a series of simple adjustments, you can customize the chair to your body, preferences, and tasks. These chairs provide continuous, stable, task-oriented comfort, and can be quickly adjusted to support you in upright, forward, and reclining work postures.

- Leap 462 Series
- Leap 464 Series WorkLounge
- Criterion 453 Series
- Think 465 Series
- Amia 482 Series
- Reply 466 Series
- Drive 461 Series
- Jersey Series

Adjustability Features

▶ See page 12 for a comparison to other chairs.

Leap 464 Series

Mechanisms

Natural glide	●
---------------	---

Seat Adjustments

Pneumatic height	●
------------------	---

Back Adjustments

Lower back firmness	●
---------------------	---

Upper back tension	●
--------------------	---

Variable back stop	●
--------------------	---

Headrest with flip-up pillow	●
------------------------------	---

Leap 464 Series WorkLounge

WorkLounge—a chair designed especially for people who like to work in a deep, reclined posture.

Headrest and flip-up pillow provide neck and head support.

LiveBack moves with the shape of the user's spine as sitting positions change.

Fixed arms have extra padding to provide forearm support and comfort.

Outer back is fully upholstered.

Ribbon back frame is standard.

Lower back firmness changes the amount of firmness user feels in lower back. Requires only two complete turns.

Lumbar pillow provides extra comfort and support to the lumbar region.

Extra thick seat cushion provides extra comfort.

Upper back force requires only five complete turns and accommodates a broader range of users by allowing user to change the rate of increase in force as the user reclines.

Five-arm base is standard with glides. 3" hard or soft casters are available as options.

Variable back stop with five positions is standard.

Polished aluminum is standard on ribbon back frame, arm supports, base, and casters.

Seat height adjusts within a 3" range with a pneumatic adjustment mechanism.

Ottoman quickly and easily converts from a footrest to an auxiliary work or laptop table.

Footrest is cushioned and upholstered. Footrest surface is 15"H from the floor.

Polished aluminum is standard on post and four-arm base.

Work table, with top up, is 25"H from the floor.

Four-arm base is standard with two glides and two hard, dual-wheel casters.

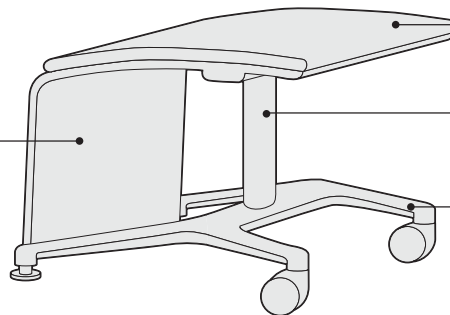
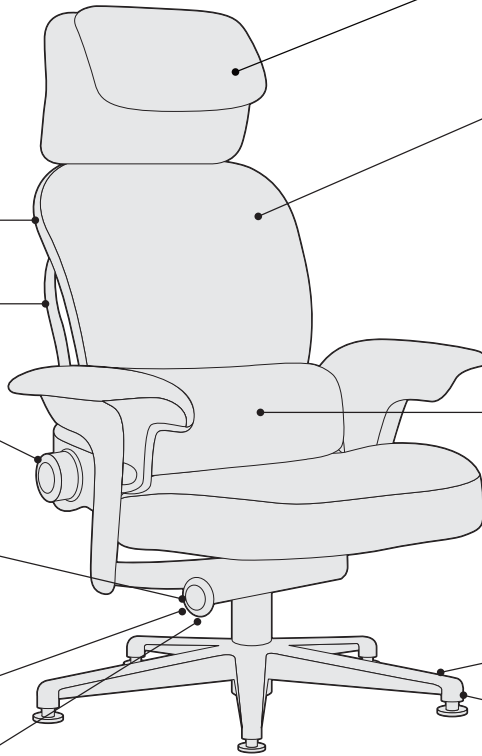

Product Details

Adjustability instructions are included with every chair and ottoman.

Controls under the seat include tactile braille designators.

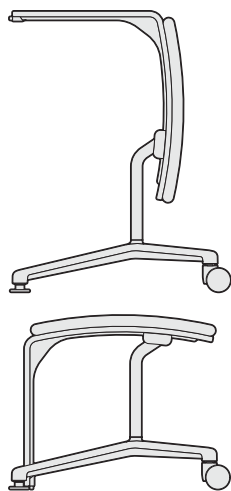

Ottoman easily converts between two positions. With the top up, it is a work or lap-top table; with the top down it is a footrest. Locking pivot mechanism holds each position in place.

Adjustment Features

Seat Adjustments

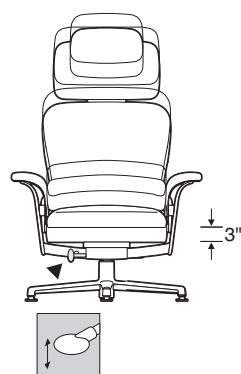

Seat height adjusts pneumatically. To lower, hold handle up while seated. To raise, hold handle up and keep your weight off the chair. This feature is standard. Range of adjustability is 3" from 15"H–18"H with standard glides and 17"H–20"H with optional casters.

Back Adjustments

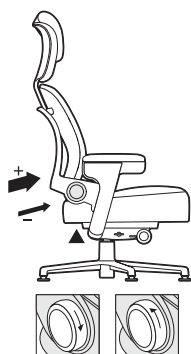

Lower back firmness adjusts by turning knob two complete turns. Forward increases firmness. Backward decreases firmness. This feature is standard.

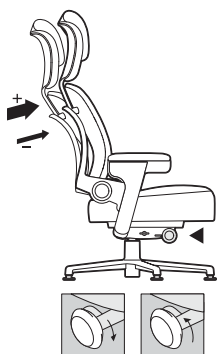

Upper back force adjusts by turning knob five complete turns. Turn knob forward to increase rate of tension; backward to decrease. This feature is standard.

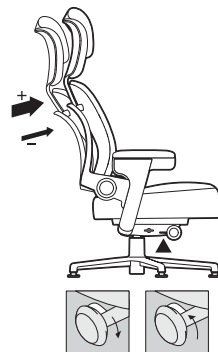

Variable back stop.

Rotate handle up or down to set recline angle. Lean back to desired back angle. Five stops are available. This feature is standard.

Tip: To stop in upright position, remove weight from back and rotate lever up.

Other Features

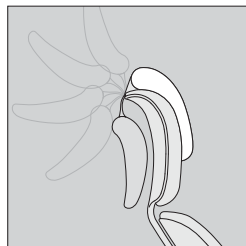

Flip-up pillow can be positioned for use on headrest or placed over the backside of headrest when not in use. This feature is standard.

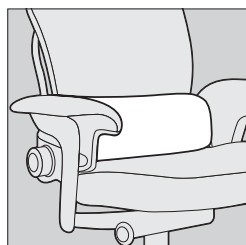

Lumbar pillow is positioned to provide comfort and support to the lumbar region.

Glides are standard.

Casters are optional. 3" polished aluminum hard- or soft-wheel casters are available.

Surface Materials

▶ See surface materials on page 264 for specific availability or refer to the *Surface Materials Reference Manual* for further information.

Upholstery

- Bo Peep fabric
- Elmorustical Leather
- Elmosoft Leather

Hard components

- (Seat shell and glides)
- 6205 Black

Polished aluminum

is standard on chair and ottoman. Polished aluminum is applied to ribbon back frame, arm supports, base, and casters of chair. Ottoman has polished aluminum on post and base.

Programs & Services

▶ See the *Surface Materials Reference Manual* for further detail about programs and services offered for seating.

The Customer's Own Material (COM & COL)

Program offers the opportunity for customers to select fabrics and leather that are not offered through the standard Steelcase surface materials program for use on Steelcase products. Avoid pattern fabrics and heavily grained leathers. Through the COM & COL program, Steelcase will test your materials for application on Steelcase products. Once approved, you can place your order. Steelcase will facilitate the entire ordering process and give you a production schedule. Steelcase will order the COM & COL fabric and leather directly from the textile manufacturer. For up-to-date information regarding fabric test results for all COM & COL fabrics and details regarding yardage requirements for most Seating lines, visit the COM Web site. To locate the COM Web site:

- Visit www.steelcase.com

Dimensions

▶ Page 108

Resources

Printed Materials

- ▶ Leap WorkLounge and Ottoman Brochure (S11526)
- ▶ Why Leap (S11014)
- ▶ Leap Brochure (05-0002313)
- ▶ Leap White Paper Packets (S11019)
- ▶ Leap Quick Reference Pocket Card (08-0000117)
- ▶ Leap User Guide available on www.steelcase.com
- ▶ Work Effectiveness Study White Papers available on in2.steelcase.com
- ▶ Humantech Case Study (03-00003715)
- ▶ Leap Productivity and Health Impact Study (03-0003716)
- ▶ Innovation Seating Brochure (04-0011870)
- ▶ Model Sales Conversation available on in2.steelcase.com
- ▶ Leap Development Story (S11124)
- ▶ Alive Seating Booklet (07-0006467)
- ▶ Leap Alive Seating Print Ad (06-0001566)
- ▶ A New Day (03-0003362)

Audiovisual Materials

- ▶ Interactive User Guide available on www.steelcase.com
- ▶ Leap mini-site (download) available on in2.steelcase.com or viewable on www.steelcase.com.
- ▶ Alive seating video (download) available on in2.steelcase.com (sales tools > seating)

Dimensions

Leap 464 Series

	Overall Depth	Width	Height	Seat Depth	Functional Seat Depth	Seat Width	Seat Height from Floor	Back Width	Back Height from Seat
Leap 464 Series									
WorkLounge									
	26 1/2"	31 1/2"	43 1/2" to 46 1/2" with glides 45 1/2" to 48 1/2" with casters	20 1/2"	18 1/2"	19"	14 1/2" to 17 1/2" with glides 16 1/2" to 19 1/2" with casters	20 1/2"	30"
Ottoman									
	19"	18 1/2"	15"	N.A.	N.A.	16 3/4"	15"	N.A.	N.A.

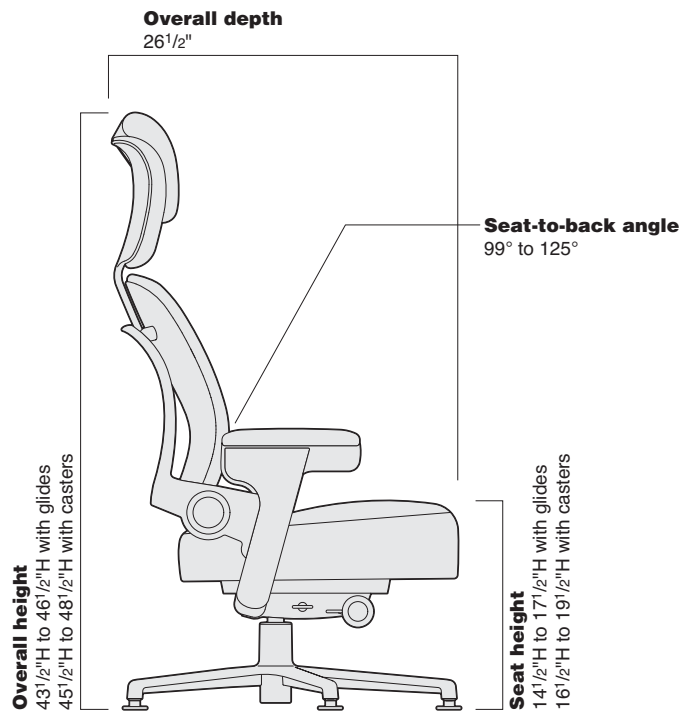
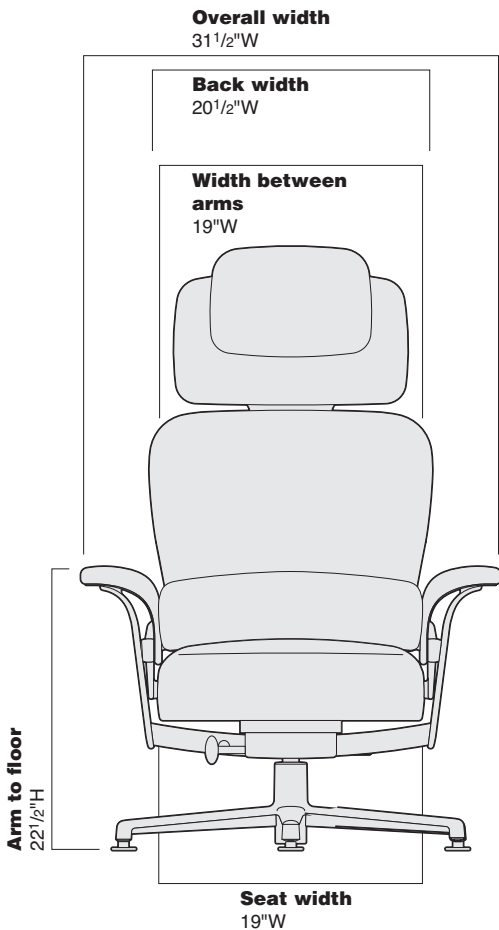

Lumbar Flex Zone	Width Between Arms	Arm to Floor	Arm Height from Seat	Angle Between Seat and Back	Table Height from Floor
------------------	--------------------	--------------	----------------------	-----------------------------	-------------------------

WorkLounge

5¼" to 10¼"	19"	22½"	7¼"	99°–125°	N.A.
-------------	-----	------	-----	----------	------

Ottoman

N.A.	N.A.	N.A.	N.A.	N.A.	25"
------	------	------	------	------	-----

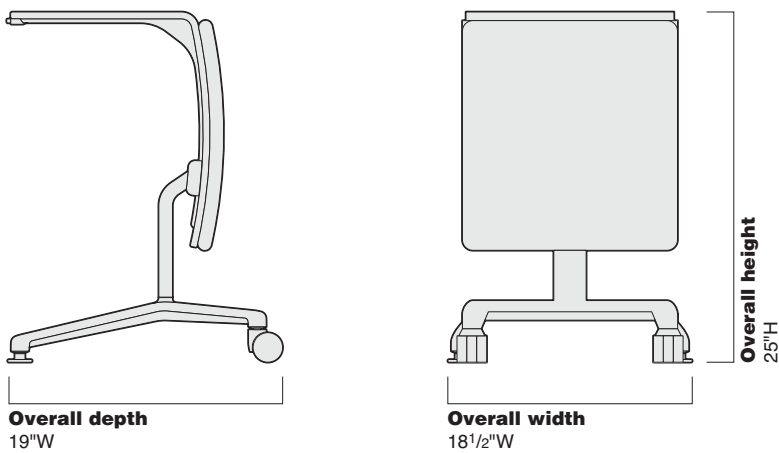
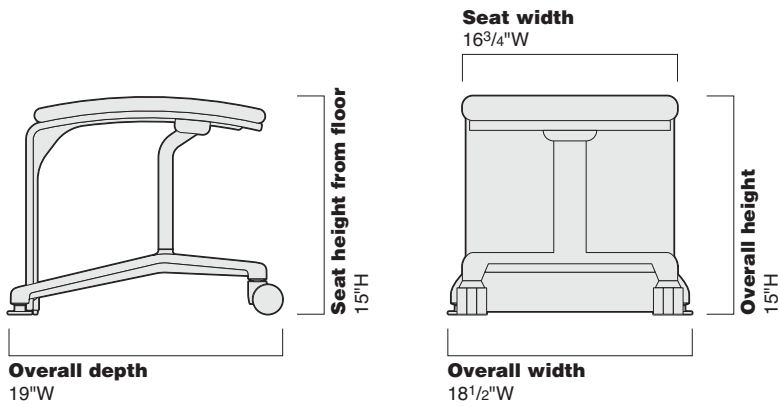

Leap 464 Series WorkLounge and Ottoman

Leap 464 Series WorkLounge

Ribbon Back Frame



	Standard Includes	Required to Specify
▶ Need help? Product details, page 106	<ul style="list-style-type: none"> Fully upholstered back, seat, arms, headrest, and flip-up pillow: Bo Peep fabric Upper back force Variable back stop Lower back firmness Lumbar pillow Fixed, non-adjustable arms 3" pneumatic seat-height adjustment Seat and back components: black plastic only Ribbon back frame, arm supports and five-arm base: polished aluminum only Glides: black with stainless steel inserts. 	1 Style number 2 Fabric color number for upholstery on back, seat, arms, headrest, and flip-up pillow 3 Options, if selected (see below) ▶ See <i>Surface Materials</i> , page 264.

	Options	U.S. Price	Required to Specify
Surface Materials	• Bo Peep	No cost	Specify Bo Peep fabric color number. ▶ See <i>Surface Materials</i> , page 264.
	• Elmorustical Leather	+\$590	Specify <i>with 59DK</i> and leather color number. ▶ See <i>Surface Materials</i> , page 264.
	• Elmosoft Leather	+\$590	▶ See <i>Surface Materials</i> , page 264.
	• Customer's Own Material (COM)	+\$ 32	▶ See <i>Surface Materials Reference Manual</i> to specify.
	• Customer's Own Leather (COL)	+\$ 32	▶ See <i>Surface Materials Reference Manual</i> to specify.
Casters	• 3" hard-composition, dual-wheel casters for use on carpet: polished aluminum and black	+\$ 62	Specify <i>with hard casters</i> .
	• 3" soft, dual-wheel casters for use on hard floors: polished aluminum and black	+\$ 62	Specify <i>with soft casters</i> .

Specification Information

• Style Number	• U.S. Base Price
464LOUNGE	\$3349

▶ Detailed dimensions, page 108



For Canadian Pricing

Multiply U.S. Price by the Canadian price factor.

▶ See page 1 for details.

Leap 464 Series Ottoman



Standard Includes		Required to Specify
<ul style="list-style-type: none"> ▶ Need help? Product details, page 106 	<ul style="list-style-type: none"> • Upholstery on footrest: Bo Peep fabric • Work table and footrest shell: black plastic only • Post and four-arm base: polished aluminum • Two glides: black with stainless steel inserts • Two 2"-diameter, hard-composition, dual-wheel casters: black 	<ol style="list-style-type: none"> 1 Style number 2 Fabric color number for upholstery on footrest 3 Options, if selected (see below) <ul style="list-style-type: none"> ▶ See <i>Surface Materials</i>, page 264.

Options	U.S. Price	Required to Specify
Surface Materials <ul style="list-style-type: none"> • Bo Peep 	No cost	Specify Bo Peep fabric color number. ▶ See <i>Surface Materials</i> , page 264.
<ul style="list-style-type: none"> • Elmorustical Leather 	+\$134	Specify with 59DK and leather color number. ▶ See <i>Surface Materials</i> , page 264.
<ul style="list-style-type: none"> • Elmosoft Leather 	+\$134	▶ See <i>Surface Materials</i> , page 264.
<ul style="list-style-type: none"> • Customer's Own Material (COM) 	+\$ 32	▶ See <i>Surface Materials Reference Manual</i> to specify.
<ul style="list-style-type: none"> • Customer's Own Leather (COL) 	+\$ 32	▶ See <i>Surface Materials Reference Manual</i> to specify.

Specification Information

Style Number	U.S. Base Price
464OTTOMAN	\$999

▶ Detailed dimensions, page 108



For Canadian Pricing
Multiply U.S. Price by the Canadian price factor.
▶ See page 1 for details.



Understanding and Specifying Siento 499 Series Work Chairs

Product Details

Siento 499 Series	114
Dimensions	114

Specifying

Design Package High-Back Executive Chair	116
Executive Desk Chairs	118

Adjustability Features

- ▶ See page 12 for a comparison to other chairs.

**Siento
499
Series**

Mechanisms

Synchro-tilt ●

Seat Adjustments

Pneumatic height ●

Passive seat edge angle ●

Back Adjustments

Back tension ●

Upright back lock ●

Siento

Siento desk chairs, designed in collaboration with Jorge Pensi, merge remarkable ergonomic comfort in a slim and sophisticated executive form.

Outer back is fully upholstered.

Patented LiveBack Technology (found in Steelcase Leap chair) is embedded in the back to change shape and mimic the user's spine.

Arms are available as either T-arms or enclosed.

Five-arm base is available in polished aluminum, platinum, or black.

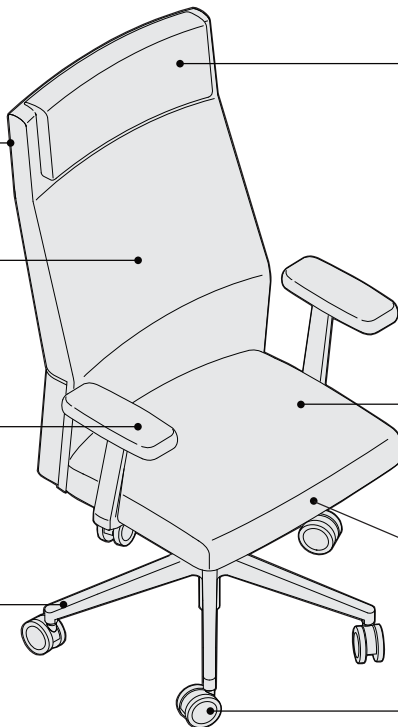

Headrest option provides additional head and neck support.

Seat height adjusts from 16" to 21" and is standard with pneumatic adjustment mechanism. Fixed-height option is also available.

Front seat edge flexes naturally to relieve pressure under the user's thighs.

3" hard dual-wheel casters are standard for use on carpet. Soft dual-wheel casters are available for use on hard floors or chair mats.

Product Details



High-back and mid-back desk chairs are available.



Arms are available as T-arms or enclosed. Fixed T-arms are available in urethane or fully upholstered. Adjustable T-arms are available in urethane only. Enclosed arms are always fully upholstered.

Adjustment Features

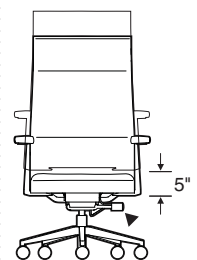

Seat height adjusts pneumatically. To lower, hold handle up while seated. To raise, hold handle up and keep your weight off the chair. Standard range of adjustability is 5" from 16"H to 21"H.



Seat edge flexes, relieving pressure under the user's thighs.

Actual Dimensions

	High-Back Desk Chairs with Headrest	High-Back Desk Chairs without Headrest	Mid-Back Desk Chairs
Overall depth	26"	26"	26"
Overall width—outside of T-arms	27½"	27½"	27½"
Overall width—outside of enclosed arms	29½"	29½"	29½"
Overall height	46¾"–51¾"	46"–51"	40"–45"
Seat depth	17½"	17½"	17½"
Seat width	21"	21"	21"
Back height from seat	31½"	30"	24"
Width between arms	20½"	20½"	20½"
Arm height from seat	8"	8"	8"

Adjustability Features

- Pneumatic seat-height
- Upright back lock
- Back tension control
- Synchro-tilt mechanism

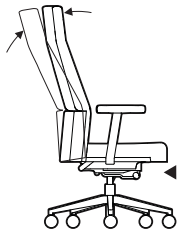

Upright back lock. Flick switch forward to lock; flick switch back to tilt.



Back tension control adjusts by turning knob. Turn knob forward to increase rate of tension, backward to decrease.

Synchro-tilt mechanism provides synchronized back movement while feet remain flat on the floor.

Height-, width-, pivot-, and depth-adjustable arms are available on select models of chairs.

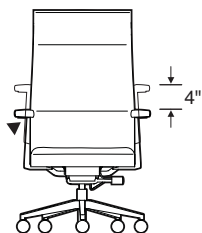

Arm height adjusts independently within a range of 4" (7"–11" from the seat). Push button on outside and under arm cap in while moving arms up or down. Releasing buttons locks arms in position.

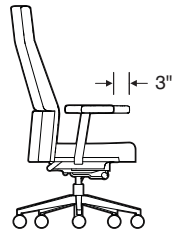

Arm depth adjusts by sliding arm caps back 3". Friction-fit mechanism keeps arms in position.

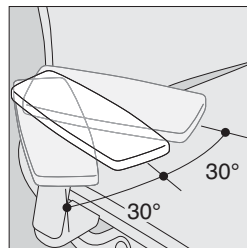

Arms pivot independently, 30° inward and outward.

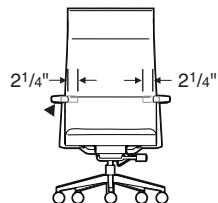

Arm width can be adjusted 2 1/4" each, 4 1/2" overall. Grasp arm cap and move in or out.

Surface Materials

Upholstery

- Fabric
- Fabric with soil-retardant treatment (option)
- Elmosoft leather
- COM
- COL

Arms

- Black urethane T-arms
- Upholstered T-arms
- Enclosed upholstered arms

Column

- Black only

Base

- 0835 Black
- 4799 Platinum
- 8046 Polished Aluminum

Casters

- Black wheels with black body on black or platinum base
- Black wheels with polished aluminum body on polished aluminum base

All Steelcase seating with standard upholstery fabrics complies with requirements of the State of California Technical Bulletin 117. All standard seating is labeled to be in compliance with California 117.

Programs & Services

▶ See the *Surface Materials Reference Manual* for further detail about programs and services offered for seating.

The Customer's Own Material (COM & COL) Program

offers the opportunity for customers to select fabrics that are not offered through the standard Steelcase surface materials program for use on Steelcase products. Through the COM and COL program, Steelcase will test your materials for application on Steelcase products. Once approved, you can place your order. Steelcase will facilitate the entire ordering process and give you a production schedule. Steelcase will order the COM and COL fabric directly from the textile manufacturer. For up-to-date information regarding fabric test results for all COM and COL fabrics and details regarding yardage requirements for most seating lines, visit the COM Web site. To locate the COM Web site:

- Visit www.steelcase.com

Soil retardants are treatments that provide long-term soil and stain resistance to a fabric without affecting the shade or the integrity of the fabric. The following Steelcase Textiles are available pre-treated with soil retardant. (You do not need to select the soil-retardant option for these fabrics and incur the upcharge.)

- Jacks
- Link
- Spyder

For information on soil retardant fabrics on Select Surfaces, please refer to the *Surface Materials Reference Manual*.

Soil-retardant treatment is available on all other seating fabrics at an additional upcharge per seating unit. To order this option, please select "Soil-Retardant Treatment" under "Optional Accessories."

For soil-retardant treatment on COMs, please select "Soil-Retardant Treatment" under "Optional Accessories." Minimums or additional yardage may be required. Please contact the vendor directly for specific information.

Extended lead times may be necessary for this service.

Contact your Steelcase Solutions Fulfillment Team Representative at (1.888.783.3522) or send an email to lineone@steelcase.com.

Fire Codes

▶ See pages 270–271 for upholstery fabrics available for use with FCS modification.

Steelcase offers Fire Code Seating modification (FCS) on nearly all seating models. The most rigorous fire codes in the nation have been developed in California, and the Steelcase FCS modification is designed to meet those codes. Fire Code Seating (FCS) indicates that a product is constructed to meet the strict fire code requirements of high public occupancy areas such as theaters, meeting rooms, and lobbies. The FCS standards will meet both the State of California Home Furnishing Technical Bulletin 133 (Cal TB 133) and Boston Fire Code (BFC). Boston adopted the California Home Furnishing Technical Bulletin TB 133 test standard in 1992.

Fire code approval:

Siento executive desk models are available in the following fabrics only:
Bo Peep
Elmosoft Leather
Hampstead
Leather

Local codes may have special requirements for upholstery.

Resources

Printed Materials

- ▶ Siento Brochure (06-0001282)

Siento Design Package High-Back Executive Chair



Tip: This design package allows you to obtain the pre-selected features at a lower price than if specifying as a standard model number.

Tip: Options or substitutions are not available on this design package.

	Standard Includes	Required to Specify
▶ Need help? Product details, page 114	<ul style="list-style-type: none"> • Back tension control • 5" pneumatic seat-height adjustment • Upright back lock • Front seat edge flex • LiveBack Technology • T-arms: upholstered • Headrest • Upholstery: Elmosoft leather • Five-arm base and arm supports: 8046 Polished Aluminum • Column: black only • 3"-diameter, hard composition, dual-wheel aluminum casters: black wheels with polished aluminum body 	1 Style number 2 Elmosoft leather color number ▶ See <i>Surface Materials</i> , page 264.

Specification Information

Style Number	U.S. Price
499SIENTO	\$2876

▶ Detailed dimensions,
page 114



For Canadian Pricing

Multiply U.S. Price by the Canadian price factor.

▶ See page 1 for details.

Siento Executive Desk Chairs



Tip: When a black or platinum painted base is specified, the casters will be black. When a polished aluminum base is specified, the casters will have black wheels with polished aluminum body.

Tip: Always add suffixes in alphabetical order when specifying options to Siento seating.

Tip: When the standard polished aluminum base is specified along with adjustable T-arms, you must specify the finish for arm uprights in either 6205 Black or 6249 Platinum.

Tip: When base and adjustable T-arms are specified in 4799 Platinum, the arm upright will be in 4799 Platinum and the lower section of the arm will be in 6205 Black.

Tip: Fully upholstered option is available on fixed T-arm style numbers only.



► Detailed dimensions, page 114

 **For Canadian Pricing**
Multiply U.S. Price by the Canadian price factor.
► See page 1 for details.

Standard Includes	Required to Specify
<p>► Need help? Product details, page 114</p> <ul style="list-style-type: none"> • Back tension control • 5" pneumatic seat-height adjustment • Upright back lock • Front seat edge flex • LiveBack Technology • Fully upholstered outer back • Adjustable arms, if selected: soft black urethane • T-arms, if selected: soft black urethane • Enclosed arms, if selected: fully upholstered • Upholstery: fabric price group 1 • Five-arm base and arm supports: paint or Polished Aluminum • Column: black only • 3"-diameter, hard-composition, dual-wheel casters: black 	<ol style="list-style-type: none"> 1 Style number 2 Paint color number for base and arm supports 3 Fabric color number for upholstery 4 Options, if selected (see below) <p>► See <i>Surface Materials</i>, page 264.</p>



Options	U.S. Price	Required to Specify
<p>Surface Materials</p> <p>Upholstery</p> <ul style="list-style-type: none"> • Fabric price group 1 No cost • Fabric price group 2 +\$ 22 • Fabric price group 3 +\$ 43 • Fabric price group 4 +\$ 59 • Fabric price group 5 +\$ 75 • Fabric price group 6 +\$ 92 • Fabric price group 7 +\$107 • Fabric price group 8 +\$134 • Fabric price group 9 +\$166 • Fabric price group 10 +\$187 • Customer's Own Material (COM) +\$ 32 • Steelcase leather upholstery +\$520 <p>• Customer's Own Leather (COL) +\$ 32</p> <p>• Elmosoft leather +\$728</p> <p>• Fire Code Seating (FCS) +\$ 64</p> <p>• Soil-retardant treatment applied to upholstery fabric +\$ 21</p> <p>T-arms</p> <ul style="list-style-type: none"> • Fully upholstered T-arms +\$ 83 <p>Base and casters</p> <ul style="list-style-type: none"> • 0835 Black base and black casters No cost • 4799 Platinum base and black casters +\$ 78 		<p>Specify fabric color number.</p> <p>Specify fabric color number.</p> <p>Specify fabric color number.</p> <p>Specify fabric color number.</p> <p>Specify fabric color number.</p> <p>Specify fabric color number.</p> <p>Specify fabric color number.</p> <p>Specify fabric color number.</p> <p>Specify fabric color number.</p> <p>► See <i>Surface Materials Reference Manual</i>. Add suffix S to the style number and specify leather color number.</p> <p>Add suffix S to the style number and specify leather color number.</p> <p>Add suffix S to the style number and specify Elmosoft leather color number.</p> <p>► See <i>Surface Materials</i>, page 264. Add suffix F to the style number and specify <i>with fire code seating</i>.</p> <p>► Pages 270–271</p> <p>Specify <i>with soil-retardant treatment</i>.</p> <p>Specify <i>with fully upholstered T-arms</i>.</p> <p>Specify <i>with 0835 Black base</i>.</p> <p>Specify <i>with 4799 Platinum base</i>.</p>
<p>Seat Height</p> <ul style="list-style-type: none"> • 18" fixed seat height No cost 		Specify <i>with fixed seat height</i> .
<p>Headrest</p> <ul style="list-style-type: none"> • Headrest on high-back chairs only +\$110 		Specify <i>with headrest</i> .
<p>Casters</p> <ul style="list-style-type: none"> • Soft, dual-wheel casters for use on hard floors +\$ 21 		Specify <i>with soft casters</i> .

Specification Information

	Fixed T-Arms		Enclosed Upholstered Arms		Adjustable T-Arms	
						
• Description	• Style Number	• U.S. Base Price	• Style Number	• U.S. Base Price	• Style Number	• U.S. Base Price

High-Back Chairs

Painted Base	499211	\$1681	499212	\$1901	499213	\$1941
Polished Aluminum Base	499221	\$2012	499222	\$2232	499223	\$2272

	Fixed T-Arms		Enclosed Upholstered Arm		Adjustable T-Arms	
						
• Description	• Style Number	• U.S. Base Price	• Style Number	• U.S. Base Price	• Style Number	• U.S. Base Price

Mid-Back Chairs

Painted Base	499111	\$1571	499112	\$1791	499113	\$1831
Polished Aluminum Base	499121	\$1902	499122	\$2122	499123	\$2162



For Canadian Pricing
 Multiply U.S. Price by the Canadian price factor.
 ▶ See page 1 for details.



Understanding and Specifying Cachet 487 Series Work Chairs

Product Details

Cachet 487 Series	122
Dimensions	124

Specifying

Swivel-Base Work Chairs	126
Leg-Base Multi-Use Chairs	128
Swivel-Base Stools	130
Cushion Upholstery Packages	132
Accessories	135

Work Chairs

Cachet offers basic ergonomic comfort for people who have varied tasks and tend to be in and out of the office during the day. Features include adjustable seat height and a unique Balanced-Action Rocker (BAR) mechanism that allows users to recline easily without a manual adjustment. Also featured is the no front-rise seat—in other words, when you lean back, the front edge of the seat doesn't rise up, lifting your legs off the floor and cutting off circulation.

- Protégé 433 Series
- Cachet 487 Series

Adjustability Features

▶ See page 12 for a comparison to other chairs

Cachet 487 Series

Mechanisms

Balanced Action Rocker (BAR)	●
------------------------------	---

Seat Adjustments

Pneumatic height	●
------------------	---

Back Adjustments

Self adjusts	●
--------------	---

Other Features

Foot ring height (stool)	●
--------------------------	---

Cachet 487 Series

Cachet chairs are lightweight, extremely comfortable, multipurpose chairs with a unique Balanced-Action Rocker (BAR) mechanism that allows the chair to recline in response to the user's weight.

Flexible, contoured back and seat have parallel slats that conform to individual users.

Nylon injection-molded tubular frame provides strength with minimal weight.

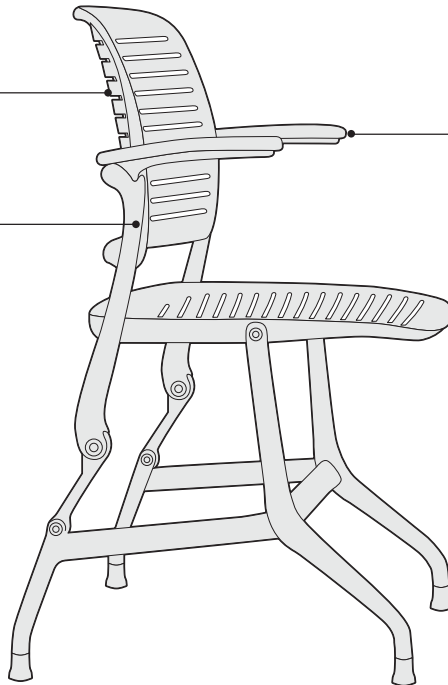

Flip-up arms easily lift to move out of the way or to allow for stacking.

Balanced-action rocker (BAR) mechanism allows every user to fully recline.

Five-arm base is standard.



Seat height adjusts within a 5" range (15½"H to 20½"H) with a pneumatic-adjustment mechanism.

Hard, dual-wheel casters are standard for use on carpets. Soft, dual-wheel roll-control casters are available for use on hard floors or chair mats.

Product Details



Chair bases are available in three styles—fixed-height four leg, adjustable-height swivel, and adjustable-height stool.



Balanced-action rocker (BAR) mechanism allows the user to recline for optimum comfort.



Upholstered cushions are available for use on chair back and seat. Cushions can be specified for factory installation or ordered separately for field installation. When specified with the chair, cushions are available for seat and back, or seat only. When ordered separately, cushions are available for seat and back, seat only, or back only. The cushions attach to the slats of back and seat.

Tip: You must specify plastic outer back color to match chair.

Soft dual-wheel roll-control casters are available as an option for use on hard floors or chair mats. Roll-control casters feature an internal brake that activates when the chair is not under load to reduce shifting when user stands up.

Hard plastic glides are standard on leg-base chairs.

Soft glides are available as an option for use on non-carpeted surfaces. The soft glide is reversible—soft on one side, hard on the other.

Leg-base chairs stack five high on the floor and 20 high on the dolly. Upholstery does not impact stacking capacity.

Leg-base chairs are available with or without flip-up arms. Chairs with or without arms can be stacked.

Other Features

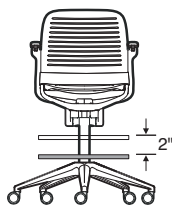

Foot ring height on stools adjusts by first lifting ring and rotating it counter-clockwise to unlock. Then raise or lower ring up to 2" to desired position before rotating it clockwise to lock. The foot ring has a diameter of 20".

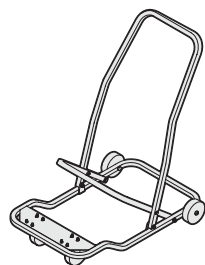

Transport and storage dolly is available to stack, move, and store up to 20 leg-base chairs. Upholstery does not impact stacking capacity. Swivel-base chairs will not stack.

Unloaded transport dolly measures 48"D x 23"W x 38¾"H.

Fully loaded transport dolly measures 51"D x 23"W x 78¾"H.

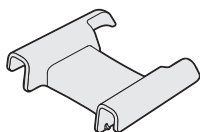

Ganging and alignment device is available to link leg-base chairs together in the field for evenly spaced rows. Chairs can be separated easily. Spacing between chairs linked with alignment device is 2".

Tip: You must specify plastic color of ganging and alignment device to match chairs.

Cachet is recommended for indoor use only.

Surface Materials

▶ See surface materials on page 264 for specific availability or refer to the *Surface Materials Reference Manual* for further information.

Hard components

(frame, flip-up arms, back, seat, and base)

- Swivel and 4-leg chair models available in black, midnight, and ash
- Stool available in black only

Upholstery

- Fabric
- Fabric with soil-retardant treatment (option)
- Leather
- ElmoSoft leather
- Vinyl

Glides

- Color-matched plastic on leg-base chair
- Color-matched soft plastic on leg-base chair (option)

Casters

- Hard, black plastic wheels on swivel-base chair and stool
- Soft, dual-wheel roll-control black plastic wheels (option)

All Steelcase seating with standard upholstery fabrics complies with requirements of the State of California Technical Bulletin 117. All standard seating is labeled to be in compliance with California 117.

Programs & Services

▶ See the *Surface Materials Reference Manual* for further detail about programs and services offered for seating.

The Customer's Own Material (COM)

Program offers the opportunity for customers to select fabrics that are not offered through the standard Steelcase surface materials program for use on Steelcase products. Through the COM program, Steelcase will test your materials for application on Steelcase products. Once approved, you can place your order. Steelcase will facilitate the entire ordering process and give you a production schedule. Steelcase will order the COM fabric directly from the textile manufacturer. For up-to-date information regarding fabric test results for all COM fabrics and details regarding yardage requirements for most Seating lines, visit the COM Web site. To locate the COM Web site:

- Visit www.steelcase.com

Soil retardants are treatments that provide long-term soil and stain resistance to a fabric without affecting the shade or the integrity of the fabric. The following Steelcase Textiles are available pre-treated with soil retardant. (You do not need to select the soil-retardant option for these fabrics and incur the upcharge.)

- Jacks
- Link
- Spyder

For information on soil retardant fabrics on Select Surfaces, please refer to the *Surface Materials Reference Manual*.

Soil-retardant treatment is available on all other seating fabrics at an additional upcharge per seating unit. To order this option, please select "Soil-Retardant Treatment" under "Optional Accessories."

For soil-retardant treatment on COMs, please select "Soil-Retardant Treatment" under "Optional Accessories." Minimums or additional yardage may be required. Please contact the vendor directly for specific information.

Extended lead times may be necessary for this service.

Contact your Steelcase Solutions Fulfillment Team Representative at 1.888.STEELCASE (1.888.783.3522) or send an email to lineone@steelcase.com.

Fire Codes

▶ See pages 270–271 for upholstery fabrics available for use with FCS modification.

Fire Code Seating (FCS) option

is available on non-upholstered models. FCS is also available on upholstered models with certain fabric choices only. ▶ See *Surface Materials*, page 264.

Steelcase offers Fire Code Seating modification (FCS) on nearly all seating models. The most rigorous fire codes in the nation have been developed in California, and the Steelcase FCS modification is designed to meet those codes. Fire Code Seating (FCS) indicates that a product is constructed to meet the strict fire code requirements of high public occupancy areas such as theaters, meeting rooms, and lobbies. The FCS standards will meet both the State of California Home Furnishing Technical Bulletin 133 (Cal TB 133) and Boston Fire Code (BFC). Boston adopted the California Home Furnishing Technical Bulletin TB 133 test standard in 1992.

Local codes may have special requirements for upholstery.

Dimensions

▶ Page 124

Resources

Printed Materials

▶ Cachet Product Brochure (08-0001115)

Dimensions

Cachet 487 Series

Features	Overall Depth	Width	Height	Seat Depth	Functional Seat Depth	Seat Width*	Seat Height from Floor	Back Width	Back Height from Seat	Back Lumbar Height
Cachet 487 Series										
Leg-Base Multi-Use Chairs										
Fixed-Height	20½"	23"	34¼"	19¾"	16⅞"	16⅜"	17⅝"	18½"	18¾"	8"
Swivel-Base Work Chairs										
Pneumatic	25"	25"	32⅛"–37⅛"	19¾"	16⅞"	16⅜"	15½"–20½"	18½"	18¾"	8"
Stools										
	25"	25"	39"–46"	19¾"	16⅞"	16⅜"	23"–30"	18½"	18¾"	8"

* **Seat width dimension** is taken close to the front edge of the seat. The dimension closer to the actual sitting surface is 19".

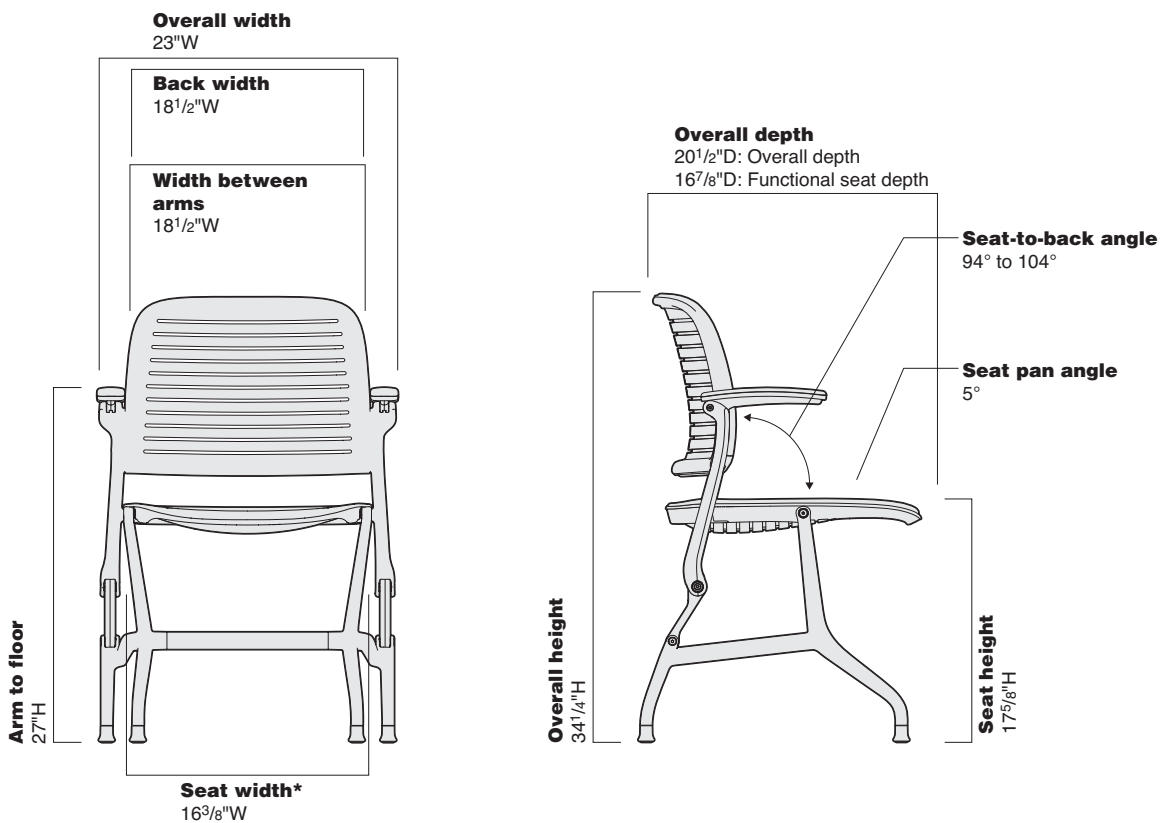

Leg-Base Multi-Use Chair

Width Between Arms	Arm to Floor	Arm Height from Seat	Seat Pan Angle	Angle Between Seat and Back
--------------------	--------------	----------------------	----------------	-----------------------------

Leg-Base Multi-Use Chairs

18 1/2"	27"	10 3/4"	5°	94°–104°
---------	-----	---------	----	----------

Swivel-Base Work Chairs

18 1/2"	25"–30"	10 3/4"	5°	94°–107°
---------	---------	---------	----	----------

Stools

18 1/2"	33"–40"	10 3/4"	5°	94°–107°
---------	---------	---------	----	----------

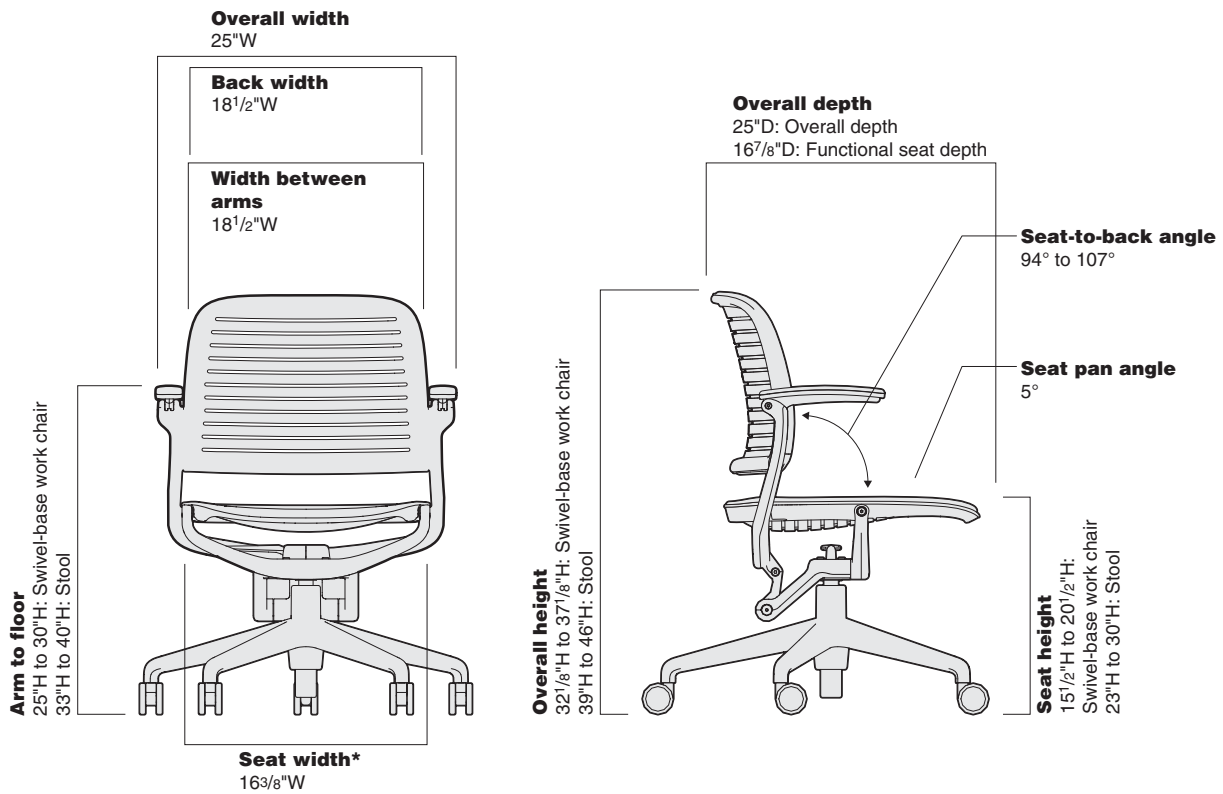

Swivel-Base Work Chair

Cachet 487 Series Swivel-Base Work Chairs



Tip: Fire Code Seating (FCS) option is available on non-upholstered models with 6205 black plastic components. FCS is also available on upholstered models with certain fabric choices only.

▶ Pages 270–271

▶ Detailed dimensions, page 124



For Canadian Pricing
Multiply U.S. Price by the Canadian price factor.
▶ See page 1 for details.

Standard Includes		Required to Specify	
▶ Need help? Product details, page 122	<ul style="list-style-type: none"> Balanced-action rocker (BAR) mechanism Frame, seat, back, flip-up arms, and five-arm base: plastic 5" pneumatic seat-height adjustment Upholstery, if selected: fabric price group 1 2$\frac{3}{8}$" diameter, hard composition, dual-wheel casters: black plastic 	<ol style="list-style-type: none"> Style number Plastic color number for frame, seat, back, flip-up arms, and five-arm base Fabric color number for upholstery on seat and back, or seat, if selected Options, if selected (see below) <p>▶ See <i>Surface Materials</i>, page 264.</p>	
Surface Materials	Options	U.S. Price	Required to Specify
	Non-upholstered chair		
	• Fire Code Seating (FCS)	+\$ 38	Add suffix F to the style number.
	Upholstery on seat		
	• Fabric price group 1	No cost	Specify fabric color number.
	• Fabric price group 2	+\$ 10	Specify fabric color number.
	• Fabric price group 3	+\$ 22	Specify fabric color number.
	• Fabric price group 4	+\$ 30	Specify fabric color number.
	• Fabric price group 5	+\$ 37	Specify fabric color number.
	• Fabric price group 6	+\$ 46	Specify fabric color number.
	• Fabric price group 7	+\$ 54	Specify fabric color number.
	• Fabric price group 8	+\$ 68	Specify fabric color number.
	• Fabric price group 9	+\$ 83	Specify fabric color number.
	• Fabric price group 10	+\$ 95	Specify fabric color number.
	• Customer's Own Material (COM)	No cost	▶ See <i>Surface Materials Reference Manual</i> to specify.
	• Steelcase leather upholstery	+\$ 80	Add suffix S to the style number and specify leather color number.
	• Elmosoft leather upholstery	+\$ 93	Add suffix S to the style number and specify Elmosoft leather color number.
	• Customer's Own Leather (COL)	No cost	Add suffix S to the style number and specify leather color number.
			▶ See <i>Surface Materials Reference Manual</i> to specify.
	• Fire Code Seating (FCS)	+\$ 50	Add suffix F to the style number.
	• Soil-retardant treatment applied to upholstery fabric	+\$ 21	Specify <i>with soil-retardant treatment</i> .
	Upholstery on seat and back		
	• Fabric price group 1	No cost	Specify fabric color number.
	• Fabric price group 2	+\$ 22	Specify fabric color number.
	• Fabric price group 3	+\$ 43	Specify fabric color number.
	• Fabric price group 4	+\$ 59	Specify fabric color number.
	• Fabric price group 5	+\$ 75	Specify fabric color number.
	• Fabric price group 6	+\$ 92	Specify fabric color number.
	• Fabric price group 7	+\$107	Specify fabric color number.
	• Fabric price group 8	+\$134	Specify fabric color number.
	• Fabric price group 9	+\$166	Specify fabric color number.
	• Fabric price group 10	+\$187	Specify fabric color number.
	• Customer's Own Material (COM)	No cost	▶ See <i>Surface Materials Reference Manual</i> to specify.
	• Steelcase leather upholstery	+\$161	Add suffix S to the style number and specify leather color number.
	• Elmosoft leather upholstery	+\$186	Add suffix S to the style number and specify Elmosoft leather color number.
	• Customer's Own Leather (COL)	No cost	Add suffix S to the style number and specify leather color number.
			▶ See <i>Surface Materials Reference Manual</i> to specify.
	• Fire Code Seating (FCS)	+\$ 64	Add suffix F to the style number.
	• Soil-retardant treatment applied to upholstery fabric	+\$ 21	Specify <i>with soil-retardant treatment</i> .
Casters	• Soft, dual-wheel roll-control casters for use on hard floors: black plastic	+\$ 21	Specify <i>with soft roll-control casters</i> .

Specification Information

Without Upholstery



• **Style Number**
• **U.S. Base Price**

4871110 \$650

With Upholstered Seat



• **Style Number**
• **U.S. Base Price**

4871210 \$780

With Upholstered Seat and Back



• **Style Number**
• **U.S. Base Price**

4871211 \$842



For Canadian Pricing
Multiply U.S. Price by the Canadian price factor.
▶ See page 1 for details.

Cachet 487 Series Leg-Base Multi-Use Chairs

Without Arms or with Flip-Up Arms



Tip: Fire Code Seating (FCS) option is available on non-upholstered models with 6205 black plastic components. FCS is also available on upholstered models with certain fabric choices only.

► Pages 270–271

► Detailed dimensions, page 124



For Canadian Pricing
Multiply U.S. Price by the Canadian price factor.

► See page 1 for details.

Standard Includes		Required to Specify
► Need help? Product details, page 122	<ul style="list-style-type: none"> Balanced-action rocker (BAR) mechanism Frame, seat, back, and four-leg base: plastic Flip-up arms, if selected: plastic color to match frame, seat, and four-leg base Upholstery, if selected: fabric price group 1 Hard glides: color-matched to frame 	<ol style="list-style-type: none"> Style number Plastic color number for frame, seat, back, four-leg base, and flip-up arms, if selected Fabric color number for upholstery on seat and back, or seat, if selected Options, if selected (see below) <p>► See <i>Surface Materials</i>, page 264.</p>

Options	U.S. Price	Required to Specify
Surface Materials		
Non-upholstered chair		
• Fire Code Seating (FCS)	+\$ 38	Add suffix F to the style number.
Upholstery on seat		
• Fabric price group 1	No cost	Specify fabric color number.
• Fabric price group 2	+\$ 10	Specify fabric color number.
• Fabric price group 3	+\$ 22	Specify fabric color number.
• Fabric price group 4	+\$ 30	Specify fabric color number.
• Fabric price group 5	+\$ 37	Specify fabric color number.
• Fabric price group 6	+\$ 46	Specify fabric color number.
• Fabric price group 7	+\$ 54	Specify fabric color number.
• Fabric price group 8	+\$ 68	Specify fabric color number.
• Fabric price group 9	+\$ 83	Specify fabric color number.
• Fabric price group 10	+\$ 95	Specify fabric color number.
• Customer's Own Material (COM)	No cost	► See <i>Surface Materials Reference Manual</i> to specify.
• Steelcase leather upholstery	+\$ 80	Add suffix S to the style number and specify leather color number.
• Elmosoft leather upholstery	+\$ 93	Add suffix S to the style number and specify Elmosoft leather color number.
• Customer's Own Leather (COL)	No cost	Add suffix S to the style number and specify leather color number.
		► See <i>Surface Materials Reference Manual</i> to specify.
• Fire Code Seating (FCS)	+\$ 50	Add suffix F to the style number.
• Soil-retardant treatment applied to upholstery fabric	+\$ 21	Specify <i>with soil-retardant treatment</i> .
Upholstery on seat and back		
• Fabric price group 1	No cost	Specify fabric color number.
• Fabric price group 2	+\$ 22	Specify fabric color number.
• Fabric price group 3	+\$ 43	Specify fabric color number.
• Fabric price group 4	+\$ 59	Specify fabric color number.
• Fabric price group 5	+\$ 75	Specify fabric color number.
• Fabric price group 6	+\$ 92	Specify fabric color number.
• Fabric price group 7	+\$107	Specify fabric color number.
• Fabric price group 8	+\$134	Specify fabric color number.
• Fabric price group 9	+\$166	Specify fabric color number.
• Fabric price group 10	+\$187	Specify fabric color number.
• Customer's Own Material (COM)	No cost	► See <i>Surface Materials Reference Manual</i> to specify.
• Steelcase leather upholstery	+\$161	Add suffix S to the style number and specify leather color number.
• Elmosoft leather upholstery	+\$186	Add suffix S to the style number and specify Elmosoft leather color number.
• Customer's Own Leather (COL)	No cost	Add suffix S to the style number and specify leather color number.
		► See <i>Surface Materials Reference Manual</i> to specify.
• Fire Code Seating (FCS)	+\$ 64	Add suffix F to the style number.
• Soil-retardant treatment applied to upholstery fabric	+\$ 21	Specify <i>with soil-retardant treatment</i> .
Glides		
• Soft glides: color matched to frame	+\$ 10	Specify <i>with soft glides</i> .

Specification Information

Without Upholstery



• **Style Number**
 • **U.S. Base Price**

With Upholstered Seat



• **Style Number**
 • **U.S. Base Price**

With Upholstered Seat and Back



• **Style Number**
 • **U.S. Base Price**

Without Arms

4878100 \$390

4878200 \$520

4878201 \$582

Without Upholstery



• **Style Number**
 • **U.S. Base Price**

With Upholstered Seat



• **Style Number**
 • **U.S. Base Price**

With Upholstered Seat and Back



• **Style Number**
 • **U.S. Base Price**

With Flip-Up Arms

4878110 \$494

4878210 \$624

4878211 \$686



For Canadian Pricing
 Multiply U.S. Price by the
 Canadian price factor.
 ▶ See page 1 for details.

Cachet 487 Series Swivel-Base Stools



Tip: Fire Code Seating (FCS) option is available on non-upholstered models with 6205 black plastic components. FCS is also available on upholstered models with certain fabric choices only.

▶ Pages 270–271

▶ Detailed dimensions, page 124



For Canadian Pricing
Multiply U.S. Price by the Canadian price factor.

▶ See page 1 for details.

Standard Includes		Required to Specify	
▶ Need help? Product details, page 122	<ul style="list-style-type: none"> Balanced-action rocker (BAR) mechanism Frame, seat, back, flip-up arms, and five-arm base: black plastic 7¾" pneumatic seat-height adjustment Upholstery, if selected: fabric price group 1 2⅜" diameter, hard composition, dual-wheel casters: black plastic 	<ol style="list-style-type: none"> Style number Fabric color number for upholstery on seat and back, or seat, if selected Options, if selected (see below) 	▶ See <i>Surface Materials</i> , page 264.
Surface Materials	Options	U.S. Price	Required to Specify
	Non-upholstered chair		
	• Fire Code Seating (FCS)	+\$ 38	Add suffix F to the style number.
	Upholstery on seat		
	• Fabric price group 1	No cost	Specify fabric color number.
	• Fabric price group 2	+\$ 10	Specify fabric color number.
	• Fabric price group 3	+\$ 22	Specify fabric color number.
	• Fabric price group 4	+\$ 30	Specify fabric color number.
	• Fabric price group 5	+\$ 37	Specify fabric color number.
	• Fabric price group 6	+\$ 46	Specify fabric color number.
	• Fabric price group 7	+\$ 54	Specify fabric color number.
	• Fabric price group 8	+\$ 68	Specify fabric color number.
	• Fabric price group 9	+\$ 83	Specify fabric color number.
	• Fabric price group 10	+\$ 95	Specify fabric color number.
	• Customer's Own Material (COM)	No cost	▶ See <i>Surface Materials Reference Manual</i> to specify.
	• Steelcase leather upholstery	+\$ 80	Add suffix S to the style number and specify leather color number.
	• Elmosoft leather upholstery	+\$ 93	Add suffix S to the style number and specify Elmosoft leather color number.
	• Customer's Own Leather (COL)	No cost	Add suffix S to the style number and specify leather color number.
	• Fire Code Seating (FCS)	+\$ 50	▶ See <i>Surface Materials Reference Manual</i> to specify.
	• Soil-retardant treatment applied to upholstery fabric	+\$ 21	Add suffix F to the style number. Specify <i>with soil-retardant treatment</i> .
	Upholstery on seat and back		
	• Fabric price group 1	No cost	Specify fabric color number.
	• Fabric price group 2	+\$ 22	Specify fabric color number.
	• Fabric price group 3	+\$ 43	Specify fabric color number.
	• Fabric price group 4	+\$ 59	Specify fabric color number.
	• Fabric price group 5	+\$ 75	Specify fabric color number.
	• Fabric price group 6	+\$ 92	Specify fabric color number.
	• Fabric price group 7	+\$107	Specify fabric color number.
	• Fabric price group 8	+\$134	Specify fabric color number.
	• Fabric price group 9	+\$166	Specify fabric color number.
	• Fabric price group 10	+\$187	Specify fabric color number.
	• Customer's Own Material (COM)	No cost	▶ See <i>Surface Materials Reference Manual</i> to specify.
	• Steelcase leather upholstery	+\$161	Add suffix S to the style number and specify leather color number.
	• Elmosoft leather upholstery	+\$186	Add suffix S to the style number and specify Elmosoft leather color number.
	• Customer's Own Leather (COL)	No cost	Add suffix S to the style number and specify leather color number.
	• Fire Code Seating (FCS)	+\$ 64	▶ See <i>Surface Materials Reference Manual</i> to specify.
	• Soil-retardant treatment applied to upholstery fabric	+\$ 21	Add suffix F to the style number. Specify <i>with soil-retardant treatment</i> .
	Casters		
	• Soft, dual-wheel roll-control casters for use on hard floors: black plastic	+\$ 21	Specify <i>with soft roll-control casters</i> .

Specification Information

Without Upholstery



• **Style Number**
• **U.S. Base Price**

4877110 \$929

With Upholstered Seat



• **Style Number**
• **U.S. Base Price**

4877210 \$1059

With Upholstered Seat and Back



• **Style Number**
• **U.S. Base Price**

4877211 \$1121



For Canadian Pricing
Multiply U.S. Price by the
Canadian price factor.
▶ See page 1 for details.

Cushion Upholstery Packages

Cushion Upholstery Package for Back and Seat

For Use on Leg-Base, Swivel, and Stool Models

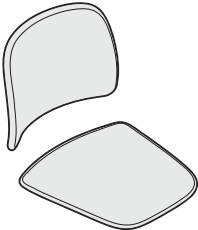

Tip: To comply with FCS requirements, both the chair and the cushion(s) must be specified with the FCS option.

Standard Includes	Required to Specify
-------------------	---------------------

- | | |
|--|--|
| Standard Includes | Required to Specify |
| <ul style="list-style-type: none"> • Package of one seat and one back cushion • Cushion upholstery for seat and back: fabric price group 1 • Outer back: plastic to match chair | <ol style="list-style-type: none"> 1 Style number 2 Fabric color number 3 Specify plastic color of back to match chair 4 Options, if selected (see below) <p>▶ See <i>Surface Materials</i>, page 264.</p> |

Options	U.S. Price	Required to Specify
---------	------------	---------------------

Options	U.S. Price	Required to Specify
Surface Materials		
• Fabric price group 1	No cost	Specify fabric color number.
• Fabric price group 2	+\$ 22	Specify fabric color number.
• Fabric price group 3	+\$ 43	Specify fabric color number.
• Fabric price group 4	+\$ 59	Specify fabric color number.
• Fabric price group 5	+\$ 75	Specify fabric color number.
• Fabric price group 6	+\$ 92	Specify fabric color number.
• Fabric price group 7	+\$107	Specify fabric color number.
• Fabric price group 8	+\$134	Specify fabric color number.
• Fabric price group 9	+\$166	Specify fabric color number.
• Fabric price group 10	+\$187	Specify fabric color number.
• Customer's Own Material (COM)	No cost	▶ See <i>Surface Materials Reference Manual</i> to specify.
• Steelcase leather upholstery	+\$161	Add suffix S to the style number and specify leather color number.
• Elmosoft leather upholstery	+\$186	Add suffix S to the style number and specify Elmosoft leather color number.
• Customer's Own Leather (COL)	No cost	Add suffix S to the style number and specify leather color number.
• Fire Code Seating (FCS)	+\$ 25	▶ See <i>Surface Materials Reference Manual</i> . Add suffix F to the style number.
• Soil-retardant treatment	+\$ 21	Specify <i>with soil-retardant treatment</i> .

Specification Information

Style Number	U.S. Base Price
.....

Package of 1 Back Cushion and 1 Seat Cushion

487STBK \$291

.....



For Canadian Pricing

Multiply U.S. Price by the Canadian price factor.

▶ See page 1 for details.

Cushion Upholstery Package for Back

For Use on Leg-Base, Swivel, and Stool Models

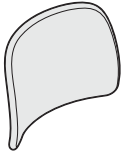

Standard Includes	Required to Specify
<ul style="list-style-type: none"> • One back cushion • Cushion upholstery for back: fabric price group 1 • Outer back: plastic to match chair 	<ol style="list-style-type: none"> 1 Style number 2 Fabric color number for cushion 3 Specify plastic color of back to match chair 4 Options, if selected (see below) <p>▶ See <i>Surface Materials</i>, page 264.</p>

Options	U.S. Price	Required to Specify
Surface Materials		
• Fabric price group 1	No cost	Specify fabric color number.
• Fabric price group 2	+\$10	Specify fabric color number.
• Fabric price group 3	+\$22	Specify fabric color number.
• Fabric price group 4	+\$30	Specify fabric color number.
• Fabric price group 5	+\$37	Specify fabric color number.
• Fabric price group 6	+\$46	Specify fabric color number.
• Fabric price group 7	+\$54	Specify fabric color number.
• Fabric price group 8	+\$68	Specify fabric color number.
• Fabric price group 9	+\$83	Specify fabric color number.
• Fabric price group 10	+\$95	Specify fabric color number.
• Customer's Own Material (COM)	No cost	▶ See <i>Surface Materials Reference Manual</i> to specify.
• Steelcase leather upholstery	+\$80	Add suffix S to the style number and specify leather color number.
• Elmosoft leather upholstery	+\$93	Add suffix S to the style number and specify Elmosoft leather color number.
• Customer's Own Leather (COL)	No cost	Add suffix S to the style number and specify leather color number.
• Fire Code Seating (FCS)	+\$14	▶ See <i>Surface Materials Reference Manual</i> . Add suffix F to the style number.
• Soil-retardant treatment	+\$21	Specify with soil-retardant treatment.

Tip: To comply with FCS requirements, both the chair and the cushion(s) must be specified with the FCS option.

Specification Information	
Style Number	U.S. Base Price
487BK	\$162

 **For Canadian Pricing**
 Multiply U.S. Price by the Canadian price factor.
 ▶ See page 1 for details.

Cushion Upholstery Package for Seat

For Use on Leg-Base, Swivel, and Stool Models

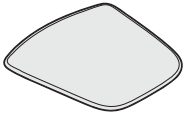

Standard Includes	Required to Specify
-------------------	---------------------

- | | |
|---|--|
| Standard Includes | Required to Specify |
| <ul style="list-style-type: none"> • One seat cushion • Cushion upholstery for seat: fabric price group 1 | <ul style="list-style-type: none"> 1 Style number 2 Fabric color number for cushion 3 Options, if selected (see below) ▶ See <i>Surface Materials</i>, page 264. |

Options	U.S. Price	Required to Specify
---------	------------	---------------------

Options	U.S. Price	Required to Specify
Surface Materials		
• Fabric price group 1	No cost	Specify fabric color number.
• Fabric price group 2	+\$10	Specify fabric color number.
• Fabric price group 3	+\$22	Specify fabric color number.
• Fabric price group 4	+\$30	Specify fabric color number.
• Fabric price group 5	+\$37	Specify fabric color number.
• Fabric price group 6	+\$46	Specify fabric color number.
• Fabric price group 7	+\$54	Specify fabric color number.
• Fabric price group 8	+\$68	Specify fabric color number.
• Fabric price group 9	+\$83	Specify fabric color number.
• Fabric price group 10	+\$95	Specify fabric color number.
• Customer's Own Material (COM)	No cost	▶ See <i>Surface Materials Reference Manual</i> to specify.
• Steelcase leather upholstery	+\$80	Add suffix S to the style number and specify leather color number.
• Elmosoft leather upholstery	+\$93	Add suffix S to the style number and specify Elmosoft leather color number.
• Customer's Own Leather (COL)	No cost	Add suffix S to the style number and specify leather color number.
• Fire Code Seating (FCS)	+\$14	▶ See <i>Surface Materials Reference Manual</i> . Add suffix F to the style number.
• Soil-retardant treatment	+\$21	Specify <i>with soil-retardant treatment</i> .

Tip: To comply with FCS requirements, both the chair and the cushion(s) must be specified with the FCS option.

Specification Information

Style Number	U.S. Base Price
487ST	\$162



For Canadian Pricing

Multiply U.S. Price by the Canadian price factor.

▶ See page 1 for details.

Transport and Storage Dolly

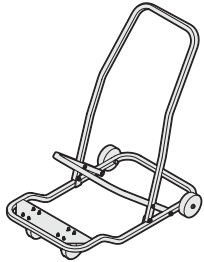

Tip: Transport and storage dolly is for leg-base chairs only.

Standard Includes	Required to Specify
<ul style="list-style-type: none"> ▶ Need help? Product details, page 123 • Transport and storage dolly: black paint only 	Style number

Specification Information

Style Number	U.S. Price
487D	\$518

Ganging and Alignment Devices

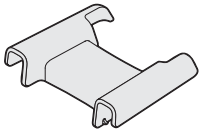

Tip: Ganging and alignment devices are for leg-base chairs only.

Standard Includes	Required to Specify
<ul style="list-style-type: none"> ▶ Need help? Product details, page 123 • Carton of 5 devices: color matched to frame 	<ul style="list-style-type: none"> 1 Style number 2 Plastic color number to match chair ▶ See <i>Surface Materials</i>, page 264.

Specification Information

Style Number	U.S. Price
487G	\$53



For Canadian Pricing
Multiply U.S. Price by the Canadian price factor.
▶ See page 1 for details.



Understanding and Specifying Protégé 433 Series Work Chairs

Product Details

Protégé 433 Series	138
Dimensions	140

Specifying

Value Package Work Chair	142
Work Chairs	144
Multi-Use Chairs	146
Sled-Base Multi-Use Chairs	148

Work Chairs

Adjustable work chairs offer basic ergonomic comfort for people who have varied tasks and tend to be in and out of the office during the day. Features include adjustable seat height, back tension, and upright back lock. Also featured is the no front-rise seat—in other words, when you lean back, the front edge of the seat doesn't rise up, lifting your legs off the floor and cutting off circulation.

- Protégé 433 Series
- Cachet 487 Series

Adjustability Features

▶ See page 12 for a comparison to other chairs

Protégé 433 Series

Mechanisms

Advanced swivel-tilt	●
----------------------	---

Seat Adjustments

Pneumatic height	●
------------------	---

Back Adjustments

Upright back lock	●
-------------------	---

Back tension	●
--------------	---

Protégé 433 Series

Protégé is an economic, general-use solution with basic ergonomic features. Protégé is stylish, comfortable, and well suited for a wide range of tasks, including moderate computer use.

Outer back is plastic. Fully upholstered outer back is an option.



Five-arm base is standard.

Arms are standard with soft arm caps.

Seat height adjusts with a 5" range from 15"H to 20"H with a pneumatic adjustment mechanism.

Hard, dual-wheel casters are standard for use on carpets. Soft, dual-wheel casters are available for use on hard floors or chair mats.

Product Details



Work and multi-use chairs are available with or without arms.



Multi-use chair bases are available in two styles: advanced swivel-tilt and sled base.

Adjustment Features

Seat Adjustments

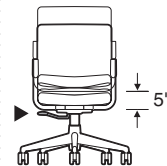

Seat height adjusts pneumatically. To lower, hold handle up while seated. To raise, hold handle up and keep your weight off the chair.

Back Adjustments



Back tension adjusts by turning knob. Turn knob clockwise to increase tension, counterclockwise to decrease.



Upright back lock.
Flick switch forward to lock; flick switch back to tilt.

Surface Materials

▶ See surface materials on page 264 for specific availability or refer to the *Surface Materials Reference Manual* for further information.

Upholstery

- Fabric
- Fabric with soil-retardant treatment (option)
- Leather
- Elmosoft leather
- Vinyl

Base and Arms

- 6205 Black
- 6250 Coffee
- 6249 Platinum

Arm Caps and Outer Back Shell

- 6205 Black
- 6250 Coffee

Casters

- 6205 Black

Tip: Chairs with a platinum finish will feature a platinum base and arms, and a black outer shell, casters, and arm caps (if specified).

Glides

- Plastic on sled base models

All Steelcase seating with standard upholstery fabrics complies with requirements of the State of California Technical Bulletin 117. All standard seating is labeled to be in compliance with California 117.

Programs & Services

▶ See the *Surface Materials Reference Manual* for further detail about programs and services offered for seating.

The Customer's Own Material (COM) Program

offers the opportunity for customers to select fabrics that are not offered through the standard Steelcase surface materials program for use on Steelcase products. Through the COM program, Steelcase will test your materials for application on Steelcase products. Once approved, you can place your order. Steelcase will facilitate the entire ordering process and give you a production schedule. Steelcase will order the COM fabric directly from the textile manufacturer. For up-to-date information regarding fabric test results for all COM fabrics and details regarding yardage requirements for most Seating lines, visit the COM Web site. To locate the COM Web site:

- Visit www.steelcase.com

Soil retardants are treatments that provide long-term soil and stain resistance to a fabric without affecting the shade or the integrity of the fabric. The following Steelcase Textiles are available pre-treated with soil retardant. (You do not need to select the soil-retardant option for these fabrics and incur the upcharge.)

- Jacks
- Link
- Spyder

For information on soil retardant fabrics on Select Surfaces, please refer to the *Surface Materials Reference Manual*.

Soil-retardant treatment is available on all other seating fabrics at an additional upcharge per seating unit. To order this option, please select "Soil-Retardant Treatment" under "Optional Accessories."

For soil-retardant treatment on COMs, please select "Soil-Retardant Treatment" under "Optional Accessories." Minimums or additional yardage may be required. Please contact the vendor directly for specific information.

Extended lead times may be necessary for this service.

Contact your Steelcase Solutions Fulfillment Team Representative at 1.888.STEELCASE (1.888.783.3522) or send an email to lineone@steelcase.com.

Fire Codes

▶ See pages 270–271 for upholstery fabrics available for use with FCS modification.

Steelcase offers Fire Code Seating modification (FCS) on nearly all seating models. The most rigorous fire codes in the nation have been developed in California, and the Steelcase FCS modification is designed to meet those codes. Fire Code Seating (FCS) indicates that a product is constructed to meet the strict fire code requirements of high public occupancy areas such as theaters, meeting rooms, and lobbies. The FCS standards will meet both the State of California Home Furnishing Technical Bulletin 133 (Cal TB 133) and Boston Fire Code (BFC). Boston adopted the California Home Furnishing Technical Bulletin TB 133 test standard in 1992.

Local codes may have special requirements for upholstery.

Dimensions

▶ Page 140

Resources

Printed Materials

▶ Protégé Brochure (08-0000160)

Dimensions

Protégé 433 Series

Features	Overall Depth	Width	Height	Seat Depth	Functional Seat Depth	Seat Width	Seat Height from Floor	Back Width	Back Height from Seat
----------	---------------	-------	--------	------------	-----------------------	------------	------------------------	------------	-----------------------

Protégé 433 Series

Work Chairs

Pneumatic	21 1/4"	24 1/4"	32 3/4"–37 3/4"	17 1/2"	16"	19 1/2"	15"–20"	19"	19 1/4"
-----------	---------	---------	-----------------	---------	-----	---------	---------	-----	---------

Multi-Use Chairs

Fixed Height	21 1/4"	24 1/4"	35 1/4"	17 1/2"	16"	19 1/2"	17 1/4"	19"	19 1/4"
Sled Base	21 1/4"	23"	35"	17 1/2"	16"	19 1/2"	18 1/4"	19"	19 1/4"

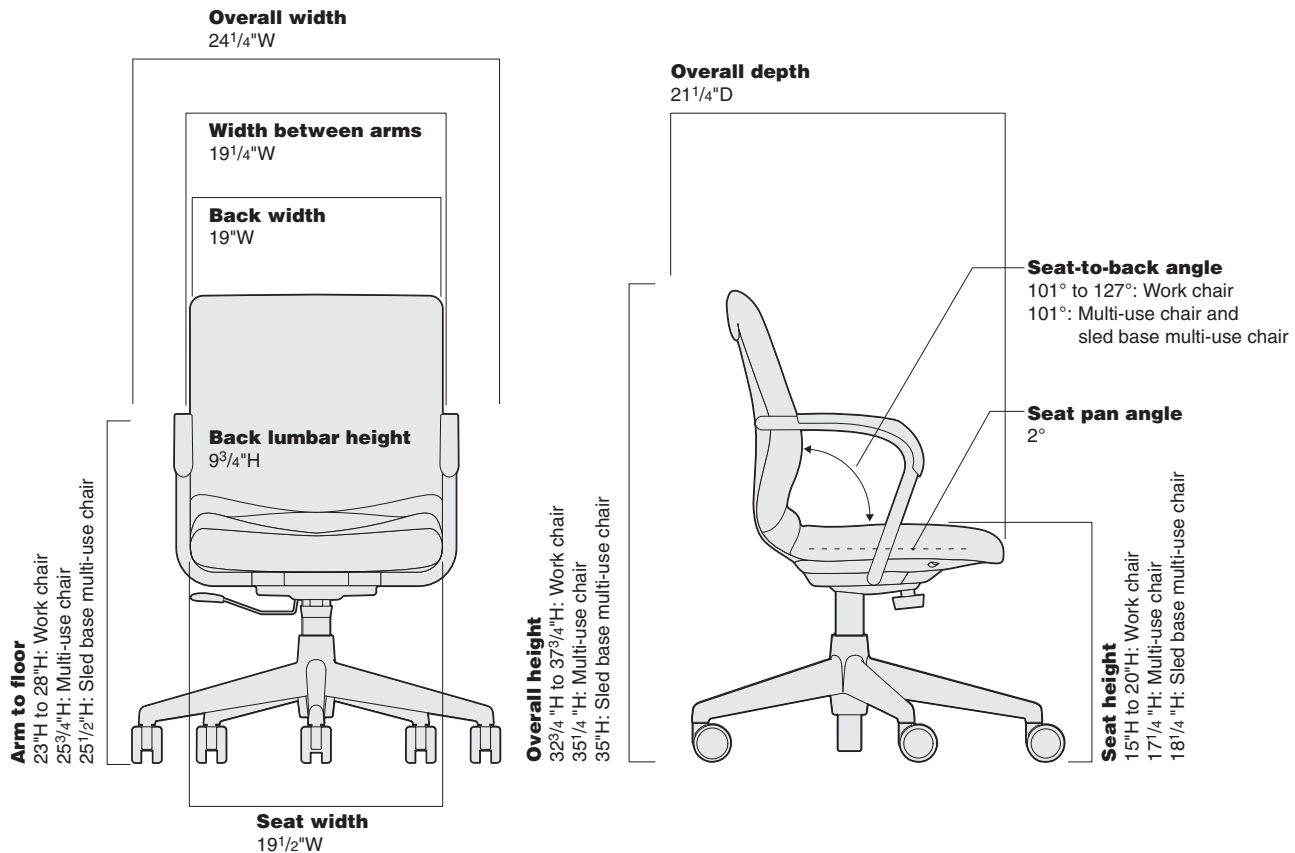

• Back Lumbar Height	• Width Between Arms	• Arm to Floor	• Arm Height from Seat	• Seat Pan Angle	• Angle Between Seat and Back
----------------------	----------------------	----------------	------------------------	------------------	-------------------------------

Work Chairs

9¾"	19¼"	23"-28"	7¾"	2°	101°-127°
-----	------	---------	-----	----	-----------

Multi-Use Chairs

9¾"	19¼"	25¾"	7¾"	2°	101°
9¾"	19¼"	25½"	7¾"	2°	101°

Protégé 433 Series

Protégé 433 Series Value Package Work Chair

Buzz2 Fabric on Seat and Back
Black Plastic Finish on Frame



Tip: This value package allows you to obtain the pre-selected features at a lower price than if specifying as a standard model number.

Tip: Options or substitutions are not available on this value package.

Standard Includes		Required to Specify
<ul style="list-style-type: none"> ▶ Need help? Product details, page 138 	<ul style="list-style-type: none"> • Advanced swivel-tilt mechanism • Pneumatic seat-height adjustment • Arms with soft arm caps: black plastic • Back tension adjustment • Seat and back: Buzz2 fabric • Five-arm base: black plastic • Frame: black plastic • Hard dual-wheel casters: black 	<ul style="list-style-type: none"> 1 Style number 2 Buzz2 fabric color number ▶ See <i>Surface Materials</i>, page 264.

Specification Information

Style Number	U.S. Price
PROTEGEV	\$697
:	:

▶ Detailed dimensions, page 140



For Canadian Pricing

Multiply U.S. Price by the Canadian price factor.

▶ See page 1 for details.

Protégé 433 Series Work Chairs



	Standard Includes	Required to Specify
▶ Need help? Product details, page 138	<ul style="list-style-type: none"> Advanced swivel-tilt mechanism Arms with soft plastic arm caps, if selected: color to match base Back tension adjustment Upholstery: fabric price group 1 Five-arm base: plastic color 2½"-diameter, hard composition, dual-wheel casters: black plastic 	<ol style="list-style-type: none"> Style number Plastic color number for base and arms Fabric color number for upholstery Options, if selected (see below) ▶ See <i>Surface Materials</i> , page 264.

	Options	U.S. Price	Required to Specify
Surface Materials	Upholstery		
	• Fabric price group 1	No cost	Specify fabric color number.
	• Fabric price group 2	+\$ 22	Specify fabric color number.
	• Fabric price group 3	+\$ 43	Specify fabric color number.
	• Fabric price group 4	+\$ 59	Specify fabric color number.
	• Fabric price group 5	+\$ 75	Specify fabric color number.
	• Fabric price group 6	+\$ 107	Specify fabric color number.
	• Fabric price group 7	+\$ 150	Specify fabric color number.
	• Fabric price group 8	+\$ 199	Specify fabric color number.
	• Fabric price group 9	+\$ 236	Specify fabric color number.
	• Fabric price group 10	+\$ 274	Specify fabric color number.
	• Customer's Own Material (COM)	+\$ 32	▶ See <i>Surface Materials Reference Manual</i> to specify.
	• Steelcase leather upholstery	+\$ 635	Add suffix S to style number and specify leather color number.
	• Elmosoft leather upholstery	+\$ 733	Add suffix S to the style number and specify Elmosoft leather color number.
• Steelcase vinyl	+\$ 68	Add suffix S to style number and specify vinyl color number.	
• Customer's Own Leather (COL)	+\$ 387	Add suffix S to style number.	
• Customer's Own Vinyl (COV)	+\$ 68	▶ See <i>Surface Materials Reference Manual</i> to specify.	
• Fire Code Seating (FCS)	+\$ 64	Add suffix F to the style number.	
• Soil-retardant treatment applied to upholstery fabric	+\$ 21	Specify <i>with soil-retardant treatment</i> .	
Fully upholstered	• Fabric fully upholstered outer back and outer seat	+\$ 111	Add suffix U to the style number.
	• Steelcase leather fully upholstered outer back and outer seat	+\$1115	Add suffix SU to the style number and specify leather color number.
	• Elmosoft leather fully upholstered outer back and outer seat	+\$1284	Add suffix SU to the style number and specify Elmosoft leather color number.
	• Customer's Own Leather (COL) fully upholstered outer back and outer seat	+\$ 622	Add suffix SU to the style number.
			▶ See <i>Surface Materials Reference Manual</i> to specify.
Platinum	• On base and arms	+\$ 78	Specify <i>with 6249 Platinum</i> .
	Casters		
	• Soft, dual-wheel casters	+\$ 21	Specify <i>with soft casters</i> .

Tip: Always add suffixes in alphabetical order when specifying options to Protégé seating.

Tip: Fire Code Seating (FCS) option is available with certain upholstery fabric choices only.
▶ Pages 270–271

Tip: Chairs with a platinum finish will feature a platinum base and arms, and a black outer shell, casters, and arm caps (if specified).

▶ Detailed dimensions, page 140

 **For Canadian Pricing**
Multiply U.S. Price by the Canadian price factor.
▶ See page 1 for details.

Specification Information

**Arms with
Soft Arm Caps**



Without Arms



• **Style
Number**

• **U.S.
Base
Price**

• **Style
Number**

• **U.S.
Base
Price**

Pneumatic

4331223

\$772

4331203

\$699

Pneumatic with Upright Back Lock

4331423

\$826

4331403

\$753

Protégé 433 Series



For Canadian Pricing

Multiply U.S. Price by the
Canadian price factor.

▶ See page 1 for details.

Protégé 433 Series Multi-Use Chairs



► Need help?
Product details,
page 138

Standard Includes

- Fixed height with advanced swivel-tilt mechanism
- Arms with soft plastic arm caps, if selected: color to match base
- Back tension adjustment
- Upholstery: fabric price group 1
- Five-arm base: plastic color
- 2½"-diameter, hard composition, dual-wheel casters: black plastic

Required to Specify

- 1 Style number
 - 2 Plastic color number for base and arms
 - 3 Fabric color number for upholstery
 - 4 Options, if selected (see below)
- See *Surface Materials*, page 264.

Tip: Always add suffixes in alphabetical order when specifying options to Protégé seating.

Tip: Fire Code Seating (FCS) option is available with certain upholstery fabric choices only.

► Pages 270–271

Tip: Chairs with a platinum finish will feature a platinum base and arms, and a black outer shell, casters, and arm caps (if specified).

► Detailed dimensions,
page 140



For Canadian Pricing

Multiply U.S. Price by the Canadian price factor.

► See page 1 for details.

	Options	U.S. Price	Required to Specify
Surface Materials	Upholstery		
	• Fabric price group 1	No cost	Specify fabric color number.
	• Fabric price group 2	+\$ 22	Specify fabric color number.
	• Fabric price group 3	+\$ 43	Specify fabric color number.
	• Fabric price group 4	+\$ 59	Specify fabric color number.
	• Fabric price group 5	+\$ 75	Specify fabric color number.
	• Fabric price group 6	+\$ 107	Specify fabric color number.
	• Fabric price group 7	+\$ 150	Specify fabric color number.
	• Fabric price group 8	+\$ 199	Specify fabric color number.
	• Fabric price group 9	+\$ 236	Specify fabric color number.
	• Fabric price group 10	+\$ 274	Specify fabric color number.
	• Customer's Own Material (COM)	+\$ 32	► See <i>Surface Materials Reference Manual</i> to specify.
	• Steelcase leather upholstery	+\$ 635	Add suffix S to style number and specify leather color number.
• Elmosoft leather upholstery	+\$ 733	Add suffix S to the style number and specify Elmosoft leather color number.	
• Steelcase vinyl	+\$ 68	Add suffix S to style number and specify vinyl color number.	
• Customer's Own Leather (COL)	+\$ 387	Add suffix S to style number.	
• Customer's Own Vinyl (COV)	+\$ 68	► See <i>Surface Materials Reference Manual</i> to specify.	
• Customer's Own Leather (COL) fully upholstered outer back and outer seat	+\$ 622	Add suffix SU to style number.	
• Fire Code Seating (FCS)	+\$ 64	Add suffix F to the style number.	
• Soil-retardant treatment applied to upholstery fabric	+\$ 21	Specify <i>with soil-retardant treatment</i> .	
	Fully upholstered		
	• Fabric fully upholstered outer back and outer seat	+\$ 111	Add suffix U to the style number.
	• Steelcase leather fully upholstered outer back and outer seat	+\$1115	Add suffix SU to the style number and specify leather color number.
	• Elmosoft leather fully upholstered outer back and outer seat	+\$1284	Add suffix SU to the style number and specify Elmosoft leather color number.
	• Customer's Own Leather (COL) fully upholstered outer back and outer seat	+\$ 622	Add suffix SU to the style number.
			► See <i>Surface Materials Reference Manual</i> to specify.
	Platinum		
	• On base and arms	+\$ 78	Specify <i>with 6249 Platinum</i> .
Casters	• Soft, dual-wheel casters	+\$ 21	Specify <i>with soft casters</i> .

Specification Information

**Arms with
Soft Arm Caps**



• Style
• Number

• U.S.
• Base
• Price

Without Arms



• Style
• Number

• U.S.
• Base
• Price

Multi-Use Chairs

Fixed Height

4333023 \$749

Fixed Height

4333003 \$676

Protégé 433 Series



For Canadian Pricing
Multiply U.S. Price by the
Canadian price factor.
▶ See page 1 for details.

Protégé 433 Series Sled-Base Multi-Use Chairs



Tip: Always add suffixes in alphabetical order when specifying options to Protégé seating.

Tip: Fire Code Seating (FCS) option is available with certain upholstery fabric choices only.
▶ Pages 270–271

Tip: Chairs with a platinum finish will feature a platinum base and arms, and a black outer shell, casters, and arm caps.

▶ Detailed dimensions, page 140

 **For Canadian Pricing**
Multiply U.S. Price by the Canadian price factor.
▶ See page 1 for details.

Standard Includes		Required to Specify
▶ Need help? Product details, page 138	<ul style="list-style-type: none"> Upholstery: fabric price group 1 Frame: plastic color Arms with soft arm caps: plastic Glides: clear plastic 	<ol style="list-style-type: none"> Style number Plastic color number for base and arms Fabric color number for upholstery Options, if selected (see below) <p>▶ See <i>Surface Materials</i>, page 264.</p>

Options	U.S. Price	Required to Specify
Surface Materials		
Upholstery		
• Fabric price group 1	No cost	Specify fabric color number.
• Fabric price group 2	+\$ 22	Specify fabric color number.
• Fabric price group 3	+\$ 43	Specify fabric color number.
• Fabric price group 4	+\$ 59	Specify fabric color number.
• Fabric price group 5	+\$ 75	Specify fabric color number.
• Fabric price group 6	+\$ 107	Specify fabric color number.
• Fabric price group 7	+\$ 150	Specify fabric color number.
• Fabric price group 8	+\$ 199	Specify fabric color number.
• Fabric price group 9	+\$ 236	Specify fabric color number.
• Fabric price group 10	+\$ 274	Specify fabric color number.
• Customer's Own Material (COM)	+\$ 32	Specify fabric color number.
• Steelcase leather upholstery	+\$ 635	▶ See <i>Surface Materials Reference Manual</i> to specify. Add suffix S to style number and specify leather color number.
• Elmosoft leather upholstery	+\$ 733	Add suffix S to the style number and specify Elmosoft leather color number.
• Steelcase vinyl	+\$ 68	Add suffix S to style number and specify vinyl color number.
• Customer's Own Leather (COL)	+\$ 387	Add suffix S to style number.
• Customer's Own Vinyl (COV)	+\$ 68	▶ See <i>Surface Materials Reference Manual</i> to specify. Add suffix S to style number.
• Fire Code Seating (FCS)	+\$ 64	Add suffix F to the style number.
• Soil-retardant treatment applied to upholstery fabric	+\$ 21	Specify with soil-retardant treatment.
Fully upholstered		
• Fabric fully upholstered outer back and outer seat	+\$ 111	Add suffix U to the style number.
• Steelcase leather fully upholstered outer back and outer seat	+\$1115	Add suffix SU to the style number and specify leather color number.
• Elmosoft leather fully upholstered outer back and outer seat	+\$1284	Add suffix SU to the style number and specify Elmosoft leather color number.
• Customer's Own Leather (COL) fully upholstered outer back and outer seat	+\$ 622	Add suffix SU to the style number. ▶ See <i>Surface Materials Reference Manual</i> to specify.
Platinum		
• On sled-base frame	+\$ 78	Specify with 6249 Platinum.

Specification Information

Style Number	U.S. Base Price
.....

Sled-Base Multi-Use Chairs

4335023	\$628
.....

Understanding and Specifying Criterion 453 Series Work Chairs

Work Chairs

Highly adjustable task seating offers maximum personalization for people who sit most of the day performing repetitive tasks. By making a series of simple adjustments, you can customize the chair to your body, preferences, and tasks. These chairs provide continuous, stable, task-oriented comfort, and can be quickly adjusted to support you in upright, forward, and reclining work postures.

- Leap 462 Series
- Leap 464 Series
- WorkLounge
- Criterion 453 Series
- Think 465 Series
- Amia 482 Series
- Reply 466 Series
- Drive 461 Series
- Jersey Series

Adjustability Features

► See page 12 for a comparison to other chairs.

	Criterion 453	Criterion Plus Series
Mechanisms		
Advanced swivel tilt	●	●
Seat Adjustments		
Pneumatic height	●	●
Seat angle	●	●
Seat depth	●	●
Back Adjustments		
Lumbar height	●	●
Back tension	●	●
Variable back stop	●	
Upright back lock		●
Back height	●	●
Arm Adjustments		
Arm height	●	●
Arm width	●	●
Arm pivot	●	
Other Features		
Foot ring height on stool	●	

Product Details

Criterion 453 Series	150
Dimensions	154

Specifying

High-Back Work Chairs	156
Mid-Back Work Chairs	158
High-Back Stools	160
Mid-Back Stools	162
Plus High-Back Work Chairs	164

Criterion 453 Series

Criterion is a high-performance chair, ideal for users who sit for long periods of time. As one of the world's best-selling chairs with a broad range of adjustments, Criterion meets the long-term comfort needs of today's diverse workforce.

Outer back and outer seat is plastic. Fully upholstered outer back is an option.

Arm height adjusts independently within a 4" range to help relieve upper back and shoulder fatigue.

Seat depth adjusts within a 3" range and is available as an option.

Seat height adjusts within a 5" range with a pneumatic adjustment mechanism.

Five-arm base is standard.

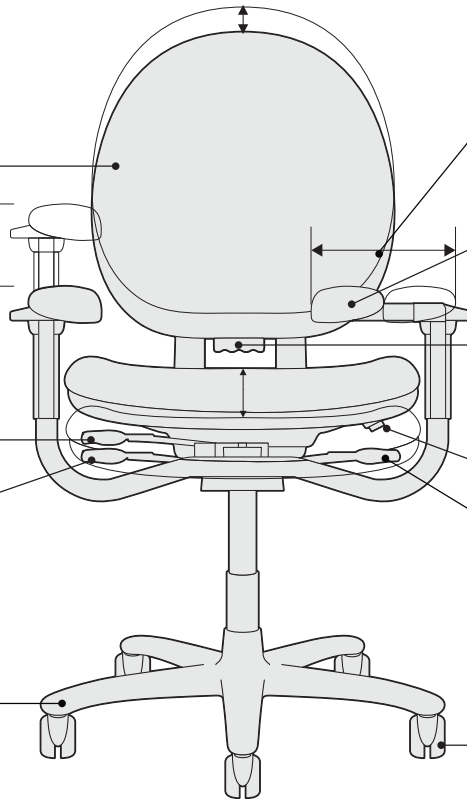

Arm width adjusts within a 4" range for each arm to provide forearm support in neutral position for 5th to 95th percentile office workers.

Arm caps can pivot independently 14° in and 21° out to accommodate individual user preferences.

Back height adjusts up and down within a 2" range to help ensure healthful back posture.

Variable back stop is standard.

Seat angle adjusts forward, upright, and reclined to suit user. Seat angle is standard.

Casters have hard, dual-wheels that roll smoothly on carpets. Soft, dual-wheel casters are available for use on hard floors or chair mats.

Product Details



Three basic sizes are available—high-back, mid-back, and Plus. All are offered with and without arms. High-back and mid-back are also available as stools.

Criterion features a seat angle adjustment which allows the seat angle to function in a fixed or articulating mode. Variable back stop will lock the back in an upright position or allow the user to set a specific back stop position which the chair will recline to.

Criterion Plus has an upright back lock and offers a wider seat with more space between the arms to accommodate workers who need a larger chair. The Criterion Plus chair is tested to hold up to 500 lbs. under normal use.

Upholstery Details



Criterion is standard with a molded upholstered seat and back.



Sewn upholstery can be specified to accommodate vinyl and other high performance fabrics. Seat and back cushions feature a stitched detail. Specify using an **S** suffix.



Non-Sewn Seat upholstery can be specified to accommodate vinyl and other high performance fabrics without a seam on the seat. Back cushion will have stitched detail. Specify using an **X** suffix. This option is available on models with adjustable seat depth only.

Adjustment Features

Seat Adjustments

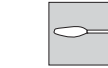
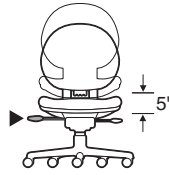

Seat height adjusts pneumatically. To lower, hold handle up while seated. To raise, hold handle up and keep your weight off the chair. Range of adjustability is 5" from 16"H to 21"H.

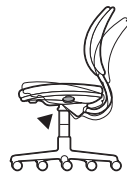

Seat angle adjusts by pulling handle up and shifting your weight to alter seat angle. Release handle to lock. This feature is standard.

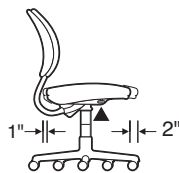

Seat depth adjusts by pulling handle up. Slide seat forward or back to accommodate various leg lengths. Release handle to lock. This feature is optional. For Criterion Plus, seat depth is a maintenance adjustment. The chair has three depth settings: 15", 16⁵/₈", and 18¹/₄". The chair will ship in the 18¹/₄" position.

Back Adjustments

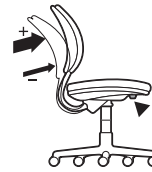

Back tension adjusts by turning knob. Turn knob clockwise to increase tension, counterclockwise to decrease. This feature is standard.



Variable back stop. Hold switch forward to recline. Lean back to desired back angle. Release switch to set tilt range. *Tip: To lock in upright position, remove weight from back and release switch.*

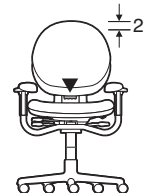

Back height adjusts within a 2" range by pulling handle forward while moving chair back up or down. Release handle to lock chair back in position. This feature is standard.

Arm Adjustments

Arms are available fixed, height-adjustable, height- and width-adjustable, and height-, width-, and pivot-adjustable.

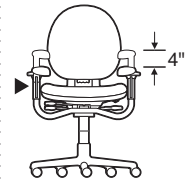

Arm height adjusts independently within a range of 4" on all adjustable arm models. Squeeze triggers in while moving arms up or down. Releasing triggers locks arms in position.

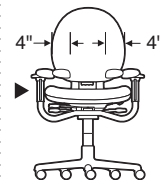

Arm width adjusts independently on chairs with the height- and width-adjustable option. Grasp arm and move in or out. Arm will stay where positioned.

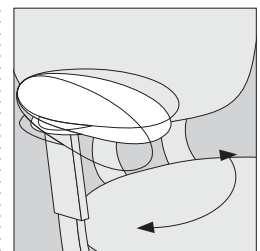

Arms pivot independently on models with height-, width-, and pivot-adjustable arms. Grasp arm and push front to left or right. Pivot adjustment width range is 10³/₄" to 18¹/₄".

Other Features

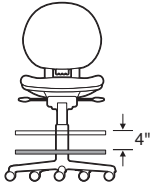

Foot ring height on stools adjusts by first lifting ring and rotating it counter-clockwise to unlock. Then raise or lower ring up to 4" to desired position before rotating it clockwise to lock.

Alternative casters and glides are available for specific applications, including soft-wheel casters for hard floors.

Glides are 2"H and interchangeable with casters.

Surface Materials

▶ See surface materials on page 264 for specific availability or refer to the *Surface Materials Reference Manual* for further information.

Upholstery

- Fabric
- Fabric with soil-retardant treatment (option)
- Leather
- Elmosoft leather
- Vinyl

Hard components

(base, arms, plastic arm caps, outer back, outer seat, and foot ring)
 • Monochromatic color from list of seating plastic color numbers will apply to all hard components.

Outer back and outer seat

- Plastic color to match color of other "hard components"
- Fully upholstered outer back with plastic color outer seat

Arms

- Soft vinyl arm caps to match the plastic color of the other "hard components"

Foot ring on stools

- Plastic color to match other "hard components"
- 9201 Polished Chrome

Glides

- Stainless steel only

All Steelcase seating with standard upholstery fabrics

complies with requirements of the State of California Technical Bulletin 117. All standard seating is labeled to be in compliance with California 117.

Programs & Services

▶ See the *Surface Materials Reference Manual* for further detail about programs and services offered for seating.

The Customer's Own Material (COM)

Program offers the opportunity for customers to select fabrics that are not offered through the standard Steelcase surface materials program for use on Steelcase products. Through the COM program, Steelcase will test your materials for application on Steelcase products. Once approved, you can place your order. Steelcase will facilitate the entire ordering process and give you a production schedule. Steelcase will order the COM fabric directly from the textile manufacturer. For up-to-date information regarding fabric test results for all COM fabrics and details regarding yardage requirements for most Seating lines, visit the COM Web site. To locate the COM Web site:

- Visit www.steelcase.com

Soil retardants are treatments that provide long-term soil and stain resistance to a fabric without affecting the shade or the integrity of the fabric. The following Steelcase Textiles are available pre-treated with soil retardant. (You do not need to select the soil-retardant option for these fabrics and incur the upcharge.)

- Jacks
- Link
- Spyder

For information on soil retardant fabrics on Select Surfaces, please refer to the *Surface Materials Reference Manual*.

Soil-retardant treatment is available on all other seating fabrics at an additional upcharge per seating unit. To order this option, please select "Soil-Retardant Treatment" under "Optional Accessories."

For soil-retardant treatment on COMs, please select "Soil-Retardant Treatment" under "Optional Accessories." Minimums or additional yardage may be required. Please contact the vendor directly for specific information.

Extended lead times may be necessary for this service.

Contact your Steelcase Solutions Fulfillment Team Representative at 1.888.STEELCASE (1.888.783.3522) or send an email to lineone@steelcase.com.

Fire Codes

▶ See pages 270–271 for upholstery fabrics available for use with FCS modification.

Steelcase offers Fire Code Seating modification (FCS) on nearly all seating models. The most rigorous fire codes in the nation have been developed in California, and the Steelcase FCS modification is designed to meet those codes. Fire Code Seating (FCS) indicates that a product is constructed to meet the strict fire code requirements of high public occupancy areas such as theaters, meeting rooms, and lobbies. The FCS standards will meet both the State of California Home Furnishing Technical Bulletin 133 (Cal TB 133) and Boston Fire Code (BFC). Boston adopted the California Home Furnishing Technical Bulletin TB 133 test standard in 1992.

Local codes may have special requirements for upholstery.

Dimensions

- ▶ Page 154

Resources

Printed Materials

- ▶ Criterion Brochure (04-0011868)
- ▶ Criterion Plus Sheet (S2396)

Computer Tools

- ▶ Interactive User Guide available on www.steelcase.com

Dimensions

Criterion 453 Series

Overall Depth	Width	Height	Seat Depth	Functional Seat Depth	Seat Width	Seat Height from Floor	Back Width	Back Height from Seat
---------------	-------	--------	------------	-----------------------	------------	------------------------	------------	-----------------------

Criterion 453 Series

High-Back Work Chairs

22 1/2"–25 1/2"	27 1/2"	37 1/2"–44 1/2"	19 1/2"	16 1/4"*	19 1/2"	16"–21"	18"	22"–24"
-----------------	---------	-----------------	---------	----------	---------	---------	-----	---------

Mid-Back Work Chairs

22 1/2"–25 1/2"	27 1/2"	34"–41"	19 1/2"	16 1/4"*	19 1/2"	16"–21"	18"	19 1/2"–21 1/2"
-----------------	---------	---------	---------	----------	---------	---------	-----	-----------------

High-Back Stools

22 1/2"–25 1/2"	27 1/2"	46"–53"	19 1/2"	16 1/4"*	19 1/2"	25"–30"	18"	22"–24"
-----------------	---------	---------	---------	----------	---------	---------	-----	---------

Mid-Back Stools

22 1/2"–25 1/2"	27 1/2"	43"–50"	19 1/2"	16 1/4"*	19 1/2"	25"–30"	18"	19 1/2"–21 1/2"
-----------------	---------	---------	---------	----------	---------	---------	-----	-----------------

Plus High-Back Work Chairs

22 1/2"–25 1/2"	31 1/2"	38"–45"	19 3/4"	18 1/4"**	23"	17"–22"	22"	23"–25"
-----------------	---------	---------	---------	-----------	-----	---------	-----	---------

*Models with adjustable seat depth 15 1/4"–18 1/4". **Plus models with adjustable seat depth require a maintenance adjustment, see page 151.

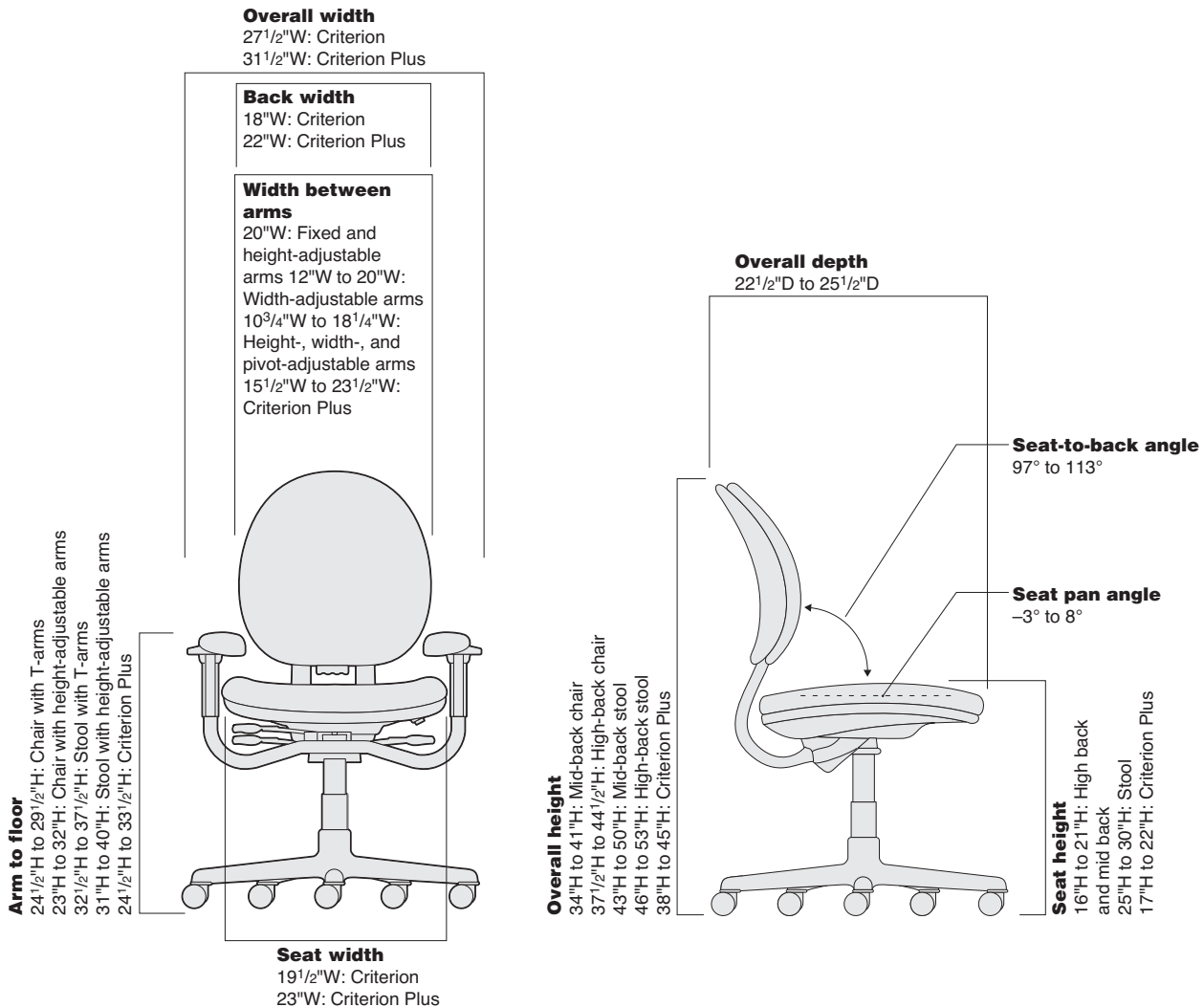

Back Lumbar Height	Width Between Fixed-Height and Adjustable-Height Arms	Width Between Height- and Width-Adjustable Arms	Width Between Height-, Width-, and Pivot-Adjustable Arms	Arm to Floor	Arm Height from Seat	Arm Cap Pivot Range	Seat Pan Angle	Angle Between Seat and Back
--------------------	---	---	--	--------------	----------------------	---------------------	----------------	-----------------------------

High-Back Work Chairs

8"	20"	12"-20"	10 ³ / ₄ "-18 ¹ / ₄ "	23"-32"	7"-11"	35°	-3°- 8°	97°-113°
----	-----	---------	---	---------	--------	-----	---------	----------

Mid-Back Work Chairs

8"	20"	12"-20"	10 ³ / ₄ "-18 ¹ / ₄ "	23"-32"	7"-11"	35°	-3°- 8°	97°-113°
----	-----	---------	---	---------	--------	-----	---------	----------

High-Back Stools

8"	20"	12"-20"	10 ³ / ₄ "-18 ¹ / ₄ "	31"-40"	7"-11"	35°	-3°- 8°	97°-113°
----	-----	---------	---	---------	--------	-----	---------	----------

Mid-Back Stools

8"	20"	12"-20"	10 ³ / ₄ "-18 ¹ / ₄ "	31"-40"	7"-11"	35°	-3°- 8°	97°-113°
----	-----	---------	---	---------	--------	-----	---------	----------

Plus High-Back Work Chairs

9"	23 ¹ / ₂ "	15 ¹ / ₂ "-23 ¹ / ₂ "	N.A.	24 ¹ / ₂ "-33 ¹ / ₂ "	7 ¹ / ₂ "-11 ¹ / ₂ "	N.A.	1°- 10°	97°-113°
----	----------------------------------	---	------	---	--	------	---------	----------

Criterion 453 Series High-Back Work Chairs



Tip: Always add suffixes in alphabetical order when specifying options to Criterion seating.

Tip: Non-sewn seat upholstery (**X** suffix) is available only on models with adjustable seat depth with (**D** suffix).

Tip: Fire Code Seating (FCS) option is available only on models with both adjustable seat depth (**D** suffix) and 6205 Black plastic components.

► See pages 270–271 for upholstery fabric choices.

► Detailed dimensions, page 154

 **For Canadian Pricing**
Multiply U.S. Price by the Canadian price factor.
► See page 1 for details.

Standard Includes	Required to Specify
<p>► Need help? Product details, page 150</p> <ul style="list-style-type: none"> • Back height adjustment • Seat angle adjustment • Variable back stop • Back tension adjustment • Arms, if selected: plastic color to match base • Outer back and outer seat: plastic color • Upholstery: fabric price group 1 • Five-arm base: plastic color • 2½"-diameter, hard composition, dual-wheel casters: plastic color to match base 	<ol style="list-style-type: none"> 1 Style number 2 Plastic color number for base, outer back, outer seat, arms, and casters 3 Fabric color number for upholstery 4 Options, if selected (see below) <p>► See <i>Surface Materials</i>, page 264.</p>

Options	U.S. Price	Required to Specify
<p>Surface Materials</p> <ul style="list-style-type: none"> • Fabric price group 1 • Fabric price group 2 • Fabric price group 3 • Fabric price group 4 • Fabric price group 5 • Fabric price group 6 • Fabric price group 7 • Fabric price group 8 • Fabric price group 9 • Fabric price group 10 • Sewn upholstery • Steelcase leather upholstery • Elmosoft leather upholstery • Steelcase vinyl • Non-sewn seat upholstery • Customer's Own Material (COM) • Customer's Own Leather (COL) • Customer's Own Vinyl (COV) • Fire Code Seating (FCS) • Soil-retardant treatment applied to upholstery fabric 	<p>No cost</p> <p>+\$ 22</p> <p>+\$ 43</p> <p>+\$ 59</p> <p>+\$ 75</p> <p>+\$ 92</p> <p>+\$107</p> <p>+\$134</p> <p>+\$166</p> <p>+\$187</p> <p>+\$ 45</p> <p>+\$594</p> <p>+\$686</p> <p>+\$ 45</p> <p>+\$ 82</p> <p>+\$ 32</p> <p>+\$376</p> <p>+\$ 45</p> <p>+\$ 64</p> <p>+\$ 21</p>	<p>Specify fabric color number.</p> <p>Specify fabric color number.</p> <p>Specify fabric color number.</p> <p>Specify fabric color number.</p> <p>Specify fabric color number.</p> <p>Specify fabric color number.</p> <p>Specify fabric color number.</p> <p>Specify fabric color number.</p> <p>Specify fabric color number.</p> <p>Specify fabric color number.</p> <p>Specify fabric color number.</p> <p>Add suffix S to the style number.</p> <p>Add suffix S to the style number and specify leather color number.</p> <p>Add suffix S to the style number and specify Elmosoft leather color number.</p> <p>Add suffix S to the style number and specify vinyl color number.</p> <p>Add suffix X to the style number.</p> <p>► See <i>Surface Materials Reference Manual</i> to specify.</p> <p>Add suffix S to the style number and specify leather color number.</p> <p>Add suffix S to the style number.</p> <p>Add suffix F to the style number.</p> <p>Specify with soil-retardant treatment.</p>
<p>Fully upholstered</p> <ul style="list-style-type: none"> • Outer back 	<p>+\$ 95</p>	<p>Add suffix B to the style number.</p>
<p>Casters</p> <ul style="list-style-type: none"> • Soft, dual-wheel casters for use on hard floors 	<p>+\$ 21</p>	<p>Specify with soft casters.</p>
<p>Glides</p> <ul style="list-style-type: none"> • Plastic glide with stainless steel cap 	<p>+\$ 21</p>	<p>Specify with GLD453.</p>

Specification Information

Height-, Width-, and Pivot-Adjustable Arms



• **Style Number**
• **U.S. Base Price**

Height- and Width-Adjustable Arms



• **Style Number**
• **U.S. Base Price**

Height-Adjustable Arms



• **Style Number**
• **U.S. Base Price**

Soft Arm Caps

Pneumatic

4535331P	\$1193	4535331W	\$1274	4535331H	\$1147
-----------------	--------	-----------------	--------	-----------------	--------

Pneumatic with Adjustable Seat Depth

4535331DP	\$1291	4535331DW	\$1372	4535331DH	\$1245
------------------	--------	------------------	--------	------------------	--------

Fixed-Height Arms



• **Style Number**
• **U.S. Base Price**

Without Arms



• **Style Number**
• **U.S. Base Price**

Pneumatic

4535331	\$1052	4535301	\$ 897
----------------	--------	----------------	--------

Pneumatic with Adjustable Seat Depth

4535331D	\$1150	4535301D	\$ 995
-----------------	--------	-----------------	--------

Criterion 453 Series



For Canadian Pricing

Multiply U.S. Price by the Canadian price factor.

▶ See page 1 for details.

Criterion 453 Series Mid-Back Work Chairs



Tip: Always add suffixes in alphabetical order when specifying options to Criterion seating.

Tip: Non-sewn seat upholstery (**X** suffix) is available only on models with adjustable seat depth (**D** suffix).

Tip: Fire Code Seating (FCS) option is available only on models with both adjustable seat depth (**D** suffix) and 6205 Black plastic components.

▶ See pages 270–271 for upholstery fabric choices.

▶ Detailed dimensions, page 154

 **For Canadian Pricing**
Multiply U.S. Price by the Canadian price factor.
▶ See page 1 for details.

Standard Includes		Required to Specify
▶ Need help? Product details, page 150	<ul style="list-style-type: none"> • Back height adjustment • Seat angle adjustment • Variable back stop • Back tension adjustment • Arms, if selected: plastic color to match base • Outer back and outer seat: plastic color • Upholstery: fabric price group 1 • Five-arm base: plastic color • 2½"-diameter, hard composition, dual-wheel casters: plastic color to match base 	<ol style="list-style-type: none"> 1 Style number 2 Plastic color number for base, outer back, outer seat, arms, and casters 3 Fabric color number for upholstery 4 Options, if selected (see below) <p>▶ See <i>Surface Materials</i>, page 264.</p>

Options	U.S. Price	Required to Specify
Surface Materials		
Upholstery		
• Fabric price group 1	No cost	Specify fabric color number.
• Fabric price group 2	+\$ 22	Specify fabric color number.
• Fabric price group 3	+\$ 43	Specify fabric color number.
• Fabric price group 4	+\$ 59	Specify fabric color number.
• Fabric price group 5	+\$ 75	Specify fabric color number.
• Fabric price group 6	+\$ 92	Specify fabric color number.
• Fabric price group 7	+\$107	Specify fabric color number.
• Fabric price group 8	+\$134	Specify fabric color number.
• Fabric price group 9	+\$166	Specify fabric color number.
• Fabric price group 10	+\$187	Specify fabric color number.
• Sewn upholstery	+\$ 45	Add suffix S to the style number.
• Steelcase leather upholstery	+\$594	Add suffix S to the style number and specify leather color number.
• Elmosoft leather upholstery	+\$686	Add suffix S to the style number and specify Elmosoft leather color number.
• Steelcase vinyl	+\$ 45	Add suffix S to the style number and specify vinyl color number.
• Non-sewn seat upholstery	+\$ 82	Add suffix X to the style number.
• Customer's Own Material (COM)	+\$ 32	▶ See <i>Surface Materials Reference Manual</i> to specify.
• Customer's Own Leather (COL)	+\$376	Add suffix S to the style number and specify leather color number.
• Customer's Own Vinyl (COV)	+\$ 45	Add suffix S to the style number.
• Fire Code Seating (FCS)	+\$ 64	Add suffix F to the style number.
• Soil-retardant treatment applied to upholstery fabric	+\$ 21	Specify <i>with soil-retardant treatment</i> .
Fully upholstered		
• Outer back	+\$ 95	Add suffix B to the style number.
Casters		
• Soft, dual-wheel casters for use on hard floors	+\$ 21	Specify <i>with soft casters</i> .
Glides		
• Plastic glide with stainless steel cap	+\$ 21	Specify <i>with GLD453</i> .

Specification Information

Height-, Width-, and Pivot-Adjustable Arms



• Style Number
• U.S. Base Price

Height- and Width Adjustable Arms



• Style Number
• U.S. Base Price

Height-Adjustable Arms



• Style Number
• U.S. Base Price

Soft Arm Caps

Pneumatic

4535330P	\$1137	4535330W	\$1218	4535330H	\$1091
-----------------	--------	-----------------	--------	-----------------	--------

Pneumatic with Adjustable Seat Depth

4535330DP	\$1235	4535330DW	\$1316	4535330DH	\$1189
------------------	--------	------------------	--------	------------------	--------

Fixed-Height Arms



• Style Number
• U.S. Base Price

Without Arms



• Style Number
• U.S. Base Price

Pneumatic

4535330	\$ 996	4535300	\$ 841
----------------	--------	----------------	--------

Pneumatic with Adjustable Seat Depth

4535330D	\$1094	4535300D	\$ 939
-----------------	--------	-----------------	--------

Criterion 453 Series



For Canadian Pricing

Multiply U.S. Price by the Canadian price factor.

▶ See page 1 for details.

Criterion 453 Series High-Back Stools



Tip: Always add suffixes in alphabetical order when specifying options to Criterion seating.

Tip: Non-sewn seat upholstery (**X** suffix) is available only on models with adjustable seat depth (**D** suffix).

Tip: Fire Code Seating (FCS) option is available only on models with both adjustable seat depth (**D** suffix) and 6205 Black plastic components.
▶ See pages 270–271 for upholstery fabric choices.

▶ Detailed dimensions, page 154

 **For Canadian Pricing**
Multiply U.S. Price by the Canadian price factor.
▶ See page 1 for details.

	Standard Includes	Required to Specify
▶ Need help? Product details, page 150	<ul style="list-style-type: none"> • Back height adjustment • Seat angle adjustment • Variable back stop • Back tension adjustment • Arms, if selected: plastic color to match base • Outer back and outer seat: plastic color • Upholstery: fabric price group 1 • Five-arm base: plastic color • Adjustable foot ring: plastic color • 2½"-diameter, hard composition, dual-wheel casters: plastic color to match base 	<ol style="list-style-type: none"> 1 Style number 2 Plastic color number for base, foot ring, outer back, outer seat, arms, and casters 3 Fabric color number for upholstery 4 Options, if selected (see below) <p>▶ See <i>Surface Materials</i>, page 264.</p>

	Options	U.S. Price	Required to Specify
Surface Materials	Upholstery		
	• Fabric price group 1	No cost	Specify fabric color number.
	• Fabric price group 2	+\$ 22	Specify fabric color number.
	• Fabric price group 3	+\$ 43	Specify fabric color number.
	• Fabric price group 4	+\$ 59	Specify fabric color number.
	• Fabric price group 5	+\$ 75	Specify fabric color number.
	• Fabric price group 6	+\$ 92	Specify fabric color number.
	• Fabric price group 7	+\$107	Specify fabric color number.
	• Fabric price group 8	+\$134	Specify fabric color number.
	• Fabric price group 9	+\$166	Specify fabric color number.
	• Fabric price group 10	+\$187	Specify fabric color number.
	• Sewn upholstery	+\$ 45	Add suffix S to the style number.
	• Steelcase leather upholstery	+\$594	Add suffix S to the style number and specify leather color number.
• Elmosoft leather upholstery	+\$686	Add suffix S to the style number and specify Elmosoft leather color number.	
• Steelcase vinyl	+\$ 45	Add suffix S to the style number and specify vinyl color number.	
	• Non-sewn seat upholstery	+\$ 82	Add suffix X to the style number.
	• Customer's Own Material (COM)	+\$ 32	▶ See <i>Surface Materials Reference Manual</i> to specify.
	• Customer's Own Leather (COL)	+\$376	Add suffix S to the style number and specify leather color number.
	• Customer's Own Vinyl (COV)	+\$ 45	Add suffix S to the style number.
	• Fire Code Seating (FCS)	+\$ 64	Add suffix F to the style number.
	• Soil-retardant treatment applied to upholstery fabric	+\$ 21	Specify with <i>soil-retardant treatment</i> .
	Fully upholstered		
	• Outer back	+\$ 95	Add suffix B to the style number.
	Height-adjustable foot ring		
	• Polished Chrome foot ring	+\$ 36	Specify with <i>9201 Polished Chrome foot ring</i> .
Casters	• Soft, dual-wheel casters for use on hard floors	+\$ 21	Specify with <i>soft casters</i> .
Glides	• Plastic glide with stainless steel cap	+\$ 21	Specify with <i>GLD453</i> .

Specification Information

Height-, Width-, and Pivot-Adjustable Arms



• Style Number
• U.S. Base Price

Height- and Width-Adjustable Arms



• Style Number
• U.S. Base Price

Height-Adjustable Arms



• Style Number
• U.S. Base Price

Soft Arm Caps

Pneumatic

4537331P	\$1422	4537331W	\$1503	4537331H	\$1376
-----------------	--------	-----------------	--------	-----------------	--------

Pneumatic with Adjustable Seat Depth

4537331DP	\$1520	4537331DW	\$1601	4537331DH	\$1474
------------------	--------	------------------	--------	------------------	--------

Fixed-Height Arms



• Style Number
• U.S. Base Price

Without Arms



• Style Number
• U.S. Base Price

Pneumatic

4537331	\$1281	4537301	\$1126
----------------	--------	----------------	--------

Pneumatic with Adjustable Seat Depth

4537331D	\$1379	4537301D	\$1224
-----------------	--------	-----------------	--------

For Canadian Pricing
Multiply U.S. Price by the Canadian price factor.
▶ See page 1 for details.

Criterion 453 Series Mid-Back Stools



► Need help?
Product details,
page 150

Standard Includes

- Back height adjustment
- Seat angle adjustment
- Variable back stop
- Back tension adjustment
- Arms, if selected: plastic color to match base
- Outer back and outer seat: plastic color
- Upholstery: fabric price group 1
- Five-arm base: plastic color
- Adjustable foot ring: plastic color
- 2½"-diameter, hard composition, dual-wheel casters: plastic color to match base

Required to Specify

- 1 Style number
 - 2 Plastic color number for base, foot ring, outer back, outer seat, arms, and casters
 - 3 Fabric color number for upholstery
 - 4 Options, if selected (see below)
- See *Surface Materials*, page 264.

Tip: Always add suffixes in alphabetical order when specifying options to Criterion seating.

Tip: Non-sewn seat upholstery (X suffix) is available only on models with adjustable seat depth (D suffix).

Tip: Fire Code Seating (FCS) option is available only on models with both adjustable seat depth (D suffix) and 6205 Black plastic components.
► See pages 270–271 for upholstery fabric choices.

	Options	U.S. Price	Required to Specify
Surface Materials	Upholstery		
	• Fabric price group 1	No cost	Specify fabric color number.
	• Fabric price group 2	+\$ 22	Specify fabric color number.
	• Fabric price group 3	+\$ 43	Specify fabric color number.
	• Fabric price group 4	+\$ 59	Specify fabric color number.
	• Fabric price group 5	+\$ 75	Specify fabric color number.
	• Fabric price group 6	+\$ 92	Specify fabric color number.
	• Fabric price group 7	+\$107	Specify fabric color number.
	• Fabric price group 8	+\$134	Specify fabric color number.
	• Fabric price group 9	+\$166	Specify fabric color number.
	• Fabric price group 10	+\$187	Specify fabric color number.
	• Sewn upholstery	+\$ 45	Add suffix S to the style number.
	• Steelcase leather upholstery	+\$594	Add suffix S to the style number and specify leather color number.
• Elmosoft leather upholstery	+\$686	Add suffix S to the style number and specify Elmosoft leather color number.	
• Steelcase vinyl	+\$ 45	Add suffix S to the style number and specify vinyl color number.	
	• Non-sewn seat upholstery	+\$ 82	Add suffix X to the style number.
	• Customer's Own Material (COM)	+\$ 32	► See <i>Surface Materials Reference Manual</i> to specify.
	• Customer's Own Leather (COL)	+\$376	Add suffix S to the style number and specify leather color number.
	• Customer's Own Vinyl (COV)	+\$ 45	Add suffix S to the style number.
	• Fire Code Seating (FCS)	+\$ 64	Add suffix F to the style number.
	• Soil-retardant treatment applied to upholstery fabric	+\$ 21	Specify with <i>soil-retardant treatment</i> .
	Fully upholstered		
	• Outer back	+\$ 95	Add suffix B to the style number.
	Height-adjustable foot ring		
	• Polished Chrome foot ring	+\$ 36	Specify with <i>9201 Polished Chrome foot ring</i> .
Casters	• Soft, dual-wheel casters for use on hard floors	+\$ 21	Specify with <i>soft casters</i> .
Glides	• Plastic glide with stainless steel cap	+\$ 21	Specify with <i>GLD453</i> .

► Detailed dimensions,
page 154



For Canadian Pricing
Multiply U.S. Price by the Canadian price factor.
► See page 1 for details.

Specification Information

Height-, Width-, and Pivot-Adjustable Arms



• **Style Number**
.....
• **U.S. Base Price**
.....

Height- and Width-Adjustable Arms



• **Style Number**
.....
• **U.S. Base Price**
.....

Height-Adjustable Arms



• **Style Number**
.....
• **U.S. Base Price**
.....

Soft Arm Caps

Pneumatic

4537330P	\$1366	4537330W	\$1447	4537330H	\$1320
-----------------	--------	-----------------	--------	-----------------	--------

Pneumatic with Adjustable Seat Depth

4537330DP	\$1464	4537330DW	\$1545	4537330DH	\$1418
------------------	--------	------------------	--------	------------------	--------

Fixed-Height Arms



• **Style Number**
.....
• **U.S. Base Price**
.....

Without Arms

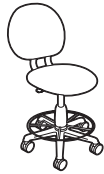

• **Style Number**
.....
• **U.S. Base Price**
.....

Pneumatic

4537330	\$1225	4537300	\$1070
----------------	--------	----------------	--------

Pneumatic with Adjustable Seat Depth

4537330D	\$1323	4537300D	\$1168
-----------------	--------	-----------------	--------

Criterion 453 Series



For Canadian Pricing

Multiply U.S. Price by the Canadian price factor.

▶ See page 1 for details.

Criterion Plus 453 Series High-Back Work Chairs



Tip: Criterion Plus is available with a fully upholstered outer back only.

Tip: Height-, width-, and pivot-adjustable arms are not available on Criterion Plus.

Tip: Fire Code Seating (FCS) option is available only on models with 6205 Black plastic components. ▶ See pages 270–271 for upholstery fabric choices.

Standard Includes		Required to Specify
▶ Need help? Product details, page 150	<ul style="list-style-type: none"> • Back height adjustment • Seat angle adjustment • Manual seat depth adjustment • Back tension adjustment • Upright back lock • Arms, if selected: plastic color to match base • Sewn upholstery • Upholstery: fabric price group 1 • Outer back: upholstery • Outer seat: plastic color • Five-arm base: plastic color • 2½"-diameter, hard composition, dual-wheel casters: plastic color to match base 	<ol style="list-style-type: none"> 1 Style number 2 Plastic color number for base, outer seat, arms, and casters 3 Fabric color number for upholstery 4 Options, if selected (see below) <p>▶ See <i>Surface Materials</i>, page 264.</p>

Options	U.S. Price	Required to Specify
Surface Materials	Upholstery <ul style="list-style-type: none"> • Fabric price group 1 No cost • Fabric price group 2 +\$ 22 • Fabric price group 3 +\$ 43 • Fabric price group 4 +\$ 59 • Fabric price group 5 +\$ 75 • Fabric price group 6 +\$ 92 • Fabric price group 7 +\$107 • Fabric price group 8 +\$134 • Fabric price group 9 +\$166 • Fabric price group 10 +\$187 • Customer's Own Material (COM) +\$ 32 • Steelcase leather upholstery +\$285 • Elmosoft leather upholstery +\$329 • Fire Code Seating (FCS) +\$ 64 • Soil-retardant treatment applied to upholstery fabric +\$ 21 	<ul style="list-style-type: none"> Specify fabric color number. Specify fabric color number. Specify fabric color number. Specify fabric color number. Specify fabric color number. Specify fabric color number. Specify fabric color number. Specify fabric color number. Specify fabric color number. Specify fabric color number. ▶ See <i>Surface Materials Reference Manual</i> to specify. Specify leather color number. Specify Elmosoft leather color number. Add suffix F to the style number. Specify with soil-retardant treatment.
Casters	<ul style="list-style-type: none"> • Soft, dual-wheel casters for use on hard floors +\$ 21 	<ul style="list-style-type: none"> Specify with soft casters.

▶ Detailed dimensions, page 154



For Canadian Pricing
Multiply U.S. Price by the Canadian price factor.
▶ See page 1 for details.

Specification Information

Height- and Width-Adjustable Arms



• **Style Number**
:
:
:
:
:
:
:
:
:
:

• **U.S. Base Price**
:
:
:
:
:
:
:
:
:
:

Height-Adjustable Arms



• **Style Number**
:
:
:
:
:
:
:
:
:
:

• **U.S. Base Price**
:
:
:
:
:
:
:
:
:
:

Fixed-Height Arms



• **Style Number**
:
:
:
:
:
:
:
:
:
:

• **U.S. Base Price**
:
:
:
:
:
:
:
:
:
:

Soft Arm Caps

Pneumatic

4539331BW	\$2014	4539331BH	\$1948	4539331B	\$1853
------------------	--------	------------------	--------	-----------------	--------

Without Arms



• **Style Number**
:
:
:
:
:
:
:
:
:
:

• **U.S. Base Price**
:
:
:
:
:
:
:
:
:
:

Pneumatic

4539301B	\$1698
-----------------	--------

Criterion 453 Series



For Canadian Pricing
Multiply U.S. Price by the Canadian price factor.
▶ See page 1 for details.



Understanding and Specifying Drive 461 Series Work Chairs

Product Details

Drive 461 Series	168
Dimensions	172

Specifying

Work Chairs	174
-------------	-----

Work Chairs

Highly adjustable task seating offers maximum personalization for people who sit most of the day performing repetitive tasks. By making a series of simple adjustments, you can customize the chair to your body, preferences, and tasks. These chairs provide continuous, stable, task-oriented comfort, and can be quickly adjusted to support you in upright, forward, and reclining work postures.

- Leap 462 Series
- Leap 464 Series
- WorkLounge
- Criterion 453 Series
- Think 465 Series
- Amia 482 Series
- Reply 466 Series
- Drive 461 Series
- Jersey Series

Adjustability Features

▶ See page 12 for a comparison to other chairs.

Drive 461 Series

Mechanisms

Synchro-tilt	●
--------------	---

Seat Adjustments

Pneumatic height	●
Seat angle	●
Seat depth	●

Back Adjustments

Lumbar height	●
Back tension	●
Upright back lock	●

Arm Adjustments

Arm height	●
Arm width	●
Arm pivot	●

Drive 461 Series

Drive is high-performance seating for value-driven customers. Intuitive controls, high-comfort ratings, a versatile statement of line, and a wide range of adjustments make it a great solution for anywhere in the office.

Outer back and outer seat is plastic.

Lumbar adjusts up and down within a 4" range to help ensure healthful back posture.

Arm height adjusts independently within a 4" range to help relieve upper back and shoulder fatigue.

Face plate is plastic and will match base color.

Upright back lock allows user to lock the back in a full upright position or release it for full-tilt motion.



Arm width adjusts within a 3" range for each arm to provide forearm support in neutral position for 5th to 95th percentile users.

Arm caps can pivot independently to accommodate user preferences.

Seat depth adjusts within a 3" range and is an option on all models. Adjustment paddle is located on left side of chair.

Seat angle adjusts forward, upright, and reclined to suit user.

Seat height adjusts within a 5" range with a pneumatic adjustment mechanism.

Five-arm base is steel with plastic cap.

Casters have hard, dual-wheels that roll smoothly on carpets. Soft, dual-wheel casters are available for use on hard floors or chair mats.

Product Details



Full-back height is available with and without arms.

Drive offers multiple arm options.

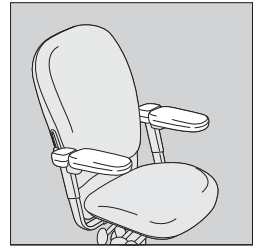

Height- and width-adjustable T-arms

- Height- and width-adjustable T-arms are standard on all chairs with arms.



Independent height-, width-, and pivot-adjustable arms

- Telescoping arms with height, width, and pivot adjustability are an option.

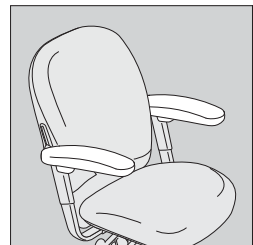

Height-adjustable T-arms

- Height-adjustable T-arms are an option.

Adjustment Features

Seat Adjustments

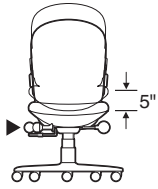

Seat height adjusts pneumatically.

To raise, lift your weight off the seat and pull lever up. To lower chair, remain seated and pull lever up.

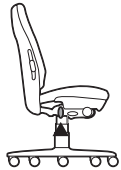

Seat angle adjusts

by pulling paddle and shifting your weight to alter seat angle. Release paddle to lock.

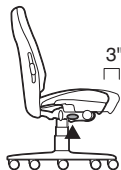

Seat depth adjustment.

Lift paddle under left side of seat. Slide seat forward or backward. Release paddle.

Back Adjustments

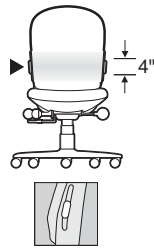

Lumbar adjustment.

Lean forward to slide handle up or down with both hands to desired position.

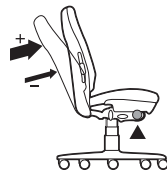

Back tension adjustment.

Turn knob forward to increase tension, backwards to decrease.

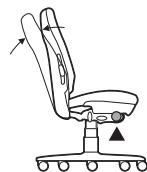

Upright back lock.

To release, lean forward and pull toward back. To lock, lean forward and push toward front.

Arm Adjustments



Arm height.

Lift trigger, raise or lower to desired height.

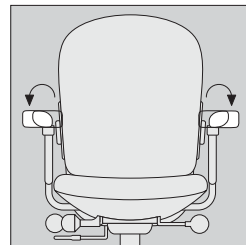

Arm width on standard T-arm.

Grasp arm caps, flip them over.

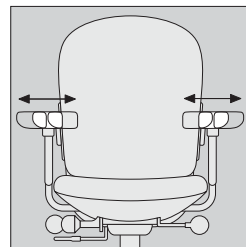

Arm width on rounded telescoping height, width, and pivot arm.

Grasp arm caps and move in or out. Arm will stay where positioned.

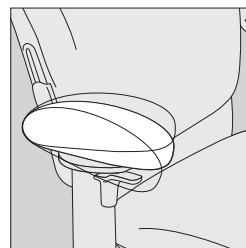

Arms pivot independently.

Grasp arm and push from front to left or right.

Surface Materials

▶ See surface materials on page 264 for specific availability or refer to the *Surface Materials Reference Manual* for further information.

Upholstery

- Fabric
- Fabric with soil-retardant treatment (option)
- Leather
- Elmosoft leather
- Vinyl

Hard components

(base, arms, plastic arm caps, outer back, outer seat, and face plate)

- Monochromatic color from list of seating plastic color numbers will apply to all hard components.

Outer back and outer seat

- Plastic color to match color of other "hard components"

Arms

- Plastic color arm caps to match the plastic color of the other "hard components"

All Steelcase seating with standard upholstery fabrics

complies with requirements of the State of California Technical Bulletin 117. All standard seating is labeled to be in compliance with California 117.

Programs & Services

▶ See the *Surface Materials Reference Manual* for further detail about programs and services offered for seating.

The Customer's Own Material (COM) Program

offers the opportunity for customers to select fabrics that are not offered through the standard Steelcase surface materials program for use on Steelcase products. Through the COM program, Steelcase will test your materials for application on Steelcase products. Once approved, you can place your order. Steelcase will facilitate the entire ordering process and give you a production schedule. Steelcase will order the COM fabric directly from the textile manufacturer. For up-to-date information regarding fabric test results for all COM fabrics and details regarding yardage requirements for most Seating lines, visit the COM Web site. To locate the COM Web site:

- Visit www.steelcase.com

Soil retardants are treatments that provide long-term soil and stain resistance to a fabric without affecting the shade or the integrity of the fabric. The following Steelcase Textiles are available pre-treated with soil retardant. (You do not need to select the soil-retardant option for these fabrics and incur the upcharge.)

- Jacks
- Link
- Spyder

For information on soil retardant fabrics on Select Surfaces, please refer to the *Surface Materials Reference Manual*.

Soil-retardant treatment is available on all other seating fabrics at an additional upcharge per seating unit. To order this option, please select "Soil-Retardant Treatment" under "Optional Accessories."

For soil-retardant treatment on COMs, please select “Soil-Retardant Treatment” under “Optional Accessories.” Minimums or additional yardage may be required. Please contact the vendor directly for specific information.

Extended lead times may be necessary for this service.

Contact your Steelcase Solutions Fulfillment Team Representative at 1.888.STEELCASE (1.888.783.3522) or send an email to lineone@steelcase.com.

Fire Codes

▶ See pages 270–271 for upholstery fabrics available for use with FCS modification.

Steelcase offers Fire Code Seating modification (FCS) on nearly all seating models. The most rigorous fire codes in the nation have been developed in California, and the Steelcase FCS modification is designed to meet those codes. Fire Code Seating (FCS) indicates that a product is constructed to meet the strict fire code requirements of high public occupancy areas such as theaters, meeting rooms, and lobbies. The FCS standards will meet both the State of California Home Furnishing Technical Bulletin 133 (Cal TB 133) and Boston Fire Code (BFC). Boston adopted the California Home Furnishing Technical Bulletin TB 133 test standard in 1992.

Local codes may have special requirements for upholstery.

Dimensions

▶ Page 172

Resources

Printed Materials

- ▶ Drive Brochure (04-0011869)
- ▶ Drive User Guide (S11264)

Computer Tools

- ▶ Interactive User Guide available on www.steelcase.com
- ▶ Electronic User Disk (S10615)

Dimensions

Drive 461 Series

Features	Overall Depth	Width	Height	Fixed Seat Depth	Adjustable Seat Depth	Seat Width	Seat Height from Floor	Back Width	Back Height from Seat
----------	---------------	-------	--------	------------------	-----------------------	------------	------------------------	------------	-----------------------

Drive 461 Series

Full-Back Work Chairs

Arms	27 ³ / ₈ "	26"	37 ¹ / ₂ "–42 ¹ / ₂ "	16 ³ / ₄ "	16"–19"	20"	15 ¹ / ₂ "–20 ¹ / ₂ "	18 ¹ / ₂ "	23 ¹ / ₂ "
Without Arms	27 ³ / ₈ "	26"	37 ¹ / ₂ "–42 ¹ / ₂ "	16 ³ / ₄ "	16"–19"	20"	15 ¹ / ₂ "–20 ¹ / ₂ "	18 ¹ / ₂ "	23 ¹ / ₂ "

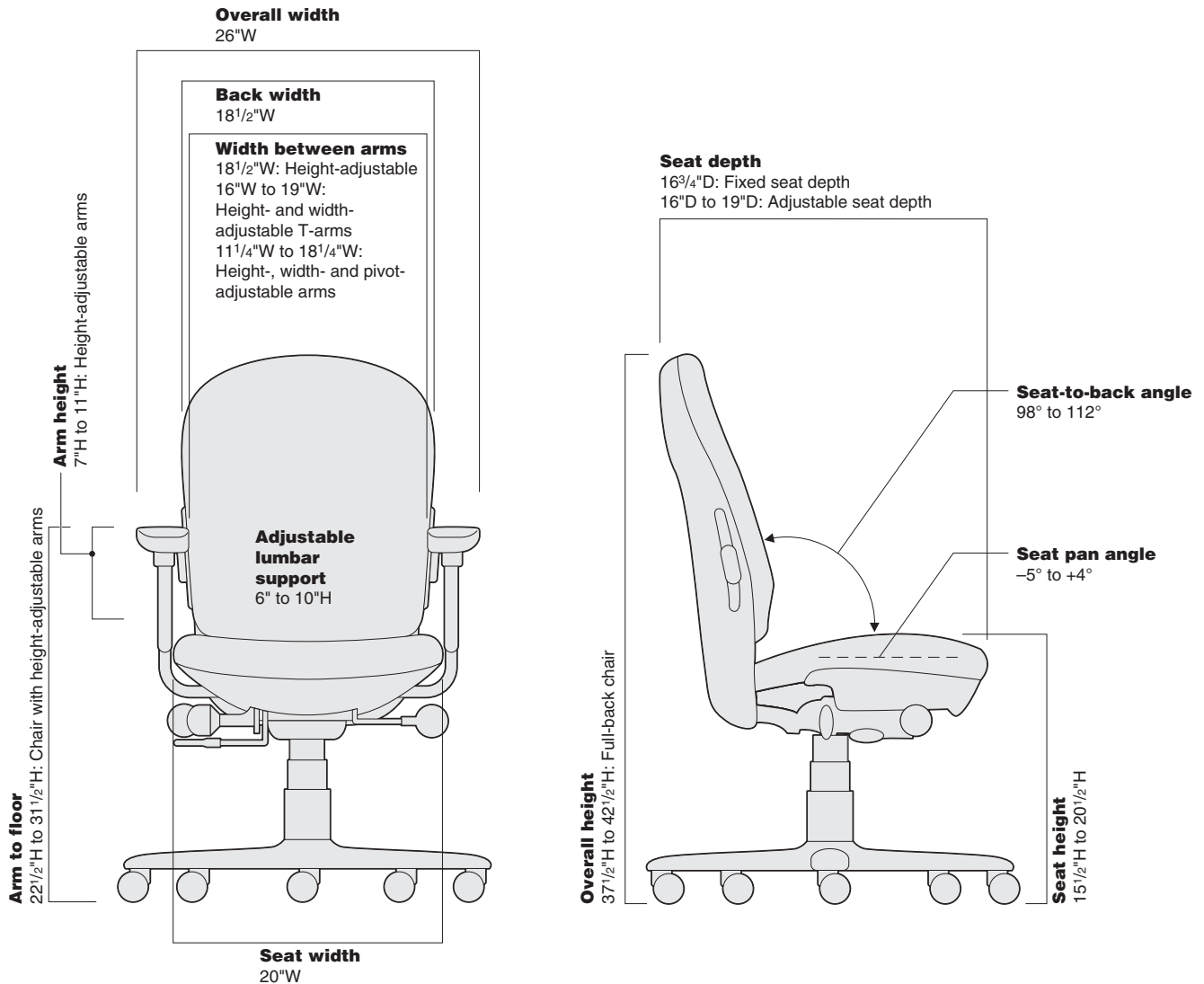

• Back Lumbar Height	• Arm to Floor	• Adjustable Arm Height from Seat	• Width Between Height-Adjustable Arms	• Width Between Height- and Width-Adjustable T-Arms	• Width Between Height-, Width- and Pivot-Adjustable Arm	• Seat Pan Angle	• Angle Between Seat and Back
----------------------	----------------	-----------------------------------	--	---	--	------------------	-------------------------------

Full-Back Work Chairs

6"-10"	22"-33"	7"-11"	18½"	16"-19"	11¼"-18¼"	-5°-+4°	98°-112°
6"-10"	N.A.	N.A.	N.A.	N.A.	N.A.	-5°-+4°	98°-112°

Drive 461 Series Work Chairs



	Standard Includes	Required to Specify
<p>► Need help? Product details, page 168</p>	<ul style="list-style-type: none"> • Synchro-tilt mechanism • Upright back lock • Lumbar adjustment • 5" seat height range • Pneumatic height adjustment • Height- and width-adjustable T-Arms, if selected: plastic color to match base • Outer back and outer seat: plastic • Upholstery: fabric price group 1 • Five-arm base: plastic color • 2½"-diameter, hard composition, dual-wheel casters: plastic color to match base 	<ol style="list-style-type: none"> 1 Style number 2 Plastic color number for base, outer back, outer seat, arms, and casters 3 Fabric color number for upholstery 4 Options, if selected (see below) <p>► See <i>Surface Materials</i>, page 264.</p>

	Options	U.S. Price	Required to Specify
Surface Materials	<p>Upholstery</p> <ul style="list-style-type: none"> • Fabric price group 1 • Fabric price group 2 • Fabric price group 3 • Fabric price group 4 • Fabric price group 5 • Fabric price group 6 • Fabric price group 7 • Fabric price group 8 • Fabric price group 9 • Fabric price group 10 • Customer's Own Material (COM) • Steelcase leather upholstery • Elmosoft leather upholstery • Steelcase vinyl • Customer's Own Leather (COL) • Customer's Own Vinyl (COV) • Fire Code Seating (FCS) • Soil-retardant treatment applied to upholstery fabric 	<p>No cost</p> <p>+\$ 22</p> <p>+\$ 43</p> <p>+\$ 59</p> <p>+\$ 75</p> <p>+\$ 92</p> <p>+\$107</p> <p>+\$134</p> <p>+\$166</p> <p>+\$187</p> <p>+\$ 32</p> <p>+\$622</p> <p>+\$718</p> <p>+\$ 68</p> <p>+\$375</p> <p>+\$ 68</p> <p>+\$ 64</p> <p>+\$ 21</p>	<p>Specify fabric color number.</p> <p>Specify fabric color number.</p> <p>Specify fabric color number.</p> <p>Specify fabric color number.</p> <p>Specify fabric color number.</p> <p>Specify fabric color number.</p> <p>Specify fabric color number.</p> <p>Specify fabric color number.</p> <p>Specify fabric color number.</p> <p>Specify fabric color number.</p> <p>► See <i>Surface Materials Reference Manual</i> to specify.</p> <p>Add suffix S to the style number and specify leather color number for upholstery.</p> <p>Add suffix S to the style number and specify Elmosoft leather color number.</p> <p>Add suffix S to the style number and specify vinyl color number.</p> <p>Add suffix S to the style number.</p> <p>► See <i>Surface Materials Reference Manual</i> to specify.</p> <p>Add suffix S to the style number.</p> <p>Add suffix F to style number.</p> <p>Specify with <i>soil-retardant treatment</i>.</p>
Rounded Arm Caps	<ul style="list-style-type: none"> • Independent height-, width-, and pivot-adjustable 	<p>+\$ 32</p>	<p>Specify with <i>height-, width-, and pivot-adjustable arms</i>.</p>
T-Arms	<ul style="list-style-type: none"> • Independent height-adjustable 	<p>-\$ 85</p>	<p>Specify with <i>height-adjustable T-arms</i>.</p>
Castors	<ul style="list-style-type: none"> • Soft, dual-wheel casters for use on hard floors (2½") 	<p>+\$ 21</p>	<p>Specify with <i>soft casters</i>.</p>

Tip: Always add suffixes in alphabetical order when specifying options to Drive seating.

Tip: Fire Code Seating (FCS) option is available only on models with 6205 black plastic components.
► Pages 270–271 for upholstery fabric choices.

► Detailed dimensions,
page 172



For Canadian Pricing
Multiply U.S. Price by the
Canadian price factor.
► See page 1 for details.

 = Last order entry
April 15, 2012

Specification Information

Arms with Soft Arm Caps



• Style
• Number

• U.S.
• Base
• Price

Without Arms



• Style
• Number

• U.S.
• Base
• Price

Full-Back Work Chairs

Back Lock, Seat Angle, Seat Depth

4611411 4/12 \$1163

4611401 4/12 \$933

Back Lock

4611111 4/12 \$1027

4611101 4/12 \$797



For Canadian Pricing
Multiply U.S. Price by the
Canadian price factor.
▶ See page 1 for details.

4/12 = Last order entry
April 15, 2012



Understanding and Specifying cobi 434 Series Collaborative Chairs

Product Details

cobi 434 Series	178
Dimensions	180

Specifying

Collaborative Chairs	182
Stools	184

Collaborative chairs

Collaborative seating promotes comfort for long periods of time and promotes movement, offers automatic and intuitive adjustments, and supports multiple postures.

- cob i 434 Series
- i2i 416 Series
- node 480 Series

Adjustability Features

▶ See page 12 for a comparison to other chairs

cobi 434 Series

Mechanisms

Weight-activated ●

Seat Adjustments

Pneumatic height ●

Back Adjustments

Self adjusting ●

cobi 434 Series

cobi is collaborative seating for teams that helps people move freely, change postures, and stay energized and comfortable.

Flexing fingers in back offer support while moving and conforming to the user.

Weight-activated mechanism provides support by automatically responding to the users movements.

Five-arm base is standard.

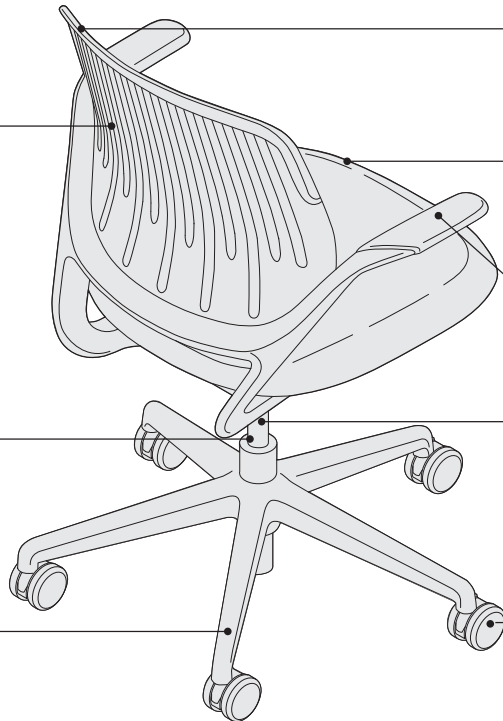

Flexible top edge allows for multiple postures while maintaining support and comfort.

Flexible seat edge on all 3-sides supports multiple postures while relieving thigh pressure.

Arms are constructed of a soft durable rubber compound.

Seat height adjusts with a 5" range from 15½"H to 20½"H with a pneumatic adjustment mechanism.

Hard, dual-wheel casters are standard for use on carpets. Soft, roll-control, dual-wheel casters are available for use on hard floors or chair mats.

Product Details



Chairs and stools are available with or without arms.



Weight-activated mechanism provides individual support without a tension control by intuitively sensing and supporting the users center of gravity.

cobi ships standard assembled and uncartoned. A cartoned version is available which ships unassembled with the chair seat, back, and cylinder separated from the base and mechanism. This allows for shipment in a smaller carton. Assembly by a qualified dealer installer is required. Assembly instructions are included.

Adjustment Features

Seat Adjustments

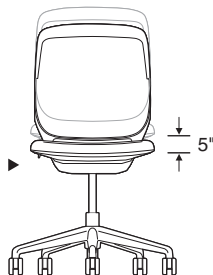

Seat height adjusts

pneumatically. To lower, pull lever up while seated. To raise, pull lever up and keep your weight off the chair.

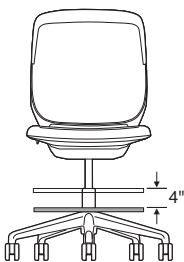

Foot ring height on stools

adjusts by first lifting ring and rotating it counter-clockwise to unlock. Then raise or lower ring up to 4" to desired position before rotating it clockwise to lock. The foot ring has a diameter of 20".

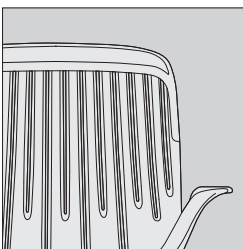

Flexing fingers in back

promote movement and provide support for a wide range of postures.

Soft roll-control caster option

features an internal brake that activates when the chair is not under load to reduce shifting when user stands up.

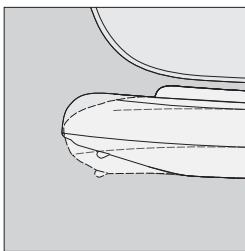

Flexing seat edge on all 3-sides supports multiple postures while relieving thigh pressure.

Surface Materials

▶ See surface materials on page 264 for specific availability or refer to the *Surface Materials Reference Manual* for further information.

Back Upholstery

- Connect 3D (back only)

Seat Upholstery

- Cogent: Connect (seat only)
- Fabric
- Fabric with soil-retardant treatment (option)
- Leather
- Elmosoft leather
- Vinyl
- COM
- COL
- COV

All seat upholstery except standard Cogent: Connect requires a sewn application. Specify with an **S** suffix.

Outer Back

- 6009 Arctic White
- 6205 Black
- 6249 Platinum
- 6295 Near Black

Arm Caps, Top Edge, and Casters

- 6205 Black
- 6249 Platinum

Tip: Frame and base will default to match outer back color.

Tip: Arm caps, top edge, and casters will coordinate to match outer back color.

Glides

- Plastic

Foot ring on stools

- 6205 Black
- 6249 Platinum

Tip: Foot ring on stool will coordinate to match outer back color.

All Steelcase seating with standard upholstery fabrics

complies with requirements of the State of California Technical Bulletin 117. All standard seating is labeled to be in compliance with California 117.

Programs & Services

▶ See the *Surface Materials Reference Manual* for further detail about programs and services offered for seating.

The Customer's Own Material (COM) Program

offers the opportunity for customers to select fabrics that are not offered through the standard Steelcase surface materials program for use on Steelcase products. Through the COM program, Steelcase will test your materials for application on Steelcase products. Once approved, you can place your order. Steelcase will facilitate the entire ordering process and give you a production schedule. Steelcase will order the COM fabric directly from the textile manufacturer. For up-to-date information regarding fabric test results for all COM fabrics and details regarding yardage requirements for most Seating lines, visit the COM Web site. To locate the COM Web site:

- Visit www.steelcase.com

Soil retardants are treatments that provide long-term soil and stain resistance to a fabric without affecting the shade or the integrity of the fabric. The following Steelcase Textiles are available pre-treated with soil retardant. (You do not need to select the soil-retardant option for these fabrics and incur the upcharge.)

- Jacks
- Link
- Spyder

For information on soil retardant fabrics on Select Surfaces, please refer to the *Surface Materials Reference Manual*.

Soil-retardant treatment is available on all other seating fabrics at an additional upcharge per seating unit. To order this option, please select "Soil-Retardant Treatment" under "Optional Accessories."

For soil-retardant treatment on COMs, please select "Soil-Retardant Treatment" under "Optional Accessories." Minimums or additional yardage may be required. Please contact the vendor directly for specific information.

Extended lead times may be necessary for this service.

Contact your Steelcase Solutions Fulfillment Team Representative at 1.888.STEELCASE (1.888.783.3522) or send an email to lineone@steelcase.com.

Fire Codes

▶ See pages 270–271 for upholstery fabrics available for use with FCS modification.

Steelcase offers Fire Code Seating modification (FCS) on nearly all seating models. The most rigorous fire codes in the nation have been developed in California, and the Steelcase FCS modification is designed to meet those codes. Fire Code Seating (FCS) indicates that a product is constructed to meet the strict fire code requirements of high public occupancy areas such as theaters, meeting rooms, and lobbies. The FCS standards will meet both the State of California Home Furnishing Technical Bulletin 133 (Cal TB 133) and Boston Fire Code (BFC). Boston adopted the California Home Furnishing Technical Bulletin TB 133 test standard in 1992.

Local codes may have special requirements for upholstery.

Dimensions

▶ Page 180

Resources

Printed Materials

▶ *cobi* Brochure (09-0000049)

Dimensions

cobi 434 Series

Features	Overall Depth	Width	Height	Seat Depth	Functional Seat Depth	Seat Width	Seat Height from Floor	Back Width	Back Height from Seat
cobi 434 Series									
Collaborative Chairs									
	23 ¹ / ₄ "	24 ³ / ₄ "	34"-39"	19 ¹ / ₂ "	17 ⁷ / ₈ "	18 ³ / ₄ "	15 ¹ / ₂ "-20 ¹ / ₂ "	18"	19 ¹ / ₂ "
Stools									
	23 ¹ / ₄ "	24 ³ / ₄ "	40"-50"	19 ¹ / ₂ "	17 ⁷ / ₈ "	18 ³ / ₄ "	21"-31"	18"	19 ¹ / ₂ "

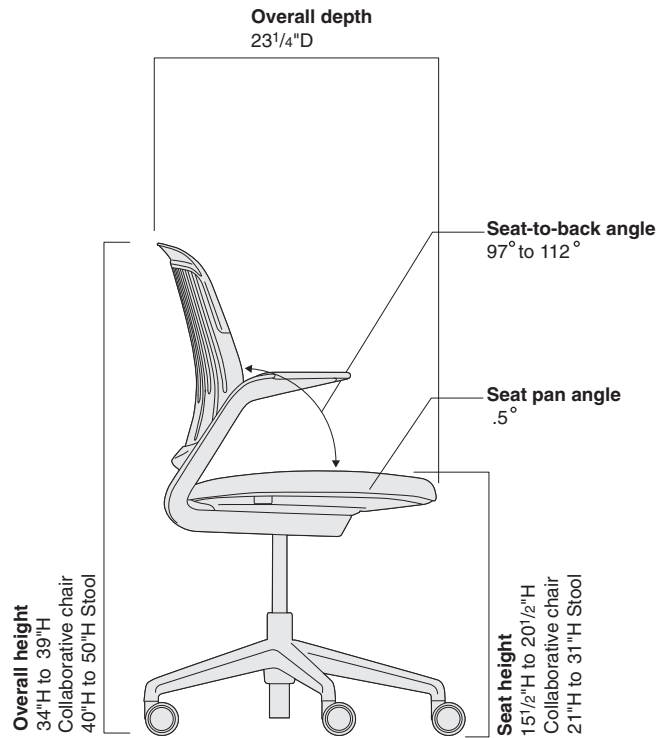
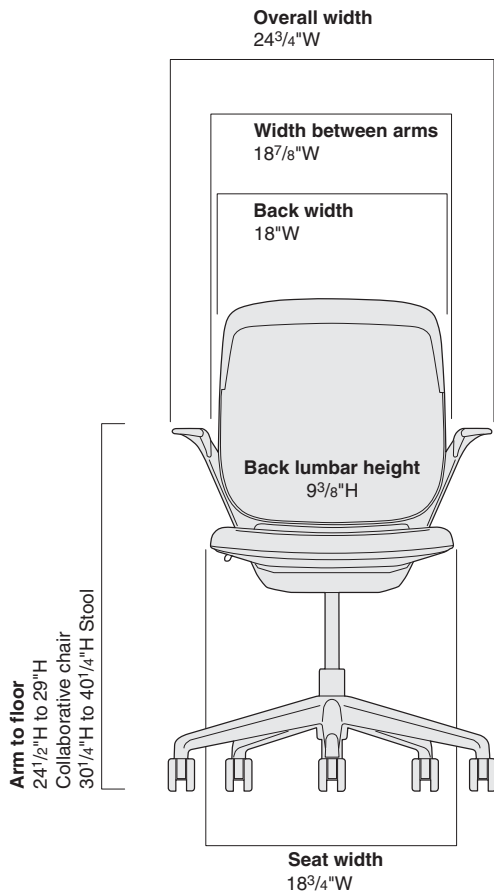

• Back • Lumbar • Height	• Width • Between • Arms	• Arm • to • Floor	• Arm • Height • from • Seat	• Seat • Pan • Angle	• Angle • Between • Seat and • Back
--------------------------------	--------------------------------	--------------------------	---------------------------------------	----------------------------	--

Collaborative Chairs

9 ³ / ₈ "	18 ⁷ / ₈ "	24 ¹ / ₄ "–29"	8 ⁷ / ₈ "	.5°	97°–112°
---------------------------------	----------------------------------	--------------------------------------	---------------------------------	-----	----------

Stools

9 ³ / ₈ "	18 ⁷ / ₈ "	30 ¹ / ₄ "–40 ¹ / ₄ "	8 ⁷ / ₈ "	.5°	97°–112°
---------------------------------	----------------------------------	---	---------------------------------	-----	----------

cobi 434 Series Collaborative Chairs



▶ Need help?
Product details,
page 178

Standard Includes

- Weight-activated mechanism
- 5" pneumatic seat-height adjustment
- Fixed arms, if selected: plastic to match outer back
- Back upholstery: Connect 3D
- Seat upholstery: Cogent: Connect
- Frame, outer back, and five-arm base: Black
- 2½"-diameter, hard composition, dual-wheel casters: black plastic

Required to Specify

- 1 Style number
 - 2 Plastic color number for outer back
 - 3 Connect 3D color number for back
 - 4 Cogent: Connect color number for upholstery on seat
 - 5 Options, if selected (see below)
- ▶ See *Surface Materials*, page 264.

*Tip: All seat upholstery except standard Cogent: Connect requires a sewn application. Specify with an **S** suffix.*

Tip: Always add suffixes in alphabetical order when specifying options to cobi seating.

Tip: Fire Code Seating (FCS) option is available with certain upholstery fabric choices only.
▶ Pages 270–271

Tip: Arm caps, top edge, and casters default to coordinate and match outer back color.

▶ Detailed dimensions,
page 180



For Canadian Pricing
Multiply U.S. Price by the
Canadian price factor.
▶ See page 1 for details.

	Options	U.S. Price	Required to Specify
Surface Materials	Upholstery		
	• Fabric price group 1	No cost	Add suffix S to the style number and specify fabric color number.
	• Fabric price group 2	No cost	Add suffix S to the style number and specify fabric color number.
	• Fabric price group 3	+\$ 22	Add suffix S to the style number and specify fabric color number.
	• Fabric price group 4	+\$ 30	Add suffix S to the style number and specify fabric color number.
	• Fabric price group 5	+\$ 37	Add suffix S to the style number and specify fabric color number.
	• Fabric price group 6	+\$ 46	Add suffix S to the style number and specify fabric color number.
	• Fabric price group 7	+\$ 54	Add suffix S to the style number and specify fabric color number.
	• Fabric price group 8	+\$ 68	Add suffix S to the style number and specify fabric color number.
	• Fabric price group 9	+\$ 83	Add suffix S to the style number and specify fabric color number.
	• Fabric price group 10	+\$ 95	Add suffix S to the style number and specify fabric color number.
	• Customer's Own Material (COM)	+\$ 36	Add suffix S to the style number and specify fabric color number.
	• Steelcase leather upholstery	+\$156	Add suffix S to the style number and specify leather color number.
	• Elmosoft leather upholstery	+\$180	Add suffix S to the style number and specify Elmosoft leather color number.
	• Sewn Upholstery	+\$ 36	Add suffix S to the style number and specify fabric color number.
• Steelcase vinyl	+\$ 36	Add suffix S to the style number and specify vinyl color number.	
• Customer's Own Leather (COL)	+\$ 36	Add suffix S to the style number and specify leather color number.	
• Customer's Own Vinyl (COV)	+\$ 36	Add suffix S to the style number and specify vinyl color number.	
• Fire Code Seating (FCS)	+\$ 32	Add suffix F to the style number.	
• Soil-retardant treatment applied to upholstery fabric	+\$ 21	Specify <i>with soil-retardant treatment</i> .	
	Outer back		
	• White	+\$ 78	Specify <i>with 6009 White</i> .
	• Platinum	+\$ 78	Specify <i>with 6249 Platinum</i> .
	• Near black	+\$ 78	Specify <i>with 6295 Near Black</i> .
Casters	• Soft, dual-wheel roll-control casters	+\$ 21	Specify <i>with soft roll-control casters</i> .
Glides	• Glides: plastic	+\$ 21	Specify <i>with glides</i> .

Specification Information

**Arms with
Soft Arm Caps**



• Style
• Number

• U.S.
• Base
• Price

434111

\$680

Without Arms



• Style
• Number

• U.S.
• Base
• Price

434110

\$626



For Canadian Pricing
Multiply U.S. Price by the
Canadian price factor.
▶ See page 1 for details.

cobi 434 Series Swivel-Base Stools

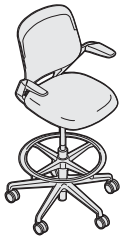

► Need help?
Product details,
page 178

Standard Includes

- Weight-activated mechanism
- 10" pneumatic seat-height adjustment
- Fixed arms, if selected: plastic to match outer back
- Adjustable foot ring: black
- Back upholstery: Connect 3D
- Seat upholstery: Cogent: Connect
- Frame, outer back, and five-arm base: black
- 2½"-diameter, hard composition, dual-wheel casters: black plastic

Required to Specify

- 1 Style number
 - 2 Plastic color number for outer back
 - 3 Connect 3D color number for back
 - 4 Cogent: Connect color number for upholstery on seat
 - 5 Options, if selected (see below)
- See *Surface Materials*, page 264.

Tip: All seat upholstery except standard Cogent: Connect requires a sewn application. Specify with an S suffix.

Tip: Always add suffixes in alphabetical order when specifying options to cobi seating.

Tip: Fire Code Seating (FCS) option is available with certain upholstery fabric choices only.
► Pages 270–271

Tip: Arm caps, top edge, casters, and stool ring default to coordinate and match outer back color.

► Detailed dimensions,
page 180



For Canadian Pricing
Multiply U.S. Price by the
Canadian price factor.
► See page 1 for details.

	Options	U.S. Price	Required to Specify
Surface Materials	Upholstery		
	• Fabric price group 1	No cost	Add suffix S to the style number and specify fabric color number.
	• Fabric price group 2	No cost	Add suffix S to the style number and specify fabric color number.
	• Fabric price group 3	+\$ 22	Add suffix S to the style number and specify fabric color number.
	• Fabric price group 4	+\$ 30	Add suffix S to the style number and specify fabric color number.
	• Fabric price group 5	+\$ 37	Add suffix S to the style number and specify fabric color number.
	• Fabric price group 6	+\$ 46	Add suffix S to the style number and specify fabric color number.
	• Fabric price group 7	+\$ 54	Add suffix S to the style number and specify fabric color number.
	• Fabric price group 8	+\$ 68	Add suffix S to the style number and specify fabric color number.
	• Fabric price group 9	+\$ 83	Add suffix S to the style number and specify fabric color number.
	• Fabric price group 10	+\$ 95	Add suffix S to the style number and specify fabric color number.
	• Customer's Own Material (COM)	+\$ 36	Add suffix S to the style number and specify fabric color number.
	• Steelcase leather upholstery	+\$156	Add suffix S to the style number and specify leather color number.
	• Elmosoft leather upholstery	+\$180	Add suffix S to the style number and specify Elmosoft leather color number.
	• Sewn Upholstery	+\$ 36	Add suffix S to the style number and specify fabric color number.
• Steelcase vinyl	+\$ 36	Add suffix S to the style number and specify vinyl color number.	
• Customer's Own Leather (COL)	+\$ 36	Add suffix S to the style number and specify leather color number.	
• Customer's Own Vinyl (COV)	+\$ 36	Add suffix S to the style number and specify vinyl color number.	
• Fire Code Seating (FCS)	+\$ 32	Add suffix F to the style number.	
• Soil-retardant treatment applied to upholstery fabric	+\$ 21	Specify <i>with soil-retardant treatment</i> .	
	Outer back		
	• White	+\$120	Specify <i>with 6009 White</i> .
	• Platinum	+\$120	Specify <i>with 6249 Platinum</i> .
	• Near black	+\$120	Specify <i>with 6295 Near Black</i> .
Casters	• Soft, dual-wheel roll-control casters	+\$ 21	Specify <i>with soft roll-control casters</i> .
Glides	• Glides: plastic	+\$ 21	Specify <i>with glides</i> .

Specification Information

**Arms with
Soft Arm Caps**



• **Style
Number**

• **U.S.
Base
Price**

434711

\$948

Without Arms



• **Style
Number**

• **U.S.
Base
Price**

434710

\$894



For Canadian Pricing
Multiply U.S. Price by the
Canadian price factor.
▶ See page 1 for details.



Understanding and Specifying i2i 416 Series

Collaborative Chairs and Collaborative Lounge Table

Product Details

i2i 416 Series	188
Dimensions	190

Specifying

Collaborative Chairs	192
Collaborative Lounge Table	193

Collaborative Chairs

Collaborative seating promotes comfort for long periods of time and promotes movement, offers automatic and intuitive adjustments, and supports multiple postures.

- cobī 434 Series
- i2i 416 Series
- node 480 Series

Adjustability Features

▶ See page 12 for a comparison to other chairs

i2i 416 Series

Mechanisms

Dual-swivel	●
-------------	---

Back Adjustments

Self adjusting	●
----------------	---

i2i 416 Series

i2i is collaborative seating that helps people move freely, change postures, and stay energized and comfortable.

Upholstery specified is applied to seat and arms.

Flexing fingers form the back and offer support while moving and conforming to your body.

Dual-swivel mechanism allows the back and seat to swivel independently as well as together.

Four-arm base is standard in polished aluminum.

Glides are standard with the static base.

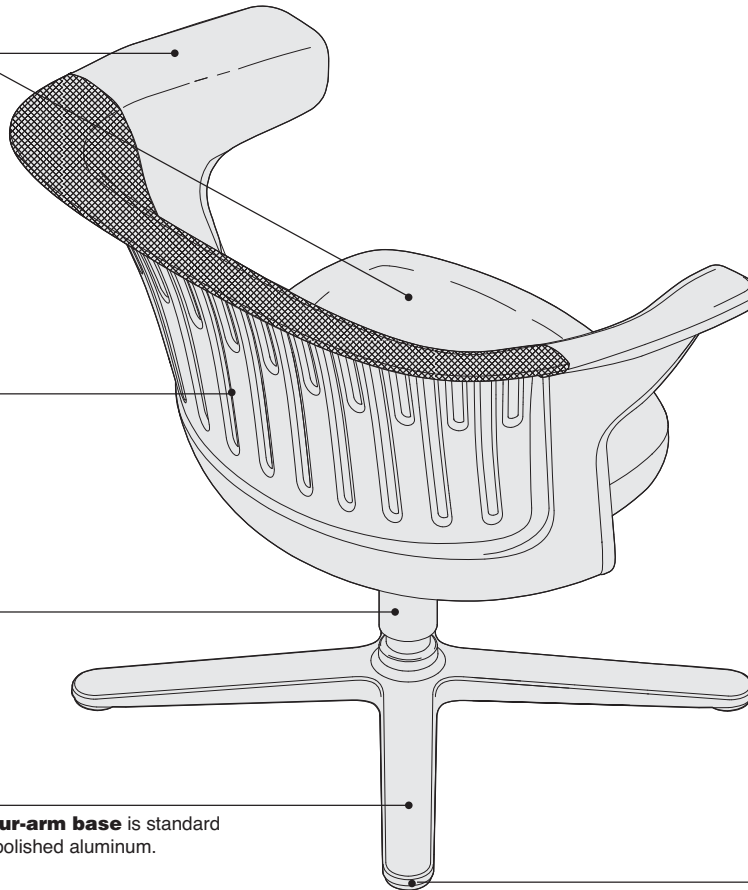

Product Details



Chairs are available with or without tablet arm.

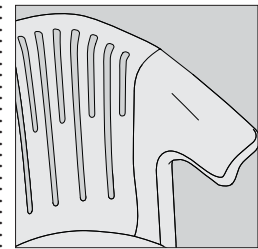

Flexing fingers in the back promote movement and provide support in a variety of postures.

Dual-swivel mechanism allows the back and seat to swivel independently as well as together.

Tablet arm attaches on the right side of the chair with a dual pivot function providing a range of motion that allows the tablet area to accommodate both left and right handed users. It provides a worksurface 12 $\frac{1}{4}$ "D x 18"W.

Adjustment Features

Swivel-return cylinder option has a built in memory and will return to the fixed position when the user leaves the chair.

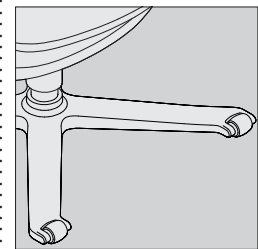

Mobile base includes two rollers on the front arms of the base that allow the chair to be moved easily.

Surface Materials

- ▶ See surface materials on page 264 for specific availability or refer to the *Surface Materials Reference Manual* for further information.

Back Upholstery

- 3D Knit (back only)

Seat and Arm Upholstery

- Cogent: Connect (seat and arm only)
- Fabric
- Fabric with soil-retardant treatment (option)
- Leather
- Elmosoft leather
- Vinyl
- COM
- COL
- COV

Cogent: Connect maximizes quality and comfort on i2i.

The selected upholstery will be applied to the seat and arms. It is standard with a sewn application.

Frame

- 6009 Arctic White
- 6249 Platinum
- 6295 Near Black

Tablet Arm

- Laminate
- Veneer

The laminate surface is available with a black edge only. The veneer surface has a self edge.

Glides

- Black plastic

Rollers

- Optional rollers on mobile base are available in dark fusion only.

All Steelcase seating with standard upholstery fabrics

complies with requirements of the State of California Technical Bulletin 117. All standard seating is labeled to be in compliance with California 117.

Programs & Services

- ▶ See the *Surface Materials Reference Manual* for further detail about programs and services offered for seating.

The Customer's Own Material (COM) Program

offers the opportunity for customers to select fabrics that are not offered through the standard Steelcase surface materials program for use on Steelcase products. Through the COM program, Steelcase will test your materials for application on Steelcase products. Once approved, you can place your order. Steelcase will facilitate the entire ordering process and give you a production schedule. Steelcase will order the COM fabric directly from the textile manufacturer. For up-to-date information regarding fabric test results for all COM fabrics and details regarding yardage requirements for most Seating lines, visit the COM Web site. To locate the COM Web site:

- Visit www.steelcase.com

Soil retardants are treatments that provide long-term soil and stain resistance to a fabric without affecting the shade or the integrity of the fabric. The following Steelcase Textiles are available pre-treated with soil retardant. (You do not need to select the soil-retardant option for these fabrics and incur the upcharge.)

- Jacks
- Link
- Spyder

For information on soil retardant fabrics on Select Surfaces, please refer to the *Surface Materials Reference Manual*.

Soil-retardant treatment is available on all other seating fabrics at an additional upcharge per seating unit. To order this option, please select "Soil-Retardant Treatment" under "Optional Accessories."

For soil-retardant treatment on COMs, please select "Soil-Retardant Treatment" under "Optional Accessories." Minimums or additional yardage may be required. Please contact the vendor directly for specific information.

Extended lead times may be necessary for this service.

Contact your Steelcase Solutions Fulfillment Team Representative at 1.888.STEELCASE (1.888.783.3522) or send an email to lineone@steelcase.com.

Fire Codes

- ▶ See pages 270–271 for upholstery fabrics available for use with FCS modification.

Steelcase offers Fire Code Seating modification (FCS) on nearly all seating models. The most rigorous fire codes in the nation have been developed in California, and the Steelcase FCS modification is designed to meet those codes. Fire Code Seating (FCS) indicates that a product is constructed to meet the strict fire code requirements of high public occupancy areas such as theaters, meeting rooms, and lobbies. The FCS standards will meet both the State of California Home Furnishing Technical Bulletin 133 (Cal TB 133) and Boston Fire Code (BFC). Boston adopted the California Home Furnishing Technical Bulletin TB 133 test standard in 1992.

Local codes may have special requirements for upholstery.

Dimensions

- ▶ Page 190

Resources

Printed Materials

- ▶ i2i Brochure (08-0001013)

Dimensions

i2i 416 Series

Features	Overall Depth	Width	Height	Seat Depth	Functional Seat Depth	Seat Width	Seat Height from Floor	Back Height from Seat	Back Lumbar Height
i2i 416 Series									
Collaborative Chairs									
	25"	32½"	31⅛"	17½"	17¼"	19"	17½"	17¼"	9¼"

Dimensions were measured with BIFMA CMD (chair-measuring device).

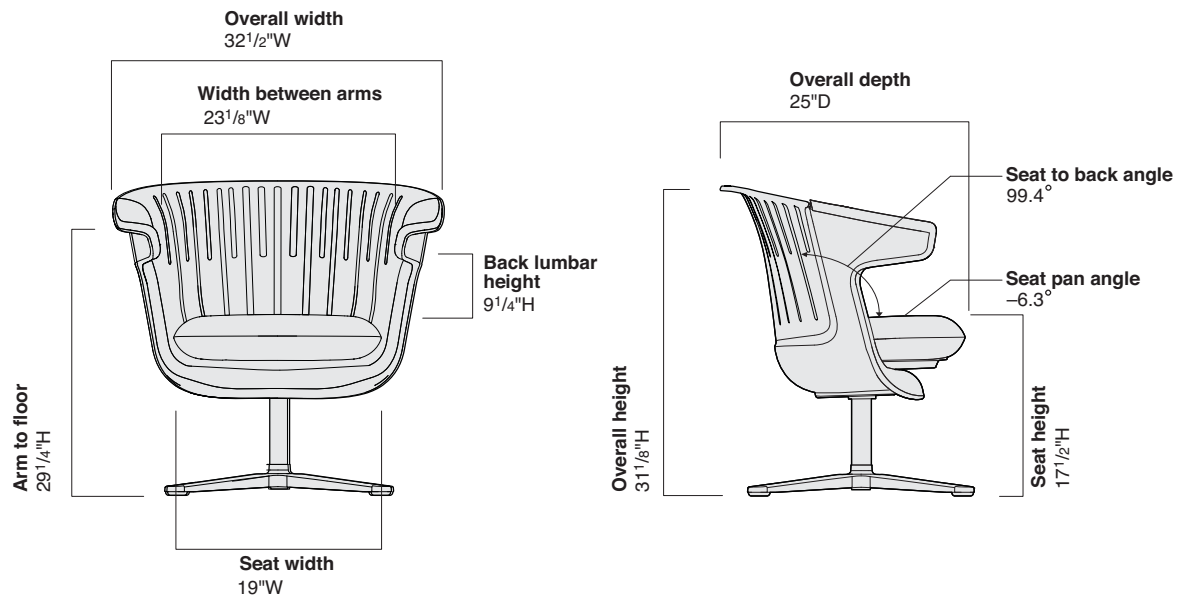

• Width • Between • Arms	• Arm • to • Floor	• Seat • Pan • Angle	• Angle • Between • Seat and • Back
--------------------------------	--------------------------	----------------------------	--

Collaborative Chairs

23 1/8"	29 1/4"	-6.3°	99.4°
---------	---------	-------	-------

i2i 416 Series Collaborative Chairs

Standard Includes		Required to Specify
<ul style="list-style-type: none"> ▶ Need help? Product details, page 188 	<ul style="list-style-type: none"> • Back: near black • Static base with dual-swivel mechanism: polished aluminum • Back upholstery: 3D Knit • Seat and arms: sewn upholstery • Tablet arm, if selected: laminate • Glides: black plastic 	<ol style="list-style-type: none"> 1 Style number 2 Plastic color number for frame 3 3D Knit color number for back 4 Fabric color number for upholstery on seat and arms 5 Laminate color number for tablet arm, if selected 6 Options, if selected (see below) <ul style="list-style-type: none"> ▶ See <i>Surface Materials</i>, page 264.

Tip: Cogent: Connect maximizes quality and comfort on the seat and arms on i2i.

Options	U.S. Price	Required to Specify
Surface Materials <ul style="list-style-type: none"> • Fabric price group 1 • Fabric price group 2 • Fabric price group 3 • Fabric price group 4 • Fabric price group 5 • Fabric price group 6 • Fabric price group 7 • Fabric price group 8 • Fabric price group 9 • Fabric price group 10 • Customer's Own Material (COM-sewn) • Steelcase leather upholstery • Elmosoft leather • Steelcase vinyl • Customer's Own Leather (COL) • Customer's Own Vinyl (COV) 	<ul style="list-style-type: none"> No cost No cost +\$ 43 +\$ 59 +\$ 75 +\$ 92 +\$107 +\$134 +\$166 +\$187 +\$ 36 +\$311 +\$359 No cost +\$ 36 +\$ 36 	<ul style="list-style-type: none"> Specify fabric color number. Specify fabric color number. Specify fabric color number. Specify fabric color number. Specify fabric color number. Specify fabric color number. Specify fabric color number. Specify fabric color number. Specify fabric color number. Specify fabric color number. See <i>Surface Materials Reference Manual</i> to specify. Specify leather color number. Specify Elmosoft leather color number. Specify vinyl color number. See <i>Surface Materials Reference Manual</i> to specify. See <i>Surface Materials Reference Manual</i> to specify. Add suffix F to the style number. Specify <i>with soil-retardant treatment</i>.
Upholstery <ul style="list-style-type: none"> • Fire Code Seating (FCS) • Soil-retardant treatment applied to upholstery fabric 	<ul style="list-style-type: none"> +\$ 64 +\$ 21 	
Platinum <ul style="list-style-type: none"> • On back shell 	<ul style="list-style-type: none"> +\$ 78 	<ul style="list-style-type: none"> Specify <i>with 6249 Platinum</i>.
Base <ul style="list-style-type: none"> • Mobile base 	<ul style="list-style-type: none"> +\$ 52 	<ul style="list-style-type: none"> Specify <i>with mobile base</i>.
Cylinder <ul style="list-style-type: none"> • Swivel with return 	<ul style="list-style-type: none"> +\$ 52 	<ul style="list-style-type: none"> Specify <i>with swivel return</i>.
Tablet Arm <ul style="list-style-type: none"> • Wood veneer 	<ul style="list-style-type: none"> +\$208 	<ul style="list-style-type: none"> Specify <i>with wood veneer</i>.

Tip: Fire code seating (FCS) option is available with certain upholstery fabric choices only.
▶ Pages 270–271

Tip: Always add suffixes in alphabetical order when specifying options to i2i seating.

Specification Information



With tablet arm

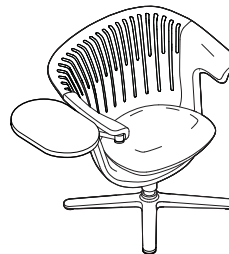

▶ Detailed dimensions, page 190

 **For Canadian Pricing**
Multiply U.S. Price by the Canadian price factor.
▶ See page 1 for details.

Style Number	U.S. Base Price	Style Number	U.S. Base Price
416911	\$1872	416911T	\$2080

Collaborative Lounge Table

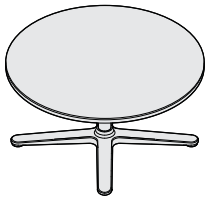

Standard Includes	Required to Specify
<ul style="list-style-type: none"> ▶ Need help? See <i>c:scape Specification Guide</i> for details. • Table: High-Pressure Laminate surface with 3 mm plastic edge profile • Base: Polished Aluminum 	<ol style="list-style-type: none"> 1 Style number 2 Laminate color number for table 3 Plastic color number for edge on laminate surface 4 Options, if selected (see below) <p>▶ See <i>Surface Materials</i>, page 264.</p>

Options	U.S. Price	Required to Specify
Surface Materials High-Pressure Laminate surface <ul style="list-style-type: none"> • Open Line laminate 	+\$ 64 plus cost of laminate	<p>▶ See <i>Surface Materials Reference Manual</i>.</p>
Wood veneer surface <ul style="list-style-type: none"> • Wood veneer surface with matching 3 mm edge profile • Premium wood 2 • Premium wood 3 • Customiz stain • Full-fill finish 	+\$333 +\$395 +\$458 +\$ 12 +\$ 25	Specify <i>with wood veneer</i> and indicate wood color number. Specify <i>with wood veneer</i> and indicate Premium wood 2 color number. Specify <i>with wood veneer</i> and indicate Premium wood 3 color number. Specify <i>with Customiz stain</i> . <p>▶ See <i>Surface Materials Reference Manual</i>. Specify full-fill finish number.</p>

Specification Information			
Dimensions		Style Number	U.S. Base Price
Diameter	Height		
32"	16"	CQCT1632	\$1144

Product on this page is *c:scape*, not seating. It is included here to simplify your planning. Remember that systems has different pricing terms than seating products.

 **For Canadian Pricing**
 Multiply U.S. Price by the Canadian price factor.
 ▶ See page 1 for details.



Understanding and Specifying node 480 Series Collaborative Chairs

Product Details

node 480 Series	196
Dimensions	198

Specifying

Collaborative Chairs	200
Collaborative Stool	202

Collaborative Chairs

Collaborative seating promotes comfort for long periods of time and promotes movement, offers automatic and intuitive adjustments, and supports multiple postures.

- cobii 434 Series
- i2i 416 Series
- node 480 Series

Adjustability Features

▶ See page 12 for a comparison to other chairs

node 480 Series

Mechanisms

360°-swivel



node 480 Series

node is collaborative seating for classrooms and other learning environments that supports multiple learning modes, freedom to change postures, and storage and use of student belongings.

One piece polypropylene contoured shell is designed for easy maintenance.

Flexible and contoured seat shell supports comfort by allowing many postures.

Casters have hard, dual wheels that roll smoothly on carpets. Soft dual-wheel casters are available for use on hard floors.

Personal worksurface moves independently of seat shell and base.

Personal worksurface is mounted on the right but appropriate for both right- and left-hand users.

Personal worksurface is depth adjustable for large and small users and allows for ingress/egress.

Five-arm base is standard.

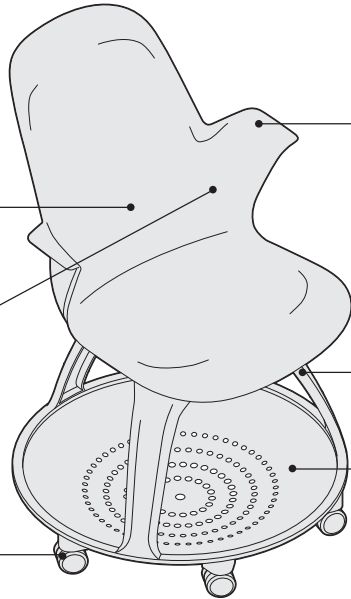

Arms are designed to support arms, side-sitting postures, and serve as a backpack hook.

360°-swivel mechanism is standard.

Backpack storage area is standard.

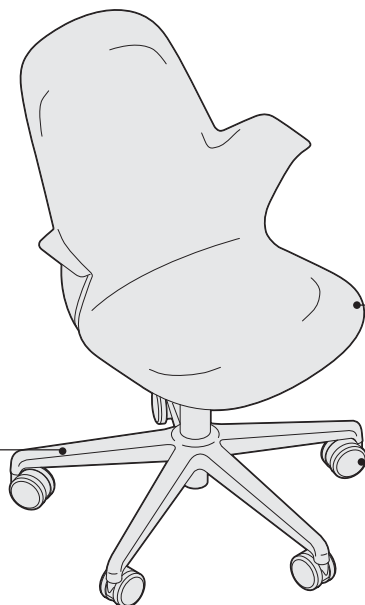
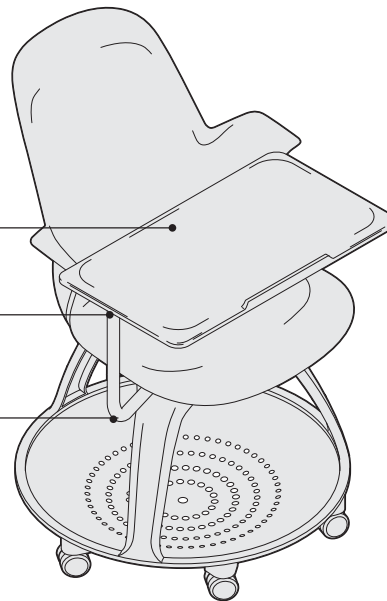

Seat height adjusts with a 6" range from 15⁷/₈"H to 21⁷/₈"H with a pneumatic adjustment mechanism.

Hard, dual wheel casters are standard for use on carpets. Soft, roll-control dual-wheel casters are available for use on hard floors or chair mats.

Product Details

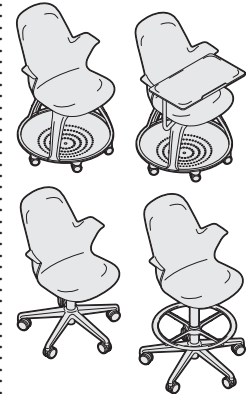

Chairs and stools are available. Chairs are available with a tripod base, tripod base with personal worksurface, or five-arm base with pneumatic adjustment. Stools are available with five-arm base only.

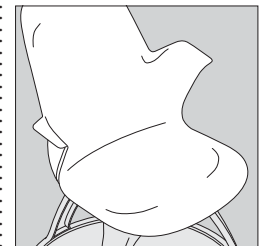

Flexing seat shell and arms promotes movement and supports multiple postures. Integrated arms support user's arms, side posture, and act as a backpack hook.

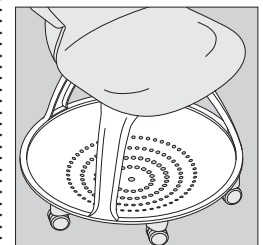

Tripod base reclaims the space under the seat. The space is 1.7 cu/ft. and allows for backpacks or personal belongings to be stored, and serves as a footrest.

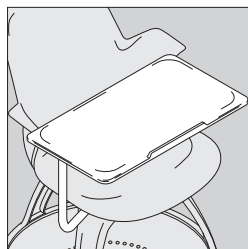

Personal workspace is mounted on user's right, and designed to accommodate left- and right-handed users. It is 12"D x 22¹/₄"W and features a safety stop to help prevent belongings and laptops from easily sliding off back edge.

node ships standard unassembled and cartoned with the seat shell separated from the base. This allows for shipment in a smaller carton. Five-arm base chairs and stools ship two to a carton. Assembly by a qualified Steelcase dealer installer is required. Assembly instructions are available at www.steelcase.com. No tools required for assembly.

Adjustment Features

360° fixed height swivel mechanism on tripod base models

allows students to remain oriented to instructor, presentation materials, and other students.

360° adjustable height swivel mechanism is standard on five-arm base models.

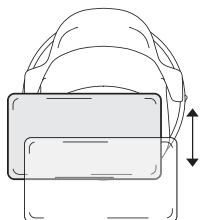

Personal workspace depth adjustment range is 7¹/₄" to 15". Measurement is from lumbar to workspace.

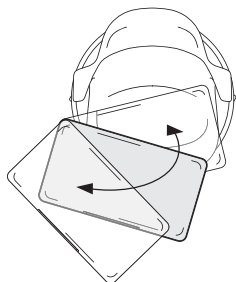

Personal workspace pivot range is 60°.

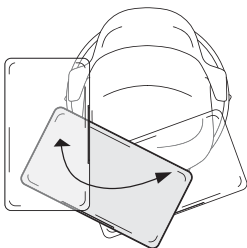

Personal workspace center pivot is 110°. The center pivot range is measured from the closest position to the furthest position from the user.

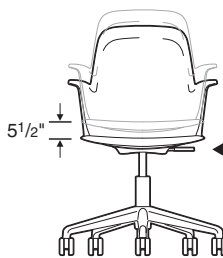

Seat height adjusts pneumatically. To lower, pull lever up while seated. To raise, pull lever up and keep your weight off the chair. Range of adjustability is 5¹/₂" from 15¹/₂"H to 21"H. An 8" range of adjustability is available on stools.

Glides are available as an option. Glides ship assembled on the chair or stool and maintain same height as casters.

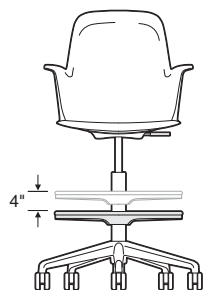

Foot ring height on stools adjusts by first lifting ring and rotating it counter-clockwise to unlock. Then raise or lower ring up to 4" to desired position before rotating it clockwise to lock. The foot ring has a diameter of 20".

Soft, dual-wheel roll-control casters for hard floors are available on five-arm base chairs and stools only.

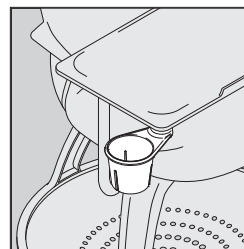

Cup holder is available as an option on node chairs with personal workspaces. It is retractable under the workspace when not in use.

Surface Materials

▶ See surface materials on page 264 for specific availability or refer to the *Surface Materials Reference Manual* for further information.

Seat Shell

- 6009 Arctic White
- 6059 Sterling Dark Solid
- 6205 Black
- 6249 Platinum Solid
- 6259 Midnight
- 6332 Citron
- 6333 Picasso
- 6334 Flash
- 6335 Wasabi
- 6336 Jazz
- 6337 Element
- 6338 Chili

Tripod Base

- 6249 Platinum Solid
- 6295 Near Black
- 6337 Element

Five-arm Base

- 6205 Black
- 6249 Platinum Solid
- 6337 Element

Personal Workspace

- 6053 Seagull
- 6249 Platinum Solid
- 6295 Near Black
- 6337 Element
- 6654 Sand

Paint for Metal

- 0835 Black
- 4750 Champagne Metallic
- 4799 Platinum

Casters

- Black

Glides

- Black plastic

Cup Holder

- Sterling Dark Solid

Fire Code Seating (FCS) option is available. ▶ See *Surface Materials*, page 264.

Steelcase offers Fire Code Seating modification (FCS) on nearly all seating models. The most rigorous fire codes in the nation have been developed in California, and the Steelcase FCS modification is designed to meet those codes. Fire Code Seating (FCS) indicates that a product is constructed to meet the strict fire code requirements of high public occupancy areas such as theaters, meeting rooms, and lobbies. The FCS standards will meet both the State of California Home Furnishing Technical Bulletin 133 (Cal TB 133) and Boston Fire Code (BFC). Boston adopted the California Home Furnishing Technical Bulletin TB 133 test standard in 1992.

Dimensions

▶ Page 198

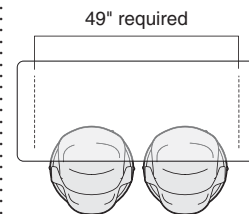

The backpack storage area and overall chair width require 23³/₄" of continuous floor space when used with tables. The minimum distance between table bases is 49" to allow two chairs to be pushed under the workspace. This does not apply to five-arm base models.

Resources

Printed Materials

▶ node Brochure (10-0002733)

Dimensions

node 480 Series

Features	Overall Depth	Width	Height	Seat Depth	Seat Width	Seat Height from Floor	Width Between Arms	Arm to Floor
----------	---------------	-------	--------	------------	------------	------------------------	--------------------	--------------

node 480 Series

Tripod Base Collaborative Chair

25"	23 ³ / ₄ "	35"	16 ¹ / ₂ "	19 ¹ / ₂ "	18 ¹ / ₄ "	20 ¹ / ₈ "	26 ³ / ₄ "
-----	----------------------------------	-----	----------------------------------	----------------------------------	----------------------------------	----------------------------------	----------------------------------

Tripod Base Collaborative Chair with Personal Worksurface

25" to 31 ¹ / ₂ "	27 ¹ / ₄ " to 32 ³ / ₄ "	35"	16 ¹ / ₂ "	19 ¹ / ₂ "	18 ¹ / ₄ "	20 ¹ / ₈ "	26 ³ / ₄ "
---	--	-----	----------------------------------	----------------------------------	----------------------------------	----------------------------------	----------------------------------

Five-Arm Base Collaborative Chair

25"	23 ³ / ₄ "	33 ¹ / ₄ " to 38 ¹ / ₂ "	16 ¹ / ₂ "	19 ¹ / ₂ "	15 ⁷ / ₈ " to 21 ⁷ / ₈ "	20 ¹ / ₈ "	24 ⁵ / ₈ " to 30"
-----	----------------------------------	--	----------------------------------	----------------------------------	--	----------------------------------	---

Five-Arm Base Stool

25"	27 ¹ / ₄ "	40 ⁷ / ₈ " to 48 ¹ / ₄ "	16 ¹ / ₂ "	19 ¹ / ₂ "	23 ⁷ / ₈ " to 31 ⁷ / ₈ "	20 ¹ / ₈ "	27" to 35"
-----	----------------------------------	--	----------------------------------	----------------------------------	--	----------------------------------	------------

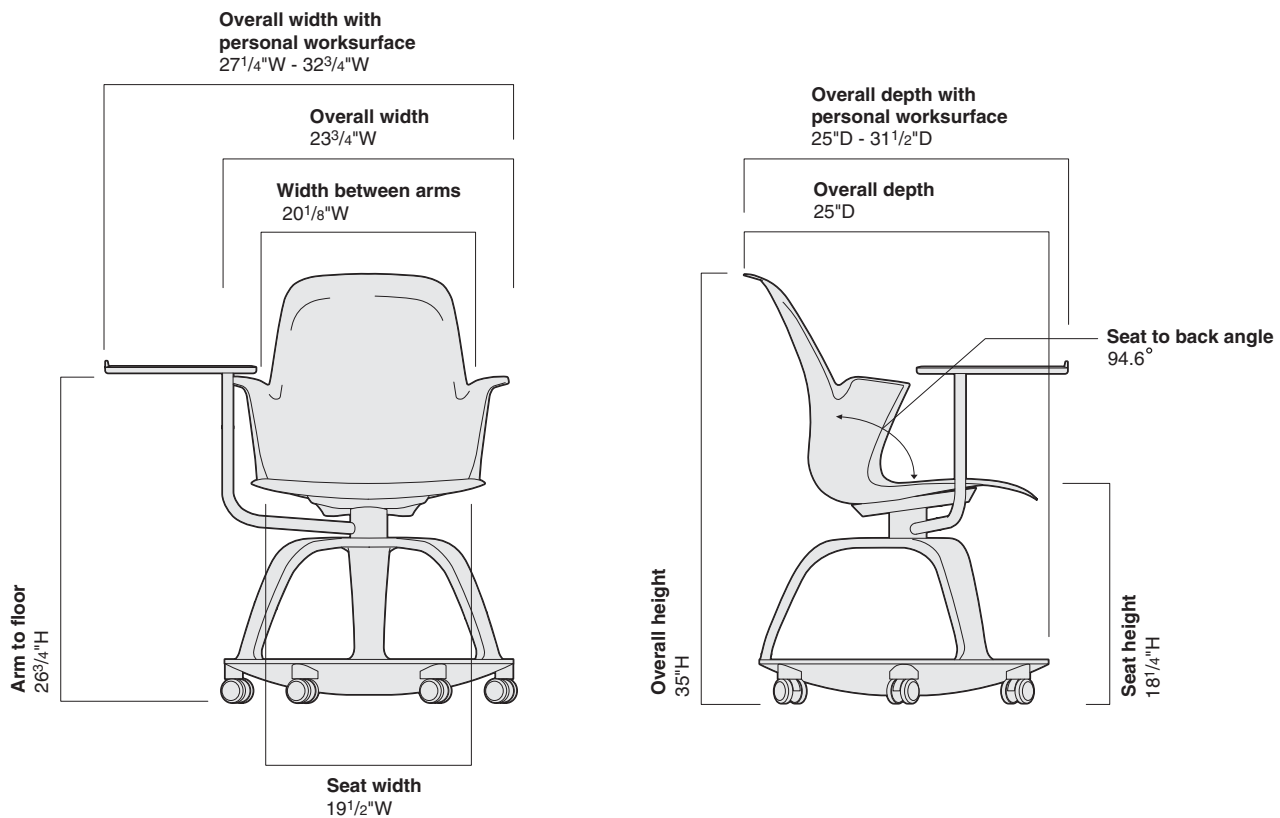

• **Angle Between Seat and Back** • **Worksurface Height from Floor** • **Worksurface Size** • **Worksurface Depth Adjustment**

Tripod Base Collaborative Chair

94.6° N.A. N.A. N.A.

Tripod Base Collaborative Chair with Personal Worksurface

94.6° 28 1/2" 22 1/4"W x 12"D 7 1/4" to 15"

Five-Arm Base Collaborative Chair

94.6° N.A. N.A. N.A.

Five-Arm Base Stool

94.6° N.A. N.A. N.A.

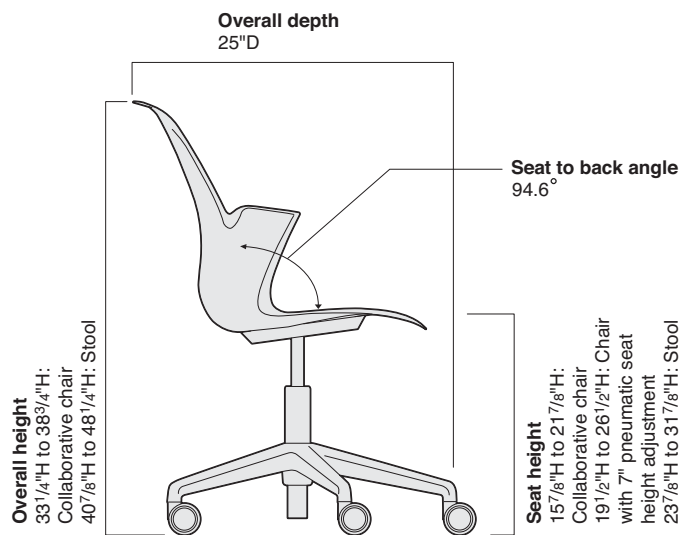
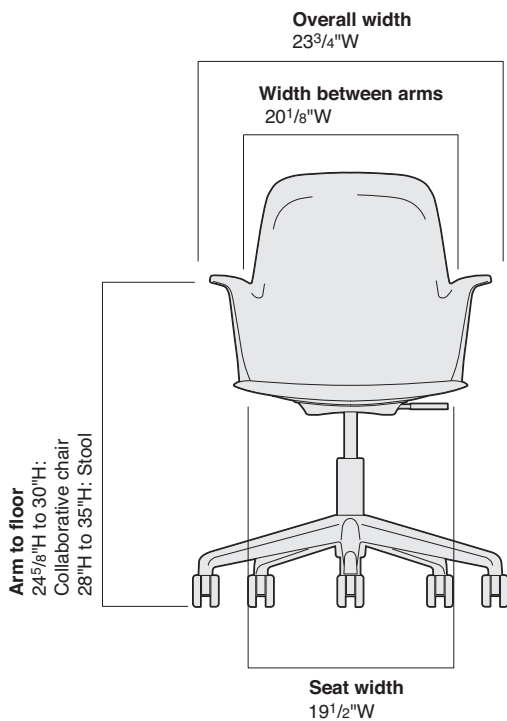

node 480 Series Collaborative Chairs

With Tripod Base

Standard Includes		Required to Specify
<ul style="list-style-type: none"> ▶ Need help? Product details, page 196 	<ul style="list-style-type: none"> • Seat shell: plastic • Tripod base: plastic • Storage tray: sterling dark solid • Metal components: 0835 Black paint • Swivel seat • Worksurface, if selected: plastic • Hard casters 	<ol style="list-style-type: none"> 1 Style number 2 Plastic color number for seat shell 3 Plastic color number for tripod base 4 Paint color number for metal components 5 Plastic color number for personal worksurface, if selected 6 Options, if selected (see below) <ul style="list-style-type: none"> ▶ See <i>Surface Materials</i>, page 264.

Options	U.S. Price	Required to Specify
Surface Materials <ul style="list-style-type: none"> • On 480110 • On 480120 • Fire Code Seating (FCS) 	Platinum or Champagne Metallic metal components <ul style="list-style-type: none"> +\$10 +\$21 +\$73 	Specify with 4799 Platinum or 4750 Champagne Metallic. Specify with 4799 Platinum or 4750 Champagne Metallic. Add suffix F to style number.
Cup Holder <ul style="list-style-type: none"> • On 480120 	+\$30	Specify with cup holder.
Casters <ul style="list-style-type: none"> • Soft casters 	+\$26	Specify with soft casters.
Glides <ul style="list-style-type: none"> • Glides: black plastic 	+\$21	Specify with glides.

Tip: Fire Code Seating (FCS) option is available with certain plastic color choices only.
▶ Pages 274-277

Tip: Cup holder is available on node models with personal worksurface only.

Specification Information

With personal worksurface			
• Style Number	• U.S. Base Price	• Style Number	• U.S. Base Price
480110	\$415	480120	\$623



▶ Detailed dimensions, page 198



For Canadian Pricing
Multiply U.S. Price by the Canadian price factor.
▶ See page 1 for details.

node 480 Series Collaborative Chair

With Five-Arm Base

node 480 Series
Collaborative Chair



Tip: Metal components will match plastic color for base.

Tip: Fire Code Seating (FCS) option is available with certain plastic color choices only.

► Pages 274-277

Standard Includes		Required to Specify
► Need help? Product details, page 196	<ul style="list-style-type: none"> • Seat shell: plastic • Five-arm base: plastic • Metal components: 0835 Black paint • Swivel seat • 6" pneumatic seat-height adjustment • Hard casters 	<ol style="list-style-type: none"> 1 Style number 2 Plastic color number for seat shell 3 Plastic color number for five-arm base 4 Options, if selected (see below) <p>► See <i>Surface Materials</i>, page 264.</p>

Options	U.S. Price	Required to Specify
Surface Materials	• Fire Code Seating (FCS) +\$73	Add suffix F to style number.
Base	• Platinum +\$30 • Element +\$30	Specify with <i>6249 Platinum</i> . Specify with <i>6337 Element</i> .
Casters	• Soft dual-wheel roll-control casters +\$21	Specify with <i>soft roll-control casters</i> .
Glides	• Glides: black plastic +\$21	Specify with <i>glides</i> .

Specification Information

• Style Number	• U.S. Base Price
480130	\$373
:	:

► Detailed dimensions,
page 198



For Canadian Pricing

Multiply U.S. Price by the Canadian price factor.

► See page 1 for details.

node 480 Series Collaborative Stool

With Five-Arm Base

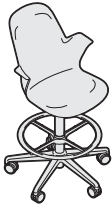

Tip: Metal components will match plastic color for base.

Tip: Fire Code Seating (FCS) option is available with certain plastic color choices only.

▶ Pages 274-277

Standard Includes		Required to Specify
▶ Need help? Product details, page 196	<ul style="list-style-type: none"> • Seat shell: plastic • Five-arm base: plastic • Metal components: 0835 Black paint • Swivel seat • 8" pneumatic seat-height adjustment • Hard casters 	<ul style="list-style-type: none"> 1 Style number 2 Plastic color number for seat shell 3 Plastic color number for five-arm base 4 Options, if selected (see below) <p>▶ See <i>Surface Materials</i>, page 264.</p>

Options	U.S. Price	Required to Specify
Surface Materials	• Fire Code Seating (FCS) +\$73	Add suffix F to style number.
Seat-Height	• 7" pneumatic seat-height adjustment No cost	Specify with <i>7" pneumatic seat-height adjustment</i> .
Base	• Platinum +\$90 • Element +\$90	Specify with <i>6249 Platinum</i> . Specify with <i>6337 Element</i> .
Casters	• Soft dual-wheel roll-control casters +\$21	Specify with <i>soft roll-control casters</i> .

Specification Information	
• Style Number	• U.S. Base Price
480140	\$550
:	:
:	:

▶ Detailed dimensions, page 198



For Canadian Pricing

Multiply U.S. Price by the Canadian price factor.

▶ See page 1 for details.

Understanding and Specifying Ally 463 Series Multi-Use Chairs

Product Details

Ally 463 Series	204
Dimensions	206

Specifying

Sled-Base Multi-Use Chairs	208
----------------------------	-----

Multi-Use Chairs

Multi-use chairs are suitable for use as occasional seating within team spaces, workstations, offices, or wherever extra seating is required.

- Ally 463 Series
- Player 475 Series
- Move 490 Series
- Snodgrass 474 Series

Ally 463 Series Sled-Base Multi-Use Chair

Ally is a multi-use chair with a flexing frame and pivoting back. The chair stacks and offers exceptional comfort for use in side/guest and team applications.

Arms slope downward and will easily clear the front edge of a worksurface or table. The arms are urethane covered.

Steel frame flexes to give added comfort and is available in monochromatic colors.

Plastic glides with a stainless steel insert are standard.

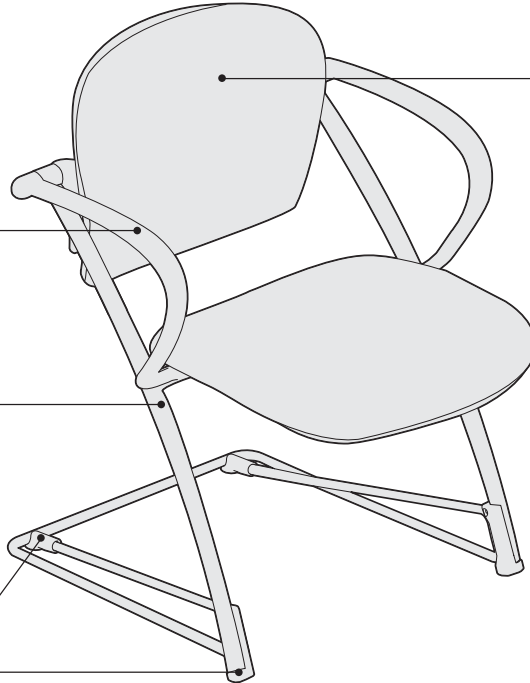

Back pivots for added comfort. Outer back is available in plastic or fully upholstered.

Product Details

Chairs with arms stack three high. Chairs without arms stack four high.

Plastic glides with stainless steel inserts are recommended for carpeted surfaces only.

Soft glides are available for non-carpeted surfaces.

Surface Materials

► See surface materials on page 264 for specific availability or refer to the *Surface Materials Reference Manual* for further information.

Upholstery

- Fabric
- Fabric with soil-retardant treatment (option)
- Leather
- Elmosoft leather
- Vinyl

Frame

- 6205 Black
 - 6296 Sterling
- Outer back, arms, and glides will be Black if you select a Black or Sterling frame.

Glides

- Stainless steel

All Steelcase seating with standard upholstery fabrics complies with requirements of the State of California Technical Bulletin 117. All standard seating is labeled to be in compliance with California 117.

Programs & Services

▶ See the *Surface Materials Reference Manual* for further detail about programs and services offered for seating.

The Customer's Own Material (COM) Program

offers the opportunity for customers to select fabrics that are not offered through the standard Steelcase surface materials program for use on Steelcase products. Through the COM program, Steelcase will test your materials for application on Steelcase products. Once approved, you can place your order. Steelcase will facilitate the entire ordering process and give you a production schedule. Steelcase will order the COM fabric directly from the textile manufacturer. For up-to-date information regarding fabric test results for all COM fabrics and details regarding yardage requirements for most Seating lines, visit the COM Web site. To locate the COM Web site:

- Visit www.steelcase.com

Soil retardants are treatments that provide long-term soil and stain resistance to a fabric without affecting the shade or the integrity of the fabric. The following Steelcase Textiles are available pre-treated with soil retardant. (You do not need to select the soil-retardant option for these fabrics and incur the upcharge.)

- Jacks
- Link
- Spyder

For information on soil retardant fabrics on Select Surfaces, please refer to the *Surface Materials Reference Manual*.

Soil-retardant treatment is available on all other seating fabrics at an additional upcharge per seating unit. To order this option, please select "Soil-Retardant Treatment" under "Optional Accessories."

For soil-retardant treatment on COMs, please select "Soil-Retardant Treatment" under "Optional Accessories." Minimums or additional yardage may be required. Please contact the vendor directly for specific information.

Extended lead times may be necessary for this service.

Contact your Steelcase Solutions Fulfillment Team Representative at 1.888.STEELCASE (1.888.783.3522) or send an email to lineone@steelcase.com.

Fire Codes

▶ See pages 270–271 for upholstery fabrics available for use with FCS modification.

Steelcase offers Fire Code Seating modification (FCS) on nearly all seating models. The most rigorous fire codes in the nation have been developed in California, and the Steelcase FCS modification is designed to meet those codes. Fire Code Seating (FCS) indicates that a product is constructed to meet the strict fire code requirements of high public occupancy areas such as theaters, meeting rooms, and lobbies. The FCS standards will meet both the State of California Home Furnishing Technical Bulletin 133 (Cal TB 133) and Boston Fire Code (BFC). Boston adopted the California Home Furnishing Technical Bulletin TB 133 test standard in 1992.

Local codes may have special requirements for upholstery.

Dimensions

▶ Page 206

Resources

Printed Materials

▶ Ally Brochure (S11024)

Dimensions

Ally 463 Series

Overall Depth	Width	Height	Seat Depth	Functional Seat Depth	Seat Width	Seat Height from Floor	Width Between Arms
Ally 463 Series							
Chair with Arms							
24½"	23¾"	33¾"	20"	17¼"	18⅛"	17¾"	20½"
Chair without Arms							
24½"	21⅛"	33¾"	20"	17¼"	18⅛"	17¾"	20½"

• Back Height from Seat	• Arm Height from Seat	• Arm Height from Floor	• Seat Pan Angle	• Back Width	• Back Lumbar Height	• Angle Between Seat and Back
-------------------------	------------------------	-------------------------	------------------	--------------	----------------------	-------------------------------

Chair with Arms

17½"	9½"	26⅝"	3°	18½"	9" to 9¼"	96°
------	-----	------	----	------	-----------	-----

Chair without Arms

17½"	9½"	26⅝"	3°	18½"	9" to 9¼"	96°
------	-----	------	----	------	-----------	-----

Ally 463 Series Sled-Base Multi-Use Chairs

Standard Includes		Required to Specify
<ul style="list-style-type: none"> ▶ Need help? Product details, page 204 	<ul style="list-style-type: none"> Flexing frame: monochromatic color Pivoting back Upholstery: fabric price group 1 Arms and glides: 6205 Black arms and glides for 6205 Black and 6296 Sterling frames 	<ol style="list-style-type: none"> 1 Style number 2 Monochromatic color for frame 3 Fabric color number for upholstery 4 Options, if selected (see below) <ul style="list-style-type: none"> ▶ See <i>Surface Materials</i>, page 264.

Options	U.S. Price	Required to Specify	
Surface Materials	Upholstery <ul style="list-style-type: none"> Fabric price group 1 Fabric price group 2 Fabric price group 3 Fabric price group 4 Fabric price group 5 Fabric price group 6 Fabric price group 7 Fabric price group 8 Fabric price group 9 Fabric price group 10 Customer's Own Material (COM) Steelcase leather upholstery Elmosoft leather upholstery Customer's Own Leather (COL) Steelcase vinyl Fire Code Seating (FCS) Soil-retardant treatment applied to upholstery fabric 	<ul style="list-style-type: none"> No cost +\$ 22 +\$ 43 +\$ 59 +\$ 75 +\$107 +\$150 +\$199 +\$236 +\$274 +\$ 32 +\$373 +\$431 +\$127 +\$127 +\$ 51 +\$ 21 	<ul style="list-style-type: none"> Specify fabric color number. Specify fabric color number. Specify fabric color number. Specify fabric color number. Specify fabric color number. Specify fabric color number. Specify fabric color number. Specify fabric color number. Specify fabric color number. Specify fabric color number. ▶ See <i>Surface Materials Reference Manual</i> to specify. Add suffix S to the style number and specify leather color number. Add suffix S to the style number and specify Elmosoft leather color number. Add suffix S to the style number and specify leather color number. ▶ See <i>Surface Materials Reference Manual</i> to specify. Add suffix S to the style number and specify vinyl color number. Add suffix F to the style number. Specify with soil-retardant treatment.
	Fully upholstered <ul style="list-style-type: none"> Fabric fully upholstered outer back Steelcase leather fully upholstered outer back Elmosoft leather fully upholstered outer back Customer's Own Leather (COL) fully upholstered outer back 	<ul style="list-style-type: none"> +\$ 51 +\$484 +\$560 +\$178 	<ul style="list-style-type: none"> Add suffix U to the style number. Add suffix SU to the style number and specify leather color number. Add suffix SU to the style number and specify Elmosoft leather color number. Add suffix SU to the style number. ▶ See <i>Surface Materials Reference Manual</i> to specify.
Glides	<ul style="list-style-type: none"> Soft glides for use on non-carpeted floors 	<ul style="list-style-type: none"> +\$ 10 	<ul style="list-style-type: none"> Specify with <i>soft glides</i>.

Tip: Always add suffixes in alphabetical order when specifying options to Ally seating.

Tip: Vinyl is available in a non-sewn version. Specify without the **S** suffix.

Tip: Fire Code Seating (FCS) option is available with certain upholstery fabric choices only.
▶ Pages 270–271

Specification Information

With Arms



Without Arms



▶ Detailed dimensions, page 206

Style Number	U.S. Base Price	Style Number	U.S. Base Price
463482 	\$563	463480 	\$480



For Canadian Pricing
Multiply U.S. Price by the Canadian price factor.
▶ See page 1 for details.

 = Transitional product

Understanding and Specifying Player 475 Series Multi-Use Chairs

Product Details

Player 475 Series	210
Dimensions	212

Specifying

Leg-Base Multi-Use Chairs	214
Sled-Base Multi-Use Chairs	217
Leg-Base Stools	219
Accessories	220

Multi-Use Chairs

Multi-use chairs are suitable for use as occasional seating within team spaces, workstations, offices, or wherever extra seating is required.

- Ally 463 Series
- Player 475 Series
- Move 490 Series
- Snodgrass 474 Series

Player 475 Series

Player chairs are guest chairs that also stack. Strength features in the back, arms, and back legs make Player a logical choice for high-traffic areas, and its simple, classic design complements a broad range of work settings.

Back and seat, including outer back, are fully upholstered. High-back and thick-seat options are available.

Arms slope downward and will easily clear the front edge of a worksurface or table. Arms are available in smooth or textured finish.

Steel frame is monochromatic.

Plastic glides with a stainless steel insert are standard.

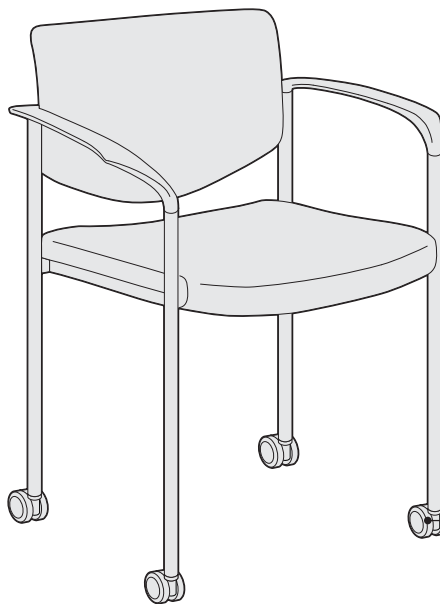
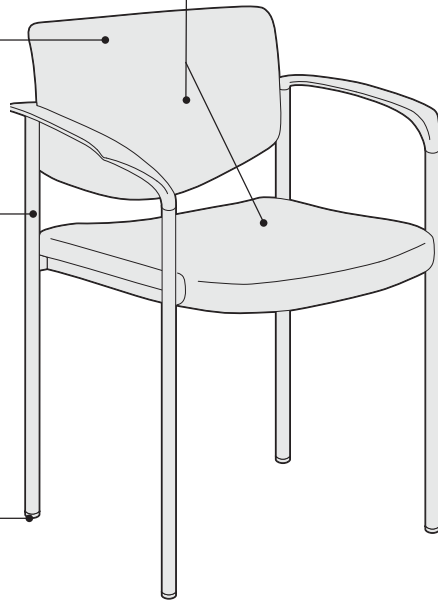

Casters have hard, dual wheels that roll smoothly on carpets. Soft, dual-wheel casters are available for use on hard floor or chair mats. Casters available in black only.

Product Details



Chair models are available with a leg-base or a sled-base. Stools are available with a leg-base. The leg base arms are available with casters. Chairs and stools are available with several features such as arms, tablet arms, high back, and thick seat.

Stackability for leg-base models is six high on the floor and eight high on the transport and storage dolly. Leg-base models with casters are not recommended to stack as damage to arms may occur. Sled-base models, stools, and chairs with tablet arms will not stack.

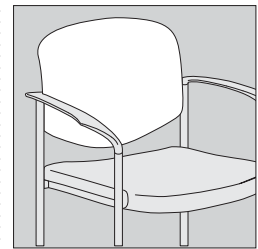

High-back option, available on all Player chairs and stools, adds 2½" to back height. Top edge is slightly rounded. Stackability is not affected.

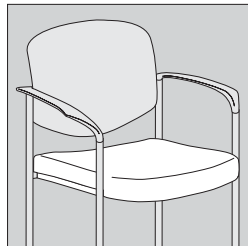

Thick-seat option, available on all Player chairs and stools, increases the thickness of the seat cushion by approximately 1/2". Stackability is not affected.

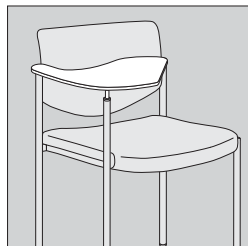

Tablet arm is available right hand and left hand and is shipped knocked down (K.D.). Tablet arm tilts for easy entrance and exit from chair. Tablet arm measures 25 1/2" x 13 1/2". Tablet arm is not available to order separately for installation on existing chairs.

Plastic glides, with stainless steel inserts on leg-base Player chairs, are recommended for carpeted surfaces only.

Soft glides are available on Player chairs for non-carpeted surfaces.

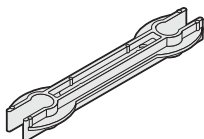

Alignment device is available to temporarily link chairs together for evenly spaced rows. Chairs can be unlinked easily. Spacing between chairs linked with alignment device is 5/8".

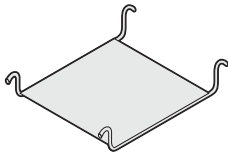

Ganging device is available to link chairs on a more permanent basis. It attaches to the chair's side frame. Spacing between chairs linked with the ganging device is approximately 9".

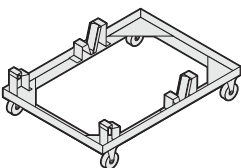

Transport and storage dolly is available to stack, move, and store up to eight chairs with or without arms. Without the dolly, chairs will stack up to six high. Sled-base models, stools, and chairs with tablet arms will not stack.

Fully loaded transport dolly measures 32 3/4"D x 25 1/2"W x 55 3/4"H.

Surface Materials

▶ See surface materials on page 264 for specific availability or refer to the *Surface Materials Reference Manual* for further information.

Upholstery

- Fabric
- Fabric with soil-retardant treatment (option)
- Vinyl

Hard components (arms, frames, and sled base)

- Monochromatic color from list of seating plastic color numbers can be applied to all hard components.

Arms

- Smooth plastic
- Textured plastic

Tablet arms

- Laminate

Casters

- Black only

Glides

- Plastic with stainless steel inserts

All Steelcase seating with standard upholstery fabrics complies with requirements of the State of California Technical Bulletin 117. All standard seating is labeled to be in compliance with California 117.

Programs & Services

▶ See the *Surface Materials Reference Manual* for further detail about programs and services offered for seating.

The Customer's Own Material (COM)

Steelcase offers the opportunity for customers to select fabrics that are not offered through the standard Steelcase surface materials program for use on Steelcase products. Through the COM program, Steelcase will test your materials for application on Steelcase products. Once approved, you can place your order. Steelcase will facilitate the entire ordering process and give you a production schedule. Steelcase will order the COM fabric directly from the textile manufacturer. For up-to-date information regarding fabric test results for all COM fabrics and details regarding yardage requirements for most Seating lines, visit the COM Web site. To locate the COM Web site:

- Visit www.steelcase.com

Soil retardants are treatments that provide long-term soil and stain resistance to a fabric without affecting the shade or the integrity of the fabric. The following Steelcase Textiles are available pre-treated with soil retardant. (You do not need to select the soil-retardant option for these fabrics and incur the upcharge.)

- Jacks
- Link
- Spyder

For information on soil retardant fabrics on Select Surfaces, please refer to the *Surface Materials Reference Manual*.

Soil-retardant treatment is available on all other seating fabrics at an additional upcharge per seating unit. To order this option, please select "Soil-Retardant Treatment" under "Optional Accessories."

For soil-retardant treatment on COMs, please select "Soil-Retardant Treatment" under "Optional Accessories." Minimums or additional yardage may be required. Please contact the vendor directly for specific information.

Extended lead times may be necessary for this service.

Contact your Steelcase Solutions Fulfillment Team Representative at 1.888.STEELCASE (1.888.783.3522) or send an email to lineone@steelcase.com.

Fire Codes

▶ See pages 270–271 for upholstery fabrics available for use with FCS modification.

Steelcase offers Fire Code Seating modification (FCS) on nearly all seating models. The most rigorous fire codes in the nation have been developed in California, and the Steelcase FCS modification is designed to meet those codes. Fire Code Seating (FCS) indicates that a product is constructed to meet the strict fire code requirements of high public occupancy areas such as theaters, meeting rooms, and lobbies. The FCS standards will meet both the State of California Home Furnishing Technical Bulletin 133 (Cal TB 133) and Boston Fire Code (BFC). Boston adopted the California Home Furnishing Technical Bulletin TB 133 test standard in 1992.

Local codes may have special requirements for upholstery.

Dimensions

▶ Page 212

Resources

Printed Materials

▶ Player Brochure (S11349)

Dimensions

Player 475 Series

Features	Overall Depth	Width	Height	Seat Depth	Functional Seat Depth	Seat Width	Seat Height from Floor	Back Width	Back Height from Seat
Player 475 Series									
Leg-Base Chair with Arms									
	21¼"	25½"	30¼"	19¾"	17½"	18¼"	18¼"	18½"	13¾"
Leg-Base Chair without Arms									
	21¼"	20"	30¼"	19¾"	17½"	18¼"	18¼"	18½"	13¾"
Sled-Base Chair with Arms									
	21¼"	25½"	30¼"	19¾"	17½"	18¼"	18"	18½"	13¾"
Sled-Base Chair without Arms									
	21¼"	20"	30¼"	19¾"	17½"	18¼"	18"	18½"	13¾"
Leg-Base Stool with Arms									
	21¼"	25½"	42"	19¾"	17½"	18¼"	29½"	18½"	13¾"
Leg-Base Stool without Arms									
	21¼"	20"	42"	19¾"	17½"	18¼"	29½"	18½"	13¾"

• Back • Lumbar • Height	• Width • Between • Arms	• Arm • to • Floor	• Arm • Height • from • Seat	• Seat • Pan • Angle	• Angle • Between • Seat and • Back
--------------------------------	--------------------------------	--------------------------	---------------------------------------	----------------------------	--

Leg-Base Chair with Arms

7¼"	20½"	25¼"	8¾"	4°	95°
-----	------	------	-----	----	-----

Leg-Base Chair without Arms

7¼"	N.A.	N.A.	N.A.	4°	95°
-----	------	------	------	----	-----

Sled-Base Chair with Arms

7¼"	20½"	25¼"	8¾"	4°	95°
-----	------	------	-----	----	-----

Sled-Base Chair without Arms

7¼"	N.A.	N.A.	N.A.	4°	95°
-----	------	------	------	----	-----

Leg-Base Stool with Arms

7¼"	20½"	36½"	8¾"	4°	95°
-----	------	------	-----	----	-----

Leg-Base Stool without Arms

7¼"	N.A.	N.A.	N.A.	4°	95°
-----	------	------	------	----	-----

Player 475 Series Leg-Base Multi-Use Chairs

With Open Arms or without Arms



Tip: Color choices are limited for chairs with textured plastic arms.

▶ Page 272

Tip: Fire Code Seating (FCS) option is available with certain upholstery fabric choices only.

▶ Pages 270–271

Standard Includes		Required to Specify
▶ Need help? Product details, page 210	<ul style="list-style-type: none"> • Frame: monochromatic color • Arms, if selected: plastic color to match frame color • Upholstery: fabric price group 1 • Glides, if selected: plastic with stainless steel inserts • Hard composition, dual-wheel casters, if selected; black 	<ol style="list-style-type: none"> 1 Style number 2 Monochromatic color number from seating plastic colors for frame 3 Fabric color number for upholstery 4 Options, if selected (see below) <p>▶ See <i>Surface Materials</i>, page 264.</p>

Options	U.S. Price	Required to Specify
Surface Materials <ul style="list-style-type: none"> • Fabric price group 1 • Fabric price group 2 • Fabric price group 3 • Fabric price group 4 • Fabric price group 5 • Fabric price group 6 • Fabric price group 7 • Fabric price group 8 • Fabric price group 9 • Fabric price group 10 • Customer's Own Material (COM) • Customer's Own Vinyl (COV) 	<ul style="list-style-type: none"> No cost +\$ 22 +\$ 43 +\$ 59 +\$ 75 +\$107 +\$150 +\$199 +\$236 +\$274 +\$ 32 +\$ 32 	<ul style="list-style-type: none"> Specify fabric color number. Specify fabric color number. Specify fabric color number. Specify fabric color number. Specify fabric color number. Specify fabric color number. Specify fabric color number. Specify fabric color number. Specify fabric color number. Specify fabric color number. <p>▶ See <i>Surface Materials Reference Manual</i> to specify.</p> <p>▶ See <i>Surface Materials Reference Manual</i> to specify.</p> <p>Add suffix F to the style number.</p> <p>Specify with <i>soil-retardant treatment</i>.</p>
Upholstery <ul style="list-style-type: none"> • Fire Code Seating (FCS) • Soil-retardant treatment applied to upholstery fabric 	<ul style="list-style-type: none"> +\$ 64 +\$ 21 	
Platinum <ul style="list-style-type: none"> • Platinum frame 	<ul style="list-style-type: none"> +\$ 52 	<ul style="list-style-type: none"> Specify with <i>6249 Platinum</i>.
Back and Seat <ul style="list-style-type: none"> • High back • Thick seat • High back and thick seat 	<ul style="list-style-type: none"> +\$ 33 +\$ 33 +\$ 66 	<ul style="list-style-type: none"> Specify with <i>high back</i>. Specify with <i>thick seat</i>. Specify with <i>high back and thick seat</i>.
Glides <ul style="list-style-type: none"> • Soft glides for use on non-carpeted floors 	<ul style="list-style-type: none"> +\$ 6 	<ul style="list-style-type: none"> Specify with <i>soft glides</i>.
Casters <ul style="list-style-type: none"> • Soft, dual-wheel casters for use on hard floors 	<ul style="list-style-type: none"> +\$ 21 	<ul style="list-style-type: none"> Specify with <i>soft casters</i>.

▶ Detailed dimensions, page 212



For Canadian Pricing

Multiply U.S. Price by the Canadian price factor.

▶ See page 1 for details.

Specification Information

• Style Number	• U.S. Base Price
-----------------------	--------------------------

Smooth Plastic Arms

With Glides

475412M	\$356
----------------	-------

With Casters

475412MC	\$403
-----------------	-------

Textured Plastic Arms

With Glides

475415M 	\$356
--	-------

With Casters

475415MC 	\$403
---	-------

Without Arms

With Glides

475410M	\$326
----------------	-------



Player 475 Series

 **For Canadian Pricing**
Multiply U.S. Price by the Canadian price factor.
▶ See page 1 for details.

 = Transitional product

Player 475 Series Leg-Base Multi-Use Chairs

With Tablet Arm

Standard Includes		Required to Specify
<ul style="list-style-type: none"> ▶ Need help? Product details, page 210 	<ul style="list-style-type: none"> • Frame: monochromatic color • Tablet arm: laminate • Upholstery: fabric price group 1 • Glides: plastic with stainless steel inserts 	<ol style="list-style-type: none"> 1 Style number 2 Monochromatic color number from seating plastic colors for frame 3 Fabric color number for upholstery 4 Laminate color number for tablet arm 5 Options, if selected (see below) <ul style="list-style-type: none"> ▶ See <i>Surface Materials</i>, page 264.

Options	U.S. Price	Required to Specify
Surface Materials	Upholstery	
	<ul style="list-style-type: none"> • Fabric price group 1 No cost • Fabric price group 2 +\$ 22 • Fabric price group 3 +\$ 43 • Fabric price group 4 +\$ 59 • Fabric price group 5 +\$ 75 • Fabric price group 6 +\$107 • Fabric price group 7 +\$150 • Fabric price group 8 +\$199 • Fabric price group 9 +\$236 • Fabric price group 10 +\$274 • Customer's Own Material (COM) +\$ 32 • Customer's Own Vinyl (COV) +\$ 32 	<ul style="list-style-type: none"> Specify fabric color number. Specify fabric color number. Specify fabric color number. Specify fabric color number. Specify fabric color number. Specify fabric color number. Specify fabric color number. Specify fabric color number. Specify fabric color number. Specify fabric color number.
	<ul style="list-style-type: none"> • Fire Code Seating (FCS) +\$ 64 • Soil-retardant treatment applied to upholstery fabric +\$ 21 	<ul style="list-style-type: none"> ▶ See <i>Surface Materials Reference Manual</i> to specify. ▶ See <i>Surface Materials Reference Manual</i> to specify. Add suffix F to the style number. Specify <i>with soil-retardant treatment</i>.
	Platinum	
	<ul style="list-style-type: none"> • Platinum frame +\$ 52 	<ul style="list-style-type: none"> Specify <i>with 6249 Platinum</i>.
Back and Seat	<ul style="list-style-type: none"> • High back +\$ 33 • Thick seat +\$ 33 • High back and thick seat +\$ 66 	<ul style="list-style-type: none"> Specify <i>with high back</i>. Specify <i>with thick seat</i>. Specify <i>with high back and thick seat</i>.
Glides	<ul style="list-style-type: none"> • Soft glides for use on non-carpeted floors +\$ 6 	<ul style="list-style-type: none"> Specify <i>with soft glides</i>.

Tip: Fire Code Seating (FCS) option is available with certain upholstery fabric choices only.
▶ Pages 270–271

Specification Information	
• Style Number	• U.S. Base Price
.....

Right-Hand Tablet Arm

475410MTR \$508



Left-Hand Tablet Arm

475410MTL \$508



▶ Detailed dimensions, page 212

Player 475 Series Sled-Base Multi-Use Chairs

With Open Arms or without Arms

Player 475 Series
Sled-Base Multi-Use Chairs

Tip: Color choices are limited for chairs with textured plastic arms.
▶ Page 272

Standard Includes	Required to Specify
<ul style="list-style-type: none"> ▶ Need help? Product details, page 210 • Frame: monochromatic color • Arms, if selected: plastic color to match frame color • Upholstery: fabric price group 1 • Glides: plastic with stainless steel inserts 	<ol style="list-style-type: none"> 1 Style number 2 Monochromatic color number from seating plastic colors for frame 3 Fabric color number for upholstery 4 Options, if selected (see below) <p>▶ See <i>Surface Materials</i>, page 264.</p>

Tip: Fire Code Seating (FCS) option is available with certain upholstery fabric choices only.
▶ Pages 270–271

Tip: Platinum is not available on smooth plastic arm model.

▶ Detailed dimensions, page 212



Options	U.S. Price	Required to Specify
Surface Materials	Upholstery <ul style="list-style-type: none"> • Fabric price group 1: No cost • Fabric price group 2: +\$ 22 • Fabric price group 3: +\$ 43 • Fabric price group 4: +\$ 59 • Fabric price group 5: +\$ 75 • Fabric price group 6: +\$107 • Fabric price group 7: +\$150 • Fabric price group 8: +\$199 • Fabric price group 9: +\$236 • Fabric price group 10: +\$274 • Customer's Own Material (COM): +\$ 32 • Customer's Own Vinyl (COV): +\$ 32 	<ul style="list-style-type: none"> Specify fabric color number. Specify fabric color number. Specify fabric color number. Specify fabric color number. Specify fabric color number. Specify fabric color number. Specify fabric color number. Specify fabric color number. Specify fabric color number. Specify fabric color number. <p>▶ See <i>Surface Materials Reference Manual</i> to specify.</p> <p>▶ See <i>Surface Materials Reference Manual</i> to specify.</p> <p>Add suffix F to the style number.</p> <p>Specify with <i>soil-retardant treatment</i>.</p>
	Platinum <ul style="list-style-type: none"> • Platinum frame: +\$ 52 	<ul style="list-style-type: none"> Specify with <i>6249 Platinum</i>.
Back and Seat	<ul style="list-style-type: none"> • High back: +\$ 33 • Thick seat: +\$ 33 • High back and thick seat: +\$ 66 	<ul style="list-style-type: none"> Specify with <i>high back</i>. Specify with <i>thick seat</i>. Specify with <i>high back and thick seat</i>.
Glides	<ul style="list-style-type: none"> • Soft glides for use on non-carpeted floors: +\$ 6 	<ul style="list-style-type: none"> Specify with <i>soft glides</i>.

Specification Information

Style Number	U.S. Base Price
--------------	-----------------

Smooth Plastic Arms

475482M \$460

Textured Plastic Arms

475485M  \$460

Without Arms

475480M \$430

 = Transitional product

Player 475 Series Sled-Base Multi-Use Chairs

With Tablet Arm

Standard Includes		Required to Specify
<ul style="list-style-type: none"> ▶ Need help? Product details, page 210 	<ul style="list-style-type: none"> • Frame: monochromatic color • Tablet arm: laminate • Upholstery: fabric price group 1 • Glides: stainless steel 	<ol style="list-style-type: none"> 1 Style number 2 Monochromatic color number from seating plastic colors for frame 3 Fabric color number for upholstery 4 Laminate color number for tablet arm 5 Options, if selected (see below) <ul style="list-style-type: none"> ▶ See <i>Surface Materials</i>, page 264.

Options	U.S. Price	Required to Specify
Surface Materials Upholstery <ul style="list-style-type: none"> • Fabric price group 1 • Fabric price group 2 • Fabric price group 3 • Fabric price group 4 • Fabric price group 5 • Fabric price group 6 • Fabric price group 7 • Fabric price group 8 • Fabric price group 9 • Fabric price group 10 • Customer's Own Material (COM) • Customer's Own Vinyl (COV) 	No cost +\$ 22 +\$ 43 +\$ 59 +\$ 75 +\$107 +\$150 +\$199 +\$236 +\$274 +\$ 32 +\$ 32	Specify fabric color number. Specify fabric color number. Specify fabric color number. Specify fabric color number. Specify fabric color number. Specify fabric color number. Specify fabric color number. Specify fabric color number. Specify fabric color number. Specify fabric color number. Specify fabric color number. ▶ See <i>Surface Materials Reference Manual</i> to specify. ▶ See <i>Surface Materials Reference Manual</i> to specify. Add suffix F to the style number. Specify with <i>soil-retardant treatment</i> .
Platinum <ul style="list-style-type: none"> • Platinum frame 	+\$ 64 +\$ 21 +\$ 52	Specify with <i>6249 Platinum</i> .
Back and Seat <ul style="list-style-type: none"> • High back • Thick seat • High back and thick seat 	+\$ 33 +\$ 33 +\$ 66	Specify with <i>high back</i> . Specify with <i>thick seat</i> . Specify with <i>high back and thick seat</i> .
Glides <ul style="list-style-type: none"> • Soft glides for use on non-carpeted floors 	+\$ 6	Specify with <i>soft glides</i> .

Tip: Fire Code Seating (FCS) option is available with certain upholstery fabric choices only.
 ▶ Pages 270–271

Specification Information	
Style Number	U.S. Base Price



Right-Hand Tablet Arm

475480MTR \$612



Left-Hand Tablet Arm

475480MTL \$612

▶ Detailed dimensions, page 212

Player 475 Series Leg-Base Stools

Player 475 Series
Leg-Base Stools

Tip: Color choices are limited for chairs with textured plastic arms.
▶ Page 272

Tip: Fire Code Seating (FCS) option is available with certain upholstery fabric choices only.
▶ Pages 270–271



▶ Detailed dimensions, page 212

Standard Includes	Required to Specify
<ul style="list-style-type: none"> ▶ Need help? Product details, page 210 • Frame: monochromatic color • Arms, if selected: plastic color to match frame color • Upholstery: fabric price group 1 • Glides: plastic with stainless steel inserts 	<ol style="list-style-type: none"> 1 Style number 2 Monochromatic color number from seating plastic colors for frame 3 Fabric color number for upholstery 4 Options, if selected (see below) <p>▶ See <i>Surface Materials</i>, page 264.</p>

Options	U.S. Price	Required to Specify
Surface Materials	Upholstery <ul style="list-style-type: none"> • Fabric price group 1: No cost • Fabric price group 2: +\$ 22 • Fabric price group 3: +\$ 43 • Fabric price group 4: +\$ 59 • Fabric price group 5: +\$ 75 • Fabric price group 6: +\$107 • Fabric price group 7: +\$150 • Fabric price group 8: +\$199 • Fabric price group 9: +\$236 • Fabric price group 10: +\$274 • Customer's Own Material (COM): +\$ 32 • Customer's Own Vinyl (COV): +\$ 32 • Fire Code Seating (FCS): +\$ 64 • Soil-retardant treatment applied to upholstery fabric: +\$ 21 Platinum <ul style="list-style-type: none"> • Platinum frame: +\$ 52 	<ul style="list-style-type: none"> Specify fabric color number. Specify fabric color number. Specify fabric color number. Specify fabric color number. Specify fabric color number. Specify fabric color number. Specify fabric color number. Specify fabric color number. Specify fabric color number. ▶ See <i>Surface Materials Reference Manual</i> to specify. ▶ See <i>Surface Materials Reference Manual</i> to specify. Add suffix F to the style number. Specify with <i>soil-retardant treatment</i>. <hr/> <ul style="list-style-type: none"> Specify with <i>6249 Platinum</i>.
Back and Seat <ul style="list-style-type: none"> • High back: +\$ 33 • Thick seat: +\$ 33 • High back and thick seat: +\$ 66 		<ul style="list-style-type: none"> Specify with <i>high back</i>. Specify with <i>thick seat</i>. Specify with <i>high back and thick seat</i>.
Glides <ul style="list-style-type: none"> • Soft glides for use on non-carpeted floors: +\$ 6 		<ul style="list-style-type: none"> Specify with <i>soft glides</i>.

Specification Information

Style Number	U.S. Base Price
--------------	-----------------

Smooth Plastic Arms

475712M \$613

Textured Plastic Arms

475715M  \$613

Without Arms

475710M \$583

 = Transitional product

Player 475 Series Accessories

Alignment Device

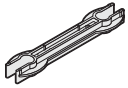

Tip: One pair is required to align two chairs.

Standard Includes

- Alignment device: black paint only
- Package of 5 pairs

Required to Specify

Style number

Specification Information

• Style Number	• U.S. Price
475A	\$69
•	•

Ganging Device

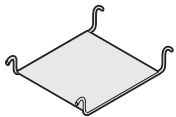

Tip: Use one ganging device for every two chairs.

Standard Includes

- Ganging device: black paint only
- Package of 2

Required to Specify

Style number

Specification Information

• Style Number	• U.S. Price
475G	\$86
•	•

Transport and Storage Dolly

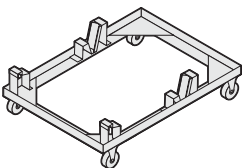

Standard Includes

- Transport and storage dolly: black paint only

Required to Specify

Style number

Specification Information

• Style Number	• U.S. Price
475D	\$285
•	•



For Canadian Pricing

Multiply U.S. Price by the Canadian price factor.

▶ See page 1 for details.

Understanding and Specifying Move 490 Series Multi-Use Chairs

Product Details

Move 490 Series	222
Dimensions	224

Specifying

Value Package Multi-Use Chairs and Stools	226
Multi-Use Chairs	228
Multi-Use Stools	232
Accessories	235

Multi-Use Chairs

Multi-use chairs are suitable for use as occasional seating within team spaces, workstations, offices, or wherever extra seating is required.

- Ally 463 Series
- Player 475 Series
- Move 490 Series
- Snodgrass 474 Series

Move 490 Series

Move chairs are guest chairs that also stack. Live dynamic seat, open cantilever arm design, light weight, and strength make Move a logical choice for multipurpose areas. Move's simple design complements a broad range of work settings.

Arms are cantilevered and will easily clear the front edge of a worksurface or table. The open cantilever design of the arms allows alternative postures and sitting positions.

Steel frame is monochromatic.

Upholstered back is available on selected styles.

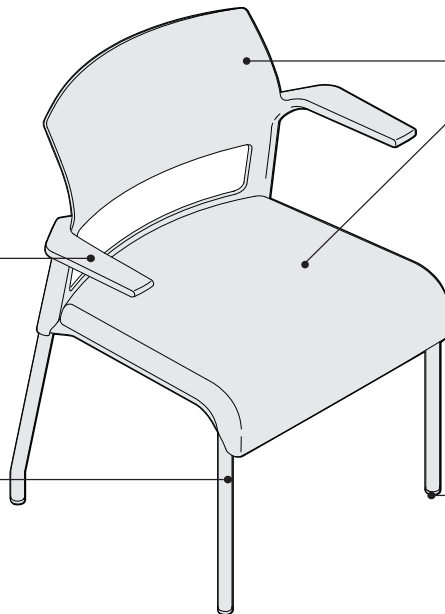

Seat and back are available in plastic or with an upholstered cushion.

Plastic glides have a stainless steel insert.

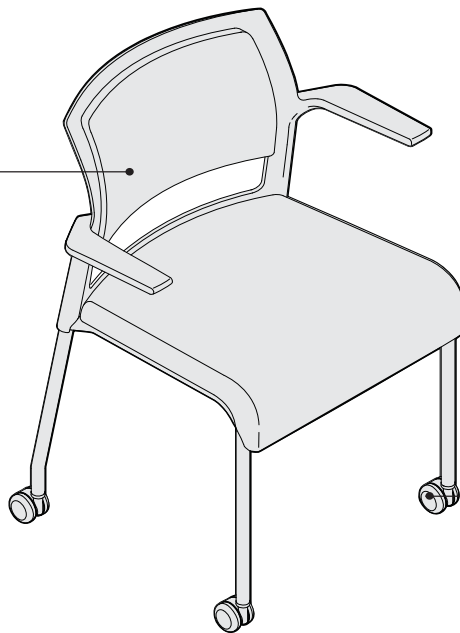

Casters have hard, dual wheels that roll smoothly on carpets. Soft, dual-wheel casters are available for use on hard floor or chair mats. Casters are available in black only.

Product Details

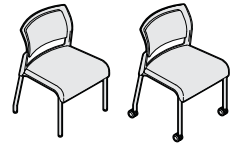
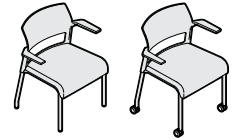

Chairs and stools have a leg-base and are available with glides or casters, and with or without arms.

Stackability for leg base chair models is five high on the floor. Stools do not stack.

Plastic glides with stainless steel inserts are recommended for carpeted surfaces.

Soft glides for use on non-carpeted surfaces are available as an option.



Transport and storage dolly is available to stack, move, and store up to 10 chairs.

Unloaded transport dolly measures 58½"D x 25½"W x 37½"H.

Fully loaded transport dolly measures 58½"D x 25½"W x 58½"H.

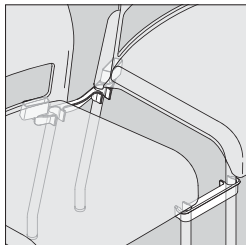

Ganging and alignment device is available to link leg-base chairs together in the field for evenly spaced rows. Chairs can be separated easily. Spacing between chairs linked with alignment device is 4" for chairs with no arms and 7" for chairs with arms.

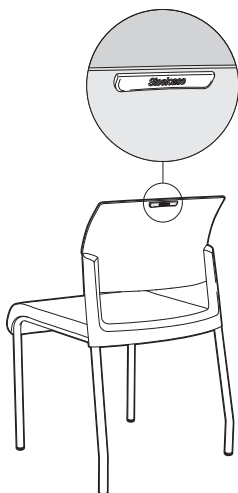

Wall saver bumper is available to protect the back of the chair from bumping into and marring a wall.

Surface Materials

▶ See surface materials on page 264 for specific availability or refer to the *Surface Materials Reference Manual* for further information.

Upholstery

- Fabric
- Fabric with soil retardant treatment (option)
- Leather
- Elmosoft leather
- Vinyl

Frame

- 0835 Black paint
- 4799 Platinum paint
- 7239 Midnight

Seat

- Plastic
- Upholstery

Back shell and arms

- Plastic

Casters

- Black only

Glides

- Plastic with stainless steel inserts

All Steelcase seating with standard upholstery fabrics complies with requirements of the State of California Technical Bulletin 117. All standard seating is labeled to be in compliance with California 117.

Programs & Services

▶ See the *Surface Materials Reference Manual* for further detail about programs and services offered for seating.

The Customer's Own Material (COM)

Program offers the opportunity for customers to select fabrics that are not offered through the standard Steelcase surface materials program for use on Steelcase products. Through the COM program, Steelcase will test your materials for application on Steelcase products. Once approved, you can place your order. Steelcase will facilitate the entire ordering process and give you a production schedule. Steelcase will order the COM fabric directly from the textile manufacturer. For up-to-date information regarding fabric test results for all COM fabrics and details regarding yardage requirements for most Seating lines, visit the COM Web site. To locate the COM Web site:

- Visit www.steelcase.com

Soil retardants are treatments that provide long-term soil and stain resistance to a fabric without affecting the shade or the integrity of the fabric. The following Steelcase Textiles are available pre-treated with soil retardant. (You do not need to select the soil-retardant option for these fabrics and incur the upcharge.)

- Jacks
- Link
- Spyder

For information on soil retardant fabrics on Select Surfaces, please refer to the *Surface Materials Reference Manual*.

Soil-retardant treatment is available on all other seating fabrics at an additional upcharge per seating unit. To order this option, please select "Soil-Retardant Treatment" under "Optional Accessories."

For soil-retardant treatment on COMs, please select "Soil-Retardant Treatment" under "Optional Accessories." Minimums or additional yardage may be required. Please contact the vendor directly for specific information.

Extended lead times may be necessary for this service.

Contact your Steelcase Solutions Fulfillment Team Representative at 1.888.STEELCASE (1.888.783.3522) or send an email to lineone@steelcase.com.

Dimensions

▶ Page 224

Resources

Printed Materials

▶ Move Brochure (10-0002807)

Dimensions

Move 490 Series

	Overall Depth	Width	Height	Seat Depth	Functional Seat Depth	Seat Width	Seat Height from Floor	Back Width	Back Height from Seat
Move 490 Series									
Chair with Arms									
	20 ¹ / ₄ "	25 ³ / ₄ "	31 ¹ / ₂ "	18 ¹ / ₂ "	16 ⁷ / ₈ "	19"	18 ¹ / ₂ "	19"	15 ¹ / ₄ "
Plastic Chair with Arms									
	20 ¹ / ₄ "	25 ³ / ₄ "	31 ¹ / ₂ "	18 ¹ / ₂ "	16 ⁷ / ₈ "	18 ¹ / ₄ "	18"	19"	15 ¹ / ₂ "
Chair without Arms									
	20 ¹ / ₄ "	21"	31 ¹ / ₂ "	18 ¹ / ₂ "	16 ⁷ / ₈ "	19"	18 ¹ / ₂ "	19"	15 ¹ / ₄ "
Plastic Chair without Arms									
	20 ¹ / ₄ "	21"	31 ¹ / ₂ "	18 ¹ / ₂ "	16 ⁷ / ₈ "	18 ¹ / ₄ "	18"	19"	15 ¹ / ₂ "
Stool with Arms									
	20 ¹ / ₄ "	25 ³ / ₄ "	42 ¹ / ₂ "	18 ¹ / ₂ "	16 ⁷ / ₈ "	19"	29 ¹ / ₂ "	19"	15 ¹ / ₄ "
Plastic Stool with Arms									
	20 ¹ / ₄ "	25 ³ / ₄ "	42 ¹ / ₂ "	18 ¹ / ₂ "	16 ⁷ / ₈ "	18 ¹ / ₄ "	29"	19"	15 ¹ / ₂ "
Stool without Arms									
	20 ¹ / ₄ "	21"	42 ¹ / ₂ "	18 ¹ / ₂ "	16 ⁷ / ₈ "	19"	29 ¹ / ₂ "	19"	15 ¹ / ₄ "
Plastic Stool without Arms									
	20 ¹ / ₄ "	21"	42 ¹ / ₂ "	18 ¹ / ₂ "	16 ⁷ / ₈ "	18 ¹ / ₄ "	29"	19"	15 ¹ / ₂ "

• Back • Lumbar • Height	• Width • Between • Arms	• Arm • to • Floor	• Arm • Height • from • Seat	• Seat • Pan • Angle	• Angle • Between • Seat and • Back
--------------------------------	--------------------------------	--------------------------	---------------------------------------	----------------------------	--

Chair with Arms

10"	20½"	25¾"	8¾"	5°	95°
-----	------	------	-----	----	-----

Plastic Chair with Arms

10"	20½"	25¾"	8¾"	4°	96°
-----	------	------	-----	----	-----

Chair without Arms

10"	N.A.	N.A.	N.A.	5°	95°
-----	------	------	------	----	-----

Plastic Chair without Arms

10"	N.A.	N.A.	N.A.	4°	96°
-----	------	------	------	----	-----

Stool with Arms

10"	20½"	36¾"	8¾"	5°	95°
-----	------	------	-----	----	-----

Plastic Stool with Arms

10"	20½"	25¾"	8¾"	4°	96°
-----	------	------	-----	----	-----

Stool without Arms

10"	N.A.	N.A.	N.A.	5°	95°
-----	------	------	------	----	-----

Plastic Stool without Arms

10"	N.A.	N.A.	N.A.	4°	96°
-----	------	------	------	----	-----

Move 490 Series Value Package Multi-Use Chairs and Stools

Buzz2 Fabric on Seat with Black on Frame and Back Shell

Tip: Value package chairs allow you to obtain pre-selected features at a lower price than if specifying as a standard model number.

Tip: Options or substitutions are not available on this value package.

Standard Includes		Required to Specify
▶ Need help? Product details, page 222	<ul style="list-style-type: none"> • Frame: 0835 Black paint • Back shell: 6205 Black plastic • Seat: Buzz2 fabric • Arms, if selected: 6205 Black plastic • Glides, if selected: plastic with stainless steel inserts • Hard, dual-wheel casters, if selected: black 	1 Style number 2 Buzz2 fabric color number for seat 3 Options, if selected (see below) ▶ See <i>Surface Materials</i> , page 264.

Options	U.S. Price	Required to Specify
Surface Materials Upholstery <ul style="list-style-type: none"> • Fire Code Seating (FCS) 	+\$64	Add suffix F to the style number.

Specification Information	
• Style Number	• U.S. Base Price
•	•
•	•
•	•

Chairs without Arms

With Glides

490410V \$250

With Casters

490410VC \$295

Chairs with Arms

With Glides

490412V \$304

With Casters

490412VC \$349

▶ **Specification Information, continued on next page**



▶ Detailed dimensions, page 224



For Canadian Pricing

Multiply U.S. Price by the Canadian price factor.

▶ See page 1 for details.

► **Specification Information, continued from previous page**

Specification Information

• Style Number	• U.S. Base Price
-------------------	-------------------------

Stools without Arms

With Glides

490710V	\$455
----------------	-------

With Casters

490710VC	\$500
-----------------	-------

Stools with Arms

With Glides

490712V	\$509
----------------	-------

With Casters

490712VC	\$554
-----------------	-------



For Canadian Pricing
Multiply U.S. Price by the
Canadian price factor.
► See page 1 for details.

Move 490 Series Multi-Use Chairs



▶ Need help?
Product details,
page 222

Standard Includes

- Frame: paint
- Back shell: plastic
- Upholstery, if selected: fabric price group 1
- Arms, if selected: plastic to match back shell
- Glides, if selected: plastic with stainless steel inserts
- Hard, dual-wheel casters, if selected: black

Required to Specify

- 1 Style number
 - 2 Paint color number for frame
 - 3 Plastic color number for back shell, and seat, if selected
 - 4 Fabric color number for upholstery on seat and back, or seat, if selected
 - 5 Options, if selected (see below)
- ▶ See *Surface Materials*, page 264.

	Options	U.S. Price	Required to Specify
Surface Materials	Upholstery on seat		
	<ul style="list-style-type: none"> • Fabric price group 1 • Fabric price group 2 • Fabric price group 3 • Fabric price group 4 • Fabric price group 5 • Fabric price group 6 • Fabric price group 7 • Fabric price group 8 • Fabric price group 9 • Fabric price group 10 • Customer's Own Material (COM) • Steelcase leather upholstery • Elmosoft leather upholstery • Customer's Own Leather (COL) • Customer's Own Vinyl (COV) • Fire Code Seating (FCS) • Soil-retardant treatment applied to upholstery fabric 	<ul style="list-style-type: none"> No cost +\$ 10 +\$ 22 +\$ 30 +\$ 37 +\$ 46 +\$ 54 +\$ 68 +\$ 83 +\$ 95 No cost +\$ 78 +\$ 90 No cost No cost +\$ 64 +\$ 21 	<ul style="list-style-type: none"> Specify fabric color number. Specify fabric color number. Specify fabric color number. Specify fabric color number. Specify fabric color number. Specify fabric color number. Specify fabric color number. Specify fabric color number. Specify fabric color number. Specify fabric color number. ▶ See <i>Surface Materials Reference Manual</i> to specify. Specify leather color number. Specify Elmosoft leather color number. Specify leather color number. Specify vinyl color number. Add suffix F to the style number. Specify <i>with soil-retardant treatment</i>.
	Upholstery on seat and back		
	<ul style="list-style-type: none"> • Fabric price group 1 • Fabric price group 2 • Fabric price group 3 • Fabric price group 4 • Fabric price group 5 • Fabric price group 6 • Fabric price group 7 • Fabric price group 8 • Fabric price group 9 • Fabric price group 10 • Customer's Own Material (COM) • Steelcase leather upholstery • Elmosoft leather upholstery • Customer's Own Leather (COL) • Customer's Own Vinyl (COV) • Fire Code Seating (FCS) • Soil-retardant treatment applied to upholstery fabric 	<ul style="list-style-type: none"> No cost +\$ 22 +\$ 43 +\$ 59 +\$ 75 +\$107 +\$150 +\$199 +\$236 +\$274 No cost +\$156 +\$180 No cost No cost +\$ 64 +\$ 21 	<ul style="list-style-type: none"> Specify fabric color number. Specify fabric color number. Specify fabric color number. Specify fabric color number. Specify fabric color number. Specify fabric color number. Specify fabric color number. Specify fabric color number. Specify fabric color number. Specify fabric color number. ▶ See <i>Surface Materials Reference Manual</i> to specify. Specify leather color number. Specify Elmosoft leather color number. Specify leather color number. Specify vinyl color number. Add suffix F to the style number. Specify <i>with soil-retardant treatment</i>.
	Frame		
	<ul style="list-style-type: none"> • Platinum frame 	<ul style="list-style-type: none"> +\$ 52 	<ul style="list-style-type: none"> Specify <i>with 4799 Platinum frame</i>.
	Glides		
	<ul style="list-style-type: none"> • Soft glides for use on non-carpeted floors 	<ul style="list-style-type: none"> +\$ 6 	<ul style="list-style-type: none"> Specify <i>with soft glides</i>.
	Casters		
	<ul style="list-style-type: none"> • Soft, dual-wheel casters for use on hard floors 	<ul style="list-style-type: none"> +\$ 21 	<ul style="list-style-type: none"> Specify <i>with soft casters</i>.

Tip: Fire Code Seating (FCS) option is available only on models with 6205 Black or 6249 Platinum Solid plastic components.

▶ See pages 270–271 for upholstery fabric choices.

▶ Detailed dimensions, page 224



For Canadian Pricing
Multiply U.S. Price by the Canadian price factor.
▶ See page 1 for details.

Specification Information

• Style	• U.S.
• Number	• Base
•	• Price

Upholstered Seat without Arms

With Glides

490410	\$265
---------------	-------

With Casters

490410C	\$310
----------------	-------

Upholstered Back and Seat without Arms

With Glides

490410U	\$319
----------------	-------

With Casters

490410UC	\$364
-----------------	-------

Plastic Back and Seat without Arms

With Glides

490410P	\$207
----------------	-------

With Casters

490410CP	\$252
-----------------	-------

► **Specification Information, continued on next page**



Tip: Plastic finish number must be specified for both seat and back on plastic styles.



For Canadian Pricing
 Multiply U.S. Price by the Canadian price factor.
 ► See page 1 for details.

► **Specification Information, continued from previous page**

Specification Information

• Style Number	• U.S. Base Price
-------------------	-------------------------

Upholstered Seat with Arms

With Glides

490412	\$319
---------------	-------

With Casters

490412C	\$364
----------------	-------

Upholstered Back and Seat with Arms

With Glides

490412U	\$373
----------------	-------

With Casters

490412UC	\$418
-----------------	-------

Plastic Back and Seat with Arms

With Glides

490412P	\$261
----------------	-------

With Casters

490412CP	\$306
-----------------	-------



Tip: Plastic finish number must be specified for both seat and back on plastic styles.



For Canadian Pricing
 Multiply U.S. Price by the Canadian price factor.
 ► See page 1 for details.

Move 490 Series Multi-Use Stools



▶ Need help?
Product details,
page 222

Standard Includes

- Frame: paint
- Back shell: plastic
- Upholstery, if selected: fabric price group 1
- Arms, if selected: plastic to match back shell
- Glides, if selected: plastic with stainless steel inserts
- Hard, dual-wheel casters, if selected: black

Required to Specify

- 1 Style number
 - 2 Paint color number for frame
 - 3 Plastic color number for back shell, and seat, if selected
 - 4 Fabric color number for upholstery on seat and back, or seat, if selected
 - 5 Options, if selected (see below)
- ▶ See *Surface Materials*, page 264.

	Options	U.S. Price	Required to Specify
Surface Materials	Upholstery on seat		
	<ul style="list-style-type: none"> • Fabric price group 1 • Fabric price group 2 • Fabric price group 3 • Fabric price group 4 • Fabric price group 5 • Fabric price group 6 • Fabric price group 7 • Fabric price group 8 • Fabric price group 9 • Fabric price group 10 • Customer's Own Material (COM) • Steelcase leather upholstery • Elmosoft leather upholstery • Customer's Own Leather (COL) • Customer's Own Vinyl (COV) • Fire Code Seating (FCS) • Soil-retardant treatment applied to upholstery fabric 	<ul style="list-style-type: none"> No cost +\$ 10 +\$ 22 +\$ 30 +\$ 37 +\$ 46 +\$ 54 +\$ 68 +\$ 83 +\$ 95 No cost +\$ 78 +\$ 90 No cost No cost +\$ 64 +\$ 21 	<ul style="list-style-type: none"> Specify fabric color number. Specify fabric color number. Specify fabric color number. Specify fabric color number. Specify fabric color number. Specify fabric color number. Specify fabric color number. Specify fabric color number. Specify fabric color number. Specify fabric color number. ▶ See <i>Surface Materials Reference Manual</i> to specify. Specify leather color number. Specify Elmosoft leather color number. Specify leather color number. Specify vinyl color number. Add suffix F to the style number. Specify <i>with soil-retardant treatment</i>.
	Upholstery on seat and back		
	<ul style="list-style-type: none"> • Fabric price group 1 • Fabric price group 2 • Fabric price group 3 • Fabric price group 4 • Fabric price group 5 • Fabric price group 6 • Fabric price group 7 • Fabric price group 8 • Fabric price group 9 • Fabric price group 10 • Customer's Own Material (COM) • Steelcase leather upholstery • Elmosoft leather upholstery • Customer's Own Leather (COL) • Customer's Own Vinyl (COV) • Fire Code Seating (FCS) • Soil-retardant treatment applied to upholstery fabric 	<ul style="list-style-type: none"> No cost +\$ 22 +\$ 43 +\$ 59 +\$ 75 +\$107 +\$150 +\$199 +\$236 +\$274 No cost +\$156 +\$180 No cost No cost +\$ 64 +\$ 21 	<ul style="list-style-type: none"> Specify fabric color number. Specify fabric color number. Specify fabric color number. Specify fabric color number. Specify fabric color number. Specify fabric color number. Specify fabric color number. Specify fabric color number. Specify fabric color number. Specify fabric color number. ▶ See <i>Surface Materials Reference Manual</i> to specify. Specify leather color number. Specify Elmosoft leather color number. Specify leather color number. Specify vinyl color number. Add suffix F to the style number. Specify <i>with soil-retardant treatment</i>.
	Frame		
	<ul style="list-style-type: none"> • Platinum frame 	<ul style="list-style-type: none"> +\$ 52 	<ul style="list-style-type: none"> Specify <i>with 4799 Platinum frame</i>.
	Glides		
	<ul style="list-style-type: none"> • Soft glides for use on non-carpeted floors 	<ul style="list-style-type: none"> +\$ 6 	<ul style="list-style-type: none"> Specify <i>with soft glides</i>.
	Casters		
	<ul style="list-style-type: none"> • Soft, dual-wheel casters for use on hard floors 	<ul style="list-style-type: none"> +\$ 21 	<ul style="list-style-type: none"> Specify <i>with soft casters</i>.

Tip: Fire Code Seating (FCS) option is available only on models with 6205 Black or 6249 Platinum Solid plastic components.

▶ See pages 270–271 for upholstery fabric choices.

▶ Detailed dimensions,
page 224



For Canadian Pricing
Multiply U.S. Price by the
Canadian price factor.
▶ See page 1 for details.

Specification Information

Style Number	U.S. Base Price
--------------	-----------------

Upholstered Seat without Arms

With Glides

490710	\$470
---------------	-------

With Casters

490710C	\$515
----------------	-------

Upholstered Back and Seat without Arms

With Glides

490710U	\$524
----------------	-------

With Casters

490710UC	\$569
-----------------	-------

Plastic Back and Seat without Arms

With Glides

490710P	\$408
----------------	-------

With Casters

490710CP	\$453
-----------------	-------

► **Specification Information, continued on next page**

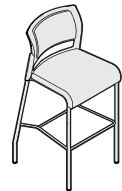

Tip: Plastic finish number must be specified for both seat and back on plastic styles.

► **Specification Information, continued from previous page**

Specification Information

• Style	• U.S.
• Number	• Base
•	• Price

Upholstered Seat with Arms

With Glides

490712	\$524
---------------	-------

With Casters

490712C	\$569
----------------	-------

Upholstered Back and Seat with Arms

With Glides

490712U	\$578
----------------	-------

With Casters

490712UC	\$623
-----------------	-------

Plastic Back and Seat with Arms

With Glides

490712P	\$462
----------------	-------

With Casters

490712CP	\$507
-----------------	-------



Tip: Plastic finish number must be specified for both seat and back on plastic styles.

Ganging and Alignment Device

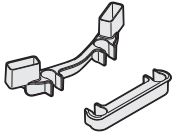

Tip: One pair is required to align two chairs. The 4" device is used for armless chairs and the 7" device is used for chairs with arms.

Standard Includes	Required to Specify
-------------------	---------------------

- | | |
|--|---------------------|
| Standard Includes | Required to Specify |
| <ul style="list-style-type: none"> Alignment device: black plastic only Package of two | Style number |

Specification Information		
Style Number	Width	U.S. Price

Style Number	Width	U.S. Price
490GA4	4"	\$33
490GA7	7"	\$33

Transport and Storage Dolly

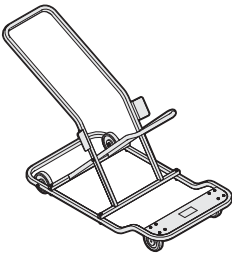

Standard Includes	Required to Specify
-------------------	---------------------

- | | |
|---|---------------------|
| Standard Includes | Required to Specify |
| <ul style="list-style-type: none"> Transport and storage dolly: black paint only | Style number |

Specification Information	
Style Number	U.S. Price

Style Number	U.S. Price
490D	\$665

Wall Saver Bumper

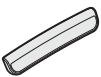

Standard Includes	Required to Specify
-------------------	---------------------

- | | |
|--|---------------------|
| Standard Includes | Required to Specify |
| <ul style="list-style-type: none"> Wall saver bumper: black plastic only Package of five | Style number |

Specification Information	
Style Number	U.S. Price

Style Number	U.S. Price
490W	\$22

 **For Canadian Pricing**
 Multiply U.S. Price by the Canadian price factor.
 ▶ See page 1 for details.



Understanding and Specifying Snodgrass 474 Series Multi-Use Chairs

Understanding Snodgrass 474 Series

Snodgrass 474 Series	238
Dimensions	240

Specifying Snodgrass 474 Series

Multi-Use Chairs	242
------------------	-----

Multi-Use Chairs

Multi-use chairs are suitable for use as occasional seating within team spaces, workstations, offices, or wherever extra seating is required.

- Ally 463 Series
- Player 475 Series
- Move 490 Series
- Snodgrass 474 Series

Snodgrass 474 Series

Snodgrass, designed by Warren Snodgrass, offers guest and occasional seating of classic simplicity. With a choice of metal or wood frames, Snodgrass has enduring design that is always in style.

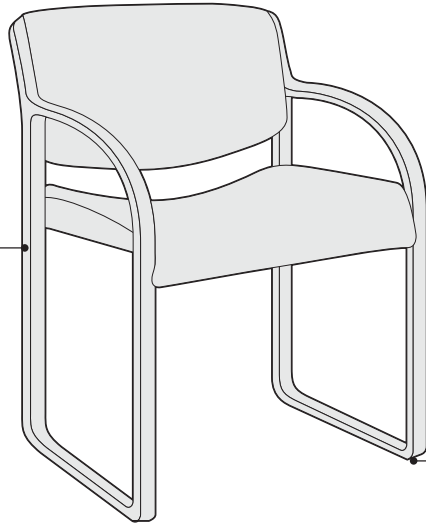

Frame is available in monochromatic colors or wood veneer.

Glides are clear plastic.

Product Details

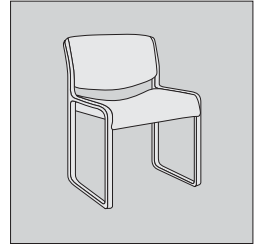

One back shape is available, open back.

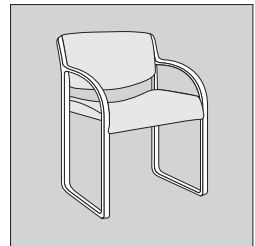

Open arms are available on monochromatic and wood models. Armless chairs are available monochromatic only.

Surface Materials

▶ See surface materials on page 264 for specific availability or refer to the *Surface Materials Reference Manual* for further information.

Upholstery

- Fabric
- Fabric with soil retardant treatment (option)
- Leather
- Elmosoft leather
- Vinyl

Frame

- Monochromatic color from list of seating plastic color numbers can be applied to the frame.
- Wood
Tip: Frames are constructed of solid maple. Finishes applied to maple will match the color of stains applied to oak, walnut, or cherry, but will not show the same natural grain.

Glides

- Clear plastic

All Steelcase seating with standard upholstery fabrics complies with requirements of the State of California Technical Bulletin 117. All standard seating is labeled to be in compliance with California 117.

Programs & Services

▶ See the *Surface Materials Reference Manual* for further detail about programs and services offered for seating.

The Customer's Own Material (COM) Program

offers the opportunity for customers to select fabrics that are not offered through the standard Steelcase surface materials program for use on Steelcase products. Through the COM program, Steelcase will test your materials for application on Steelcase products. Once approved, you can place your order. Steelcase will facilitate the entire ordering process and give you a production schedule. Steelcase will order the COM fabric directly from the textile manufacturer. For up-to-date information regarding fabric test results for all COM fabrics and details regarding yardage requirements for most Seating lines, visit the COM Web site. To locate the COM Web site:

- Visit www.steelcase.com

Soil retardants are treatments that provide long-term soil and stain resistance to a fabric without affecting the shade or the integrity of the fabric. The following Steelcase Textiles are available pre-treated with soil retardant. (You do not need to select the soil-retardant option for these fabrics and incur the upcharge.)

- Jacks
- Link
- Spyder

For information on soil retardant fabrics on Select Surfaces, please refer to the *Surface Materials Reference Manual*.

Soil-retardant treatment is available on all other seating fabrics at an additional upcharge per seating unit. To order this option, please select "Soil-Retardant Treatment" under "Optional Accessories."

For soil-retardant treatment on COMs, please select "Soil-Retardant Treatment" under "Optional Accessories." Minimums or additional yardage may be required. Please contact the vendor directly for specific information.

Soil-retardant treatment is available on all other seating fabrics at an additional upcharge per seating unit. To order this option, please select "Soil-Retardant Treatment" under "Optional Accessories."

For soil-retardant treatment on COMs, please select "Soil-Retardant Treatment" under "Optional Accessories." Minimums or additional yardage may be required. Please contact the vendor directly for specific information.

Extended lead times may be necessary for this service.

Contact your Steelcase Solutions Fulfillment Team Representative at 1.888.STEELCASE (1.888.783.3522) or send an email to lineone@steelcase.com.

Fire Codes

▶ See pages 270–271 for upholstery fabrics available for use with FCS modification.

Steelcase offers Fire Code Seating modification (FCS) on nearly all seating models. The most rigorous fire codes in the nation have been developed in California, and the Steelcase FCS modification is designed to meet those codes. Fire Code Seating (FCS) indicates that a product is constructed to meet the strict fire code requirements of high public occupancy areas such as theaters, meeting rooms, and lobbies. The FCS standards will meet both the State of California Home Furnishing Technical Bulletin 133 (Cal TB 133) and Boston Fire Code (BFC). Boston adopted the California Home Furnishing Technical Bulletin TB 133 test standard in 1992.

Local codes may have special requirements for upholstery.

Dimensions

▶ Page 240

Resources

Printed Materials

▶ Snodgrass Brochure (11-0002246)

Dimensions

Snodgrass 474 Series

Features	Overall Depth	Width	Height	Seat Depth	Functional Seat Depth	Seat Width	Seat Height from Floor	Back Width	Back Height from Seat
----------	---------------	-------	--------	------------	-----------------------	------------	------------------------	------------	-----------------------

Snodgrass 474 Series

Chair with Open Loop Arms

23½"	22¾"	31½"	21"	17½"	20"	18¼"	20"	14¼"
------	------	------	-----	------	-----	------	-----	------

Chair without Arms

23½"	22¾"	31½"	21"	17½"	20"	18¼"	20"	14¼"
------	------	------	-----	------	-----	------	-----	------

• Back Lumbar Height	• Width Between Arms	• Arm to Floor	• Arm Height from Seat	• Seat Pan Angle	• Angle Between Seat and Back
----------------------	----------------------	----------------	------------------------	------------------	-------------------------------

Chair with Open Loop Arms

7"	20"	25¼"	7"	5°	103°
----	-----	------	----	----	------

Chair without Arms



7"	20"	25¼"	7"	5°	103°
----	-----	------	----	----	------

Snodgrass 474 Series Multi-Use Chairs T

Standard Includes	Required to Specify
<ul style="list-style-type: none"> ▶ Need help? Product details, page 238 • Frame and arms, if selected: monochromatic color, or wood veneer • Upholstery: fabric price group 1 • Glides: clear plastic 	<ol style="list-style-type: none"> 1 Style number 2 Fabric color number for upholstery 3 Monochromatic color number from seating plastic colors for frame, if applicable 4 Wood veneer color number for frame, if applicable 5 Options, if selected (see below) <ul style="list-style-type: none"> ▶ See <i>Surface Materials</i>, page 264.

Options	U.S. Price	Required to Specify						
<table border="0"> <tr> <td style="vertical-align: top;">Surface Materials</td> <td> <ul style="list-style-type: none"> • Fabric price group 1 • Fabric price group 2 • Fabric price group 3 • Fabric price group 4 • Fabric price group 5 • Fabric price group 6 • Fabric price group 7 • Fabric price group 8 • Fabric price group 9 • Fabric price group 10 • Leather price group • Elmosoft leather upholstery • Customer's Own Material/Leather (COM/COL) • Fire Code Seating (FCS) • Soil-retardant treatment applied to upholstery fabric </td> <td> <ul style="list-style-type: none"> No cost +\$ 22 +\$ 43 +\$ 59 +\$ 75 +\$ 92 +\$107 +\$134 +\$166 +\$187 +\$483 +\$557 +\$ 32 +\$ 64 +\$ 21 </td> <td> <ul style="list-style-type: none"> Specify fabric color number. Specify fabric color number. Specify fabric color number. Specify fabric color number. Specify fabric color number. Specify fabric color number. Specify fabric color number. Specify fabric color number. Specify fabric color number. Specify fabric color number. Specify leather color number. Specify Elmosoft leather color number. ▶ See <i>Surface Materials Reference Manual</i> to specify. Add suffix F to the style number. Specify with <i>soil-retardant treatment</i>. </td> </tr> <tr> <td></td> <td> <ul style="list-style-type: none"> • Customiz stain on wood </td> <td> <ul style="list-style-type: none"> +\$ 26 </td> <td> <ul style="list-style-type: none"> Specify with <i>Customiz stain</i>. ▶ See <i>Surface Materials Reference Manual</i>. </td> </tr> </table>	Surface Materials	<ul style="list-style-type: none"> • Fabric price group 1 • Fabric price group 2 • Fabric price group 3 • Fabric price group 4 • Fabric price group 5 • Fabric price group 6 • Fabric price group 7 • Fabric price group 8 • Fabric price group 9 • Fabric price group 10 • Leather price group • Elmosoft leather upholstery • Customer's Own Material/Leather (COM/COL) • Fire Code Seating (FCS) • Soil-retardant treatment applied to upholstery fabric 	<ul style="list-style-type: none"> No cost +\$ 22 +\$ 43 +\$ 59 +\$ 75 +\$ 92 +\$107 +\$134 +\$166 +\$187 +\$483 +\$557 +\$ 32 +\$ 64 +\$ 21 	<ul style="list-style-type: none"> Specify fabric color number. Specify fabric color number. Specify fabric color number. Specify fabric color number. Specify fabric color number. Specify fabric color number. Specify fabric color number. Specify fabric color number. Specify fabric color number. Specify fabric color number. Specify leather color number. Specify Elmosoft leather color number. ▶ See <i>Surface Materials Reference Manual</i> to specify. Add suffix F to the style number. Specify with <i>soil-retardant treatment</i>. 		<ul style="list-style-type: none"> • Customiz stain on wood 	<ul style="list-style-type: none"> +\$ 26 	<ul style="list-style-type: none"> Specify with <i>Customiz stain</i>. ▶ See <i>Surface Materials Reference Manual</i>.
Surface Materials	<ul style="list-style-type: none"> • Fabric price group 1 • Fabric price group 2 • Fabric price group 3 • Fabric price group 4 • Fabric price group 5 • Fabric price group 6 • Fabric price group 7 • Fabric price group 8 • Fabric price group 9 • Fabric price group 10 • Leather price group • Elmosoft leather upholstery • Customer's Own Material/Leather (COM/COL) • Fire Code Seating (FCS) • Soil-retardant treatment applied to upholstery fabric 	<ul style="list-style-type: none"> No cost +\$ 22 +\$ 43 +\$ 59 +\$ 75 +\$ 92 +\$107 +\$134 +\$166 +\$187 +\$483 +\$557 +\$ 32 +\$ 64 +\$ 21 	<ul style="list-style-type: none"> Specify fabric color number. Specify fabric color number. Specify fabric color number. Specify fabric color number. Specify fabric color number. Specify fabric color number. Specify fabric color number. Specify fabric color number. Specify fabric color number. Specify fabric color number. Specify leather color number. Specify Elmosoft leather color number. ▶ See <i>Surface Materials Reference Manual</i> to specify. Add suffix F to the style number. Specify with <i>soil-retardant treatment</i>. 					
	<ul style="list-style-type: none"> • Customiz stain on wood 	<ul style="list-style-type: none"> +\$ 26 	<ul style="list-style-type: none"> Specify with <i>Customiz stain</i>. ▶ See <i>Surface Materials Reference Manual</i>. 					

Tip: Fire Code Seating (FCS) option is available with certain upholstery fabric choices only.
▶ Pages 270–271

Specification Information			
Open Loop Arms with Open Back 		Armless with Open Back 	
• Style Number	• U.S. Base Price	• Style Number	• U.S. Base Price
.....
Monochromatic			
474419M T	\$ 774	474410M T	\$736
Wood			
474419W T	\$1060		
.....		

▶ Detailed dimensions, page 240



For Canadian Pricing
Multiply U.S. Price by the Canadian price factor.
▶ See page 1 for details.

T = Transitional product

Understanding and Specifying Max-Stacker 472 Series Stackable Chairs

Product Details

Max-Stacker 472 Series	244
Dimensions	246

Specifying

Stackable Chairs	248
Accessories	250

Stackable Chairs

Stackable chairs offer flexibility and ease of use in classrooms, auditoriums, or wherever extra seating is required.

- Max-Stacker 472 Series
- Max-Stacker II 473 Series
- Player 475 Series Leg-Base Chairs
- Ally 463 Series

Max-Stacker 472 Series

Max-Stacker provides stackable seating for high-traffic applications. Its clean lines and durable steel rod frame have made the Max-Stacker a universally popular stacker selection.

Tablet arms and bookracks are available factory or field installed.

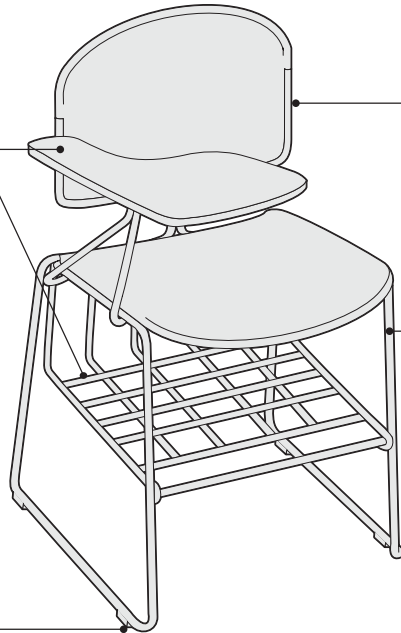

Plastic glides are standard. Soft glides, optional, are recommended for use on non-carpeted floors.

Back and seat are available in flexible, contoured plastic.

Two-piece wire-rod frame is 7/16" diameter carbon steel for strength and durability.

Product Details

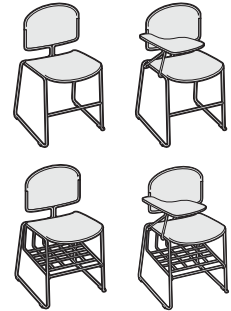

Four models are available—chairs without arms, chairs with bookracks, chairs with tablet arms, and chairs with a combination of bookrack and tablet arm.

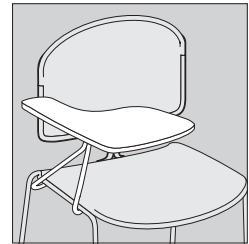

Tablet arms provide a writing surface that is 12½"D x 11⅜"W. They are available in left- or right-hand models.

Clearance between tablet arm and seat is 7¼"H. Tablet arm tilts for easy entrance and exit from chair.

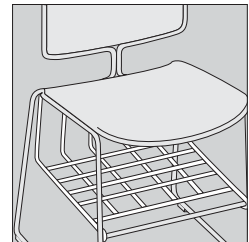

Bookrack is available factory or field installed for convenient storage of notebooks and purses.

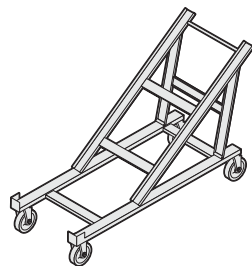

Transport and storage dolly is available to stack, move, and store up to 45 chairs. Chairs with bookracks and tablet arms cannot be stacked.

Unloaded transport dolly measures 55"D x 22"W x 37½"H.

Fully loaded transport dolly measures 57"D x 22"W x 68½"H.

Without transport dolly stack can be up to 12 chairs high.

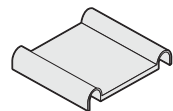

Alignment device is available to temporarily link chairs without tablet arms together in the field for evenly spaced rows. Chairs can be unlinked easily. Spacing between chairs linked with alignment device is 2¼".

Surface Materials

▶ See surface materials on page 264 for specific availability or refer to the *Surface Materials Reference Manual* for further information.

Hard components (frame)

- Seating coating
- 9201 Polished Chrome

Back and seat

- Plastic color

Bookrack

- Coated to match the frame color on seating coated models
- 9201 Polished Chrome on Polished Chrome models

Tablet arms

- Laminate

Glides

- Clear plastic
- Soft

Programs & Services

▶ See the *Surface Materials Reference Manual* for further detail about programs and services offered for seating.

Dimensions

▶ Page 246

Resources

Printed Materials

▶ Max-Stacker Brochure (11-0002245)

Dimensions

Max-Stacker 472 Series

• Overall • Depth	Width	Height	• Seat • Depth	• Functional • Seat • Depth	• Seat • Width	• Seat • Height • from • Floor	• Back • Width	• Back • Height • from • Seat	• Back • Lumbar • Height
Max-Stacker 472 Series									
21½"	20"	30¼"	17¾"	16¾"	18¼"	17½"	18¼"	14¾"	9½"

• Width • Between • Arms	• Arm • to • Floor	• Arm • Height • from • Seat	• Seat • Pan • Angle	• Angle • Between • Seat and • Back
--------------------------------	--------------------------	---------------------------------------	----------------------------	--

N.A.	N.A.	N.A.	8°	93°
------	------	------	----	-----

Max-Stacker 472 Series Stackable Chairs



Standard Includes		Required to Specify	
<ul style="list-style-type: none"> ▶ Need help? Product details, page 244 	<ul style="list-style-type: none"> • Frame: seating coating or 9201 Polished Chrome • Seat and back: plastic • Tablet arm, if selected: laminate • Bookrack, if selected: high-wear coating or 9201 Polished Chrome • Glides: plastic 		<ol style="list-style-type: none"> 1 Style number 2 Seating coating color number for frame and bookrack 3 Plastic color number for back and seat 4 Laminate color number for tablet arm 5 Options, if selected (see below) <ul style="list-style-type: none"> ▶ See <i>Surface Materials</i>, page 264.
Options		U.S. Price	Required to Specify
Glides	<ul style="list-style-type: none"> • Soft glides for use on non-carpeted floors 	+\$6	Specify <i>with soft glides</i> .

▶ Detailed dimensions, page 246



For Canadian Pricing

Multiply U.S. Price by the Canadian price factor.

▶ See page 1 for details.

Specification Information

Frame Finish	Style Number	U.S. Base Price
--------------	--------------	-----------------

Without Arms

Coated frame	472410N	\$162
Polished Chrome frame	472410	\$162

With Tablet Arm

Right-Hand

Coated frame	472410NTR	\$300
Polished Chrome frame	472410TR	\$300

Left-Hand

Coated frame	472410NTL	\$300
Polished Chrome frame	472410TL	\$300

With Bookrack

Coated frame	472410NBR	\$245
Polished Chrome frame	472410BR	\$245

With Right-Hand Tablet Arm

Coated frame	472410NTRB	\$383
Polished Chrome frame	472410TRB	\$383

With Left-Hand Tablet Arm

Coated frame	472410NTLB	\$383
Polished Chrome frame	472410TLB	\$383



Max-Stacker 472 Series

 **For Canadian Pricing**
Multiply U.S. Price by the
Canadian price factor.
▶ See page 1 for details.

Max-Stacker 472 Series Accessories

Tablet Arm Assembly



Standard Includes	Required to Specify
<ul style="list-style-type: none"> • Tablet arm frame: seating coating or 9201 Polished Chrome • Tablet arm worksurface: laminate 	<ul style="list-style-type: none"> 1 Style number 2 Laminate color number 3 Color number for tablet arm frame ▶ See <i>Surface Materials</i>, page 264.

Specification Information

Style Number	U.S. Price
Right-hand	
472TAR	\$144
Left-hand	
472TAL	\$144

Bookrack Assembly



Standard Includes	Required to Specify
<ul style="list-style-type: none"> • Bookrack assembly: seating coating or 9201 Polished Chrome 	<ul style="list-style-type: none"> 1 Style number 2 Color number for bookrack ▶ See <i>Surface Materials</i>, page 264.

Specification Information

Style Number	U.S. Price
472BR	\$87

Alignment Device

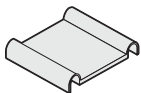

Standard Includes	Required to Specify
<ul style="list-style-type: none"> • Carton of 12 alignment devices: black plastic only 	<ul style="list-style-type: none"> Style number

Specification Information

Style Number	U.S. Price
472G	\$32



For Canadian Pricing
 Multiply U.S. Price by the Canadian price factor.
 ▶ See page 1 for details.

Transport and Storage Dolly

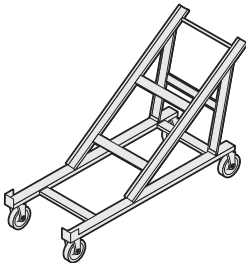

Standard Includes	Required to Specify
• Transport and storage dolly: black paint only	Style number

Specification Information

Style Number	U.S. Price
473D	\$476
.	.

For Canadian Pricing
Multiply U.S. Price by the
Canadian price factor.
▶ See page 1 for details.



Understanding and Specifying Max-Stacker II 473 Series Stackable Chairs

Product Details

Max-Stacker II 473 Series	254
Dimensions	256

Specifying

Stackable Chairs	258
Accessories	260

Stackable Chairs

Stackable chairs offer flexibility and ease of use in classrooms, auditoriums, or wherever extra seating is required.

- Max-Stacker 472 Series
- Max-Stacker II 473 Series
- Player 475 Series Leg-Base Chairs
- Ally 463 Series

Max-Stacker II 473 Series

Max-Stacker II offers different visuals with rounded back and curved lines in another great stacking chair.

Tablet arms and bookracks are available factory or field installed.

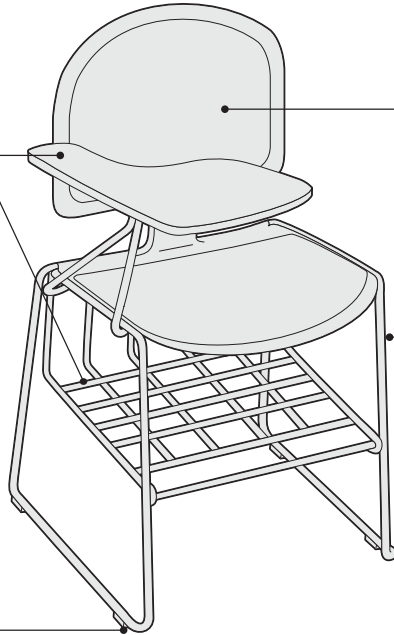

Plastic glides are standard. Soft glides, optional, are recommended for use on non-carpeted floors.

Flexible, contoured back and seat are available in plastic or with upholstered cushions.

Two-piece wire-rod frame is 7/16"-diameter carbon steel for strength and durability.

Product Details

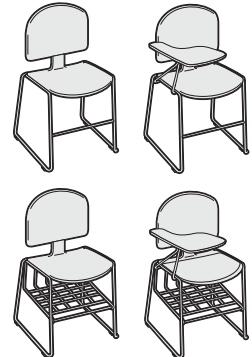

Four models are available—chairs without arms, chairs with bookracks, chairs with tablet arms, and chairs with a combination of bookrack and tablet arm.

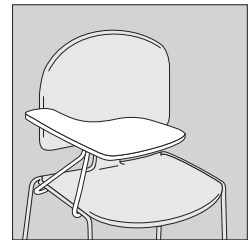

Tablet arms provide a writing surface that is 12½"D x 11⅜"W. They are available in left- or right-hand models.

Clearance between tablet arm and seat is 7¼"H. Tablet arm tilts for easy entrance and exit from chair.

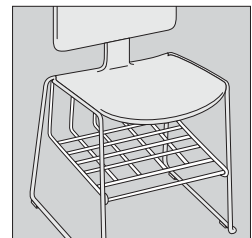

Bookrack is available factory or field installed for convenient storage of notebooks and purses.

Stacking bumpers are provided on upholstered models to protect the fabric when chairs are stacked.

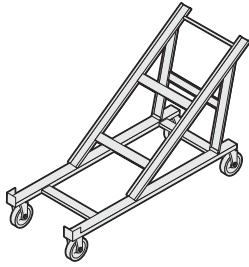

Transport and storage dolly is available to stack, move, and store up to 35 non-upholstered or 25 upholstered chairs. Chairs with bookracks and tablet arms cannot be stacked.

Unloaded transport dolly measures 55"D x 22"W x 37½"H.

Fully loaded transport dolly measures 57"D x 22"W x 68½"H.

Without transport dolly stack can be up to 12 chairs high.

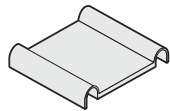

Alignment device is available to temporarily link chairs together in the field for evenly spaced rows. Chairs can be unlinked easily. Spacing between chairs linked with alignment device is 2¼".

Surface Materials

▶ See surface materials on page 264 for specific availability or refer to the *Surface Materials Reference Manual* for further information.

Hard components (frame)

- Seating coating
- 9201 Polished Chrome

Back and seat

- Plastic color
- Upholstery

Upholstery

- Fabric
- Fabric with soil retardant treatment (option)

Bookrack

- Coated to match the frame color on seating coated models
- 9201 Polished Chrome on Polished Chrome models

Tablet arms

- Laminate

Glides

- Clear plastic
- Soft

Programs & Services

▶ See the *Surface Materials Reference Manual* for further detail about programs and services offered for seating.

The Customer's Own Material (COM) Program

offers the opportunity for customers to select fabrics that are not offered through the standard Steelcase surface materials program for use on Steelcase products. Through the COM program, Steelcase will test your materials for application on Steelcase products. Once approved, you can place your order. Steelcase will facilitate the entire ordering process and give you a production schedule. Steelcase will order the COM fabric directly from the textile manufacturer. For up-to-date information regarding fabric test results for all COM fabrics and details regarding yardage requirements for most Seating lines, visit the COM Web site. To locate the COM Web site:

- Visit www.steelcase.com

Soil retardants are treatments that provide long-term soil and stain resistance to a fabric without affecting the shade or the integrity of the fabric. The following Steelcase Textiles are available pre-treated with soil retardant. (You do not need to select the soil-retardant option for these fabrics and incur the upcharge.)

- Jacks
- Link
- Spyder

For information on soil retardant fabrics on Select Surfaces, please refer to the *Surface Materials Reference Manual*.

Soil-retardant treatment is available on all other seating fabrics at an additional upcharge per seating unit. To order this option, please select "Soil-Retardant Treatment" under "Optional Accessories."

For soil-retardant treatment on COMs, please select "Soil-Retardant Treatment" under "Optional Accessories." Minimums or additional yardage may be required. Please contact the vendor directly for specific information.

Extended lead times may be necessary for this service.

Contact your Steelcase Solutions Fulfillment Team Representative at 1.888.STEELCASE (1.888.783.3522) or send an email to lineone@steelcase.com.

Steelcase Fire Code Seating (FCS) is not available on Max-Stacker II seating.

Dimensions

▶ Page 256

Resources

Printed Materials

▶ Max-Stacker Brochure (11-0002245)

Dimensions

Max-Stacker II 473 Series

• Overall • Depth	Width	Height	• Seat • Depth	• Functional • Seat • Depth	• Seat • Width	• Seat • Height • from • Floor	• Back • Width	• Back • Height • from • Seat	• Back • Lumbar • Height
Max-Stacker II 473 Series									
22 ³ / ₄ "	19 ³ / ₄ "	33 ¹ / ₄ "	19"	17"	18 ¹ / ₄ "	17 ¹ / ₂ "	18 ¹ / ₄ "	17 ³ / ₄ "	10"

• Width • Between • Arms	• Arm • to • Floor	• Arm • Height • from • Seat	• Seat • Pan • Angle	• Angle • Between • Seat and • Back
--------------------------------	--------------------------	---------------------------------------	----------------------------	--

N.A.	N.A.	N.A.	8°	93°
------	------	------	----	-----

Max-Stacker II 473 Series Stackable Chairs



	Standard Includes	Required to Specify
▶ Need help? Product details, page 254	<ul style="list-style-type: none"> • Frame: seating coating or 9201 Polished Chrome • Back and seat: plastic • Tablet arm, if selected: laminate • Bookrack, if selected: high-wear coating or 9201 Polished Chrome • Glides: plastic 	<ol style="list-style-type: none"> 1 Style number 2 Seating coating color number for frame 3 Plastic color number for back and seat 4 Laminate color number for tablet arm 5 Options, if selected (see below) <p>▶ See <i>Surface Materials</i>, page 264.</p>

	Options	U.S. Price	Required to Specify
Surface Materials	Upholstered seat and back		
	• Fabric price group 1	+\$129	Add suffix U to the style number and specify fabric color number.
	• Fabric price group 2	+\$151	Add suffix U to the style number and specify fabric color number.
	• Fabric price group 3	+\$172	Add suffix U to the style number and specify fabric color number.
	• Fabric price group 4	+\$188	Add suffix U to the style number and specify fabric color number.
	• Fabric price group 5	+\$204	Add suffix U to the style number and specify fabric color number.
	• Fabric price group 6	+\$221	Add suffix U to the style number and specify fabric color number.
	• Fabric price group 7	+\$236	Add suffix U to the style number and specify fabric color number.
	• Fabric price group 8	+\$263	Add suffix U to the style number and specify fabric color number.
	• Fabric price group 9	+\$295	Add suffix U to the style number and specify fabric color number.
	• Fabric price group 10	+\$316	Add suffix U to the style number and specify fabric color number.
	• Customer's Own Material (COM)	+\$161	▶ See <i>Surface Materials Reference Manual</i> to specify.
	• Soil-retardant treatment applied to upholstery fabric	+\$ 21	Specify <i>with soil-retardant treatment</i> .
Glides	• Soft glides for use on non-carpeted floors	+\$ 6	Specify <i>with soft glides</i> .

▶ Detailed dimensions,
page 256



For Canadian Pricing
Multiply U.S. Price by the
Canadian price factor.
▶ See page 1 for details.

Specification Information

Frame Finish	Style Number	U.S. Base Price
--------------	--------------	-----------------



Without Arms

Coated frame	473410N	\$193
Polished Chrome frame	473410	\$193



With Tablet Arm

Right-Hand

Coated frame	473410NTR	\$334
Polished Chrome frame	473410TR	\$334



Left-Hand

Coated frame	473410NTL	\$334
Polished Chrome frame	473410TL	\$334



With Bookrack

Coated frame	473410NB	\$276
Polished Chrome frame	473410B	\$276



With Right-Hand Tablet Arm

Coated frame	473410NTRB	\$417
Polished Chrome frame	473410TRB	\$417



With Left-Hand Tablet Arm

Coated frame	473410NTLB	\$417
Polished Chrome frame	473410TLB	\$417



For Canadian Pricing
Multiply U.S. Price by the
Canadian price factor.
▶ See page 1 for details.

Max-Stacker II 473 Series Accessories

Tablet Arm Assembly

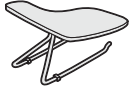

Standard Includes	Required to Specify
<ul style="list-style-type: none"> • Tablet arm frame: seating coating or 9201 Polished Chrome • Tablet arm worksurface: laminate 	<ul style="list-style-type: none"> 1 Style number 2 Laminate color number 3 Color number for tablet arm frame ▶ See <i>Surface Materials</i>, page 264.

Specification Information

Style Number	U.S. Price
Right-Hand	
473TR	\$144
Left-Hand	
473TL	\$144
•	•

Bookrack Assembly



Standard Includes	Required to Specify
<ul style="list-style-type: none"> • Bookrack assembly: seating coating or 9201 Polished Chrome 	<ul style="list-style-type: none"> 1 Style number 2 Color number for bookrack ▶ See <i>Surface Materials</i>, page 264.

Specification Information

Style Number	U.S. Price
473B	\$87
•	•

Alignment Device

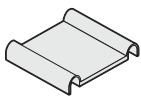

Standard Includes	Required to Specify
<ul style="list-style-type: none"> • Carton of 12 alignment devices: black plastic only 	<ul style="list-style-type: none"> Style number

Specification Information

Style Number	U.S. Price
473G	\$32
•	•



For Canadian Pricing
 Multiply U.S. Price by the Canadian price factor.
 ▶ See page 1 for details.

Transport and Storage Dolly

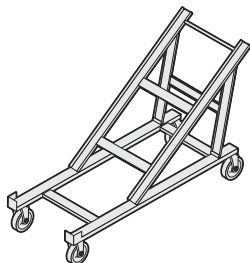

Standard Includes

- Transport and storage dolly: black paint only

Required to Specify

- Style number

Specification Information

• Style Number	• U.S. Price
473D	\$476
.	.



For Canadian Pricing
Multiply U.S. Price by the
Canadian price factor.
▶ See page 1 for details.



Surface Materials

Surface Materials	264
Seating Upholstery Matrix	268
Fire Code Seating Upholstery Matrix	270
Color Availability Matrix	272
Special Features	276

Surface Materials

This listing includes all the surface material choices that are available for the products in this specification guide.

Resources

For more information about surface materials, refer to the following resources:

Additional surface materials specification tools are available to assist you in the specification process—the Surface Materials Binders.

Surface Materials Binders

- Surface Materials Reference Manual
- A complete set of swatch cards for hard surfaces, vertical surface fabrics, and seating upholstery

Plastic

Steelcase Surfaces

Not every plastic color is available on every plastic component.

▶ Refer to the *Color Availability Matrix* on page 272 before specifying.

- 6009 Arctic White
- 6053 Seagull
- 6059 Sterling Dark Solid
- 6205 Black
- 6206 Burgundy
- 6249 Platinum Solid
- 6250 Coffee
- 6256 Graphite
- 6259 Midnight
- 6295 Near Black
- 6296 Sterling
- 6301 Aegean
- 6302 Baltic
- 6303 Pomegranate
- 6332 Citron
- 6333 Picasso
- 6334 Flash
- 6335 Wasabi
- 6336 Jazz
- 6337 Element
- 6338 Chili
- 6654 Sand

ⓔ=Established

Seating Coating

Steelcase Surfaces

- Applies to:
- Max-Stacker 472 Series
 - Max-Stacker II 473 Series
- 7000 Black
 - 7005 Coffee
 - 7011 Graphite

Paint

Steelcase Surfaces

- Applies to:
- Jersey Series work chairs
- 4799 Platinum Metallic

- Applies to:
- Jersey Series guest chairs
- 4799 Platinum Metallic
 - 7207 Black

- Applies to:
- Siento 499 Series chairs
 - Move 490 Series chair frames

- 0835 Black
- 4799 Platinum Metallic
- 7239 Midnight

- Applies to:
- cobl 434 Series chairs
- 0835 Black
 - 4799 Platinum Metallic
 - 4803 Near Black Metallic

- Applies to:
- node 480 Series chairs
- 0835 Black
 - 4750 Champagne Metallic
 - 4799 Platinum Metallic

Accessory Paint

Steelcase Surfaces

- Applies to:
- cobl 434 Series chairs
- 4140 Arctic White Gloss

Metal

Steelcase Surfaces

- Metal finishes are not available on every chair.
- ▶ Refer to the *Color Availability Matrix* on page 272 before specifying.
- 8046 Polished Aluminum
 - 9201 Polished Chrome

Laminate

Steelcase Surfaces

Not every laminate color is available on every chair.

▶ Refer to the *Color Availability Matrix* on page 272 before specifying.

- 2406 Clear Cherry
- 2409 Clear Maple
- 2410 Graphite Walnut
- 2412 Natural Cherry
- 2422 Medium Cherry
- 2511 Winter on Maple
- 2538 Clear Walnut
- 2539 Warm Oak
- 2714 Natural Walnut
- 2722 Cream
- 2730 Arctic White
- 2746 Black
- 2759 Warm White
- 2772 Medium Mahogany on Walnut ⓔ
- 2811 Mist
- 2883 Seagull
- 2884 Milk
- 2885 Dune
- 25T1 Winter on Maple
- 26T1 Natural Cherry

Note: Some wood veneer finishes and woodgrain laminates share the same name. Because of the difference in materials, veneers and laminates of the same name are not an exact match but do coordinate with each other.

Wood

Steelcase Surfaces

- Applies to:
- Snodgrass 474 Series chair frames
- Tip: Frames are constructed of solid maple. Finishes applied to maple will match the color of stains applied to oak, walnut, or cherry, but will not show the same natural grain.*

Wood Seating Color Choices

- 3062 Graphite Walnut
- 3402 Clear Cherry (Aged)
- 3412 Natural Cherry ⓔ
- 3422 Medium Cherry
- 3522 Clear Maple*
- 3572 Amber on Maple
- 3592 Blonde on Maple
- 3602 Desert Oak
- 3612 Warm Oak
- 3692 Espresso Oak
- 3702 Clear Walnut
- 3712 Natural Walnut
- 3722 Dark Mahogany on Walnut
- 3752 Medium Walnut
- 3762 Dark Walnut
- 3772 Medium Mahogany on Walnut

**To ensure an understanding of the color ranges and characteristic variations of natural veneer, a sign-off sheet is required prior to orders being accepted for this clear-coat finish. The sign-off sheet is available through Steelcase advertising stock. Form number 05-0001370.*

Applies to:

- i2i tablet arms
- 3062 Graphite Walnut
 - 3222 Clear Maple*
 - 3272 Amber on Maple
 - 3292 Blonde on Maple
 - 3302 Desert Oak
 - 3312 Natural Walnut
 - 3322 Dark Mahogany on Walnut
 - 3352 Medium Walnut
 - 3362 Dark Walnut
 - 3372 Medium Mahogany on Walnut
 - 3382 Graphite Walnut
 - 3402 Clear Cherry (Aged)
 - 3412 Natural Cherry ⓔ
 - 3422 Medium Cherry
 - 3522 Clear Maple
 - 3572 Amber on Maple
 - 3592 Blonde on Maple
 - 3602 Desert Oak
 - 3612 Warm Oak
 - 3692 Espresso Oak
 - 3702 Clear Walnut
 - 3712 Natural Walnut
 - 3722 Dark Mahogany on Walnut
 - 3752 Medium Walnut
 - 3762 Dark Walnut
 - 3772 Medium Mahogany on Walnut

**To ensure an understanding of the color ranges and characteristic variations of natural veneer, a sign-off sheet is required prior to orders being accepted for this clear-coat finish. The sign-off sheet is available through Steelcase advertising stock. Form number 05-0001370.*

Custom Surfaces

Customiz stain is a service that allows you to create your own stain color. Minimum order quantities, per unit up-charges, and a one-time customer processing fee apply.

▶ See the *Surface Materials Reference Manual* for more information.

▶ See *c:scape Specification Guide* for the complete surface materials list for the i2i collaborative lounge table.

Elmorous Leather**Custom Surfaces**

Applies to:

- Leap 464 Series
WorkLounge
- 12011 Light Grey
- 22679 Beige
- 33286 Rust
- 43236 Camel
- 43632 Honey
- 48059 Field Green
- 53301 Red Brown
- 55057 Crimson
- 55063 Flame
- 93287 Charbrown
- 93327 Loam
- 97054 Twilight
- 98953 Mist Green
- 99991 Ebony

Mesh**Steelcase Surfaces**

Applies to:

- Jersey Series
- T084 Black
- T085 Grey
- T086 White
- T087 Yellow
- T088 Orange
- T089 Red
- T090 Green
- T091 Blue
- T094 Cardinal

Applies to

- Reply Series
- AR01 Air Grey
- AR02 Air Black
- AR03 Air White
- AR04 Air Red
- AR05 Air Royal Blue
- AR06 Air Apple Green
- AR07 Air Orange
- AR08 Air Bright Purple
- AR09 Air Sable

3D Knit**Steelcase Surfaces**

Applies to:

- i2i 416 Series
- Leap 462 Series
- Think 465 Series
- Amia 482 Series
- 5064 Licorice
- 5065 Coconut
- 5066 Malt
- 5067 Root Beer
- 5090 Wasabi
- 5091 Maya Blue
- 5092 Graphite
- 5093 Nickel
- 5094 Tangerine
- 5095 Scarlet
- 5096 Turmeric
- 5097 Concord
- 5098 Blue Jay
- 5099 Basil

Connect 3D**Steelcase Surfaces**

Applies to:

- cob1 434 Series
- 5015 Coconut
- 5016 Turmeric
- 5017 Tangerine
- 5018 Scarlet
- 5019 Concord
- 5020 Maya Blue
- 5021 Blue Jay
- 5022 Basil
- 5023 Wasabi
- 5024 Nickel
- 5025 Graphite
- 5026 Licorice
- 5027 Malt
- 5028 Root Beer

Upholstery

Not every upholstery is available on every chair.

▶ Refer to the *Steelcase Upholstery Matrix* on page 268 before specifying.**Steelcase Surfaces****Price Group 1****Buzz2**

- 5F01 Camel **E**
- 5F03 Tomato
- 5F04 Red **E**
- 5F05 Burgundy
- 5F06 Sky **E**
- 5F07 Blue
- 5F08 Navy
- 5F10 Grape **E**
- 5F11 Eggplant **E**
- 5F15 Stone
- 5F16 Grey
- 5F17 Black
- 5G50 Dunegrass
- 5G51 Sable
- 5G52 Barley
- 5G53 Sunrise
- 5G54 Carrot
- 5G55 Pumpkin
- 5G56 Timber
- 5G57 Rouge
- 5G58 Chocolate
- 5G59 Meadow
- 5G60 Ivy
- 5G61 Cyan
- 5G62 Atlantic
- 5G63 Crocus
- 5G64 Alpine
- 5G65 Tornado

Jacks

- 5B61 Taupe
- 5B63 Camel
- 5B64 Pewter
- 5B66 Plum
- 5B70 Midnight

Link

- 5A20 Burgundy
- 5A21 Rust
- 5A23 Green
- 5A24 Blue
- 5A25 Navy
- 5A26 Purple
- 5A27 Black
- 5A28 Ocean
- 5A29 Lichen
- 5A30 Chamois

Playground

- 5F28 Claret
- 5F29 Chile
- 5F30 Amber
- 5F31 Nut
- 5F32 Blade
- 5F33 Stone
- 5F34 Sky
- 5F35 Navy
- 5F36 Huckleberry
- 5F37 Charcoal

Seating Vinyl

- 5801 Topaz
- 5805 Foggy Night
- 5809 Black
- 5810 Forest
- 5812 Navy
- 5813 Currant
- 5814 Leaf
- 5815 Seaside
- 5817 Pebble
- 5818 Spice
- 5819 Thistle
- 5820 Coffee
- 5822 Iris

Price Group 2**Cogent: Connect**

- 5S15 Coconut
- 5S16 Turmeric
- 5S17 Tangerine
- 5S18 Scarlet
- 5S19 Concord
- 5S20 Maya Blue
- 5S21 Blue Jay
- 5S22 Basil
- 5S23 Wasabi
- 5S24 Nickel
- 5S25 Graphite
- 5S26 Licorice
- 5S27 Malt
- 5S28 Root Beer
- 5S93 Blueprint
- 5S94 Lizard
- 5S95 Sailor
- 5S96 Quicksilver
- 5S97 Nugget
- 5S98 Canary
- 5S99 Lipstick

Cogent: Geode Seating

- 5S46 Bark
- 5S47 Coal
- 5S48 Smoke
- 5S49 Cobalt
- 5S50 Ink
- 5S51 Shamrock
- 5S52 Pear
- 5S53 Berry
- 5S54 Mandarin
- 5S55 Sunset
- 5S56 Citrus
- 5S57 Thunder

Cogent: Geode Vertical

- 5S31 Pebble
- 5S32 Canyon
- 5S33 Honey
- 5S34 Ice
- 5S35 Slate
- 5S36 Cement
- 5S37 Rock
- 5S38 Oyster
- 5S39 Buff
- 5S40 Toast
- 5S41 Sesame
- 5S42 Ecru
- 5S43 Dove

Cogent: Trails

- 5S29 Bronzite
- 5S30 Amethyst
- 5S84 Jasper
- 5S85 Agate
- 5S86 Lapis
- 5S87 Malachite
- 5S88 Quartz
- 5S89 Carnelian
- 5S90 Tiger Eye
- 5S91 Travertine
- 5S92 Topaz

Cricket

- 5A84 Plum
- 5A85 Camel
- 5A86 Charcoal
- 5A87 Black
- 5A90 Currant
- 5A91 Spearmint
- 5A92 Sky
- 5A93 Midnight
- 5A95 Ocean
- 5A96 Forest

Crosswalk

- 5F48 Beech
- 5F49 Moon
- 5F50 Berry
- 5F51 Admiral Blue
- 5F52 Moss
- 5F53 Persimmon
- 5F54 Bittersweet
- 5F55 Midnight
- 5F56 Poppy

Nitelights

- 5F58 Hazelnut
- 5F59 Burgundy
- 5F60 Cherry
- 5F61 Earth
- 5F62 Shore
- 5F63 Moss
- 5F64 Sea
- 5F65 Regal Blue
- 5F66 Stone
- 5F67 Moon

Regis2

- 5F18 Black
- 5F24 Pacific
- 5F26 Cherry
- 5F27 Navy

E=Established

Spyder

- 5B00 Orchid **E**
- 5B01 Foggy Night **E**
- 5B04 Peri **E**
- 5B05 Merlot **E**
- 5B06 Dove **E**
- 5B07 Sage **E**
- 5B09 Topaz **E**
- 5B11 Currant **E**
- 5B12 Lichen **E**

Stand In

- 5621 Sleet
- 5622 Lunar
- 5623 Cyclone
- 5624 Eclipse
- 5625 Powder
- 5626 Chardonnay
- 5627 Graham
- 5628 Sediment
- 5629 Allspice
- 5630 Apple
- 5631 Lava
- 5632 Cayenne
- 5633 Plantain
- 5634 Parsley
- 5635 Scallion
- 5636 Atlantis
- 5691 Orca

Zoe2

- 5C90 Eggplant
- 5C91 Aloe
- 5C92 Fiddle
- 5C93 Patina
- 5C94 Peacock
- 5C95 Rain
- 5C96 Grey Flannel
- 5C97 Pebble
- 5C98 Cymbal
- 5C99 Fiesta

Price Group 3

Cogent: Tides

- 5S71 Butter
- 5S72 Snow
- 5S73 Celery
- 5S74 Wicker
- 5S75 Pool
- 5S76 Cloud
- 5S77 Grass
- 5S78 Clay
- 5S79 Hyacinth
- 5S80 Jet
- 5S81 Doe
- 5S82 Boysenberry
- 5S83 Night

Hampstead

- B351 Blue Green V4 **E**
- B359 Blue Blue Green V5 **E**
- B366 Blue Blue Violet V4 **E**
- B369 Blue Blue Violet V5 **E**
- B377 Violet V5 (Low Intensity) **E**
- B389 Red Red Violet V5 **E**
- B395 Grey V5 **E**
- B399 Black
- B406 Windflower **E**
- B413 Shale **E**
- B423 Clementine
- B424 Butter Cream
- B425 Iris
- B426 Sapphire
- B427 Turquoise
- B428 Navy
- B429 Charcoal
- B430 Spa
- B431 Plum
- B432 Cocoa
- B433 Cork
- B434 Stone
- B435 Metal
- B436 Peridot
- B437 Cactus
- B438 Sycamore
- B439 Candy Apple

Price Group 5

Bo Peep

- 5G66 Pita
- 5G67 Bone
- 5G68 Safari
- 5G69 Brown Sugar
- 5G70 Chocolate Chip
- 5G71 Candlelight
- 5G72 Honey Mustard
- 5G73 Marmalade
- 5G74 Picnic
- 5G75 Pinot
- 5G76 Bloom
- 5G77 Grapevine
- 5G78 Firefly
- 5G79 Artichoke
- 5G80 Serpent
- 5G81 Carolina
- 5G82 Blue Bonnet
- 5G83 Nautical
- 5G84 Gravel
- 5G85 Sharkskin
- 5G86 Kohl

Price Group 6

Brisa

- BR01 Black Onyx
- BR04 Truffle
- BR06 Ash
- BR07 Sage
- BR08 Celery
- BR09 Sterling Blue
- BR10 Night Navy
- BR11 Cambridge Blue
- BR12 Abyss
- BR13 Canyon
- BR14 Pompeian Red
- BR15 Salsa
- BR16 Cinnabar
- BR17 Aztec
- BR18 New Sand
- BR19 Cream
- BR20 White
- BR21 Moccasin
- BR22 Buckskin
- BR23 Prairie

Leather Price Group

Steelcase Leather

- L107 Black
- L202 Dusk
- L203 Bottle
- L207 Mahogany
- L220 Soapstone
- L221 Rocky
- L224 Plum
- L500 Camel
- L503 Navy
- L507 Vineyard

Elmosoft Leather Price Group

Elmosoft Leather

- L110 Maritime Blue
- L111 Midnight Blue
- L112 Ebony
- L113 Gunmetal
- L114 Mica
- L115 Dove Grey
- L116 Plum Pleasure
- L122 Truffle
- L128 Red Birch
- L132 Violet
- L133 Espresso
- L134 Ruby
- L135 Scarlet
- L136 Claret
- L137 Cabernet
- L138 Bourbon
- L139 Cinder
- L140 Garnet
- L143 Pecan
- L144 Chamois
- L145 Palomino
- L146 Russet
- L147 Saddle
- L148 Goldstone
- L150 Ivory
- L151 White
- L709 Sugar
- L710 Lava
- L711 Parchment
- L712 Buff
- L713 Sand
- L714 Maize
- L715 Camel
- L716 Khaki
- L717 Cameo
- L718 Mushroom
- L719 Taupe
- L720 Fawn
- L721 Rock
- L722 Desert
- L723 Storm
- L724 Mist
- L725 Teal
- L726 Celadon
- L727 Egyptian Blue
- L728 Bright Blue
- L729 Aquarium
- L730 Hunter
- L731 Fern
- L732 Edamame
- L733 Moss
- L734 Key Lime
- L735 Creamsicle
- L736 Lemon
- L737 Sunshine
- L738 Drama
- L739 Byzantium
- L740 Dazzle
- L741 Fuchsia
- L742 Flamingo

Select Surfaces

For information on products within Select Surfaces, including accent paints and fabrics from Designtex, Maharam, and Pollack, please refer to the *Surface Materials Reference Manual* or visit Steelcase.com/selectsurfaces.

Custom Surfaces

Price Group COM (Customer's Own Material)

Fabric Approval and Yardage
To confirm whether a particular COM material has already been tested for use on a specific Steelcase product or to determine actual yardage requirements:
• Visit www.steelcase.com

For additional information regarding Customer's Own Material, call (1.888.783.3522) or send an email to lineone@steelcase.com.

E=Established

Seating Upholstery Matrix

Legend

- = Not available
- = Available
- = Available with exceptions
- Ⓜ = Established
- EL = Elmosoft leather
- L = Leather
- ▶ See specification pages for details.

	Price Group	Ally 463 Series	Ally 463 Series - Sewn	Amia 482 Series - 3D Knit	Amia 482 Series	Amia 482 Series - 3D Knit - Sewn	Amia 482 Series - Sewn	ap40: Amia 482 Series, Crew, Jack	Cachet 487 Series	cobi 434 Series - Connect 3D	cobi 434 Series - Connect 3D - Sewn	Criterion 453 Series - Molded	Criterion 453 Series - Plus	Criterion 453 Series - Sewn	Criterion 453 Series - Sewn Back, Non-Sewn Seat	Drive 461 Series	Drive 461 Series - Sewn	i2i 416 Series - 3D Knit - Sewn	Jersey Series - Jersey Mesh	Jersey Series - Sewn	Leap V2 462 Series - 3D Knit	Leap V2 462 Series	Leap Plus 462 Series - 3D Knit	Leap Plus 462 Series	Leap V2 462 Series - 3D Knit - Sewn	Leap V2 462 Series - Sewn
Bo Peep	5	■	•	■	■	•	•	•	■	•	■	■	■	•	•	■	•	■	■	•	■	■	■	■	•	•
Brisa	6	■	■	■	■	■	■	•	■	•	■	■	■	■	•	•	■	■	■	•	■	■	■	■	■	■
Buzz2	1	■	•	■	■	■	■	•	■	•	■	■	■	•	•	■	•	■	■	•	■	■	■	■	•	•
Cogent: Connect	2	■	•	■	■	•	•	•	■	•	■	■	■	•	•	■	•	■	■	•	■	■	■	■	•	•
Cogent: Geode Seating	2	■	•	■	■	•	•	•	■	•	■	■	■	•	•	■	•	■	■	•	■	■	■	■	•	•
Cogent: Geode Vertical	2	■	•	■	■	•	•	•	■	•	■	■	■	•	•	■	•	■	■	•	■	■	■	■	•	•
Cogent: Tides	3	■	•	■	■	•	•	•	■	•	■	■	■	•	•	■	•	■	■	•	■	■	■	■	•	•
Cogent: Trails	2	■	•	■	■	•	•	•	■	•	■	■	■	•	•	■	•	■	■	•	■	■	■	■	•	•
Cricket	2	■	•	■	■	•	•	•	■	•	■	■	■	•	•	■	•	■	■	•	■	■	■	■	•	•
Crosswalk	2	■	•	■	■	•	•	•	■	•	■	■	■	•	•	■	•	■	■	•	■	■	■	■	•	•
Elmorustical Leather	NA	•	•	•	•	•	•	•	•	•	•	•	•	•	•	•	•	•	•	•	•	•	•	•	•	•
Elmosoft Leather	EL	•	■	•	•	■	■	•	■	•	■	■	■	■	■	■	■	■	■	■	■	■	■	■	■	■
Hampstead	3	■	•	■	■	•	•	•	■	•	■	■	■	•	•	■	•	■	■	•	■	■	■	■	•	•
Jacks	1	■	•	■	■	■	■	•	■	•	■	■	■	•	•	■	•	■	■	•	■	■	■	■	•	•
Jersey Black	NA	•	•	•	•	•	•	•	•	•	•	•	•	•	•	•	•	•	•	•	•	•	•	•	•	•
Steelcase Leather	L	•	■	•	•	■	■	•	■	•	■	■	■	■	■	■	■	■	■	■	■	■	■	■	■	■
Link	1	■	•	■	■	■	■	•	■	•	■	■	■	■	■	■	■	■	■	■	■	■	■	■	■	■
Nitelights	2	■	•	■	■	•	•	•	■	•	■	■	■	•	•	■	•	■	■	•	■	■	■	■	■	■
Playground	1	■	•	■	■	•	•	■	■	•	■	■	■	•	•	■	•	■	■	•	■	■	■	■	■	■
Regis2	2	■	•	■	■	■	■	•	■	•	■	■	■	•	•	■	•	■	■	•	■	■	■	■	■	■
Seating Vinyl	1	•	■	•	•	■	■	•	■	•	■	■	■	■	■	■	■	■	■	■	■	■	■	■	■	■
Spyder Ⓜ	2	■	•	■	■	■	■	•	■	•	■	■	■	•	•	■	•	■	■	•	■	■	■	■	■	■
Stand In	2	•	■	•	•	■	■	•	■	•	■	■	■	■	■	■	■	■	■	■	■	■	■	■	■	■
Zoe2	2	■	•	■	■	■	■	•	■	•	■	■	■	■	■	■	■	■	■	■	■	■	■	■	■	■

Leap 464 Series WorkLounge is standard with Bo Peep. Elmorustical leather is an option.
Think 465 Series sewn version available in leather and vinyl only on models with 3D Knit back.
Amia 482 Series sewn version models with leather or vinyl require an "S" suffix which features an additional stitch detail across the lumbar region on the back cushion. Vinyl is not available on models with upholstered outer back.
3D Knit upholstery available only on models with 3D Knit back.

Legend

- = Not available
- = Available
- = Available with exceptions
- Ⓜ = Established
- EL = Elmosoft leather
- L = Leather
- ▶ See specification pages for details.

	Leap 464 WorkLounge and Ottoman Series	Max Stacker II 473 Series	media:scape Lounge	Mobile Ped Cushion Tops-9000,Avenir, and Context	Mobile Pedestal Cushion Tops - ap40	Move 490 Series	Player 475 Series	Protégé 433 Series	Protégé 433 Series - Sewn	Reply 466 Series - Uph Seat - Mesh Back	Reply 466 Series Uph Seat-Mesh Back-Side Chair	Reply 466 Series - Uph Seat - Uph Back	Reply 466 Series-Uph Seat-Uph Back-Side Chair	Reply 466 Series - Sewn Seat - Mesh Back	Reply 466 Series-Sewn Seat-Mesh Back-Side Chair	Reply 466 Series-Sewn Seat-Sewn Back	Reply 466 Series-Sewn Seat-Sewn Back-Side Chair	Reply 466 Series-Sewn Seat-Uph Back-Side Chair	Siento 499 Series - Sewn	Snodgrass 474 Series	Think 465 Series - 3D Knit	Think 465 Series	Think 465 Series - Sewn - 3D Knit	Think 465 Series - Sewn - Stitched Detail	Universal Pedestal Cushion Tops
Bo Peep	■	■	■	■	•	■	■	■	•	■	■	■	■	•	•	•	•	■	■	■	■	■	■	■	
Brisa	•	•	■	■	•	■	■	■	•	■	•	•	•	■	■	■	■	■	■	■	•	•	■	■	
Buzz2	•	■	■	■	■	■	■	■	•	■	■	■	■	•	•	•	•	■	■	■	■	■	■	■	
Cogent: Connect	•	■	■	■	•	■	■	■	•	■	■	■	■	•	•	•	•	■	■	■	■	■	■	■	
Cogent: Geode Seating	•	■	•	■	•	■	■	■	•	■	•	■	•	•	•	•	•	■	■	■	■	■	■	■	
Cogent: Geode Vertical	•	■	•	■	•	■	■	■	•	■	•	■	•	•	•	•	•	■	■	■	■	■	■	■	
Cogent: Tides	•	■	■	■	•	■	■	■	•	■	■	■	■	•	•	•	•	■	■	■	■	■	■	•	
Cogent: Trails	•	■	•	■	•	■	■	■	•	■	•	•	•	•	•	•	•	■	■	■	■	■	■	■	
Cricket	•	■	■	■	•	■	■	■	•	■	■	■	■	•	•	•	•	■	■	■	■	■	■	■	
Crosswalk	•	■	•	■	•	■	■	■	•	■	■	■	■	•	•	•	•	■	■	■	■	■	■	■	
Elmorustical Leather	■	•	•	•	•	•	•	•	•	•	•	•	•	•	•	•	•	•	•	•	•	•	•	•	
Elmosoft Leather	•	•	■	■	•	■	■	■	•	■	•	•	•	■	■	■	■	■	■	■	•	•	■	■	
Hampstead	•	■	■	■	•	■	■	■	•	■	■	■	■	•	•	•	•	■	■	■	■	■	■	■	
Jacks	•	■	■	■	■	■	■	■	•	■	■	■	■	•	•	•	•	■	■	■	■	■	■	■	
Jersey Black	•	•	•	•	•	•	•	•	•	•	•	•	•	•	•	•	•	•	•	•	•	•	•	•	
Steelcase Leather	•	•	■	■	•	■	■	■	•	■	•	•	•	■	■	■	■	■	■	■	•	•	■	■	
Link	•	■	■	■	•	■	■	■	•	■	■	■	■	•	•	•	•	■	■	■	■	■	■	■	
Nitelights	•	■	■	■	•	■	■	■	•	■	■	■	■	•	•	•	•	■	■	■	■	■	■	■	
Playground	•	■	■	■	■	■	■	■	•	■	■	■	■	•	•	•	•	■	■	■	■	■	■	■	
Regis2	•	■	■	■	•	■	■	■	•	■	■	■	■	•	•	•	•	■	■	■	■	■	■	■	
Seating Vinyl	•	•	■	■	■	■	■	■	•	■	■	■	■	■	■	■	■	■	■	■	•	•	■	■	
Spyder Ⓜ	•	■	■	■	•	■	■	■	•	■	■	■	■	•	•	•	•	■	■	■	■	■	■	■	
Stand In	•	•	■	■	■	■	■	■	•	■	•	•	•	■	■	■	■	■	■	■	•	•	■	■	
Zoe2	•	■	•	■	•	■	■	■	•	■	■	■	■	•	•	•	•	■	■	■	■	■	■	■	

Leap 464 Series WorkLounge is standard with Bo Peep. Elmorustical leather is an option.
Think 465 Series sewn version available in leather and vinyl only on models with 3D Knit back.
Amia 482 Series sewn version models with leather or vinyl require an "S" suffix which features an additional stitch detail across the lumbar region on the back cushion. Vinyl is not available on models with upholstered outer back.
3D Knit upholstery available only on models with 3D Knit back.

Surface Materials

Fire Code Seating Upholstery Matrix

Seating Upholstery: Availability of Fire Code Treatment

The following matrix lists each seating line and denotes fabrics that are available, available with exceptions, and not available. For further detail regarding exceptions, see the specific chapter within the *Seating Specification Guide* or the *Surface Materials Reference Manual*.

	Price Group	Ally 463 Series	Ally 463 Series - Sewn	Amia 482 Series - 3D Knit	Amia 482 Series	Amia 482 Series - 3D Knit, Sewn	Amia 482 Series - Sewn	ap40: Amia 482 Series, Crew, Jack	Cachet 487 Series	cobi 434 Series - Connect 3D	cobi 434 Series - Connect 3D, Sewn	Criterion 453 Series - Molded	Criterion 453 Series - Plus	Criterion 453 Series - Sewn	Criterion 453 Series - Sewn Back, Non-Sewn Seat	Drive 461 Series	Drive 461 Series - Sewn	i2i 416 Series - 3D Knit, Sewn	Jersey Series - Jersey Mesh	Jersey Series - Sewn	Leap 462 Series - 3D Knit	Leap 462 Series	Leap Plus 462 Series - 3D Knit	Leap Plus 462 Series	Leap 462 Series - 3D Knit, Sewn	Leap 462 Series - Sewn
Bo Peep	5	■	•	■	■	•	•	•	■	•	■	■	■	•	•	■	•	■	•	•	■	■	■	•	■	
Brisa	6	■	■	■	■	•	■	•	■	•	■	■	■	■	•	■	■	■	•	•	■	■	■	■	•	■
Buzz2	1	■	•	■	■	•	■	•	■	•	■	■	■	■	•	■	•	■	•	•	■	■	■	■	•	■
Cogent: Connect	2	■	•	■	■	•	•	•	■	•	■	■	■	■	•	■	•	■	•	•	■	■	■	■	•	■
Cogent: Geode Seating	2	■	•	■	■	•	•	•	■	•	■	■	■	■	•	■	•	■	•	•	■	■	■	■	•	■
Cogent: Geode Vertical	2	■	•	■	■	•	•	•	■	•	■	■	■	■	•	■	•	■	•	•	■	■	■	■	•	■
Cogent: Tides	3	■	•	■	■	•	•	•	■	•	■	■	■	■	•	■	•	■	•	•	■	■	■	■	•	■
Cogent: Trails	2	■	•	■	■	•	•	•	■	•	■	■	■	■	•	■	•	■	•	•	■	■	■	■	•	■
Cricket	2	■	•	■	■	•	•	•	■	•	■	■	■	■	•	■	•	■	•	•	■	■	■	■	•	■
Crosswalk	2	■	•	■	■	•	•	•	■	•	■	■	■	■	•	■	•	■	•	•	■	■	■	■	•	■
Elmoustrical Leather	NA	■	•	■	■	•	•	•	■	•	■	■	■	■	•	■	•	■	•	•	■	■	■	■	•	■
Elmosoft Leather	EL	•	■	■	•	•	■	•	■	•	■	■	■	■	•	■	•	■	•	•	■	■	■	■	•	■
Hampstead	3	■	•	■	■	•	•	•	■	•	■	■	■	■	•	■	•	■	•	•	■	■	■	■	•	■
Jacks	1	■	•	■	■	•	■	•	■	•	■	■	■	■	•	■	•	■	•	•	■	■	■	■	•	■
Jersey Black	NA	■	•	■	■	•	•	•	■	•	■	■	■	■	•	■	•	■	•	•	■	■	■	■	•	■
Steelcase Leather	L	■	■	■	■	•	■	•	■	•	■	■	■	■	•	■	•	■	•	•	■	■	■	■	•	■
Link	1	■	•	■	■	•	•	•	■	•	■	■	■	■	•	■	•	■	•	•	■	■	■	■	•	■
Nitelights	2	■	•	■	■	•	•	•	■	•	■	■	■	■	•	■	•	■	•	•	■	■	■	■	•	■
Playground	1	■	•	■	■	•	•	•	■	•	■	■	■	■	•	■	•	■	•	•	■	■	■	■	•	■
Regis2	2	■	•	■	■	•	■	•	■	•	■	■	■	■	•	■	•	■	•	•	■	■	■	■	•	■
Seating Vinyl	1	■	■	■	■	•	■	•	■	•	■	■	■	■	•	■	•	■	•	•	■	■	■	■	•	■
Spyder [Ⓢ]	2	■	•	■	■	•	■	•	■	•	■	■	■	■	•	■	•	■	•	•	■	■	■	■	•	■
Stand In	2	■	■	■	■	•	■	•	■	•	■	■	■	■	•	■	•	■	•	•	■	■	■	■	•	■
Zoe2	2	■	•	■	■	•	■	•	■	•	■	■	■	■	•	■	•	■	•	•	■	■	■	■	•	■

Cachet models meet fire code requirements only when specified with 6205 Black plastic.
cobi 434 Series fire code models are available in the following Connect 3D colors only: 5021 Blue Jay, 5023 Wasabi, 5025 Graphite, 5026 Licorice, 5027 Malt, and 5028 Root Beer.
Criterion and Criterion Plus models meet fire code requirements only when specified with adjustable seat depth and 6205 Black plastic.
Drive models meet fire code requirements only when specified with 6205 Black plastic.
Move models meet fire code requirements only when specified with 6205 Black plastic.
Think 3D Knit models meet fire code requirements except for models with lumbar option.
Think 465 Series sewn version is available in leather and vinyl only on models with 3D Knit back.
3D Knit upholstery is available only on models with 3D Knit back.

Legend

- = Not available
 - = Available
 - = Available with exceptions
 - ▣ = Untested
 - Ⓢ = Established
 - EL = Elmosoft leather
 - L = Leather
- ▶ See specification pages for details.
 Fire Code Seating (FCS) indicates that a product is constructed to meet the strict fire code requirements of high public occupancy areas.

Seating Upholstery: Availability of Fire Code Treatment, continued

The following matrix lists each seating line and denotes fabrics that are available, available with exceptions, and not available. For further detail regarding exceptions, see the specific chapter within the *Seating Specification Guide* or the *Surface Materials Reference Manual*.

	Leap 464 WorkLounge and Ottoman Series	Max Stacker II 473 Series	media:scape Lounge	Mobile Ped Cushion Tops-9000,Avenir, and Context	Mobile Pedestal Cushion Tops - ap40	Move 490 Series	Player 475 Series	Protégé 433 Series	Protégé 433 Series - Sewn	Reply 466 Series - Uph Seat, Mesh Back	Reply 466 Series - Uph Seat, Mesh Back, Side Chair	Reply 466 Series - Uph Seat, Uph Back	Reply 466 Series - Uph Seat, Uph Back, Side Chair	Reply 466 Series - Sewn Seat, Mesh Back	Reply 466 Series-Sewn Seat,Mesh Back,Side Chair	Reply 466 Series - Sewn Seat, Sewn Back	Reply 466 Series-Sewn Seat,Sewn Back,Side Chair	Reply 466 Series - Sewn Seat, Uph Back, Side chair	Siento 499 Series - Sewn	Snodgrass 474 Series	Think 465 Series - 3D Knit	Think 465 Series	Think 465 Series - Sewn, 3D Knit	Think 465 Series - Sewn, Stitched Detail	Universal Pedestal Cushion Tops
Bo Peep	■	•	•	•	•	■	■	■	■	■	■	■	■	■	■	■	■	■	■	■	•	•	■	•	■
Brisa	•	•	•	•	•	■	■	•	■	■	■	■	■	■	■	■	■	■	■	■	■	•	•	■	•
Buzz2	•	•	•	•	•	■	■	■	■	■	■	■	■	■	■	■	■	■	■	■	■	•	■	■	•
Cogent: Connect	•	•	•	•	•	■	■	■	■	■	■	■	■	■	■	■	■	■	■	■	■	■	■	■	•
Cogent: Geode Seating	•	•	•	•	•	■	■	■	■	■	■	■	■	■	■	■	■	■	■	■	■	■	■	■	•
Cogent: Geode Vertical	•	•	•	•	•	■	■	■	■	■	■	■	■	■	■	■	■	■	■	■	■	■	■	■	•
Cogent: Tides	•	•	•	•	•	■	■	■	■	■	■	■	■	■	■	■	■	■	■	■	■	■	■	■	•
Cogent: Trails	•	•	•	■	•	■	■	•	■	■	■	■	■	■	■	■	■	■	■	■	■	■	■	■	•
Cricket	•	•	•	•	•	■	■	■	■	■	■	■	■	■	■	■	■	■	■	■	■	■	■	■	•
Crosswalk	•	•	•	•	•	■	■	■	■	■	■	■	■	■	■	■	■	■	■	■	■	■	■	■	•
Elmorustical Leather	•	•	•	•	•	■	■	■	■	■	■	■	■	■	■	■	■	■	■	■	■	■	■	■	•
Elmosoft Leather	•	•	•	•	•	■	■	■	■	■	■	■	■	■	■	■	■	■	■	■	■	■	■	■	•
Hampstead	•	•	•	•	•	■	■	■	■	■	■	■	■	■	■	■	■	■	■	■	■	■	■	■	•
Jacks	•	•	•	•	•	■	■	■	■	■	■	■	■	■	■	■	■	■	■	■	■	■	■	■	•
Jersey Black	•	•	•	•	•	■	■	■	■	■	■	■	■	■	■	■	■	■	■	■	■	■	■	■	•
Steelcase Leather	•	•	•	•	•	■	■	■	■	■	■	■	■	■	■	■	■	■	■	■	■	■	■	■	•
Link	•	•	•	•	•	■	■	■	■	■	■	■	■	■	■	■	■	■	■	■	■	■	■	■	•
Nitelights	•	•	•	•	•	■	■	■	■	■	■	■	■	■	■	■	■	■	■	■	■	■	■	■	•
Playground	•	•	•	•	•	■	■	■	■	■	■	■	■	■	■	■	■	■	■	■	■	■	■	■	•
Regis2	•	•	•	•	•	■	■	■	■	■	■	■	■	■	■	■	■	■	■	■	■	■	■	■	•
Seating Vinyl	•	•	•	•	•	■	■	■	■	■	■	■	■	■	■	■	■	■	■	■	■	■	■	■	•
Spyder [ⓐ]	•	•	•	•	•	■	■	■	■	■	■	■	■	■	■	■	■	■	■	■	■	■	■	■	•
Stand In	•	•	•	•	•	■	■	■	■	■	■	■	■	■	■	■	■	■	■	■	■	■	■	■	•
Zoe2	•	•	•	•	•	■	■	■	■	■	■	■	■	■	■	■	■	■	■	■	■	■	■	■	•

- Cachet models** meet fire code requirements only when specified with 6205 Black plastic.
- Criterion and Criterion Plus models** meet fire code requirements only when specified with adjustable seat depth and 6205 Black plastic.
- Drive models** meet fire code requirements only when specified with 6205 Black plastic.
- Move models** meet fire code requirements only when specified with 6205 Black plastic.
- Think 3D Knit models** meet fire code requirements except for models with lumbar option.
- Think 465 Series** sewn version is available in leather and vinyl only on models with 3D Knit back.
- 3D Knit upholstery** is available only on models with 3D Knit back.

Legend

- = Not available
 - = Available
 - = Available with exceptions
 - = Untested
 - ⓐ = Established
 - EL = Elmosoft leather
 - L = Leather
 - ▶ See specification pages for details.
- Fire Code Seating (FCS) indicates that a product is constructed to meet the strict fire code requirements of high public occupancy areas.

Color Availability Matrix

Legend

- = Not available
- = Available
- = Available with exceptions
- Ⓜ = Established
- ▶ See specification pages for details.

		Plastic																						
		6009	6053	6059	6205	6206	6249	6250	6256	6259	6295	6296	6301	6302	6303	6332	6333	6334	6335	6336	6337	6338	6654	
		Arctic White	Seagull	Sterling Dark Solid	Black	Burgundy	Platinum Solid	Coffee	Graphite	Midnight	Near Black	Sterling	Aegean	Baltic	Pomegranate	Citron	Picasso	Flash	Wasabi	Jazz	Element	Chili	Sand	
Ally 463 Series	Outer seat, back, and arms	•	•	•	■	•	•	•	•	•	•	•	•	•	•	•	•	•	•	•	•	•	•	•
	Frame	•	•	•	■	•	•	•	•	■	•	■	•	•	•	•	•	•	•	•	•	•	•	•
Amia 482 Series	Base and frame	•	•	•	■	•	■	•	•	•	•	•	•	•	•	•	•	•	•	•	•	•	•	•
	Outer seat and back	•	•	•	■	•	■	•	•	•	•	•	•	•	•	•	•	•	•	•	•	•	•	•
	Arms	•	•	•	■	•	•	•	•	•	•	•	•	•	•	•	•	•	•	•	•	•	•	•
	Stool base and frame	•	•	•	■	•	■	•	•	•	•	•	•	•	•	•	•	•	•	•	•	•	•	•
	Stool foot ring	•	•	•	■	•	•	•	•	•	•	•	•	•	•	•	•	•	•	•	•	•	•	•
Cachet 487 Series	Swivel and 4-leg frame	•	•	•	■	•	•	•	•	□	•	•	•	•	•	•	•	•	•	•	•	•	•	•
	Stool frame	•	•	•	■	•	•	•	•	•	•	•	•	•	•	•	•	•	•	•	•	•	•	•
cobi 434 Series	Base and back frame	•	•	•	■	•	•	•	•	•	•	•	•	•	•	•	•	•	•	•	•	•	•	•
	Arm caps, top edge, and casters	•	•	•	■	•	■	•	•	•	•	•	•	•	•	•	•	•	•	•	•	•	•	•
	Outer back	■	•	•	■	•	■	•	•	•	■	•	•	•	•	•	•	•	•	•	•	•	•	•
	Foot ring	•	•	•	■	•	■	•	•	•	•	•	•	•	•	•	•	•	•	•	•	•	•	•
Criterion 453 Series	Base, arms, outer seat and back, casters	•	•	•	■	•	•	□	□	•	•	•	•	•	•	•	•	•	•	•	•	•	•	•
	Foot ring	•	•	•	■	•	•	□	□	•	•	•	•	•	•	•	•	•	•	•	•	•	•	•
Drive 461 Series	Base, arms, faceplate, outer seat and back, casters	•	•	•	■	•	•	•	□	•	•	•	•	•	•	•	•	•	•	•	•	•	•	•
i2i 416 Series	Outer back	□	•	•	•	•	■	•	•	•	■	•	•	•	•	•	•	•	•	•	•	•	•	•
	Base and cylinder	•	•	•	•	•	•	•	•	•	•	•	•	•	•	•	•	•	•	•	•	•	•	•
	Tablet arm	•	•	•	•	•	•	•	•	•	•	•	•	•	•	•	•	•	•	•	•	•	•	•
Jersey Series	Work chair	•	•	•	•	•	•	•	•	•	•	•	•	•	•	•	•	•	•	•	•	•	•	•
	Guest chair	•	•	•	•	•	•	•	•	•	•	•	•	•	•	•	•	•	•	•	•	•	•	•
Leap 462 Series	Base and ribbon frame	•	•	•	■	•	■	•	•	■	•	•	•	•	•	•	•	•	•	•	•	•	•	•
	Outer seat and back	•	•	•	■	•	■	•	•	■	•	•	•	•	•	•	•	•	•	•	•	•	•	•
	Arms	•	•	•	■	•	•	•	•	•	•	•	•	•	•	•	•	•	•	•	•	•	•	•
	Stool base and ribbon frame	•	•	•	■	•	■	•	•	■	•	•	•	•	•	•	•	•	•	•	•	•	•	•
	Stool foot ring	•	•	•	■	•	•	•	•	•	•	•	•	•	•	•	•	•	•	•	•	•	•	•
Leap 464 Series WorkLounge	Back frame, arm supports, and base	•	•	•	•	•	•	•	•	•	•	•	•	•	•	•	•	•	•	•	•	•	•	•
Max-Stacker 472 and 473 Series	Frame and bookrack	•	•	•	•	•	•	•	•	•	•	•	•	•	•	•	•	•	•	•	•	•	•	•
	Seat and back	•	•	•	■	■	•	■	■	•	•	•	■	■	■	•	•	•	■	•	•	•	•	•
	Tablet arm	•	•	•	•	•	•	•	•	•	•	•	•	•	•	•	•	•	•	•	•	•	•	•
Move 490 Series	Frame	•	•	•	•	•	•	•	•	•	•	•	•	•	•	•	•	•	•	•	•	•	•	•
	Back shell and arms	□	•	□	■	•	■	•	•	□	•	•	•	•	•	□	□	□	□	□	□	□	□	•
node 480 Series	Shell	□	•	□	■	•	□	•	•	■	•	•	•	•	•	□	□	□	■	■	□	□	•	•
	Personal worksurface	•	■	•	•	•	■	•	•	■	•	•	•	•	•	•	•	•	•	■	•	■	•	■
	Tripod base	•	•	•	•	•	■	•	•	•	■	•	•	•	•	•	•	•	•	•	■	•	•	•
	Metal	•	•	•	•	•	•	•	•	•	•	•	•	•	•	•	•	•	•	•	•	•	•	•

FCS models for Cachet, Criterion, and Drive are available with 6205 Black plastic only.

FCS models for Move are available with 6205 Black or 6249 Platinum Solid plastic only.

FCS models for i2i are available with 6249 Platinum Solid or 6295 Near Black plastic only.

FCS models for node are available with 6205 Black, 6259 Midnight, 6335 Wasabi, or 6336 Jazz only.

Metal		Accessory Paint		Paint		Seating Coating		Laminate	
8046	Polished Aluminum	4140	Arctic White Gloss	0835	Black	7000	Black	2406	Clear Cherry
9201	Polished Chrome			4750	Champagne Metallic	7005	Coffee	2409	Clear Maple
				4799	Platinum Metallic	7011	Graphite	2410	Graphite Walnut
				4803	Near Black Metallic			2412	Natural Cherry
				7207	Black			2422	Medium Cherry
				7239	Midnight			2511	Winter on Maple
								2538	Clear Walnut
								2539	Warm Oak
								2714	Natural Walnut
								2722	Cream
								2730	Arctic White
								2746	Black
								2759	Warm White
								2772	Med Mahogany on Walnut E
								2811	Mist
								2883	Seagull
								2884	Milk
								2885	Dune
								25T1	Winter on Maple
								26T1	Natural Cherry

Color Availability Matrix, continued

Legend

- = Not available
- = Available
- = Available with exceptions
- E = Established
- ▶ See specification pages for details.

		Plastic																						
		6009	6053	6059	6205	6206	6249	6250	6256	6259	6295	6296	6301	6302	6303	6332	6333	6334	6335	6336	6337	6338	6654	
		Arctic White	Seagull	Sterling Dark Solid	Black	Burgundy	Platinum Solid	Coffee	Graphite	Midnight	Near Black	Sterling	Aegean	Baltic	Pomegranate	Citron	Picasso	Flash	Wasabi	Jazz	Element	Chili	Sand	
Player 475 Series	Frame on chairs with smooth arms	•	•	•	■	•	■	■	•	•	•	•	•	•	•	•	•	•	•	•	•	•	•	
	Smooth arms	•	•	•	■	•	■	■	•	•	•	•	•	•	•	•	•	•	•	•	•	•	•	
	Frame on chairs with textured arms	•	•	•	■	•	■	•	•	•	•	•	•	•	•	•	•	•	•	•	•	•	•	
	Textured arms	•	•	•	■	•	■	•	•	•	•	•	•	•	•	•	•	•	•	•	•	•	•	
	Tablet arm	•	•	•	•	•	•	•	•	•	•	•	•	•	•	•	•	•	•	•	•	•	•	
Protégé 433 Series	Base, arms, and sled base	•	•	•	■	•	■	■	•	•	•	•	•	•	•	•	•	•	•	•	•	•	•	
	Arm caps and outer back shell	•	•	•	■	•	•	■	•	•	•	•	•	•	•	•	•	•	•	•	•	•	•	
	Casters	•	•	•	■	•	•	•	•	•	•	•	•	•	•	•	•	•	•	•	•	•	•	
Reply 466 Series	Base and arm tube	•	•	•	■	•	•	•	•	•	•	•	•	•	•	•	•	•	•	•	•	•	•	
	Frame, outer back, arm caps, and casters	•	•	•	■	•	•	•	•	•	•	•	•	•	•	•	•	•	•	•	•	•	•	
Siento 499 Series	Base and arm supports	•	•	•	•	•	•	•	•	•	•	•	•	•	•	•	•	•	•	•	•	•	•	
Snodgrass 474 Series	Frame	•	•	•	■	•	•	■	•	•	•	•	•	•	•	•	•	•	•	•	•	•	•	
Think 465 Series	Base	•	•	•	■	•	■	•	•	•	•	•	•	•	•	•	•	•	•	•	•	•	•	
	Frame, arm supports and seat shell	•	•	•	■	•	■	•	•	•	•	•	•	•	•	•	•	•	•	•	•	•	•	
	Stool frame and arm supports	•	•	•	■	•	■	•	•	•	•	•	•	•	•	•	•	•	•	•	•	•	•	
	Stool footling	•	•	•	■	•	•	•	•	•	•	•	•	•	•	•	•	•	•	•	•	•	•	
	Stool base	•	•	•	■	•	■	•	•	•	•	•	•	•	•	•	•	•	•	•	•	•	•	

FCS models for Cachet, Criterion, and Drive are available with 6205 Black plastic only.

FCS models for Move are available with 6205 Black or 6249 Platinum Solid plastic only.

FCS models for i2i are available with 6249 Platinum Solid or 6295 Near Black plastic only.

FCS models for node are available with 6205 Black, 6259 Midnight, 6335 Wasabi, or 6336 Jazz only.

Special Features

This chart provides general guidelines about some of the types of special features that are available.

Legend

- = Not available
- = Available
- S = Standard offering
- DO= Available in Design Options
- ▶ See specification pages for details.

	Different fabric on seat and back	Headrest	Sewn seam using vinyl or leather	Thicker seat cushion	Special seat height *	Special seat height base assemblies for field installation	Stool base	Jury base	Glides	Soft roll-control casters (specified with chair/stool)	Field-installed roll-control casters	Braking or reverse braking casters (specified with chair/stool)	Field-installed reverse-braking casters	High-performance arm	Oversized tablet arm	Corporate logo	Narrow arm width
Ally 463 Series	■	•	■	•	•	•	•	S	•	•	•	•	•	•	•	•	•
Amia 482 Series	■	•	S	■	■	•	S	■	S	DO	DO	■	DO	S	•	•	•
Cachet 487 Series	■	•	•	■	■	■	S	■	DO	S	S	DO	DO	•	•	•	•
cobi 434 Series	■	•	S	•	•	•	S	■	S	•	•	■	•	•	•	•	•
Criterion 453 Series	■	•	S	■	DO	■	S	•	S	DO	DO	DO	•	S	•	•	•
Drive 461 Series	■	•	•	•	■	■	■	•	■	•	DO	■	•	S	•	•	•
i2i 416 Series	■	•	•	•	•	•	•	•	S	•	•	•	•	•	•	•	•
Jersey Series	S	•	•	•	■	•	•	■	S	•	•	•	•	•	S	•	•
Leap 462 Series	■	S	S	■	DO	■	S	■	S	DO	DO	■	DO	S	•	■	DO
Leap 464 Series WorkLounge	■	S	•	■	■	•	•	•	S	•	•	•	•	•	•	•	•
Max-Stacker 472	•	•	•	•	•	•	•	•	S	•	•	•	•	•	■	•	•
Max-Stacker II 473 Series	■	•	•	•	•	•	•	•	S	•	•	•	•	•	■	•	•
Move 490 Series	■	•	•	•	•	•	S	•	S	•	•	•	•	•	•	•	•
Player 475 Series	■	•	S	•	•	•	•	•	S	•	•	•	•	•	•	•	•
Protégé 433 Series	•	•	•	■	■	■	■	•	■	■	DO	■	•	•	•	•	•
Reply 466 Series	■	•	•	•	•	■	•	•	S	■	DO	•	•	•	•	•	•
Siento 499 Series	■	■	S	•	■	•	•	•	■	•	•	•	•	■	•	•	•
Snodgrass 474 Series	■	•	•	•	•	•	•	•	S	•	•	•	•	•	•	•	•
Think 465 Series	■	•	•	•	■	•	S	■	DO	S	DO	■	DO	S	•	■	•
Turnstone 1.0																	
à la carte Series	S	•	•	•	•	•	S	■	S	•	•	•	•	•	•	•	•
Crew Series	■	•	S	•	■	•	S	•	S	•	DO	•	•	•	•	•	•
Domino Series	•	•	•	•	•	•	•	•	S	•	•	•	•	•	•	•	•
Executive 319 Series	•	•	•	•	•	•	•	•	•	•	•	•	•	•	•	•	•
Jacket Series	S	•	•	•	•	•	•	•	•	•	•	•	•	•	•	•	•
Jack Series	■	•	•	•	•	•	•	■	S	•	•	•	•	•	•	•	•
Uno Series	S	•	•	•	•	•	S	■	S	•	•	•	•	•	•	•	•

Design Options is a collection of commonly ordered Specials. Products in Design Options have a special quote number already assigned so it's not necessary to go through the normal E-quote process.

For individual quote information, or special requests not listed above, please submit an RFQ request form. The form may be accessed at the following: in2.steelcase.com/specialsrfq

*Maximum seat height is 33".
Minimum seat height is 14½" with 3" travel.

Turnstone 1.0 Seating

Statement of Line	278
--------------------------	------------

Product Details	
Seating Dimensions	281
Seating Mechanisms and Adjustability Features Defined	288
Adjustability Overview	289

Specifying	
Performance Seating	
Crew	292
Jacket	298
Jack Task Chairs	300
à la carte	302
Executive 319	306
Multipurpose/Guest Seating	
Uno	308
Domino	310

Surface Materials	314
--------------------------	------------

This specification guide contains multiple Steelcase and Turnstone product lines which are designed into one specification guide for your convenience. Note that each product may be subject to different pricing terms and conditions.

Statement of Line

Seating

Crew



Task Chair with Arms
▶ Page 292



Task Chair without Arms
▶ Page 292



Stool with Arms
▶ Page 292



Stool without Arms
▶ Page 292



Guest Chair with Arms
▶ Page 294



Guest Chair without Arms
▶ Page 294

Jacket



Desk Chair
▶ Page 298

Jack



Task Chairs
▶ Pages 300



Armless Task Chair
▶ Pages 300



Stools
▶ Pages 300



Armless Stool
▶ Pages 300

à la carte



Mid-Back Task Chair with Modified Round Back
▶ Page 302



Mid-Back Task Chair with Round Back
▶ Page 302



High-Back Task Chair with Round Back
▶ Page 302



Mid-Back Task Chair with Square Back
▶ Page 302



High-Back Task Chair with Square Back
▶ Page 302



Mid-Back Stool with Modified Round Back
▶ Page 302



Mid- or High-Back Stool with Round Back
▶ Page 302



Mid- or High-Back Stool with Square Back
▶ Page 302



Guest Chair with Round Back
▶ Page 304



Guest Chair with Square Back
▶ Page 304

Executive 319



High-Back Executive Chair
▶ Page 306



Full-Back Executive Chair
▶ Page 306



Guest Chair
▶ Page 307

Uno



Multi-Purpose High-Back Chair
▶ Page 308



Multi-Purpose High-Back Stool
▶ Page 308



Multi-Purpose Mid-Back Chair
▶ Page 308



Multi-Purpose Mid-Back Stool
▶ Page 308

Domino Stack Chair



Stack Chair
▶ Page 310



Cushions for Stack Chair
▶ Pages 311–312

Seating Dimensions

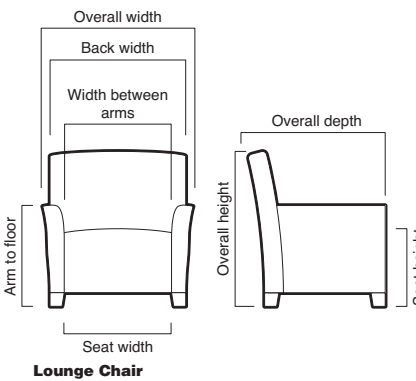
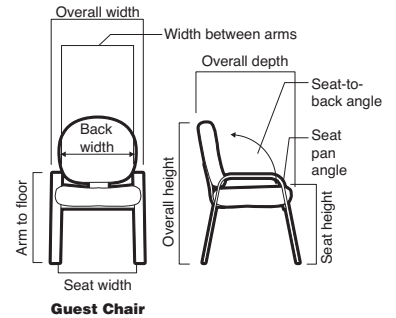
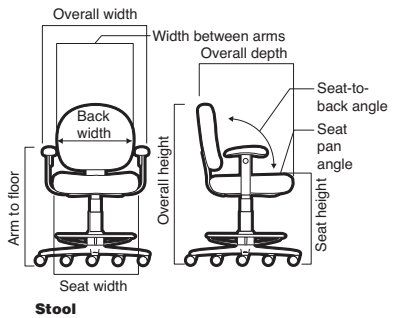
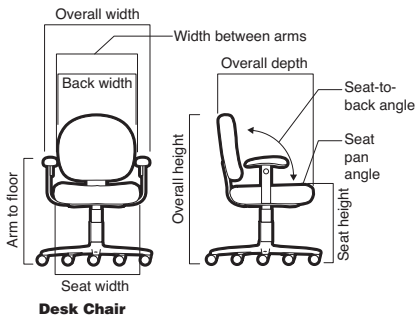

Seating Dimensions, continued



TS30801, TS30802, TS30803
Crew full-back desk chair

Armless

Overall depth	26"
Overall width	26½"
Overall height	39⅝"–44⅝"
Functional seat depth	18"
Functional seat depth on chairs with adjustable seat depth	16⅞"–18⅞"
Seat width	19½"
Seat height from floor	16"–21"
Back width	19"
Back height from seat	21¼"–23½"
Seat pan angle	3°
Angle between seat and back	96°–110°

Stool

Seat height from floor	22¼"–32½"
Foot ring diameter	20"
Foot ring height	7¾"–13¼"



TS30811, TS30812, TS30813, TS30821, TS30822, TS30823, TS30831, TS30832, TS30833
Crew full-back desk chair

With arms

Overall depth	26"
Overall width	26½"
Overall height	39⅝"–44⅝"
Functional seat depth	18"
Functional seat depth on chairs with adjustable seat depth	16⅞"–18⅞"
Seat width	19½"
Seat height from floor	16"–21"
Back width	19"
Back height from seat	21¼"–23½"
Seat pan angle	3°
Angle between seat and back	96°–110°

Fixed-height T-arms

Width between arms	17¾"–19½"
Arm cap width	3½"
Arm cap length	9"
Arm height from seat	9"

Height- and width-adjustable T-arms

Width between arms	17¾"–19½"
Arm cap width	3½"
Arm cap length	9"
Arm height from seat	7"–11"

Height- and width-adjustable pivot T-arms

Width between arms	12¼"–19½"
Arm cap pivot	35°
Arm cap width	4½"
Arm cap length	10"
Arm height from seat	7"–11"

Stool

Seat height from floor	22¼"–32½"
Foot ring diameter	20"
Foot ring height	7¾"–13¼"



TS30805, TS30806
Crew guest chair

Armless

Overall depth	24"
Overall width	23"
Overall height	32"
Functional seat depth	18¼"
Seat width	19"
Seat height from floor	18½"
Back width	20"
Back height from seat	15½"



TS30807, TS30808
Crew guest chair

With arms

Overall depth	24"
Overall width	23"
Overall height	32"
Functional seat depth	18¼"
Seat width	19"
Seat height from floor	18½"
Back width	20"
Back height from seat	15½"
Width between arms	20"
Arm rest width	7/8"
Arm rest length	7⅞"
Arm-to-floor	25"
Arm height from seat	7¼"

**TS31301****Jacket desk chair****Synchro-tilt mechanism**

Overall depth	25"
Overall width	27"
Overall height	37½"-40½"
Functional seat depth	19"
Seat width	20"
Seat height from floor	17½"-20½"
Back width	21½"
Back height from seat	21½"
Width between arms	20"
Arm cap width	3½"
Arm cap length	9½"
Arm height from seat	7½"-9½"
Arm-to-floor	25"-30"
Angle between seat and back	98°-105°

**TS30301, TS30311, TS30321, TS30302, TS30312, TS30322****Jack with swivel-only mechanism**

Overall depth	27¾"
Overall width	27¾"
Overall height	34⅞"-39⅝"
Functional seat depth	17¼"
Seat width	18½"
Seat height from floor	15¾"-20½"
Back width	17½"
Back height from seat	21"
Seat pan angle	2½°
Angle between seat and back	101½°

Arm Options**Fixed height/ user width adjustable T-arms**

Width between arms	18½"-20"
Arm cap width	3½"
Arm cap length	6½"
Arm height from seat	7"-11"

Stool Kit

Overall height	46⅞"-51⅝"
Seat height from floor	21¾"-31½"
Foot ring diameter	20"
Foot ring height	7¾"-13¼"

**TS30303, TS30313, TS30323, TS30304, TS30314, TS30324****Jack with Synchro-tilt mechanism**

Overall depth	27¾"
Overall width	27¾"
Overall height	34⅞"-43¾"
Functional seat depth	17⅞"
Seat width	18½"
Seat height from floor	15¼"-20"
Back width	17½"
Back height from seat	19⅞"-21⅞"
Seat pan angle	-2°
Angle between seat and back	90°-121°

Arm Options**Fixed height/ user width adjustable T-arms**

Width between arms	18½"-20"
Arm cap width	3½"
Arm cap length	6½"
Arm height from seat	9"

Height- and width adjustable T-arms

Width between arms	18½"-20"
Arm cap width	3½"
Arm cap length	6½"
Arm height from seat	7"-11"

**TS30304, TS30314, TS30324****Jack with Synchro-tilt mechanism and seat depth adjustment**

Overall depth	27¾"
Overall width	27¾"
Overall height	35⅞"-43⅞"
Adjustable seat depth	16"-17¾"
Seat width	18½"
Seat height from floor	17¼"-22"
Back width	17½"
Back height from seat	19⅞"-21⅞"
Seat pan angle	1°
Angle between seat and back	94°-111°

Arm Options**Fixed height/ user width adjustable T-arms**

Width between arms	18½"-20"
Arm cap width	3½"
Arm cap length	6½"
Arm height from seat	9"

Height- and width adjustable T-arms

Width between arms	18½"-20"
Arm cap width	3½"
Arm cap length	6½"
Arm height from seat	7"-11"

Seating Dimensions, continued



TS30101
à la carte task chair
Modified round mid-back
Armless

Swivel mechanism

Overall depth	24½"–27"
Overall width	27"
Overall height	32"–39"
Functional seat depth	16½"–18½"
Seat width	20½"
Seat height from floor	15¾"–20¾"
Back width	19¼"
Back height from seat	17"
Seat pan angle	0°
Seat pan angle on chairs with swivel-tilt mechanism	0°–9°
Seat pan angle on chairs with synchro-tilt mechanism	3°–13°
Angle between seat and back	96°
Angle between seat and back on chairs with swivel-tilt mechanism	95°–108°
Angle between seat and back on chairs with synchro-tilt mechanism	95°–115°

Arm Options**Fixed T-arms with curved caps**

Width between arms	18¼"–20¾"
Arm cap width	3"
Arm cap length	8"
Arm height from seat	8½"

Height- and width-adjustable T-arms with curved caps

Width between arms	18¼"–20¾"
Arm cap width	3"
Arm cap length	8"
Arm height from seat	7"–10"

Width-adjustable C-arms

Width between arms	18"–20"
Arm cap width	2¼"
Arm cap length	15"
Arm height from seat	8"

Stool Option

Overall height	37"–49"
Seat height from floor	22½"–32½"
Foot ring diameter	20"
Foot ring height	7½"–15½"



TS30102
à la carte task chair
Round mid-back
Armless

Swivel mechanism

Overall depth	24"–27"
Overall width	27"
Overall height	32"–39"
Functional seat depth	16½"–18½"
Seat width	20½"
Seat height from floor	15¾"–20¾"
Back width	19"
Back height from seat	17"–19"
Seat pan angle	0°
Seat pan angle on chairs with swivel-tilt mechanism	0°–9°
Seat pan angle on chairs with synchro-tilt mechanism	0°–9°
Angle between seat and back	98°
Angle between seat and back on chairs with swivel-tilt mechanism	98°–124°
Angle between seat and back on chairs with synchro-tilt mechanism	100°–134°

Arm Options**Fixed T-arms with curved caps**

Width between arms	18"–20½"
Arm cap width	3"
Arm cap length	8"
Arm height from seat	8"

Height- and width-adjustable T-arms with curved caps

Width between arms	18"–20½"
Arm cap width	3"
Arm cap length	8"
Arm height from seat	7"–10"

Width-adjustable C-arms

Width between arms	18"–20½"
Arm cap width	2¼"
Arm cap length	15"
Arm height from seat	8"

Stool Option

Overall height	37"–49"
Seat height from floor	22½"–32½"
Foot ring diameter	20"
Foot ring height	7½"–15½"



TS30103
à la carte task chair
Round high-back
Armless

Swivel mechanism

Overall depth	24"–27"
Overall width	27"
Overall height	34"–41"
Functional seat depth	16½"–18½"
Seat width	20½"
Seat height from floor	15¾"–20¾"
Back width	19½"
Back height from seat	20"–22"
Seat pan angle	0°
Seat pan angle on chairs with swivel-tilt mechanism	0°–9°
Seat pan angle on chairs with synchro-tilt mechanism	0°–9°
Angle between seat and back	98°
Angle between seat and back on chairs with swivel-tilt mechanism	98°–124°
Angle between seat and back on chairs with synchro-tilt mechanism	100°–134°

Arm Options**Fixed T-arms with curved caps**

Width between arms	18"–20½"
Arm cap width	3"
Arm cap length	8"
Arm height from seat	8"

Height- and width-adjustable T-arms with curved caps

Width between arms	18"–20½"
Arm cap width	3"
Arm cap length	8"
Arm height from seat	7"–10"

Width-adjustable C-arms

Width between arms	18"–20½"
Arm cap width	2¼"
Arm cap length	15"
Arm height from seat	8"

Stool Option

Overall height	37"–49"
Seat height from floor	22½"–32½"
Foot ring diameter	20"
Foot ring height	7½"–15½"



TS30105
à la carte task chair
Square mid-back
Armless

Swivel mechanism

Overall depth	24"–27"
Overall width	27"
Overall height	32"–39"
Functional seat depth	16½"–18½"
Seat width	20½"
Seat height from floor	15¾"–20¾"
Back width	19"
Back height from seat	17"–19"
Seat pan angle	0°
Seat pan angle on chairs with swivel-tilt mechanism	0°–9°
Seat pan angle on chairs with synchro-tilt mechanism	0°–9°
Angle between seat and back	98°
Angle between seat and back on chairs with swivel-tilt mechanism	98°–124°
Angle between seat and back on chairs with synchro-tilt mechanism	100°–134°

Arm Options

Fixed T-arms with curved caps

Width between arms	18"–20½"
Arm cap width	3"
Arm cap length	8"
Arm height from seat	8"

Height- and width-adjustable T-arms with curved caps

Width between arms	18"–20½"
Arm cap width	3"
Arm cap length	8"
Arm height from seat	7"–10"

Width-adjustable C-arms

Width between arms	18"–20½"
Arm cap width	2¼"
Arm cap length	15"
Arm height from seat	8"

Stool Option

Overall height	37"–49"
Seat height from floor	22½"–32½"
Foot ring diameter	20"
Foot ring height	7½"–15½"



TS30106
à la carte task chair
Square high-back
Armless

Swivel mechanism

Overall depth	24"–27"
Overall width	27"
Overall height	34"–41"
Functional seat depth	16½"–18½"
Seat width	20½"
Seat height from floor	15¾"–20¾"
Back width	20"
Back height from seat	20"–22"
Seat pan angle	0°
Seat pan angle on chairs with swivel-tilt mechanism	0°–9°
Seat pan angle on chairs with synchro-tilt mechanism	0°–9°
Angle between seat and back	98°
Angle between seat and back on chairs with swivel-tilt mechanism	98°–124°
Angle between seat and back on chairs with synchro-tilt mechanism	100°–134°

Arm Options

Fixed T-arms with curved caps

Width between arms	18"–20½"
Arm cap width	3"
Arm cap length	8"
Arm height from seat	8"

Height- and width-adjustable T-arms with curved caps

Width between arms	18"–20½"
Arm cap width	3"
Arm cap length	8"
Arm height from seat	7"–10"

Width-adjustable C-arms

Width between arms	18"–20½"
Arm cap width	2¼"
Arm cap length	15"
Arm height from seat	8"

Stool Option

Overall height	37"–49"
Seat height from floor	22½"–32½"
Foot ring diameter	20"
Foot ring height	7½"–15½"

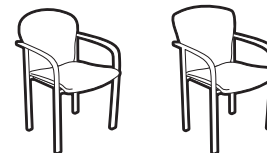

TS30104, TS30107
à la carte guest chair
Mid-back

Overall depth	21"
Overall width	22"
Overall height	32¾"
Functional seat depth	16¼"
Seat width	19"
Seat height from floor	17½"
Back width	19¼"
Back height from seat	18"
Width between arms	19½"
Arm-to-floor	25½"
Arm height from seat	7¾"
Seat pan angle	0°
Angle between seat and back	100°



TS31901
Executive 319 chair
High-back
Swivel-tilt mechanism

Overall depth	29"
Overall width	26"
Overall height	42"–46"
Functional seat depth	19"
Seat width	20"
Seat height from floor	18"–22"
Back width	20"
Back height from seat	24"
Width between arms	21"
Arm cap width	2½"
Arm cap length	13"
Arm-to-floor	26"–30"
Arm height from seat	8"

Seating Dimensions, continued



TS31902
Executive 319 chair
Full-back
Swivel-tilt mechanism

Overall depth	29"
Overall width	26"
Overall height	36"-40"
Functional seat depth	19"
Seat width	20"
Seat height from floor	18"-22"
Back width	20"
Back height from seat	18"
Width between arms	21"
Arm cap width	2 1/2"
Arm cap length	13"
Arm-to-floor	26"-30"
Arm height from seat	8"



TS31903
Executive 319 chair
Guest chair

Overall depth	28 3/8"
Overall width	26"
Overall height	38 3/4"
Functional seat depth	17 3/4"
Seat width	21 7/16"
Seat height from floor	17 1/2"
Back width	21 1/2"
Back height from seat	25 3/8"
Width between arms	21 1/2"
Arm cap width	2 1/2"
Arm cap length	13"
Arm height from seat	10 1/2"



TS31101
Uno multi-purpose chair
Mid-back
Fixed arms
Swivel mechanism

Overall depth	23"
Overall width	25"
Overall height	31 1/2"-36 1/2"
Functional seat depth	19"
Seat width	18 1/4"
Seat height from floor	15 1/2"-20 1/2"
Back width	17 1/2"
Back height from seat	18"
Width between arms	18 1/2"
Arm cap width	3"
Arm cap length	12"
Arm-to-floor	23"-28"
Arm height from seat	7 1/2"
Seat pan angle	5°
Angle between seat and back	92°

Stool Option

Overall height	37 1/2"-45"
Seat height from floor	23 1/2"-33 3/4"
Foot ring diameter	20"
Foot ring height	7 3/4"-13 1/4"



TS31102
Uno multi-purpose chair
High-back
Fixed arms
Swivel mechanism

Overall depth	23"
Overall width	25"
Overall height	34 3/4"-39 3/4"
Functional seat depth	19"
Seat width	18 1/4"
Seat height from floor	15 1/2"-20 1/2"
Back width	18"
Back height from seat	21 1/2"
Width between arms	18 1/2"
Arm cap width	3"
Arm cap length	12"
Arm-to-floor	23"-28"
Arm height from seat	7 1/2"
Seat pan angle	5°
Angle between seat and back	92°

Stool Option

Overall height	41 1/2"-49"
Seat height from floor	23 1/2"-33 3/4"
Foot ring diameter	20"
Foot ring height	7 3/4"-13 1/4"



TS37101

Domino stack chair

Overall depth	20 ¹ / ₂ "
Overall width	20"
Overall height	30"
Functional seat depth	17 ¹¹ / ₁₆ "
Seat width	16 ¹¹ / ₁₆ "
Seat height from floor	17 ⁹ / ₁₆ "
Back width	17 ⁵ / ₁₆ "
Back height from seat	14 ¹ / ₈ "
Stacked 20-high on dolly	62"H x 23"W x 41"D
Stacked 8-high on the floor	39"H x 20"W x 30"D

Seating Mechanisms and Adjustability Features Defined

Seating Mechanisms



Swivel Mechanism
Chair swivels 360°. Seat and back stay in a fixed position (no recline).



Swivel-Tilt Mechanism
Chair swivels 360°. Back and seat recline in unison.



Synchro-Tilt Mechanism
Chair swivels 360°. Back and seat move together but at different angles. For every 2 degrees of back recline, the seat angle tilts 1 degree.

Adjustability Features



Adjustable Back Height
Allows the user to position the back up or down.



Adjustable Foot Ring
Allows the user to position the stool foot ring up or down.



Adjustable Seat Depth
Allows the user to change the distance between the front edge of the seat and the chair back.



Adjustable Seat Depth via the Back
Allows the user to change the distance between the front edge of the seat and the chair back via the maintenance back adjustment.



Lumbar Height Adjustment
Allows the user to raise or lower the lumbar support.



Pneumatic Height Adjustment
Allows the user to raise or lower the chair with one lever from a seated position.



Seat Angle Adjustment
Allows the user to position and lock the seat angle in a variety of positions.



Tilt Tension
Allows the user to vary the amount of recline resistance.



Upright Back Lock
Allows the user to lock the back in the upright position.



Variable Back Stop
Allows the user to stop the back recline at various points.



Variable Back Lock
Allows the user to locate and lock the back in a variety of positions.

Tip: Your chair may not include all the adjustments shown.

Style Reference Number	Number
TS30801	1
TS30802	1
TS30803	1
TS30811	1
TS30812	1
TS30813	1
TS30821	1
TS30822	1
TS30823	1
TS30831	1
TS30832	1
TS30833	1
TS31301	2
TS31901	7
TS31902	7
à la carte	4
à la carte	Options: 5, 6

1 Crew

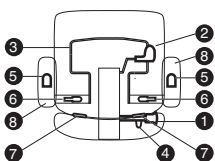

- 1 Tilt tension**
To decrease tension, turn counterclockwise. To increase tension, turn clockwise.
- 2 Pneumatic height adjustment**
To raise chair, lift body weight up and pull lever up. To lower chair, remain seated and pull lever out.
- 3 Adjustable seat depth**
Lift lever up and hold, shift seat forward or back, and release lever to lock. Available on models TS30802, TS30812, and TS30822 only.
- 4 Upright back lock**
To release, lean forward and flip lever up. To lock, lean forward and flip lever down.
- 5 Arm height**
Pull trigger up and hold, pull arm up or push down, and release trigger.
- 6 Arm width**
Push toggle down to release and adjust arms in or out. Push toggle up to lock.
- 7 Back height**
While seated, pull levers inward, raise or lower back into position, and release lever.
- 8 Height-, width-, and pivot-adjustable arm**
Press button under arm caps to adjust height. Grasp arm caps to slide width in and out, and to pivot.

2 Jacket

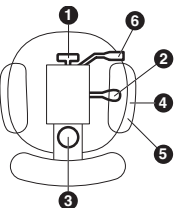

- 1 Tilt tension**
To decrease tension, turn counterclockwise. To increase tension, turn clockwise.
- 2 Pneumatic height adjustment**
To raise chair, lift body weight up and pull lever up. To lower chair, remain seated and pull lever up.
- 3 Adjustable seat depth via the back**
Loosen bolt, adjust back in or out to desired position, and retighten knob.
- 4 Height-adjustable arms**
To raise arm, lift arm to desired height. To lower arm, lift arm to its highest position and then lower to bottom.
- 5 Maintenance width-adjustable arms**
Loosen screws under arm bracket, adjust arm in or out, tighten screws.
- 6 Upright back lock**
To lock back in upright position, lean forward and push lever back. To release back lock, lean forward and push lever forward.

3 Jack

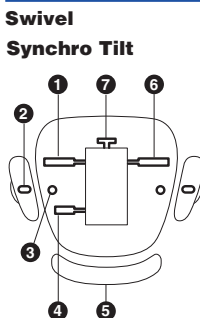

- Swivel**
Synchro Tilt
- 1 Variable back lock**
To adjust back angle, pull lever forward and lean back to desired angle. Push lever back to lock into position. To release for tilt, push lever forward and lean back.
 - 2 Arm height**
Push trigger up and hold, pull arm up or push down and release trigger to lock.
 - 3 Maintenance arm width**
Loosen screws under arm bracket, adjust arm in or out, tighten screws.
 - 4 Adjustable seat depth**
Lift lever up and hold, shift seat forward or back, and release lever to lock.
 - 5 Back height**
Grab chair back with both hands and slowly pull up to desired height. To lower back, pull up to highest position, and back will drop to lowest position. Reset mechanism by pushing down firmly, then adjust upward.
 - 6 Pneumatic seat height**
To raise chair, lift body weight up and pull lever. To lower chair, remain seated and pull lever up.
 - 7 Tilt tension**
To decrease, turn counterclockwise. To increase, turn clockwise.

4 à la carte

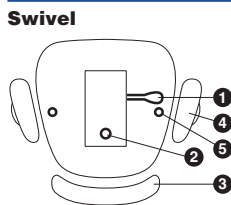

- Swivel**
- 1 Pneumatic height adjustment**
To raise chair, lift body weight up and pull lever up. To lower chair, remain seated and pull lever up.
 - 2 Seat depth adjustment via the back**
Loosen bolt and adjust back in or out to desired position. Retighten bolt.
 - 3 Adjustable back height**
Grab chair back with both hands and slowly pull up to desired height. To lower back, pull up to highest position, and back will drop to lowest position. Reset mechanism by pushing down firmly, then adjust upward.
 - 4 Height-adjustable arms**
Squeeze trigger under arm cap and raise or lower arm to desired height. Release trigger.
 - 5 Maintenance width-adjustable arms**
Loosen screws under arm bracket, adjust arm in or out, tighten screws.

Adjustability Overview, continued

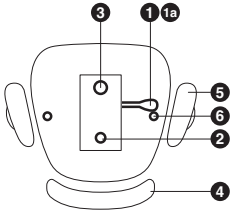
5 à la carte**Swivel Tilt****1 Pneumatic height adjustment**

To raise chair, lift body weight up and pull lever up. To lower chair, remain seated and pull lever up.

1 Upright back lock

While in the upright position, push the lever in and the chair will not tilt; pull it out and the chair can tilt.

2 Seat depth adjustment via the back

Loosen bolt and adjust back in or out to desired position. Retighten bolt.

3 Tilt tension

To decrease tension, turn counterclockwise. To increase tension, turn clockwise.

4 Adjustable back height

Grab chair back with both hands and slowly pull up to desired height. To lower back, pull up to highest position, and back will drop to lowest position. Reset mechanism by pushing down firmly, then adjust upward.

5 Height-adjustable arms

Squeeze trigger under arm cap and raise or lower arm to desired height. Release trigger.

6 Maintenance width-adjustable arms

Loosen screws under arm bracket, adjust arm in or out, tighten screws.

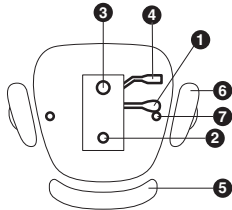
6 à la carte**Synchro Tilt****1 Pneumatic height adjustment**

To raise chair, lift body weight up and pull lever up. To lower chair, remain seated and pull lever up.

2 Seat depth adjustment via the back

Loosen bolt and adjust back in or out to desired position. Retighten bolt.

3 Tilt tension

To decrease tension, turn counterclockwise. To increase tension, turn clockwise.

4 Upright back lock

To lock back in upright position, lean forward and push lever back. To release back lock, lean forward and push lever forward.

5 Adjustable back height

Grab chair back with both hands and slowly pull up to desired height. To lower back, pull up to highest position, and back will drop to lowest position. Reset mechanism by pushing down firmly, then adjust upward.

6 Height-adjustable arms

Squeeze trigger under arm cap and raise or lower arm to desired height. Release trigger.

7 Maintenance width-adjustable arms

Loosen screws under arm bracket, adjust arm in or out, tighten screws.

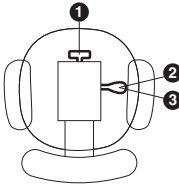
7 Executive 319**1 Tilt tension**

To decrease tension, turn counterclockwise. To increase tension, turn clockwise.

2 Pneumatic height adjustment

To raise chair, lift body weight up and pull lever up. To lower chair, remain seated and pull lever up.

3 Upright back lock

To lock back in upright position, lean forward and push lever in. To release for tilt, lean forward and pull lever out.

Crew

Task Chairs and Stools with Foot Rings



Tip: Hard dual-wheel casters are for use on carpet. Use on hard surfaces, including floor mats, will affect chair stability and may result in personal injury.

Tip: Leather (L suffix) uses a sewn upholstery process on the seat which produces a stitched detail.

Tip: Vinyl specified with a V suffix uses a sewn upholstery process on the seat which produces a stitched detail. Vinyl specified without a suffix is a non-sewn, seamless upholstery process and is available at no additional cost.

Tip: Fire code seating is not available with upholstered outer back option. FCS is only available with standard plastic outer back.

Tip: Arms, if specified, will match base.

Standard Includes	Required to Specify
<ul style="list-style-type: none"> • Synchro-tilt mechanism • Pneumatic seat height • Upright back lock • Tilt tension • Back height adjustment • Upholstered seat and inner back: fabric price group 1 • Outer back: black plastic • Five-arm base: black plastic • Width-adjustable arms, if arms selected: 0835 Black • Adjustable foot ring on stools only: 9201 Polished Chrome • Hard dual-wheel casters: black • Shipped ready to assemble with no tools required • Meets Cal. 116 and 117 requirements 	<ol style="list-style-type: none"> 1 Style number 2 Fabric color number for upholstery 3 Options, if selected (see below) <p>▶ See <i>Surface Materials</i>, page 314.</p>

Options	U.S. Price	Required to Specify
<p>Surface Materials</p> <p>Upholstery</p> <ul style="list-style-type: none"> • Fabric price group 1 No cost • Fabric price group 2 +\$ 22 • Fabric price group 3 +\$ 43 • Fabric price group 4 +\$ 59 • Fabric price group 5 +\$ 75 • Fabric price group 6 +\$ 92 • Fabric price group 7 +\$107 • Fabric price group 8 +\$134 • Fabric price group 9 +\$166 • Fabric price group 10 +\$187 • Leather price group +\$418 <ul style="list-style-type: none"> • Sewn Vinyl +\$ 68 • Customer's Own Material (COM) +\$ 32 • Customer's Own Leather (COL) +\$ 68 • Customer's Own Vinyl (COV) +\$ 68 • Fire Code Seating (FCS) +\$114 <p>Outer back</p> <ul style="list-style-type: none"> • Upholstered outer back +\$ 90 <p>Base on task chairs</p> <ul style="list-style-type: none"> • Aluminum base: 4799 Platinum +\$ 57 		<p>Specify fabric color number.</p> <p>Specify fabric color number.</p> <p>Specify fabric color number.</p> <p>Specify fabric color number.</p> <p>Specify fabric color number.</p> <p>Specify fabric color number.</p> <p>Specify fabric color number.</p> <p>Specify fabric color number.</p> <p>Specify fabric color number.</p> <p>Specify fabric color number.</p> <p>Add suffix L to style number and specify leather color number.</p> <p>Add suffix V to style number and specify vinyl color number.</p> <p>▶ See <i>Understanding Customer's Own Material (COM)</i>, page 324.</p> <p>Add suffix L to style number and specify leather color number.</p> <p>Add suffix V to style number and specify vinyl color number.</p> <p>Add suffix F to style number and specify fabric color number.</p> <p>Add suffix U to the style number.</p> <p>Specify with 4799 Platinum.</p> <p>Specify with soft casters.</p> <p>Specify with glides.</p>
<p>Casters</p> <ul style="list-style-type: none"> • Soft dual-wheel casters for use on hard floors No cost 		
<p>Glides</p> <ul style="list-style-type: none"> • Non-marring plastic glides +\$ 26 		



For Canadian Pricing
 Multiply U.S. Price by the Canadian price factor.
 ▶ See page 1 for details.

Specification Information

Style Number	U.S. Base Price
--------------	-----------------



Tip: Arms, if specified, will match base.

Full-Back Task Chairs

Armless

TS30801 \$537

With Fixed-Height T-Arms

TS30811 \$617

With Height- and Width-Adjustable T-Arms

TS30821 \$650

With Height-, Width-, and Pivot-Adjustable Arms

TS30831 \$707



Tip: Arms, if specified, will match base.

Full-Back Task Chairs with Seat Depth

Armless

TS30802 \$598

With Fixed-Height T-Arms

TS30812 \$678

With Height- and Width-Adjustable T-Arms

TS30822 \$711

With Height-, Width-, and Pivot-Adjustable Arms

TS30832 \$768



Tip: Arms and base available in black only.

Full-Back Task Stools

Armless

TS30803 \$679

With Fixed-Height T-Arms

TS30813 \$759

With Height- and Width-Adjustable T-Arms

TS30823 \$792

With Height-, Width-, and Pivot-Adjustable Arms

TS30833 \$849



For Canadian Pricing
 Multiply U.S. Price by the Canadian price factor.
 ▶ See page 1 for details.

Guest Chairs



Tip: Hard dual-wheel casters are for use on carpet. Use on hard surfaces, including floor mats, will affect chair stability and may result in personal injury.

*Tip: When specifying wood back and leather seat, specify suffix **W** before suffix **L**. Example: TS30805WL.*

*Tip: When specifying wood back and vinyl seat, specify suffix **W** before suffix **V**. Example: TS30806WV.*

Standard Includes	Required to Specify
<ul style="list-style-type: none"> • Upholstered seat and back: fabric price group 1 • Steel four-leg frame: 7207 Black • Hard dual-wheel casters or glides: black • Shipped fully assembled • Stacks four high • Meets Cal. 116 and 117 requirements 	<ol style="list-style-type: none"> 1 Style number 2 Fabric color number for upholstery 3 Options, if selected (see below) <p>▶ See <i>Surface Materials</i>, page 314.</p>

Surface Materials	Options	U.S. Price	Required to Specify
	Single upholstery fabric		
	• Fabric price group 1	No cost	Specify fabric color number.
	• Fabric price group 2	+\$ 22	Specify fabric color number.
	• Fabric price group 3	+\$ 43	Specify fabric color number.
	• Fabric price group 4	+\$ 59	Specify fabric color number.
	• Fabric price group 5	+\$ 75	Specify fabric color number.
	• Fabric price group 6	+\$ 92	Specify fabric color number.
	• Fabric price group 7	+\$107	Specify fabric color number.
	• Fabric price group 8	+\$134	Specify fabric color number.
	• Fabric price group 9	+\$166	Specify fabric color number.
	• Fabric price group 10	+\$187	Specify fabric color number.
	• Leather price group	+\$398	Specify fabric color number. Add suffix L to style number and specify leather color number.
	• Vinyl	No cost	Add suffix V to style number and specify vinyl color number.
	• Customer's Own Material (COM)	+\$ 32	▶ See <i>Understanding Customer's Own Material (COM)</i> , page 324.
	• Fire Code Seating (FCS)	+\$114	Add suffix F to style number and specify fabric color number.

Upholstery on chair with wood back			
	• Fabric price group 1	No cost	Specify fabric color number.
	• Fabric price group 2	+\$ 10	Specify fabric color number.
	• Fabric price group 3	+\$ 22	Specify fabric color number.
	• Fabric price group 4	+\$ 30	Specify fabric color number.
	• Fabric price group 5	+\$ 37	Specify fabric color number.
	• Fabric price group 6	+\$ 46	Specify fabric color number.
	• Fabric price group 7	+\$ 54	Specify fabric color number.
	• Fabric price group 8	+\$ 68	Specify fabric color number.
	• Fabric price group 9	+\$ 83	Specify fabric color number.
	• Fabric price group 10	+\$ 95	Specify fabric color number.
	• Leather price group	+\$142	Specify fabric color number. Add suffix L to style number and specify leather color number.
	• Vinyl	No cost	Add suffix V to style number and specify vinyl color number.
	• Customer's Own Material (COM)	+\$ 32	▶ See <i>Understanding Customer's Own Material (COM)</i> , page 324.
	• Fire Code Seating (FCS)	+\$114	Specify suffix F to style number and specify fabric color number.

▶ **Options, continued on next page**



For Canadian Pricing
Multiply U.S. Price by the Canadian price factor.
▶ See page 1 for details.

► Options, continued from previous page

Options	U.S. Price	Required to Specify
Surface Materials (continued)	Multiple upholstery fabric	
	• Different fabric on seat and back ► See below and at right.	+ \$ 57 Add suffix M to chair style number and select fabric color number for: 1 Seat 2 Back <i>Example: TS30805M with T015 on seat and T016 on back.</i>
	1 Fabric on seat	
	• Fabric price group 1	No cost
	• Fabric price group 2	+ \$ 10
	• Fabric price group 3	+ \$ 22
	• Fabric price group 4	+ \$ 30
	• Fabric price group 5	+ \$ 37
	• Fabric price group 6	+ \$ 46
	• Fabric price group 7	+ \$ 54
	• Fabric price group 8	+ \$ 68
	• Fabric price group 9	+ \$ 83
	• Fabric price group 10	+ \$ 95
	• Customer's Own Material (COM)	+ \$ 32
	2 Fabric on back	
	• Fabric price group 1	No cost
	• Fabric price group 2	+ \$ 10
	• Fabric price group 3	+ \$ 22
	• Fabric price group 4	+ \$ 30
	• Fabric price group 5	+ \$ 37
	• Fabric price group 6	+ \$ 46
	• Fabric price group 7	+ \$ 54
	• Fabric price group 8	+ \$ 68
	• Fabric price group 9	+ \$ 83
	• Fabric price group 10	+ \$ 95
	• Customer's Own Material (COM)	+ \$ 32
	Frame	
	• Steel frame: 4799 Platinum	+ \$ 26 Specify with 4799 Platinum.
	Back	
	• Wood back	+ \$ 107 Add suffix W to style number and specify wood color number.
Caster	• Soft dual-wheel casters for use on hard floors	No cost Specify with soft casters.

Tip: Arms, if specified, will match frame.

► Specification information, on next page

**For Canadian Pricing**

Multiply U.S. Price by the Canadian price factor.

► See page 1 for details.

► Options, on previous page

Specification Information

• Style • Number	• U.S. • Base • Price

Armless Guest Chairs

With Glides

TS30805	\$334
----------------	-------

With Casters

TS30806	\$363
----------------	-------

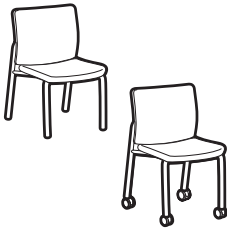

Guest Chairs with Arms

With Glides

TS30807	\$374
----------------	-------

With Casters

TS30808	\$403
----------------	-------

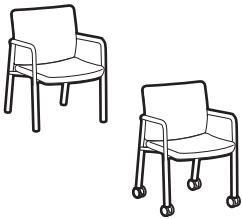

For Canadian Pricing

Multiply U.S. Price by the Canadian price factor.

► See page 1 for details.

Jacket

Desk Chair



Tip: Jacket cover on back is removable. Additional covers can be ordered separately.
 ▶ Page 299

Tip: Hard dual-wheel casters are for use on carpet. Use on hard surfaces, including floor mats, will affect chair stability and may result in personal injury.

Standard Includes	Required to Specify
<ul style="list-style-type: none"> • Synchro-tilt mechanism • Pneumatic height adjustment • Tilt tension • Adjustable seat depth via the back • Height- and maintenance width-adjustable arms • Leather chair • Five-arm base: reinforced black plastic • Hard dual-wheel casters: black • Shipped ready to assemble • Meets Cal. 116 and 117 requirements 	<ol style="list-style-type: none"> 1 Style number 2 Upholstery color number for seat: L305 Brown Leather T802 Black Leather T803 Port Leather 3 Upholstery color number for back: L305 Brown Leather T802 Black Leather T803 Port Leather 4 Options, if selected (see below)

Options	U.S. Price	Required to Specify
Surface Materials <ul style="list-style-type: none"> • Customer's Own Material (COM) on seat • Customer's Own Material (COM) on back 	<ul style="list-style-type: none"> +\$ 16 +\$ 16 	<ul style="list-style-type: none"> ▶ See <i>Understanding Customer's Own Material (COM)</i>, page 324. ▶ See <i>Understanding Customer's Own Material (COM)</i>, page 324.
Base <ul style="list-style-type: none"> • Polished Aluminum base 	<ul style="list-style-type: none"> +\$130 	<ul style="list-style-type: none"> Specify with <i>Polished Aluminum base</i>.
Casters <ul style="list-style-type: none"> • Soft dual-wheel casters for use on hard floors 	<ul style="list-style-type: none"> No cost 	<ul style="list-style-type: none"> Specify with <i>soft casters</i>.

Specification Information	
Style Number	U.S. Base Price
TS31301	\$828

For Canadian Pricing
 Multiply U.S. Price by the Canadian price factor.
 ▶ See page 1 for details.

Jacket Cover



Turnstone 1.0

Standard Includes	Required to Specify
<ul style="list-style-type: none"> Removable back slip-cover Meets Cal. 116 and 117 requirements 	<ul style="list-style-type: none"> 1 Style number 2 Upholstery color number for back: <ul style="list-style-type: none"> L305 Brown Leather T802 Black Leather T803 Port Leather 3 Options, if selected (see below)

Options	U.S. Price	Required to Specify
Surface Materials Upholstery <ul style="list-style-type: none"> Customer's Own Material (COM) on back 	+\$16	<ul style="list-style-type: none"> ▶ See <i>Understanding Customer's Own Material (COM)</i>, page 324.

Specification Information	
Style Number	U.S. Base Price
TS31302	\$150

 **For Canadian Pricing**
 Multiply U.S. Price by the Canadian price factor.
 ▶ See page 1 for details.

Jack Task Chairs

With Synchro-Tilt Mechanism

Tip: Hard dual-wheel casters are for use on carpet. Use on hard surfaces, including floor mats, will affect chair stability and may result in personal injury.

Standard Includes	Required to Specify
<ul style="list-style-type: none"> • Synchro-tilt mechanism • Pneumatic seat height • Tilt tension • Variable back lock • Adjustable back height • Arms: maintenance-width adjustable arms, if specified: black plastic • Upholstered seat and inner back: Fabric price group 1 • Outer back: black plastic • Five arm base: reinforced black plastic • Hard dual-wheel casters: black • Shipped ready to assemble • Meets Cal. 116 and 117 requirements 	<ul style="list-style-type: none"> 1 Style number 2 Fabric color number for upholstery 3 Options, if selected (see below) ▶ See <i>Surface Materials</i>, page 314.

Options	U.S. Price	Required to Specify																																																	
<table border="0"> <tr> <td>Surface Materials</td> <td>Upholstery</td> <td></td> <td></td> </tr> <tr> <td></td> <td>• Fabric price group 1</td> <td>No cost</td> <td>Specify fabric color number.</td> </tr> <tr> <td></td> <td>• Fabric price group 2</td> <td>+\$ 22</td> <td>Specify fabric color number.</td> </tr> <tr> <td></td> <td>• Fabric price group 3</td> <td>+\$ 43</td> <td>Specify fabric color number.</td> </tr> <tr> <td></td> <td>• Fabric price group 4</td> <td>+\$ 59</td> <td>Specify fabric color number.</td> </tr> <tr> <td></td> <td>• Fabric price group 5</td> <td>+\$ 75</td> <td>Specify fabric color number.</td> </tr> <tr> <td></td> <td>• Fabric price group 6</td> <td>+\$ 92</td> <td>Specify fabric color number.</td> </tr> <tr> <td></td> <td>• Fabric price group 7</td> <td>+\$107</td> <td>Specify fabric color number.</td> </tr> <tr> <td></td> <td>• Fabric price group 8</td> <td>+\$134</td> <td>Specify fabric color number.</td> </tr> <tr> <td></td> <td>• Fabric price group 9</td> <td>+\$166</td> <td>Specify fabric color number.</td> </tr> <tr> <td></td> <td>• Fabric price group 10</td> <td>+\$187</td> <td>Specify fabric color number.</td> </tr> <tr> <td></td> <td>• Customer's Own Material (COM)</td> <td>+\$ 32</td> <td>▶ See <i>Understanding Customer's Own Material (COM)</i>, page 324.</td> </tr> </table>	Surface Materials	Upholstery				• Fabric price group 1	No cost	Specify fabric color number.		• Fabric price group 2	+\$ 22	Specify fabric color number.		• Fabric price group 3	+\$ 43	Specify fabric color number.		• Fabric price group 4	+\$ 59	Specify fabric color number.		• Fabric price group 5	+\$ 75	Specify fabric color number.		• Fabric price group 6	+\$ 92	Specify fabric color number.		• Fabric price group 7	+\$107	Specify fabric color number.		• Fabric price group 8	+\$134	Specify fabric color number.		• Fabric price group 9	+\$166	Specify fabric color number.		• Fabric price group 10	+\$187	Specify fabric color number.		• Customer's Own Material (COM)	+\$ 32	▶ See <i>Understanding Customer's Own Material (COM)</i> , page 324.			
Surface Materials	Upholstery																																																		
	• Fabric price group 1	No cost	Specify fabric color number.																																																
	• Fabric price group 2	+\$ 22	Specify fabric color number.																																																
	• Fabric price group 3	+\$ 43	Specify fabric color number.																																																
	• Fabric price group 4	+\$ 59	Specify fabric color number.																																																
	• Fabric price group 5	+\$ 75	Specify fabric color number.																																																
	• Fabric price group 6	+\$ 92	Specify fabric color number.																																																
	• Fabric price group 7	+\$107	Specify fabric color number.																																																
	• Fabric price group 8	+\$134	Specify fabric color number.																																																
	• Fabric price group 9	+\$166	Specify fabric color number.																																																
	• Fabric price group 10	+\$187	Specify fabric color number.																																																
	• Customer's Own Material (COM)	+\$ 32	▶ See <i>Understanding Customer's Own Material (COM)</i> , page 324.																																																
Casters	• Soft dual-wheel casters for use on hard floors	No cost	Specify with soft casters.																																																
Glides	• Non-marring plastic glides	+\$ 26	Specify with glides.																																																

Tip: The a la carte square-back guest chair, TS30107, complements the Jack task chairs.



Specification Information	
Style Number	U.S. Base Price

Full-Back Task Chair with Synchro-tilt

Armless	
TS30303	\$400
With Fixed-Height and Maintenance-Width T-arms	
TS30313	\$478
With Height-Adjustable and Maintenance-Width T-arms	
TS30323	\$514

Full-Back Task Chair with Synchro-tilt and Seat Depth

Armless	
TS30304	\$462
With Fixed-Height and Maintenance-Width T-arms	
TS30314	\$540
With Height-Adjustable and Maintenance-Width T-arms	
TS30324	\$576

 **For Canadian Pricing**
 Multiply U.S. Price by the Canadian price factor.
 ▶ See page 1 for details.

à la carte

Task Chairs



Tip: Arms are not included with à la carte chairs unless you specify one of the arm options.

Tip: Hard dual-wheel casters are for use on carpet. Use on hard surfaces, including floor mats, will affect chair stability and may result in personal injury.

Tip: Bolt under seat allows for adjustable seat depth via the back.

Tip: When specifying multiple COM fabrics, indicate all surfaces where COM applies.

Example: TS30101M with Designtex 1234 on seat and Designtex 5678 on back



For Canadian Pricing
Multiply U.S. Price by the Canadian price factor.
▶ See page 1 for details.

Standard Includes	Required to Specify
-------------------	---------------------

- Swivel mechanism
- Pneumatic height adjustment
- Adjustable seat depth via the back
- Upholstered seat, back, and outer back: fabric price group 1
- Five-arm base: reinforced black plastic
- Hard dual-wheel casters: black
- Shipped ready to assemble
- Meets Cal. 116 and 117 requirements

- 1 Style number
- 2 Fabric color number for upholstery
- 3 Options, if selected (see below)
- ▶ See *Surface Materials*, page 314.

Options	U.S. Price	Required to Specify
---------	------------	---------------------

Surface Materials

Single upholstery fabric

- | | |
|---------------------------------|---------|
| • Fabric price group 1 | No cost |
| • Fabric price group 2 | +\$ 22 |
| • Fabric price group 3 | +\$ 43 |
| • Fabric price group 4 | +\$ 59 |
| • Fabric price group 5 | +\$ 75 |
| • Fabric price group 6 | +\$ 92 |
| • Fabric price group 7 | +\$107 |
| • Fabric price group 8 | +\$134 |
| • Fabric price group 9 | +\$166 |
| • Fabric price group 10 | +\$187 |
| • Customer's Own Material (COM) | +\$ 32 |
| • Fire Code Seating (FCS) | +\$114 |

- Specify fabric color number.
- Specify fabric color number.
- Specify fabric color number.
- Specify fabric color number.
- Specify fabric color number.
- Specify fabric color number.
- Specify fabric color number.
- Specify fabric color number.
- Specify fabric color number.
- Specify fabric color number.
- ▶ See *Understanding Customer's Own Material (COM)*, page 324.
- Add suffix **F** and specify fabric color number.

Multiple upholstery fabrics

- Different fabric on seat and back
- ▶ See below.

Add suffix **M** to chair style number and select fabric color number for:

- ① Seat
- ② Back

Example: TS30101M with T015 on seat and T016 on back.

① Fabric on seat

- | | |
|---------------------------------|---------|
| • Fabric price group 1 | No cost |
| • Fabric price group 2 | +\$ 10 |
| • Fabric price group 3 | +\$ 22 |
| • Fabric price group 4 | +\$ 30 |
| • Fabric price group 5 | +\$ 37 |
| • Fabric price group 6 | +\$ 46 |
| • Fabric price group 7 | +\$ 54 |
| • Fabric price group 8 | +\$ 68 |
| • Fabric price group 9 | +\$ 83 |
| • Fabric price group 10 | +\$ 95 |
| • Customer's Own Material (COM) | +\$ 16 |
| • Fire Code Seating (FCS) | +\$ 57 |

- Specify fabric color number.
- Specify fabric color number.
- Specify fabric color number.
- Specify fabric color number.
- Specify fabric color number.
- Specify fabric color number.
- Specify fabric color number.
- Specify fabric color number.
- Specify fabric color number.
- Specify fabric color number.
- ▶ See *Understanding Customer's Own Material (COM)*, page 324.
- Add suffix **F** and specify fabric color number.



② Fabric on back

- | | |
|---------------------------------|---------|
| • Fabric price group 1 | No cost |
| • Fabric price group 2 | +\$ 10 |
| • Fabric price group 3 | +\$ 22 |
| • Fabric price group 4 | +\$ 30 |
| • Fabric price group 5 | +\$ 37 |
| • Fabric price group 6 | +\$ 46 |
| • Fabric price group 7 | +\$ 54 |
| • Fabric price group 8 | +\$ 68 |
| • Fabric price group 9 | +\$ 83 |
| • Fabric price group 10 | +\$ 95 |
| • Customer's Own Material (COM) | +\$ 16 |
| • Fire Code Seating (FCS) | +\$ 57 |

- Specify fabric color number.
- Specify fabric color number.
- Specify fabric color number.
- Specify fabric color number.
- Specify fabric color number.
- Specify fabric color number.
- Specify fabric color number.
- Specify fabric color number.
- Specify fabric color number.
- Specify fabric color number.
- ▶ See *Understanding Customer's Own Material (COM)*, page 324.
- Add suffix **F** and specify fabric color number.

▶ **Options, continued on next page**

► Options, continued from previous page

Options	U.S. Price	Required to Specify
Adjustable Back Height <ul style="list-style-type: none"> Adjustable back height on chair without modified backs 	+\$ 42	Specify with adjustable back height.
Seating Mechanism <ul style="list-style-type: none"> Swivel-tilt: tilt, tilt tension, and upright back lock Synchro-tilt: tilt, tilt tension, and upright back lock 	+\$ 69 +\$137	Specify with swivel-tilt. Specify with synchro-tilt.
Fixed T-Arms  Curved	+\$ 81	Specify with fixed T-arms with curved arm caps.
Height- and Maintenance Width-Adjustable T-Arms  Curved	+\$125	Specify with height- and width-adjustable with curved arm caps.
Maintenance Width-Adjustable C-Arms <ul style="list-style-type: none"> Width-adjustable C-arms: black only 	+\$116	Specify with width-adjustable C-arms.
Stool Kit <ul style="list-style-type: none"> Stool kit available on chairs with standard swivel mechanism only. Not available on chairs with optional seating mechanisms. Includes taller pneumatic height and chrome foot ring. 	+\$139	Specify with stool kit.
Casters <ul style="list-style-type: none"> Soft, dual-wheel casters for use on hard floors 	No cost	Specify with soft casters.
Glides <ul style="list-style-type: none"> Non-marring plastic glides 	No cost	Specify with glides.

Arm Options

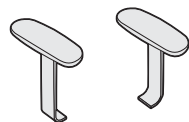

Fixed T-arms

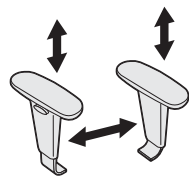

Height- and width-adjustable T-arms

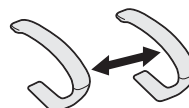

Width-adjustable C-arms

Tip: Adjustable back height option is not available on TS30101.

Specification Information

Style Number	U.S. Base Price

Modified Round-Back Task Chair

Mid-Back	
TS30101	\$290

Round-Back Task Chairs

Mid-Back	
TS30102	\$304
High-Back	
TS30103	\$373

Square-Back Task Chairs

Mid-Back	
TS30105	\$304
High-Back	
TS30106	\$373



Guest Chairs



Standard Includes **Required to Specify**

- Mid-back
- Steel four-leg frame with open arms: 7207 Black
- Upholstered seat, back, and outer back: fabric price group 1
- Glides: plastic
- Shipped fully assembled
- Chairs can stack four high
- Meets Cal. 116 and 117 requirements

- 1 Style number
- 2 Fabric color number for upholstery
- 3 Options, if selected (see below)
- ▶ See *Surface Materials*, page 314.

Options **U.S. Price** **Required to Specify**

Surface Materials

Single upholstery fabric

- Fabric price group 1 No cost
- Fabric price group 2 +\$ 22
- Fabric price group 3 +\$ 43
- Fabric price group 4 +\$ 59
- Fabric price group 5 +\$ 75
- Fabric price group 6 +\$ 92
- Fabric price group 7 +\$107
- Fabric price group 8 +\$134
- Fabric price group 9 +\$166
- Fabric price group 10 +\$187
- Customer's Own Material (COM) +\$ 32
- Fire Code Seating (FCS) +\$114

- Specify fabric color number.
- Specify fabric color number.
- Specify fabric color number.
- Specify fabric color number.
- Specify fabric color number.
- Specify fabric color number.
- Specify fabric color number.
- Specify fabric color number.
- Specify fabric color number.
- Specify fabric color number.
- ▶ See *Understanding Customer's Own Material (COM)*, page 324.
- Add suffix **F** and specify fabric color number.

Multiple upholstery fabrics

- Different fabric on seat and back +\$ 57
- ▶ See below.

- Add suffix **M** to chair style number and select fabric color number for:
- 1 Seat
- 2 Back
- Example: TS30104M with T015 on seat and T016 on back.

1 Fabric on seat

- Fabric price group 1 No cost
- Fabric price group 2 +\$ 10
- Fabric price group 3 +\$ 22
- Fabric price group 4 +\$ 30
- Fabric price group 5 +\$ 37
- Fabric price group 6 +\$ 46
- Fabric price group 7 +\$ 54
- Fabric price group 8 +\$ 68
- Fabric price group 9 +\$ 83
- Fabric price group 10 +\$ 95
- Customer's Own Material (COM) +\$ 16
- Fire Code Seating (FCS) +\$ 57

- Specify fabric color number.
- Specify fabric color number.
- Specify fabric color number.
- Specify fabric color number.
- Specify fabric color number.
- Specify fabric color number.
- Specify fabric color number.
- Specify fabric color number.
- Specify fabric color number.
- Specify fabric color number.
- ▶ See *Understanding Customer's Own Material (COM)*, page 324.
- Add suffix **F** and specify fabric color number.

2 Fabric on back

- Fabric price group 1 No cost
- Fabric price group 2 +\$ 10
- Fabric price group 3 +\$ 22
- Fabric price group 4 +\$ 30
- Fabric price group 5 +\$ 37
- Fabric price group 6 +\$ 46
- Fabric price group 7 +\$ 54
- Fabric price group 8 +\$ 68
- Fabric price group 9 +\$ 83
- Fabric price group 10 +\$ 95
- Customer's Own Material (COM) +\$ 16
- Fire Code Seating (FCS) +\$ 57

- Specify color number.
- Specify color number.
- Specify fabric color number.
- Specify fabric color number.
- Specify fabric color number.
- Specify fabric color number.
- Specify fabric color number.
- Specify fabric color number.
- Specify fabric color number.
- Specify fabric color number.
- ▶ See *Understanding Customer's Own Material (COM)*, page 324.
- Add suffix **F** and specify fabric color number.

*Tip: When specifying multiple COM fabrics, indicate all surfaces where COM applies.
Example: TS30104M with Designtex 1234 on seat and Designtex 5678 on back*

For Canadian Pricing
Multiply U.S. Price by the Canadian price factor.
▶ See page 1 for details.

Specification Information

• Style • Number	• U.S. • Base • Price
---------------------	-----------------------------



Round-Back Guest Chair

TS30104	\$317
---------	-------



Square-Back Guest Chair

TS30107	\$317
---------	-------



For Canadian Pricing
 Multiply U.S. Price by the
 Canadian price factor.
 ▶ See page 1 for details.

Executive 319

Executive Chairs

Tip: The black plastic arms and black leather on the seat and back are not an exact match to Steelcase colors.

Tip: Hard dual-wheel casters are for use on carpet. Use on hard surfaces, including floor mats, will affect chair stability and may result in personal injury.

Tip: Soft dual-wheel casters are available through Service Parts (TS30486SR).

Tip: Executive 319 chairs require complete assembly.



Standard Includes	Required to Specify
<ul style="list-style-type: none"> • Swivel-tilt mechanism • Tilt tension • Upright back lock • Pneumatic height adjustment • Plastic open arms: black • Leather on seat and back and simulated leather on balance of chair: L304 Black • Five-arm base: reinforced black plastic • Hard dual-wheel casters: black • Shipped ready to assemble • Meets Cal. 116 and 117 requirements 	<p>Style number</p>

Specification Information

• Style Number	• U.S. Price

High-Back Executive Chair

TS31901	\$589

Full-Back Executive Chair

TS31902	\$564



For Canadian Pricing

Multiply U.S. Price by the Canadian price factor.

▶ See page 1 for details.

Guest Chair



Tip: Executive 319 chairs require complete assembly.

Standard Includes	Required to Specify
<ul style="list-style-type: none"> • Plastic open arms: black • Leather on seat and back and simulated leather on balance of chair: black • Sled base frame: black • Shipped fully assembled • Meets Cal. 116 and 117 requirements 	Style number

Specification Information	
• Style Number	• U.S. Price
TS31903	\$552



For Canadian Pricing
 Multiply U.S. Price by the Canadian price factor.
 ▶ See page 1 for details.

Uno

Multi-Purpose Chairs



Tip: Frame is available in black only.

Tip: Hard dual-wheel casters are for use on carpet. Use on hard surfaces, including floor mats, will affect chair stability and may result in personal injury.

Tip: FCS is not available on Uno high-back chairs (TS31102).

Tip: Always add suffixes in alphabetical order when specifying options to Uno seating.

Tip: When specifying multiple COM fabrics, indicate all surfaces where COM applies.

Example: TS31101M with Designtex 1234 on seat and Designtex 5678 on back

Standard Includes	Required to Specify
<ul style="list-style-type: none"> • Hammock-style support • Swivel mechanism • Pneumatic height adjustment • Upholstered seat and back: fabric price group 1 • Outer back: black plastic • Five-arm base: reinforced black plastic • Hard dual-wheel casters: black • Stool ring, if selected: black paint • Shipped ready to assemble with no tools required • Meets Cal. 116 and 117 requirements 	<ul style="list-style-type: none"> 1 Style number 2 Fabric color number for upholstery 3 Options, if selected (see below) ▶ See <i>Surface Materials</i>, page 314.

Surface Materials	Options	U.S. Price	Required to Specify
	Single upholstery fabric		
	<ul style="list-style-type: none"> • Fabric price group 1 • Fabric price group 2 • Fabric price group 3 • Fabric price group 4 • Fabric price group 5 • Fabric price group 6 • Fabric price group 7 • Fabric price group 8 • Fabric price group 9 • Fabric price group 10 • Leather price group • Customer's Own Material (COM) • Customer's Own Leather (COL) • Fire Code Seating (FCS) 	<ul style="list-style-type: none"> No cost +\$ 22 +\$ 43 +\$ 59 +\$ 75 +\$ 92 +\$107 +\$134 +\$166 +\$187 +\$241 +\$ 32 +\$ 54 +\$114 	<ul style="list-style-type: none"> Specify fabric color number. Specify fabric color number. Specify fabric color number. Specify fabric color number. Specify fabric color number. Specify fabric color number. Specify fabric color number. Specify fabric color number. Specify fabric color number. Specify fabric color number. Specify leather color number. ▶ See <i>Understanding Customer's Own Material (COM)</i>, page 324. Specify leather color number.
	Multiple upholstery fabric		
	<ul style="list-style-type: none"> • Different fabric on seat and back 	<ul style="list-style-type: none"> +\$ 57 	<ul style="list-style-type: none"> Add suffix F to the style number.
	① Fabric on seat		
	<ul style="list-style-type: none"> • Fabric price group 1 • Fabric price group 2 • Fabric price group 3 • Fabric price group 4 • Fabric price group 5 • Fabric price group 6 • Fabric price group 7 • Fabric price group 8 • Fabric price group 9 • Fabric price group 10 • Leather price group • Customer's Own Material (COM) • Customer's Own Leather (COL) 	<ul style="list-style-type: none"> No cost +\$ 10 +\$ 22 +\$ 30 +\$ 37 +\$ 46 +\$ 54 +\$ 68 +\$ 83 +\$ 95 +\$121 +\$ 16 +\$ 27 	<ul style="list-style-type: none"> Add suffix M to chair style number and select fabric color number for: ① Seat ② Back Example: TS31101M with T015 on seat and T016 on back. Specify fabric color number. Specify fabric color number. Specify fabric color number. Specify fabric color number. Specify fabric color number. Specify fabric color number. Specify fabric color number. Specify fabric color number. Specify fabric color number. Specify leather color number. ▶ See <i>Understanding Customer's Own Material (COM)</i>, page 324. Specify leather color number.

▶ Options, continued on next page



For Canadian Pricing

Multiply U.S. Price by the Canadian price factor.

▶ See page 1 for details.

► Options, continued from previous page

Options	U.S. Price	Required to Specify	
Surface Materials (continued)	② Fabric on back <ul style="list-style-type: none"> Fabric price group 1 Fabric price group 2 Fabric price group 3 Fabric price group 4 Fabric price group 5 Fabric price group 6 Fabric price group 7 Fabric price group 8 Fabric price group 9 Fabric price group 10 Leather price group Customer's Own Material (COM) Customer's Own Leather (COL) 	No cost +\$ 10 +\$ 22 +\$ 30 +\$ 37 +\$ 46 +\$ 54 +\$ 68 +\$ 83 +\$ 95 +\$121 +\$ 16 +\$ 27	Specify fabric color number. Specify fabric color number. Specify fabric color number. Specify fabric color number. Specify fabric color number. Specify fabric color number. Specify fabric color number. Specify fabric color number. Specify fabric color number. Specify fabric color number. Specify leather color number. ► See <i>Understanding Customer's Own Material (COM)</i> , page 324. Specify leather color number.
Stool Kit	<ul style="list-style-type: none"> Stool kit with swivel mechanism 	+\$174	Specify <i>with stool kit</i> .
Casters	<ul style="list-style-type: none"> Soft dual-wheel casters for use on hard floors 	No cost	Specify <i>with soft casters</i> .
Glides	<ul style="list-style-type: none"> Non-marring plastic glides 	+\$ 26	Specify <i>with glides</i> .

Specification Information

• Style
• Number
•

• U.S.
• Base
• Price
•

Mid-Back Multi-Purpose Chair

TS31101 \$486



High-Back Multi-Purpose Chair

TS31102 \$565



 **For Canadian Pricing**
 Multiply U.S. Price by the Canadian price factor.
 ► See page 1 for details.

Domino

Stack Chairs

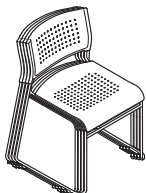

Tip: The black plastic seat and black paint frame on Domino stack chair are not an exact match to Steelcase finishes.

Standard Includes	Required to Specify
<ul style="list-style-type: none"> • Frame: black • Shell: 6205 Black plastic • Glides: plastic • Package of four • Shipped fully assembled • Stacks 20 high on a dolly • Stacks 8 high on the floor 	<p>Style number</p>

Related Products
<ul style="list-style-type: none"> • Seat and back cushions ▶ Page 311 • Seat cushions ▶ Page 312 • Transport and storage dolly ▶ Page 312

Specification Information	
• Style Number	• U.S. Price

Package of Four Chairs

TS37101	\$452

For Canadian Pricing
 Multiply U.S. Price by the Canadian price factor.
 ▶ See page 1 for details.

Seat and Back Cushions



Standard Includes	Required to Specify
<ul style="list-style-type: none"> • Package of four seat and four back cushions: fabric price group 1 • Hardware package to attach cushions to chair • Meets Cal. 116 and 117 requirements • Ships ready to assemble 	<ol style="list-style-type: none"> 1 Style number 2 Fabric color number for seat and back cushions 3 Options, if selected (see below) <p>▶ See <i>Surface Materials</i>, page 314.</p>

Options	U.S. Price	Required to Specify
<p>Surface Materials</p>		
<p>Upholstery</p> <ul style="list-style-type: none"> • Fabric price group 1 • Fabric price group 2 • Fabric price group 3 • Fabric price group 4 • Fabric price group 5 • Fabric price group 6 • Fabric price group 7 • Fabric price group 8 • Fabric price group 9 • Fabric price group 10 • Leather price group • Customer's Own Material (COM) 	<p>No cost</p> <p>+\$ 41</p> <p>+\$ 95</p> <p>+\$134</p> <p>+\$175</p> <p>+\$214</p> <p>+\$255</p> <p>+\$321</p> <p>+\$401</p> <p>+\$456</p> <p>+\$428</p> <p>+\$ 32</p>	<p>Specify fabric color number.</p> <p>Specify fabric color number.</p> <p>Specify fabric color number.</p> <p>Specify fabric color number.</p> <p>Specify fabric color number.</p> <p>Specify fabric color number.</p> <p>Specify fabric color number.</p> <p>Specify fabric color number.</p> <p>Specify fabric color number.</p> <p>Specify fabric color number.</p> <p>Specify leather color number.</p> <p>▶ See <i>Understanding Customer's Own Material (COM)</i>, page 324</p>

Specification Information	
• Style Number	• U.S. Base Price
.....

Package of Four Seat and Four Back Cushions

TS37102	\$420
.....



For Canadian Pricing
 Multiply U.S. Price by the Canadian price factor.
 ▶ See page 1 for details.

Seat Cushions



Standard Includes	Required to Specify
<ul style="list-style-type: none"> • Package of four seat cushions: fabric price group 1 • Hardware package to attach cushions to chair • Meets Cal. 116 and 117 requirements • Ships ready to assemble 	1 Style number 2 Fabric color number for seat cushions 3 Options, if selected (see below) ▶ See <i>Surface Materials</i> , page 314.

		Options	U.S. Price	Required to Specify
Surface Materials	Upholstery	• Fabric price group 1	No cost	Specify fabric color number.
		• Fabric price group 2	+\$ 25	Specify fabric color number.
		• Fabric price group 3	+\$ 57	Specify fabric color number.
		• Fabric price group 4	+\$ 80	Specify fabric color number.
		• Fabric price group 5	+\$105	Specify fabric color number.
		• Fabric price group 6	+\$129	Specify fabric color number.
		• Fabric price group 7	+\$153	Specify fabric color number.
		• Fabric price group 8	+\$192	Specify fabric color number.
		• Fabric price group 9	+\$241	Specify fabric color number.
		• Fabric price group 10	+\$274	Specify fabric color number.
		• Leather price group	+\$257	Specify leather color number.
		• Customer's Own Material (COM)	+\$ 32	▶ See <i>Understanding Customer's Own Material (COM)</i> , page 324

Specification Information	
• Style Number	• U.S. Base Price
.....

Package of Four Seat Cushions

TS37104	\$256
.....

Transport and Storage Dolly

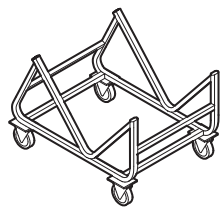

Standard Includes	Required to Specify
<ul style="list-style-type: none"> • Transport and storage dolly: black paint only • Stores 20 Domino stack chairs 	Style number

Specification Information	
• Style Number	• U.S. Price
.....

TS37103	\$348
.....

For Canadian Pricing
 Multiply U.S. Price by the Canadian price factor.
 ▶ See page 1 for details.

Turnstone 1.0

Surface Materials

Surface Materials	314
Seating Upholstery Matrix	320
Seating Upholstery Matrix Turnstone Collection by Designtex	321
Fire Code Seating Upholstery Matrix	322
Fire Code Seating Upholstery Turnstone Collection by Designtex	323
Understanding Customer's Own Material (COM)	324
Maintenance and Cleaning	326

Surface Materials

► For Surface Materials matrices for all product lines, see page 313.

Paint

Steelcase Surfaces

Applies to:
• Crew guest chair
7207 Black

Applies to:
• Crew arms
0835 Black **E**

Applies to:
• Crew base, arms, and frame
4799 Platinum Metallic

Plastic

Steelcase Surfaces

Applies to:
• Domino stack chair
• Crew task chair outer back and base
6205 Black

Wood

Steelcase Surfaces

Applies to:
• Crew guest wood back
3412 Natural Cherry **E**
3522 Clear Maple
3762 Dark Walnut

Tip: Due to natural variations in wood, finished products may vary in color, texture and grain.

Upholstery

Steelcase Surfaces

Not every upholstery is available on every chair. Please refer to the upholstery matrix on page 320 before specifying.

Price Group 1

Buzz2
Jacks
Link
Playground
Seating Vinyl

Tip: Established finishes are available for delivery in 15 business days.

E = Established

Price Group 2

Cogent: Connect
Cogent: Geode Seating
Cogent: Geode Vertical
Cogent: Trails
Cricket
Crosswalk
Nitelights
Regis2
Spyder
Zoe2

Price Group 3

Cogent: Tides
Hampstead

Price Group 5

Bo Peep

Price Group 6

Brisa

Leather Price Group

Steelcase Surfaces

Applies to:
• Crew, Domino, and Uno
L107 Black
L202 Dusk
L203 Bottle
L207 Mahogany
L220 Soapstone
L221 Rocky
L224 Plum
L500 Camel
L503 Navy
L507 Vineyard

Turnstone Leather

Steelcase Surfaces

Applies to:
• Jacket
L305 Brown
T802 Black
T803 Port

Applies to:
• Executive 319
L304 Black

Turnstone Collection by Designtex

Designtex and Turnstone partnered to create an exclusive collection of affordable seating textiles that offer fresh and exciting designs.

This collection of textiles is stocked and available in standard lead-time. Fabrics are supported just like standard fabrics, which makes ordering easy. This program is supported by a swatch card that presents the entire offering. The swatch card is available to order through ad-stock # 08-0000726.

Price Group 3

Boyne - 3280
Great Lakes - 3282
Ludington - 3285

Price Group 4

Glen Arbor - 3283
Leland - 3281
Saugatuck - 3284

Select Surfaces

For information on products within Select Surfaces, including accent paints and fabrics from Designtex, Maharam, and Pollack, please refer to the *Surface Materials Reference Manual* or visit Steelcase.com/selectsurfaces.

Custom Surfaces

Customers' Own Material (COM) Program

The Customers' Own Material (COM) program offers the opportunity for customers to select fabrics that are not offered through the standard Steelcase surface materials program for use on Steelcase products. Once approved, you can place your order. Steelcase will facilitate the entire ordering process and give you a production schedule. Steelcase will order the COM fabric directly from the textile manufacturer. For up-to-date information regarding fabric test results for all COM fabrics and details regarding yardage requirements for most seating lines, visit the COM website on www.steelcase.com. COMs are not covered under the Steelcase warranty.

Soil Retardants

Soil retardants are treatments that provide long-term soil and stain resistance to a fabric without affecting the shade or the integrity of the fabric. The following Steelcase Textiles and Turnstone Collection by Designtex fabrics are available pre-treated with soil retardant:

- Boyne
- Glen Arbor
- Jacks
- Link
- Saugatuck
- Spyder

For information on soil retardant fabrics on select surfaces, please refer to the *Surface Materials Reference Manual*.

Seating Upholstery Steelcase Surfaces

Tip: All Steelcase Textiles Price Group 3 upholstery requires an additional leadtime of two or more weeks.

Bo Peep

Price Group 5

5G66 Pita	5G77 Grapevine
5G67 Bone	5G78 Firefly
5G68 Safari	5G79 Artichoke
5G69 Brown Sugar	5G80 Serpent
5G70 Chocolate Chip	5G81 Carolina
5G71 Candlelight	5G82 Blue Bonnet
5G72 Honey Mustard	5G83 Nautical
5G73 Marmalade	5G84 Gravel
5G74 Picnic	5G85 Sharkskin
5G75 Pinot	5G86 Kohl
5G76 Bloom	

Boyne - 3280

Price Group 3

T925 Sand	T930 Peridot
T926 Bark	T931 Plum
T927 Bittersweet	T932 Comet
T928 Brick	T933 Boulder
T929 Navy	

Brisa

Price Group 6

BR01 Black Onyx	BR14 Pompeian Red
BR04 Truffle	BR15 Salsa
BR06 Ash	BR16 Cinnabar
BR07 Sage	BR17 Aztec
BR08 Celery	BR18 New Sand
BR09 Sterling Blue	BR19 Cream
BR10 Night Navy	BR20 White
BR11 Cambridge Blue	BR21 Moccasin
BR12 Abyss	BR22 Buckskin
BR13 Canyon	BR23 Prairie

Buzz2

Price Group 1

5F01 Camel E	5G52 Barley
5F03 Tomato	5G53 Sunrise
5F04 Red E	5G54 Carrot
5F05 Burgundy	5G55 Pumpkin
5F06 Sky E	5G56 Timber
5F07 Blue	5G57 Rouge
5F08 Navy	5G58 Chocolate
5F10 Grape E	5G59 Meadow
5F11 Eggplant E	5G60 Ivy
5F15 Stone	5G61 Cyan
5F16 Grey	5G62 Atlantic
5F17 Black	5G63 Crocus
5G50 Dunegrass	5G64 Alpine
5G51 Sable	5G65 Tornado

Cogent: Connect

Price Group 2

5S15 Coconut	5S26 Licorice
5S16 Turmeric	5S27 Malt
5S17 Tangerine	5S28 Root Beer
5S18 Scarlet	5S93 Blueprint
5S19 Concord	5S94 Lizard
5S20 Maya Blue	5S95 Sailor
5S21 Blue Jay	5S96 Quicksilver
5S22 Basil	5S97 Nugget
5S23 Wasabi	5S98 Canary
5S24 Nickel	5S99 Lipstick
5S25 Graphite	

Cogent: Geode Seating

Price Group 2

5S46 Bark	5S52 Pear
5S47 Coal	5S53 Berry
5S48 Smoke	5S54 Mandarin
5S49 Cobalt	5S55 Sunset
5S50 Ink	5S56 Citrus
5S51 Shamrock	5S57 Thunder

Cogent: Geode Vertical

Price Group 2

5S31 Pebble	5S38 Oyster
5S32 Canyon	5S39 Buff
5S33 Honey	5S40 Toast
5S34 Ice	5S41 Sesame
5S35 Slate	5S42 Ecru
5S36 Cement	5S43 Dove
5S37 Rock	

Surface Materials, continued

Cogent: Tides

Price Group 2

5S71 Butter	5S78 Clay
5S72 Snow	5S79 Hyacinth
5S73 Celery	5S80 Jet
5S74 Wicker	5S81 Doe
5S75 Pool	5S82 Boysenberry
5S76 Cloud	5S83 Night
5S77 Grass	

Cogent: Trails

Price Group 2

5S29 Bronzite	5S88 Quartz
5S30 Amethyst	5S89 Carnelian
5S84 Jasper	5S90 Tiger Eye
5S85 Agate	5S91 Travertine
5S86 Lapis	5S92 Topaz
5S87 Malachite	

Cricket

Price Group 2

5A84 Plum	5A91 Spearmint
5A85 Camel	5A92 Sky
5A86 Charcoal	5A93 Midnight
5A87 Black	5A95 Ocean
5A90 Currant	5A96 Forest

Crosswalk

Price Group 2

5F48 Beech	5F53 Persimmon
5F49 Moon	5F54 Bittersweet
5F50 Berry	5F55 Midnight
5F51 Admiral Blue	5F56 Poppy
5F52 Moss	

Glen Arbor - 3283

Price Group 4

T945 Sand	T949 Plum
T946 Bark	T950 Comet
T947 Iris	T951 Boulder
T948 Green Stone	

Great Lakes - 3282

Price Group 3

T935 Sand	T939 Peridot
T936 Bark	T940 Mountain
T937 Iris	T941 Comet
T938 Green Stone	

E = Established

Hampstead

Price Group 3

B351 Blue Green V4 E	B427 Turquoise
B359 Blue Blue Green V5 E	B428 Navy
B366 Blue Blue Violet V4 E	B429 Charcoal
B369 Blue Blue Violet V5 E	B430 Spa
B377 Violet V5 E	B431 Plum
B389 Red Red Violet V5 E	B432 Cocoa
B395 Grey V5 E	B433 Cork
B399 Black	B434 Stone
B406 Windflower E	B435 Metal
B413 Shale E	B436 Peridot
B423 Clementine	B437 Cactus
B424 Butter Cream	B438 Sycamore
B425 Iris	B439 Candy Apple
B426 Sapphire	

Jacks

Price Group 1

5B61 Taupe	5B66 Plum
5B63 Camel	5B70 Midnight
5B64 Pewter	

Leland - 3281

Price Group 4

T955 Birch	T960 Apple
T956 Sand	T961 Wild Flower
T957 Frost	T962 Plum
T958 Comet	T963 Lake
T959 Bark	T964 Peridot

Link

Price Group 1

5A20 Burgundy	5A26 Purple
5A21 Rust	5A27 Black
5A23 Green	5A28 Ocean
5A24 Blue	5A29 Lichen
5A25 Navy	5A30 Chamois

Ludington - 3285

Price Group 3

T965 Putty	T972 Earth
T966 Dune	T973 Cobblestone
T967 Walnut	T974 Fog
T968 Cloud	T975 Midnight
T969 Chocolate	T976 Wood Smoke
T970 Red Clay	T977 Gray Quartz
T971 Canyon	T978 Ink

Nitelights

Price Group 2

5F58 Hazelnut	5F63 Moss
5F59 Burgundy	5F64 Sea
5F60 Cherry	5F65 Regal Blue
5F61 Earth	5F66 Stone
5F62 Shore	5F67 Moon

Playground

Price Group 1

5F28 Claret	5F33 Stone
5F29 Chile	5F34 Sky
5F30 Amber	5F35 Navy
5F31 Nut	5F36 Huckleberry
5F32 Blade	5F37 Charcoal

Regis2

Price Group 2

5F18 Black	5F26 Cherry
5F24 Pacific	5F27 Navy

Saugatuck - 3284

Price Group 4

T915 White Pine	T920 Green Stone
T916 Bark	T921 Comet
T917 Sand	T922 Boulder
T918 Apple	T923 Plum
T919 Navy	

Spyder [®]

Price Group 2

5B00 Orchid	5B07 Sage
5B01 Foggy Night	5B09 Topaz
5B04 Peri	5B11 Currant
5B05 Merlot	5B12 Lichen
5B06 Dove	

Zoe2

Price Group 2

5C90 Eggplant	5C95 Rain
5C91 Aloe	5C96 Grey Flannel
5C92 Fiddle	5C97 Pebble
5C93 Patina	5C98 Cymbal
5C94 Peacock	5C99 Fiesta

[®] = Established**Select Surfaces**

For information on products within Select Surfaces, including accent paints and fabrics from Designtex, Maharam, and Pollack, please refer to the *Surface Materials Reference Manual* or visit Steelcase.com/selectsurfaces.

Please refer to the Steelcase COM database on Steelcase.com for the most current application information.

Leather**Steelcase Surfaces****Turnstone Leather**

L304 Black
L305 Brown
T802 Black
T803 Port

Leather

Price Group Leather

L107 Black	L221 Rocky
L202 Dusk	L224 Plum
L203 Bottle	L500 Camel
L207 Mahogany	L503 Navy
L220 Soapstone	L507 Vineyard

Seating Vinyl**Steelcase Surfaces****Seating Vinyl**

Price Group 1

5801 Topaz	5815 Seaside
5805 Foggy Night	5817 Pebble
5809 Black	5818 Spice
5810 Forest	5819 Thistle
5812 Navy	5820 Coffee
5813 Currant	5822 Iris

Surface Materials, continued

Finish Code 59DF

Price Group 6

Acacia - 2843	Kenaf - 2859
Agave - 2847	Kenaf w/o Crypton - 2859u
Alistair - 2992	Klange - 2741
Allure - 2756	Knockabout - 3326
Amaranth w/o Crypton - 2855u	Laureate - 2774
Amuse - 2767	Palace - H254
Arlington - 2724	Pivot - 3374
Banda - 3227	Pueblo - 2844
Barnsbury - 2726	Quintessence - 3347
Bottle Bank - 2869	React - 2861
Cassava - 2838	Rice - 2858
Chicory - 2993	Rough & Ready - 2016
Circolo - 3229	Salvage - 2867
Converge - 2873	Seed - 2839
Copa - 2641	Senna - 2848
Coupe - H245	Sequence - 2742
Dahlia - 2995	Sock Hop - 3298
Décor - H244	Soda Pop - 2868
Dot to Dot - 2691	Square - 2788
Downtown - 2029	Swing Set - 2421
Epiphany - 2734	Tangent - 2875
Faconne - 2764	Tartan - 2994
Friendly Faux w/Knit Backing - 2008	Teddy - H236
Griglia - 3231	Terrain - 2846
Hula Hoop - 3297	Transpose - 2874
	Tumbleweed - 2845

Finish Code 59DG

Price Group 7

Amaranth - 2855	Inertia - 3235
Baratto - 3266	Juxtaposition - 2744
Battista - 2718	Kaleidoscope - 2863
Beam - 2785	Lorien - H201
Bon Bon - 2749	Minuet - 2656
Calm - 2768	Oscillate - 3238
Cestino - 3270	Point - 2783
Chakin - 7146	Razor Stripe - 2857
Coperta - 3228	Samba - 2654
Drive-In - 3299	Samba Otra Vez - 2885
Dwell - 2850	Spiro - 3237
Faux Sure w/Knit Backing - 3351	Sundance - 3278
Flux - 3239	Uptown - 2024
Fuse w/Knit Backing - 3362	Ziggurat - 2827
Garden Key - 3252	

Finish Code 59DH

Price Group 8

Biba - H216	Nexus - 3236
Chandelier - 7354	Polygon - 2883
Circumference - 2884	Thumbnail Sketch - 2841
Facets - 7350	Titanium - 2842
Honor Plus - 2547	Valanka - 3279
Hue - 2710	Torsade - 7358
Maglia - 3233	Wire - 2743

E = Established

Finish Code 59DJ

Price Group 9

Bangles - 7352	Gramercy - 2599
Belvedere - 3275	Hofburg - 3276
Gotham - 2390	Yorkshire - 2771

Finish Code 59DK

Price Group 10

Chalet - 3290	Migration w/Knit Backing - 3373
Kanthas - H238	Shimmering Tide
Links - 7353	w/Knit Backing - 3369
Lolland - 3263	Tumble Stones
Metamorphosis	w/Knit Backing - 3371
w/Knit Backing - 3367	Wood Work w/Knit Backing - 3372

Select Surfaces Pollack Seating Upholstery

► See *Surface Materials Reference Manual* for information about the Select Surfaces Program.

Pattern numbers are listed below. For specific color availability, visit pollackassociates.com.

Please refer to the Steelcase COM database on Steelcase.com for the most current application information.

Price Group 5 - Finish Code 59DE

Rewrite - 2304

Price Group 7 - Finish Code 59DG

Beadwork - 4123

Journey - 4121

Spice Market - 4128

Sumatra - 2291

Price Group 8 - Finish Code 59DH

Glyph Matelasse - 2305

Nest - 2329

Squirt - 2348

Price Group 9 - Finish Code 59DJ

Amazement - 2338

Bull's Eye - 2225

Louis - 2264

Microcosm - 2315

Mod - 2242

Quarry Stones - 2308

Volute - 2313

Price Group 10 - Finish Code 59DK

Glyph Velvet - 5058

Select Surfaces

For information on products within **Select Surfaces**, including accent paints and fabrics from Designtex, Maharam, and Pollack, please refer to the *Surface Materials Reference Manual* or visit Steelcase.com/selectsurfaces.

Please refer to the Steelcase COM database on Steelcase.com for the most current application information.

Leather

Steelcase Surfaces

Turnstone Leather

- L304** Black
- L305** Brown
- T802** Black
- T803** Port

Leather

Price Group Leather

- | | |
|-----------------------|----------------------|
| L107 Black | L221 Rocky |
| L202 Dusk | L224 Plum |
| L203 Bottle | L500 Camel |
| L207 Mahogany | L503 Navy |
| L220 Soapstone | L507 Vineyard |

Seating Vinyl

Steelcase Surfaces

Seating Vinyl

Price Group 1

- | | |
|-------------------------|---------------------|
| 5801 Topaz | 5815 Seaside |
| 5805 Foggy Night | 5817 Pebble |
| 5809 Black | 5818 Spice |
| 5810 Forest | 5819 Thistle |
| 5812 Navy | 5820 Coffee |
| 5813 Currant | 5822 Iris |
| 5814 Leaf | |

Seating Upholstery Matrix

	Price Group	á la carte - Task	á la carte - Guest	Crew - Task, Plastic Back	Crew - Task, Upholstered Back	Crew - Guest, Upholstered Back	Crew - Guest, Wood Back	Domino	Executive 319 Series	Jack Task Chairs	Jacket	Pedestal Seat Cushion	Uno	Uno - High Back
Bo Peep	5	■	■	■	■	■	■	■	●	■	■	■	■	■
Brisa	6	■	■	■	●	■	■	■	●	■	■	■	■	■
Buzz2	1	■	■	■	■	■	■	■	●	■	■	■	■	■
Cogent: Connect	2	■	■	■	■	■	■	■	●	■	■	■	■	■
Cogent: Geode Seating	2	●	●	■	■	●	●	■	●	■	■	■	■	■
Cogent: Geode Vertical	2	●	●	■	■	●	●	■	●	■	■	■	■	■
Cogent: Tides	3	●	●	■	■	■	■	■	●	■	■	■	■	■
Cogent: Trails	2	■	■	■	■	■	■	■	●	■	■	■	■	■
Cricket	2	■	■	■	■	■	■	■	●	■	■	■	■	■
Crosswalk	2	■	■	■	■	■	■	■	●	■	■	■	■	■
Hampstead	3	■	■	■	■	■	■	■	●	■	■	■	■	■
Jacks	1	■	■	■	■	■	■	■	●	■	■	■	■	■
Turnstone Leather	NA	●	●	●	●	●	●	●	●	●	■	●	●	●
Steelcase Leather	L	■	■	■	■	■	■	■	●	●	■	■	■	■
Mastrotto Leather	NA	●	●	●	●	●	●	■	●	●	●	●	●	●
Link	1	■	■	■	■	■	■	■	●	■	■	■	■	■
Nitelights	2	■	■	■	■	■	■	■	●	■	■	■	■	■
Playground	1	■	■	■	■	■	■	■	●	■	■	■	■	■
Regis2	2	■	■	■	■	■	■	■	●	■	■	■	■	■
Seating Vinyl	1	■	■	■	●	■	■	■	●	●	●	●	■	■
Spyder ^E	2	■	■	■	■	■	■	■	●	■	●	■	■	■
Stand In	2	■	■	■	■	■	■	■	●	■	●	■	■	■
Zoe2	2	■	■	■	■	■	■	■	●	■	■	■	■	■

Legend

- = Not available
- = Available
- = Available with exceptions
- (with grid) = COM approved
- ^E = Established
- ▶ See *Surface Materials* and *Specifying* pages.

Products that are missing from the matrix are not available with these surface materials.

Seating Upholstery Matrix Turnstone Collection by Designtex



	Price Group	á la carte - Task	á la carte - Guest	Crew - Task, Plastic Back	Crew - Task, Upholstered Back	Crew - Guest, Upholstered Back	Crew - Guest, Wood Back	Domino	Executive 319 Series	Jack Task Chairs	Jacket	Pedestal Seat Cushion	Uno	Uno - High Back
Boyne	3	■	■	■	■	■	■	■	●	■	■	■	■	■
Glen Arbor	4	■	■	■	■	■	■	■	●	■	■	■	■	■
Great Lakes	3	■	■	■	■	■	■	■	●	■	■	■	■	■
Leland	4	■	■	■	■	■	■	■	●	■	■	■	■	■
Ludington	2	■	■	■	●	■	■	■	●	●	●	●	■	■
Saugatuck	4	■	■	■	■	■	■	■	●	■	■	■	■	■

Surface Materials

- Legend**
- = Not available
 - = Available
 - = Available with exceptions
 - ▣ = COM approved
 - ▶ See *Surface Materials* and *Specifying* pages.

Fire Code Seating Upholstery Matrix

Cal. 133 is the highest flame retardance rating available on Turnstone brand seating products. It means that an article is manufactured for use in public occupancies and meets the flammability requirements of California Bureau of Home Furnishings Technical Bulletin, etc.

All Turnstone upholstery fabrics pass Cal. 116 and 117 requirements.

	Price Group	á la carte - Task	á la carte - Guest	Crew - Task, Plastic Back	Crew - Task, Upholstered Back	Crew - Guest, Upholstered Back	Crew - Guest, Wood Back	Domino	Executive 319 Series	Jack Task Chairs	Jacket	Pedestal Seat Cushion	Uno	Uno - High Back
Bo Peep	5	☐	☐	☐	☐	☐	☐	•	•	•	•	•	■	•
Brisa	6	☐	☐	☐	•	☐	☐	•	•	•	•	•	☐	•
Buzz2	1	■	■	■	☐	■	■	•	•	•	•	•	■	•
Cogent: Connect	2	■	■	■	•	■	■	•	•	•	•	•	■	•
Cogent: Geode Seating	2	•	•	■	☐	•	•	•	•	•	•	•	■	•
Cogent: Geode Vertical	2	•	•	■	☐	•	•	•	•	•	•	•	■	•
Cogent: Tides	3	•	•	■	☐	☐	☐	•	•	•	•	•	■	•
Cogent: Trails	2	■	■	■	☐	■	■	•	•	•	•	•	■	•
Cricket	2	■	■	■	☐	■	■	•	•	•	•	•	■	•
Crosswalk	2	■	■	■	☐	■	■	•	•	•	•	•	■	•
Hampstead	3	■	☐	☐	☐	☐	☐	•	•	•	•	•	■	•
Jacks	1	■	☐	■	☐	☐	☐	•	•	•	•	•	■	•
Turnstone Leather	NA	•	•	•	•	•	•	•	•	•	•	•	•	•
Steelcase Leather	L	•	•	☐	☐	☐	☐	•	•	•	•	•	☐	•
Mastrotto Leather	NA	•	•	•	•	•	•	•	•	•	•	•	•	•
Link	1	☐	☐	■	☐	☐	☐	•	•	•	•	•	■	•
Nitelights	2	■	■	■	☐	■	■	•	•	•	•	•	■	•
Playground	1	■	■	■	☐	■	■	•	•	•	•	•	■	•
Regis2	2	■	■	☐	☐	■	■	•	•	•	•	•	■	•
Seating Vinyl	1	■	■	■	•	■	■	•	•	•	•	•	☐	•
Spyder [Ⓢ]	2	☐	☐	■	☐	☐	☐	•	•	•	•	•	■	•
Stand In	2	☐	☐	☐	•	☐	☐	•	•	•	•	•	☐	•
Zoe2	2	■	■	■	☐	■	■	•	•	•	•	•	■	•

Legend

- = Not available
- = Available
- ☐ = Available with exceptions
- ☐ = Untested
- Ⓢ = Established
- ▶ See *Surface Materials* and *Specifying* pages

Fire Code Seating Upholstery Turnstone Collection by Designtex

Fire Code Seating Upholstery Turnstone Collection by Designtex

	Price Group	á la carte - Task	á la carte - Guest	Crew - Task, Plastic Back	Crew - Task, Upholstered Back	Crew - Guest, Upholstered Back	Crew - Guest, Wood Back	Domino	Executive 319 Series	Jack Task Chairs	Jacket	Pedestal Seat Cushion	Uno	Uno - High Back
Boyne	3	☐	☐	☐	☐	☐	☐	•	•	•	•	•	☐	•
Glen Arbor	4	☐	☐	☐	☐	☐	☐	•	•	•	•	•	☐	•
Great Lakes	3	■	■	■	☐	■	■	•	•	•	•	•	■	•
Leland	4	■	■	■	☐	■	■	•	•	•	•	•	■	•
Ludington	2	☐	☐	☐	•	☐	☐	•	•	•	•	•	☐	•
Saugatuck	4	☐	☐	☐	☐	☐	☐	•	•	•	•	•	☐	•

Surface Materials

Legend

- = Not available
- = Available
- ☐ = Available with exceptions
- ☐ = Untested
- ▶ See *Surface Materials* and *Specifying* pages

Understanding Customer's Own Material (COM)

The Customer's Own Material (COM) program allows customers to select textiles that are not offered through the standard Surface Materials program for use on Turnstone products.

The COM process consists of seven steps: COM Web Site, Testing/Approval, Steelcase to Purchase Service, Pricing, Cutting Direction, Yardage Requirements, and the Purchase Orders.

COM Web Site

- COM Web site features application test results for all COM, Designtex Graded-In, Options Collection and Classics Collection fabrics. The Web site allows you to calculate yardage requirements for most Turnstone seating and systems products.
- Access the COM Web site at: www.steelcase.com.
- Or call 1.888.STEELCASE (1.888.783.3522) or send an e-mail to lineone@steelcase.com.

Application Testing/Approval

- Confirm that the selected COM has been tested and approved for application on a specific product by checking the COM Web site at: www.steelcase.com.

COM Application Testing or "approved for application" means the COM fabric has been reviewed for manufacturability using the standard manufacturing techniques to achieve acceptable appearance per Steelcase quality standards.

COM fabric performance, including durability, pilling, color fastness, stretch, splitting, fraying, etc. is not tested by Steelcase. Therefore, COMs are not covered by the Steelcase Warranty. Each COM vendor is responsible for all warranty claims related to fabric performance.

Steelcase reserves the right to reject or reverse any COM approval that does not meet the manufacturing requirements in actual production. COM approval may be rejected or reversed because not all application testing is based on actual production conditions and because some materials vary in fabrication.

- If the COM is approved, you may continue the order process.
- If the COM has failed, you must reselect a fabric.
- If the COM is not listed, that means Steelcase has not tested that fabric on our products.

Helpful hint: Seating vinyl and leather do not require testing. Customer's own vinyl is available on all seating products that accept Steelcase standard vinyl.

- If your material has not been tested, then send yardage (4.5 yards for seating, 2 yards for vertical surfaces) and submit a completed COM Application Testing Request form to:
Steelcase Inc.
Attn: COM Testing
Door 305
4060 Eastern Avenue
Grand Rapids, MI 49508
- To ensure rapid processing, please use the electronic COM Application Testing Request form found on the COM Web site under the "How To Test" tab **or** fax a copy of the COM Testing Request form from the *Surface Materials Reference Manual* to 616.698.4700. **All information on the form is required in order to complete testing. COM tests cannot be performed if information is incomplete. Contact your requested fabric vendor for any missing information.**
- Test results will be returned (by fax or e-mail) in four working days from receipt of fabric and completed form.

COM materials that are approved for application to panel systems might require UL approval after application test approval. UL approval does involve fees and extended lead times.

All vertical surface COMs tested and approved with a content of 100% polyester meet a minimum of class C/UL1286. If class A or B fire rating is indicated, a burn test must be performed. All vertical surface COMs with a blended fabric construction require a UL burn test. For further UL information, contact a COM Consultant at 616.475.2426.

Steelcase to Purchase Service

The COM program also includes a service to purchase approved COM for our customers for use on Turnstone products. Steelcase will facilitate the ordering, scheduling and shipment of COM directly from the suppliers. There are no additional charges for this service.

Steelcase is the only party that may purchase COM for all Turnstone products.

In some instances, not all colors in a fabric family are approved. You will be informed of these instances before Steelcase purchases the fabric.

If for some reason the fabric must be ordered directly from the supplier, contact your Steelcase Solutions Fulfillment Team Representative for approval and instructions prior to purchase. The only time the customer can purchase fabric is for testing.

COM Pricing

- Confirm COM is tested and approved.
- Use the COM or COL (Customer's Own Leather) price group found under Surface Materials Options within each product spec guide.
- Calculate yardage required by using the COM Calculator found on the COM Web site at www.steelcase.com.
- Or call 1.888.STEELCASE (1.888.783.3522) or send an e-mail to lineone@steelcase.com.
Helpful tip: Fabric width, repeat and product quantity and style number are required in order to calculate yardage accurately.
- Add the cost of the fabric to the COM or COL price group.
- The cost of the COM will be shown as a separate line on the acknowledgement.

COM vendors require fabric purchases in half or full yard increments. Therefore, Steelcase will round all final yardage calculations to the half yard.

COL (Customer's Own Leather) is calculated by the square foot, but purchased in hide. The customer is responsible for purchasing the minimum hide requirement.

Base price of chair includes standard fabrics. Steelcase will not allow credit or deduct the cost of the standard fabric when a COM fabric is selected in its place.

Steelcase cannot be held responsible for costs incurred when a COM supplier ships a COM fabric that does not meet Steelcase application standards or for costs incurred for late deliveries when a COM supplier commits to shipping a COM fabric for manufacturing by a specific date and misses that date.

COM Warranty

Steelcase standard warranty does not apply to Designtex or any other COM vendor's fabric.

- Designtex and other COM suppliers are responsible for color consistency within commercial tolerances, abrasion resistance, UV stability, and resistance to soiling and perspiration. These fabrics or vinyls are subject to policies regarding appearance, behavior, and durability that have been established by the fabric supplier. The customer's remedy for a fabric defect is limited to the replacement of the fabric by the supplier. Durability, performance, and fabric defects of COM fabrics are not guaranteed by Steelcase.

Cutting Direction

SEATING:

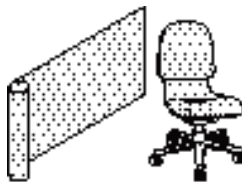

Warp horizontal

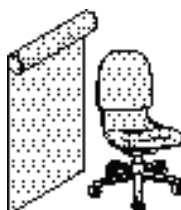

Warp vertical

- Dealers must specify fabric application direction on all COM orders.**
- COMs for seating are most often applied in the warp vertical (downroll, woven way) direction. Some exceptions include patterns with stripes, fabrics that are sampled in the warp horizontal (railroad, across roll) direction, and solid vinyls.
- ▶ See Cutting Direction Guidelines in the *Surface Materials Reference Manual* for more information.

VERTICAL SURFACES:

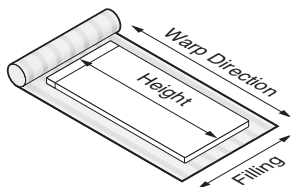

Warp vertical

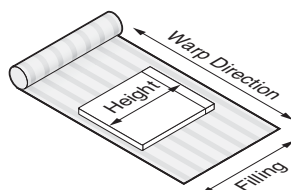

Warp horizontal

- Dealers must specify fabric application direction on all COM orders.**

- The cutting direction of COMs on vertical surfaces varies by product and sometimes by style number. Please check the COM Web site for the approved cutting direction for your particular COM.

▶ See Cutting Direction Guidelines in the *Surface Materials Reference Manual* for more information.

Steelcase cannot guarantee pattern repeat match from product to product. Steelcase also cannot guarantee pattern repeat match within each product listed. (i.e., seat and back, arms to back, etc.)

COM Yardage Requirements

- For the most accurate yardage requirements, visit the Calculator found on the COM Web site or call 1.888.STEELCASE (1.888.783.3522) or send an e-mail to lineone@steelcase.com.
- The Calculator on the COM Web site provides the same yardage requirements used by Steelcase purchasing.

Yardage requirements will change depending on:

- width of fabric
- fabric repeat
- cutting direction
- product style number
- quantity of products being manufactured

- COM vinyl requires upholstery in the railroad cutting direction. Please visit our Web site or call 1.888.STEELCASE (1.888.783.3522) or send an e-mail to lineone@steelcase.com for yardage requirements.
- Certain fabric treatments and backings require additional yardage or yardage minimums. Please contact the supplier for specific information.
- COM fabric vendors require fabric purchases in half- or full-yard increments, and the Steelcase COM calculator will automatically round all final yardage calculations to the half yard.
- Steelcase is the only party who may purchase COMs.

Maintenance and Cleaning

Inspecting and cleaning. Have your chair's upholstery, finishes, controls, base, and other moving parts inspected and cleaned at least once a year.

Cleaning painted and plastic surfaces. Finishes should be cleaned with water and/or a non-abrasive cleaner (such as Formula 409® and Fantastik®).

Maintaining upholstery. Use a vacuum cleaner for regular cleaning. Periodic professional dry cleaning is recommended. Do not steam clean.

Removing excess stains or heavy soil. Soak up excess stain with a cloth. Do not dry the stain completely or it may set. For most water-soluble stains (coffee, fruit juice, washable ink), use an upholstery cleaning solution (such as Bissell® upholstery shampoo or Guardsman Fabri-Kleen® products) and follow directions on package. For oil-borne stains, use a dry cleaning solution at room temperature (never hot) and let solution work into the stain. Use quick, light strokes to brush the stain with a soft bristle brush. Work from outside toward the center to prevent rings. Soak up remaining dry cleaning solution, then sponge the fabric with cool water. Let fabric dry completely; then vacuum thoroughly. If stain is still visible, repeat procedure. Several light applications of cleaning solution are more effective and less damaging than one heavy application.

Formula 409 is a registered trademark of Clorox company. Fantastik is a registered trademark of Dow Consumer Products, Inc. Fabri-Kleen is a registered trademark of Guardsman Chemical. All other marks are marks of their respective owners.

Resources

Style Number Index

328

Resources

Style Number Index

Style Number	Page	Description
416911	192	i2i 416 Work Chair
416911T	192	i2i 416 Work Chair/Tab
4331203	145	Protégé 433 Work Chair
4331223	145	Protégé 433 Work Chair
4331403	145	Protégé 433 Work Chair
4331423	145	Protégé 433 Work Chair
4333003	147	Protégé 433 Guest Chair
4333023	147	Protégé 433 Guest Chair
4335023	148	Protégé 433 Sled-Base Guest Chair
434110	183	cobi 434 Work Chair
434111	183	cobi 434 Work Chair/Arm
434710	185	cobi 434 Work Stool
434711	185	cobi 434 Work Stool/Arm
4535300	159	Criterion 453 MidBk Work Chair
4535300D	159	Criterion 453 MidBk Work Chair
4535301	157	Criterion 453 HiBk Work Chair
4535301D	157	Criterion 453 HiBk Work Chair
4535330	159	Criterion 453 MidBk Work Chair
4535330D	159	Criterion 453 MidBk Work Chair
4535330DH	159	Criterion 453 MidBk Work Chair
4535330DP	159	Criterion 453 MidBk Work Chair
4535330DW	159	Criterion 453 MidBk Work Chair
4535330H	159	Criterion 453 MidBk Work Chair
4535330P	159	Criterion 453 MidBk Work Chair
4535330W	159	Criterion 453 MidBk Work Chair
4535331	157	Criterion 453 HiBk Work Chair
4535331D	157	Criterion 453 HiBk Work Chair
4535331DH	157	Criterion 453 HiBk Work Chair
4535331DP	157	Criterion 453 HiBk Work Chair
4535331DW	157	Criterion 453 HiBk Work Chair
4535331H	157	Criterion 453 HiBk Work Chair
4535331P	157	Criterion 453 HiBk Work Chair
4535331W	157	Criterion 453 HiBk Work Chair
4537300	163	Criterion 453 MidBk Stool
4537300D	163	Criterion 453 MidBk Stool
4537301	161	Criterion 453 HiBk Stool
4537301D	161	Criterion 453 HiBk Stool
4537330	163	Criterion 453 MidBk Stool
4537330D	163	Criterion 453 MidBk Stool
4537330DH	163	Criterion 453 MidBk Stool
4537330DP	163	Criterion 453 MidBk Stool
4537330DW	163	Criterion 453 MidBk Stool
4537330H	163	Criterion 453 MidBk Stool
4537330P	163	Criterion 453 MidBk Stool
4537330W	163	Criterion 453 MidBk Stool
4537331	161	Criterion 453 HiBk Stool
4537331D	161	Criterion 453 HiBk Stool
4537331DH	161	Criterion 453 HiBk Stool
4537331DP	161	Criterion 453 HiBk Stool
4537331DW	161	Criterion 453 HiBk Stool
4537331H	161	Criterion 453 HiBk Stool
4537331P	161	Criterion 453 HiBk Stool
4537331W	161	Criterion 453 HiBk Stool
4539301B	165	Criterion Plus 453 HiBk Work Chair
4539331B	165	Criterion Plus 453 HiBk Work Chair

Style Number	Page	Description
4539331BH	165	Criterion Plus 453 HiBk Work Chair
4539331BW	165	Criterion Plus 453 HiBk Work Chair
4611101	175	Drive 461 Work Chair
4611111	175	Drive 461 Work Chair
4611401	175	Drive 461 Work Chair
4611411	175	Drive 461 Work Chair
46216179	27	Leap 462 Work Chair
46216189	29	Leap 462 Work Chair
46267179	31	Leap 462 Stool
46267189	33	Leap 462 Stool
46296179	35	Leap Plus 462 Work Chair
46296189	37	Leap Plus 462 Work Chair
463480	208	Ally 463 Sled-Base Multi-Purp Chair
463482	208	Ally 463 Sled-Base Multi-Purp Chair
464LOUNGE	110	Leap 464 WorkLounge
464OTTOMAN	111	Leap 464 Ottoman
4653000	60	Think 465 Series Stool
46530100	56	Think 465 Series Stool
46531000S	61	Think 465 Series Stool
46531100S	57	Think 465 Series Stool
46532000	59	Think 465 Series Stool
46532100	55	Think 465 Series Stool
46533000	58	Think 465 Series Stool
46533100	54	Think 465 Series Stool
46540000	52	Think 465 Work Chair
46540100	48	Think 465 Work Chair
46541000S	53	Think 465 Series Work Chair
46541100S	49	Think 465 Series Work Chair
46542000	51	Think 465 Work Chair
46542100	47	Think 465 Work Chair
46543000	50	Think 465 Work Chair
46543100	46	Think 465 Work Chair
466160MP	87	Reply 466 Series Work Chair
466160MT	86	Reply 466 Series Work Chair
466450MH	89	Reply 466 Series Leg-Base Multi-Use Chair
466450MT	88	Reply 466 Series Leg-Base Multi-Use Chair
466452MH	89	Reply 466 Series Leg-Base Multi-Use Chair
466452MT	88	Reply 466 Series Leg-Base Multi-Use Chair
466480MH	91	Reply 466 Series Sled-Base Multi-Use Chair
466480MT	90	Reply 466 Series Sled-Base Multi-Use Chair
466482MH	91	Reply 466 Series Sled-Base Multi-Use Chair
466482MT	90	Reply 466 Series Sled-Base Multi-Use Chair
472410	249	Max-Stkr 472 Stackable Seating
472410BR	249	Max-Stkr 472 Stackable Seating
472410N	249	Max-Stkr 472 Stackable Seating
472410NBR	249	Max-Stkr 472 Stackable Seating
472410NTL	249	Max-Stkr 472 Stackable Seating
472410NTLB	249	Max-Stkr 472 Stackable Seating
472410NTR	249	Max-Stkr 472 Stackable Seating
472410NTRB	249	Max-Stkr 472 Stackable Seating
472410TL	249	Max-Stkr 472 Stackable Seating
472410TLB	249	Max-Stkr 472 Stackable Seating
472410TR	249	Max-Stkr 472 Stackable Chair
472410TRB	249	Max-Stkr 472 Stackable Chair
472BR	250	Max-Stkr 472 Bkrack Assy

Style Number	Page	Description	Style Number	Page	Description
472G	250	Max-Stkr 472 Alignment Device	4877211	131	Cachet 487 Stool
472TAL	250	Max-Stkr 472 Tablet Arm Assy	4878100	129	Cachet 487 Leg-Base
472TAR	250	Max-Stkr 472 Tablet Arm Assy	4878110	129	Cachet 487 Leg-Base
473410	259	Max-Stkr II 473 Stackable Seating	4878200	129	Cachet 487 Leg-Base
473410B	259	Max-Stkr II 473 Stackable Seating	4878201	129	Cachet 487 Leg-Base
473410N	259	Max-Stkr II 473 Stackable Seating	4878210	129	Cachet 487 Leg-Base
473410NB	259	Max-Stkr II 473 Stackable Seating	4878211	129	Cachet 487 Leg-Base
473410NTL	259	Max-Stkr II 473 Stackable Seating	487BK	133	Cachet 487 Cushion Upholstery Pkg
473410NTLB	259	Max-Stkr II 473 Stackable Seating	487D	135	Cachet 487 Transport/Strg Dolly
473410NTR	259	Max-Stkr II 473 Stackable Seating	487G	135	Cachet 487 Ganging/Alignment Device
473410NTRB	259	Max-Stkr II 473 Stackable Seating	487ST	134	Cachet 487 Cushion Upholstery Pkg
473410TL	259	Max-Stkr II 473 Stackable Seating	487STBK	132	Cachet 487 Cushion Upholstery Pkg
473410TLB	259	Max-Stkr II 473 Stackable Seating	490410	229	Move 490
473410TR	259	Max-Stkr II 473 Stackable Seating	490410C	229	Move 490
473410TRB	259	Max-Stkr II 473 Stackable Seating	490410CP	229	Move 490
473B	260	Max-Stkr II 473 Bkrack Assy	490410P	229	Move 490
473D	251, 261	Max-Stkr Trans/Strg Dolly	490410U	229	Move 490
473G	260	Max-Stkr II 473 Alignment Device	490410UC	229	Move 490
473TL	260	Max-Stkr II 473 Tablet Arm Assy	490410V	226	Move 490
473TR	260	Max-Stkr II 473 Tablet Arm Assy	490410VC	226	Move 490
474410M	242	Snodgrass 474 Series Chair	490412	230	Move 490
474419M	242	Snodgrass 474 Series Chair	490412C	230	Move 490
474419W	242	Snodgrass 474 Guest Chair	490412CP	230	Move 490
475410M	215	Player 475 Leg-Base Multi-Purp Chair	490412P	230	Move 490
475410MTL	216	Player 475 Leg-Base Multi-Purp Chair	490412U	230	Move 490
475410MTR	216	Player 475 Leg-Base Multi-Purp Chair	490412UC	230	Move 490
475412M	215	Player 475 Leg-Base Multi-Purp Chair	490412V	226	Move 490
475412MC	215	Player 475 Leg-Base Multi-Purp Chair	490412VC	226	Move 490
475415M	215	Player 475 Leg-Base Multi-Purp Chair	490710	233	Move 490
475415MC	215	Player 475 Leg-Base	490710C	233	Move 490
475480M	217	Player 475 Sled-Base	490710CP	233	Move 490
475480MTL	218	Player 475 Sled-Base	490710P	233	Move 490
475480MTR	218	Player 475 Sled-Base	490710U	233	Move 490
475482M	217	Player 475 Sled-Base	490710UC	233	Move 490
475485M	217	Player 475 Sled-Base	490710V	227	Move 490 Value Pkg
475710M	219	Player 475 Leg-Base Stool	490710VC	227	Move 490 Value Pkg
475712M	219	Player 475 Leg-Base Stool	490712	234	Move 490
475715M	219	Player 475 Leg-Base Stool	490712C	234	Move 490
475A	220	Player 475 Alignment Device	490712CP	234	Move 490
475D	220	Player 475 Transport/Strg Dolly	490712P	234	Move 490
475G	220	Player 475 Ganging Device	490712U	234	Move 490
480110	200	node 480 Series Work Chair	490712UC	234	Move 490
480120	200	node 480 Series Work Chair	490712V	227	Move 490 Value Pkg
480130	201	node 480 Series Collaborative Chair	490712VC	227	Move 490 Value Pkg
480140	202	node 480 Series Collaborative Stool	490D	235	Move Transport/Storage Dolly
4821410	73	Amia 482 Series Work Chair	490GA4	235	Move Ganging/Alignment Device
4821410LS	70	Amia 482 Series Work Chair	490GA7	235	Move Ganging/Alignment Device
4821418	75	Amia 482 Series Chair	490W	235	Move Wall Saver Bumper
4827410	77	Amia 482 Series Stool	499111	119	Siento Mid-Back Desk Chair
4827418	78	Amia 482 Series Stool	499112	119	Siento Mid-Back Desk Chair
4871110	127	Cachet 487 Swivel-Base	499113	119	Siento Mid-Back Desk Chair
4871210	127	Cachet 487 Swivel-Base	499121	119	Siento Mid-Back Desk Chair
4871211	127	Cachet 487 Swivel-Base	499122	119	Siento Mid-Back Desk Chair
4877110	131	Cachet 487 Stool	499123	119	Siento Mid-Back Desk Chair
4877210	131	Cachet 487 Stool	499211	119	Siento High-Back Desk Chair

Style Number Index, continued

Style Number	Page	Description
499212	119	Siento High-Back Desk Chair
499213	119	Siento High-Back Desk Chair
499221	119	Siento High-Back Desk Chair
499222	119	Siento High-Back Desk Chair
499223	119	Siento High-Back Desk Chair
499SIENTO	116	Siento Design Pkg High-Back Chair
CQCT1632	193	Collaborative Lounge Table
JERSEYV	100	Jersey Series Value Work Chair
LEAPV2	24	Leap 462 Work Chair
PROTEGEV	142	Protégé 433 Value Work Chair
TS30101	303	à la carte Chair
TS30102	303	à la carte Chair
TS30103	303	à la carte Chair
TS30104	305	à la carte Chair
TS30105	303	à la carte Chair
TS30106	303	à la carte Chair
TS30107	305	à la carte Chair
TS30301	300	Jack Task Chair
TS30302	300	Jack Task Chair
TS30303	301	Jack Task Chair
TS30304	301	Jack Task Chair
TS30311	300	Jack Task Chair
TS30312	300	Jack Task Chair
TS30313	301	Jack Task Chair
TS30314	301	Jack Task Chair
TS30321	300	Jack Task Chair
TS30322	300	Jack Task Chair
TS30323	301	Jack Task Chair
TS30324	301	Jack Task Chair
TS30801	293	Crew Chair
TS30802	293	Crew Chair
TS30803	293	Crew Stool
TS30805	296	Crew Chair
TS30806	296	Crew Chair
TS30807	296	Crew Chair
TS30808	296	Crew Chair
TS30811	293	Crew Chair
TS30812	293	Crew Chair
TS30813	293	Crew Stool
TS30821	293	Crew Chair
TS30822	293	Crew Chair
TS30823	293	Crew Stool
TS30831	293	Crew Chair
TS30832	293	Crew Chair
TS30833	293	Crew Stool
TS31101	309	Uno Chair
TS31102	309	Uno Chair
TS31301	298	Jacket Chair
TS31302	299	Jacket Cover
TS31901	306	Executive 319 Chair
TS31902	306	Executive 319 Chair
TS31903	307	Executive 319 Chair
TS37101	310	Domino Chair
TS37102	311	Domino Cushion
TS37103	312	Domino Dolly

Style Number	Page	Description
TS37104	312	Domino Cushion
TS38301	101	Jersey Chair
TS38304	102	Jersey Chair
TS38305	102	Jersey Chair
TS38308	103	Jersey Chair
TS38309	103	Jersey Chair

Trademark List

® The following are registered trademarks for products of Steelcase Inc. or one of its related corporate entities: 4 o'clock, 900 Series, à la carte, Airtouch, Ally, Amia, Answer, Archipelago, Avenir, Ballet, Bix, Brayton International, Cachet, Canopy, Canto, Chancellor, Coalesse, Confidante, Context, Convene, CopyCam, Criterion, Crushed Can, Currency, Designtex, Details, Detour, Drive, Elective Elements, Ellipse, Ember Chrome, Emerge, E-Table 2, FYI, Garland, Gentry, Ginkgo Biloba, Groupwork, Ideo, Jacket, Jenny, Jersey, Kart, Kick, LaCosta, Leap, Let's B, LiveBack, Max-Stacker, Metro, Migrations, Mitra, Montage, Nurture, Oriana, Parade, Pathways, PCT, Permiso, Player, PolyVision, Portal, Power Pincher, Progeny, Protégé, R2, Rally, Relevant, Reply, Rizzi Arc, Sensor, Series 9000, Siento, Sieste, Sine, Softcare, Springboard, Steelcase, Steelcase Design Partnership, Stella, Stow Davis, Swathmore, TeamWork, Technique, Texpress, Think, Thunder, Topo, Train, Turnstone, Underline, Unison, Vecta, Viridian, Walden, Werndl, and X-Stack.

® The following are a registered trademarks of AWI Licensing Company, Dover, DE: SoundScapes, DuraBrite, BioBlock, and Armstrong.

® The following registered trademarks are under license from Byrne Electrical, Rockford, MI: Interport and Mini-Port.

® The following is a registered trademark of DuPont, Wilmington, DE: Corian.

® The following is a registered trademark of Genlyte Thomas Company, Louisville, KY: Lightlior.

® The following is a registered trademark of Hilti Corporation, FL-9494 Schaan, Principality of Liechtenstein: Hilti.

® The following is a registered trademark of Leviton Manufacturing Company, Little Neck, NY: Decora.

® The following is a registered trademark of Mechanical Plactics Corp, Elmsford, NY: Toggle.

® The following is a registered trademark of Microsoft Corporation, Redmond, WA: Microsoft.

® The following is a registered trademark of Panduit Corporation, Lockport, IL: Panduit.

® The following is a registered trademark of Trav (Press), Cuneo, Italy: Assisa.

® The following is a registered trademark of Virtual Ink, Boston, MA: mimioActive.

® The following registered trademarks are under license from Wilkhahn Furniture Products: Avera, Senzo, Versal, and Wilkhahn FS.

® The following is a registered trademark of Wilsonart International, Temple, TX: Chemsurf.

® The following is a registered trademark of Wiremold, West Hartford, CT: Wiremold.

® The following is a registered trademark of EMU Group S.P.A., Perugia, Italy: Emu

™ The following are trademarks for products of Steelcase Inc. or one of its related corporate entities: Access, Active/Passive Shelf, Ainsley, Akira, Alcove, Alerion, ailight, Amaris, American Elect, American Tradition, ap40, Arbor, Arriva, Asana, Ascot, Aspekt, Astor, Await, Bira, Bivi, Bottomline, Brook, Burton, c:scape, Calla, Calm, Camber, Campfire, Capa, Cappucino, Cesar, Chester, Chord, Circa, Clarendon, Classic Rectangular, cobi, Collaboration, Community, Company, Convey, Cortex, Coupe, Crea, Crew, Cura, Cypress, Davenport, Dearborn, Deck, Déjà, Denizen, Denska, Derby, Donovan, Dune, Duo, e³, e³ ceramicsteel, e³ environmental ceramicsteel, Echo, Edge, Elсна, Empress, Enea, ēno, EnSync, Enviro, Escapade, Exchange, Exponents, Field, Flat Top, FlexFrame, Flip Top, Flute, Folio, FrameOne, FreeFlow, Frontier, Galilei, Ginger, Ginkgo, Go Wall, Grip, Groove, Hatchback, Hawthorne, Hitch, Host Collection, Huddleboard, i2i, Impact, Indy, InfoLink, IOS, I-Solve, Jack, Jarrah, Jetty, Juice, Kami, Kast, Kathryn, Lark, L'Attitude, LearnLab, Leela, Lincoln, Linden, LiveSeat, Loria, Lyric, Malibu, Malibu Too, Mansfield, Marathon, Martini, Mason, Masque, media:scape, Millbrae, Mineral, Mingle, Mystic, Mystic Metal, Mystic Wood, Montreal, Move, Nadia, Neighbor, nesso, Nickel, Nikko, Nod, node, Norfolk, Ontrak, Oom, Opus, Orchid, Outlook Collection, Ovation, Paloma, Paperflo, Parliament, Pasio, Passerelle, Patriarch, Payback, Peek, Pile File, Pisa, Pool, PUCK, Quba, Rave, Reed, Reunion, Ripple, Riser, Rocco, Rocky, RoomWizard, Runner, Satellite, Sawyer, ScapeSeries, Senti, Sentinel, Senza, Sequoia, Session, ShareLink, Shield, Sidewalk, Skylar, Slumber, Smoke, Snug, Soft Leaf, Sonata, Sorrel, SOTO, Stationkits, Stiletto, Surprise!, Switch, Symphony, Sync, Tava, Tenaro, Terrazzo, Theorem, Topaz, Touchdown, Tour, Tower Too, Trees, Trillium, Trolley, tX2, U-Free, Uno, Verge, Visalia, Waldorf, Woodruff, Workspring, and X-tenz.

™ The following is a trademark of Microsoft Corporation, Redmond, WA: Windows.

™ The following is a trademark of Rodman Industries, Inc., Oconomowoc, WI: ResinCore1.

™ The following is a trademark of Ultrafabrics, LLC, Elmsford, NY: Ultraleather.

™ The following trademarks are used under license from Wilkhahn Furniture: Cana, Linus, Logon, Picto, Range, Stitz, Thema, Timetable, and Tubis.

™ The following is a trademark of MBDC, Charlottesville, VA: Cradle to Cradle.

™ The following trademarks are under license from Walter Knoll: Andoo, Bob, Lazlo, Ribbon, and Together

™ The following trademarks are under license from PP Mobler: Bar and Flag Halyard.

™ The following trademarks are under license from Viccarbe: Davos, Holy Day, Last Minute, RS, and Wrapp.

™ The following trademarks are under license from Carl Hansen: Elbow, Paddle, Shell, Wing, and Wishbone.

™ The following trademarks are under license from Cambridge Sound Management, LLC, Cambridge, MA: Qt PRO Soundmasking, Qt Quiet Technology, and Sonet Qt.

™ The following is a trademark of Electri-Cable Assemblies, Shelton, CT: Interact.

Trademarks used here in are the property of Steelcase, Inc. or of their respective owners.