

Host Collection

Understanding Tables	322
Specifying Tables	
Round Tables	344
Rectangular Tables	346
Soft Radiused Tables	374
Racetrack Tables	404
Boat Shaped Tables	436
Trapezoid Tables	456
Accessories	463

Host Collection

Host Collection is a suite of elegant furnishings for the multimedia, interactive conference room. Host Collection's fully resolved design details speak to the need for refinement in aesthetic appeal, while every functional aspect of the table was designed to accommodate a breadth of user needs.

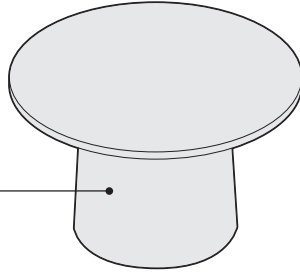

Round base is conical shaped plywood with wood veneer surface.

Top is 1/4" thick particle board with laminate or wood veneer top.

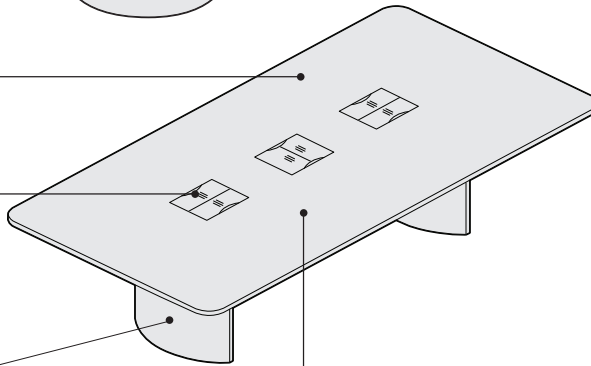

TAP trays, if selected, provide access to power, data, voice, audio, video, or any type of outlet required. Storage trays provide access to house equipment, such as, speaker phones.

Bases are available with either a flared or a slim base.

Quarter Cut Anigre and Quarter Cut Walnut are two veneers exclusively for Host Collection.

Product Details

Table height is standard at 28 1/2" H.

Adjustable leveling glides have a range of 1/2" to accommodate uneven floors.



Round



Rectangular

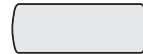

Soft Radiused



Racetrack



Boat Shaped



Trapezoid

Table shapes include round, rectangular, soft radiused, racetrack, boat shaped, and trapezoid. A wide range of sizes up to 20'L is available to fit any room size.

In addition to all standard Grade 1 veneers, two new veneers are available exclusively on the Host Collection: Quarter Cut Anigre 3035, a Grade 1 veneer, and Quarter Cut Walnut 3315, a Grade 2 veneer.

Tip: Tops with Quarter Cut Anigre 3035 veneer will have maple solid wood edge stained to match the natural anigre.

Coalesse's standard veneers are plain sliced and book matched, except for 3035 and 3315 which are quarter cut and slip matched.

Seating Capacity Guidelines
▶ See page 332

Host Collection

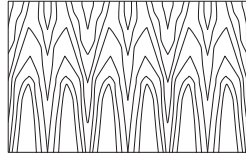

Plain sliced veneer has the traditional cathedral appearance. Book matching produces a mirror image of pairs of veneer leaves.

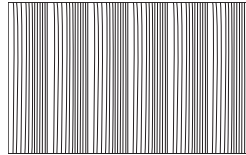

Quarter cut veneer has a straighter grain that produces a more contemporary appearance. These veneer leaves are slip-matched to produce a subtle repetition.



Self-edge table tops have flat edges that are surfaced with the same material and color that is applied to the top of the table. Self edges are available on tops that are 1/4" thick.

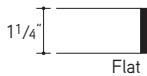

Vinyl edge profiles are available in the following shapes and colors on table tops that are 1/4" thick.

- Flat 1/4" edge available in 6000 Black

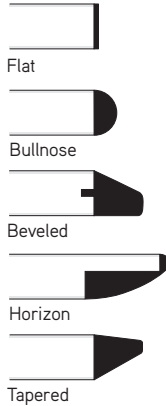

Solid wood edges are available in five profiles—flat, bullnose, beveled, horizon, or tapered. Not every edge is available on every top shape. ▶Refer to the matrix on page 326 for availability.



Tops with flat, bullnose and beveled wood edges will have square corners.



Tops with tapered and horizon wood edges have 4" radius corners.

Sectioned tops

Large tops are shipped in sections with hardware for field assembly. Tops 8'L ship in one piece. Tops 10'L and 12'L can ship in one or two pieces. Tops 14'L, 16'L, 18'L and 20'L can ship in two or three pieces.

Tip: The style number indicates top sections.

▶Refer to style number explanation, page 343.

Large tops can be difficult to move through some buildings.

Tip: Inspect the building where the table will be installed to confirm that elevators, loading docks, hallways, doorways, windows, etc. can accommodate large table tops.

Removable access door on each base allows for easy installation of utility infeeds. A toe hole allows infeeds from a floor monument outside the base.

Leveling glides on all bases adjust 1/2".

Wood veneer bases are available in three styles—round, slim, and flared.

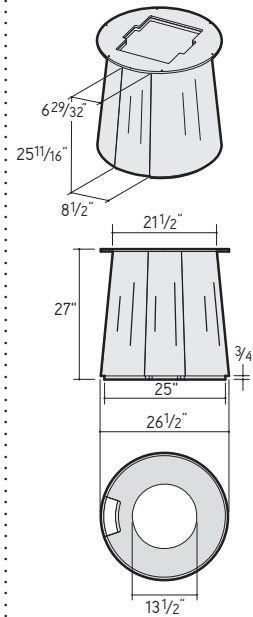

Round base is conical shaped plywood with a wood veneer surface, 26 1/2"-diameter bottom and 21 1/2"-diameter top. Underneath the round base is a 25"-diameter black painted wood inset, 3/4"H, with an opening. The 13 1/2"-diameter opening is surrounded by a 50 lb concrete weight for stability. The removable access door, 8 1/2"W at the bottom and 6.9"W at the top x 25 3/4"H, is secured with a ball catch fastener on each corner.

Tip: Round base only available on round tables.

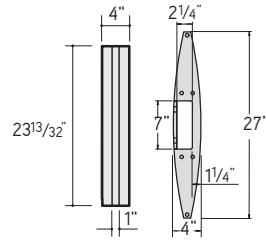

Slim base has a wood veneer surface on molded MDF with aluminum universal bracket. The removable access door, 7"W x 23 1/2"H, is secured with a ball catch fastener on each corner. Slim bases are available in one size, 4" x 27".

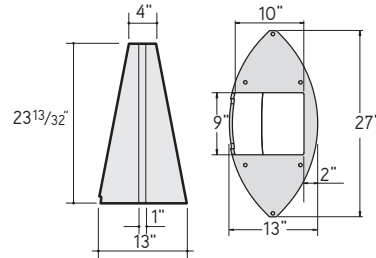
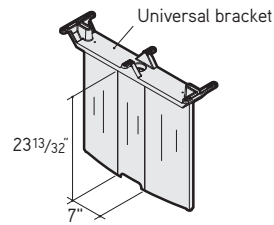

Flared base has a wood veneer surface on molded MDF with aluminum universal bracket. The removable access door, 9"W x 23 1/2"H, is secured with a ball catch fastener on each corner. Flared bases are available in one size, 13" x 27".

Style and number of bases required are determined by top shape and length. Round table tops have a single round base. Table tops 8'L through 12'L have two bases: two slim, two flared or slim and flared. Table tops 14'L through 20'L have three bases: three slim, three flared or combination of slim and flared.

Floor monuments can fit inside round and flared bases. Slim bases can be placed over some flush floor monuments.

▶For dimensions to aid in locating floor monuments, see page 336.

Host Collection *continued*

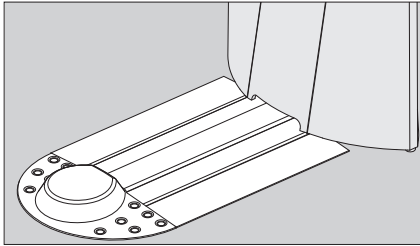

Connectrac, a floor monument kit, should be specified when a floor monument is not positioned under a base. Connectrac is a U.L. listed, ADA compliant raceway that can be installed underneath carpet tiles or broadloom to conceal wires and cables running from a floor monument to the Host base.

► See page 463

Tip: For detailed information about Connectrac, go to www.connectrac.com.

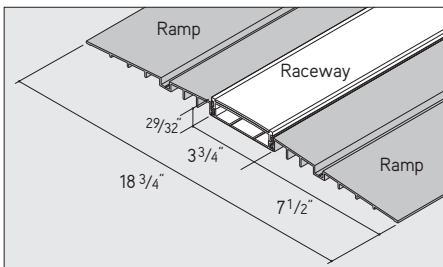
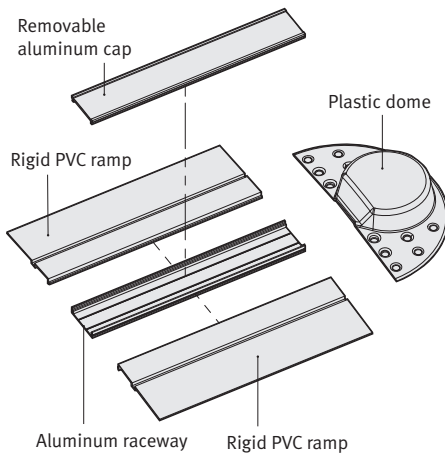

Raceway interior, 3¹/₄"W x 7⁷/₈"H, provides ample room for wires and cable.

Raceway overall is 3³/₄"W x 7⁷/₈"H.

Ramps, 5⁵/₈"H at the raceway connection, transition down to 1¹/₈"H.

Raceway and ramps overall is 18³/₄"W.

Dome interior, 5⁷/₈" diameter x 3"H, covers the floor monument. Dome opens allowing easy access to floor monument.

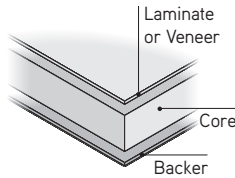

Solid core tops with 1¹/₄" edge thickness have a core of 45 lb median-density particle board with laminate or wood veneer on the top and a backer applied to the opposite side for balance. Laminate and wood veneer surfaces are bonded to the core with a PVA adhesive in a cold press.

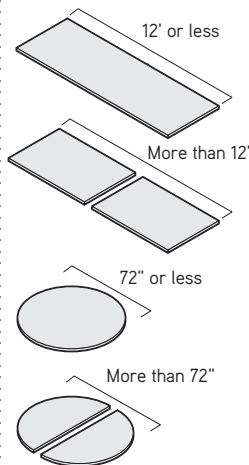

Large tops are shipped in sections with Tite-Joint fasteners for assembly on site. Table tops that are longer than 12' and table tops that are larger than 72" in diameter are always shipped in two pieces.

Large tops can be difficult to move through some buildings. *Tip: Inspect the building where the table will be installed to confirm that elevators, loading docks, hallways, doorways, windows, etc., can accommodate large table tops. You can request any one-piece top to be fabricated and shipped in two pieces to accommodate these small spaces. The following upcharges apply: 24" through 36" list upcharge for cut is \$250 U.S., 37" through 48" list upcharge for cut is \$285 U.S., 49" through 60" list upcharge for cut is \$317 U.S.*

To specify sectioned tops, designate with sectioned top.

A two-piece top may be fabricated and shipped in three pieces, please contact Customer Service for a quotation, 1.800.627.6770.

Custom shapes and sizes
Special table sizes and shapes are possible. To confirm practicality and obtain a quotation, contact Customer Service at 1.800.627.6770.

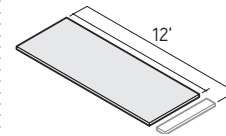

Cut-down tops, which are standard table tops with smaller dimensions, are available. Use the product number of the next larger size and specify the exact dimensions you want. Some restrictions apply, including minimum quantities. This option is not available for folding tables. Additional lead times may be required. Contact Customer Service at 1.800.627.6770. The following upcharge applies to cut-down tops, +\$373 U.S. *Tip: Upcharge for a cut-down top is applied one time only per size/style number. Tip: Fee is at list and contract discounts apply.*

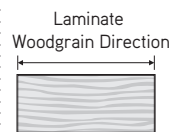

Woodgrain laminates are always oriented with the grain direction running parallel with the length of the table top.

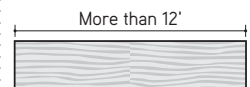

Woodgrain laminate sectioned tops cannot be guaranteed to have a perfect match of the grain pattern along the seam that joins the sections. Large tops that are more than 12' in length require two or more separate sheets of laminate. Coalesse will create the best match that is possible between two sheets of laminate, but depending on the woodgrain laminate pattern that you choose, a perfect match between sections cannot be guaranteed.

Wood edges are not recommended on tables with wood-grain laminates because matching of woodgrain laminate and natural, solid wood is not guaranteed. For tables with wood edge profiles, always specify either laminates in solid colors or patterns or wood veneer surfaces.

Tip: Because of natural variations, you should know that finished solid wood edges may vary slightly in tone or character from each other or from the samples Coalesse produces. No guarantee can be made of an absolutely exact match.

Standard veneer grain directions—grain directions are determined by the size and shape of the table top. Refer to the following guidelines for standard grain directions.

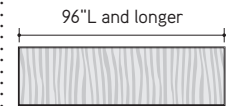

Grain runs parallel to the width on rectangular and boat tops that are more than 96"L.

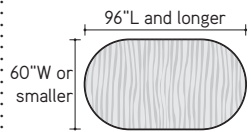

Grain runs across the width on racetrack tops that are 60"W or larger or more than 96"L.

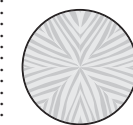

Wedge lay-up veneers radiate from the center on round tops.

Same flitch veneer is also available for tables that require similar graining and color, but will not be ganged. For example, specify same flitch veneer for two tables used in the same room, but spaced apart.

Host Collection

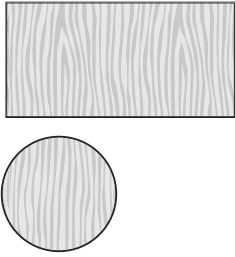

Same flitch matching is specified in cases where you want the veneer grain and pattern on two or more tops to come from the same flitch of veneer. This ensures a consistent grain pattern and coloration and should be specified when tops will be used near each other but not ganged.

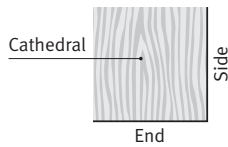

Grain directions are designated in relation to the dominant direction of the veneer—often referred to as the cathedral of the veneer. End-matched veneer refers to two pieces of veneer that match at the end of the cathedral. Side matched veneer refers to two pieces of veneer that match along the side of the cathedrals.

Surface Materials

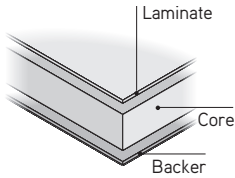

Laminates are available in two standard grades. Additional laminates from any manufacturer may also be practical—see *Other laminates* below.

Grade 1 laminates include:

- Coalesse standard laminates
- ▶ See *Surface Materials Listing*, page 600.
- Steelcase standard laminates (code 290A)
- ▶ See *Steelcase Surface Materials Reference Manual*.
- Any standard-grade Wilsonart laminate in solid color, woodgrain, or pattern finish (code 290A)

Grade 2 laminates (code 290B) include any standard-grade, solid color, woodgrain, or patterned laminate from Nevamar (includes Matrix), Formica, or Pionite. Grade 2 laminates may have extended lead times. For details, contact Customer Service at 1.800.627.6770.

Other laminates that are not included in the Grade 1 or Grade 2 offerings may also be available, such as Abet Laminati and Laminart. To determine availability and pricing, contact Customer Service at 1.800.627.6770, with the laminate manufacturer's name and the name and number of the laminate you want.

Laminate swatches are reproduced in the Surface Materials Color Palettes in the back of the book.

Swatch cards and actual samples of Coalesse standard laminates are available from your Coalesse customer service representative. For samples of laminates from other manufacturers, contact them directly:

- Wilsonart
1.800.433.3222
- Nevamar
1.800.638.4380
- Formica
1.800.FORMICA
- Pionite
1.800.285.5161

Tip: Laminate manufacturers change their offerings frequently. Always check availability before ordering.

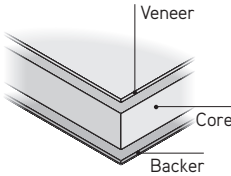

Wood veneer table tops are fabricated with Architectural Grade AA hand-selected hardwood veneer, plain sliced, book matched, and bonded to the core with a backing sheet for balance. Coalesse's primary wood finish, Clarity, is a waterborne UV topcoat, which protects the environment while providing exceptional durability and resistance to water and chemical stains. Due to natural variations in wood, finished products may vary from samples in color, texture, and grain.

Wood is a natural material; slight variations occur in veneer texture, color, grain configuration, and stain acceptance. Coalesse stains are all applied with an exacting regard for consistency and are well within traditional tolerances for wood products.

Tip: You should know that finished tops may vary slightly in tone or character from each other or from the samples Coalesse produces. No guarantee can be made of an absolutely exact match.

Additional wood veneer species are available. To confirm availability and to determine pricing, contact Customer Service at 1.800.627.6770.

Stains applied to Coalesse wood veneer table tops are standard with the same stain color applied to both the top and the solid hardwood edge profile. Coalesse strives to produce a consistently high quality product and some natural variation in color is to be expected. This is especially apparent on natural woods which have no stain applied, for example 3525 Natural Maple. This color variation is normal and reflects the unique and natural properties of wood. This should not be considered a defect.

Stain swatches are reproduced in the Surface Materials Color Palettes in the back of the book.

Swatch cards and actual samples of standard wood veneers are available from your Customer Service representative.

Additional wood veneer stains are possible. Coalesse offers two programs to accommodate customers who need special stains—Stain-to-Match and Stain and Finish to Match.

Stain-to-Match option is a special Coalesse program that will match a wood stain sample that you provide. There is no additional charge for this service. You must supply a sample of reasonable size (3" x 3" or larger is usually adequate). Coalesse will formulate a stain, produce a matching sample, and send it to you for approval. When we receive your written approval, we'll schedule production of your order.

Tip: Stain-to-Match will achieve a color match to the sample only. Graining of the wood veneer and final surface finish may differ from your original sample. See Stain and Finish to Match below.

Stain and Finish to Match is a special Coalesse program that can achieve both a color and a surface finish match for most customer-supplied samples. To determine feasibility and pricing, send us a sample of reasonable size (3" x 3" or larger is usually adequate) before you send us your order. If feasible, Coalesse will produce a sample showing the best possible match and send it to you for approval. When we receive your written approval, we'll schedule production of your order.

Stain formulas for special stain color matches are all retained in Coalesse's archives so that you can refer to them in future orders and skip the approval steps required for the initial order.











Care & Maintenance

Laminate and solid phenolic should be cleaned with soap and water. For stubborn stains, use a non-abrasive household cleaner.

Veneers should be cleaned regularly with mild soap and water and dried with a soft cloth. To polish, use silicone-free household polishers. Use sparingly.
Tip: Never use ammonia-based cleaners or wax on wood surfaces.

Tables should be inspected and maintained regularly by tightening screws and bolts, inspecting casters and glides for damage, and inspecting all moving parts for damage and wear.

Edge Alternatives

Edge Alternatives	Table Top Shape					
	Round	Soft-Radiused	Rectangular	Racetrack	Boat Shaped	Trapezoid
1/4" Tops						
 <ul style="list-style-type: none"> • 1/4" bullnose wood • 5/8"D profile 	• Available with square corner	• Available with radius corner	• Available with square corner	• Available with square corner	• Available with square corner	• Available with square corner
 <ul style="list-style-type: none"> • 1/4" beveled wood • 1/4"D profile 	• Available with square corner	• No	• Available with square corner	• Available with square corner	No	• No
 <ul style="list-style-type: none"> • 1/4" horizon wood • 3/2"D profile 	• Available with radius corners	• Available with radius corners	• Available with radius corners	• Available with radius corner	No	• Available with radius corner
 <ul style="list-style-type: none"> • 1/4" tapered wood • 1/4"D profile 	• No	• No	• Available with 4" radius corners	• No	• No	• No
 <ul style="list-style-type: none"> • 1/4" flat wood • 1/8"D profile 	• Available with square corners	• Available	• Available with square corners	• Available	• Available with square corners	• Available with square corners

Host Collection

Host Collection *continued*

Tech Corridor

All Host tables except round shapes are equipped with a Tech Corridor.

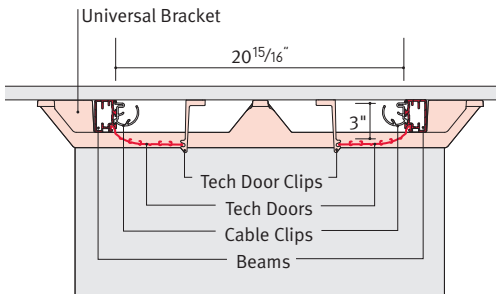

Tech corridor runs under the length of the table between the table top and the universal base brackets. Tech corridor creates a space approximately 20^{15/16}" x 3" for cables, TAP tray(s), and optional equipment shelf(s).

Tech corridor assembly consists of satin anodized aluminum twin beams and ribbed satin anodized aluminum hinged tech doors that clip shut.

Beams, 1^{5/8}"W x 2^{3/8}"H, with black plastic end caps provide support to the table top. Beams have a rail feature that accommodates cable clips.

Tip: One cable clip is provided for each foot of table length.

Tech doors hinge from the beams and clip shut with door clips to conceal and support wires and cables. Tech doors are approximately 5^{3/4}"W.

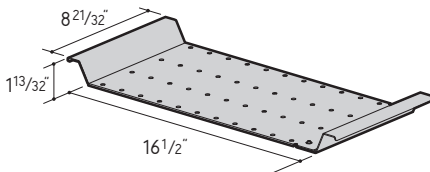

Corridor shelf is available to hold routers, hubs, line drivers, scalars and other technical equipment. Corridor shelf hangs between the beams and provides 1.5 rack units of space, 2^{3/4}"H.

► See page 463

Two Beam Tables:

96"L, 10'L, 12'L

Place the two bases in their approximate final locations.

Tip: End bases will be centered 24" from the end of the table top.

Tip: In most cases base access doors should face inward.

Tip: Bases can be the same style or a combination of slim and flared. Bases are located in the same position for any given table shape, regardless of table shape.

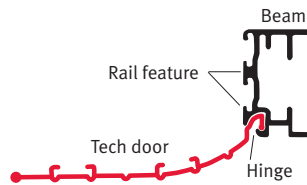

Tech Corridor Assembly:

- Remove beam end caps.
- Slide long tech doors on to hinge of each beam.
- Slide short tech doors on to each end in the same hinge.

Place beam/tech doors assemblies facing each other on to the bases with the long doors between the bases and short doors outside the bases.

Push beam end caps in to the ends of the beams. Align the second predrilled hole from each end of the two beams with the holes in the bracket castings.

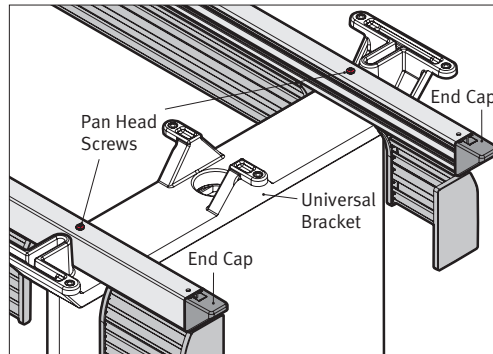

Start the Pan Head screws into each bracket casting. **DO NOT** tighten.

Tip: Pan Head screws remain above the beam to aid in table top alignment.

Level bases. Check the square alignment of the beams. Tighten Pan Head screws.

Four Beam Tables:

14'L, 16'L, 18'L, 20'L

Place and center the three bases where they should be in the room and assemble the Tech Corridor (See Tech Corridor Assembly in Two Beam Tables).

Tip: End bases will be centered 24" from the end of the table top.

Middle base is positioned in the center of the table top.

Rail Clamp splices the two beams together at the center base.

Host Collection

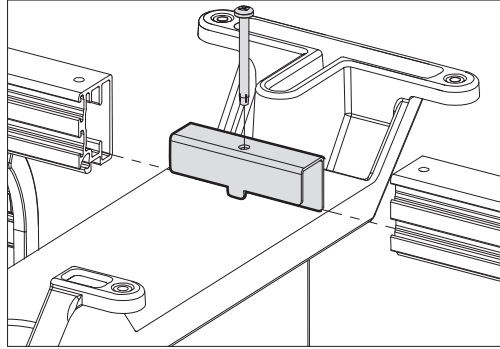

Align black rail clamps with predrilled holes in center base bracket casting. Position each clamp with the tab pointing downward, and the short side of the clamp facing inward.

Place beam/tech doors assemblies facing each on to the bases with the long doors between the bases and the short doors outside the end bases.

Slide a pair of beams on to each rail clamp. Push both beams against the tab at the bottom of the clamp, forming a 1/2" gap between the beams.

Tighten each black screw on each clamp to ensure the gap remains unchanged.

Check the square alignment of the beams. The clamped beams can pivot as needed to square the frame.

Align the second predrilled hole from each end of the two beams with the holes in the bracket castings.

Start the pan head screws into each bracket casting. **DO NOT** tighten.

Tip: Pan head screws remain above the beam to aid in table top alignment.

Level bases. Check the square alignment of the beams. Tighten pan head screws.

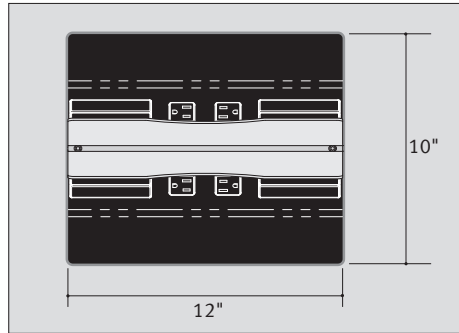
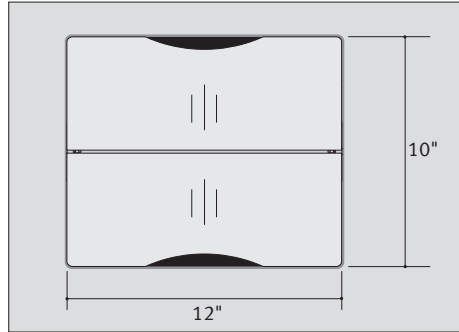

Table top opening for TAP is 12" x 10", trimmed with a flat solid wood profile. Two doors conceal dual access to a black powder coated steel tray that houses power and data outlets.

Tip: Wood trim will match the color of the wood edge.

Up to six TAPs can be specified depending on the table length. TAPs are available as an option on all Host Collection tables.

► See individual product specifying pages for TAP locations.

Tip: A storage tray may replace one TAP.

► See page 335

TAP doors are made of brushed anodized aluminum. Each TAP door has an opening that allows cables to pass when the doors are closed. TAP doors are friction hinged, opening to 77°. TAP doors are fully adjustable to maintain an even appearance with the table top when closed.

TAP doors can be silver or black anodized or with optional wood veneer. The veneer doors will always match the finish of the table top. Veneer doors will be available on veneer tops only.

All doors must be the same finish—silver, black or veneer.

TAP Door Adjustments

CAUTION: TAP DOORS CAN BE EASILY SCRATCHED WITH HEX KEYS. MAKE SURE BOTH DOORS ARE FULLY OPEN BEFORE MAKING ADJUSTMENTS.

Host Collection *continued*

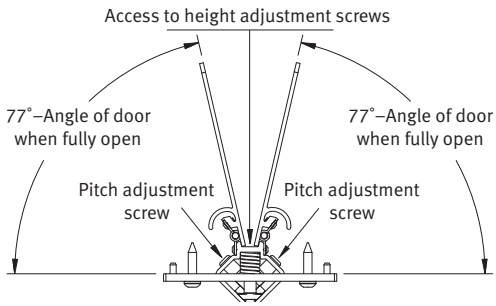

Adjust the pitch first, then adjust the height.

Adjust the pitch of each door to be level with the table surface by adjusting the Allen screw found under each door.

Adjust the height of the left and right sides of the TAP door assembly to be flush with the table surface by adjusting the Allen screws on top between the doors. There is an adjustment screw at each end of the TAP assembly. Doors must be fully open to adjust screws.

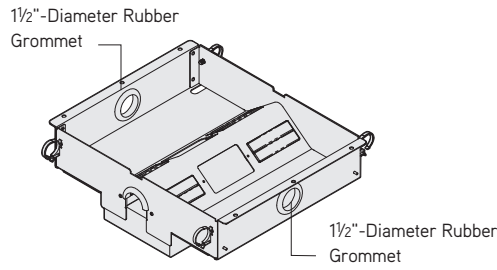
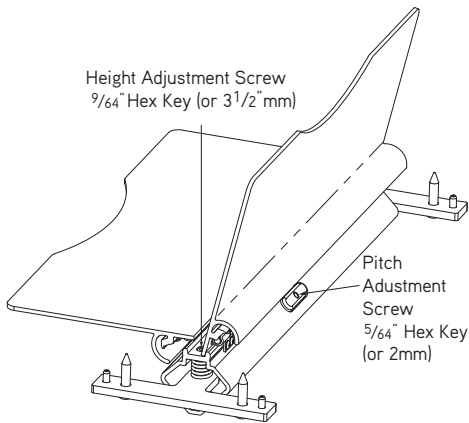

TAP trays provide access to power, data, voice, audio, video, or any type of outlet required. Each TAP tray includes a storage area for laptop computer transformers, excess wires, or other accessories. A 1/2"-diameter rubber grommet located in each half of the TAP tray allows cables to enter directly into the tray from the tech corridor (such as a PolyVision Multipurpose Cable). The bottom cover of the TAP tray is easily removable without tools for technician's access.

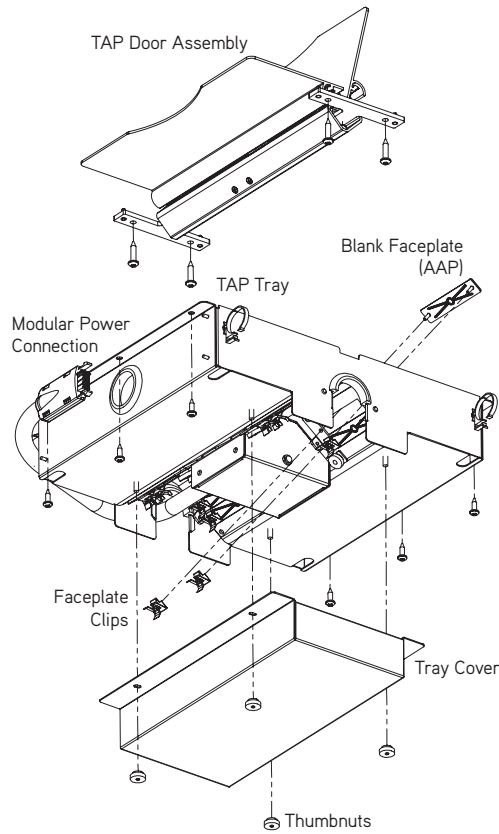

Host Collection

TAP Tray Electrical Systems

Four choices:

Tip: All TAP trays (except field-wired) have four 15-amp power outlets.

Tip: All TAP trays are U.L. and C.U.L. listed.

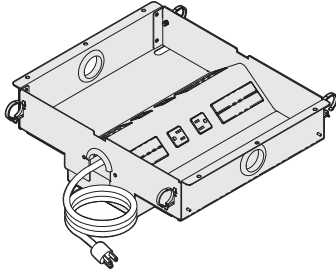

Cord and plug tray will have a 10' cord and 15-amp plug. Each TAP tray must be plugged into a floor outlet. This TAP tray cannot be daisy-chained.

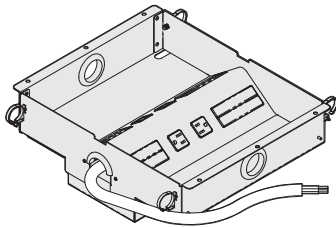

Hardwired tray will have a 6' conduit and a three-wire hardwire connection.

Tip: Hardwired TAP tray must be connected to the building power supply by a licensed electrician.

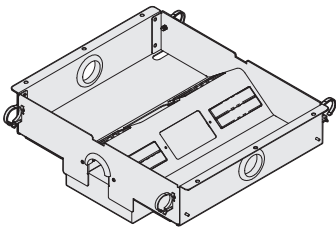

Field-wired tray will have two single-gang faceplate openings for customer's own power outlets and wiring.

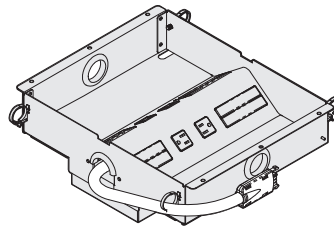
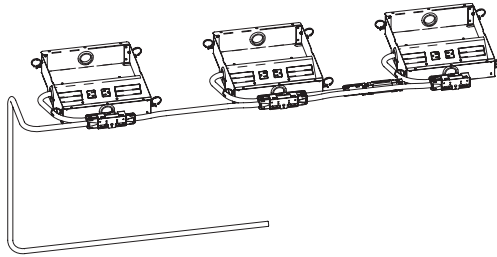

Modular tray will have a modular harness that "daisy-chains" from one TAP to the next. A two-circuit, four-wire hardwire base power infeed is included.

Tip: Modular TAP tray is a two-circuit system. Modular TAPs will alternate circuits within a table.

Tip: Lengths of the modular hardwire base power infeed will vary by table size and configuration but will be able to always reach floor monuments located anywhere underneath the table.

Tip: Power infeeds can be routed down any table base.

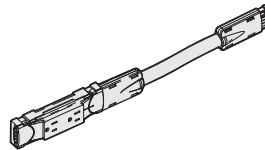

Corridor power kit, modular can be added only to modular trays.

This kit adds two electrical outlets inside the tech corridor for plugging in speaker phones or other equipment that does not require frequent access.

► See page 464

Tip: A six outlet plug strip with 15' cord and plug can also be installed in the tech corridor.

► See page 464

Host Collection *continued*

TAP Tray Faceplates

Architectural Adapter Plate (AAP) choices:

Tip: TAP trays utilize Extron Electronics' Architectural Adapter Plates (AAPs).

Tip: Each TAP tray can accommodate up to eight single-space AAPs.

AAPs provide access to data, audio, video, telephone, microphone, room control systems and other technologies inside TAPs. Data AAPs and Video/Audio AAPs are available with Host TAPs. Many other AAPs are available from Extron Electronics. For information on other styles of AAPs and to find an Extron Electronics dealer, call Extron at 800.633.9876 or online at www.extron.com.

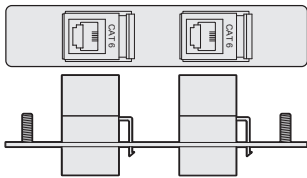

Data Architectural Adapter Plate has two CAT 6 RJ45 barrel (pass-through) outlets.

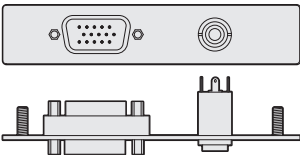

Video/Audio Architectural Adapter Plate has one VGA outlet (HD15 female to female gender changer) and one audio outlet (3 1/2 mm stereo mini jack to solder tabs).

Seating Capacity Guidelines

Depth	Width	Approximate Capacity	Depth	Width	Approximate Capacity
Round Tops			Racetrack Tops		
42"		4	96"	48"	6
48"		5	10'	48"	6
54"		5	12'	48"	8
60"		6	14'	48"	12
66"		6	16'	48"	14
72"		7	18'	48"	16
84"		8	20'	48"	18
96"		10	10'	60"	12
108"		11	12'	60"	12
10'		12	14'	60"	14
Rectangular and Soft Radiused Tops			18'	60"	14
12'	48"	10	16'	60"	16
14'	48"	12	18'	60"	18
16'	48"	14	20'	60"	20
18'	48"	16			
20'	48"	18			
10'	60"	12			
12'	60"	12			
14'	60"	14			
16'	60"	16			
18'	60"	18			
20'	60"	20			
Depth	Center Width	End Width	Approximate Capacity		
Boat Tops					
96"	54"	42"	8		
10'	60"	48"	10		
12'	60"	48"	10		
14'	60"	48"	12		
16'	60"	48"	14		
18'	60"	48"	16		
20'	60"	48"	18		
Trapezoid Tops					
96"	60"	42"	9		
10'	60"	42"	11		
12'	60"	42"	11		

Optional Modular Installation

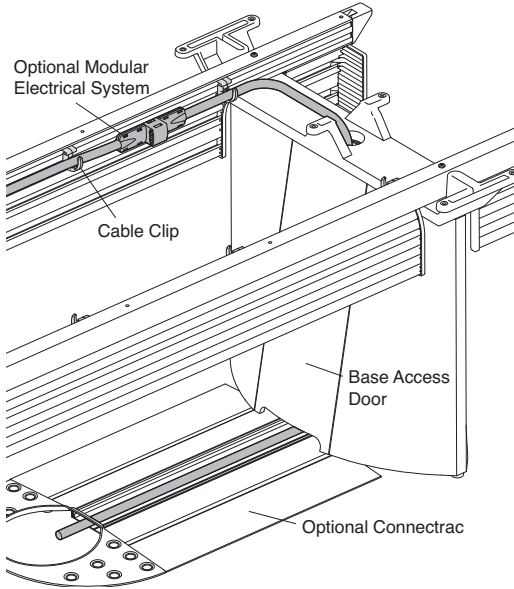

If optional modular electrical system is specified, bring wiring up through base from floor monument or base access door into Tech Corridor. A hardwire infeed is used for the modular electrical systems. For single TAP styles, the modular infeed is not needed. Specify the hardwired tray option. Connect electrical cables and secure with cable clips. Run data wires along opposite beam and secure with cable clips as required.

Note: A licensed electrician must connect the power infeed(s) to the building power source in accordance with all national and local electrical codes. These electrical assemblies are intended for installation in accessible, dry locations in accordance with Article 604 of the National Electric Code NFPA70. If you have any concerns about a specific application, please consult the local authority having jurisdiction. This system is rated for a maximum of 20 amps, 125/250 V, 1-Phase, 60Hz or 120/208 V, 3-Phase, 60Hz.

Modular Tray Connection Example with Accessories

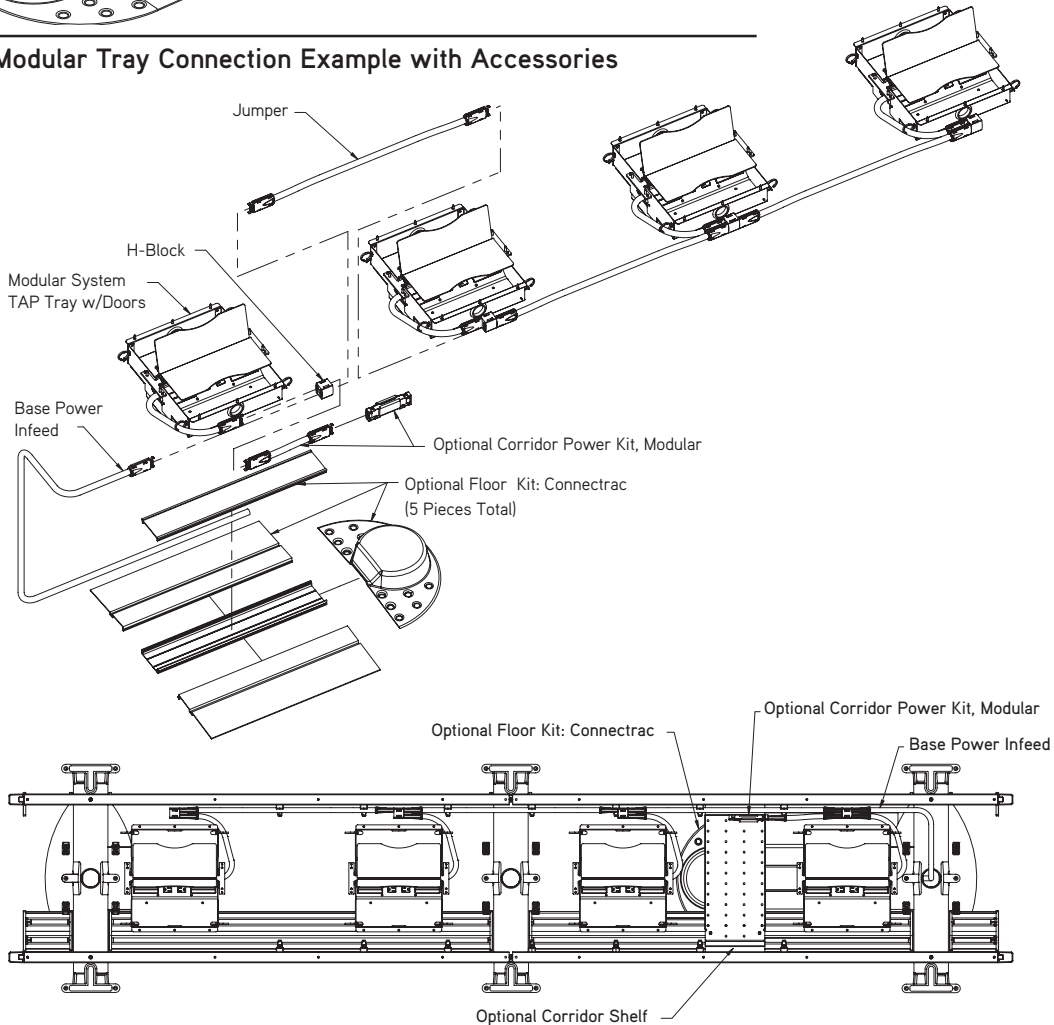

Host Collection

TAP Tray Electrical System and Faceplate Matrix

Faceplate Option— Blank AAPs

- Eight spaces for customer-supplied Extron AAP plates

Data AAPs

- Four CAT 6 data outlets
- Six spaces for customer-supplied Extron AAP plates

Data/Audio/Video AAPs

- Four CAT 6 data outlets
- Two stereo mini jacks
- Two VGA video outlets
- Four spaces for customer-supplied Extron AAP plates

Electrical System—

Cord and Plug Tray

- includes 10' cord and 15-amp plug
- Four power outlets

Option PACP

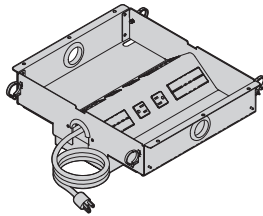

Option PDCP

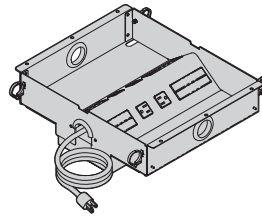

Option PAVC

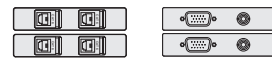
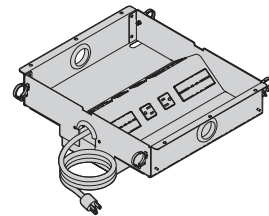

Hard-Wired Tray

- includes 6' conduit
- Four power outlets

Option PAHW

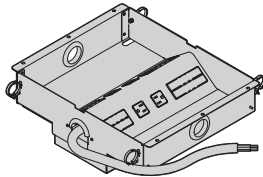

Option PDHW

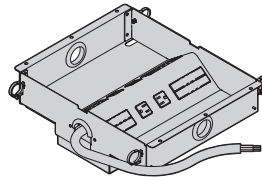

Option PAVH

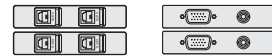
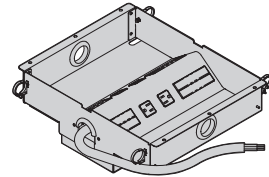

Modular Tray

- includes hardwire base power infeed and jumpers
- Four power outlets
 - Trays will alternate from Circuit 1 to Circuit 2

Option PAMH

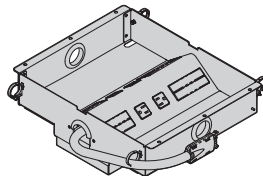

Option PDMH

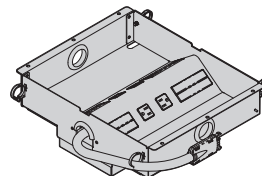

Option PVMH

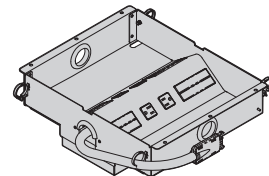

Field-Wired Tray

- includes single gang opening
- No electrical
- Tip: Electrician provides all electrical parts.*

Option PAFW

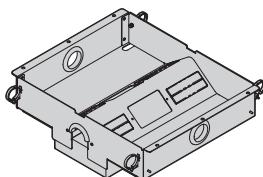

Option PDFW

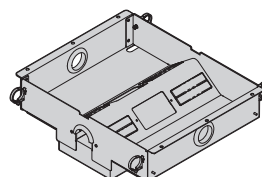

Option PVFW

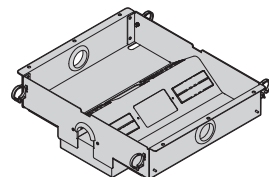

Storage Tray

Call Customer Service for availability,
1.800.627.6770

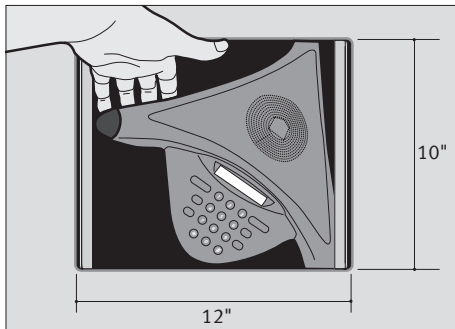
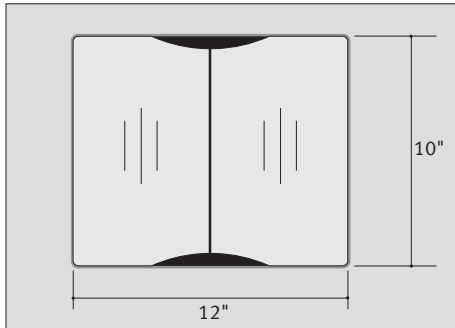

Table top opening for storage tray is 12" x 10", trimmed with a flat solid wood profile. Two doors conceal access to a black powder coated steel tray that can house equipment, such as most common speaker phones. The inside dimensions for the storage tray are 15⁷/₈" x 13³/₄" x 2¹³/₁₆".
Tip: Wood trim will match the color of the wood edge.

Only one storage tray can be specified for each table. Storage tray, if chosen, will replace one TAP on the table. If the specified table has multiple TAPs, any one of the TAPs can be replaced with a storage tray. The location of the storage tray can be determined in the field.
▶ See individual product specifying pages for TAP locations.

Storage tray doors are made of brushed anodized aluminum. storage tray doors are friction hinged, opening to 90°. Storage tray doors are fully adjustable to maintain an even appearance with the table top when closed.

Storage tray doors can be silver or black anodized or with optional wood veneer. The veneer doors will always match the finish of the table top. Veneer doors will be available on veneer tops only. Veneer doors will always be cross grain.

If storage tray is specified with TAP(s), the finish on the doors will match —silver, black or veneer.

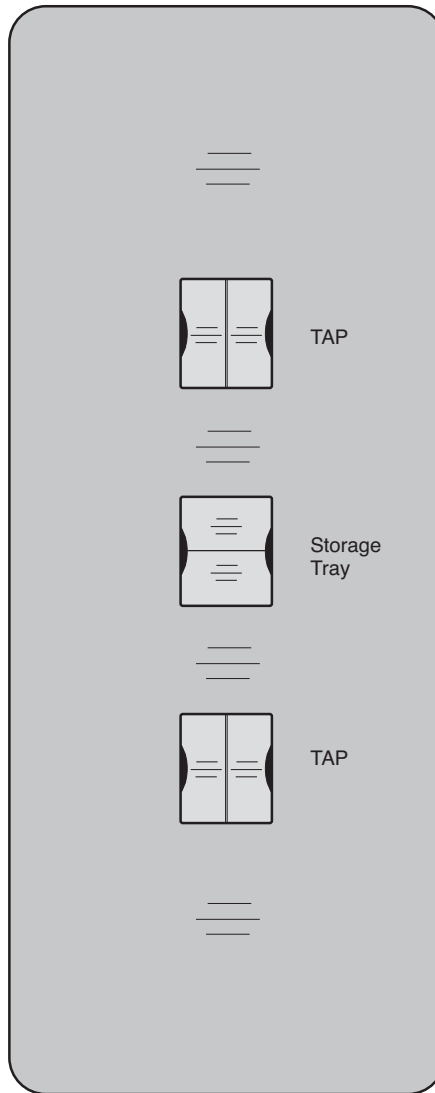

26¹/₂" Round Bases

►Page 323

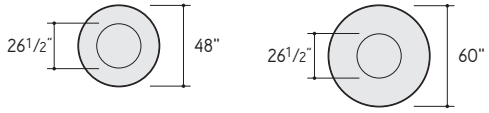

Veneer direction





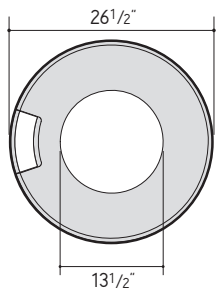



26¹/₂" Round Base Footprint

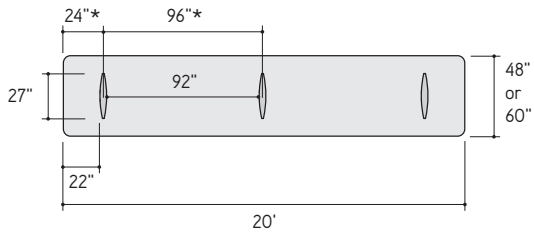
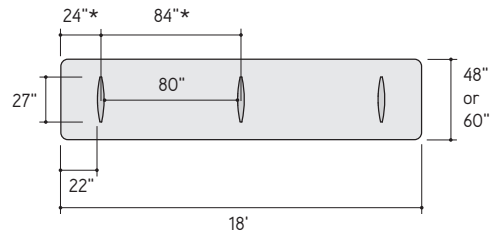
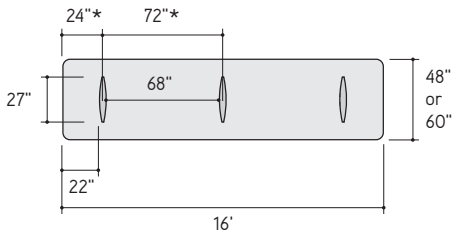
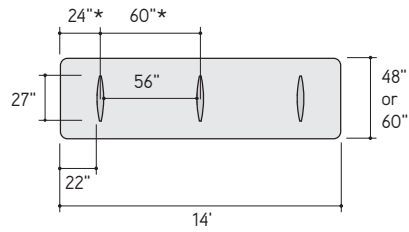
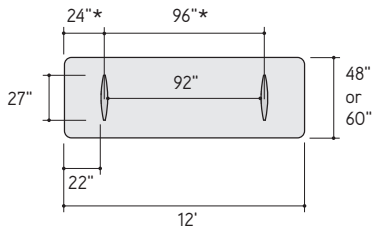
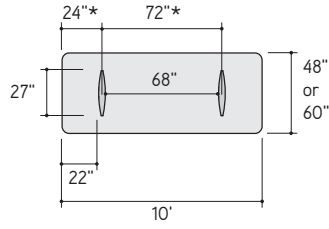
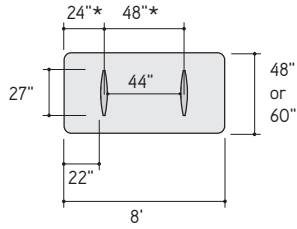

Slim Bases

►Page 323



- Rectangle (R) 
- Soft Radiused (S) 
- Racetrack (C) 
- Boat Shaped (B) 
- Trapezoid (T) 

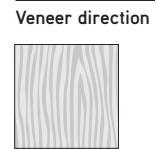

*Dimensions reference center line of base.

Bases are located in the same position for any given table top size, regardless of table shape.

27" x 4" Slim Base Footprint

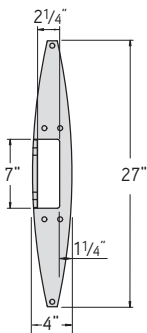

Flared Bases

►Page 323

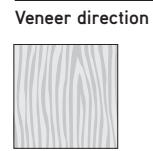
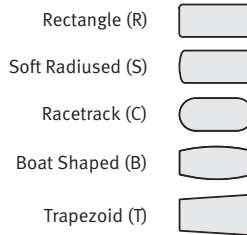
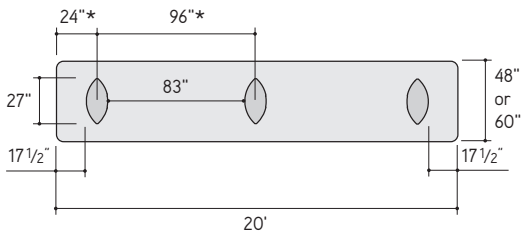
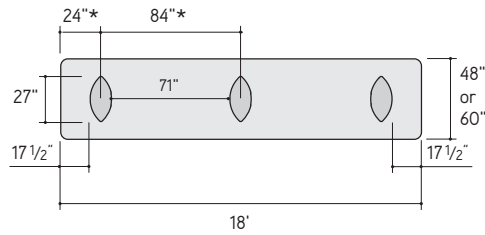
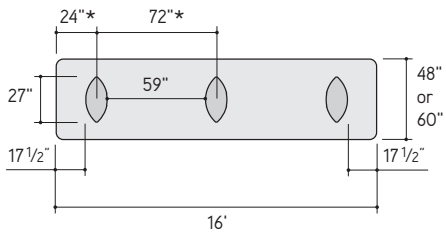
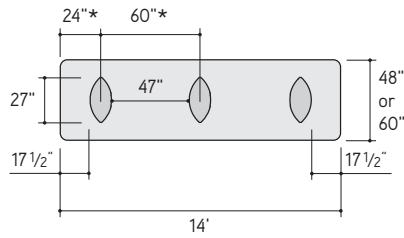
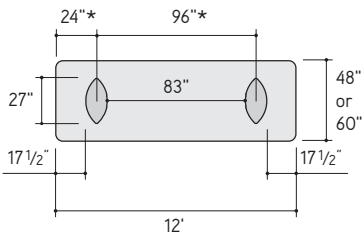
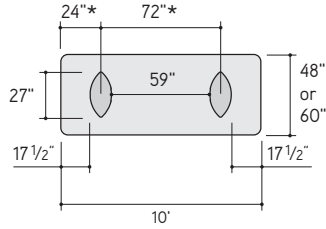
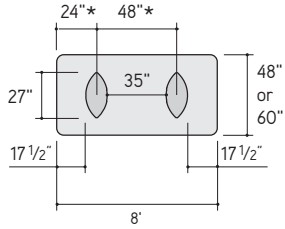

*Dimensions reference center line of base.

Bases are located in the same position for any given table top size, regardless of table shape.

27" x 13" Flared Base Footprint

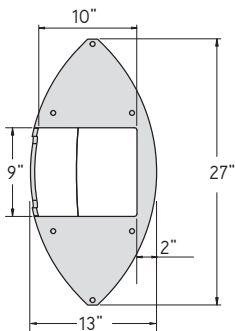

Combination Bases: Slim and Flared

►Page 323

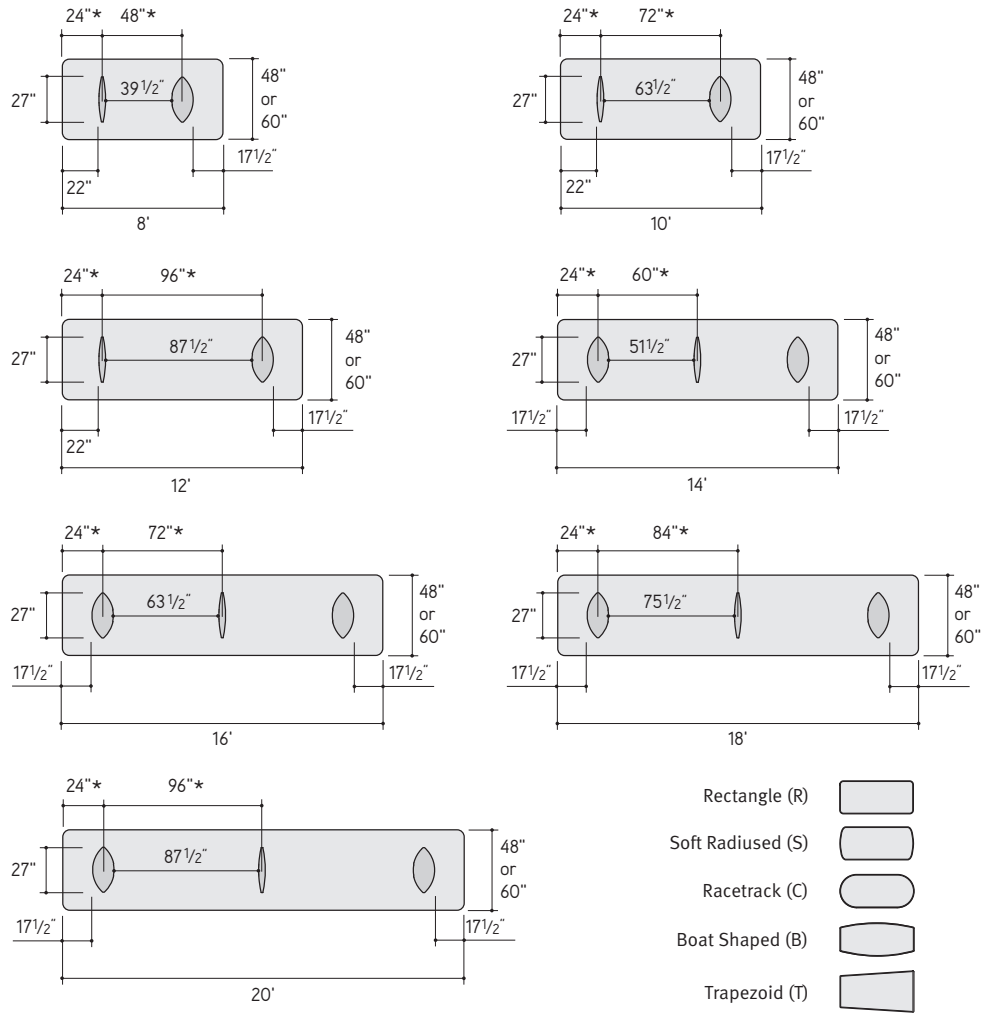

*Dimensions reference center line of base.

Bases are located in the same position for any given table top size, regardless of table shape.

27" x 4" Slim Base Footprint

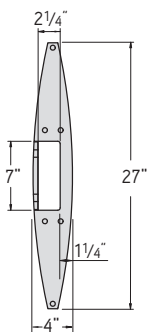

27" x 13" Flared Base Footprint

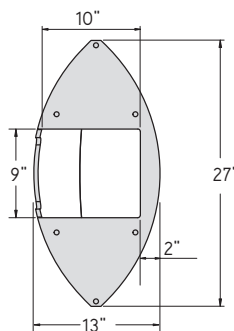

Combination Bases: Slim and Flared

►Page 323

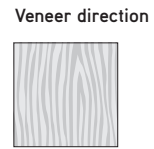
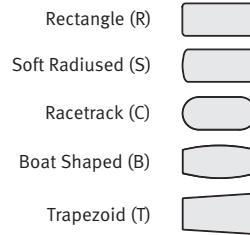
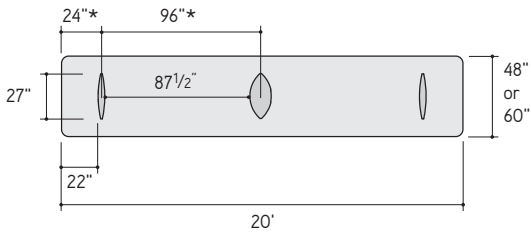
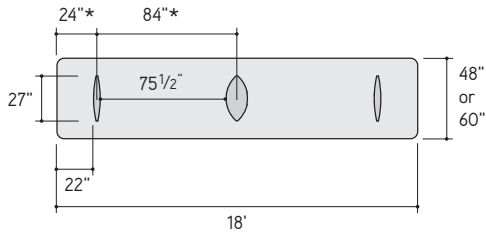
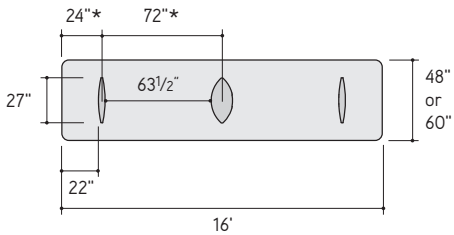
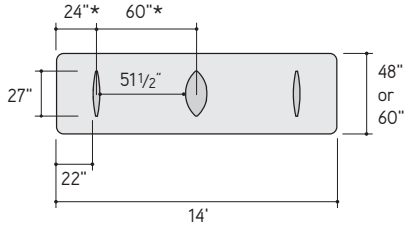

*Dimensions reference center line of base.

Bases are located in the same position for any given table top size, regardless of table shape.

27" x 4" Slim Base Footprint

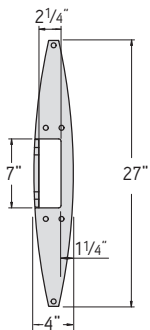

27" x 13" Flared Base Footprint

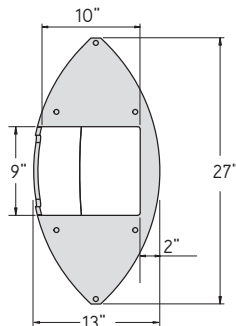

Sectioned Tops Pilot Holes

C Alignment index holes D Beam mounting holes E Base bracket mounting holes F Tech door clip mounting holes

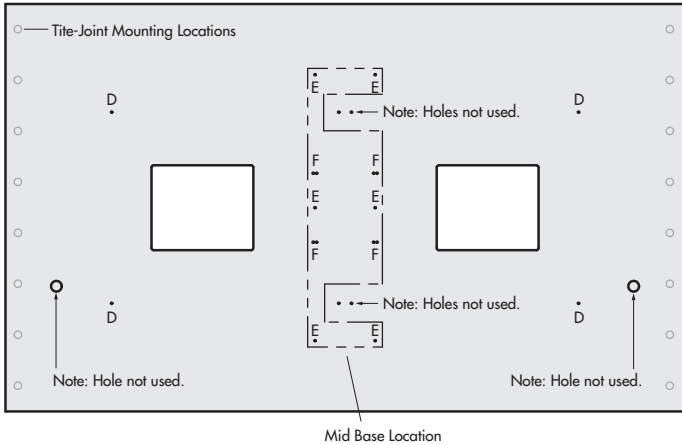
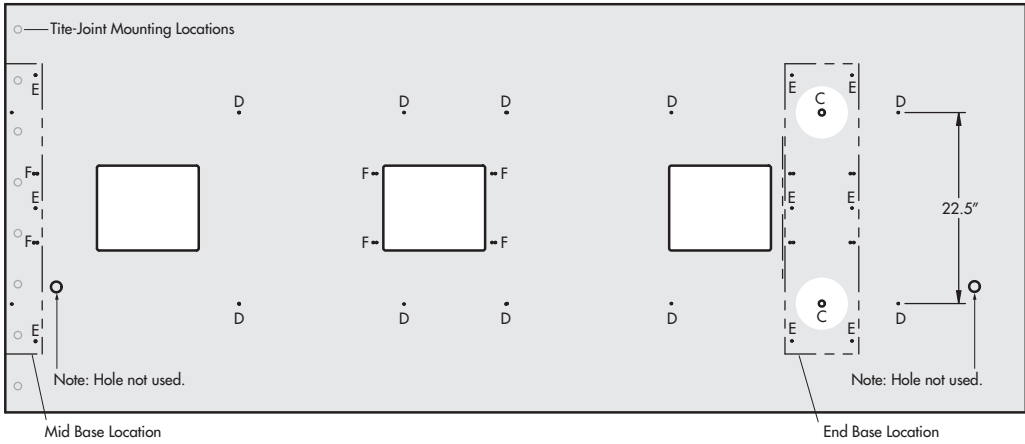

Bases are located in the same position for any given table top, regardless of table shape. Bases can be the same style or a combination of slim and flared.

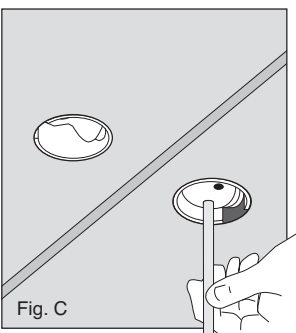
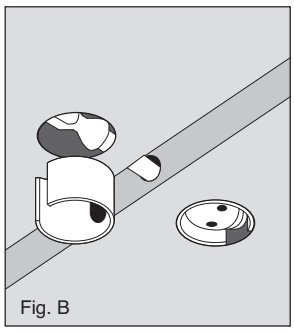
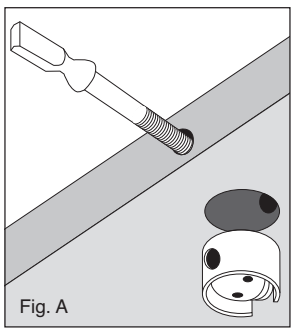

Insert tightening nuts in to alternating holes in table top sections with threaded ends towards the joint. Fig. A

Insert the draw bolts and thread each into the nut leaving 1/8" of bolt to fit into joining section. Fig. A

Insert locking sleeves into remaining holes to engage the head of the draw bolt. Fig. B
Tighten nut with tightening tool thus drawing joints together. Fig. C

Joining Sectioned Tops

Tip: For grain matching, top sections are in numbered sequence on the underside.

Align end top section with pan head screws on end base.

Insert Tite-Joint fasteners. Locate alignment bullets to aid in joining sectioned tops.

Alternate tightening tite-joint fasteners to join one section with another section. Begin with the center fastener and alternating left and right toward the outside of the top. As top sections come together, adjust tite-joints for a leveled, even seam between sections.

Level the bases.

Check alignment of the joined top on the bases.



Attach beams and bases to top.

Attach TAP doors and trays, if any, to top.

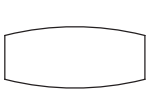
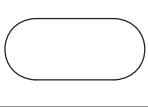
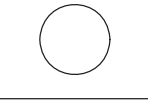
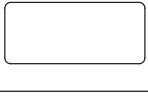
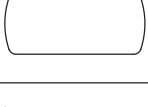

H S 9 6 4 8 R 1 2

"HOST SERIES"

TOP LENGTH		TOP WIDTH	
96"	96 IN	42"	
10'	120 IN	48"	
12'	144 IN	54"	
14'	168 IN	60"	
16'	192 IN	00" (Round)	
18'	216 IN		
20'	240 IN		
48" dia.	48 IN		
60" dia.	60 IN		

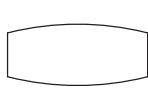
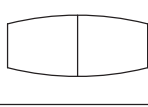
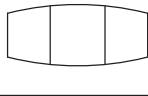
TOP SHAPE	
"B" (Boat)	
"C" (Racetrack)	
"D" (Round)	
"R" (Rectangle)	
"S" (Soft Radiused)	
"T" (Trapezoid)	

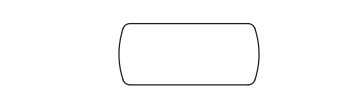
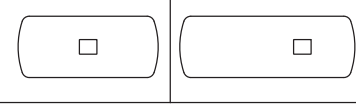
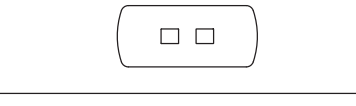
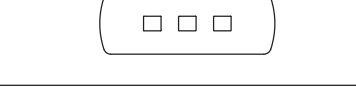
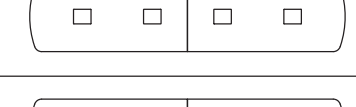
TOP SECTIONS	
"1"	
"2"	
"3"	

TAPS PER TOP	
"0"	
"1"	
"2"	
"3"	
"4"	
"6"	

Host Collection Round Tables

DESIGN F/P DESIGN AND VECTA DESIGN TEAM



Tip: Shipped knocked down and top ships in one piece.

Tip: The wood edge on a table top with woodgrain laminate may not match the top.

Veneer direction



Tip: You must send a sample of reasonable size for Stain-to-Match.

TAP Location

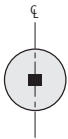

Tip: Tables available with zero or one TAP.

Tip: In addition to the data and audio/video AAPs available from Coalesse, other styles of AAPs are available through Extron Electronics. For an Extron dealer, call 1.800.633.9876.

Tip: See TAP options for electrical systems and faceplate list.

Tip: Wood veneer doors for storage tray or TAP will always be cross grain.

Tip: Veneer doors not recommended for wedge lay-up veneer tables.

Tip: Connectrac must be the same wiring schematic as the table.

Standard Includes	Required to Specify
<ul style="list-style-type: none"> ▶ Need help? Product details, page 322 • Top: 1/4" particle board core with laminate • Flat wood edge • TAP, if selected: 10"W x 12"L opening(s) trimmed with a flat solid wood profile and with brushed anodized aluminum doors: 8043 silver or 8044 black • Base: <ul style="list-style-type: none"> - Wood veneer - Concealed leveling glides: non-marring, black plastic 	<ol style="list-style-type: none"> 1 Top Style number 2 Wood color number for base 3 Laminate color number for table top, if selected 4 Wood color number for wood edge 5 Door color number for storage tray or TAP doors, if selected <ul style="list-style-type: none"> - 8043 Silver - 8044 Black 6 Options, if selected (see below) <ul style="list-style-type: none"> ▶ See <i>Surface Materials</i>, page 600.

Options	U.S. Price	Required to Specify
Surface Materials Top <ul style="list-style-type: none"> • Grade 2 laminate • Grade 1 wood veneer • Grade 2 wood veneer • Grade 1 wedge lay-up veneer • Grade 2 wedge lay-up veneer • Stain-to-Match 	<ul style="list-style-type: none"> Prices at right Prices at right Prices at right Prices at right Prices at right No cost 	<ul style="list-style-type: none"> Specify with <i>Grade 2 laminate</i> and select color number. Specify with <i>Grade 1 wood veneer</i> and select color number. Specify with <i>Grade 2 wood veneer</i> and select color number. Specify with <i>Grade 1 wedge lay-up veneer</i> and select color number. Specify with <i>Grade 2 wedge lay-up veneer</i> and select color number. Specify with <i>Stain-to-Match</i>. <p>▶ Page 5</p>
Edges Wood <ul style="list-style-type: none"> • Bullnose wood edge • Beveled wood edge • Horizon wood edge 	<ul style="list-style-type: none"> Prices at right Prices at right Prices at right 	<ul style="list-style-type: none"> Specify with <i>bullnose wood edge</i>. Specify with <i>beveled wood edge</i>. Specify with <i>Horizon wood edge</i>.

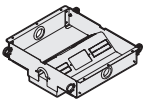
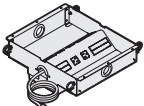
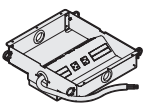
TAP Electrical System with Faceplate Options	U.S. Price	Required to Specify
▶ Page 334  Field Wired	No cost	Specify with <i>power data</i> , and select TAP type and TAP door color number.
 Cord and Plug	No cost	Specify with <i>power data</i> , and select TAP type and TAP door color number.
 Hardwired	No cost	Specify with <i>power data</i> , and select TAP type and TAP door color number.

Storage Tray ▶ Page 335	<ul style="list-style-type: none"> • Storage tray 	-\$500	Specify with <i>storage tray</i> and select door color number.
Doors	<ul style="list-style-type: none"> • Storage tray wood veneer doors • TAP wood veneer doors 	<ul style="list-style-type: none"> +\$250 per door +\$250 per door 	<ul style="list-style-type: none"> Specify with <i>wood doors</i>. Specify with <i>wood doors</i>.





Related Products	<ul style="list-style-type: none"> • Floor kit: Connectrac 		▶ Page 463
-------------------------	---	--	------------

Host Collection Round Tables

DESIGN F/P DESIGN AND VECTA DESIGN TEAM

Tip: Last digit of style number indicates number of TAP(s).

Specification Information

Style Number	Finish	U.S. Base Prices			
		 Flat Wood Edge:	 Bullnose Wood Edge:	 Beveled Wood Edge:	 Horizon Wood Edge:

48"W Diameter One Piece Top

0 TAP					
HS4800D10	Grade 1 Laminate	\$3631	\$3675	\$3736	\$4119
	Grade 2 Laminate	\$3672	\$3716	\$3777	\$4160
	Grade 1 Veneer	\$3973	\$4017	\$4078	\$4461
	Grade 2 Veneer	\$4184	\$4228	\$4289	\$4672
	Grade 1 Wedge Veneer	\$4343	\$4387	\$4448	\$4831
	Grade 2 Wedge Veneer	\$4935	\$4979	\$5040	\$5423
1 TAP					
HS4800D11	Grade 1 Laminate	\$4940	\$4984	\$5045	\$5428
	Grade 2 Laminate	\$4981	\$5025	\$5086	\$5469
	Grade 1 Veneer	\$5282	\$5326	\$5387	\$5770
	Grade 2 Veneer	\$5493	\$5537	\$5598	\$5981
	Grade 1 Wedge Veneer	\$5652	\$5696	\$5757	\$6140
	Grade 2 Wedge Veneer	\$6244	\$6288	\$6349	\$6732

60" Diameter One Piece Top

0 TAP					
HS6000D10	Grade 1 Laminate	\$3910	\$3964	\$4038	\$4436
	Grade 2 Laminate	\$3972	\$4026	\$4100	\$4498
	Grade 1 Veneer	\$4553	\$4607	\$4681	\$5079
	Grade 2 Veneer	\$4881	\$4935	\$5009	\$5407
	Grade 1 Wedge Veneer	\$5176	\$5230	\$5304	\$5702
	Grade 2 Wedge Veneer	\$6214	\$6268	\$6342	\$6740
1 TAP					
HS6000D11	Grade 1 Laminate	\$5220	\$5274	\$5348	\$5746
	Grade 2 Laminate	\$5282	\$5336	\$5410	\$5808
	Grade 1 Veneer	\$5863	\$5917	\$5991	\$6389
	Grade 2 Veneer	\$6191	\$6245	\$6319	\$6717
	Grade 1 Wedge Veneer	\$6486	\$6540	\$6614	\$7012
	Grade 2 Wedge Veneer	\$7524	\$7578	\$7652	\$8050



For Canadian Pricing
 Multiply U.S. Price by the Canadian price factor.
 ▶ See page 1 for details.

Host Collection Rectangular Tables with Two Bases

DESIGN F/P DESIGN AND VECTA DESIGN TEAM

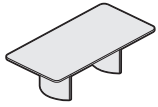

Tip: Shipped knocked down and top ships in one piece.

Tip: Grain direction for wood-grain laminate runs the length of the table.

Tip: Clips are provided with table: One clip per foot of table length.

Tip: The wood edge on a table top with woodgrain laminate may not match the top.

Tip: You must send a sample of reasonable size for Stain-to-Match.

Tip: 96"L tables available with zero, one, or two TAP(s). 10'L and 12'L tables available with zero, one, two, or three TAP(s).

Tip: In addition to the data and audio/video AAPs available from Coalesse, other styles of AAPs are available through Extron Electronics. For an Extron dealer, call 1.800.633.9876.

Tip: See TAP options for electrical systems and faceplate list.

Veneer direction

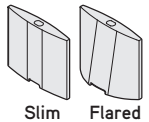
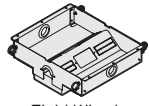
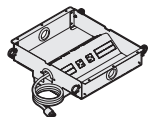
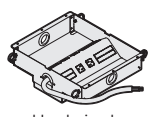

Standard Includes		Required to Specify	
<p>► Need help? Product details, page 322</p>	<ul style="list-style-type: none"> • Top: 1/4" particle board core with laminate • TAP(s) or storage tray, if selected: 10"W x 12"L opening(s) trimmed with a flat solid wood profile and with brushed anodized aluminum doors • Tech corridor: two aluminum beams for top support provide tracks for hinged aluminum doors that clip shut: satin anodized finish • Universal clip: black plastic • Two 27"W bases: wood veneer on MDF with aluminum universal bracket • Concealed leveling glides: non-marring, black plastic 	<ol style="list-style-type: none"> 1 Style number 2 Base selection (see below) and wood color number for base 3 Laminate color number for table top, if selected 4 Wood color number for wood edge 5 Door color number for storage tray or TAP doors, if selected: <ul style="list-style-type: none"> - 8043 Silver - 8044 Black 6 Options, if selected (see below) <p>► See <i>Surface Materials</i>, page 600.</p>	
Options		U.S. Price	Required to Specify
Surface Materials	Top		
	<ul style="list-style-type: none"> • Grade 2 laminate 	Prices at right	Specify with <i>Grade 2 laminate</i> and select color number.
	<ul style="list-style-type: none"> • Grade 1 wood veneer 	Prices at right	Specify with <i>Grade 1 wood veneer</i> and select color number.
	<ul style="list-style-type: none"> • Grade 2 wood veneer 	Prices at right	Specify with <i>Grade 2 wood veneer</i> and select color number.
	<ul style="list-style-type: none"> • Stain-to-Match 	No cost	Specify with <i>Stain-to-Match</i> . ► Page 5
Edges	Wood		
	<ul style="list-style-type: none"> • Bullnose wood edge • Beveled wood edge • Tapered wood edge • Horizon wood edge 	Prices at right Prices at right Prices at right Prices at right	Specify with <i>bullnose wood edge</i> . Specify with <i>beveled wood edge</i> . Specify with <i>tapered wood edge</i> . Specify with <i>Horizon wood edge</i> .
Bases	Wood		
 <p>Slim Flared</p>	<ul style="list-style-type: none"> • Two slim bases • One slim and one flared base • Two flared bases 	No cost +\$ 693 +\$1386	Specify with <i>two slim bases</i> . Specify with <i>one slim base and one flared base</i> . Specify with <i>two flared bases</i> .
TAP Electrical System with Faceplate Options	Wood		
<p>► Page 334</p>  <p>Field Wired</p>  <p>Cord and Plug</p>  <p>Hardwired</p>	<ul style="list-style-type: none"> • Field-Wired tray (no electrical) <ul style="list-style-type: none"> - PAFW Field-Wired tray (no electrical) with blank AAPs - PDFW Field-Wired tray (no electrical) with two Data AAPs - PVFW Field-Wired tray (no electrical) with two of each Video/Audio and Data AAPs • Cord and Plug tray (10' cord) <ul style="list-style-type: none"> - PACP Cord and Plug tray with outlets and blank AAPs - PDCP Cord and Plug tray with outlets and two Data AAPs - PAVC Cord and Plug tray with outlets and two of each Video/Audio and Data AAPs • Hard-Wired tray (6' conduit) <ul style="list-style-type: none"> - PAHW Hard-Wired tray with outlets and blank AAPs - PDHW Hard-Wired tray with outlets and two Data AAPs - PAVH Hard-Wired tray with outlets and two of each Video/Audio and Data AAPs 	No cost No cost No cost	Specify with <i>power data</i> , and select TAP type and TAP door color number. Specify with <i>power data</i> , and select TAP type and TAP door color number. Specify with <i>power data</i> , and select TAP type and TAP door color number.

► Options, continued on next page



For Canadian Pricing
Multiply U.S. Price by the Canadian price factor.
► See page 1 for details.

Host Collection Rectangular Tables with Two Bases

DESIGN F/P DESIGN AND VECTA DESIGN TEAM

Tip: For single TAP style numbers, the modular system tray is not available. Specify the hard-wired tray option.

Tip: If the specified table has multiple TAPs, any one TAP can be replaced with a storage tray.

Tip: Wood veneer doors for storage tray and TAP will always be cross grain.

Tip: Connectrac must be the same wiring schematic as the table.

► Options, continued from previous page

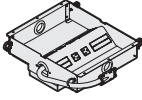
Options	U.S. Price	Required to Specify
TAP Electrical System with Faceplate Options ► Page 334  Modular	<ul style="list-style-type: none"> • Modular System tray (hardwire base power infeed) +\$119 each tray - PAMH Modular System tray with outlets and blank AAPs - PDMH Modular System tray with outlets and two Data AAPs - PVMH Modular System tray with outlets and two of each Video/Audio and Data AAPs 	Specify with <i>modular power data</i> , and select TAP type and TAP door color number.
Storage Tray ► Page 335	<ul style="list-style-type: none"> • Storage tray -\$500 	Specify with <i>storage tray</i> and select door color number.
Doors	<ul style="list-style-type: none"> • Storage tray wood veneer doors +\$250 per door • TAP wood veneer doors +\$250 per door 	Specify with <i>wood doors</i> .
Related Products	<ul style="list-style-type: none"> • Floor kit: Connectrac • Corridor shelf 	► Page 463 ► Page 463

TAP Locations

96"L x 48"W TAP Locations—One piece top

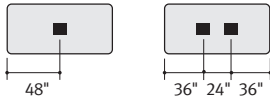

10"L x 48"W TAP Locations—One piece top

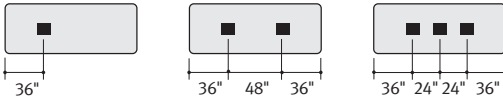

10"L x 48"W TAP Locations—Two piece top

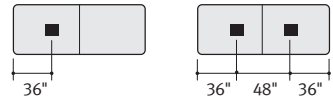

10"L x 60"W TAP Locations—One piece top

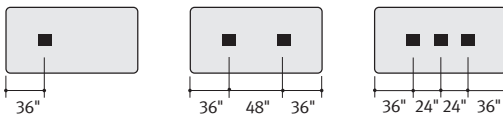

10"L x 60"W TAP Locations—Two piece top

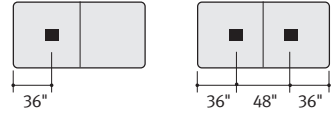

12"L x 48"W TAP Locations—One piece top

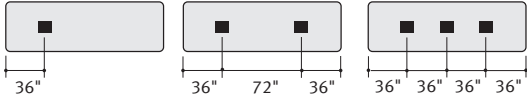

12"L x 48"W TAP Locations—Two piece top



12"L x 60"W TAP Locations—One piece top

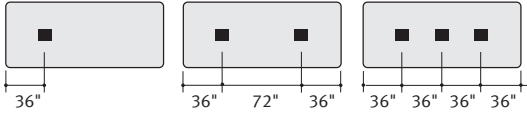

12"L x 60"W TAP Locations—Two piece top

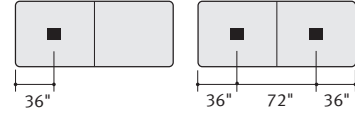

► Specification Information on next page

Host Collection

For Canadian Pricing
 Multiply U.S. Price by the Canadian price factor.
 ► See page 1 for details.

Host Collection Rectangular Tables with Two Bases *continued*





DESIGN F/P DESIGN AND VECTA DESIGN TEAM

Tip: Prices shown include top, TAP(s), and slim bases.
 ▶ See base options for flared bases, page 346

Tip: Last digit of style number indicates number of TAP(s).

▶ Options on previous page

Specification Information

Style Number	Finish	U.S. Base Prices			
					
		Flat Wood Edge:	Bullnose Wood Edge:	Beveled Wood Edge, Tapered Wood Edge:	Horizon Wood Edge:

96"L x 48"W One Piece Top

0 TAP

HS9648R10	Grade 1 Laminate	\$5623	\$5707	\$ 5822	\$ 6919
	Grade 2 Laminate	\$5722	\$5806	\$ 5921	\$ 7018
	Grade 1 Veneer	\$6049	\$6133	\$ 6248	\$ 7345
	Grade 2 Veneer	\$6555	\$6639	\$ 6754	\$ 7851

1 TAP

HS9648R11	Grade 1 Laminate	\$6933	\$7017	\$ 7132	\$ 8229
	Grade 2 Laminate	\$7032	\$7116	\$ 7231	\$ 8328
	Grade 1 Veneer	\$7359	\$7443	\$ 7558	\$ 8655
	Grade 2 Veneer	\$7865	\$7949	\$ 8064	\$ 9161

2 TAPS

HS9648R12	Grade 1 Laminate	\$8243	\$8327	\$ 8442	\$ 9539
	Grade 2 Laminate	\$8342	\$8426	\$ 8541	\$ 9638
	Grade 1 Veneer	\$8669	\$8753	\$ 8868	\$ 9965
	Grade 2 Veneer	\$9175	\$9259	\$ 9374	\$10,471

10'L x 48"W One Piece Top

0 TAP

HS1048R10	Grade 1 Laminate	\$6064	\$6161	\$ 6295	\$ 7415
	Grade 2 Laminate	\$6188	\$6285	\$ 6419	\$ 7539
	Grade 1 Veneer	\$6582	\$6679	\$ 6813	\$ 7933
	Grade 2 Veneer	\$7214	\$7311	\$ 7445	\$ 8565

1 TAP

HS1048R11	Grade 1 Laminate	\$7373	\$7470	\$ 7604	\$ 8724
	Grade 2 Laminate	\$7497	\$7594	\$ 7728	\$ 8848
	Grade 1 Veneer	\$7891	\$7988	\$ 8122	\$ 9242
	Grade 2 Veneer	\$8523	\$8620	\$ 8754	\$ 9874

2 TAPS

HS1048R12	Grade 1 Laminate	\$8683	\$8780	\$ 8914	\$10,034
	Grade 2 Laminate	\$8807	\$8904	\$ 9038	\$10,158
	Grade 1 Veneer	\$9201	\$9298	\$ 9432	\$10,552
	Grade 2 Veneer	\$9833	\$9930	\$10,064	\$ 11,184

▶ Specification Information, continued on next page

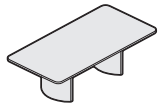

Tip: For tech corridor, 96"L tables have two long doors and four short doors.

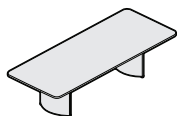
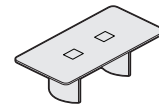
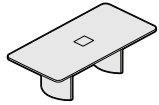

Tip: For tech corridor, 10'L tables have four long doors and four short doors.

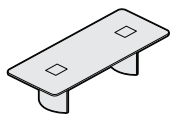
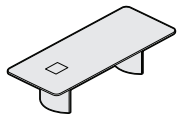

For Canadian Pricing
 Multiply U.S. Price by the Canadian price factor.
 ▶ See page 1 for details.

Host Collection Rectangular Tables with Two Bases





DESIGN F/P DESIGN AND VECTA DESIGN TEAM

Tip: Prices shown include top, TAP(s), and slim bases.
 ▶ See base options for flared bases, page 346

Tip: Last digit of style number indicates number of TAP(s).

▶ Specification Information, continued from previous page

Specification Information

Style Number	Finish	U.S. Base Prices			
					
		Flat Wood Edge:	Bullnose Wood Edge:	Beveled Wood Edge, Tapered Wood Edge:	Horizon Wood Edge:

10'L x 48"W One Piece Top

3 TAPS

Style Number	Finish	Flat Wood Edge	Bullnose Wood Edge	Beveled Wood Edge, Tapered Wood Edge	Horizon Wood Edge
HS1048R13	Grade 1 Laminate	\$ 9993	\$10,090	\$10,224	\$11,344
	Grade 2 Laminate	\$10,117	\$10,214	\$10,348	\$11,468
	Grade 1 Veneer	\$10,511	\$10,608	\$10,742	\$11,862
	Grade 2 Veneer	\$11,143	\$11,240	\$11,374	\$12,494

10'L x 48"W Two Piece Top

0 TAP

Style Number	Finish	Flat Wood Edge	Bullnose Wood Edge	Beveled Wood Edge, Tapered Wood Edge	Horizon Wood Edge
HS1048R20	Grade 1 Laminate	\$ 6377	\$ 6474	\$ 6608	\$ 7728
	Grade 2 Laminate	\$ 6501	\$ 6598	\$ 6732	\$ 7852
	Grade 1 Veneer	\$ 6895	\$ 6992	\$ 7126	\$ 8246
	Grade 2 Veneer	\$ 7527	\$ 7624	\$ 7758	\$ 8878

1 TAP

Style Number	Finish	Flat Wood Edge	Bullnose Wood Edge	Beveled Wood Edge, Tapered Wood Edge	Horizon Wood Edge
HS1048R21	Grade 1 Laminate	\$ 7687	\$ 7784	\$ 7918	\$ 9038
	Grade 2 Laminate	\$ 7811	\$ 7908	\$ 8042	\$ 9162
	Grade 1 Veneer	\$ 8205	\$ 8302	\$ 8436	\$ 9556
	Grade 2 Veneer	\$ 8837	\$ 8934	\$ 9068	\$10,188

2 TAPS

Style Number	Finish	Flat Wood Edge	Bullnose Wood Edge	Beveled Wood Edge, Tapered Wood Edge	Horizon Wood Edge
HS1048R22	Grade 1 Laminate	\$ 8997	\$ 9094	\$ 9228	\$10,348
	Grade 2 Laminate	\$ 9121	\$ 9218	\$ 9352	\$10,472
	Grade 1 Veneer	\$ 9515	\$ 9612	\$ 9746	\$10,866
	Grade 2 Veneer	\$10,147	\$10,244	\$10,378	\$11,498

10'L x 60"W One Piece Top

0 TAP

Style Number	Finish	Flat Wood Edge	Bullnose Wood Edge	Beveled Wood Edge, Tapered Wood Edge	Horizon Wood Edge
HS1060R10	Grade 1 Laminate	\$ 6226	\$ 6330	\$ 6474	\$ 7604
	Grade 2 Laminate	\$ 6381	\$ 6485	\$ 6629	\$ 7759
	Grade 1 Veneer	\$ 7139	\$ 7243	\$ 7387	\$ 8517
	Grade 2 Veneer	\$ 7938	\$ 8042	\$ 8186	\$ 9316

1 TAP

Style Number	Finish	Flat Wood Edge	Bullnose Wood Edge	Beveled Wood Edge, Tapered Wood Edge	Horizon Wood Edge
HS1060R11	Grade 1 Laminate	\$ 7535	\$ 7639	\$ 7783	\$ 8913
	Grade 2 Laminate	\$ 7690	\$ 7794	\$ 7938	\$ 9068
	Grade 1 Veneer	\$ 8448	\$ 8552	\$ 8696	\$ 9826
	Grade 2 Veneer	\$ 9247	\$ 9351	\$ 9495	\$10,625

▶ Specification Information, continued on next page

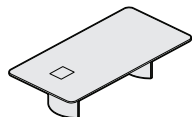
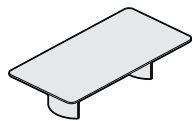
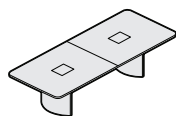
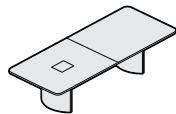
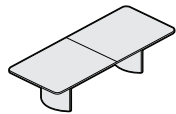
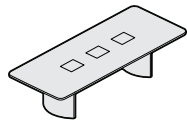

 **For Canadian Pricing**
 Multiply U.S. Price by the Canadian price factor.
 ▶ See page 1 for details.

Host Collection Rectangular Tables with Two Bases *continued*





DESIGN F/P DESIGN AND VECTA DESIGN TEAM

Tip: Prices shown include top, TAP(s), and slim bases.
 ▶ See base options for flared bases, page 346

Tip: Last digit of style number indicates number of TAP(s).

▶ Specification Information, continued from previous page

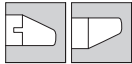
Specification Information

Style Number	Finish	U.S. Base Prices			
					
		Flat Wood Edge:	Bullnose Wood Edge:	Beveled Wood Edge, Tapered Wood Edge:	Horizon Wood Edge:

10'L x 60"W One Piece Top, continued

2 TAPS

HS1060R12	Grade 1 Laminate	\$ 8845	\$ 8949	\$ 9093	\$10,223
	Grade 2 Laminate	\$ 9000	\$ 9104	\$ 9248	\$10,378
	Grade 1 Veneer	\$ 9758	\$ 9862	\$10,006	\$11,136
	Grade 2 Veneer	\$10,557	\$10,661	\$10,805	\$11,935

3 TAPS

HS1060R13	Grade 1 Laminate	\$10,155	\$10,259	\$10,403	\$11,533
	Grade 2 Laminate	\$10,310	\$10,414	\$10,558	\$11,688
	Grade 1 Veneer	\$11,068	\$11,172	\$11,316	\$12,446
	Grade 2 Veneer	\$11,867	\$11,971	\$12,115	\$13,245

10'L x 60"W Two Piece Top

0 TAP

HS1060R20	Grade 1 Laminate	\$ 6539	\$ 6643	\$ 6787	\$ 7917
	Grade 2 Laminate	\$ 6694	\$ 6798	\$ 6942	\$ 8072
	Grade 1 Veneer	\$ 7452	\$ 7556	\$ 7700	\$ 8830
	Grade 2 Veneer	\$ 8251	\$ 8355	\$ 8499	\$ 9629

1 TAP

HS1060R21	Grade 1 Laminate	\$ 7849	\$ 7953	\$ 8097	\$ 9227
	Grade 2 Laminate	\$ 8004	\$ 8108	\$ 8252	\$ 9382
	Grade 1 Veneer	\$ 8762	\$ 8866	\$ 9010	\$10,140
	Grade 2 Veneer	\$ 9561	\$ 9665	\$ 9809	\$10,939

2 TAPS

HS1060R22	Grade 1 Laminate	\$ 9159	\$ 9263	\$ 9407	\$10,537
	Grade 2 Laminate	\$ 9314	\$ 9418	\$ 9562	\$10,692
	Grade 1 Veneer	\$10,072	\$10,176	\$10,320	\$11,450
	Grade 2 Veneer	\$10,871	\$10,975	\$ 11,119	\$12,249

▶ Specification Information, continued on next page

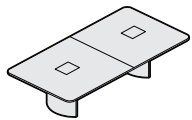
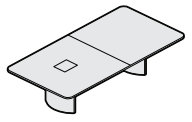
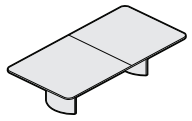
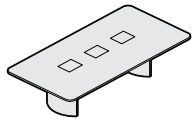
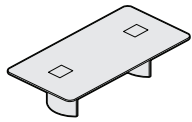

For Canadian Pricing
 Multiply U.S. Price by the Canadian price factor.
 ▶ See page 1 for details.

Host Collection Rectangular Tables with Two Bases

DESIGN F/P DESIGN AND VECTA DESIGN TEAM

Tip: Prices shown include top, TAP(s), and slim bases.
 ▶ See base options for flared bases, page 346

Tip: Last digit of style number indicates number of TAP(s).

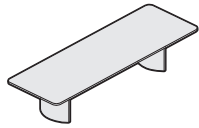

Tip: For tech corridor, 12'L tables have four long doors and four short doors.

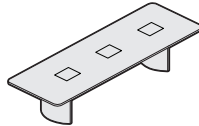
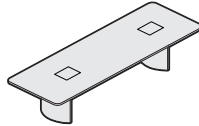
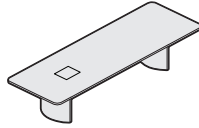

▶ Specification Information, continued from previous page

Specification Information

Style Number	Finish	U.S. Base Prices			
		Flat Wood Edge:	Bullnose Wood Edge:	Beveled Wood Edge, Tapered Wood Edge:	Horizon Wood Edge:

12'L x 48''W One Piece Top

0 TAP					
HS1248R10	Grade 1 Laminate	\$ 6454	\$ 6565	\$ 6717	\$ 7858
	Grade 2 Laminate	\$ 6603	\$ 6714	\$ 6866	\$ 8007
	Grade 1 Veneer	\$ 7139	\$ 7250	\$ 7402	\$ 8543
	Grade 2 Veneer	\$ 7901	\$ 8012	\$ 8164	\$ 9305
1 TAP					
HS1248R11	Grade 1 Laminate	\$ 7764	\$ 7875	\$ 8027	\$ 9168
	Grade 2 Laminate	\$ 7913	\$ 8024	\$ 8176	\$ 9317
	Grade 1 Veneer	\$ 8449	\$ 8560	\$ 8712	\$ 9853
	Grade 2 Veneer	\$ 9211	\$ 9322	\$ 9474	\$10,615
2 TAPS					
HS1248R12	Grade 1 Laminate	\$ 9074	\$ 9185	\$ 9337	\$10,478
	Grade 2 Laminate	\$ 9223	\$ 9334	\$ 9486	\$10,627
	Grade 1 Veneer	\$ 9759	\$ 9870	\$10,022	\$11,163
	Grade 2 Veneer	\$10,521	\$10,632	\$10,784	\$11,925
3 TAPS					
HS1248R13	Grade 1 Laminate	\$10,384	\$10,495	\$10,647	\$11,788
	Grade 2 Laminate	\$10,533	\$10,644	\$10,796	\$11,937
	Grade 1 Veneer	\$11,069	\$11,180	\$11,332	\$12,473
	Grade 2 Veneer	\$11,831	\$11,942	\$12,094	\$13,235

▶ Specification Information, continued on next page



For Canadian Pricing
 Multiply U.S. Price by the Canadian price factor.
 ▶ See page 1 for details.

Host Collection Rectangular Tables with Two Bases *continued*





DESIGN F/P DESIGN AND VECTA DESIGN TEAM

Tip: Prices shown include top, TAP(s), and slim bases.
 ▶ See base options for flared bases, page 346

Tip: Last digit of style number indicates number of TAP(s).

▶ Specification Information, continued from previous page

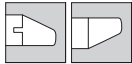
Specification Information

Style Number	Finish	U.S. Base Prices			
					
		Flat Wood Edge:	Bullnose Wood Edge:	Beveled Wood Edge, Tapered Wood Edge:	Horizon Wood Edge:

12'L x 48"W Two Piece Top

0 TAP

HS1248R20	Grade 1 Laminate	\$ 6767	\$ 6878	\$ 7030	\$ 8171
	Grade 2 Laminate	\$ 6916	\$ 7027	\$ 7179	\$ 8320
	Grade 1 Veneer	\$ 7452	\$ 7563	\$ 7715	\$ 8856
	Grade 2 Veneer	\$ 8214	\$ 8325	\$ 8477	\$ 9618

1 TAP

HS1248R21	Grade 1 Laminate	\$ 8078	\$ 8189	\$ 8341	\$ 9482
	Grade 2 Laminate	\$ 8227	\$ 8338	\$ 8490	\$ 9631
	Grade 1 Veneer	\$ 8763	\$ 8874	\$ 9026	\$10,167
	Grade 2 Veneer	\$ 9525	\$ 9636	\$ 9788	\$10,929

2 TAPS

HS1248R22	Grade 1 Laminate	\$ 9388	\$ 9499	\$ 9651	\$10,792
	Grade 2 Laminate	\$ 9537	\$ 9648	\$ 9800	\$10,941
	Grade 1 Veneer	\$10,073	\$10,184	\$10,336	\$11,477
	Grade 2 Veneer	\$10,835	\$10,946	\$11,098	\$12,239

12'L x 60"W One Piece Top

0 TAP

HS1260R10	Grade 1 Laminate	\$ 6625	\$ 6742	\$ 6905	\$ 8056
	Grade 2 Laminate	\$ 6811	\$ 6928	\$ 7091	\$ 8242
	Grade 1 Veneer	\$ 7747	\$ 7864	\$ 8027	\$ 9178
	Grade 2 Veneer	\$ 8707	\$ 8824	\$ 8987	\$10,138

1 TAP

HS1260R11	Grade 1 Laminate	\$ 7935	\$ 8052	\$ 8215	\$ 9366
	Grade 2 Laminate	\$ 8121	\$ 8238	\$ 8401	\$ 9552
	Grade 1 Veneer	\$ 9057	\$ 9174	\$ 9337	\$10,488
	Grade 2 Veneer	\$10,017	\$10,134	\$10,297	\$11,448

2 TAPS

HS1260R12	Grade 1 Laminate	\$ 9245	\$ 9362	\$ 9525	\$10,676
	Grade 2 Laminate	\$ 9431	\$ 9548	\$ 9711	\$10,862
	Grade 1 Veneer	\$10,367	\$10,484	\$10,647	\$11,798
	Grade 2 Veneer	\$11,327	\$11,444	\$11,607	\$12,758

▶ Specification Information, continued on next page

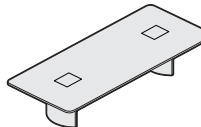
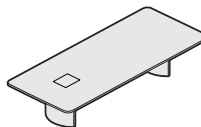
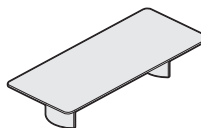
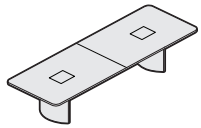
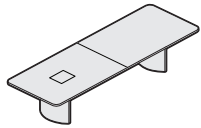
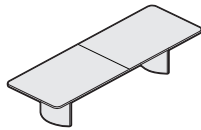

For Canadian Pricing
 Multiply U.S. Price by the Canadian price factor.
 ▶ See page 1 for details.

Host Collection Rectangular Tables with Two Bases





DESIGN F/P DESIGN AND VECTA DESIGN TEAM

Tip: Prices shown include top, TAP(s), and slim bases.
 ▶ See base options for flared bases, page 346

Tip: Last digit of style number indicates number of TAP(s).

▶ Specification Information, continued from previous page

Specification Information

Style Number	Finish	U.S. Base Prices			
					
		Flat Wood Edge:	Bullnose Wood Edge:	Beveled Wood Edge, Tapered Wood Edge:	Horizon Wood Edge:

12'L x 60"W One Piece Top, continued

3 TAPS

HS1260R13	Grade 1 Laminate	\$10,555	\$10,672	\$10,835	\$11,986
	Grade 2 Laminate	\$10,741	\$10,858	\$11,021	\$12,172
	Grade 1 Veneer	\$11,677	\$11,794	\$11,957	\$13,108
	Grade 2 Veneer	\$12,637	\$12,754	\$12,917	\$14,068

12'L x 60"W Two Piece Top

0 TAP

HS1260R20	Grade 1 Laminate	\$ 6938	\$ 7055	\$ 7218	\$ 8369
	Grade 2 Laminate	\$ 7124	\$ 7241	\$ 7404	\$ 8555
	Grade 1 Veneer	\$ 8060	\$ 8177	\$ 8340	\$ 9491
	Grade 2 Veneer	\$ 9020	\$ 9137	\$ 9300	\$10,451

1 TAP

HS1260R21	Grade 1 Laminate	\$ 8249	\$ 8366	\$ 8529	\$ 9680
	Grade 2 Laminate	\$ 8435	\$ 8552	\$ 8715	\$ 9866
	Grade 1 Veneer	\$ 9371	\$ 9488	\$ 9651	\$10,802
	Grade 2 Veneer	\$10,331	\$10,448	\$10,611	\$11,762

2 TAPS

HS1260R22	Grade 1 Laminate	\$ 9559	\$ 9676	\$ 9839	\$10,990
	Grade 2 Laminate	\$ 9745	\$ 9862	\$10,025	\$11,176
	Grade 1 Veneer	\$10,681	\$10,798	\$10,961	\$12,112
	Grade 2 Veneer	\$11,641	\$11,758	\$11,921	\$13,072

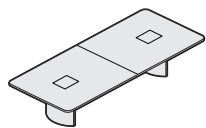
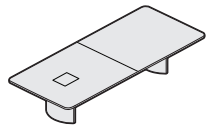
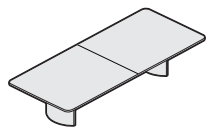
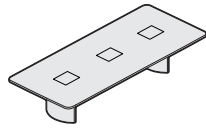

For Canadian Pricing
 Multiply U.S. Price by the Canadian price factor.
 ▶ See page 1 for details.

Host Collection Rectangular Tables with Three Bases

DESIGN F/P DESIGN AND VECTA DESIGN TEAM

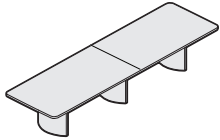

Tip: Shipped knocked down and top ships in one piece.

Tip: Grain direction for wood-grain laminate runs the length of the table.

Tip: Clips are provided with table: One clip per foot of table length.

Tip: The wood edge on a table top with woodgrain laminate may not match the top.

Tip: You must send a sample of reasonable size for Stain-to-Match.





Tip: 14'L and 16'L tables available with zero, one, two, or four TAP(s). 18'L and 20'L tables available with zero, one, two, four, or six TAP(s).

Tip: In addition to the data and audio/video AAPs available from Coalesse, other styles of AAPs are available through Extron Electronics. For an Extron dealer, call 1.800.633.9876.

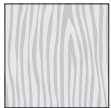
Tip: See TAP options for electrical systems and faceplate list.

Veneer direction

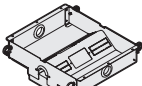

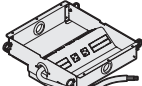
Standard Includes		Required to Specify	
<ul style="list-style-type: none"> ▶ Need help? Product details, page 322 	<ul style="list-style-type: none"> • Top: 1/4" particle board core with laminate • Flat wood edge • TAP(s), if selected: 10"W x 12"L opening(s) trimmed with a flat solid wood profile and with brushed anodized aluminum TAP doors: • Tech corridor: four aluminum beams for top support provide tracks for hinged aluminum doors that clip shut: satin anodized finish • Universal clip: black plastic • Three 27"W bases: wood veneer on MDF with aluminum universal bracket • Concealed leveling glides: non-marring, black plastic 	<ol style="list-style-type: none"> 1 Style number 2 Base selection (see below) and wood color number for base 3 Laminate color number for table top, if selected 4 Wood color number for wood edge 5 Door color number for storage tray or TAP door, if selected: <ul style="list-style-type: none"> - 8043 Silver - 8044 Black 6 Options, if selected (see below) 	<ul style="list-style-type: none"> ▶ See <i>Surface Materials</i>, page 600.
Options		U.S. Price	Required to Specify
Surface Materials	Top		
	<ul style="list-style-type: none"> • Grade 2 laminate 	Prices at right	Specify with <i>Grade 2 laminate</i> and select color number.
	<ul style="list-style-type: none"> • Grade 1 wood veneer 	Prices at right	Specify with <i>Grade 1 wood veneer</i> and select color number.
	<ul style="list-style-type: none"> • Grade 2 wood veneer 	Prices at right	Specify with <i>Grade 2 wood veneer</i> and select color number.
	<ul style="list-style-type: none"> • Stain-to-Match 	No cost	Specify with <i>Stain-to-Match</i> . ▶ Page 5
Edges	Wood		
	<ul style="list-style-type: none"> • Bullnose wood edge 	Prices at right	Specify with <i>bullnose wood edge</i> .
	<ul style="list-style-type: none"> • Beveled wood edge 	Prices at right	Specify with <i>beveled wood edge</i> .
	<ul style="list-style-type: none"> • Tapered wood edge 	Prices at right	Specify with <i>tapered wood edge</i> .
	<ul style="list-style-type: none"> • Horizon wood edge 	Prices at right	Specify with <i>Horizon wood edge</i> .
Bases			
			
Slim	Flared		
	<ul style="list-style-type: none"> • Three slim bases • Two slim and one flared bases • One slim and two flared bases • Three flared bases 	No cost +\$ 693 +\$1386 +\$2079	Specify with <i>three slim bases</i> . Specify with <i>two slim and one flared bases</i> . Specify with <i>one slim and two flared bases</i> . Specify with <i>three flared bases</i> .
TAP Electrical System with Faceplate Options			
▶ Pages 334			
			
Field Wired	<ul style="list-style-type: none"> • Field-Wired tray (no electrical) <ul style="list-style-type: none"> - PAFW Field-Wired tray (no electrical) with blank AAPs - PDFW Field-Wired tray (no electrical) with two Data AAPs - PVFW Field-Wired tray (no electrical) with two of each Video/Audio and Data AAPs 	No cost	Specify with <i>power data</i> , and select TAP type and TAP door color number.
			
Cord and Plug	<ul style="list-style-type: none"> • Cord and Plug tray (10' cord) <ul style="list-style-type: none"> - PACP Cord and Plug tray with outlets and blank AAPs - PDCP Cord and Plug tray with outlets and two Data AAPs - PAVC Cord and Plug tray with outlets and two of each Video/Audio and Data AAPs 	No cost	Specify with <i>power data</i> , and select TAP type and TAP door color number.
			
Hardwired	<ul style="list-style-type: none"> • Hard-Wired tray (6' conduit) <ul style="list-style-type: none"> - PAHW Hard-Wired tray with outlets and blank AAPs - PDHW Hard-Wired tray with outlets and two Data AAPs - PAVH Hard-Wired tray with outlets and two of each Video/Audio and Data AAPs 	No cost	Specify with <i>power data</i> , and select TAP type and TAP door color number.

▶ Options, continued on next page



For Canadian Pricing
Multiply U.S. Price by the Canadian price factor.
▶ See page 1 for details.

Host Collection Rectangular Tables with Three Bases

DESIGN F/P DESIGN AND VECTA DESIGN TEAM

Tip: For single TAP style numbers, the modular system tray is not available. Specify the hardwired tray option.

Tip: If the specified table has multiple TAP(s), any one TAP can be replaced with a storage tray.

Tip: Wood veneer doors for storage tray and TAP will always be cross grain.

Tip: Connectrac must be the same wiring schematic as the table.

►Options, continued from previous page

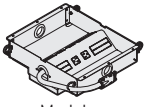
Options	U.S. Price	Required to Specify
TAP Electrical System with Faceplate Options ▶ Pages 334  Modular	<ul style="list-style-type: none"> • Modular System tray (hardwire base power infeed) +\$119 each tray - PAMH Modular System tray with outlets and blank AAPs - PDMH Modular System tray with outlets and two Data AAPs - PVMH Modular System tray with outlets and two of each Video/Audio and Data AAPs 	Specify with <i>modular power data</i> , and select TAP type and TAP door color number.
Storage Tray ▶ Page 335	<ul style="list-style-type: none"> • Storage tray -\$500 	Specify with <i>storage tray</i> and select door color number.
Doors	<ul style="list-style-type: none"> • Storage tray wood veneer doors +\$250 per door • TAP wood veneer doors +\$250 per door 	Specify with <i>wood doors</i> .
Related Products	<ul style="list-style-type: none"> • Floor kit: Connectrac • Corridor shelf 	▶ Page 463 ▶ Page 463

TAP Locations

14'L x 48"W TAP Locations—Two piece top

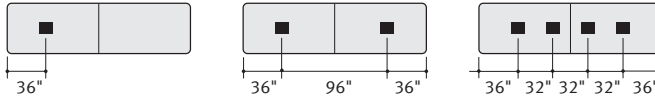

14'L x 48"W TAP Locations—Three piece top

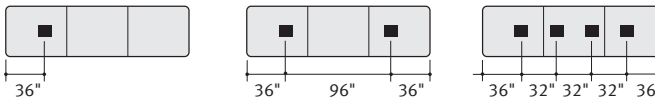

14'L x 60"W TAP Locations—Two piece top

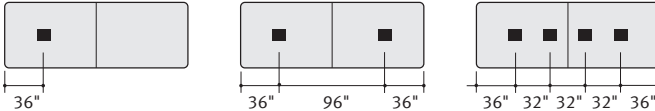

14'L x 60"W TAP Locations—Three piece top

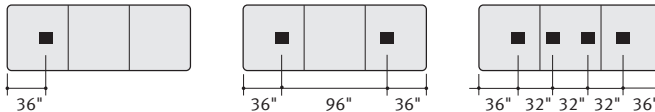

►Options, continued on next page

Host Collection



For Canadian Pricing
 Multiply U.S. Price by the Canadian price factor.
 ▶ See page 1 for details.

Host Collection Rectangular Tables with Three Bases *continued*

DESIGN F/P DESIGN AND VECTA DESIGN TEAM

►Options, continued from previous page

TAP Locations

16'L x 48"W TAP Locations—Two piece top

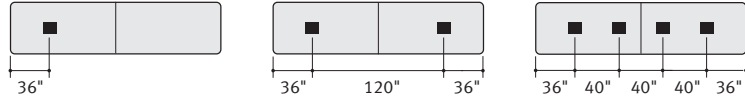

16'L x 48"W TAP Locations—Three piece top

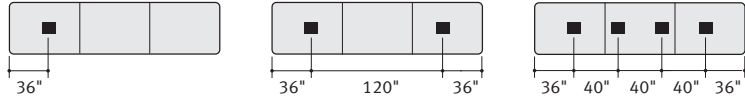

16'L x 60"W TAP Locations—Two piece top

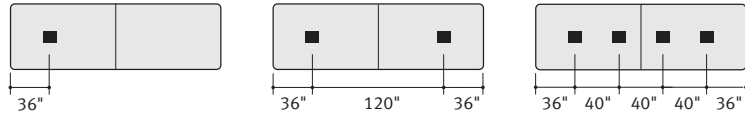

16'L x 60"W TAP Locations—Three piece top

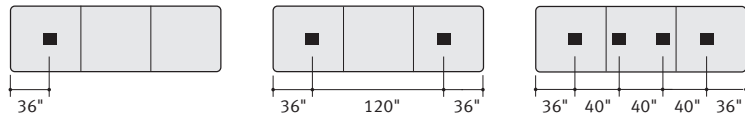

18'L x 48"W TAP Locations—Two piece top

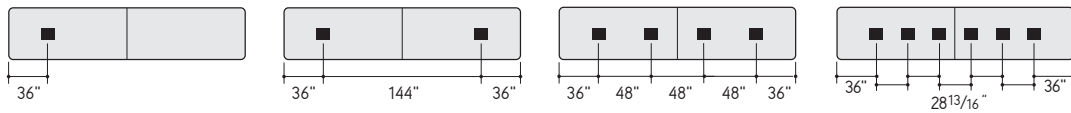

18'L x 48"W TAP Locations—Three piece top

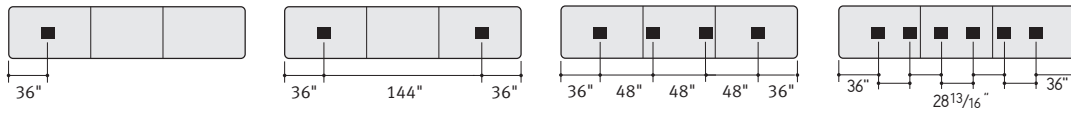

18'L x 60"W TAP Locations—Two piece top

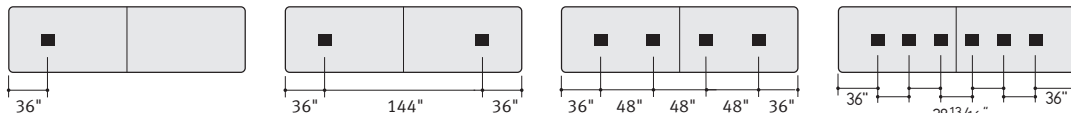

18'L x 60"W TAP Locations—Three piece top

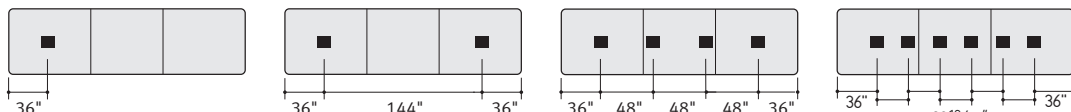

►Options, continued on next page

Host Collection Rectangular Tables with Three Bases

DESIGN F/P DESIGN AND VECTA DESIGN TEAM

► Options, continued from previous page

TAP Locations

20'L x 48"W TAP Locations—Two piece top

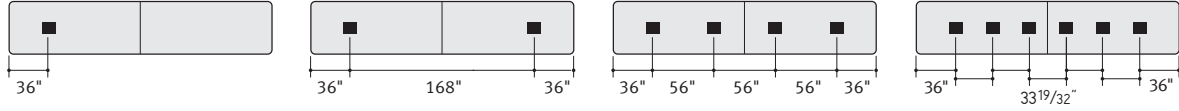

20'L x 48"W TAP Locations—Three piece top

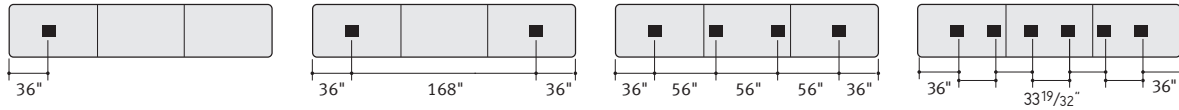

20'L x 60"W TAP Locations—Two piece top

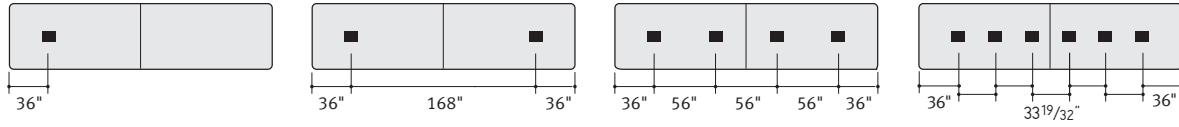

20'L x 60"W TAP Locations—Three piece top

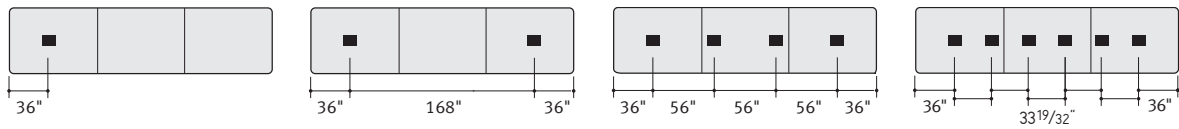

► Specification Information on next page

Host Collection Rectangular Tables with Three Bases *continued*

DESIGN F/P DESIGN AND VECTA DESIGN TEAM

Tip: Prices shown include top, TAP(s), and slim bases.
 ▶ See base options for flared bases, page 354



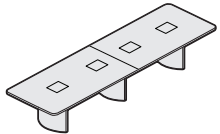
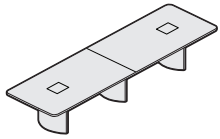
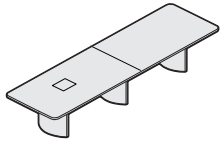
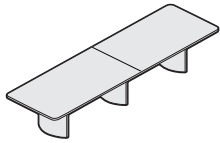

Tip: Last digit of style number indicates number of TAP(s).

Tip: For tech corridor, 14'L tables have four long doors and four short doors.



▶ Options on previous page

Specification Information

Style Number	Finish	U.S. Base Prices			
					
		Flat Wood Edge:	Bullnose Wood Edge:	Beveled Wood Edge, Tapered Wood Edge:	Horizon Wood Edge:

14'L x 48"W Two Piece Top

0 TAP

HS1448R20	Grade 1 Laminate	\$ 8773	\$ 8897	\$ 9068	\$10,231
	Grade 2 Laminate	\$ 8947	\$ 9071	\$ 9242	\$10,405
	Grade 1 Veneer	\$ 9736	\$ 9860	\$10,031	\$11,194
	Grade 2 Veneer	\$10,629	\$10,753	\$10,924	\$12,087

1 TAP

HS1448R21	Grade 1 Laminate	\$10,083	\$10,207	\$10,378	\$11,541
	Grade 2 Laminate	\$10,257	\$10,381	\$10,552	\$11,715
	Grade 1 Veneer	\$11,046	\$11,170	\$11,341	\$12,504
	Grade 2 Veneer	\$11,939	\$12,063	\$12,234	\$13,397

2 TAPS

HS1448R22	Grade 1 Laminate	\$11,393	\$11,517	\$11,688	\$12,851
	Grade 2 Laminate	\$11,567	\$11,691	\$11,862	\$13,025
	Grade 1 Veneer	\$12,356	\$12,480	\$12,651	\$13,814
	Grade 2 Veneer	\$13,249	\$13,373	\$13,544	\$14,707

4 TAPS

HS1448R24	Grade 1 Laminate	\$14,013	\$14,137	\$14,308	\$15,471
	Grade 2 Laminate	\$14,187	\$14,311	\$14,482	\$15,645
	Grade 1 Veneer	\$14,976	\$15,100	\$15,271	\$16,434
	Grade 2 Veneer	\$15,869	\$15,993	\$16,164	\$17,327

▶ Specification Information, continued on next page



For Canadian Pricing
 Multiply U.S. Price by the Canadian price factor.
 ▶ See page 1 for details.

Host Collection Rectangular Tables with Three Bases

DESIGN F/P DESIGN AND VECTA DESIGN TEAM

Tip: Prices shown include top, TAP(s), and slim bases.
 ▶ See base options for flared bases, page 354



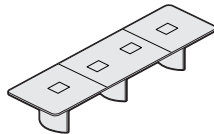
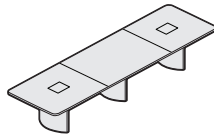
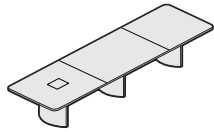
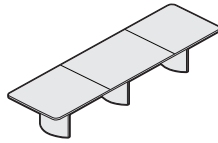

Tip: Last digit of style number indicates number of TAP(s).

Tip: For tech corridor, 14'L tables have four long doors and four short doors.



▶ Specification Information, continued from previous page

Specification Information

Style Number	Finish	U.S. Base Prices			
					
		Flat Wood Edge:	Bullnose Wood Edge:	Beveled Wood Edge, Tapered Wood Edge:	Horizon Wood Edge:

14'L x 48''W Three Piece Top

0 TAP

HS1448R30	Finish	Flat Wood Edge	Bullnose Wood Edge	Beveled Wood Edge, Tapered Wood Edge	Horizon Wood Edge
	Grade 1 Laminate	\$ 9086	\$ 9210	\$ 9381	\$10,544
	Grade 2 Laminate	\$ 9260	\$ 9384	\$ 9555	\$10,718
	Grade 1 Veneer	\$10,049	\$10,173	\$10,344	\$11,507
	Grade 2 Veneer	\$10,942	\$11,066	\$11,237	\$12,400

1 TAP

HS1448R31	Finish	Flat Wood Edge	Bullnose Wood Edge	Beveled Wood Edge, Tapered Wood Edge	Horizon Wood Edge
	Grade 1 Laminate	\$10,397	\$10,521	\$10,692	\$11,855
	Grade 2 Laminate	\$10,571	\$10,695	\$10,866	\$12,029
	Grade 1 Veneer	\$11,360	\$11,484	\$11,655	\$12,818
	Grade 2 Veneer	\$12,253	\$12,377	\$12,548	\$13,711

2 TAPS

HS1448R32	Finish	Flat Wood Edge	Bullnose Wood Edge	Beveled Wood Edge, Tapered Wood Edge	Horizon Wood Edge
	Grade 1 Laminate	\$11,707	\$11,831	\$12,002	\$13,165
	Grade 2 Laminate	\$11,881	\$12,005	\$12,176	\$13,339
	Grade 1 Veneer	\$12,670	\$12,794	\$12,965	\$14,128
	Grade 2 Veneer	\$13,563	\$13,687	\$13,858	\$15,021

4 TAPS

HS1448R34	Finish	Flat Wood Edge	Bullnose Wood Edge	Beveled Wood Edge, Tapered Wood Edge	Horizon Wood Edge
	Grade 1 Laminate	\$14,328	\$14,452	\$14,623	\$15,786
	Grade 2 Laminate	\$14,502	\$14,626	\$14,797	\$15,960
	Grade 1 Veneer	\$15,291	\$15,415	\$15,586	\$16,749
	Grade 2 Veneer	\$16,184	\$16,308	\$16,479	\$17,642

▶ Specification Information, continued on next page



For Canadian Pricing
 Multiply U.S. Price by the Canadian price factor.
 ▶ See page 1 for details.

Host Collection Rectangular Tables with Three Bases *continued*

DESIGN F/P DESIGN AND VECTA DESIGN TEAM

Tip: Prices shown include top, TAP(s), and slim bases.
 ▶ See base options for flared bases, page 354

Tip: Last digit of style number indicates number of TAP(s).

Tip: For tech corridor, 14'L tables have four long doors and four short doors.

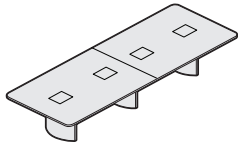
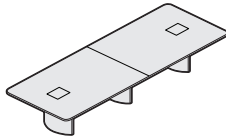
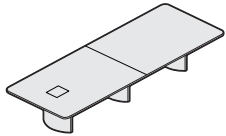
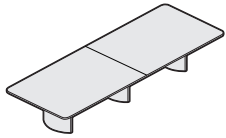

▶ Specification Information, continued from previous page

Specification Information

Style Number	Finish	U.S. Base Prices			
		Flat Wood Edge:	Bullnose Wood Edge:	Beveled Wood Edge, Tapered Wood Edge:	Horizon Wood Edge:

14'L x 60"W Two Piece Top

0 TAP

Style Number	Finish	Flat Wood Edge	Bullnose Wood Edge	Beveled Wood Edge, Tapered Wood Edge	Horizon Wood Edge
HS1460R20	Grade 1 Laminate	\$ 9160	\$ 9290	\$ 9472	\$10,645
	Grade 2 Laminate	\$ 9377	\$ 9507	\$ 9689	\$10,862
	Grade 1 Veneer	\$10,929	\$11,059	\$11,241	\$12,414
	Grade 2 Veneer	\$12,064	\$12,194	\$12,376	\$13,549

1 TAP

HS1460R21	Grade 1 Laminate	\$10,470	\$10,600	\$10,782	\$11,955
	Grade 2 Laminate	\$10,687	\$10,817	\$10,999	\$12,172
	Grade 1 Veneer	\$12,239	\$12,369	\$12,551	\$13,724
	Grade 2 Veneer	\$13,374	\$13,504	\$13,686	\$14,859

2 TAPS

HS1460R22	Grade 1 Laminate	\$11,780	\$11,910	\$12,092	\$13,265
	Grade 2 Laminate	\$11,997	\$12,127	\$12,309	\$13,482
	Grade 1 Veneer	\$13,549	\$13,679	\$13,861	\$15,034
	Grade 2 Veneer	\$14,684	\$14,814	\$14,996	\$16,169

4 TAPS

HS1460R24	Grade 1 Laminate	\$14,400	\$14,530	\$14,712	\$15,885
	Grade 2 Laminate	\$14,617	\$14,747	\$14,929	\$16,102
	Grade 1 Veneer	\$16,169	\$16,299	\$16,481	\$17,654
	Grade 2 Veneer	\$17,304	\$17,434	\$17,616	\$18,789

▶ Specification Information, continued on next page



For Canadian Pricing
 Multiply U.S. Price by the Canadian price factor.
 ▶ See page 1 for details.

Host Collection Rectangular Tables with Three Bases

DESIGN F/P DESIGN AND VECTA DESIGN TEAM

Tip: Prices shown include top, TAP(s), and slim bases.
 ▶ See base options for flared bases, page 354

Tip: Last digit of style number indicates number of TAP(s).

Tip: For tech corridor, tables have four long doors and four short doors.

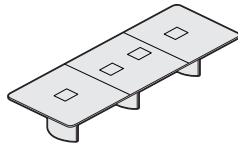
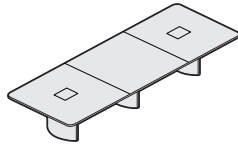
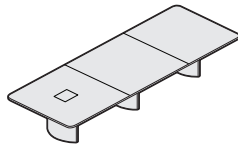
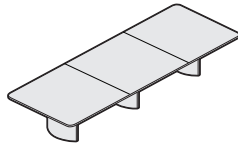

▶ Specification Information, continued from previous page

Specification Information

Style Number	Finish	U.S. Base Prices			
		Flat Wood Edge:	Bullnose Wood Edge:	Beveled Wood Edge, Tapered Wood Edge:	Horizon Wood Edge:

14'L x 60"W Three Piece Top

0 TAP

HS1460R30	Grade 1 Laminate	\$ 9474	\$ 9604	\$ 9786	\$10,959
	Grade 2 Laminate	\$ 9691	\$ 9821	\$10,003	\$11,176
	Grade 1 Veneer	\$11,243	\$11,373	\$11,555	\$12,728
	Grade 2 Veneer	\$12,378	\$12,508	\$12,690	\$13,863

1 TAP

HS1460R31	Grade 1 Laminate	\$10,784	\$10,914	\$11,096	\$12,269
	Grade 2 Laminate	\$11,001	\$11,131	\$11,313	\$12,486
	Grade 1 Veneer	\$12,553	\$12,683	\$12,865	\$14,038
	Grade 2 Veneer	\$13,688	\$13,818	\$14,000	\$15,173

2 TAPS

HS1460R32	Grade 1 Laminate	\$12,094	\$12,224	\$12,406	\$13,579
	Grade 2 Laminate	\$12,311	\$12,441	\$12,623	\$13,796
	Grade 1 Veneer	\$13,863	\$13,993	\$14,175	\$15,348
	Grade 2 Veneer	\$14,998	\$15,128	\$15,310	\$16,483

4 TAPS

HS1460R34	Grade 1 Laminate	\$14,715	\$14,845	\$15,027	\$16,200
	Grade 2 Laminate	\$14,932	\$15,062	\$15,244	\$16,417
	Grade 1 Veneer	\$16,484	\$16,614	\$16,796	\$17,969
	Grade 2 Veneer	\$17,619	\$17,749	\$17,931	\$19,104

▶ Specification Information, continued on next page



For Canadian Pricing
 Multiply U.S. Price by the Canadian price factor.
 ▶ See page 1 for details.

Host Collection Rectangular Tables with Three Bases *continued*

DESIGN F/P DESIGN AND VECTA DESIGN TEAM

Tip: Prices shown include top, TAP(s), and slim bases.
 ▶ See base options for flared bases, page 354

Tip: Last digit of style number indicates number of TAP(s).

Tip: For tech corridor, 16'L tables have eight long doors and four short doors.

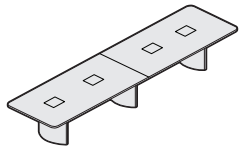
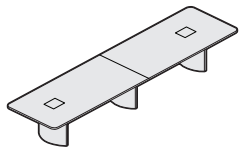
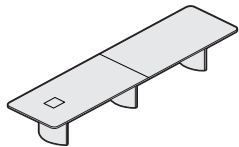
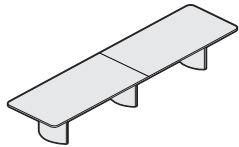

▶ Specification Information, continued from previous page

Specification Information

Style Number	Finish	U.S. Base Prices			
		Flat Wood Edge:	Bullnose Wood Edge:	Beveled Wood Edge, Tapered Wood Edge:	Horizon Wood Edge:

16'L x 48"W Two Piece Top

0 TAP

Style Number	Finish	Flat Wood Edge	Bullnose Wood Edge	Beveled Wood Edge, Tapered Wood Edge	Horizon Wood Edge
HS1648R20	Grade 1 Laminate	\$ 9128	\$ 9265	\$ 9455	\$10,640
	Grade 2 Laminate	\$ 9326	\$ 9463	\$ 9653	\$10,838
	Grade 1 Veneer	\$10,087	\$10,224	\$10,414	\$11,599
	Grade 2 Veneer	\$11,105	\$11,242	\$11,432	\$12,617

1 TAP

HS1648R21	Grade 1 Laminate	\$10,437	\$10,574	\$10,764	\$11,949
	Grade 2 Laminate	\$10,635	\$10,772	\$10,962	\$12,147
	Grade 1 Veneer	\$11,396	\$11,533	\$11,723	\$12,908
	Grade 2 Veneer	\$12,414	\$12,551	\$12,741	\$13,926

2 TAPS

HS1648R22	Grade 1 Laminate	\$11,747	\$11,884	\$12,074	\$13,259
	Grade 2 Laminate	\$11,945	\$12,082	\$12,272	\$13,457
	Grade 1 Veneer	\$12,706	\$12,843	\$13,033	\$14,218
	Grade 2 Veneer	\$13,724	\$13,861	\$14,051	\$15,236

4 TAPS

HS1648R24	Grade 1 Laminate	\$14,367	\$14,504	\$14,694	\$15,879
	Grade 2 Laminate	\$14,565	\$14,702	\$14,892	\$16,077
	Grade 1 Veneer	\$15,326	\$15,463	\$15,653	\$16,838
	Grade 2 Veneer	\$16,344	\$16,481	\$16,671	\$17,856

▶ Specification Information, continued on next page



For Canadian Pricing
 Multiply U.S. Price by the Canadian price factor.
 ▶ See page 1 for details.

Host Collection Rectangular Tables with Three Bases

DESIGN F/P DESIGN AND VECTA DESIGN TEAM

Tip: Prices shown include top, TAP(s), and slim bases.
 ▶ See base options for flared bases, page 354



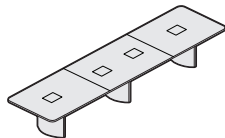
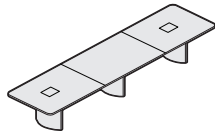
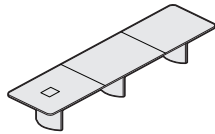
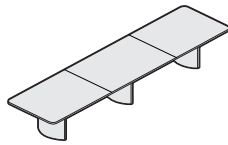

Tip: Last digit of style number indicates number of TAP(s).

Tip: For tech corridor, 16'L tables have eight long doors and four short doors.



▶ Specification Information, continued from previous page

Specification Information

Style Number	Finish	U.S. Base Prices			
					
		Flat Wood Edge:	Bullnose Wood Edge:	Beveled Wood Edge, Tapered Wood Edge:	Horizon Wood Edge:

16'L x 48''W Three Piece Top

0 TAP

Style Number	Finish	Flat Wood Edge	Bullnose Wood Edge	Beveled Wood Edge, Tapered Wood Edge	Horizon Wood Edge
HS1648R30	Grade 1 Laminate	\$ 9441	\$ 9578	\$ 9768	\$10,953
	Grade 2 Laminate	\$ 9639	\$ 9776	\$ 9966	\$11,151
	Grade 1 Veneer	\$10,400	\$10,537	\$10,727	\$11,912
	Grade 2 Veneer	\$11,418	\$11,555	\$11,745	\$12,930

1 TAP

Style Number	Finish	Flat Wood Edge	Bullnose Wood Edge	Beveled Wood Edge, Tapered Wood Edge	Horizon Wood Edge
HS1648R31	Grade 1 Laminate	\$10,751	\$10,888	\$11,078	\$12,263
	Grade 2 Laminate	\$10,949	\$11,086	\$11,276	\$12,461
	Grade 1 Veneer	\$11,710	\$11,847	\$12,037	\$13,222
	Grade 2 Veneer	\$12,728	\$12,865	\$13,055	\$14,240

2 TAPS

Style Number	Finish	Flat Wood Edge	Bullnose Wood Edge	Beveled Wood Edge, Tapered Wood Edge	Horizon Wood Edge
HS1648R32	Grade 1 Laminate	\$12,061	\$12,198	\$12,388	\$13,573
	Grade 2 Laminate	\$12,259	\$12,396	\$12,586	\$13,771
	Grade 1 Veneer	\$13,020	\$13,157	\$13,347	\$14,532
	Grade 2 Veneer	\$14,038	\$14,175	\$14,365	\$15,550

4 TAPS

Style Number	Finish	Flat Wood Edge	Bullnose Wood Edge	Beveled Wood Edge, Tapered Wood Edge	Horizon Wood Edge
HS1648R34	Grade 1 Laminate	\$14,681	\$14,818	\$15,008	\$16,193
	Grade 2 Laminate	\$14,879	\$15,016	\$15,206	\$16,391
	Grade 1 Veneer	\$15,640	\$15,777	\$15,967	\$17,152
	Grade 2 Veneer	\$16,658	\$16,795	\$16,985	\$18,170

▶ Specification Information, continued on next page



For Canadian Pricing
 Multiply U.S. Price by the Canadian price factor.
 ▶ See page 1 for details.

Host Collection Rectangular Tables with Three Bases *continued*

DESIGN F/P DESIGN AND VECTA DESIGN TEAM

Tip: Prices shown include top, TAP(s), and slim bases.
 ▶ See base options for flared bases, page 354



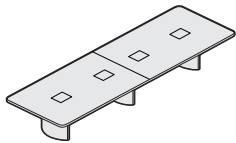
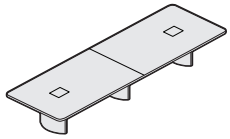
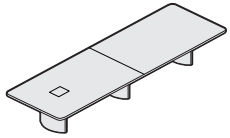
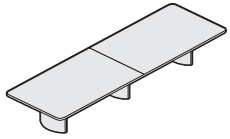

Tip: Last digit of style number indicates number of TAP(s).

Tip: For tech corridor, 16'L tables have eight long doors and four short doors.



▶ Specification Information, continued from previous page

Specification Information

Style Number	Finish	U.S. Base Prices			
					
		Flat Wood Edge:	Bullnose Wood Edge:	Beveled Wood Edge, Tapered Wood Edge:	Horizon Wood Edge:

16'L x 60''W Two Piece Top

0 TAP

HS1660R20	Grade 1 Laminate	\$ 9515	\$ 9659	\$ 9858	\$11,053
	Grade 2 Laminate	\$ 9763	\$ 9907	\$10,106	\$11,301
	Grade 1 Veneer	\$11,281	\$11,425	\$11,624	\$12,819
	Grade 2 Veneer	\$12,570	\$12,714	\$12,913	\$14,108

1 TAP

HS1660R21	Grade 1 Laminate	\$10,824	\$10,968	\$11,167	\$12,362
	Grade 2 Laminate	\$11,072	\$11,216	\$11,415	\$12,610
	Grade 1 Veneer	\$12,590	\$12,734	\$12,933	\$14,128
	Grade 2 Veneer	\$13,879	\$14,023	\$14,222	\$15,417

2 TAPS

HS1660R22	Grade 1 Laminate	\$12,134	\$12,278	\$12,477	\$13,672
	Grade 2 Laminate	\$12,382	\$12,526	\$12,725	\$13,920
	Grade 1 Veneer	\$13,900	\$14,044	\$14,243	\$15,438
	Grade 2 Veneer	\$15,189	\$15,333	\$15,532	\$16,727

4 TAPS

HS1660R24	Grade 1 Laminate	\$14,754	\$14,898	\$15,097	\$16,292
	Grade 2 Laminate	\$15,002	\$15,146	\$15,345	\$16,540
	Grade 1 Veneer	\$16,520	\$16,664	\$16,863	\$18,058
	Grade 2 Veneer	\$17,809	\$17,953	\$18,152	\$19,347

▶ Specification Information, continued on next page



For Canadian Pricing
 Multiply U.S. Price by the Canadian price factor.
 ▶ See page 1 for details.

Host Collection Rectangular Tables with Three Bases

DESIGN F/P DESIGN AND VECTA DESIGN TEAM

Tip: Prices shown include top, TAP(s), and slim bases.
 ▶ See base options for flared bases, page 354

Tip: Last digit of style number indicates number of TAP(s).

Tip: For tech corridor, 16'L tables have eight long doors and four short doors.

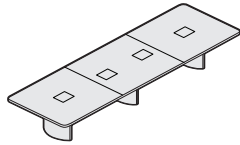
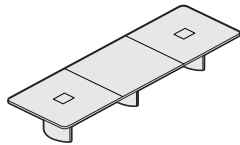
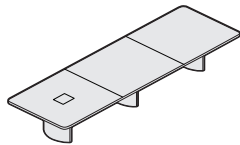
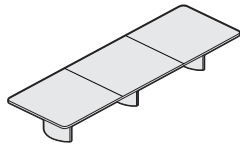

▶ Specification Information, continued from previous page

Specification Information

Style Number	Finish	U.S. Base Prices			
		Flat Wood Edge:	Bullnose Wood Edge:	Beveled Wood Edge, Tapered Wood Edge:	Horizon Wood Edge:

16'L x 60"W Three Piece Top

0 TAP

Style Number	Finish	Flat Wood Edge	Bullnose Wood Edge	Beveled Wood Edge, Tapered Wood Edge	Horizon Wood Edge
HS1660R30	Grade 1 Laminate	\$ 9828	\$ 9972	\$10,171	\$11,366
	Grade 2 Laminate	\$10,076	\$10,220	\$10,419	\$11,614
	Grade 1 Veneer	\$11,594	\$11,738	\$11,937	\$13,132
	Grade 2 Veneer	\$12,883	\$13,027	\$13,226	\$14,421

1 TAP

Style Number	Finish	Flat Wood Edge	Bullnose Wood Edge	Beveled Wood Edge, Tapered Wood Edge	Horizon Wood Edge
HS1660R31	Grade 1 Laminate	\$11,138	\$11,282	\$11,481	\$12,676
	Grade 2 Laminate	\$11,386	\$11,530	\$11,729	\$12,924
	Grade 1 Veneer	\$12,904	\$13,048	\$13,247	\$14,442
	Grade 2 Veneer	\$14,193	\$14,337	\$14,536	\$15,731

2 TAPS

Style Number	Finish	Flat Wood Edge	Bullnose Wood Edge	Beveled Wood Edge, Tapered Wood Edge	Horizon Wood Edge
HS1660R32	Grade 1 Laminate	\$12,448	\$12,592	\$12,791	\$13,986
	Grade 2 Laminate	\$12,696	\$12,840	\$13,039	\$14,234
	Grade 1 Veneer	\$14,214	\$14,358	\$14,557	\$15,752
	Grade 2 Veneer	\$15,503	\$15,647	\$15,846	\$17,041

4 TAPS

Style Number	Finish	Flat Wood Edge	Bullnose Wood Edge	Beveled Wood Edge, Tapered Wood Edge	Horizon Wood Edge
HS1660R34	Grade 1 Laminate	\$15,068	\$15,212	\$15,411	\$16,606
	Grade 2 Laminate	\$15,316	\$15,460	\$15,659	\$16,854
	Grade 1 Veneer	\$16,834	\$16,978	\$17,177	\$18,372
	Grade 2 Veneer	\$18,123	\$18,267	\$18,466	\$19,661

▶ Specification Information, continued on next page



For Canadian Pricing
 Multiply U.S. Price by the Canadian price factor.
 ▶ See page 1 for details.

Host Collection Rectangular Tables with Three Bases *continued*

DESIGN F/P DESIGN AND VECTA DESIGN TEAM

Tip: Prices shown include top, TAP(s), and slim bases.
 ▶ See base options for flared bases, page 354

Tip: Last digit of style number indicates number of TAP(s).

Tip: For tech corridor, 18'L tables have eight long doors and four short doors.

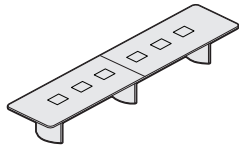
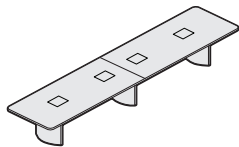
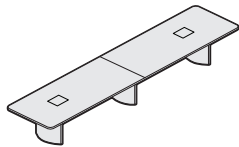
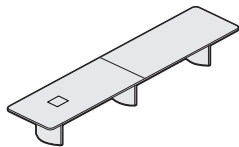
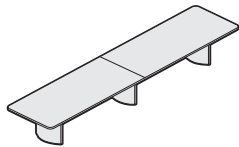

▶ Specification Information, continued from previous page

Specification Information

Style Number	Finish	U.S. Base Prices			
		Flat Wood Edge:	Bullnose Wood Edge:	Beveled Wood Edge, Tapered Wood Edge:	Horizon Wood Edge:

18'L x 48"W Two Piece Top

0 TAP

Style Number	Finish	Flat Wood Edge	Bullnose Wood Edge	Beveled Wood Edge, Tapered Wood Edge	Horizon Wood Edge
HS1848R20	Grade 1 Laminate	\$ 9690	\$ 9841	\$10,049	\$11,255
	Grade 2 Laminate	\$ 9913	\$10,064	\$10,272	\$11,478
	Grade 1 Veneer	\$10,914	\$11,065	\$11,273	\$12,479
	Grade 2 Veneer	\$12,062	\$12,213	\$12,421	\$13,627

1 TAP

HS1848R21	Grade 1 Laminate	\$11,000	\$11,151	\$11,359	\$12,565
	Grade 2 Laminate	\$11,223	\$11,374	\$11,582	\$12,788
	Grade 1 Veneer	\$12,224	\$12,375	\$12,583	\$13,789
	Grade 2 Veneer	\$13,372	\$13,523	\$13,731	\$14,937

2 TAPS

HS1848R22	Grade 1 Laminate	\$12,310	\$12,461	\$12,669	\$13,875
	Grade 2 Laminate	\$12,533	\$12,684	\$12,892	\$14,098
	Grade 1 Veneer	\$13,534	\$13,685	\$13,893	\$15,099
	Grade 2 Veneer	\$14,682	\$14,833	\$15,041	\$16,247

4 TAPS

HS1848R24	Grade 1 Laminate	\$14,930	\$15,081	\$15,289	\$16,495
	Grade 2 Laminate	\$15,153	\$15,304	\$15,512	\$16,718
	Grade 1 Veneer	\$16,154	\$16,305	\$16,513	\$17,719
	Grade 2 Veneer	\$17,302	\$17,453	\$17,661	\$18,867

6 TAPS

HS1848R26	Grade 1 Laminate	\$17,550	\$17,701	\$17,909	\$19,115
	Grade 2 Laminate	\$17,773	\$17,924	\$18,132	\$19,338
	Grade 1 Veneer	\$18,774	\$18,925	\$19,133	\$20,339
	Grade 2 Veneer	\$19,922	\$20,073	\$20,281	\$21,487

▶ Specification Information, continued on next page



For Canadian Pricing
 Multiply U.S. Price by the Canadian price factor.
 ▶ See page 1 for details.

Host Collection Rectangular Tables with Three Bases

DESIGN F/P DESIGN AND VECTA DESIGN TEAM

Tip: Prices shown include top, TAP(s), and slim bases.
 ▶ See base options for flared bases, page 354



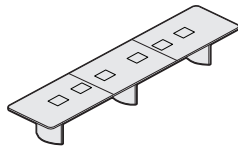
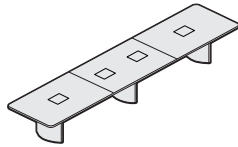
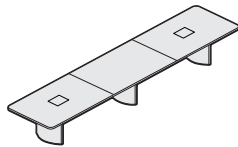
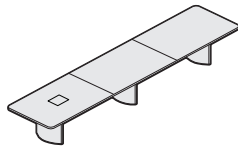
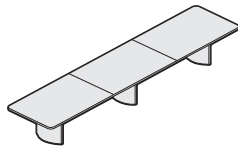

Tip: Last digit of style number indicates number of TAP(s).

Tip: For tech corridor, 18'L tables have eight long doors and four short doors.



▶ Specification Information, continued from previous page

Specification Information

Style Number	Finish	U.S. Base Prices			
					
		Flat Wood Edge:	Bullnose Wood Edge:	Beveled Wood Edge, Tapered Wood Edge:	Horizon Wood Edge:

18'L x 48"W Three Piece Top

0 TAP					
HS1848R30	Grade 1 Laminate	\$10,003	\$10,154	\$10,362	\$11,568
	Grade 2 Laminate	\$10,226	\$10,377	\$10,585	\$11,791
	Grade 1 Veneer	\$11,227	\$11,378	\$11,586	\$12,792
	Grade 2 Veneer	\$12,375	\$12,526	\$12,734	\$13,940
1 TAP					
HS1848R31	Grade 1 Laminate	\$11,314	\$11,465	\$11,673	\$12,879
	Grade 2 Laminate	\$11,537	\$11,688	\$11,896	\$13,102
	Grade 1 Veneer	\$12,538	\$12,689	\$12,897	\$14,103
	Grade 2 Veneer	\$13,686	\$13,837	\$14,045	\$15,251
2 TAPS					
HS1848R32	Grade 1 Laminate	\$12,624	\$12,775	\$12,983	\$14,189
	Grade 2 Laminate	\$12,847	\$12,998	\$13,206	\$14,412
	Grade 1 Veneer	\$13,848	\$13,999	\$14,207	\$15,413
	Grade 2 Veneer	\$14,996	\$15,147	\$15,355	\$16,561
4 TAPS					
HS1848R34	Grade 1 Laminate	\$15,244	\$15,395	\$15,603	\$16,809
	Grade 2 Laminate	\$15,467	\$15,618	\$15,826	\$17,032
	Grade 1 Veneer	\$16,468	\$16,619	\$16,827	\$18,033
	Grade 2 Veneer	\$17,616	\$17,767	\$17,975	\$19,181
6 TAPS					
HS1848R36	Grade 1 Laminate	\$17,864	\$18,015	\$18,223	\$19,429
	Grade 2 Laminate	\$18,087	\$18,238	\$18,446	\$19,652
	Grade 1 Veneer	\$19,088	\$19,239	\$19,447	\$20,653
	Grade 2 Veneer	\$20,236	\$20,387	\$20,595	\$21,801

▶ Specification Information, continued on next page



For Canadian Pricing
 Multiply U.S. Price by the Canadian price factor.
 ▶ See page 1 for details.

Host Collection Rectangular Tables with Three Bases *continued*

DESIGN F/P DESIGN AND VECTA DESIGN TEAM

Tip: Prices shown include top, TAP(s), and slim bases.
 ▶ See base options for flared bases, page 354

Tip: Last digit of style number indicates number of TAP(s).

Tip: For tech corridor, 18'L tables have eight long doors and four short doors.

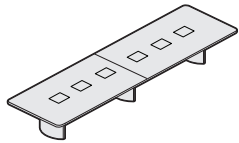
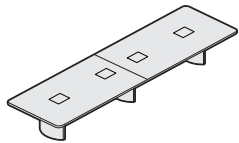
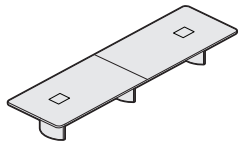
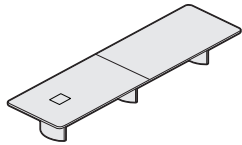
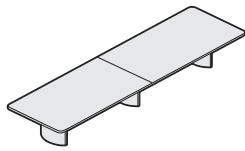

▶ Specification Information, continued from previous page

Specification Information

Style Number	Finish	U.S. Base Prices			
		Flat Wood Edge:	Bullnose Wood Edge:	Beveled Wood Edge, Tapered Wood Edge:	Horizon Wood Edge:

18'L x 60"W Two Piece Top

0 TAP

Style Number	Finish	Flat Wood Edge	Bullnose Wood Edge	Beveled Wood Edge, Tapered Wood Edge	Horizon Wood Edge
HS1860R20	Grade 1 Laminate	\$ 9898	\$10,055	\$10,273	\$11,490
	Grade 2 Laminate	\$10,177	\$10,334	\$10,552	\$11,769
	Grade 1 Veneer	\$12,260	\$12,417	\$12,635	\$13,852
	Grade 2 Veneer	\$13,721	\$13,878	\$14,096	\$15,313

1 TAP

Style Number	Finish	Flat Wood Edge	Bullnose Wood Edge	Beveled Wood Edge, Tapered Wood Edge	Horizon Wood Edge
HS1860R21	Grade 1 Laminate	\$11,207	\$11,364	\$11,582	\$12,799
	Grade 2 Laminate	\$11,486	\$11,643	\$11,861	\$13,078
	Grade 1 Veneer	\$13,569	\$13,726	\$13,944	\$15,161
	Grade 2 Veneer	\$15,030	\$15,187	\$15,405	\$16,622

2 TAPS

Style Number	Finish	Flat Wood Edge	Bullnose Wood Edge	Beveled Wood Edge, Tapered Wood Edge	Horizon Wood Edge
HS1860R22	Grade 1 Laminate	\$12,517	\$12,674	\$12,892	\$14,109
	Grade 2 Laminate	\$12,796	\$12,953	\$13,171	\$14,388
	Grade 1 Veneer	\$14,879	\$15,036	\$15,254	\$16,471
	Grade 2 Veneer	\$16,340	\$16,497	\$16,715	\$17,932

4 TAPS

Style Number	Finish	Flat Wood Edge	Bullnose Wood Edge	Beveled Wood Edge, Tapered Wood Edge	Horizon Wood Edge
HS1860R24	Grade 1 Laminate	\$15,137	\$15,294	\$15,512	\$16,729
	Grade 2 Laminate	\$15,416	\$15,573	\$15,791	\$17,008
	Grade 1 Veneer	\$17,499	\$17,656	\$17,874	\$19,091
	Grade 2 Veneer	\$18,960	\$19,117	\$19,335	\$20,552

6 TAPS

Style Number	Finish	Flat Wood Edge	Bullnose Wood Edge	Beveled Wood Edge, Tapered Wood Edge	Horizon Wood Edge
HS1860R26	Grade 1 Laminate	\$17,757	\$17,914	\$18,132	\$19,349
	Grade 2 Laminate	\$18,036	\$18,193	\$18,411	\$19,628
	Grade 1 Veneer	\$20,119	\$20,276	\$20,494	\$21,711
	Grade 2 Veneer	\$21,580	\$21,737	\$21,955	\$23,172

▶ Specification Information, continued on next page



For Canadian Pricing
 Multiply U.S. Price by the Canadian price factor.
 ▶ See page 1 for details.

Host Collection Rectangular Tables with Three Bases

DESIGN F/P DESIGN AND VECTA DESIGN TEAM

Tip: Prices shown include top, TAP(s), and slim bases.
 ▶ See base options for flared bases, page 354

Tip: Last digit of style number indicates number of TAP(s).

Tip: For tech corridor, 18'L tables have eight long doors and four short doors.

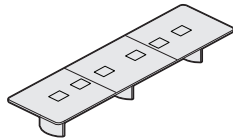
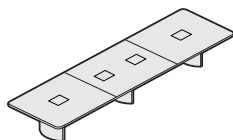
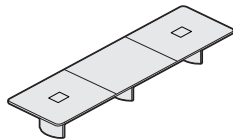
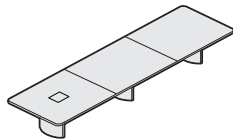
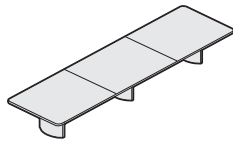

▶ Specification Information, continued from previous page

Specification Information

Style Number	Finish	U.S. Base Prices			
		Flat Wood Edge:	Bullnose Wood Edge:	Beveled Wood Edge, Tapered Wood Edge:	Horizon Wood Edge:

18'L x 60"W Three Piece Top

0 TAP

Style Number	Finish	Flat Wood Edge	Bullnose Wood Edge	Beveled Wood Edge, Tapered Wood Edge	Horizon Wood Edge
HS1860R30	Grade 1 Laminate	\$10,211	\$10,368	\$10,586	\$11,803
	Grade 2 Laminate	\$10,490	\$10,647	\$10,865	\$12,082
	Grade 1 Veneer	\$12,573	\$12,730	\$12,948	\$14,165
	Grade 2 Veneer	\$14,034	\$14,191	\$14,409	\$15,626

1 TAP

Style Number	Finish	Flat Wood Edge	Bullnose Wood Edge	Beveled Wood Edge, Tapered Wood Edge	Horizon Wood Edge
HS1860R31	Grade 1 Laminate	\$11,521	\$11,678	\$11,896	\$13,113
	Grade 2 Laminate	\$11,800	\$11,957	\$12,175	\$13,392
	Grade 1 Veneer	\$13,883	\$14,040	\$14,258	\$15,475
	Grade 2 Veneer	\$15,344	\$15,501	\$15,719	\$16,936

2 TAPS

Style Number	Finish	Flat Wood Edge	Bullnose Wood Edge	Beveled Wood Edge, Tapered Wood Edge	Horizon Wood Edge
HS1860R32	Grade 1 Laminate	\$12,831	\$12,988	\$13,206	\$14,423
	Grade 2 Laminate	\$13,110	\$13,267	\$13,485	\$14,702
	Grade 1 Veneer	\$15,193	\$15,350	\$15,568	\$16,785
	Grade 2 Veneer	\$16,654	\$16,811	\$17,029	\$18,246

4 TAPS

Style Number	Finish	Flat Wood Edge	Bullnose Wood Edge	Beveled Wood Edge, Tapered Wood Edge	Horizon Wood Edge
HS1860R34	Grade 1 Laminate	\$15,451	\$15,608	\$15,826	\$17,043
	Grade 2 Laminate	\$15,730	\$15,887	\$16,105	\$17,322
	Grade 1 Veneer	\$17,813	\$17,970	\$18,188	\$19,405
	Grade 2 Veneer	\$19,274	\$19,431	\$19,649	\$20,866

6 TAPS

Style Number	Finish	Flat Wood Edge	Bullnose Wood Edge	Beveled Wood Edge, Tapered Wood Edge	Horizon Wood Edge
HS1860R36	Grade 1 Laminate	\$18,071	\$18,228	\$18,446	\$19,663
	Grade 2 Laminate	\$18,350	\$18,507	\$18,725	\$19,942
	Grade 1 Veneer	\$20,433	\$20,590	\$20,808	\$22,025
	Grade 2 Veneer	\$21,894	\$22,051	\$22,269	\$23,486

▶ Specification Information, continued on next page



For Canadian Pricing
 Multiply U.S. Price by the Canadian price factor.
 ▶ See page 1 for details.

Host Collection Rectangular Tables with Three Bases *continued*

DESIGN F/P DESIGN AND VECTA DESIGN TEAM

Tip: Prices shown include top, TAP(s), and slim bases.
 ▶ See base options for flared bases, page 354

Tip: Last digit of style number indicates number of TAP(s).

Tip: For tech corridor, 20'L tables have eight long doors and four short doors.

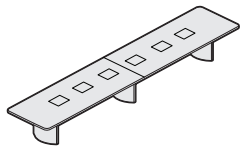
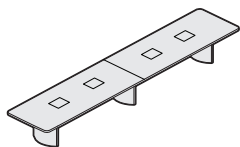
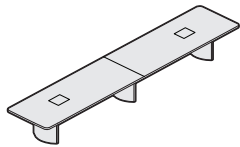
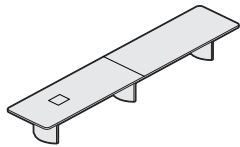
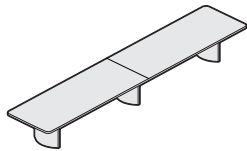

▶ Specification Information, continued from previous page

Specification Information

Style Number	Finish	U.S. Base Prices			
		Flat Wood Edge:	Bullnose Wood Edge:	Beveled Wood Edge, Tapered Wood Edge:	Horizon Wood Edge:

20'L x 48''W Two Piece Top

0 TAP

HS2048R20	Finish	Flat Wood Edge	Bullnose Wood Edge	Beveled Wood Edge, Tapered Wood Edge	Horizon Wood Edge
	Grade 1 Laminate	\$10,045	\$10,209	\$10,436	\$11,665
	Grade 2 Laminate	\$10,293	\$10,457	\$10,684	\$11,913
	Grade 1 Veneer	\$11,266	\$11,430	\$11,657	\$12,886
	Grade 2 Veneer	\$12,538	\$12,702	\$12,929	\$14,158

1 TAP

HS2048R21	Finish	Flat Wood Edge	Bullnose Wood Edge	Beveled Wood Edge, Tapered Wood Edge	Horizon Wood Edge
	Grade 1 Laminate	\$11,354	\$11,518	\$11,745	\$12,974
	Grade 2 Laminate	\$11,602	\$11,766	\$11,993	\$13,222
	Grade 1 Veneer	\$12,575	\$12,739	\$12,966	\$14,195
	Grade 2 Veneer	\$13,847	\$14,011	\$14,238	\$15,467

2 TAPS

HS2048R22	Finish	Flat Wood Edge	Bullnose Wood Edge	Beveled Wood Edge, Tapered Wood Edge	Horizon Wood Edge
	Grade 1 Laminate	\$12,664	\$12,828	\$13,055	\$14,284
	Grade 2 Laminate	\$12,912	\$13,076	\$13,303	\$14,532
	Grade 1 Veneer	\$13,885	\$14,049	\$14,276	\$15,505
	Grade 2 Veneer	\$15,157	\$15,321	\$15,548	\$16,777

4 TAPS

HS2048R24	Finish	Flat Wood Edge	Bullnose Wood Edge	Beveled Wood Edge, Tapered Wood Edge	Horizon Wood Edge
	Grade 1 Laminate	\$15,284	\$15,448	\$15,675	\$16,904
	Grade 2 Laminate	\$15,532	\$15,696	\$15,923	\$17,152
	Grade 1 Veneer	\$16,505	\$16,669	\$16,896	\$18,125
	Grade 2 Veneer	\$17,777	\$17,941	\$18,168	\$19,397

6 TAPS

HS2048R26	Finish	Flat Wood Edge	Bullnose Wood Edge	Beveled Wood Edge, Tapered Wood Edge	Horizon Wood Edge
	Grade 1 Laminate	\$17,904	\$18,068	\$18,295	\$19,524
	Grade 2 Laminate	\$18,152	\$18,316	\$18,543	\$19,772
	Grade 1 Veneer	\$19,125	\$19,289	\$19,516	\$20,745
	Grade 2 Veneer	\$20,397	\$20,561	\$20,788	\$22,017

▶ Specification Information, continued on next page



For Canadian Pricing
 Multiply U.S. Price by the Canadian price factor.
 ▶ See page 1 for details.

Host Collection Rectangular Tables with Three Bases

DESIGN F/P DESIGN AND VECTA DESIGN TEAM

Tip: Prices shown include top, TAP(s), and slim bases.
 ▶ See base options for flared bases, page 354



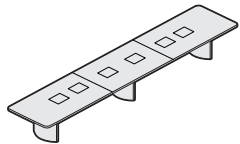
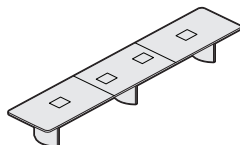
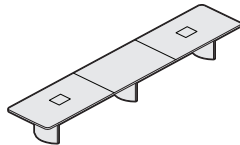
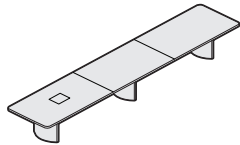
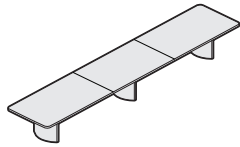

Tip: Last digit of style number indicates number of TAP(s).

Tip: For tech corridor, 20'L tables have eight long doors and four short doors.



► Specification Information, continued from previous page

Specification Information

Style Number	Finish	U.S. Base Prices			
					
		Flat Wood Edge:	Bullnose Wood Edge:	Beveled Wood Edge, Tapered Wood Edge:	Horizon Wood Edge:

20'L x 48''W Three Piece Top

0 TAP					
HS2048R30	Grade 1 Laminate	\$10,358	\$10,522	\$10,749	\$11,978
	Grade 2 Laminate	\$10,606	\$10,770	\$10,997	\$12,226
	Grade 1 Veneer	\$11,579	\$11,743	\$11,970	\$13,199
	Grade 2 Veneer	\$12,851	\$13,015	\$13,242	\$14,471
1 TAP					
HS2048R31	Grade 1 Laminate	\$11,668	\$11,832	\$12,059	\$13,288
	Grade 2 Laminate	\$11,916	\$12,080	\$12,307	\$13,536
	Grade 1 Veneer	\$12,889	\$13,053	\$13,280	\$14,509
	Grade 2 Veneer	\$14,161	\$14,325	\$14,552	\$15,781
2 TAPS					
HS2048R32	Grade 1 Laminate	\$12,978	\$13,142	\$13,369	\$14,598
	Grade 2 Laminate	\$13,226	\$13,390	\$13,617	\$14,846
	Grade 1 Veneer	\$14,199	\$14,363	\$14,590	\$15,819
	Grade 2 Veneer	\$15,471	\$15,635	\$15,862	\$17,091
4 TAPS					
HS2048R34	Grade 1 Laminate	\$15,598	\$15,762	\$15,989	\$17,218
	Grade 2 Laminate	\$15,846	\$16,010	\$16,237	\$17,466
	Grade 1 Veneer	\$16,819	\$16,983	\$17,210	\$18,439
	Grade 2 Veneer	\$18,091	\$18,255	\$18,482	\$19,711
6 TAPS					
HS2048R36	Grade 1 Laminate	\$18,218	\$18,382	\$18,609	\$19,838
	Grade 2 Laminate	\$18,466	\$18,630	\$18,857	\$20,086
	Grade 1 Veneer	\$19,439	\$19,603	\$19,830	\$21,059
	Grade 2 Veneer	\$20,711	\$20,875	\$21,102	\$22,331

► Specification Information, continued on next page



For Canadian Pricing
 Multiply U.S. Price by the Canadian price factor.
 ▶ See page 1 for details.

Host Collection Rectangular Tables with Three Bases *continued*

DESIGN F/P DESIGN AND VECTA DESIGN TEAM

Tip: Prices shown include top, TAP(s), and slim bases.
 ▶ See base options for flared bases, page 354

Tip: Last digit of style number indicates number of TAP(s).

Tip: For tech corridor, 20'L tables have eight long doors and four short doors.

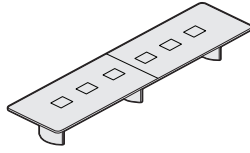
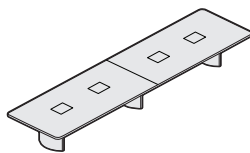
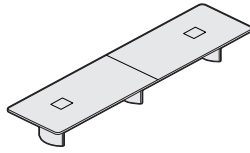
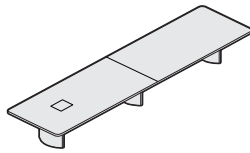
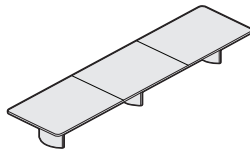

▶ Specification Information, continued from previous page

Specification Information

Style Number	Finish	U.S. Base Prices			
		Flat Wood Edge:	Bullnose Wood Edge:	Beveled Wood Edge, Tapered Wood Edge:	Horizon Wood Edge:

20'L x 60" W Two Piece Top

0 TAP

HS2060R20	Finish	Flat Wood Edge	Bullnose Wood Edge	Beveled Wood Edge, Tapered Wood Edge	Horizon Wood Edge
	Grade 1 Laminate	\$10,252	\$10,422	\$10,659	\$11,898
	Grade 2 Laminate	\$10,562	\$10,732	\$10,969	\$12,208
	Grade 1 Veneer	\$12,611	\$12,781	\$13,018	\$14,257
	Grade 2 Veneer	\$14,226	\$14,396	\$14,633	\$15,872

1 TAP

HS2060R21	Finish	Flat Wood Edge	Bullnose Wood Edge	Beveled Wood Edge, Tapered Wood Edge	Horizon Wood Edge
	Grade 1 Laminate	\$11,562	\$11,732	\$11,969	\$13,208
	Grade 2 Laminate	\$11,872	\$12,042	\$12,279	\$13,518
	Grade 1 Veneer	\$13,921	\$14,091	\$14,328	\$15,567
	Grade 2 Veneer	\$15,536	\$15,706	\$15,943	\$17,182

2 TAPS

HS2060R22	Finish	Flat Wood Edge	Bullnose Wood Edge	Beveled Wood Edge, Tapered Wood Edge	Horizon Wood Edge
	Grade 1 Laminate	\$12,872	\$13,042	\$13,279	\$14,518
	Grade 2 Laminate	\$13,182	\$13,352	\$13,589	\$14,828
	Grade 1 Veneer	\$15,231	\$15,401	\$15,638	\$16,877
	Grade 2 Veneer	\$16,846	\$17,016	\$17,253	\$18,492

4 TAPS

HS2060R24	Finish	Flat Wood Edge	Bullnose Wood Edge	Beveled Wood Edge, Tapered Wood Edge	Horizon Wood Edge
	Grade 1 Laminate	\$15,492	\$15,662	\$15,899	\$17,138
	Grade 2 Laminate	\$15,802	\$15,972	\$16,209	\$17,448
	Grade 1 Veneer	\$17,851	\$18,021	\$18,258	\$19,497
	Grade 2 Veneer	\$19,466	\$19,636	\$19,873	\$21,112

6 TAPS

HS2060R26	Finish	Flat Wood Edge	Bullnose Wood Edge	Beveled Wood Edge, Tapered Wood Edge	Horizon Wood Edge
	Grade 1 Laminate	\$18,112	\$18,282	\$18,519	\$19,758
	Grade 2 Laminate	\$18,422	\$18,592	\$18,829	\$20,068
	Grade 1 Veneer	\$20,471	\$20,641	\$20,878	\$22,117
	Grade 2 Veneer	\$22,086	\$22,256	\$22,493	\$23,732

▶ Specification Information, continued on next page



For Canadian Pricing
 Multiply U.S. Price by the Canadian price factor.
 ▶ See page 1 for details.

Host Collection Rectangular Tables with Three Bases

DESIGN F/P DESIGN AND VECTA DESIGN TEAM





Tip: Prices shown include top, TAP(s), and slim bases.
 ▶ See base options for flared bases, page 354

Tip: Last digit of style number indicates number of TAP(s).

Tip: For tech corridor, 20'L tables have eight long doors and four short doors.

▶ Specification Information, continued from previous page

Specification Information

Style Number	Finish	U.S. Base Prices			
					
		Flat Wood Edge:	Bullnose Wood Edge:	Beveled Wood Edge, Tapered Wood Edge:	Horizon Wood Edge:

20'L x 60"W Three Piece Top

0 TAP

HS2060R30	Grade 1 Laminate	\$10,565	\$10,735	\$10,972	\$12,211
	Grade 2 Laminate	\$10,875	\$11,045	\$11,282	\$12,521
	Grade 1 Veneer	\$12,924	\$13,094	\$13,331	\$14,570
	Grade 2 Veneer	\$14,539	\$14,709	\$14,946	\$16,185

1 TAP

HS2060R31	Grade 1 Laminate	\$11,876	\$12,046	\$12,283	\$13,522
	Grade 2 Laminate	\$12,186	\$12,356	\$12,593	\$13,832
	Grade 1 Veneer	\$14,235	\$14,405	\$14,642	\$15,881
	Grade 2 Veneer	\$15,850	\$16,020	\$16,257	\$17,496

2 TAPS

HS2060R32	Grade 1 Laminate	\$13,186	\$13,356	\$13,593	\$14,832
	Grade 2 Laminate	\$13,496	\$13,666	\$13,903	\$15,142
	Grade 1 Veneer	\$15,545	\$15,715	\$15,952	\$17,191
	Grade 2 Veneer	\$17,160	\$17,330	\$17,567	\$18,806

4 TAPS

HS2060R34	Grade 1 Laminate	\$15,806	\$15,976	\$16,213	\$17,452
	Grade 2 Laminate	\$16,116	\$16,286	\$16,523	\$17,762
	Grade 1 Veneer	\$18,165	\$18,335	\$18,572	\$19,811
	Grade 2 Veneer	\$19,780	\$19,950	\$20,187	\$21,426

6 TAPS

HS2060R36	Grade 1 Laminate	\$18,426	\$18,596	\$18,833	\$20,072
	Grade 2 Laminate	\$18,736	\$18,906	\$19,143	\$20,382
	Grade 1 Veneer	\$20,785	\$20,955	\$21,192	\$22,431
	Grade 2 Veneer	\$22,400	\$22,570	\$22,807	\$24,046

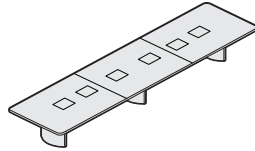
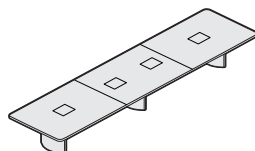
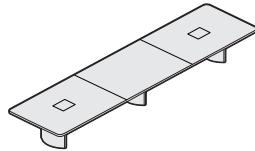
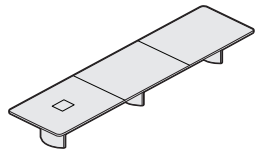
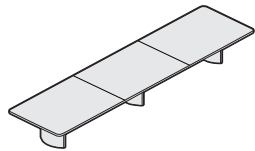

For Canadian Pricing
 Multiply U.S. Price by the Canadian price factor.
 ▶ See page 1 for details.

Host Collection Soft Radiused Tables with Two Bases

DESIGN F/P DESIGN AND VECTA DESIGN TEAM

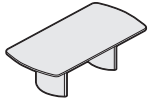

Tip: Shipped knocked down and top ships in one piece.

Tip: Grain direction for wood-grain laminate runs the length of the table.

Tip: Clips are provided with table. One clip per foot of table length.

Tip: The wood edge on a table top with woodgrain laminate may not match the top.

Tip: You must send a sample of reasonable size for Stain-to-Match.

Tip: 96"L tables available with zero, one, or two TAP(s). 10'L and 12'L tables available with zero, one, two, or three TAP(s).

Tip: In addition to the data and audio/video AAPs available from Coalesse, other styles of AAPs are available through Extron Electronics. For an Extron dealer, call 1-800-633-9876.

Tip: See TAP options for electrical systems and faceplate list.

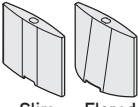
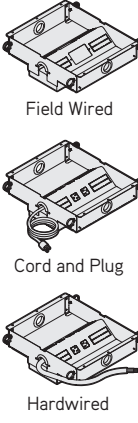
Standard Includes		Required to Specify	
<ul style="list-style-type: none"> ▶ Need help? Product details, page 322 	<ul style="list-style-type: none"> • Top: 1¼" particle board core with laminate • Flat wood edge • TAP(s), if selected: 10"W x 12"L opening(s) trimmed with a flat solid wood profile and with brushed anodized aluminum TAP doors • Tech corridor: two aluminum beams for top support provide tracks for hinged aluminum doors that clip shut: satin anodized finish • Universal clip: black plastic • Two 27"W bases: wood veneer on MDF with aluminum universal bracket • Concealed leveling glides: non-marring, black plastic 	<ol style="list-style-type: none"> 1 Style number 2 Base selection (see below) and wood color number for base 3 Laminate color number for table top, if selected 4 Wood color number for wood edge 5 Door color number for storage tray or TAP door, if selected: <ul style="list-style-type: none"> - 8043 Silver - 8044 Black 6 Options, if selected (see below) 	<ul style="list-style-type: none"> ▶ See <i>Surface Materials</i>, page 600.
Options		U.S. Price	Required to Specify
Surface Materials	Top <ul style="list-style-type: none"> • Grade 2 laminate • Grade 1 wood veneer • Grade 2 wood veneer • Stain-to-Match 	<ul style="list-style-type: none"> Prices at right Prices at right Prices at right No cost 	<ul style="list-style-type: none"> Specify with <i>Grade 2 laminate</i> and select color number. Specify with <i>Grade 1 wood veneer</i> and select color number. Specify with <i>Grade 2 wood veneer</i> and select color number. Specify with <i>Stain-to-Match</i>.
Edges	Wood <ul style="list-style-type: none"> • Bullnose wood edge • Horizon wood edge 	<ul style="list-style-type: none"> Prices at right Prices at right 	<ul style="list-style-type: none"> Specify with <i>bullnose wood edge</i>. Specify with <i>Horizon wood edge</i>.
Bases	 <ul style="list-style-type: none"> • Two slim bases • One slim and one flared base • Two flared bases 	<ul style="list-style-type: none"> No cost +\$ 693 +\$1386 	<ul style="list-style-type: none"> Specify with <i>two slim bases</i>. Specify with <i>one slim base and one flared base</i>. Specify with <i>two flared bases</i>.
TAP Electrical System with Faceplate Options	 <ul style="list-style-type: none"> • Field-Wired tray (no electrical) <ul style="list-style-type: none"> - PAFW Field-Wired tray (no electrical) with blank AAPs - PDFW Field-Wired tray (no electrical) with two Data AAPs - PVFW Field-Wired tray (no electrical) with two of each Video/Audio and Data AAPs • Cord and Plug tray (10' cord) <ul style="list-style-type: none"> - PACP Cord and Plug tray with outlets and blank AAPs - PDCP Cord and Plug tray with outlets and two Data AAPs - PAVC Cord and Plug tray with outlets and two of each Video/Audio and Data AAPs • Hard-Wired tray (6' conduit) <ul style="list-style-type: none"> - PAHW Hard-Wired tray with outlets and blank AAPs - PDHW Hard-Wired tray with outlets and two Data AAPs - PAVH Hard-Wired tray with outlets and two of each Video/Audio and Data AAPs 	<ul style="list-style-type: none"> No cost No cost No cost 	<ul style="list-style-type: none"> Specify with <i>power data</i>, and select TAP type and TAP door color number. Specify with <i>power data</i>, and select TAP type and TAP door color number. Specify with <i>power data</i>, and select TAP type and TAP door color number.

▶ Options, continued on next page



For Canadian Pricing
 Multiply U.S. Price by the Canadian price factor.
 ▶ See page 1 for details.

Host Collection Soft Radiused Tables with Two Bases

DESIGN F/P DESIGN AND VECTA DESIGN TEAM

► Options, continued from previous page

Tip: For single TAP style numbers, the modular system tray is not available. Specify the hard-wired tray option.

Tip: If the specified table has multiple TAP(s), any one TAP can be replaced with a storage tray.

Tip: Wood veneer doors for storage tray and TAP will always be cross grain.

Tip: Connectrac must be the same wiring schematic as the table.

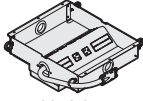
Options	U.S. Price	Required to Specify
TAP Electrical System with Faceplate Options ► Page 334  Modular	<ul style="list-style-type: none"> • Modular System tray (hardwire base power infeed) +\$119 each tray - PAMH Modular System tray with outlets and blank AAPs - PDMH Modular System tray with outlets and two Data AAPs - PVMH Modular System tray with outlets and two of each Video/Audio and Data AAPs 	Specify with <i>modular power data</i> , and select TAP type and TAP door color number.
Storage Tray ► Page 335	<ul style="list-style-type: none"> • Storage tray -\$500 	Specify with <i>storage tray</i> and select door color number.
Doors	<ul style="list-style-type: none"> • Storage tray wood veneer doors +\$250 per door • TAP wood veneer doors +\$250 per door 	Specify with <i>wood doors</i> .
Related Products	<ul style="list-style-type: none"> • Floor kit: Connectrac • Corridor shelf 	► Page 463 ► Page 463

TAP Locations

96"L x 48"W TAP Locations—One piece top

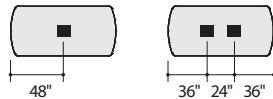

10'L x 48"W TAP Locations—One piece top

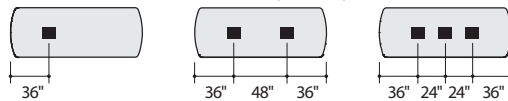

10'L x 48"W TAP Locations—Two piece top

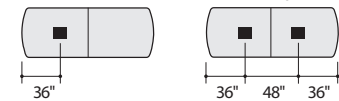

10'L x 60"W TAP Locations—One piece top

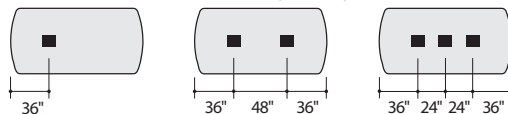

10'L x 60"W TAP Locations—Two piece top

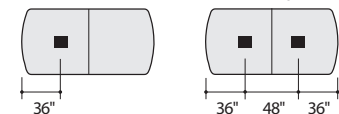

12'L x 48"W TAP Locations—One piece top

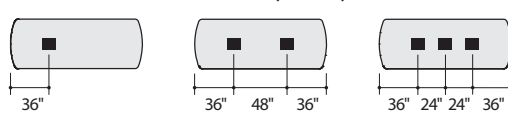

12'L x 48"W TAP Locations—Two piece top

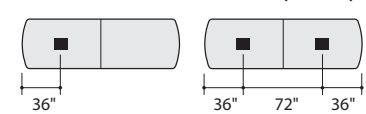

12'L x 60"W TAP Locations—One piece top

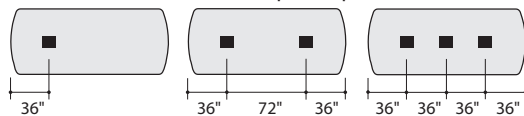

12'L x 60"W TAP Locations—Two piece top

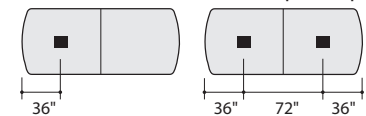

► Specification Information on next page



For Canadian Pricing
 Multiply U.S. Price by the Canadian price factor.
 ► See page 1 for details.

Host Collection Soft Radiused Tables with Two Bases *continued*

DESIGN F/P DESIGN AND VECTA DESIGN TEAM

Tip: Prices shown include top, TAP(s), and slim bases.
 ▶ See base options for flared bases, page 374

Tip: Last digit of style number indicates number of TAP(s).

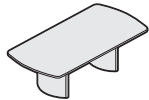

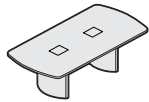
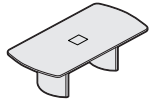

Tip: For tech corridor, 96"L tables have two long doors and four short doors.



▶ Options on previous page

Specification Information

Style Number	Finish	U.S. Base Prices		
				
		Flat Wood Edge:	Bullnose Wood Edge:	Horizon Wood Edge:

96"L x 48"W One Piece Top

0 TAP

HS9648S10	Grade 1 Laminate	\$5624	\$5708	\$ 7364
	Grade 2 Laminate	\$5723	\$5807	\$ 7463
	Grade 1 Veneer	\$6050	\$6134	\$ 7790
	Grade 2 Veneer	\$6556	\$6640	\$ 8296

1 TAP

HS9648S11	Grade 1 Laminate	\$6933	\$7017	\$ 8673
	Grade 2 Laminate	\$7032	\$7116	\$ 8772
	Grade 1 Veneer	\$7359	\$7443	\$ 9099
	Grade 2 Veneer	\$7865	\$7949	\$ 9605

2 TAPS

HS9648S12	Grade 1 Laminate	\$8243	\$8327	\$ 9982
	Grade 2 Laminate	\$8342	\$8426	\$10,081
	Grade 1 Veneer	\$8669	\$8753	\$10,408
	Grade 2 Veneer	\$9175	\$9259	\$10,914

▶ Specification Information, continued on next page



For Canadian Pricing
 Multiply U.S. Price by the Canadian price factor.
 ▶ See page 1 for details.

Host Collection Soft Radiused Tables with Two Bases

DESIGN F/P DESIGN AND VECTA DESIGN TEAM

Tip: Prices shown include top, TAP(s), and slim bases.
 ▶ See base options for flared bases, page 374

Tip: Last digit of style number indicates number of TAP(s).

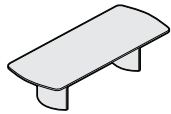

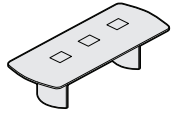
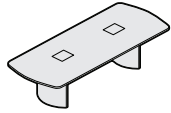
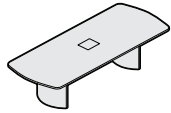

Tip: For tech corridor, 10'L tables have four long doors and four short doors.



▶ Specification Information, continued from previous page

Specification Information

Style Number	Finish	U.S. Base Prices		
				
		Flat Wood Edge:	Bullnose Wood Edge:	Horizon Wood Edge:

10'L x 48"W One Piece Top

0 TAP

HS1048S10	Grade 1 Laminate	\$ 6064	\$ 6161	\$ 7934
	Grade 2 Laminate	\$ 6188	\$ 6285	\$ 8058
	Grade 1 Veneer	\$ 6582	\$ 6679	\$ 8452
	Grade 2 Veneer	\$ 7214	\$ 7311	\$ 9084

1 TAP

HS1048S11	Grade 1 Laminate	\$ 7373	\$ 7470	\$ 9243
	Grade 2 Laminate	\$ 7497	\$ 7594	\$ 9367
	Grade 1 Veneer	\$ 7891	\$ 7988	\$ 9761
	Grade 2 Veneer	\$ 8523	\$ 8620	\$10,393

2 TAPS

HS1048S12	Grade 1 Laminate	\$ 8683	\$ 8780	\$10,553
	Grade 2 Laminate	\$ 8807	\$ 8904	\$10,677
	Grade 1 Veneer	\$ 9201	\$ 9298	\$11,071
	Grade 2 Veneer	\$ 9833	\$ 9930	\$11,703

3 TAPS

HS1048S13	Grade 1 Laminate	\$ 9993	\$10,090	\$11,863
	Grade 2 Laminate	\$10,117	\$10,214	\$11,987
	Grade 1 Veneer	\$10,511	\$10,608	\$12,381
	Grade 2 Veneer	\$11,143	\$11,240	\$13,013

▶ Specification Information, continued on next page



For Canadian Pricing
 Multiply U.S. Price by the Canadian price factor.
 ▶ See page 1 for details.

Host Collection Soft Radiused Tables with Two Bases *continued*

DESIGN F/P DESIGN AND VECTA DESIGN TEAM



Tip: Prices shown include top, TAP(s), and slim bases.

► See base options for flared bases, page 374

Tip: Last digit of style number indicates number of TAP(s).

► Specification Information, continued from previous page

Specification Information

Style Number	Finish	U.S. Base Prices		
				
		Flat Wood Edge:	Bullnose Wood Edge:	Horizon Wood Edge:

10'L x 48"W Two Piece Top

0 TAP

HS1048S20	Grade 1 Laminate	\$ 6377	\$ 6474	\$ 8247
	Grade 2 Laminate	\$ 6501	\$ 6598	\$ 8371
	Grade 1 Veneer	\$ 6895	\$ 6992	\$ 8765
	Grade 2 Veneer	\$ 7527	\$ 7624	\$ 9397

1 TAP

HS1048S21	Grade 1 Laminate	\$ 7687	\$ 7784	\$ 9557
	Grade 2 Laminate	\$ 7811	\$ 7908	\$ 9681
	Grade 1 Veneer	\$ 8205	\$ 8302	\$10,075
	Grade 2 Veneer	\$ 8837	\$ 8934	\$10,707

2 TAPS

HS1048S22	Grade 1 Laminate	\$ 8997	\$ 9094	\$10,867
	Grade 2 Laminate	\$ 9121	\$ 9218	\$10,991
	Grade 1 Veneer	\$ 9515	\$ 9612	\$11,385
	Grade 2 Veneer	\$10,147	\$10,244	\$12,017

10'L x 60"W One Piece Top

0 TAP

HS1060S10	Grade 1 Laminate	\$ 6226	\$ 6330	\$ 8116
	Grade 2 Laminate	\$ 6381	\$ 6485	\$ 8271
	Grade 1 Veneer	\$ 7139	\$ 7243	\$ 9029
	Grade 2 Veneer	\$ 7938	\$ 8042	\$ 9828

1 TAP

HS1060S11	Grade 1 Laminate	\$ 7535	\$ 7639	\$ 9425
	Grade 2 Laminate	\$ 7690	\$ 7794	\$ 9580
	Grade 1 Veneer	\$ 8448	\$ 8552	\$10,338
	Grade 2 Veneer	\$ 9247	\$ 9351	\$11,137

2 TAPS

HS1060S12	Grade 1 Laminate	\$ 8845	\$ 8949	\$10,735
	Grade 2 Laminate	\$ 9000	\$ 9104	\$10,890
	Grade 1 Veneer	\$ 9758	\$ 9862	\$11,648
	Grade 2 Veneer	\$10,557	\$10,661	\$12,447

► Specification Information, continued on next page

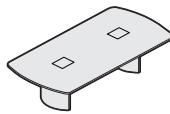
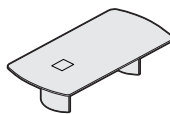
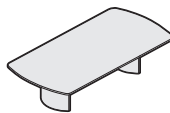
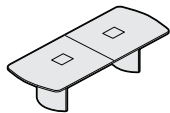
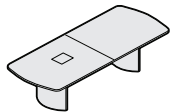
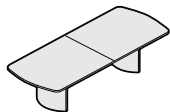

For Canadian Pricing
 Multiply U.S. Price by the Canadian price factor.
 ► See page 1 for details.

Host Collection Soft Radiused Tables with Two Bases



DESIGN F/P DESIGN AND VECTA DESIGN TEAM

Tip: Prices shown include top, TAP(s), and slim bases.
 ▶ See base options for flared bases, page 374

Tip: Last digit of style number indicates number of TAP(s).

▶ Specification Information, continued from previous page

Specification Information

Style Number	Finish	U.S. Base Prices		
				
		Flat Wood Edge:	Bullnose Wood Edge:	Horizon Wood Edge:

10'L x 60"W One Piece Top, continued

3 TAPS

HS1060S13	Grade 1 Laminate	\$10,155	\$10,259	\$12,045
	Grade 2 Laminate	\$10,310	\$10,414	\$12,200
	Grade 1 Veneer	\$11,068	\$11,172	\$12,958
	Grade 2 Veneer	\$11,867	\$11,971	\$13,757

10'L x 60"W Two Piece Top

0 TAP

HS1060S20	Grade 1 Laminate	\$ 6539	\$ 6643	\$ 8429
	Grade 2 Laminate	\$ 6694	\$ 6798	\$ 8584
	Grade 1 Veneer	\$ 7452	\$ 7556	\$ 9342
	Grade 2 Veneer	\$ 8251	\$ 8355	\$10,141

1 TAP

HS1060S21	Grade 1 Laminate	\$ 7849	\$ 7953	\$ 9739
	Grade 2 Laminate	\$ 8004	\$ 8108	\$ 9894
	Grade 1 Veneer	\$ 8762	\$ 8866	\$10,652
	Grade 2 Veneer	\$ 9561	\$ 9665	\$11,451

2 TAPS

HS1060S22	Grade 1 Laminate	\$ 9159	\$ 9263	\$11,049
	Grade 2 Laminate	\$ 9314	\$ 9418	\$11,204
	Grade 1 Veneer	\$10,072	\$10,176	\$11,962
	Grade 2 Veneer	\$10,871	\$10,975	\$12,761

12'L x 48"W One Piece Top

0 TAP

HS1248S10	Grade 1 Laminate	\$ 6454	\$ 6565	\$ 8358
	Grade 2 Laminate	\$ 6603	\$ 6714	\$ 8507
	Grade 1 Veneer	\$ 7139	\$ 7250	\$ 9043
	Grade 2 Veneer	\$ 7901	\$ 8012	\$ 9805

1 TAP

HS1248S11	Grade 1 Laminate	\$ 7764	\$ 7875	\$ 9668
	Grade 2 Laminate	\$ 7913	\$ 8024	\$ 9817
	Grade 1 Veneer	\$ 8449	\$ 8560	\$10,353
	Grade 2 Veneer	\$ 9211	\$ 9322	\$11,115

▶ Specification Information, continued on next page

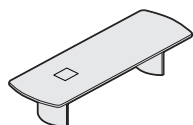
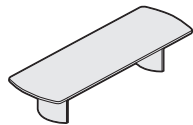
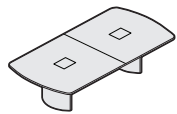
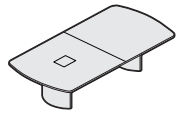
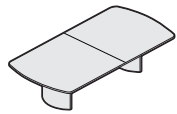
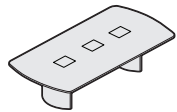

For Canadian Pricing
 Multiply U.S. Price by the Canadian price factor.
 ▶ See page 1 for details.

Host Collection Soft Radiused Tables with Two Bases *continued*

DESIGN F/P DESIGN AND VECTA DESIGN TEAM

Tip: Prices shown include top, TAP(s), and slim bases.
 ▶ See base options for flared bases, page 374

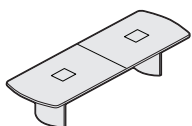
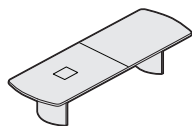
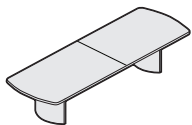
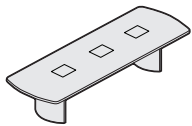
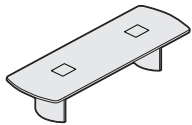

Tip: Last digit of style number indicates number of TAP(s).

Tip: For tech corridor, 12'L tables have four long doors and four short doors.



▶ Specification Information, continued from previous page

Specification Information

Style Number	Finish	U.S. Base Prices		
				
		Flat Wood Edge:	Bullnose Wood Edge:	Horizon Wood Edge:

12'L x 48''W One Piece Top, continued

2 TAPS

HS1248S12	Grade 1 Laminate	\$ 9074	\$ 9185	\$10,978
	Grade 2 Laminate	\$ 9223	\$ 9334	\$11,127
	Grade 1 Veneer	\$ 9759	\$ 9870	\$11,663
	Grade 2 Veneer	\$10,521	\$10,632	\$12,425

3 TAPS

HS1248S13	Grade 1 Laminate	\$10,384	\$10,495	\$12,288
	Grade 2 Laminate	\$10,533	\$10,644	\$12,437
	Grade 1 Veneer	\$11,069	\$11,180	\$12,973
	Grade 2 Veneer	\$11,831	\$11,942	\$13,735

12'L x 48''W Two Piece Top

0 TAP

HS1248S20	Grade 1 Laminate	\$ 6767	\$ 6878	\$ 8671
	Grade 2 Laminate	\$ 6916	\$ 7027	\$ 8820
	Grade 1 Veneer	\$ 7452	\$ 7563	\$ 9356
	Grade 2 Veneer	\$ 8214	\$ 8325	\$10,118

1 TAP

HS1248S21	Grade 1 Laminate	\$ 8078	\$ 8189	\$ 9982
	Grade 2 Laminate	\$ 8227	\$ 8338	\$10,131
	Grade 1 Veneer	\$ 8763	\$ 8874	\$10,667
	Grade 2 Veneer	\$ 9525	\$ 9636	\$11,429

2 TAPS

HS1248S22	Grade 1 Laminate	\$ 9388	\$ 9499	\$11,292
	Grade 2 Laminate	\$ 9537	\$ 9648	\$11,441
	Grade 1 Veneer	\$10,073	\$10,184	\$11,977
	Grade 2 Veneer	\$10,835	\$10,946	\$12,739

▶ Specification Information, continued on next page



For Canadian Pricing
 Multiply U.S. Price by the Canadian price factor.
 ▶ See page 1 for details.

Host Collection Soft Radiused Tables with Two Bases



DESIGN F/P DESIGN AND VECTA DESIGN TEAM

Tip: Prices shown include top, TAP(s), and slim bases.
 ▶ See base options for flared bases, page 374

Tip: Last digit of style number indicates number of TAP(s).

▶ Specification Information, continued from previous page

Specification Information

Style Number	Finish	U.S. Base Prices		
				
		Flat Wood Edge:	Bullnose Wood Edge:	Horizon Wood Edge:

12'L x 60"W One Piece Top

0 TAP

HS1260S10	Grade 1 Laminate	\$ 6625	\$ 6742	\$ 8549
	Grade 2 Laminate	\$ 6811	\$ 6928	\$ 8735
	Grade 1 Veneer	\$ 7747	\$ 7864	\$ 9671
	Grade 2 Veneer	\$ 8707	\$ 8824	\$10,631

1 TAP

HS1260S11	Grade 1 Laminate	\$ 7935	\$ 8052	\$ 9859
	Grade 2 Laminate	\$ 8121	\$ 8238	\$10,045
	Grade 1 Veneer	\$ 9057	\$ 9174	\$10,981
	Grade 2 Veneer	\$10,017	\$10,134	\$11,941

2 TAPS

HS1260S12	Grade 1 Laminate	\$ 9245	\$ 9362	\$11,169
	Grade 2 Laminate	\$ 9431	\$ 9548	\$11,355
	Grade 1 Veneer	\$10,367	\$10,484	\$12,291
	Grade 2 Veneer	\$11,327	\$11,444	\$13,251

3 TAPS

HS1260S13	Grade 1 Laminate	\$10,555	\$10,672	\$12,479
	Grade 2 Laminate	\$10,741	\$10,858	\$12,665
	Grade 1 Veneer	\$11,677	\$11,794	\$13,601
	Grade 2 Veneer	\$12,637	\$12,754	\$14,561

▶ Specification Information, continued on next page

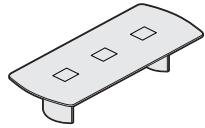
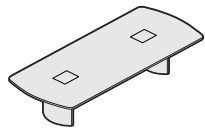
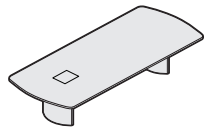
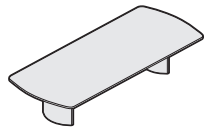

For Canadian Pricing
 Multiply U.S. Price by the Canadian price factor.
 ▶ See page 1 for details.

Host Collection Soft Radiused Tables with Two Bases *continued*



DESIGN F/P DESIGN AND VECTA DESIGN TEAM

Tip: Prices shown include top, TAP(s), and slim bases.
 ▶ See base options for flared bases, page 374

Tip: Last digit of style number indicates number of TAP(s).

▶ Specification Information, continued from previous page

Specification Information

Style Number	Finish	U.S. Base Prices		
				
		Flat Wood Edge:	Bullnose Wood Edge:	Horizon Wood Edge:

12'L x 60"W Two Piece Top

0 TAP

HS1260S20	Grade 1 Laminate	\$ 6938	\$ 7055	\$ 8862
	Grade 2 Laminate	\$ 7124	\$ 7241	\$ 9048
	Grade 1 Veneer	\$ 8060	\$ 8177	\$ 9984
	Grade 2 Veneer	\$ 9020	\$ 9137	\$10,944

1 TAP

HS1260S21	Grade 1 Laminate	\$ 8249	\$ 8366	\$10,173
	Grade 2 Laminate	\$ 8435	\$ 8552	\$10,359
	Grade 1 Veneer	\$ 9371	\$ 9488	\$11,295
	Grade 2 Veneer	\$10,331	\$10,448	\$12,255

2 TAPS

HS1260S22	Grade 1 Laminate	\$ 9559	\$ 9676	\$11,483
	Grade 2 Laminate	\$ 9745	\$ 9862	\$11,669
	Grade 1 Veneer	\$10,681	\$10,798	\$12,605
	Grade 2 Veneer	\$11,641	\$11,758	\$13,565

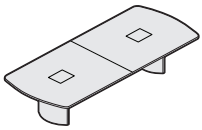
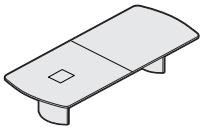
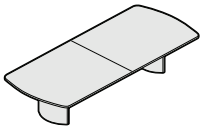

For Canadian Pricing
 Multiply U.S. Price by the Canadian price factor.
 ▶ See page 1 for details.

Coalesse

Host Collection

Soft Radiused Tables with Two Bases

DESIGN F/P DESIGN AND VECTA DESIGN TEAM

Host Collection Soft Radiused Tables with Three Bases

DESIGN F/P DESIGN AND VECTA DESIGN TEAM

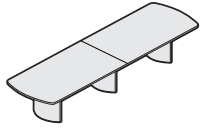

Tip: Shipped knocked down and top ships in one piece.

Tip: Grain direction for wood-grain laminate runs the length of the table.

Tip: Clips are provided with table: One clip per foot of table length.

Tip: The wood edge on a table top with woodgrain laminate may not match the top.

Tip: You must send a sample of reasonable size for Stain-to-Match.

Tip: 14'L and 16'L tables available with zero, one, two, or four TAP(s). 18'L and 20'L tables available with zero, one, two, four, or six TAP(s).

Tip: In addition to the data and audio/video AAPs available from Coalesse, other styles of AAPs are available through Extron Electronics. For an Extron dealer, call 1-800-633-9876.

Tip: See TAP options for electrical systems and faceplate list.

Veneer direction



Standard Includes	Required to Specify
<ul style="list-style-type: none"> ▶ Need help? Product details, page 322 • Top: 1/4" particle board core with laminate • Flat wood edge • TAP(s), if selected: 10"W x 12"L opening(s) trimmed with a flat solid wood profile and with brushed anodized aluminum TAP doors • Tech corridor: four aluminum beams for top support provide tracks for hinged aluminum doors that clip shut: satin anodized finish • Universal clip: black plastic • Three 27"W bases: wood veneer on MDF with aluminum universal bracket, see below • Concealed leveling glides: non-marring, black plastic 	<ol style="list-style-type: none"> 1 Style number 2 Base selection (see below) and wood color number for base 3 Laminate color number for table top, if selected 4 Wood color number for wood edge 5 Door color number for storage tray or TAP door, if selected: <ul style="list-style-type: none"> - 8043 Silver - 8044 Black 6 Options, if selected (see below) <p>▶ See <i>Surface Materials</i>, page 600.</p>

Options	U.S. Price	Required to Specify
Surface Materials <ul style="list-style-type: none"> • Top • Grade 2 laminate • Grade 1 wood veneer • Grade 2 wood veneer • Stain-to-Match 	<ul style="list-style-type: none"> Prices at right Prices at right Prices at right No cost 	<ul style="list-style-type: none"> Specify with <i>Grade 2 laminate</i> and select color number. Specify with <i>Grade 1 wood veneer</i> and select color number. Specify with <i>Grade 2 wood veneer</i> and select color number. Specify with <i>Stain-to-Match</i>. <p>▶ Page 5</p>

Edges	Wood	U.S. Price	Required to Specify
	<ul style="list-style-type: none"> • Bullnose wood edge • Horizon wood edge 	<ul style="list-style-type: none"> Prices at right Prices at right 	<ul style="list-style-type: none"> Specify with <i>bullnose wood edge</i>. Specify with <i>Horizon wood edge</i>.

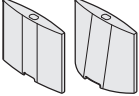
Bases	U.S. Price	Required to Specify
 <ul style="list-style-type: none"> • Three slim bases • Two slim and one flared bases • One slim and two flared bases • Three flared bases 	<ul style="list-style-type: none"> No cost +\$ 693 +\$1386 +\$2079 	<ul style="list-style-type: none"> Specify with <i>three slim bases</i>. Specify with <i>two slim and one flared bases</i>. Specify with <i>one slim and two flared bases</i>. Specify with <i>three flared bases</i>.

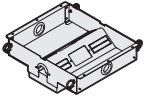
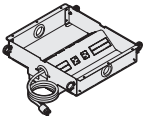
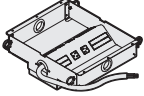
TAP Electrical System with Faceplate Options	U.S. Price	Required to Specify
<p>▶ Page 334</p>  <p>Field Wired</p>  <p>Cord and Plug</p>  <p>Hardwired</p>	<ul style="list-style-type: none"> • Field-Wired tray (no electrical) No cost - PAFW Field-Wired tray (no electrical) with blank AAPs - PDFW Field-Wired tray (no electrical) with two Data AAPs - PVFW Field-Wired tray (no electrical) with two of each Video/Audio and Data AAPs • Cord and Plug tray (10' cord) No cost - PACP Cord and Plug tray with outlets and blank AAPs - PDCP Cord and Plug tray with outlets and two Data AAPs - PAVC Cord and Plug tray with outlets and two of each Video/Audio and Data AAPs • Hard-Wired tray (6' conduit) No cost - PAHW Hard-Wired tray with outlets and blank AAPs - PDHW Hard-Wired tray with outlets and two Data AAPs - PAVH Hard-Wired tray with outlets and two of each Video/Audio and Data AAPs 	<ul style="list-style-type: none"> Specify with <i>power data</i>, and select TAP type and TAP door color number. Specify with <i>power data</i>, and select TAP type and TAP door color number. Specify with <i>power data</i>, and select TAP type and TAP door color number.

▶ Options, continued on next page



For Canadian Pricing
 Multiply U.S. Price by the Canadian price factor.
 ▶ See page 1 for details.

Host Collection Soft Radiused Tables with Three Bases

DESIGN F/P DESIGN AND VECTA DESIGN TEAM

►Options, continued from previous page

Tip: For single TAP style numbers, the modular system tray is not available. Specify the hard-wired tray option.

Tip: If the specified table has multiple TAPs, any one TAP can be replaced with a storage tray.

Tip: Wood veneer doors for storage tray or TAP will always be cross grain.

Tip: Connectrac must be the same wiring schematic as the table.

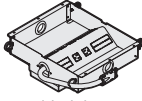
Options	U.S. Price	Required to Specify
TAP Electrical System with Faceplate Options ► Page 334  Modular	<ul style="list-style-type: none"> • Modular System tray (hardwire base power infeed) +\$119 each tray - PAMH Modular System tray with outlets and blank AAPs - PDMH Modular System tray with outlets and two Data AAPs - PVMH Modular System tray with outlets and two of each Video/Audio and Data AAPs 	Specify with <i>modular power data</i> , and select TAP type and TAP door color number.
Storage Tray ► Page 335	<ul style="list-style-type: none"> • Storage tray -\$500 	Specify with <i>storage tray</i> and select door color number.
Doors	<ul style="list-style-type: none"> • Storage tray wood veneer doors +\$250 per door • TAP wood veneer doors +\$250 per door 	Specify with <i>wood doors</i> .
Related Products	<ul style="list-style-type: none"> • Floor kit: Connectrac • Corridor shelf 	► Page 463 ► Page 463

TAP Locations

14'L x 48"W TAP Locations—Two piece top

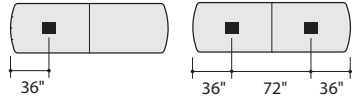

14'L x 48"W TAP Locations—Three piece top

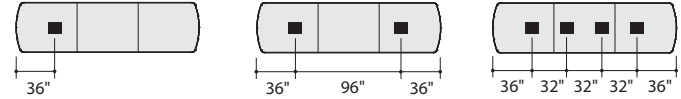

14'L x 60"W TAP Locations—Two piece top

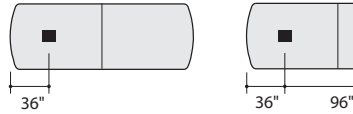

14'L x 60"W TAP Locations—Three piece top

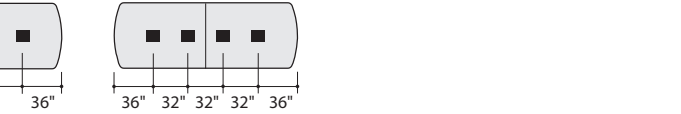

14'L x 60"W TAP Locations—Three piece top

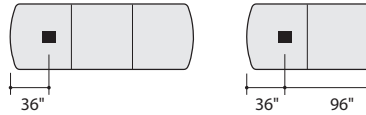

14'L x 60"W TAP Locations—Two piece top

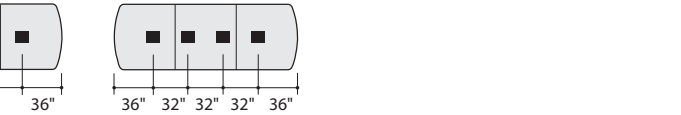

16'L x 48"W TAP Locations—Two piece top



16'L x 48"W TAP Locations—Three piece top

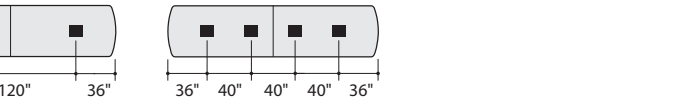

16'L x 48"W TAP Locations—Three piece top

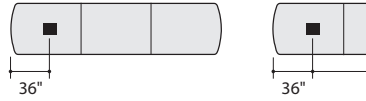

16'L x 48"W TAP Locations—Two piece top

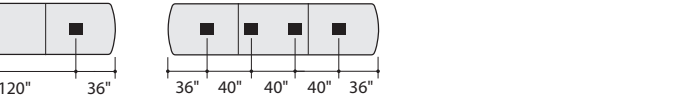

16'L x 60"W TAP Locations—Two piece top



16'L x 60"W TAP Locations—Three piece top

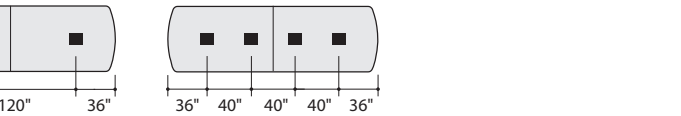

►Options, continued on next page

For Canadian Pricing
 Multiply U.S. Price by the Canadian price factor.
 ► See page 1 for details.

Host Collection Soft Radiused Tables with Three Bases *continued*

DESIGN F/P DESIGN AND VECTA DESIGN TEAM

►Options, continued from previous page

TAP Locations

16'L x 60"W TAP Locations—Three piece top

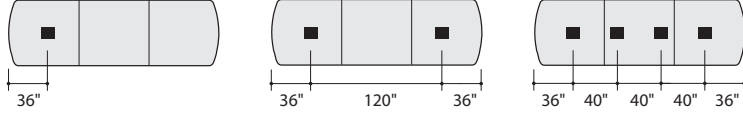

18'L x 48"W TAP Locations—Two piece top

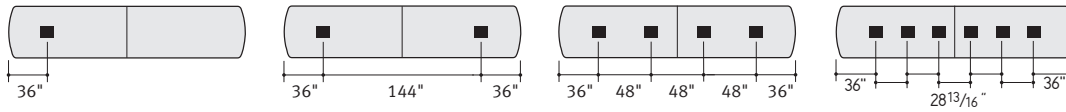

18'L x 48"W TAP Locations—Three piece top

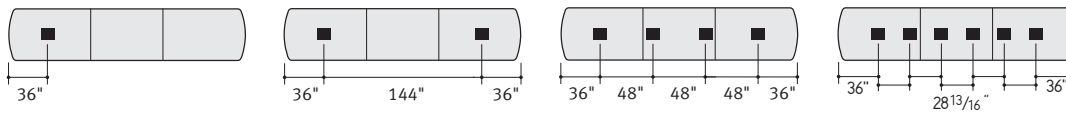

18'L x 60"W TAP Locations—Two piece top

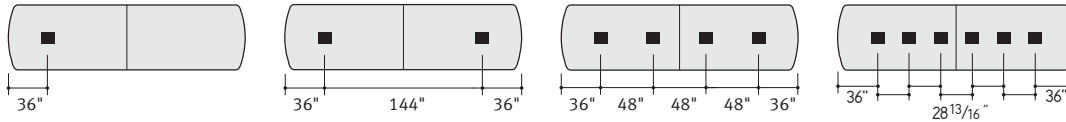

18'L x 60"W TAP Locations—Three piece top

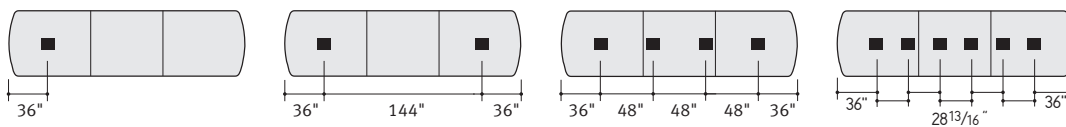

20'L x 48"W TAP Locations—Two piece top

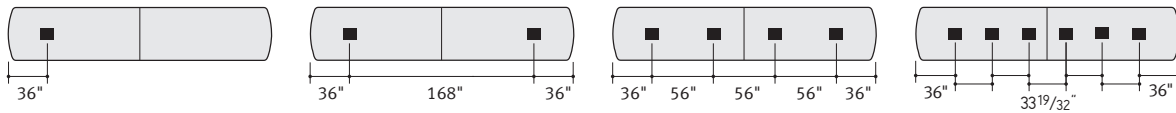

20'L x 48"W TAP Locations—Three piece top

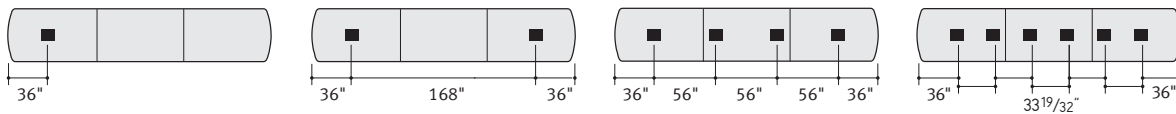

20'L x 60"W TAP Locations—Two piece top

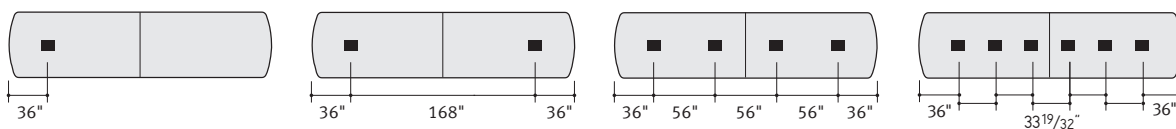

20'L x 60"W TAP Locations—Three piece top

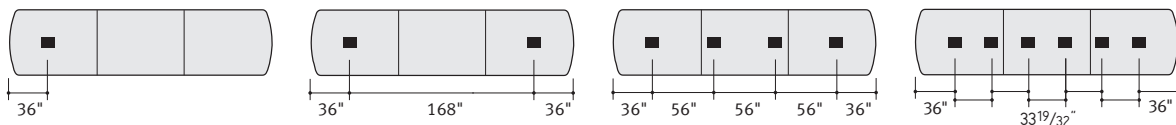

Host Collection Soft Radiused Tables with Three Bases

DESIGN F/P DESIGN AND VECTA DESIGN TEAM



Tip: Prices shown include top, TAP(s), and slim bases.
 ▶ See base options for flared bases, page 384

Tip: Last digit of style number indicates number of TAP(s).

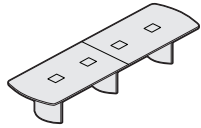
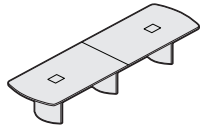
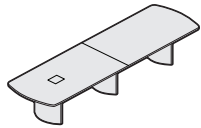
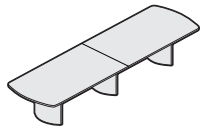
Tip: For tech corridor, 14'L tables have four long doors and four short doors.



Specification Information

Style Number	Finish	U.S. Base Prices		
				
		Flat Wood Edge:	Bullnose Wood Edge:	Horizon Wood Edge:

14'L x 48''W Two Piece Top

0 TAP				
HS1448S20	Grade 1 Laminate	\$ 8773	\$ 8897	\$10,711
	Grade 2 Laminate	\$ 8947	\$ 9071	\$10,885
	Grade 1 Veneer	\$ 9736	\$ 9860	\$11,674
	Grade 2 Veneer	\$10,629	\$10,753	\$12,567
1 TAP				
HS1448S21	Grade 1 Laminate	\$10,083	\$10,207	\$12,021
	Grade 2 Laminate	\$10,257	\$10,381	\$12,195
	Grade 1 Veneer	\$11,046	\$11,170	\$12,984
	Grade 2 Veneer	\$11,939	\$12,063	\$13,877
2 TAPS				
HS1448S22	Grade 1 Laminate	\$11,393	\$11,517	\$13,331
	Grade 2 Laminate	\$11,567	\$11,691	\$13,505
	Grade 1 Veneer	\$12,356	\$12,480	\$14,294
	Grade 2 Veneer	\$13,249	\$13,373	\$15,187
4 TAPS				
HS1448S24	Grade 1 Laminate	\$14,013	\$14,137	\$15,951
	Grade 2 Laminate	\$14,187	\$14,311	\$16,125
	Grade 1 Veneer	\$14,976	\$15,100	\$16,914
	Grade 2 Veneer	\$15,869	\$15,993	\$17,807

▶ Specification Information, continued on next page



For Canadian Pricing
 Multiply U.S. Price by the Canadian price factor.
 ▶ See page 1 for details.

Host Collection Soft Radiused Tables with Three Bases *continued*

DESIGN F/P DESIGN AND VECTA DESIGN TEAM

Tip: Prices shown include top, TAP(s), and slim bases.
 ▶ See base options for flared bases, page 384

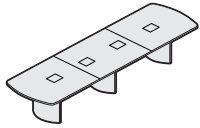
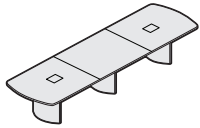
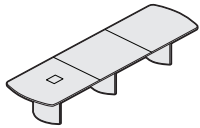
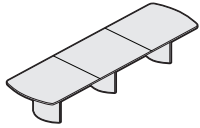

Tip: Last digit of style number indicates number of TAP(s).

Tip: For tech corridor, 14'L tables have four long doors and four short doors.



▶ Specification Information, continued from previous page

Specification Information

Style Number	Finish	U.S. Base Prices		
				
		Flat Wood Edge:	Bullnose Wood Edge:	Horizon Wood Edge:

14'L x 48"W Three Piece Top

0 TAP

HS1448S30	Grade 1 Laminate	\$ 9086	\$ 9210	\$11,024
	Grade 2 Laminate	\$ 9260	\$ 9384	\$11,198
	Grade 1 Veneer	\$10,049	\$10,173	\$11,987
	Grade 2 Veneer	\$10,942	\$11,066	\$12,880

1 TAP

HS1448S31	Grade 1 Laminate	\$10,397	\$10,521	\$12,335
	Grade 2 Laminate	\$10,571	\$10,695	\$12,509
	Grade 1 Veneer	\$11,360	\$11,484	\$13,298
	Grade 2 Veneer	\$12,253	\$12,377	\$14,191

2 TAPS

HS1448S32	Grade 1 Laminate	\$11,707	\$11,831	\$13,645
	Grade 2 Laminate	\$11,881	\$12,005	\$13,819
	Grade 1 Veneer	\$12,670	\$12,794	\$14,608
	Grade 2 Veneer	\$13,563	\$13,687	\$15,501

4 TAPS

HS1448S34	Grade 1 Laminate	\$14,327	\$14,451	\$16,265
	Grade 2 Laminate	\$14,501	\$14,625	\$16,439
	Grade 1 Veneer	\$15,290	\$15,414	\$17,228
	Grade 2 Veneer	\$16,183	\$16,307	\$18,121

▶ Specification Information, continued on next page



For Canadian Pricing
 Multiply U.S. Price by the Canadian price factor.
 ▶ See page 1 for details.

Host Collection Soft Radiused Tables with Three Bases

DESIGN F/P DESIGN AND VECTA DESIGN TEAM

Tip: Prices shown include top, TAP(s), and slim bases.
 ▶ See base options for flared bases, page 384

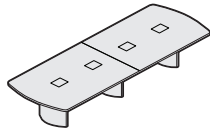
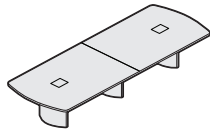
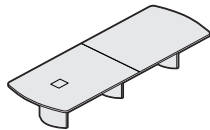
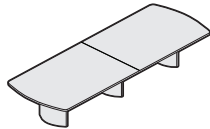

Tip: Last digit of style number indicates number of TAP(s).

Tip: For tech corridor, 14'L tables have four long doors and four short doors.



▶ Specification Information, continued from previous page

Specification Information

Style Number	Finish	U.S. Base Prices		
				
		Flat Wood Edge:	Bullnose Wood Edge:	Horizon Wood Edge:

14'L x 60''W Two Piece Top

0 TAP

Style Number	Finish	Flat Wood Edge	Bullnose Wood Edge	Horizon Wood Edge
HS1460S20	Grade 1 Laminate	\$ 9160	\$ 9290	\$11,112
	Grade 2 Laminate	\$ 9377	\$ 9507	\$11,329
	Grade 1 Veneer	\$10,929	\$11,059	\$12,881
	Grade 2 Veneer	\$12,064	\$12,194	\$14,016

1 TAP

Style Number	Finish	Flat Wood Edge	Bullnose Wood Edge	Horizon Wood Edge
HS1460S21	Grade 1 Laminate	\$10,470	\$10,600	\$12,422
	Grade 2 Laminate	\$10,687	\$10,817	\$12,639
	Grade 1 Veneer	\$12,239	\$12,369	\$14,191
	Grade 2 Veneer	\$13,374	\$13,504	\$15,326

2 TAPS

Style Number	Finish	Flat Wood Edge	Bullnose Wood Edge	Horizon Wood Edge
HS1460S22	Grade 1 Laminate	\$11,780	\$11,910	\$13,732
	Grade 2 Laminate	\$11,997	\$12,127	\$13,949
	Grade 1 Veneer	\$13,549	\$13,679	\$15,501
	Grade 2 Veneer	\$14,684	\$14,814	\$16,636

4 TAPS

Style Number	Finish	Flat Wood Edge	Bullnose Wood Edge	Horizon Wood Edge
HS1460S24	Grade 1 Laminate	\$14,400	\$14,530	\$16,352
	Grade 2 Laminate	\$14,617	\$14,747	\$16,569
	Grade 1 Veneer	\$16,169	\$16,299	\$18,121
	Grade 2 Veneer	\$17,304	\$17,434	\$19,256

▶ Specification Information, continued on next page



For Canadian Pricing
 Multiply U.S. Price by the Canadian price factor.
 ▶ See page 1 for details.

Host Collection Soft Radiused Tables with Three Bases *continued*

DESIGN F/P DESIGN AND VECTA DESIGN TEAM

Tip: Prices shown include top, TAP(s), and slim bases.
 ▶ See base options for flared bases, page 384

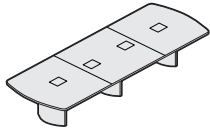
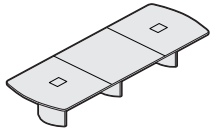
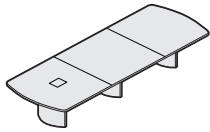
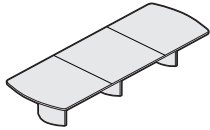

Tip: Last digit of style number indicates number of TAP(s).

Tip: For tech corridor, 14'L tables have four long doors and four short doors.



▶ Specification Information, continued from previous page

Specification Information

Style Number	Finish	U.S. Base Prices		
				
		Flat Wood Edge:	Bullnose Wood Edge:	Horizon Wood Edge:

14'L x 60"W Three Piece Top

0 TAP

HS1460S30	Grade 1 Laminate	\$ 9474	\$ 9604	\$11,426
	Grade 2 Laminate	\$ 9691	\$ 9821	\$11,643
	Grade 1 Veneer	\$11,243	\$11,373	\$13,195
	Grade 2 Veneer	\$12,378	\$12,508	\$14,330

1 TAP

HS1460S31	Grade 1 Laminate	\$10,784	\$10,914	\$12,736
	Grade 2 Laminate	\$11,001	\$11,131	\$12,953
	Grade 1 Veneer	\$12,553	\$12,683	\$14,505
	Grade 2 Veneer	\$13,688	\$13,818	\$15,640

2 TAPS

HS1460S32	Grade 1 Laminate	\$12,094	\$12,224	\$14,046
	Grade 2 Laminate	\$12,311	\$12,441	\$14,263
	Grade 1 Veneer	\$13,863	\$13,993	\$15,815
	Grade 2 Veneer	\$14,998	\$15,128	\$16,950

4 TAPS

HS1460S34	Grade 1 Laminate	\$14,714	\$14,844	\$16,666
	Grade 2 Laminate	\$14,931	\$15,061	\$16,883
	Grade 1 Veneer	\$16,483	\$16,613	\$18,435
	Grade 2 Veneer	\$17,618	\$17,748	\$19,570

▶ Specification Information, continued on next page



For Canadian Pricing
 Multiply U.S. Price by the Canadian price factor.
 ▶ See page 1 for details.

Host Collection Soft Radiused Tables with Three Bases

DESIGN F/P DESIGN AND VECTA DESIGN TEAM

Tip: Prices shown include top, TAP(s), and slim bases.
 ▶ See base options for flared bases, page 384

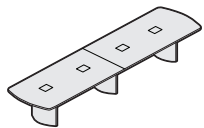
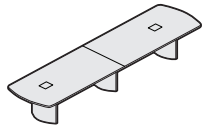
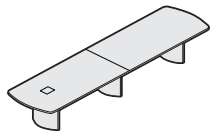
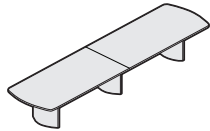

Tip: Last digit of style number indicates number of TAP(s).

Tip: For tech corridor, 16'L tables have eight long doors and four short doors.



▶ Specification Information, continued from previous page

Specification Information

Style Number	Finish	U.S. Base Prices		
				
		Flat Wood Edge:	Bullnose Wood Edge:	Horizon Wood Edge:

16'L x 48''W Two Piece Top

0 TAP

HS1648S20	Grade 1 Laminate	\$ 9128	\$ 9265	\$11,099
	Grade 2 Laminate	\$ 9326	\$ 9463	\$11,297
	Grade 1 Veneer	\$10,087	\$10,224	\$12,058
	Grade 2 Veneer	\$11,105	\$11,242	\$13,076

1 TAP

HS1648S21	Grade 1 Laminate	\$10,437	\$10,574	\$12,408
	Grade 2 Laminate	\$10,635	\$10,772	\$12,606
	Grade 1 Veneer	\$11,396	\$11,533	\$13,367
	Grade 2 Veneer	\$12,414	\$12,551	\$14,385

2 TAPS

HS1648S22	Grade 1 Laminate	\$11,747	\$11,884	\$13,718
	Grade 2 Laminate	\$11,945	\$12,082	\$13,916
	Grade 1 Veneer	\$12,706	\$12,843	\$14,677
	Grade 2 Veneer	\$13,724	\$13,861	\$15,695

4 TAPS

HS1648S24	Grade 1 Laminate	\$14,367	\$14,504	\$16,338
	Grade 2 Laminate	\$14,565	\$14,702	\$16,536
	Grade 1 Veneer	\$15,326	\$15,463	\$17,297
	Grade 2 Veneer	\$16,344	\$16,481	\$18,315

▶ Specification Information, continued on next page



For Canadian Pricing
 Multiply U.S. Price by the Canadian price factor.
 ▶ See page 1 for details.

Host Collection Soft Radiused Tables with Three Bases *continued*

DESIGN F/P DESIGN AND VECTA DESIGN TEAM

Tip: Prices shown include top, TAP(s), and slim bases.
 ▶ See base options for flared bases, page 384

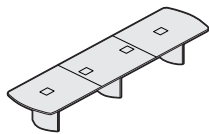
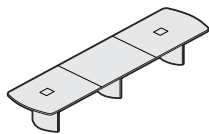
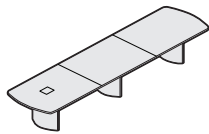
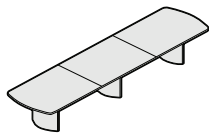

Tip: Last digit of style number indicates number of TAP(s).

Tip: For tech corridor, 16'L tables have eight long doors and four short doors.



▶ Specification Information, continued from previous page

Specification Information

Style Number	Finish	U.S. Base Prices		
				
		Flat Wood Edge:	Bullnose Wood Edge:	Horizon Wood Edge:

16'L x 48"W Three Piece Top

0 TAP

HS1648S30	Grade 1 Laminate	\$ 9441	\$ 9578	\$11,412
	Grade 2 Laminate	\$ 9639	\$ 9776	\$11,610
	Grade 1 Veneer	\$10,400	\$10,537	\$12,371
	Grade 2 Veneer	\$11,418	\$11,555	\$13,389

1 TAP

HS1648S31	Grade 1 Laminate	\$10,751	\$10,888	\$12,722
	Grade 2 Laminate	\$10,949	\$11,086	\$12,920
	Grade 1 Veneer	\$11,710	\$11,847	\$13,681
	Grade 2 Veneer	\$12,728	\$12,865	\$14,699

2 TAPS

HS1648S32	Grade 1 Laminate	\$12,061	\$12,198	\$14,032
	Grade 2 Laminate	\$12,259	\$12,396	\$14,230
	Grade 1 Veneer	\$13,020	\$13,157	\$14,991
	Grade 2 Veneer	\$14,038	\$14,175	\$16,009

4 TAPS

HS1648S34	Grade 1 Laminate	\$14,681	\$14,818	\$16,652
	Grade 2 Laminate	\$14,879	\$15,016	\$16,850
	Grade 1 Veneer	\$15,640	\$15,777	\$17,611
	Grade 2 Veneer	\$16,658	\$16,795	\$18,629

▶ Specification Information, continued on next page



For Canadian Pricing
 Multiply U.S. Price by the Canadian price factor.
 ▶ See page 1 for details.

Host Collection Soft Radiused Tables with Three Bases

DESIGN F/P DESIGN AND VECTA DESIGN TEAM

Tip: Prices shown include top, TAP(s), and slim bases.
 ▶ See base options for flared bases, page 384

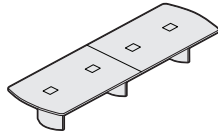
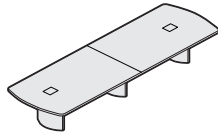
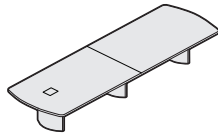
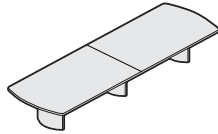

Tip: Last digit of style number indicates number of TAP(s).

Tip: For tech corridor, 16'L tables have eight long doors and four short doors.



▶ Specification Information, continued from previous page

Specification Information

Style Number	Finish	U.S. Base Prices		
				
		Flat Wood Edge:	Bullnose Wood Edge:	Horizon Wood Edge:

16'L x 60''W Two Piece Top

0 TAP

HS1660S20	Grade 1 Laminate	\$ 9515	\$ 9659	\$11,523
	Grade 2 Laminate	\$ 9763	\$ 9907	\$11,771
	Grade 1 Veneer	\$11,281	\$11,425	\$13,289
	Grade 2 Veneer	\$12,570	\$12,714	\$14,578

1 TAP

HS1660S21	Grade 1 Laminate	\$10,824	\$10,968	\$12,832
	Grade 2 Laminate	\$11,072	\$11,216	\$13,080
	Grade 1 Veneer	\$12,590	\$12,734	\$14,598
	Grade 2 Veneer	\$13,879	\$14,023	\$15,887

2 TAPS

HS1660S22	Grade 1 Laminate	\$12,134	\$12,278	\$14,142
	Grade 2 Laminate	\$12,382	\$12,526	\$14,390
	Grade 1 Veneer	\$13,900	\$14,044	\$15,908
	Grade 2 Veneer	\$15,189	\$15,333	\$17,197

4 TAPS

HS1660S24	Grade 1 Laminate	\$14,754	\$14,898	\$16,762
	Grade 2 Laminate	\$15,002	\$15,146	\$17,010
	Grade 1 Veneer	\$16,520	\$16,664	\$18,528
	Grade 2 Veneer	\$17,809	\$17,953	\$19,817

▶ Specification Information, continued on next page



For Canadian Pricing
 Multiply U.S. Price by the Canadian price factor.
 ▶ See page 1 for details.

Host Collection Soft Radiused Tables with Three Bases *continued*

DESIGN F/P DESIGN AND VECTA DESIGN TEAM

Tip: Prices shown include top, TAP(s), and slim bases.
 ▶ See base options for flared bases, page 384

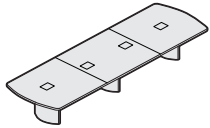
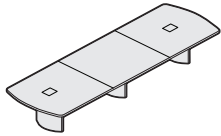
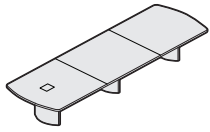
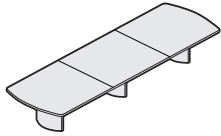

Tip: Last digit of style number indicates number of TAP(s).

Tip: For tech corridor, 16'L tables have eight long doors and four short doors.



▶ Specification Information, continued from previous page

Specification Information

Style Number	Finish	U.S. Base Prices		
				
		Flat Wood Edge:	Bullnose Wood Edge:	Horizon Wood Edge:

16'L x 60"W Three Piece Top

0 TAP

HS1660S30	Grade 1 Laminate	\$ 9828	\$ 9972	\$11,836
	Grade 2 Laminate	\$10,076	\$10,220	\$12,084
	Grade 1 Veneer	\$11,594	\$11,738	\$13,602
	Grade 2 Veneer	\$12,883	\$13,027	\$14,891

1 TAP

HS1660S31	Grade 1 Laminate	\$11,138	\$11,282	\$13,146
	Grade 2 Laminate	\$11,386	\$11,530	\$13,394
	Grade 1 Veneer	\$12,904	\$13,048	\$14,912
	Grade 2 Veneer	\$14,193	\$14,337	\$16,201

2 TAPS

HS1660S32	Grade 1 Laminate	\$12,448	\$12,592	\$14,456
	Grade 2 Laminate	\$12,696	\$12,840	\$14,704
	Grade 1 Veneer	\$14,214	\$14,358	\$16,222
	Grade 2 Veneer	\$15,503	\$15,647	\$17,511

4 TAPS

HS1660S34	Grade 1 Laminate	\$15,068	\$15,212	\$17,076
	Grade 2 Laminate	\$15,316	\$15,460	\$17,324
	Grade 1 Veneer	\$16,834	\$16,978	\$18,842
	Grade 2 Veneer	\$18,123	\$18,267	\$20,131

▶ Specification Information, continued on next page



For Canadian Pricing
 Multiply U.S. Price by the Canadian price factor.
 ▶ See page 1 for details.

Host Collection Soft Radiused Tables with Three Bases

DESIGN F/P DESIGN AND VECTA DESIGN TEAM

Tip: Prices shown include top, TAP(s), and slim bases.
 ▶ See base options for flared bases, page 384

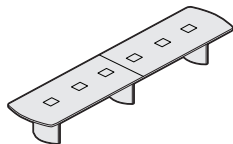
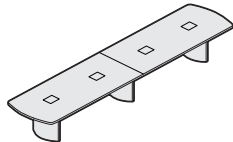
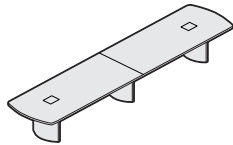
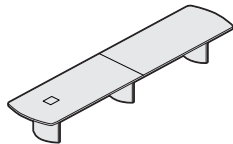
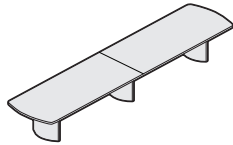

Tip: Last digit of style number indicates number of TAP(s).

Tip: For tech corridor, 18'L tables have eight long doors and four short doors.



▶ Specification Information, continued from previous page

Specification Information

Style Number	Finish	U.S. Base Prices		
				
		Flat Wood Edge:	Bullnose Wood Edge:	Horizon Wood Edge:

18'L x 48"W Two Piece Top

0 TAP

HS1848S20	Grade 1 Laminate	\$ 9690	\$ 9841	\$11,708
	Grade 2 Laminate	\$ 9913	\$10,064	\$11,931
	Grade 1 Veneer	\$10,914	\$11,065	\$12,932
	Grade 2 Veneer	\$12,062	\$12,213	\$14,080

1 TAP

HS1848S21	Grade 1 Laminate	\$11,000	\$11,151	\$13,018
	Grade 2 Laminate	\$11,223	\$11,374	\$13,241
	Grade 1 Veneer	\$12,224	\$12,375	\$14,242
	Grade 2 Veneer	\$13,372	\$13,523	\$15,390

2 TAPS

HS1848S22	Grade 1 Laminate	\$12,310	\$12,461	\$14,328
	Grade 2 Laminate	\$12,533	\$12,684	\$14,551
	Grade 1 Veneer	\$13,534	\$13,685	\$15,552
	Grade 2 Veneer	\$14,682	\$14,833	\$16,700

4 TAPS

HS1848S24	Grade 1 Laminate	\$14,930	\$15,081	\$16,948
	Grade 2 Laminate	\$15,153	\$15,304	\$17,171
	Grade 1 Veneer	\$16,154	\$16,305	\$18,172
	Grade 2 Veneer	\$17,302	\$17,453	\$19,320

6 TAPS

HS1848S26	Grade 1 Laminate	\$17,550	\$17,701	\$19,568
	Grade 2 Laminate	\$17,773	\$17,924	\$19,791
	Grade 1 Veneer	\$18,774	\$18,925	\$20,792
	Grade 2 Veneer	\$19,922	\$20,073	\$21,940

▶ Specification Information, continued on next page



For Canadian Pricing
 Multiply U.S. Price by the Canadian price factor.
 ▶ See page 1 for details.

Host Collection Soft Radiused Tables with Three Bases *continued*

DESIGN F/P DESIGN AND VECTA DESIGN TEAM

Tip: Prices shown include top, TAP(s), and slim bases.
 ▶ See base options for flared bases, page 384

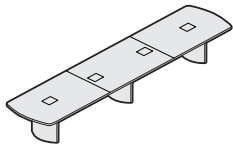
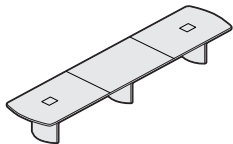
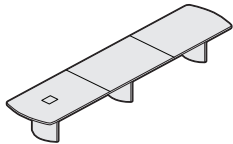
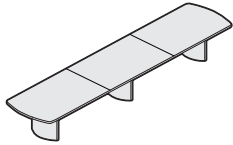

Tip: Last digit of style number indicates number of TAP(s).

Tip: For tech corridor, 18'L tables have eight long doors and four short doors.



▶ Specification Information, continued from previous page

Specification Information

Style Number	Finish	U.S. Base Prices		
				
		Flat Wood Edge:	Bullnose Wood Edge:	Horizon Wood Edge:

18'L x 48"W Three Piece Top

0 TAP

HS1848S30	Grade 1 Laminate	\$10,003	\$10,154	\$12,021
	Grade 2 Laminate	\$10,226	\$10,377	\$12,244
	Grade 1 Veneer	\$11,227	\$11,378	\$13,245
	Grade 2 Veneer	\$12,375	\$12,526	\$14,393

1 TAP

HS1848S31	Grade 1 Laminate	\$11,314	\$11,465	\$13,332
	Grade 2 Laminate	\$11,537	\$11,688	\$13,555
	Grade 1 Veneer	\$12,538	\$12,689	\$14,556
	Grade 2 Veneer	\$13,686	\$13,837	\$15,704

2 TAPS

HS1848S32	Grade 1 Laminate	\$12,624	\$12,775	\$14,642
	Grade 2 Laminate	\$12,847	\$12,998	\$14,865
	Grade 1 Veneer	\$13,848	\$13,999	\$15,866
	Grade 2 Veneer	\$14,996	\$15,147	\$17,014

4 TAPS

HS1848S34	Grade 1 Laminate	\$15,244	\$15,395	\$17,262
	Grade 2 Laminate	\$15,467	\$15,618	\$17,485
	Grade 1 Veneer	\$16,468	\$16,619	\$18,486
	Grade 2 Veneer	\$17,616	\$17,767	\$19,634

6 TAPS

HS1848S36	Grade 1 Laminate	\$17,864	\$18,015	\$19,882
	Grade 2 Laminate	\$18,087	\$18,238	\$20,105
	Grade 1 Veneer	\$19,088	\$19,239	\$21,106
	Grade 2 Veneer	\$20,236	\$20,387	\$22,254

▶ Specification Information, continued on next page



For Canadian Pricing
 Multiply U.S. Price by the Canadian price factor.
 ▶ See page 1 for details.

Host Collection Soft Radiused Tables with Three Bases

DESIGN F/P DESIGN AND VECTA DESIGN TEAM

Tip: Prices shown include top, TAP(s), and slim bases.
 ▶ See base options for flared bases, page 384

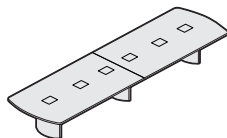
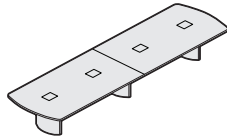
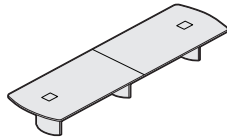
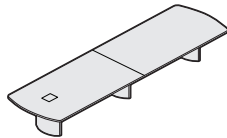
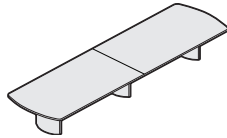

Tip: Last digit of style number indicates number of TAP(s).

Tip: For tech corridor, 18'L tables have eight long doors and four short doors.



▶ Specification Information, continued from previous page

Specification Information

Style Number	Finish	U.S. Base Prices		
				
		Flat Wood Edge:	Bullnose Wood Edge:	Horizon Wood Edge:

18'L x 60"W Two Piece Top

0 TAP

HS1860S20	Grade 1 Laminate	\$ 9898	\$10,055	\$11,949
	Grade 2 Laminate	\$10,177	\$10,334	\$12,228
	Grade 1 Veneer	\$12,260	\$12,417	\$14,311
	Grade 2 Veneer	\$13,721	\$13,878	\$15,772

1 TAP

HS1860S21	Grade 1 Laminate	\$11,207	\$11,364	\$13,258
	Grade 2 Laminate	\$11,486	\$11,643	\$13,537
	Grade 1 Veneer	\$13,569	\$13,726	\$15,620
	Grade 2 Veneer	\$15,030	\$15,187	\$17,081

2 TAPS

HS1860S22	Grade 1 Laminate	\$12,517	\$12,674	\$14,568
	Grade 2 Laminate	\$12,796	\$12,953	\$14,847
	Grade 1 Veneer	\$14,879	\$15,036	\$16,930
	Grade 2 Veneer	\$16,340	\$16,497	\$18,391

4 TAPS

HS1860S24	Grade 1 Laminate	\$15,137	\$15,294	\$17,188
	Grade 2 Laminate	\$15,416	\$15,573	\$17,467
	Grade 1 Veneer	\$17,499	\$17,656	\$19,550
	Grade 2 Veneer	\$18,960	\$19,117	\$21,011

6 TAPS

HS1860S26	Grade 1 Laminate	\$17,757	\$17,914	\$19,808
	Grade 2 Laminate	\$18,036	\$18,193	\$20,087
	Grade 1 Veneer	\$20,119	\$20,276	\$22,170
	Grade 2 Veneer	\$21,580	\$21,737	\$23,631

▶ Specification Information, continued on next page



For Canadian Pricing
 Multiply U.S. Price by the Canadian price factor.
 ▶ See page 1 for details.

Host Collection Soft Radiused Tables with Three Bases *continued*

DESIGN F/P DESIGN AND VECTA DESIGN TEAM

Tip: Prices shown include top, TAP(s), and slim bases.
 ▶ See base options for flared bases, page 384

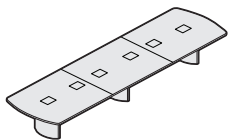
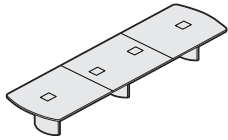
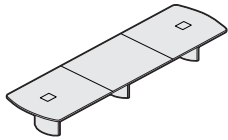
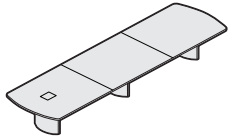
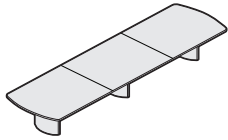

Tip: Last digit of style number indicates number of TAP(s).

Tip: For tech corridor, 18'L tables have eight long doors and four short doors.



▶ Specification Information, continued from previous page

Specification Information

Style Number	Finish	U.S. Base Prices		
				
		Flat Wood Edge:	Bullnose Wood Edge:	Horizon Wood Edge:

18'L x 60"W Three Piece Top

0 TAP

HS1860S30	Grade 1 Laminate	\$10,211	\$10,368	\$12,262
	Grade 2 Laminate	\$10,490	\$10,647	\$12,541
	Grade 1 Veneer	\$12,573	\$12,730	\$14,624
	Grade 2 Veneer	\$14,034	\$14,191	\$16,085

1 TAP

HS1860S31	Grade 1 Laminate	\$11,521	\$11,678	\$13,572
	Grade 2 Laminate	\$11,800	\$11,957	\$13,851
	Grade 1 Veneer	\$13,883	\$14,040	\$15,934
	Grade 2 Veneer	\$15,344	\$15,501	\$17,395

2 TAPS

HS1860S32	Grade 1 Laminate	\$12,831	\$12,988	\$14,882
	Grade 2 Laminate	\$13,110	\$13,267	\$15,161
	Grade 1 Veneer	\$15,193	\$15,350	\$17,244
	Grade 2 Veneer	\$16,654	\$16,811	\$18,705

4 TAPS

HS1860S34	Grade 1 Laminate	\$15,451	\$15,608	\$17,502
	Grade 2 Laminate	\$15,730	\$15,887	\$17,781
	Grade 1 Veneer	\$17,813	\$17,970	\$19,864
	Grade 2 Veneer	\$19,274	\$19,431	\$21,325

6 TAPS

HS1860S36	Grade 1 Laminate	\$18,071	\$18,228	\$20,122
	Grade 2 Laminate	\$18,350	\$18,507	\$20,401
	Grade 1 Veneer	\$20,433	\$20,590	\$22,484
	Grade 2 Veneer	\$21,894	\$22,051	\$23,945

▶ Specification Information, continued on next page



For Canadian Pricing
 Multiply U.S. Price by the Canadian price factor.
 ▶ See page 1 for details.

Host Collection Soft Radiused Tables with Three Bases

DESIGN F/P DESIGN AND VECTA DESIGN TEAM

Tip: Prices shown include top, TAP(s), and slim bases.
 ▶ See base options for flared bases, page 384

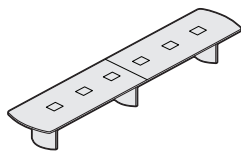
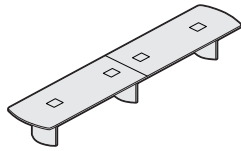
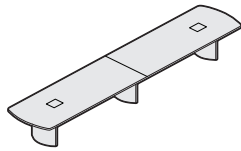
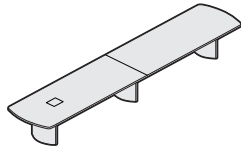
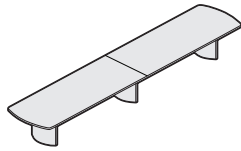

Tip: Last digit of style number indicates number of TAP(s).

Tip: For tech corridor, 20'L tables have eight long doors and four short doors.



▶ Specification Information, continued from previous page

Specification Information

Style Number	Finish	U.S. Base Prices		
				
		Flat Wood Edge:	Bullnose Wood Edge:	Horizon Wood Edge:

20'L x 48"W Two Piece Top

0 TAP

HS2048S20	Grade 1 Laminate	\$10,045	\$10,209	\$12,202
	Grade 2 Laminate	\$10,293	\$10,457	\$12,450
	Grade 1 Veneer	\$11,266	\$11,430	\$13,423
	Grade 2 Veneer	\$12,538	\$12,702	\$14,695

1 TAP

HS2048S21	Grade 1 Laminate	\$11,354	\$11,518	\$13,511
	Grade 2 Laminate	\$11,602	\$11,766	\$13,759
	Grade 1 Veneer	\$12,575	\$12,739	\$14,732
	Grade 2 Veneer	\$13,847	\$14,011	\$16,004

2 TAPS

HS2048S22	Grade 1 Laminate	\$12,664	\$12,828	\$14,821
	Grade 2 Laminate	\$12,912	\$13,076	\$15,069
	Grade 1 Veneer	\$13,885	\$14,049	\$16,042
	Grade 2 Veneer	\$15,157	\$15,321	\$17,314

4 TAPS

HS2048S24	Grade 1 Laminate	\$15,284	\$15,448	\$17,441
	Grade 2 Laminate	\$15,532	\$15,696	\$17,689
	Grade 1 Veneer	\$16,505	\$16,669	\$18,662
	Grade 2 Veneer	\$17,777	\$17,941	\$19,934

6 TAPS

HS2048S26	Grade 1 Laminate	\$17,924	\$18,088	\$20,081
	Grade 2 Laminate	\$18,172	\$18,336	\$20,329
	Grade 1 Veneer	\$19,145	\$19,309	\$21,302
	Grade 2 Veneer	\$20,417	\$20,581	\$22,574

▶ Specification Information, continued on next page

Host Collection

For Canadian Pricing
 Multiply U.S. Price by the Canadian price factor.
 ▶ See page 1 for details.

Host Collection Soft Radiused Tables with Three Bases *continued*

DESIGN F/P DESIGN AND VECTA DESIGN TEAM

Tip: Prices shown include top, TAP(s), and slim bases.
 ▶ See base options for flared bases, page 384

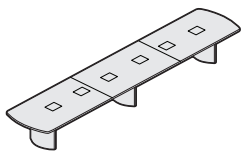
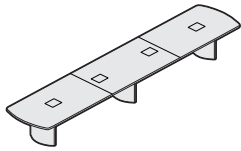
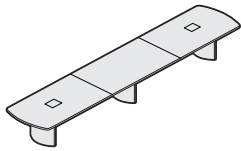
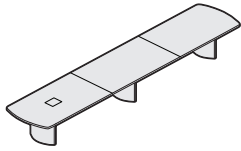
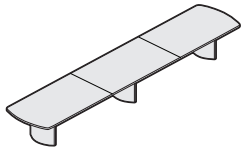

Tip: Last digit of style number indicates number of TAP(s).

Tip: For tech corridor, 20'L tables have eight long doors and four short doors.



► Specification Information, continued from previous page

Specification Information

Style Number	Finish	U.S. Base Prices		
				
		Flat Wood Edge:	Bullnose Wood Edge:	Horizon Wood Edge:

20'L x 48"W Three Piece Top

0 TAP

HS2048S30	Grade 1 Laminate	\$10,358	\$10,522	\$12,515
	Grade 2 Laminate	\$10,606	\$10,770	\$12,763
	Grade 1 Veneer	\$11,579	\$11,743	\$13,736
	Grade 2 Veneer	\$12,851	\$13,015	\$15,008

1 TAP

HS2048S31	Grade 1 Laminate	\$11,668	\$11,832	\$13,825
	Grade 2 Laminate	\$11,916	\$12,080	\$14,073
	Grade 1 Veneer	\$12,889	\$13,053	\$15,046
	Grade 2 Veneer	\$14,161	\$14,325	\$16,318

2 TAPS

HS2048S32	Grade 1 Laminate	\$12,978	\$13,142	\$15,135
	Grade 2 Laminate	\$13,226	\$13,390	\$15,383
	Grade 1 Veneer	\$14,199	\$14,363	\$16,356
	Grade 2 Veneer	\$15,471	\$15,635	\$17,628

4 TAPS

HS2048S34	Grade 1 Laminate	\$15,598	\$15,762	\$17,753
	Grade 2 Laminate	\$15,846	\$16,010	\$18,001
	Grade 1 Veneer	\$16,819	\$16,983	\$18,974
	Grade 2 Veneer	\$18,091	\$18,255	\$20,246

6 TAPS

HS2048S36	Grade 1 Laminate	\$18,218	\$18,382	\$20,373
	Grade 2 Laminate	\$18,466	\$18,630	\$20,621
	Grade 1 Veneer	\$19,439	\$19,603	\$21,594
	Grade 2 Veneer	\$20,711	\$20,875	\$22,866

► Specification Information, continued on next page



For Canadian Pricing
 Multiply U.S. Price by the Canadian price factor.
 ▶ See page 1 for details.

Host Collection Soft Radiused Tables with Three Bases

DESIGN F/P DESIGN AND VECTA DESIGN TEAM

Tip: Prices shown include top, TAP(s), and slim bases.
 ▶ See base options for flared bases, page 384

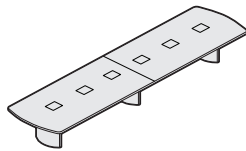
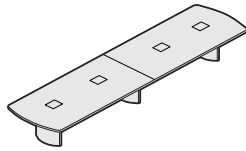
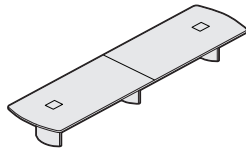
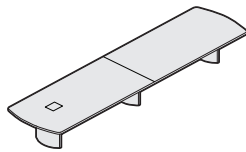
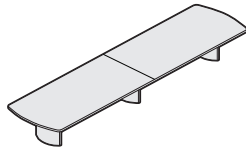

Tip: Last digit of style number indicates number of TAP(s).

Tip: For tech corridor, 20'L tables have eight long doors and four short doors.



▶ Specification Information, continued from previous page

Specification Information

Style Number	Finish	U.S. Base Prices		
				
		Flat Wood Edge:	Bullnose Wood Edge:	Horizon Wood Edge:

20'L x 60''W Two Piece Top

0 TAP				
HS2060S20	Grade 1 Laminate	\$10,252	\$10,422	\$12,453
	Grade 2 Laminate	\$10,562	\$10,732	\$12,763
	Grade 1 Veneer	\$12,611	\$12,781	\$14,812
	Grade 2 Veneer	\$14,226	\$14,396	\$16,427
1 TAP				
HS2060S21	Grade 1 Laminate	\$11,562	\$11,732	\$13,763
	Grade 2 Laminate	\$11,872	\$12,042	\$14,073
	Grade 1 Veneer	\$13,921	\$14,091	\$16,122
	Grade 2 Veneer	\$15,536	\$15,706	\$17,737
2 TAPS				
HS2060S22	Grade 1 Laminate	\$12,872	\$13,042	\$15,073
	Grade 2 Laminate	\$13,182	\$13,352	\$15,383
	Grade 1 Veneer	\$15,231	\$15,401	\$17,432
	Grade 2 Veneer	\$16,846	\$17,016	\$19,047
4 TAPS				
HS2060S24	Grade 1 Laminate	\$15,492	\$15,662	\$17,693
	Grade 2 Laminate	\$15,802	\$15,972	\$18,003
	Grade 1 Veneer	\$17,851	\$18,021	\$20,052
	Grade 2 Veneer	\$19,466	\$19,636	\$21,667
6 TAPS				
HS2060S26	Grade 1 Laminate	\$18,112	\$18,282	\$20,313
	Grade 2 Laminate	\$18,422	\$18,592	\$20,623
	Grade 1 Veneer	\$20,471	\$20,641	\$22,672
	Grade 2 Veneer	\$22,086	\$22,256	\$24,287

▶ Specification Information, continued on next page



For Canadian Pricing
 Multiply U.S. Price by the Canadian price factor.
 ▶ See page 1 for details.

Host Collection Soft Radiused Tables with Three Bases *continued*

DESIGN F/P DESIGN AND VECTA DESIGN TEAM



► Specification Information, continued from previous page

Tip: Prices shown include top, TAP(s), and slim bases.
 ► See base options for flared bases, page 384

Tip: Last digit of style number indicates number of TAP(s).

Tip: For tech corridor, 20'L tables have eight long doors and four short doors.

Specification Information

Style Number	Finish	U.S. Base Prices		
				
		Flat Wood Edge:	Bullnose Wood Edge:	Horizon Wood Edge:

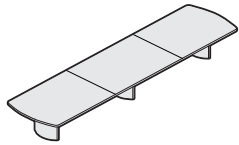

20'L x 60''W Three Piece Top

0 TAP

HS2060S30	Grade 1 Laminate	\$10,565	\$10,735	\$12,766
	Grade 2 Laminate	\$10,875	\$11,045	\$13,076
	Grade 1 Veneer	\$12,924	\$13,094	\$15,125
	Grade 2 Veneer	\$14,539	\$14,709	\$16,740

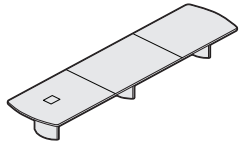

1 TAP

HS2060S31	Grade 1 Laminate	\$11,876	\$12,046	\$14,077
	Grade 2 Laminate	\$12,186	\$12,356	\$14,387
	Grade 1 Veneer	\$14,235	\$14,405	\$16,436
	Grade 2 Veneer	\$15,850	\$16,020	\$18,051

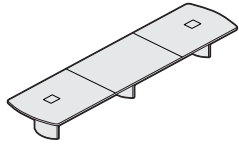

2 TAPS

HS2060S32	Grade 1 Laminate	\$13,186	\$13,356	\$15,387
	Grade 2 Laminate	\$13,496	\$13,666	\$15,697
	Grade 1 Veneer	\$15,545	\$15,715	\$17,746
	Grade 2 Veneer	\$17,160	\$17,330	\$19,361

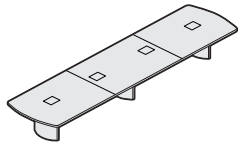

4 TAPS

HS2060S34	Grade 1 Laminate	\$15,806	\$15,976	\$18,007
	Grade 2 Laminate	\$16,116	\$16,286	\$18,317
	Grade 1 Veneer	\$18,165	\$18,335	\$20,366
	Grade 2 Veneer	\$19,780	\$19,950	\$21,981

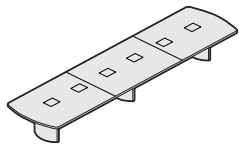

6 TAPS

HS2060S36	Grade 1 Laminate	\$18,426	\$18,596	\$20,627
	Grade 2 Laminate	\$18,736	\$18,906	\$20,937
	Grade 1 Veneer	\$20,785	\$20,995	\$22,986
	Grade 2 Veneer	\$22,400	\$22,570	\$24,601



For Canadian Pricing
 Multiply U.S. Price by the Canadian price factor.
 ► See page 1 for details.

Coalesse

Host Collection

Soft Radiused Tables with Three Bases

DESIGN F/P DESIGN AND VECTA DESIGN TEAM

Host Collection Racetrack Tables with Two Bases

DESIGN F/P DESIGN AND VECTA DESIGN TEAM

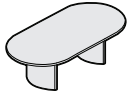

Tip: Shipped knocked down.

Tip: Grain direction for wood-grain laminate runs the length of the table.

Tip: Clips are provided with table: one clip per foot of table length.

Tip: The wood edge on a table top with woodgrain laminate may not match the top.

Tip: You must send a sample of reasonable size for Stain-to-Match.

Standard Includes		Required to Specify
<ul style="list-style-type: none"> ▶ Need help? Product details, page 322 	<ul style="list-style-type: none"> • Top: 1/4" particle board core with laminate • Flat wood edge • TAP(s), if selected: 10"W x 12"L opening(s) trimmed with a flat solid wood profile and with brushed anodized aluminum TAP doors • Tech corridor: two aluminum beams for top support provide tracks for hinged aluminum doors that clip shut: satin anodized finish • Universal clip: black plastic • Two 27"W bases: wood veneer on MDF with aluminum universal bracket • Concealed leveling glides: non-marring, black plastic 	<ol style="list-style-type: none"> 1 Style number 2 Base selection (see below) and wood color number for base 3 Laminate color number for table top, if selected 4 Wood color number for wood edge 5 Door color number for storage tray or TAP door, if selected: <ul style="list-style-type: none"> - 8043 Silver - 8044 Black 6 Options, if selected (see below) <p>▶ See <i>Surface Materials</i>, page 600.</p>

Options	U.S. Price	Required to Specify
Surface Materials <ul style="list-style-type: none"> • Top • Grade 2 laminate • Grade 1 wood veneer • Grade 2 wood veneer • Stain-to-Match 	<ul style="list-style-type: none"> Prices at right Prices at right Prices at right No cost 	<ul style="list-style-type: none"> Specify with <i>Grade 2 laminate</i> and select color number. Specify with <i>Grade 1 wood veneer</i> and select color number. Specify with <i>Grade 2 wood veneer</i> and select color number. Specify with <i>Stain-to-Match</i>. <p>▶ Page 5</p>

Edges	Wood	U.S. Price	Required to Specify
	<ul style="list-style-type: none"> • Bullnose wood edge • Beveled wood edge • Horizon wood edge 	<ul style="list-style-type: none"> Prices at right Prices at right Prices at right 	<ul style="list-style-type: none"> Specify with <i>bullnose wood edge</i>. Specify with <i>beveled wood edge</i>. Specify with <i>Horizon wood edge</i>.

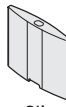
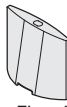
Bases	Options	U.S. Price	Required to Specify
  <p>Slim Flared</p>	<ul style="list-style-type: none"> • Two slim bases • One slim and one flared base • Two flared bases 	<ul style="list-style-type: none"> No cost +\$ 693 +\$1386 	<ul style="list-style-type: none"> Specify with <i>two slim bases</i>. Specify with <i>one slim base and one flared base</i>. Specify with <i>two flared bases</i>.

Tip: 96"L tables available with zero, one, or two TAP(s). 10'L and 12'L tables available with zero, one, two, or three TAP(s).

Tip: In addition to the data and audio/video AAPs available from Coalesse, other styles of AAPs are available through Extron Electronics. For an Extron dealer, call 1-800-633-9876.

Tip: See TAP options for electrical systems and faceplate list.

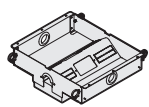
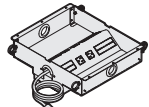
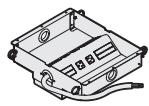
TAP Electrical System with Faceplate Options	Options	U.S. Price	Required to Specify
 <p>Field Wired</p>	<ul style="list-style-type: none"> • Field-Wired tray (no electrical) <ul style="list-style-type: none"> - PAFW Field-Wired tray (no electrical) with blank AAPs - PDFW Field-Wired tray (no electrical) with two Data AAPs - PVFW Field-Wired tray (no electrical) with two of each Video/Audio and Data AAPs 	<ul style="list-style-type: none"> No cost 	<ul style="list-style-type: none"> Specify with <i>power data</i>, and select TAP type and TAP door color number.
 <p>Cord and Plug</p>	<ul style="list-style-type: none"> • Cord and Plug tray (10' cord) <ul style="list-style-type: none"> - PACP Cord and Plug tray with outlets and blank AAPs - PDCP Cord and Plug tray with outlets and two Data AAPs - PAVC Cord and Plug tray with outlets and two of each Video/Audio and Data AAPs 	<ul style="list-style-type: none"> No cost 	<ul style="list-style-type: none"> Specify with <i>power data</i>, and select TAP type and TAP door color number.
 <p>Hardwired</p>	<ul style="list-style-type: none"> • Hard-Wired tray (6' conduit) <ul style="list-style-type: none"> - PAHW Hard-Wired tray with outlets and blank AAPs - PDHW Hard-Wired tray with outlets and two Data AAPs - PAVH Hard-Wired tray with outlets and two of each Video/Audio and Data AAPs 	<ul style="list-style-type: none"> No cost 	<ul style="list-style-type: none"> Specify with <i>power data</i>, and select TAP type and TAP door color number.

▶ Options, continued on next page



For Canadian Pricing
 Multiply U.S. Price by the Canadian price factor.
 ▶ See page 1 for details.

Host Collection Racetrack Tables with Two Bases

DESIGN F/P DESIGN AND VECTA DESIGN TEAM

► Options, continued from previous page

Tip: For single TAP style numbers, the modular system tray is not available. Specify the hardwire tray option.

Tip: If the specified table has multiple TAP(s), any one TAP can be replaced with a storage tray.

Tip: Wood veneer doors for storage tray and TAP will always be cross grain.

Tip: Connectrac must be the same wiring schematic as the table.

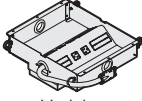
Options	U.S. Price	Required to Specify
TAP Electrical System with Faceplate Options ► Page 334  Modular	<ul style="list-style-type: none"> • Modular System tray (hardwire base power infeed) +\$119 each tray - PAMH Modular System tray with outlets and blank AAPs - PDMH Modular System tray with outlets and two Data AAPs - PVMH Modular System tray with outlets and two of each Video/Audio and Data AAPs 	Specify with <i>modular power data</i> , and select TAP type and TAP door color number.
Storage Tray ► Page 335	<ul style="list-style-type: none"> • Storage tray -\$500 	Specify with <i>storage tray</i> and select door color number.
Doors	<ul style="list-style-type: none"> • Storage tray wood veneer doors +\$250 per door • TAP wood veneer doors +\$250 per door 	Specify with <i>wood doors</i> .
Related Products	<ul style="list-style-type: none"> • Floor kit: Connectrac • Corridor shelf 	► Page 463 ► Page 463

TAP Locations

96"L x 48"W TAP Locations—One piece top

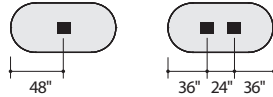

10'L x 48"W TAP Locations—One piece top

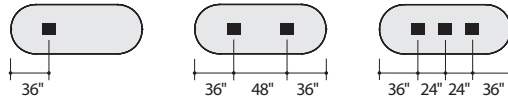

10'L x 48"W TAP Locations—Two piece top

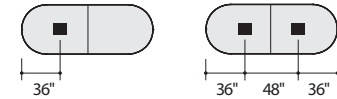

10'L x 60"W TAP Locations—One piece top

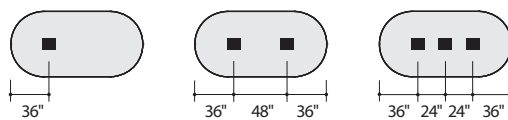

10'L x 60"W TAP Locations—Two piece top

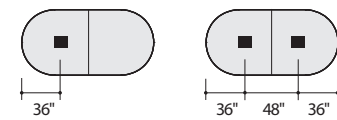

12'L x 48"W TAP Locations—One piece top

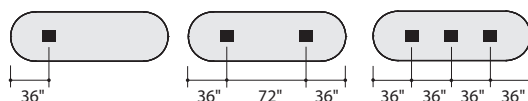

12'L x 48"W TAP Locations—Two piece top

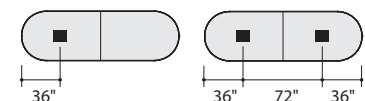

12'L x 60"W TAP Locations—One piece top

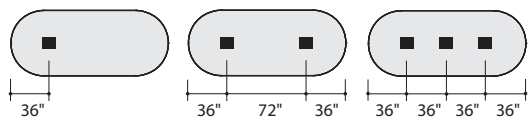

12'L x 60"W TAP Locations—Two piece top

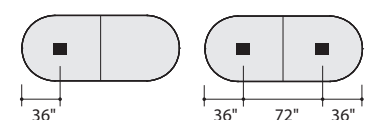

► Specification Information on next page



For Canadian Pricing
 Multiply U.S. Price by the Canadian price factor.
 ► See page 1 for details.

Host Collection Racetrack Tables with Two Bases *continued*

DESIGN F/P DESIGN AND VECTA DESIGN TEAM

Tip: Prices shown include top, TAP(s), and slim bases.
 ▶ See base options for flared bases, page 404



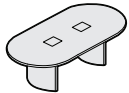
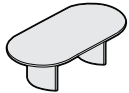

Tip: Last digit of style number indicates number of TAP(s).

Tip: For tech corridor, 96"L tables have two long doors and four short doors.



▶ Options, on previous page

Specification Information

Style Number	Finish	U.S. Base Prices			
					
		Flat Wood Edge:	Bullnose Wood Edge:	Beveled Wood Edge:	Horizon Wood Edge:

96"L x 48"W One Piece Top

0 TAP

HS9648C10	Grade 1 Laminate	\$5732	\$5816	\$5931	\$ 7499
	Grade 2 Laminate	\$5831	\$5915	\$6030	\$ 7598
	Grade 1 Veneer	\$6319	\$6403	\$6518	\$ 8086
	Grade 2 Veneer	\$6830	\$6914	\$7029	\$ 8597

1 TAP

HS9648C11	Grade 1 Laminate	\$7041	\$7125	\$7240	\$ 8808
	Grade 2 Laminate	\$7140	\$7224	\$7339	\$ 8907
	Grade 1 Veneer	\$7628	\$7712	\$7827	\$ 9395
	Grade 2 Veneer	\$8139	\$8223	\$8338	\$ 9906

2 TAPS

HS9648C12	Grade 1 Laminate	\$8351	\$8435	\$8550	\$10,118
	Grade 2 Laminate	\$8450	\$8534	\$8649	\$10,217
	Grade 1 Veneer	\$8938	\$9022	\$9137	\$10,705
	Grade 2 Veneer	\$9449	\$9533	\$9648	\$11,216

▶ Specification Information, continued on next page



For Canadian Pricing
 Multiply U.S. Price by the Canadian price factor.
 ▶ See page 1 for details.

Host Collection Racetrack Tables with Two Bases

DESIGN F/P DESIGN AND VECTA DESIGN TEAM

Tip: Prices shown include top, TAP(s), and slim bases.
 ▶ See base options for flared bases, page 404

Tip: Last digit of style number indicates number of TAP(s).

Tip: For tech corridor, 10'L tables have four long doors and four short doors.

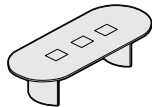
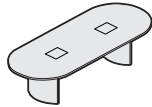
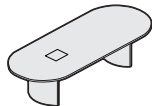
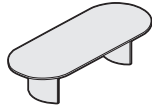

▶ Specification Information, continued from previous page

Specification Information

Style Number	Finish	U.S. Base Prices			
		Flat Wood Edge:	Bullnose Wood Edge:	Beveled Wood Edge:	Horizon Wood Edge:

10'L x 48"W One Piece Top

0 TAP					
HS1048C10	Grade 1 Laminate	\$ 6232	\$ 6329	\$ 6463	\$ 8032
	Grade 2 Laminate	\$ 6356	\$ 6453	\$ 6587	\$ 8156
	Grade 1 Veneer	\$ 6940	\$ 7037	\$ 7171	\$ 8740
	Grade 2 Veneer	\$ 7580	\$ 7677	\$ 7811	\$ 9380
1 TAP					
HS1048C11	Grade 1 Laminate	\$ 7542	\$ 7639	\$ 7773	\$ 9342
	Grade 2 Laminate	\$ 7666	\$ 7763	\$ 7897	\$ 9466
	Grade 1 Veneer	\$ 8250	\$ 8347	\$ 8481	\$10,050
	Grade 2 Veneer	\$ 8890	\$ 8987	\$ 9121	\$10,690
2 TAPS					
HS1048C12	Grade 1 Laminate	\$ 8852	\$ 8949	\$ 9083	\$10,652
	Grade 2 Laminate	\$ 8976	\$ 9073	\$ 9207	\$10,776
	Grade 1 Veneer	\$ 9561	\$ 9658	\$ 9792	\$11,361
	Grade 2 Veneer	\$10,200	\$10,297	\$10,431	\$12,000
3 TAPS					
HS1048C13	Grade 1 Laminate	\$10,162	\$10,259	\$10,393	\$11,962
	Grade 2 Laminate	\$10,286	\$10,383	\$10,517	\$12,086
	Grade 1 Veneer	\$10,870	\$10,967	\$11,101	\$12,670
	Grade 2 Veneer	\$11,510	\$11,607	\$11,741	\$13,310

▶ Specification Information, continued on next page

For Canadian Pricing
 Multiply U.S. Price by the Canadian price factor.
 ▶ See page 1 for details.

Host Collection Racetrack Tables with Two Bases *continued*

DESIGN F/P DESIGN AND VECTA DESIGN TEAM

Tip: Prices shown include top, TAP(s), and slim bases.
 ▶ See base options for flared bases, page 404

Tip: Last digit of style number indicates number of TAP(s).

Tip: For tech corridor, 10'L tables have four long doors and four short doors.

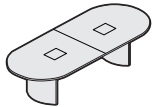
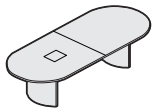
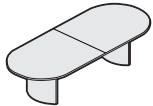

▶ Specification Information, continued from previous page

Specification Information

Style Number	Finish	U.S. Base Prices			
		Flat Wood Edge:	Bullnose Wood Edge:	Beveled Wood Edge:	Horizon Wood Edge:

10'L x 48"W Two Piece Top

0 TAP

HS1048C20	Grade 1 Laminate	\$ 6546	\$ 6643	\$ 6777	\$ 8346
	Grade 2 Laminate	\$ 6670	\$ 6767	\$ 6901	\$ 8470
	Grade 1 Veneer	\$ 7254	\$ 7351	\$ 7485	\$ 9054
	Grade 2 Veneer	\$ 7894	\$ 7991	\$ 8125	\$ 9694

1 TAP

HS1048C21	Grade 1 Laminate	\$ 7856	\$ 7953	\$ 8087	\$ 9656
	Grade 2 Laminate	\$ 7980	\$ 8077	\$ 8211	\$ 9780
	Grade 1 Veneer	\$ 8564	\$ 8661	\$ 8795	\$10,364
	Grade 2 Veneer	\$ 9204	\$ 9301	\$ 9435	\$11,004

2 TAPS

HS1048C22	Grade 1 Laminate	\$ 9166	\$ 9263	\$ 9397	\$10,966
	Grade 2 Laminate	\$ 9290	\$ 9387	\$ 9521	\$11,090
	Grade 1 Veneer	\$ 9874	\$ 9971	\$10,105	\$11,674
	Grade 2 Veneer	\$10,514	\$10,611	\$10,745	\$12,314

▶ Specification Information, continued on next page



For Canadian Pricing
 Multiply U.S. Price by the Canadian price factor.
 ▶ See page 1 for details.

Host Collection Racetrack Tables with Two Bases

DESIGN F/P DESIGN AND VECTA DESIGN TEAM

Tip: Prices shown include top, TAP(s), and slim bases.
 ▶ See base options for flared bases, page 404



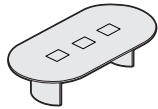
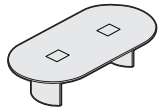
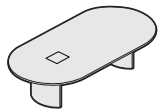
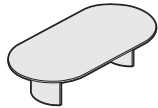

Tip: Last digit of style number indicates number of TAP(s).

Tip: For tech corridor, 10'L tables have four long doors and four short doors.



▶ Specification Information, continued from previous page

Specification Information

Style Number	Finish	U.S. Base Prices			
					
		Flat Wood Edge:	Bullnose Wood Edge:	Beveled Wood Edge:	Horizon Wood Edge:

10'L x 60''W One Piece Top

0 TAP

Style Number	Finish	Flat Wood Edge	Bullnose Wood Edge	Beveled Wood Edge	Horizon Wood Edge
HS1060C10	Grade 1 Laminate	\$ 6361	\$ 6465	\$ 6609	\$ 8175
	Grade 2 Laminate	\$ 6516	\$ 6620	\$ 6764	\$ 8330
	Grade 1 Veneer	\$ 7475	\$ 7579	\$ 7723	\$ 9289
	Grade 2 Veneer	\$ 8280	\$ 8384	\$ 8528	\$10,094

1 TAP

Style Number	Finish	Flat Wood Edge	Bullnose Wood Edge	Beveled Wood Edge	Horizon Wood Edge
HS1060C11	Grade 1 Laminate	\$ 7670	\$ 7774	\$ 7918	\$ 9484
	Grade 2 Laminate	\$ 7825	\$ 7929	\$ 8073	\$ 9639
	Grade 1 Veneer	\$ 8784	\$ 8888	\$ 9032	\$10,598
	Grade 2 Veneer	\$ 9589	\$ 9693	\$ 9837	\$11,403

2 TAPS

Style Number	Finish	Flat Wood Edge	Bullnose Wood Edge	Beveled Wood Edge	Horizon Wood Edge
HS1060C12	Grade 1 Laminate	\$ 8980	\$ 9084	\$ 9228	\$10,794
	Grade 2 Laminate	\$ 9135	\$ 9239	\$ 9383	\$10,949
	Grade 1 Veneer	\$10,094	\$10,198	\$10,342	\$11,908
	Grade 2 Veneer	\$10,899	\$11,003	\$11,147	\$12,713

3 TAPS

Style Number	Finish	Flat Wood Edge	Bullnose Wood Edge	Beveled Wood Edge	Horizon Wood Edge
HS1060C13	Grade 1 Laminate	\$10,290	\$10,394	\$10,538	\$12,104
	Grade 2 Laminate	\$10,445	\$10,549	\$10,693	\$12,259
	Grade 1 Veneer	\$11,404	\$11,508	\$11,652	\$13,218
	Grade 2 Veneer	\$12,209	\$12,313	\$12,457	\$14,023

▶ Specification Information, continued on next page



For Canadian Pricing
 Multiply U.S. Price by the Canadian price factor.
 ▶ See page 1 for details.

Host Collection Racetrack Tables with Two Bases *continued*

DESIGN F/P DESIGN AND VECTA DESIGN TEAM

Tip: Prices shown include top, TAP(s), and slim bases.
 ▶ See base options for flared bases, page 404

Tip: Last digit of style number indicates number of TAP(s).

Tip: For tech corridor, 10'L tables have four long doors and four short doors.

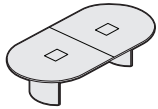
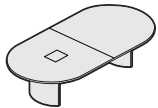
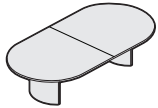

▶ Specification Information, continued from previous page

Specification Information

Style Number	Finish	U.S. Base Prices			
		Flat Wood Edge:	Bullnose Wood Edge:	Beveled Wood Edge:	Horizon Wood Edge:

10'L x 60"W Two Piece Top

0 TAP

HS1060C20	Grade 1 Laminate	\$ 6674	\$ 6778	\$ 6922	\$ 8488
	Grade 2 Laminate	\$ 6829	\$ 6933	\$ 7077	\$ 8643
	Grade 1 Veneer	\$ 7788	\$ 7892	\$ 8036	\$ 9602
	Grade 2 Veneer	\$ 8593	\$ 8697	\$ 8841	\$10,407

1 TAP

HS1060C21	Grade 1 Laminate	\$ 7984	\$ 8088	\$ 8232	\$ 9798
	Grade 2 Laminate	\$ 8139	\$ 8243	\$ 8387	\$ 9953
	Grade 1 Veneer	\$ 9098	\$ 9202	\$ 9346	\$10,912
	Grade 2 Veneer	\$ 9903	\$10,007	\$10,151	\$11,717

2 TAPS

HS1060C22	Grade 1 Laminate	\$ 9294	\$ 9398	\$ 9542	\$11,108
	Grade 2 Laminate	\$ 9449	\$ 9553	\$ 9697	\$11,263
	Grade 1 Veneer	\$10,408	\$10,512	\$10,656	\$12,222
	Grade 2 Veneer	\$11,213	\$11,317	\$11,461	\$13,027

▶ Specification Information, continued on next page



For Canadian Pricing
 Multiply U.S. Price by the Canadian price factor.
 ▶ See page 1 for details.

Host Collection Racetrack Tables with Two Bases

DESIGN F/P DESIGN AND VECTA DESIGN TEAM

Tip: Prices shown include top, TAP(s), and slim bases.
 ▶ See base options for flared bases, page 404

Tip: Last digit of style number indicates number of TAP(s).

Tip: For tech corridor, 12'L tables have four long doors and four short doors.

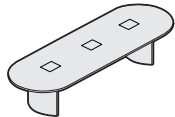
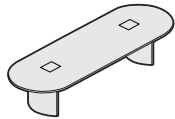
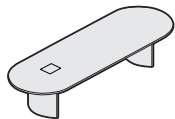
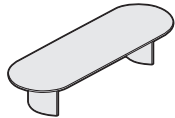

▶ Specification Information, continued from previous page

Specification Information

Style Number	Finish	U.S. Base Prices			
		Flat Wood Edge:	Bullnose Wood Edge:	Beveled Wood Edge:	Horizon Wood Edge:

12'L x 48"W One Piece Top

0 TAP

HS1248C10	Grade 1 Laminate	\$ 6683	\$ 6794	\$ 6946	\$ 8516
	Grade 2 Laminate	\$ 6832	\$ 6943	\$ 7095	\$ 8665
	Grade 1 Veneer	\$ 7591	\$ 7702	\$ 7854	\$ 9424
	Grade 2 Veneer	\$ 8360	\$ 8471	\$ 8623	\$10,193

1 TAP

HS1248C11	Grade 1 Laminate	\$ 7993	\$ 8104	\$ 8256	\$ 9826
	Grade 2 Laminate	\$ 8142	\$ 8243	\$ 8405	\$ 9975
	Grade 1 Veneer	\$ 8901	\$ 9012	\$ 9164	\$10,734
	Grade 2 Veneer	\$ 9670	\$ 9781	\$ 9933	\$11,503

2 TAPS

HS1248C12	Grade 1 Laminate	\$ 9303	\$ 9414	\$ 9566	\$11,136
	Grade 2 Laminate	\$ 9452	\$ 9563	\$ 9715	\$11,285
	Grade 1 Veneer	\$10,211	\$10,322	\$10,474	\$12,044
	Grade 2 Veneer	\$10,980	\$11,091	\$11,243	\$12,813

3 TAPS

HS1248C13	Grade 1 Laminate	\$10,613	\$10,724	\$10,876	\$12,446
	Grade 2 Laminate	\$10,762	\$10,873	\$11,025	\$12,595
	Grade 1 Veneer	\$11,521	\$11,632	\$11,784	\$13,354
	Grade 2 Veneer	\$12,290	\$12,401	\$12,553	\$14,123

▶ Specification Information, continued on next page

For Canadian Pricing
 Multiply U.S. Price by the Canadian price factor.
 ▶ See page 1 for details.

Host Collection Racetrack Tables with Two Bases *continued*

DESIGN F/P DESIGN AND VECTA DESIGN TEAM

Tip: Prices shown include top, TAP(s), and slim bases.
 ▶ See base options for flared bases, page 404

Tip: Last digit of style number indicates number of TAP(s).

Tip: For tech corridor, 12'L tables have four long doors and four short doors.

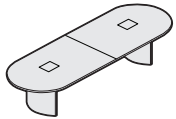
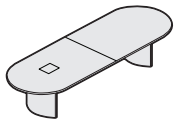
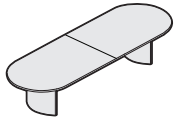

▶ Specification Information, continued from previous page

Specification Information

Style Number	Finish	U.S. Base Prices			
		Flat Wood Edge:	Bullnose Wood Edge:	Beveled Wood Edge:	Horizon Wood Edge:

12'L x 48"W Two Piece Top

0 TAP

HS1248C20	Grade 1 Laminate	\$ 6996	\$ 7107	\$ 7259	\$ 8829
	Grade 2 Laminate	\$ 7145	\$ 7256	\$ 7408	\$ 8978
	Grade 1 Veneer	\$ 7904	\$ 8015	\$ 8167	\$ 9737
	Grade 2 Veneer	\$ 8673	\$ 8784	\$ 8936	\$10,506

1 TAP

HS1248C21	Grade 1 Laminate	\$ 8307	\$ 8418	\$ 8570	\$10,140
	Grade 2 Laminate	\$ 8456	\$ 8567	\$ 8719	\$10,289
	Grade 1 Veneer	\$ 9215	\$ 9326	\$ 9478	\$11,048
	Grade 2 Veneer	\$ 9984	\$10,095	\$10,247	\$11,817

2 TAPS

HS1248C22	Grade 1 Laminate	\$ 9617	\$ 9728	\$ 9880	\$11,450
	Grade 2 Laminate	\$ 9766	\$ 9877	\$10,029	\$11,599
	Grade 1 Veneer	\$10,525	\$10,636	\$10,788	\$12,358
	Grade 2 Veneer	\$11,294	\$11,405	\$11,557	\$13,127

▶ Specification Information, continued on next page



For Canadian Pricing
 Multiply U.S. Price by the Canadian price factor.
 ▶ See page 1 for details.

Host Collection Racetrack Tables with Two Bases

DESIGN F/P DESIGN AND VECTA DESIGN TEAM

Tip: Prices shown include top, TAP(s), and slim bases.
 ▶ See base options for flared bases, page 404



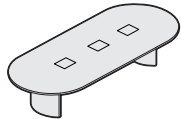
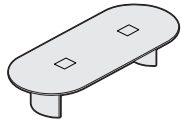
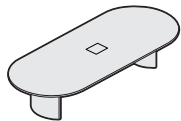
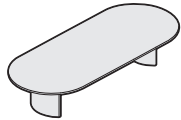

Tip: Last digit of style number indicates number of TAP(s).

Tip: For tech corridor, 12'L tables have four long doors and four short doors.



▶ Specification Information, continued from previous page

Specification Information

Style Number	Finish	U.S. Base Prices			
					
		Flat Wood Edge:	Bullnose Wood Edge:	Beveled Wood Edge:	Horizon Wood Edge:

12'L x 60''W One Piece Top

0 TAP

HS1260C10	Grade 1 Laminate	\$ 6821	\$ 6938	\$ 7101	\$ 8670
	Grade 2 Laminate	\$ 7007	\$ 7124	\$ 7287	\$ 8856
	Grade 1 Veneer	\$ 8175	\$ 8292	\$ 8455	\$10,024
	Grade 2 Veneer	\$ 9142	\$ 9259	\$ 9422	\$10,991

1 TAP

HS1260C11	Grade 1 Laminate	\$ 8130	\$ 8247	\$ 8410	\$ 9979
	Grade 2 Laminate	\$ 8316	\$ 8433	\$ 8596	\$10,165
	Grade 1 Veneer	\$ 9484	\$ 9601	\$ 9764	\$11,333
	Grade 2 Veneer	\$10,451	\$10,568	\$10,731	\$12,300

2 TAPS

HS1260C12	Grade 1 Laminate	\$ 9440	\$ 9557	\$ 9720	\$11,289
	Grade 2 Laminate	\$ 9626	\$ 9743	\$ 9906	\$11,475
	Grade 1 Veneer	\$10,794	\$10,911	\$11,074	\$12,643
	Grade 2 Veneer	\$11,761	\$11,878	\$12,041	\$13,610

3 TAPS

HS1260C13	Grade 1 Laminate	\$10,750	\$10,867	\$11,030	\$12,599
	Grade 2 Laminate	\$10,936	\$11,053	\$11,216	\$12,785
	Grade 1 Veneer	\$12,104	\$12,221	\$12,384	\$13,953
	Grade 2 Veneer	\$13,071	\$13,188	\$13,351	\$14,920

▶ Specification Information, continued on next page



For Canadian Pricing
 Multiply U.S. Price by the Canadian price factor.
 ▶ See page 1 for details.

Host Collection Racetrack Tables with Two Bases *continued*

DESIGN F/P DESIGN AND VECTA DESIGN TEAM

► Specification Information, continued from previous page

Tip: Prices shown include top, TAP(s), and slim bases.
 ► See base options for flared bases, page 404

Tip: Last digit of style number indicates number of TAP(s).

Tip: For tech corridor, 12'L tables have four long doors and four short doors.

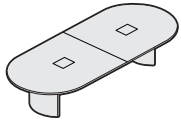
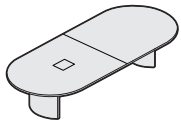
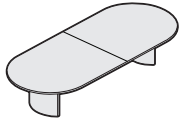

Specification Information

Style Number	Finish	U.S. Base Prices			
		Flat Wood Edge:	Bullnose Wood Edge:	Beveled Wood Edge:	Horizon Wood Edge:

12'L x 60"W Two Piece Top

0 TAP

HS1260C20	Grade 1 Laminate	\$ 7134	\$ 7251	\$ 7414	\$ 8983
	Grade 2 Laminate	\$ 7320	\$ 7437	\$ 7600	\$ 9169
	Grade 1 Veneer	\$ 8488	\$ 8605	\$ 8768	\$10,337
	Grade 2 Veneer	\$ 9455	\$ 9572	\$ 9735	\$11,304

1 TAP

HS1260C21	Grade 1 Laminate	\$ 8444	\$ 8561	\$ 8724	\$10,293
	Grade 2 Laminate	\$ 8630	\$ 8747	\$ 8910	\$10,479
	Grade 1 Veneer	\$ 9798	\$ 9915	\$10,078	\$11,647
	Grade 2 Veneer	\$10,765	\$10,882	\$11,045	\$12,614

2 TAPS

HS1260C22	Grade 1 Laminate	\$ 9754	\$ 9871	\$10,034	\$11,603
	Grade 2 Laminate	\$ 9940	\$10,057	\$10,220	\$11,789
	Grade 1 Veneer	\$11,108	\$11,225	\$11,388	\$12,957
	Grade 2 Veneer	\$12,075	\$12,192	\$12,355	\$13,924



For Canadian Pricing
 Multiply U.S. Price by the Canadian price factor.
 ► See page 1 for details.

Coalesse

Host Collection

Racetrack Tables with Two Bases

DESIGN F/P DESIGN AND VECTA DESIGN TEAM

Host Collection Racetrack Tables with Three Bases

DESIGN F/P DESIGN AND VECTA DESIGN TEAM

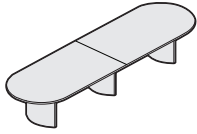

Tip: Shipped knocked down.

Tip: Grain direction for wood-grain laminate runs the length of the table.

Tip: Clips are provided with table. One clip per foot of table length.

Tip: The wood edge on a table top with woodgrain laminate may not match the top.

Tip: You must send a sample of reasonable size for Stain-to-Match.

Tip: 14'L and 16'L tables available with zero, one, two, or four TAP(s). 18'L and 20'L tables available with zero, one, two, four, or six TAP(s).

Tip: In addition to the data and audio/video AAPs available from Coalesse, other styles of AAPs are available through Extron Electronics. For an Extron dealer, call 1.800.633.9876.

Tip: See TAP options for electrical systems and faceplate list.



For Canadian Pricing
Multiply U.S. Price by the Canadian price factor.
▶ See page 1 for details.

Standard Includes		Required to Specify
▶ Need help? Product details, page 322	<ul style="list-style-type: none"> • Top: 1/4" particle board core with laminate • Flat wood edge • TAP(s), if selected: 10"W x 12"L opening(s) trimmed with a flat solid wood profile and with brushed anodized aluminum TAP doors • Tech corridor: four aluminum beams for top support provide tracks for hinged aluminum doors that clip shut: satin anodized finish • Universal clip: black plastic • Three 27"W bases: wood veneer on MDF with aluminum universal bracket, see below • Concealed leveling glides: non-marring, black plastic 	<ol style="list-style-type: none"> 1 Style number 2 Base selection (see below) and wood color number for base 3 Laminate color number for table top, if selected 4 Wood color number for wood edge 5 Door color number for storage tray or TAP door, if selected: <ul style="list-style-type: none"> - 8043 Silver - 8044 Black 6 Options, if selected (see below) ▶ See <i>Surface Materials</i> , page 600.

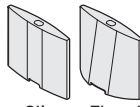
Options	U.S. Price	Required to Specify
Surface Materials <ul style="list-style-type: none"> • Top • Grade 2 laminate • Grade 1 wood veneer • Grade 2 wood veneer • Stain-to-Match 	Prices at right Prices at right Prices at right No cost	Specify with <i>Grade 2 laminate</i> and select color number. Specify with <i>Grade 1 wood veneer</i> and select color number. Specify with <i>Grade 2 wood veneer</i> and select color number. Specify with <i>Stain-to-Match</i> . ▶ Page 5
Edges <ul style="list-style-type: none"> • Wood • Bullnose wood edge • Beveled wood edge • Horizon wood edge 	Prices at right Prices at right Prices at right	Specify with <i>bullnose wood edge</i> . Specify with <i>beveled wood edge</i> . Specify with <i>Horizon wood edge</i> .
Bases  <ul style="list-style-type: none"> • Three slim bases • Two slim and one flared bases • One slim and two flared bases • Three flared bases 	No cost +\$ 693 +\$1386 +\$2079	Specify with <i>three slim bases</i> . Specify with <i>two slim and one flared bases</i> . Specify with <i>one slim and two flared bases</i> . Specify with <i>three flared bases</i> .

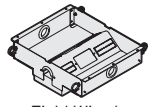
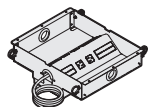
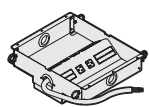
TAP Electrical System with Faceplate Options	U.S. Price	Required to Specify
▶ Page 334  Field Wired	No cost	Specify with <i>power data</i> , and select TAP type and TAP door color number.
 Cord and Plug	No cost	Specify with <i>power data</i> , and select TAP type and TAP door color number.
 Hardwired	No cost	Specify with <i>power data</i> , and select TAP type and TAP door color number.

▶ Options, continued on next page

Host Collection Racetrack Tables with Three Bases

DESIGN F/P DESIGN AND VECTA DESIGN TEAM

►Options, continued from previous page

Tip: For single TAP style numbers, the modular system tray is not available. Specify the hard-wired tray option.

Tip: If the specified table has multiple TAP(s), any one TAP can be replaced with a storage tray.

Tip: Wood veneer doors for storage tray and TAP will always be cross grain.

Tip: Connectrac must be the same wiring schematic as the table.

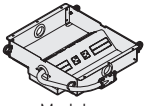
Options	U.S. Price	Required to Specify
TAP Electrical System with Faceplate Options ► Page 334  Modular	<ul style="list-style-type: none"> • Modular System tray (hardwire base power infeed) +\$119 each tray - PAMH Modular System tray with outlets and blank AAPs - PDMH Modular System tray with outlets and two Data AAPs - PVMH Modular System tray with outlets and two of each Video/Audio and Data AAPs 	Specify with <i>modular power data</i> , and select TAP type and TAP door color number.
Storage Tray ► Page 335	<ul style="list-style-type: none"> • Storage tray -\$500 	Specify with <i>storage tray</i> and select door color number.
Doors	<ul style="list-style-type: none"> • Storage tray wood veneer doors +\$250 per door • TAP wood veneer doors +\$250 per door 	Specify with <i>wood doors</i> .
Related Products	<ul style="list-style-type: none"> • Floor kit: Connectrac • Corridor shelf 	► Page 463 ► Page 463

TAP Locations

14'L x 48"W TAP Locations—Two piece top

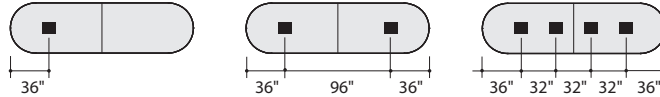

14'L x 48"W TAP Locations—Three piece top

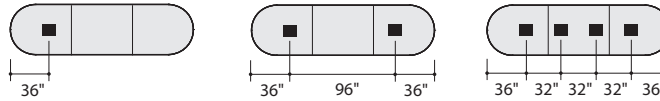

14'L x 60"W TAP Locations—Two piece top

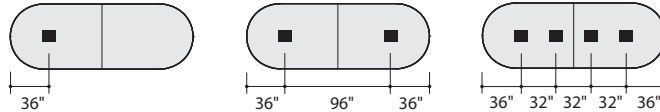

14'L x 60"W TAP Locations—Three piece top

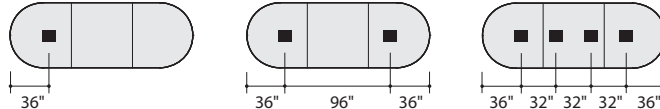

►Options, continued on next page

Host Collection

For Canadian Pricing
 Multiply U.S. Price by the Canadian price factor.
 ► See page 1 for details.

Host Collection Racetrack Tables with Three Bases *continued*

DESIGN F/P DESIGN AND VECTA DESIGN TEAM

► Options, continued from previous page

TAP Locations

16'L x 48"W TAP Locations—Two piece top

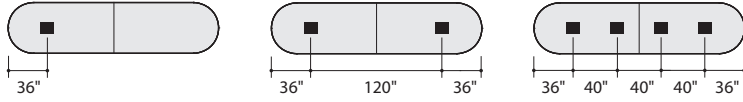

16'L x 48"W TAP Locations—Three piece top

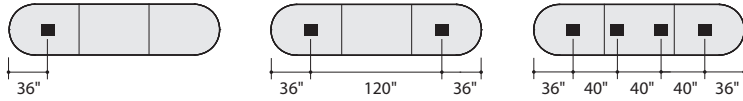

16'L x 60"W TAP Locations—Two piece top

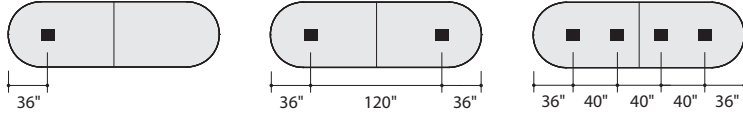

16'L x 60"W TAP Locations—Three piece top

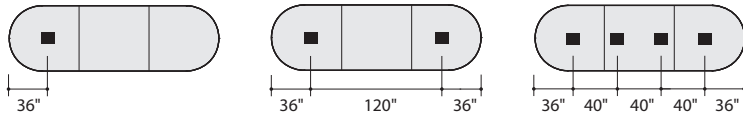

18'L x 48"W TAP Locations—Two piece top

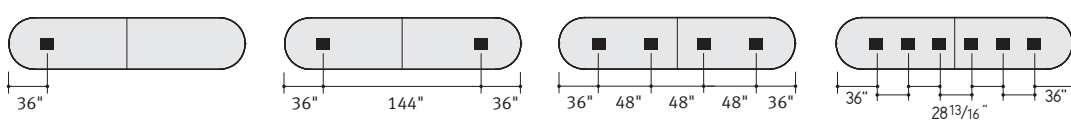

18'L x 48"W TAP Locations—Three piece top

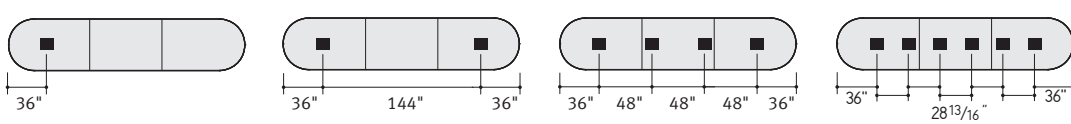

18'L x 60"W TAP Locations—Two piece top

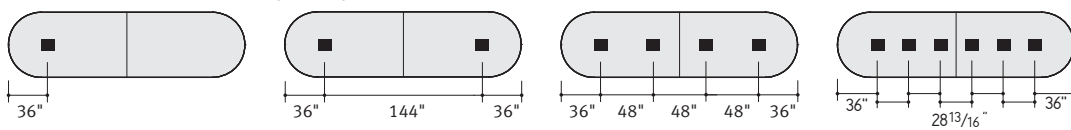

18'L x 60"W TAP Locations—Three piece top

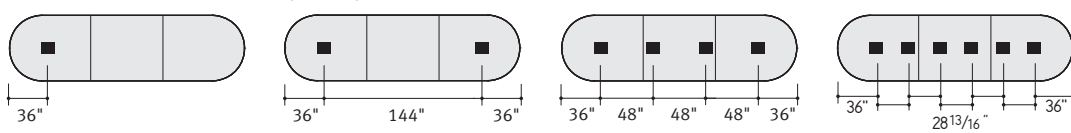

► Options, continued on next page

Host Collection Racetrack Tables with Three Bases

DESIGN F/P DESIGN AND VECTA DESIGN TEAM

► Options, continued from previous page

TAP Locations

20'L x 48"W TAP Locations—Two piece top

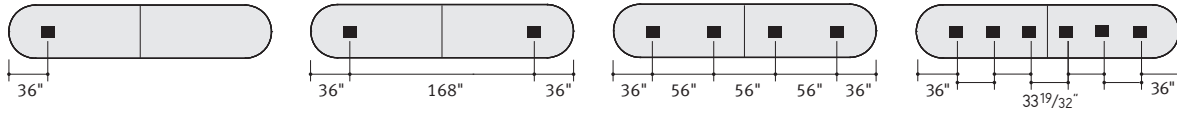

20'L x 48"W TAP Locations—Three piece top

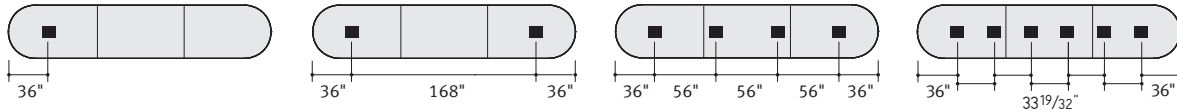

20'L x 60"W TAP Locations—Two piece top

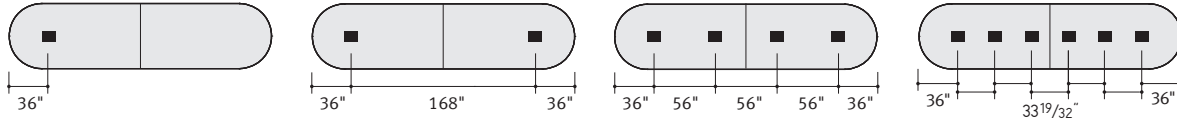

20'L x 60"W TAP Locations—Three piece top

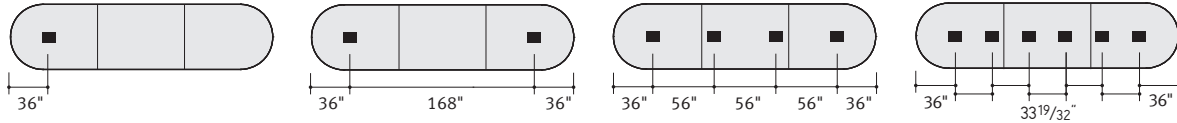

► Specification Information on next page

Host Collection Racetrack Tables with Three Bases *continued*

DESIGN F/P DESIGN AND VECTA DESIGN TEAM

Tip: Prices shown include top, TAP(s), and slim bases.
 ▶ See base options for flared bases, page 416

Tip: Last digit of style number indicates number of TAP(s).

Tip: For tech corridor, 14'L tables have four long doors and four short doors.

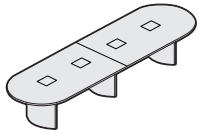
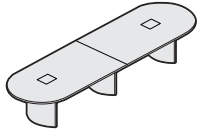
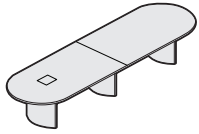
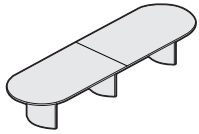

▶ Options, on previous page

Specification Information

Style Number	Finish	U.S. Base Prices			
		Flat Wood Edge:	Bullnose Wood Edge:	Beveled Wood Edge:	Horizon Wood Edge:

14'L x 48''W Two Piece Top

0 TAP

HS1448C20	Grade 1 Laminate	\$ 9053	\$ 9177	\$ 9348	\$10,919
	Grade 2 Laminate	\$ 9227	\$ 9351	\$ 9522	\$11,093
	Grade 1 Veneer	\$10,269	\$10,393	\$10,564	\$12,135
	Grade 2 Veneer	\$11,170	\$11,294	\$11,465	\$13,036

1 TAP

HS1448C21	Grade 1 Laminate	\$10,363	\$10,487	\$10,658	\$12,229
	Grade 2 Laminate	\$10,537	\$10,661	\$10,832	\$12,403
	Grade 1 Veneer	\$11,579	\$11,703	\$11,874	\$13,445
	Grade 2 Veneer	\$12,480	\$12,604	\$12,775	\$14,346

2 TAPS

HS1448C22	Grade 1 Laminate	\$11,673	\$11,797	\$11,968	\$13,539
	Grade 2 Laminate	\$11,847	\$11,971	\$12,142	\$13,713
	Grade 1 Veneer	\$12,889	\$13,013	\$13,184	\$14,755
	Grade 2 Veneer	\$13,790	\$13,914	\$14,085	\$15,656

4 TAPS

HS1448C24	Grade 1 Laminate	\$14,293	\$14,417	\$14,588	\$16,159
	Grade 2 Laminate	\$14,467	\$14,591	\$14,762	\$16,333
	Grade 1 Veneer	\$15,509	\$15,633	\$15,804	\$17,375
	Grade 2 Veneer	\$16,410	\$16,534	\$16,705	\$18,276

▶ Specification Information, continued on next page



For Canadian Pricing
 Multiply U.S. Price by the Canadian price factor.
 ▶ See page 1 for details.

Host Collection Racetrack Tables with Three Bases

DESIGN F/P DESIGN AND VECTA DESIGN TEAM

Tip: Prices shown include top, TAP(s), and slim bases.
 ▶ See base options for flared bases, page 416

Tip: Last digit of style number indicates number of TAP(s).

Tip: For tech corridor, 14'L tables have four long doors and four short doors.

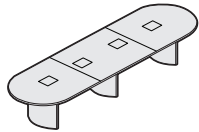
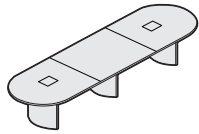
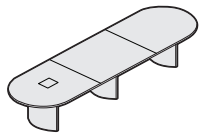
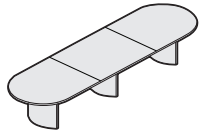

▶ Specification Information, continued from previous page

Specification Information

Style Number	Finish	U.S. Base Prices			
		Flat Wood Edge:	Bullnose Wood Edge:	Beveled Wood Edge:	Horizon Wood Edge:

14'L x 48''W Three Piece Top

0 TAP

HS1448C30	Grade 1 Laminate	\$ 9366	\$ 9490	\$ 9661	\$11,232
	Grade 2 Laminate	\$ 9540	\$ 9664	\$ 9835	\$11,406
	Grade 1 Veneer	\$10,582	\$10,706	\$10,877	\$12,448
	Grade 2 Veneer	\$11,483	\$11,607	\$11,778	\$13,349

1 TAP

HS1448C31	Grade 1 Laminate	\$10,677	\$10,801	\$10,972	\$12,543
	Grade 2 Laminate	\$10,851	\$10,975	\$11,146	\$12,717
	Grade 1 Veneer	\$11,893	\$12,017	\$12,188	\$13,759
	Grade 2 Veneer	\$12,794	\$12,918	\$13,089	\$14,660

2 TAPS

HS1448C32	Grade 1 Laminate	\$11,987	\$12,111	\$12,282	\$13,853
	Grade 2 Laminate	\$12,161	\$12,285	\$12,456	\$14,027
	Grade 1 Veneer	\$13,203	\$13,327	\$13,498	\$15,069
	Grade 2 Veneer	\$14,104	\$14,228	\$14,399	\$15,790

4 TAPS

HS1448C34	Grade 1 Laminate	\$14,293	\$14,417	\$14,588	\$16,159
	Grade 2 Laminate	\$14,467	\$14,591	\$14,762	\$16,333
	Grade 1 Veneer	\$15,509	\$15,633	\$15,804	\$17,375
	Grade 2 Veneer	\$16,410	\$16,534	\$16,705	\$18,276

▶ Specification Information, continued on next page

For Canadian Pricing
 Multiply U.S. Price by the Canadian price factor.
 ▶ See page 1 for details.

Host Collection Racetrack Tables with Three Bases *continued*

DESIGN F/P DESIGN AND VECTA DESIGN TEAM

Tip: Prices shown include top, TAP(s), and slim bases.
 ▶ See base options for flared bases, page 416



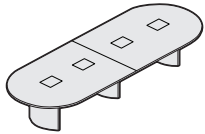
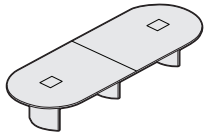
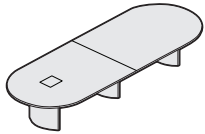
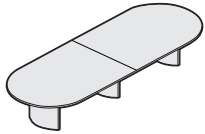

Tip: Last digit of style number indicates number of TAP(s).

Tip: For tech corridor, 14'L tables have four long doors and four short doors.



▶ Specification Information, continued from previous page

Specification Information

Style Number	Finish	U.S. Prices			
					
		Flat Wood Edge:	Bullnose Wood Edge:	Beveled Wood Edge:	Horizon Wood Edge:

14'L x 60"W Two Piece Top

0 TAP

Style Number	Finish	Flat Wood Edge	Bullnose Wood Edge	Beveled Wood Edge	Horizon Wood Edge
HS1460C20	Grade 1 Laminate	\$ 9406	\$ 9536	\$ 9718	\$11,290
	Grade 2 Laminate	\$ 9623	\$ 9753	\$ 9935	\$11,507
	Grade 1 Veneer	\$11,439	\$11,569	\$11,751	\$13,323
	Grade 2 Veneer	\$12,580	\$12,710	\$12,892	\$14,464

1 TAP

Style Number	Finish	Flat Wood Edge	Bullnose Wood Edge	Beveled Wood Edge	Horizon Wood Edge
HS1460C21	Grade 1 Laminate	\$10,715	\$10,845	\$11,027	\$12,599
	Grade 2 Laminate	\$10,932	\$11,062	\$11,244	\$12,816
	Grade 1 Veneer	\$12,748	\$12,878	\$13,060	\$14,632
	Grade 2 Veneer	\$13,889	\$14,019	\$14,201	\$15,773

2 TAPS

Style Number	Finish	Flat Wood Edge	Bullnose Wood Edge	Beveled Wood Edge	Horizon Wood Edge
HS1460C22	Grade 1 Laminate	\$12,025	\$12,155	\$12,337	\$13,909
	Grade 2 Laminate	\$12,242	\$12,372	\$12,554	\$14,126
	Grade 1 Veneer	\$14,058	\$14,188	\$14,370	\$15,942
	Grade 2 Veneer	\$15,199	\$15,329	\$15,511	\$17,083

4 TAPS

Style Number	Finish	Flat Wood Edge	Bullnose Wood Edge	Beveled Wood Edge	Horizon Wood Edge
HS1460C24	Grade 1 Laminate	\$14,645	\$14,775	\$14,957	\$16,529
	Grade 2 Laminate	\$14,862	\$14,992	\$15,174	\$16,746
	Grade 1 Veneer	\$16,678	\$16,808	\$16,990	\$18,562
	Grade 2 Veneer	\$17,819	\$17,949	\$18,131	\$19,703

▶ Specification Information, continued on next page



For Canadian Pricing
 Multiply U.S. Price by the Canadian price factor.
 ▶ See page 1 for details.

Host Collection Racetrack Tables with Three Bases

DESIGN F/P DESIGN AND VECTA DESIGN TEAM

Tip: Prices shown include top, TAP(s), and slim bases.
 ▶ See base options for flared bases, page 416



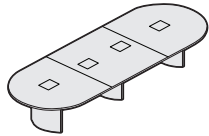
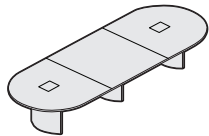
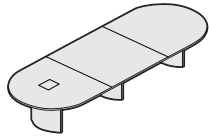
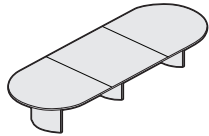

Tip: Last digit of style number indicates number of TAP(s).

Tip: For tech corridor, 14'L tables have four long doors and four short doors.



▶ Specification Information, continued from previous page

Specification Information

Style Number	Finish	U.S. Base Prices			
					
		Flat Wood Edge:	Bullnose Wood Edge:	Beveled Wood Edge:	Horizon Wood Edge:

14'L x 60"W Three Piece Top

0 TAP

HS1460C30	Grade 1 Laminate	\$ 9719	\$ 9849	\$10,031	\$11,603
	Grade 2 Laminate	\$ 9936	\$10,066	\$10,248	\$11,820
	Grade 1 Veneer	\$11,752	\$11,882	\$12,064	\$13,636
	Grade 2 Veneer	\$12,893	\$13,023	\$13,205	\$14,777

1 TAP

HS1460C31	Grade 1 Laminate	\$11,029	\$11,159	\$11,341	\$12,913
	Grade 2 Laminate	\$11,246	\$11,376	\$11,558	\$13,130
	Grade 1 Veneer	\$13,062	\$13,192	\$13,374	\$14,946
	Grade 2 Veneer	\$14,203	\$14,333	\$14,515	\$16,087

2 TAPS

HS1460C32	Grade 1 Laminate	\$12,339	\$12,469	\$12,651	\$14,223
	Grade 2 Laminate	\$12,556	\$12,686	\$12,868	\$14,440
	Grade 1 Veneer	\$14,372	\$14,502	\$14,684	\$16,256
	Grade 2 Veneer	\$15,513	\$15,643	\$15,825	\$17,397

4 TAPS

HS1460C34	Grade 1 Laminate	\$14,959	\$15,089	\$15,271	\$16,843
	Grade 2 Laminate	\$15,176	\$15,306	\$15,488	\$17,060
	Grade 1 Veneer	\$16,992	\$17,122	\$17,304	\$18,876
	Grade 2 Veneer	\$18,133	\$18,263	\$18,445	\$20,017

▶ Specification Information, continued on next page



For Canadian Pricing
 Multiply U.S. Price by the Canadian price factor.
 ▶ See page 1 for details.

Host Collection Racetrack Tables with Three Bases *continued*

DESIGN F/P DESIGN AND VECTA DESIGN TEAM

Tip: Prices shown include top, TAP(s), and slim bases.
 ▶ See base options for flared bases, page 416



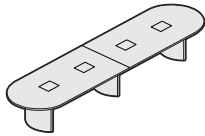
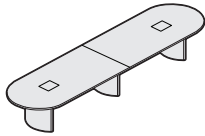
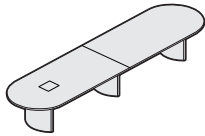
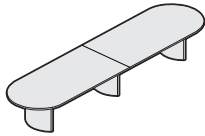

Tip: Last digit of style number indicates number of TAP(s).

Tip: For tech corridor, 16'L tables have eight long doors and four short doors.



▶ Specification Information, continued from previous page

Specification Information

Style Number	Finish	U.S. Base Prices			
					
		Flat Wood Edge:	Bullnose Wood Edge:	Beveled Wood Edge:	Horizon Wood Edge:

16'L x 48''W Two Piece Top

0 TAP

HS1648C20	Grade 1 Laminate	\$ 9467	\$ 9604	\$ 9794	\$11,366
	Grade 2 Laminate	\$ 9665	\$ 9802	\$ 9992	\$11,564
	Grade 1 Veneer	\$10,711	\$10,848	\$11,038	\$12,610
	Grade 2 Veneer	\$11,736	\$11,873	\$12,063	\$13,635

1 TAP

HS1648C21	Grade 1 Laminate	\$10,777	\$10,914	\$11,104	\$12,676
	Grade 2 Laminate	\$10,975	\$11,112	\$11,302	\$12,874
	Grade 1 Veneer	\$12,021	\$12,158	\$12,348	\$13,920
	Grade 2 Veneer	\$13,046	\$13,183	\$13,373	\$14,945

2 TAPS

HS1648C22	Grade 1 Laminate	\$12,087	\$12,224	\$12,414	\$13,986
	Grade 2 Laminate	\$12,285	\$12,422	\$12,612	\$14,184
	Grade 1 Veneer	\$13,331	\$13,468	\$13,658	\$15,230
	Grade 2 Veneer	\$14,356	\$14,493	\$14,683	\$16,255

4 TAPS

HS1648C24	Grade 1 Laminate	\$14,707	\$14,844	\$15,034	\$16,606
	Grade 2 Laminate	\$14,905	\$15,042	\$15,232	\$16,804
	Grade 1 Veneer	\$15,951	\$16,088	\$16,278	\$17,850
	Grade 2 Veneer	\$16,976	\$17,113	\$17,303	\$18,875

▶ Specification Information, continued on next page



For Canadian Pricing
 Multiply U.S. Price by the Canadian price factor.
 ▶ See page 1 for details.

Host Collection Racetrack Tables with Three Bases

DESIGN F/P DESIGN AND VECTA DESIGN TEAM

Tip: Prices shown include top, TAP(s), and slim bases.
 ▶ See base options for flared bases, page 416

Tip: Last digit of style number indicates number of TAP(s).

Tip: For tech corridor, 16'L tables have eight long doors and four short doors.

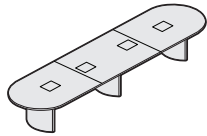
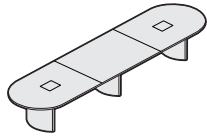
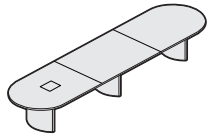
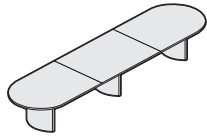

▶ Specification Information, continued from previous page

Specification Information

Style Number	Finish	U.S. Base Prices			
		Flat Wood Edge:	Bullnose Wood Edge:	Beveled Wood Edge:	Horizon Wood Edge:

16'L x 48''W Three Piece Top

0 TAP

Style Number	Finish	Flat Wood Edge	Bullnose Wood Edge	Beveled Wood Edge	Horizon Wood Edge
HS1648C30	Grade 1 Laminate	\$ 9781	\$ 9918	\$10,108	\$11,680
	Grade 2 Laminate	\$ 9979	\$10,116	\$10,306	\$11,878
	Grade 1 Veneer	\$11,025	\$11,162	\$11,352	\$12,924
	Grade 2 Veneer	\$12,050	\$12,187	\$12,377	\$13,949

1 TAP

Style Number	Finish	Flat Wood Edge	Bullnose Wood Edge	Beveled Wood Edge	Horizon Wood Edge
HS1648C31	Grade 1 Laminate	\$11,091	\$11,228	\$11,418	\$12,990
	Grade 2 Laminate	\$11,289	\$11,426	\$11,616	\$13,188
	Grade 1 Veneer	\$12,335	\$12,472	\$12,662	\$14,234
	Grade 2 Veneer	\$13,360	\$13,497	\$13,687	\$15,259

2 TAPS

Style Number	Finish	Flat Wood Edge	Bullnose Wood Edge	Beveled Wood Edge	Horizon Wood Edge
HS1648C32	Grade 1 Laminate	\$12,401	\$12,538	\$12,728	\$14,300
	Grade 2 Laminate	\$12,599	\$12,736	\$12,926	\$14,498
	Grade 1 Veneer	\$13,645	\$13,782	\$13,972	\$15,544
	Grade 2 Veneer	\$14,670	\$14,807	\$14,997	\$16,569

4 TAPS

Style Number	Finish	Flat Wood Edge	Bullnose Wood Edge	Beveled Wood Edge	Horizon Wood Edge
HS1648C34	Grade 1 Laminate	\$15,021	\$15,158	\$15,348	\$16,920
	Grade 2 Laminate	\$15,219	\$15,356	\$15,546	\$17,118
	Grade 1 Veneer	\$16,265	\$16,402	\$16,592	\$18,164
	Grade 2 Veneer	\$17,290	\$17,427	\$17,617	\$19,189

▶ Specification Information, continued on next page



For Canadian Pricing
 Multiply U.S. Price by the Canadian price factor.
 ▶ See page 1 for details.

Host Collection Racetrack Tables with Three Bases *continued*

DESIGN F/P DESIGN AND VECTA DESIGN TEAM

Tip: Prices shown include top, TAP(s), and slim bases.
 ▶ See base options for flared bases, page 416

Tip: Last digit of style number indicates number of TAP(s).

Tip: For tech corridor, 16'L tables have eight long doors and four short doors.

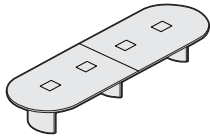
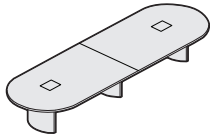
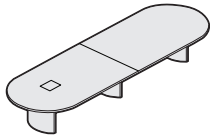
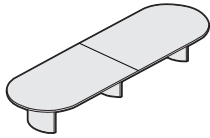

▶ Specification Information, continued from previous page

Specification Information

Style Number	Finish	U.S. Base Prices			
		Flat Wood Edge:	Bullnose Wood Edge:	Beveled Wood Edge:	Horizon Wood Edge:

16'L x 60"W Two Piece Top

0 TAP

HS1660C20	Grade 1 Laminate	\$ 9820	\$ 9964	\$10,163	\$11,739
	Grade 2 Laminate	\$10,068	\$10,212	\$10,411	\$11,987
	Grade 1 Veneer	\$11,879	\$12,023	\$12,222	\$13,798
	Grade 2 Veneer	\$13,177	\$13,321	\$13,520	\$15,096

1 TAP

HS1660C21	Grade 1 Laminate	\$11,129	\$11,273	\$11,472	\$13,048
	Grade 2 Laminate	\$11,377	\$11,521	\$11,720	\$13,296
	Grade 1 Veneer	\$13,188	\$13,332	\$13,531	\$15,107
	Grade 2 Veneer	\$14,486	\$14,630	\$14,829	\$16,405

2 TAPS

HS1660C22	Grade 1 Laminate	\$12,439	\$12,583	\$12,782	\$14,358
	Grade 2 Laminate	\$12,687	\$12,831	\$13,030	\$14,606
	Grade 1 Veneer	\$14,498	\$14,642	\$14,841	\$16,417
	Grade 2 Veneer	\$15,796	\$15,940	\$16,139	\$17,715

4 TAPS

HS1660C24	Grade 1 Laminate	\$15,059	\$15,203	\$15,402	\$16,978
	Grade 2 Laminate	\$15,307	\$15,451	\$15,650	\$17,226
	Grade 1 Veneer	\$17,118	\$17,262	\$17,461	\$19,037
	Grade 2 Veneer	\$18,416	\$18,560	\$18,759	\$20,335

▶ Specification Information, continued on next page



For Canadian Pricing
 Multiply U.S. Price by the Canadian price factor.
 ▶ See page 1 for details.

Host Collection Racetrack Tables with Three Bases

DESIGN F/P DESIGN AND VECTA DESIGN TEAM

Tip: Prices shown include top, TAP(s), and slim bases.
 ▶ See base options for flared bases, page 416

Tip: Last digit of style number indicates number of TAP(s).

Tip: For tech corridor, 16'L tables have eight long doors and four short doors.

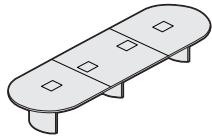
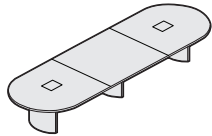
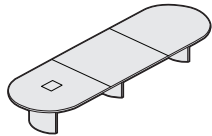
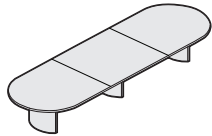

▶ Specification Information, continued from previous page

Specification Information

Style Number	Finish	U.S. Base Prices			
		Flat Wood Edge:	Bullnose Wood Edge:	Beveled Wood Edge:	Horizon Wood Edge:

16'L x 60"W Three Piece Top

0 TAP

HS1660C30	Finish	Flat Wood Edge	Bullnose Wood Edge	Beveled Wood Edge	Horizon Wood Edge
	Grade 1 Laminate	\$10,133	\$10,277	\$10,476	\$12,052
	Grade 2 Laminate	\$10,381	\$10,525	\$10,724	\$12,300
	Grade 1 Veneer	\$12,192	\$12,336	\$12,535	\$14,111
	Grade 2 Veneer	\$13,490	\$13,634	\$13,833	\$15,409

1 TAP

HS1660C31	Finish	Flat Wood Edge	Bullnose Wood Edge	Beveled Wood Edge	Horizon Wood Edge
	Grade 1 Laminate	\$11,443	\$11,587	\$11,786	\$13,362
	Grade 2 Laminate	\$11,691	\$11,835	\$12,034	\$13,610
	Grade 1 Veneer	\$13,502	\$13,646	\$13,845	\$15,421
	Grade 2 Veneer	\$14,800	\$14,944	\$15,143	\$16,719

2 TAPS

HS1660C32	Finish	Flat Wood Edge	Bullnose Wood Edge	Beveled Wood Edge	Horizon Wood Edge
	Grade 1 Laminate	\$12,753	\$12,897	\$13,096	\$14,672
	Grade 2 Laminate	\$13,001	\$13,145	\$13,344	\$14,920
	Grade 1 Veneer	\$14,812	\$14,956	\$15,155	\$16,731
	Grade 2 Veneer	\$16,110	\$16,254	\$16,453	\$18,029

4 TAPS

HS1660C34	Finish	Flat Wood Edge	Bullnose Wood Edge	Beveled Wood Edge	Horizon Wood Edge
	Grade 1 Laminate	\$15,373	\$15,517	\$15,716	\$17,292
	Grade 2 Laminate	\$15,621	\$15,765	\$15,964	\$17,540
	Grade 1 Veneer	\$17,432	\$17,576	\$17,775	\$19,351
	Grade 2 Veneer	\$18,730	\$18,874	\$19,073	\$20,649

▶ Specification Information, continued on next page



For Canadian Pricing
 Multiply U.S. Price by the Canadian price factor.
 ▶ See page 1 for details.

Host Collection Racetrack Tables with Three Bases *continued*

DESIGN F/P DESIGN AND VECTA DESIGN TEAM

Tip: Prices shown include top, TAP(s), and slim bases.
 ▶ See base options for flared bases, page 416

Tip: Last digit of style number indicates number of TAP(s).

Tip: For tech corridor, 18'L tables have eight long doors and four short doors.

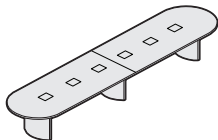
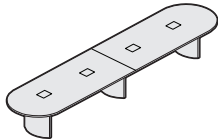
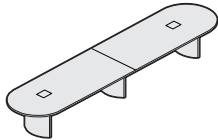
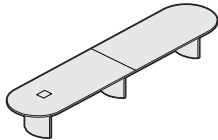
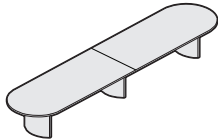

▶ Specification Information, continued from previous page

Specification Information

Style Number	Finish	U.S. Base Prices			
		Flat Wood Edge:	Bullnose Wood Edge:	Beveled Wood Edge:	Horizon Wood Edge:

18'L x 48"W Two Piece Top

0 TAP

HS1848C20	Grade 1 Laminate	\$10,092	\$10,243	\$10,451	\$12,044
	Grade 2 Laminate	\$10,315	\$10,466	\$10,674	\$12,267
	Grade 1 Veneer	\$11,630	\$11,781	\$11,989	\$13,582
	Grade 2 Veneer	\$12,789	\$12,940	\$13,148	\$14,741

1 TAP

HS1848C21	Grade 1 Laminate	\$11,401	\$11,552	\$11,760	\$13,353
	Grade 2 Laminate	\$11,624	\$11,775	\$11,983	\$13,576
	Grade 1 Veneer	\$12,939	\$13,090	\$13,298	\$14,891
	Grade 2 Veneer	\$14,098	\$14,249	\$14,457	\$16,050

2 TAPS

HS1848C22	Grade 1 Laminate	\$12,711	\$12,862	\$13,070	\$14,663
	Grade 2 Laminate	\$12,934	\$13,085	\$13,293	\$14,886
	Grade 1 Veneer	\$14,249	\$14,400	\$14,608	\$16,201
	Grade 2 Veneer	\$15,408	\$15,559	\$15,767	\$17,360

4 TAPS

HS1848C24	Grade 1 Laminate	\$15,331	\$15,482	\$15,690	\$17,283
	Grade 2 Laminate	\$15,554	\$15,705	\$15,913	\$17,506
	Grade 1 Veneer	\$16,869	\$17,020	\$17,228	\$18,821
	Grade 2 Veneer	\$18,028	\$18,179	\$18,387	\$19,980

6 TAPS

HS1848C26	Grade 1 Laminate	\$17,951	\$18,102	\$18,310	\$19,903
	Grade 2 Laminate	\$18,174	\$18,325	\$18,533	\$20,126
	Grade 1 Veneer	\$19,489	\$19,640	\$19,848	\$21,441
	Grade 2 Veneer	\$20,648	\$20,799	\$21,007	\$22,600

▶ Specification Information, continued on next page



For Canadian Pricing
 Multiply U.S. Price by the Canadian price factor.
 ▶ See page 1 for details.

Host Collection Racetrack Tables with Three Bases

DESIGN F/P DESIGN AND VECTA DESIGN TEAM

Tip: Prices shown include top, TAP(s), and slim bases.
 ▶ See base options for flared bases, page 416

Tip: Last digit of style number indicates number of TAP(s).

Tip: For tech corridor, 18'L tables have eight long doors and four short doors.

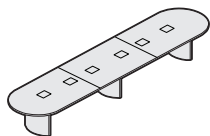
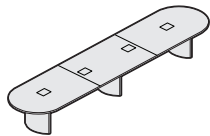
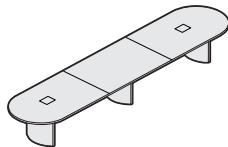
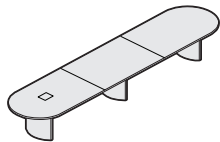
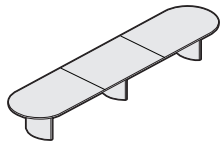

▶ Specification Information, continued from previous page

Specification Information

Style Number	Finish	U.S. Base Prices			
		Flat Wood Edge:	Bullnose Wood Edge:	Beveled Wood Edge:	Horizon Wood Edge:

18'L x 48"W Three Piece Top

0 TAP					
HS1848C30	Grade 1 Laminate	\$10,405	\$10,556	\$10,764	\$12,357
	Grade 2 Laminate	\$10,628	\$10,779	\$10,987	\$12,580
	Grade 1 Veneer	\$11,943	\$12,094	\$12,302	\$13,895
	Grade 2 Veneer	\$13,102	\$13,253	\$13,461	\$15,054
1 TAP					
HS1848C31	Grade 1 Laminate	\$11,715	\$11,866	\$12,074	\$13,667
	Grade 2 Laminate	\$11,938	\$12,089	\$12,297	\$13,890
	Grade 1 Veneer	\$13,253	\$13,404	\$13,612	\$15,205
	Grade 2 Veneer	\$14,412	\$14,563	\$14,771	\$16,364
2 TAPS					
HS1848C32	Grade 1 Laminate	\$13,025	\$13,176	\$13,384	\$14,977
	Grade 2 Laminate	\$13,248	\$13,399	\$13,607	\$15,200
	Grade 1 Veneer	\$14,563	\$14,714	\$14,922	\$16,515
	Grade 2 Veneer	\$15,722	\$15,873	\$16,081	\$17,674
4 TAPS					
HS1848C34	Grade 1 Laminate	\$15,645	\$15,796	\$16,004	\$17,597
	Grade 2 Laminate	\$15,868	\$16,019	\$16,227	\$17,820
	Grade 1 Veneer	\$17,183	\$17,334	\$17,542	\$19,135
	Grade 2 Veneer	\$18,342	\$18,493	\$18,701	\$20,294
6 TAPS					
HS1848C36	Grade 1 Laminate	\$18,265	\$18,416	\$18,624	\$20,217
	Grade 2 Laminate	\$18,488	\$18,639	\$18,847	\$20,440
	Grade 1 Veneer	\$19,803	\$19,954	\$20,162	\$21,755
	Grade 2 Veneer	\$20,962	\$21,113	\$21,321	\$22,914

▶ Specification Information, continued on next page



For Canadian Pricing
 Multiply U.S. Price by the Canadian price factor.
 ▶ See page 1 for details.

Host Collection Racetrack Tables with Three Bases *continued*

DESIGN F/P DESIGN AND VECTA DESIGN TEAM

Tip: Prices shown include top, TAP(s), and slim bases.
 ▶ See base options for flared bases, page 416

Tip: Last digit of style number indicates number of TAP(s).

Tip: For tech corridor, 18'L tables have eight long doors and four short doors.

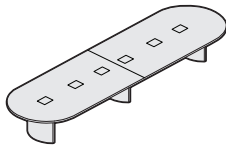
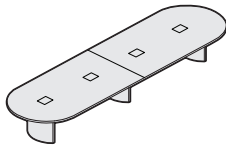
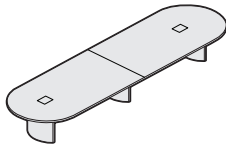
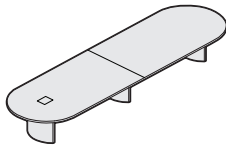
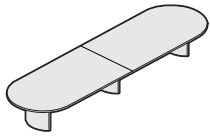

▶ Specification Information, continued from previous page

Specification Information

Style Number	Finish	U.S. Base Prices			
		Flat Wood Edge:	Bullnose Wood Edge:	Beveled Wood Edge:	Horizon Wood Edge:

18'L x 60"W Two Piece Top

0 TAP

HS1860C20	Grade 1 Laminate	\$10,264	\$10,421	\$10,639	\$12,231
	Grade 2 Laminate	\$10,543	\$10,700	\$10,918	\$12,510
	Grade 1 Veneer	\$12,951	\$13,108	\$13,326	\$14,918
	Grade 2 Veneer	\$14,421	\$14,578	\$14,796	\$16,388

1 TAP

HS1860C21	Grade 1 Laminate	\$11,573	\$11,730	\$11,948	\$13,540
	Grade 2 Laminate	\$11,852	\$12,009	\$12,227	\$13,819
	Grade 1 Veneer	\$14,260	\$14,417	\$14,635	\$16,227
	Grade 2 Veneer	\$15,730	\$15,887	\$16,105	\$17,697

2 TAPS

HS1860C22	Grade 1 Laminate	\$12,883	\$13,040	\$13,258	\$14,850
	Grade 2 Laminate	\$13,162	\$13,319	\$13,537	\$15,129
	Grade 1 Veneer	\$15,570	\$15,727	\$15,945	\$17,537
	Grade 2 Veneer	\$17,040	\$17,197	\$17,415	\$19,007

4 TAPS

HS1860C24	Grade 1 Laminate	\$15,503	\$15,660	\$15,878	\$17,470
	Grade 2 Laminate	\$15,782	\$15,939	\$16,157	\$17,749
	Grade 1 Veneer	\$18,190	\$18,347	\$18,565	\$20,157
	Grade 2 Veneer	\$19,660	\$19,817	\$20,035	\$21,627

6 TAPS

HS1860C26	Grade 1 Laminate	\$18,123	\$18,280	\$18,498	\$20,090
	Grade 2 Laminate	\$18,402	\$18,559	\$18,777	\$20,369
	Grade 1 Veneer	\$20,810	\$20,967	\$21,185	\$22,777
	Grade 2 Veneer	\$22,280	\$22,437	\$22,655	\$24,247

▶ Specification Information, continued on next page



For Canadian Pricing
 Multiply U.S. Price by the Canadian price factor.
 ▶ See page 1 for details.

Host Collection Racetrack Tables with Three Bases

DESIGN F/P DESIGN AND VECTA DESIGN TEAM

Tip: Prices shown include top, TAP(s), and slim bases.
 ▶ See base options for flared bases, page 416

Tip: Last digit of style number indicates number of TAP(s).

Tip: For tech corridor, 18'L tables have eight long doors and four short doors.

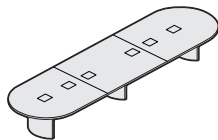
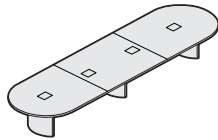
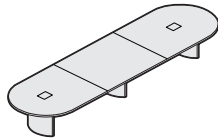
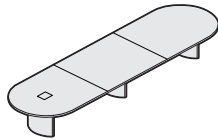
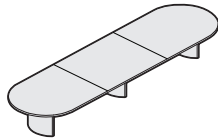

▶ Specification Information, continued from previous page

Specification Information

Style Number	Finish	U.S. Base Prices			
		Flat Wood Edge:	Bullnose Wood Edge:	Beveled Wood Edge:	Horizon Wood Edge:

18'L x 60"W Three Piece Top

0 TAP					
HS1860C30	Grade 1 Laminate	\$10,577	\$10,734	\$10,952	\$12,544
	Grade 2 Laminate	\$10,856	\$11,013	\$11,231	\$12,823
	Grade 1 Veneer	\$13,264	\$13,421	\$13,639	\$15,231
	Grade 2 Veneer	\$14,734	\$14,891	\$15,109	\$16,701
1 TAP					
HS1860C31	Grade 1 Laminate	\$11,887	\$12,044	\$12,262	\$13,854
	Grade 2 Laminate	\$12,166	\$12,323	\$12,541	\$14,133
	Grade 1 Veneer	\$14,574	\$14,731	\$14,949	\$16,541
	Grade 2 Veneer	\$16,044	\$16,201	\$16,419	\$18,011
2 TAPS					
HS1860C32	Grade 1 Laminate	\$13,197	\$13,354	\$13,572	\$15,164
	Grade 2 Laminate	\$13,476	\$13,633	\$13,851	\$15,443
	Grade 1 Veneer	\$15,884	\$16,041	\$16,259	\$17,851
	Grade 2 Veneer	\$17,354	\$17,511	\$17,729	\$19,321
4 TAPS					
HS1860C34	Grade 1 Laminate	\$15,817	\$15,974	\$16,192	\$17,784
	Grade 2 Laminate	\$16,096	\$16,253	\$16,471	\$18,063
	Grade 1 Veneer	\$18,504	\$18,661	\$18,879	\$20,471
	Grade 2 Veneer	\$19,974	\$20,131	\$20,349	\$21,941
6 TAPS					
HS1860C36	Grade 1 Laminate	\$18,437	\$18,594	\$18,812	\$20,404
	Grade 2 Laminate	\$18,716	\$18,873	\$19,091	\$20,683
	Grade 1 Veneer	\$21,124	\$21,281	\$21,499	\$23,091
	Grade 2 Veneer	\$22,594	\$22,751	\$22,969	\$24,561

▶ Specification Information, continued on next page

Host Collection

For Canadian Pricing
 Multiply U.S. Price by the Canadian price factor.
 ▶ See page 1 for details.

Host Collection Racetrack Tables with Three Bases *continued*

DESIGN F/P DESIGN AND VECTA DESIGN TEAM

Tip: Prices shown include top, TAP(s), and slim bases.
 ▶ See base options for flared bases, page 416

Tip: Last digit of style number indicates number of TAP(s).

Tip: For tech corridor, 20'L tables have eight long doors and four short doors.

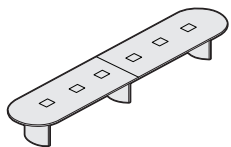
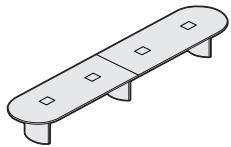
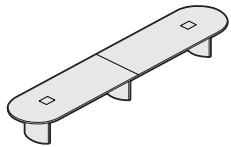
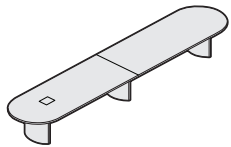
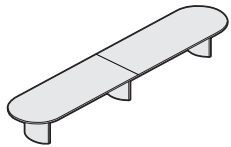

► Specification Information, continued from previous page

Specification Information

Style Number	Finish	U.S. Base Prices			
		Flat Wood Edge:	Bullnose Wood Edge:	Beveled Wood Edge:	Horizon Wood Edge:

20'L x 48''W Two Piece Top

0 TAP					
HS2048C20	Grade 1 Laminate	\$10,507	\$10,671	\$10,898	\$12,492
	Grade 2 Laminate	\$10,755	\$10,919	\$11,146	\$12,740
	Grade 1 Veneer	\$12,073	\$12,237	\$12,464	\$14,058
	Grade 2 Veneer	\$13,356	\$13,520	\$13,747	\$15,341
1 TAP					
HS2048C21	Grade 1 Laminate	\$11,816	\$11,980	\$12,207	\$13,801
	Grade 2 Laminate	\$12,064	\$12,228	\$12,455	\$14,049
	Grade 1 Veneer	\$13,382	\$13,546	\$13,773	\$15,367
	Grade 2 Veneer	\$14,665	\$14,829	\$15,056	\$16,650
2 TAPS					
HS2048C22	Grade 1 Laminate	\$13,126	\$13,290	\$13,517	\$15,111
	Grade 2 Laminate	\$13,374	\$13,538	\$13,765	\$15,359
	Grade 1 Veneer	\$14,692	\$14,856	\$15,083	\$16,677
	Grade 2 Veneer	\$15,975	\$16,139	\$16,366	\$17,960
4 TAPS					
HS2048C24	Grade 1 Laminate	\$15,746	\$15,910	\$16,137	\$17,731
	Grade 2 Laminate	\$15,994	\$16,158	\$16,385	\$17,979
	Grade 1 Veneer	\$17,312	\$17,476	\$17,703	\$19,297
	Grade 2 Veneer	\$18,595	\$18,759	\$18,986	\$20,580
6 TAPS					
HS2048C26	Grade 1 Laminate	\$18,366	\$18,530	\$18,757	\$20,351
	Grade 2 Laminate	\$18,614	\$18,778	\$19,005	\$20,599
	Grade 1 Veneer	\$19,932	\$20,096	\$20,323	\$21,917
	Grade 2 Veneer	\$21,215	\$21,379	\$21,606	\$23,200

► Specification Information, continued on next page



For Canadian Pricing
 Multiply U.S. Price by the Canadian price factor.
 ▶ See page 1 for details.

Host Collection Racetrack Tables with Three Bases

DESIGN F/P DESIGN AND VECTA DESIGN TEAM

Tip: Prices shown include top, TAP(s), and slim bases.
 ▶ See base options for flared bases, page 416

Tip: Last digit of style number indicates number of TAP(s).

Tip: For tech corridor, 20'L tables have eight long doors and four short doors.

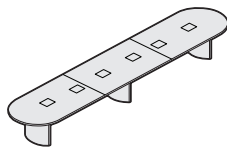
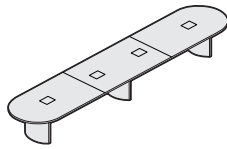
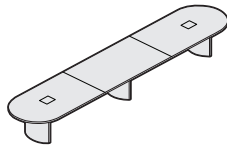
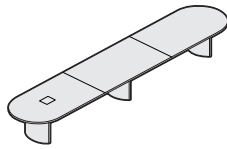
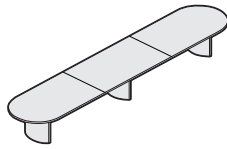

▶ Specification Information, continued from previous page

Specification Information

Style Number	Finish	U.S. Base Prices			
		Flat Wood Edge:	Bullnose Wood Edge:	Beveled Wood Edge:	Horizon Wood Edge:

20'L x 48''W Three Piece Top

0 TAP

HS2048C30	Grade 1 Laminate	\$10,820	\$10,984	\$11,211	\$12,805
	Grade 2 Laminate	\$11,068	\$11,232	\$11,459	\$13,053
	Grade 1 Veneer	\$12,386	\$12,550	\$12,777	\$14,371
	Grade 2 Veneer	\$13,669	\$13,833	\$14,060	\$15,654

1 TAP

HS2048C31	Grade 1 Laminate	\$12,130	\$12,294	\$12,521	\$14,115
	Grade 2 Laminate	\$12,378	\$12,542	\$12,769	\$14,363
	Grade 1 Veneer	\$13,696	\$13,860	\$14,087	\$15,681
	Grade 2 Veneer	\$14,979	\$15,143	\$15,370	\$16,964

2 TAPS

HS2048C32	Grade 1 Laminate	\$13,440	\$13,604	\$13,831	\$15,425
	Grade 2 Laminate	\$13,688	\$13,852	\$14,079	\$15,673
	Grade 1 Veneer	\$15,006	\$15,170	\$15,397	\$16,991
	Grade 2 Veneer	\$16,289	\$16,453	\$16,680	\$18,274

4 TAPS

HS2048C34	Grade 1 Laminate	\$16,060	\$16,224	\$16,451	\$18,045
	Grade 2 Laminate	\$16,308	\$16,472	\$16,699	\$18,293
	Grade 1 Veneer	\$17,626	\$17,790	\$18,017	\$19,611
	Grade 2 Veneer	\$18,909	\$19,073	\$19,300	\$20,894

6 TAPS

HS2048C36	Grade 1 Laminate	\$18,680	\$18,844	\$19,071	\$20,665
	Grade 2 Laminate	\$18,928	\$19,092	\$19,319	\$20,913
	Grade 1 Veneer	\$20,246	\$20,410	\$20,637	\$22,231
	Grade 2 Veneer	\$21,529	\$21,693	\$21,920	\$23,514

▶ Specification Information, continued on next page



For Canadian Pricing
 Multiply U.S. Price by the Canadian price factor.
 ▶ See page 1 for details.

Host Collection Racetrack Tables with Three Bases *continued*

DESIGN F/P DESIGN AND VECTA DESIGN TEAM

Tip: Prices shown include top, TAP(s), and slim bases.
 ▶ See base options for flared bases, page 416



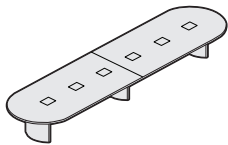
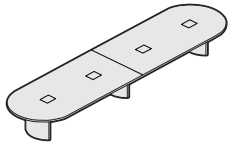
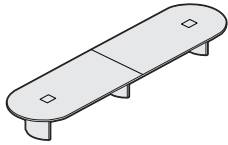
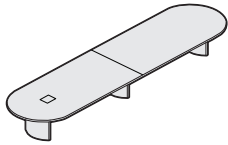
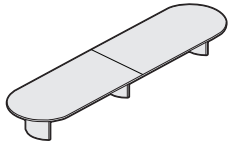

Tip: Last digit of style number indicates number of TAP(s).

Tip: For tech corridor, 20'L tables have eight long doors and four short doors.



▶ Specification Information, continued from previous page

Specification Information

Style Number	Finish	U.S. Base Prices			
		 Flat Wood Edge:	 Bullnose Wood Edge:	 Beveled Wood Edge:	 Horizon Wood Edge:

20'L x 60''W Two Piece Top

0 TAP

HS2060C20	Grade 1 Laminate	\$10,679	\$10,849	\$11,086	\$12,676
	Grade 2 Laminate	\$10,989	\$11,159	\$11,396	\$12,986
	Grade 1 Veneer	\$13,394	\$13,564	\$13,801	\$15,391
	Grade 2 Veneer	\$15,019	\$15,189	\$15,426	\$17,016

1 TAP

HS2060C21	Grade 1 Laminate	\$11,988	\$12,158	\$12,395	\$13,985
	Grade 2 Laminate	\$12,298	\$12,468	\$12,705	\$14,295
	Grade 1 Veneer	\$14,703	\$14,873	\$15,110	\$16,700
	Grade 2 Veneer	\$16,328	\$16,498	\$16,735	\$18,325

2 TAPS

HS2060C22	Grade 1 Laminate	\$13,298	\$13,468	\$13,705	\$15,295
	Grade 2 Laminate	\$13,608	\$13,778	\$14,015	\$15,605
	Grade 1 Veneer	\$16,013	\$16,183	\$16,420	\$18,010
	Grade 2 Veneer	\$17,638	\$17,808	\$18,045	\$19,635

4 TAPS

HS2060C24	Grade 1 Laminate	\$15,918	\$16,088	\$16,325	\$17,915
	Grade 2 Laminate	\$16,228	\$16,398	\$16,635	\$18,225
	Grade 1 Veneer	\$18,633	\$18,803	\$19,040	\$20,630
	Grade 2 Veneer	\$20,258	\$20,428	\$20,665	\$22,255

6 TAPS

HS2060C26	Grade 1 Laminate	\$18,538	\$18,708	\$18,945	\$20,535
	Grade 2 Laminate	\$18,848	\$19,018	\$19,255	\$20,845
	Grade 1 Veneer	\$21,253	\$21,423	\$21,660	\$23,250
	Grade 2 Veneer	\$22,878	\$23,048	\$23,285	\$24,875

▶ Specification Information, continued on next page



For Canadian Pricing
 Multiply U.S. Price by the Canadian price factor.
 ▶ See page 1 for details.

Host Collection Racetrack Tables with Three Bases

DESIGN F/P DESIGN AND VECTA DESIGN TEAM

Tip: Prices shown include top, TAP(s), and slim bases.
 ▶ See base options for flared bases, page 416



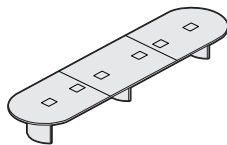
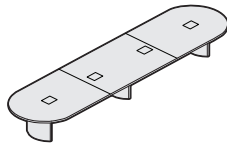
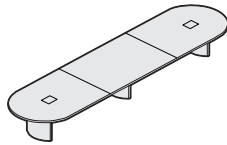
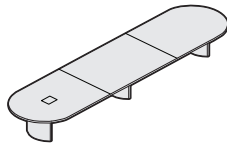
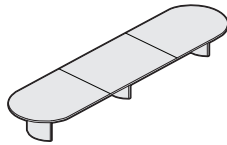

Tip: Last digit of style number indicates number of TAP(s).

Tip: For tech corridor, 20'L tables have eight long doors and four short doors.



► Specification Information, continued from previous page

Specification Information

Style Number	Finish	U.S. Base Prices			
					
		Flat Wood Edge:	Bullnose Wood Edge:	Beveled Wood Edge:	Horizon Wood Edge:

20'L x 60''W Three Piece Top

0 TAP

HS2060C30	Grade 1 Laminate	\$10,992	\$11,162	\$11,399	\$12,989
	Grade 2 Laminate	\$11,302	\$11,472	\$11,709	\$13,299
	Grade 1 Veneer	\$13,707	\$13,877	\$14,114	\$15,704
	Grade 2 Veneer	\$15,332	\$15,502	\$15,739	\$17,329

1 TAP

HS2060C31	Grade 1 Laminate	\$12,302	\$12,472	\$12,709	\$14,299
	Grade 2 Laminate	\$12,612	\$12,782	\$13,019	\$14,609
	Grade 1 Veneer	\$15,017	\$15,187	\$15,424	\$17,014
	Grade 2 Veneer	\$16,642	\$16,812	\$17,049	\$18,639

2 TAPS

HS2060C32	Grade 1 Laminate	\$13,612	\$13,782	\$14,019	\$15,609
	Grade 2 Laminate	\$13,922	\$14,092	\$14,329	\$15,919
	Grade 1 Veneer	\$16,327	\$16,497	\$16,734	\$18,324
	Grade 2 Veneer	\$17,952	\$18,122	\$18,359	\$19,949

4 TAPS

HS2060C34	Grade 1 Laminate	\$16,232	\$16,402	\$16,639	\$18,229
	Grade 2 Laminate	\$16,542	\$16,712	\$16,949	\$18,539
	Grade 1 Veneer	\$18,947	\$19,117	\$19,354	\$20,944
	Grade 2 Veneer	\$20,572	\$20,742	\$20,979	\$22,569

6 TAPS

HS2060C36	Grade 1 Laminate	\$18,852	\$19,022	\$19,259	\$20,849
	Grade 2 Laminate	\$19,162	\$19,332	\$19,569	\$21,159
	Grade 1 Veneer	\$21,567	\$21,737	\$21,974	\$23,564
	Grade 2 Veneer	\$23,192	\$23,362	\$23,599	\$25,189

For Canadian Pricing
 Multiply U.S. Price by the Canadian price factor.
 ▶ See page 1 for details.

Host Collection Boat Shaped Tables with Two Bases

DESIGN F/P DESIGN AND VECTA DESIGN TEAM

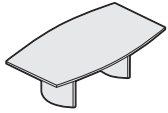

Tip: Shipped knocked down.

Tip: Grain direction for wood-grain laminate runs the length of the table.

Tip: Clips are provided with table: One clip per foot of table length.

Tip: The wood edge on a table top with woodgrain laminate may not match the top.

Tip: You must send a sample of reasonable size for Stain-to-Match.

Tip: 96"L tables available with zero, one, or two TAP(s). 10'L and 12'L tables available with zero, one, two, or three TAP(s).

Tip: Last digit of style number indicates number of TAP(s).

Tip: In addition to the data and audio/video AAPs available from Coalesse, other styles of AAPs are available through Extron Electronics. For an Extron dealer, call 1-800-633-9876.

Tip: See TAP options for electrical systems and faceplate list.

Standard Includes		Required to Specify	
<ul style="list-style-type: none"> ▶ Need help? Product details, page 322 	<ul style="list-style-type: none"> • Top: 1/4" particle board core with laminate • Flat wood edge • TAP(s), if selected: 10"W x 12"L opening(s) trimmed with a flat solid wood profile and with brushed anodized aluminum TAP doors • Tech corridor: two aluminum beams for top support provide tracks for hinged aluminum doors that clip shut: satin anodized finish • Universal clip: black plastic • Two 27"W bases: wood veneer on MDF with aluminum universal bracket • Concealed leveling glides: non-marring, black plastic 	<ol style="list-style-type: none"> 1 Style number 2 Base section (see below) and wood color number for base 3 Laminate color number for table top, if selected 4 Wood color number for wood edge 5 Door color number for storage tray or TAP door, if selected: <ul style="list-style-type: none"> - 8043 Silver - 8044 Black 6 Options, if selected (see below) 	<ul style="list-style-type: none"> ▶ See <i>Surface Materials</i>, page 600.
Options		U.S. Price	Required to Specify
Surface Materials	Top <ul style="list-style-type: none"> • Grade 2 laminate • Grade 1 wood veneer • Grade 2 wood veneer • Stain-to-Match 	<ul style="list-style-type: none"> Prices at right Prices at right Prices at right No cost 	<ul style="list-style-type: none"> Specify with <i>Grade 2 laminate</i> and select color number. Specify with <i>Grade 1 wood veneer</i> and select color number. Specify with <i>Grade 2 wood veneer</i> and select color number. Specify with <i>Stain-to-Match</i>.
Edges	Wood <ul style="list-style-type: none"> • Bullnose wood edge 	<ul style="list-style-type: none"> Prices at right 	<ul style="list-style-type: none"> Specify with <i>bullnose wood edge</i>.
Bases	<ul style="list-style-type: none"> • Two slim bases • One slim and one flared base • Two flared bases 	<ul style="list-style-type: none"> No cost +\$ 693 +\$1386 	<ul style="list-style-type: none"> Specify with <i>two slim bases</i>. Specify with <i>one slim base and one flared base</i>. Specify with <i>two flared bases</i>.
TAP Electrical System with Faceplate Options <p>▶ Page 334</p> <p>Field Wired</p> <p>Cord and Plug</p> <p>Hardwired</p>	<ul style="list-style-type: none"> • Field-Wired tray (no electrical) <ul style="list-style-type: none"> - PAFW Field-Wired tray (no electrical) with blank AAPs - PDFW Field-Wired tray (no electrical) with two Data AAPs - PVFW Field-Wired tray (no electrical) with two of each Video/Audio and Data AAPs • Cord and Plug tray (10' cord) <ul style="list-style-type: none"> - PACP Cord and Plug tray with outlets and blank AAPs - PDCP Cord and Plug tray with outlets and two Data AAPs - PAVC Cord and Plug tray with outlets and two of each Video/Audio and Data AAPs • Hard-Wired tray (6' conduit) <ul style="list-style-type: none"> - PAHW Hard-Wired tray with outlets and blank AAPs - PDHW Hard-Wired tray with outlets and two Data AAPs - PAVH Hard-Wired tray with outlets and two of each Video/Audio and Data AAPs 	<ul style="list-style-type: none"> No cost No cost No cost 	<ul style="list-style-type: none"> Specify with <i>power data</i>, and select TAP type and TAP door color number. Specify with <i>power data</i>, and select TAP type and TAP door color number. Specify with <i>power data</i>, and select TAP type and TAP door color number.

▶ Options, continued on next page



For Canadian Pricing
 Multiply U.S. Price by the Canadian price factor.
 ▶ See page 1 for details.

Host Collection Boat Shaped Tables with Two Bases

DESIGN F/P DESIGN AND VECTA DESIGN TEAM

► Options, continued from previous page

Tip: For single TAP style numbers, the modular system tray is not available. Specify the hard-wired tray option.

Tip: If the specified table has multiple TAP(s), any one TAP can be replaced with a storage tray.

Tip: Wood veneer doors for storage tray and TAP(s) will always be cross grain.

Tip: Connectrac must be the same wiring schematic as the table.

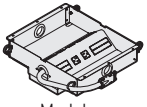
Options	U.S. Price	Required to Specify
TAP Electrical System with Faceplate Options ► Page 334  Modular	<ul style="list-style-type: none"> • Modular System tray (hardwire base power infeed) +\$119 each tray - PAMH Modular System tray with outlets and blank AAPs - PDMH Modular System tray with outlets and two Data AAPs - PVMH Modular System tray with outlets and two of each Video/Audio and Data AAPs 	Specify with <i>modular power data</i> , and select TAP type and TAP door color number.
Storage Tray ► Page 335	<ul style="list-style-type: none"> • Storage tray -\$500 	Specify with <i>storage tray</i> and select door color number.
Doors	<ul style="list-style-type: none"> • Storage tray wood veneer doors +\$250 per door • TAP wood veneer doors +\$250 per door 	Specify with <i>wood doors</i> .
Related Products	<ul style="list-style-type: none"> • Floor kit: Connectrac • Corridor shelf 	► Page 463 ► Page 463

TAP Locations

96"L, 54"W Center, 42"W End TAP Locations—One piece top

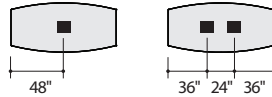

10'L, 60"W Center, 48"W End TAP Locations—One piece top

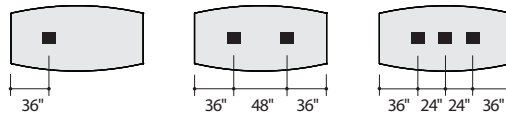

10'L, 60"W Center, 48"W End TAP Locations—Two piece top

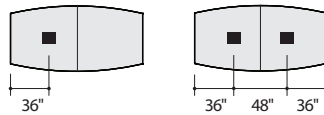

12'L, 60"W Center, 48"W End TAP Locations—One piece top

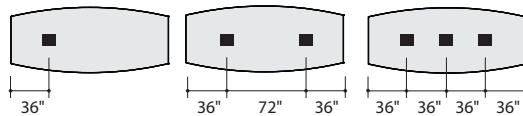

12'L, 60"W Center, 48"W Ends TAP Locations—Two piece top

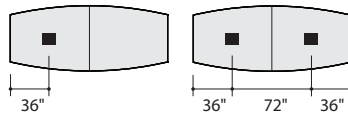

► Specification Information, on next page

Host Collection



For Canadian Pricing
 Multiply U.S. Price by the Canadian price factor.
 ► See page 1 for details.

Host Collection Boat Shaped Tables with Two Bases *continued*

DESIGN F/P DESIGN AND VECTA DESIGN TEAM

Tip: Prices shown include top, TAP(s), and slim bases.
 ▶ See base options for flared bases, page 436

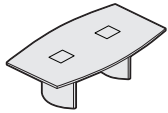
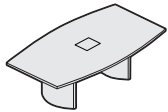
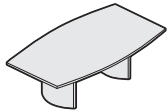

Tip: Last digit of style number indicates number of TAP(s).

Tip: For tech corridor, 96"L tables have two long doors and four short doors.



▶ Options, on previous page

Specification Information

Style Number	Finish	U.S. Base Prices	
			
		Flat Wood Edge:	Bullnose Wood Edge:

96"L, 54"W Center, 42"W End One Piece Top

0 TAP

HS9654B10	Grade 1 Laminate	\$5732	\$5816
	Grade 2 Laminate	\$5831	\$5915
	Grade 1 Veneer	\$6319	\$6403
	Grade 2 Veneer	\$6830	\$6914

1 TAP

HS9654B11	Grade 1 Laminate	\$7041	\$7125
	Grade 2 Laminate	\$7140	\$7224
	Grade 1 Veneer	\$7628	\$7712
	Grade 2 Veneer	\$8139	\$8223

2 TAPS

HS9654B12	Grade 1 Laminate	\$8351	\$8435
	Grade 2 Laminate	\$8450	\$8534
	Grade 1 Veneer	\$8938	\$9022
	Grade 2 Veneer	\$9449	\$9533

▶ Specification Information, continued on next page



For Canadian Pricing
 Multiply U.S. Price by the Canadian price factor.
 ▶ See page 1 for details.

Host Collection Boat Shaped Tables with Two Bases

DESIGN F/P DESIGN AND VECTA DESIGN TEAM

Tip: Prices shown include top, TAP(s), and slim bases.
 ▶ See base options for flared bases, page 436

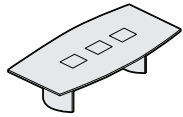
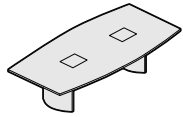
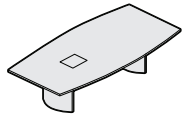
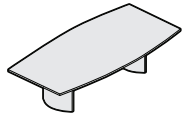

Tip: Last digit of style number indicates number of TAP(s).

Tip: For tech corridor, 10'L tables have four long doors and four short doors.



▶ Specification Information, continued from previous page

Specification Information

Style Number	Finish	U.S. Base Prices	
			
		Flat Wood Edge:	Bullnose Wood Edge:

10'L, 60"W Center, 48"W End One Piece Top

0 TAP

HS1060B10	Grade 1 Laminate	\$ 6361	\$ 6465
	Grade 2 Laminate	\$ 6516	\$ 6620
	Grade 1 Veneer	\$ 7475	\$ 7579
	Grade 2 Veneer	\$ 8280	\$ 8384

1 TAP

HS1060B11	Grade 1 Laminate	\$ 7670	\$ 7774
	Grade 2 Laminate	\$ 7825	\$ 7929
	Grade 1 Veneer	\$ 8784	\$ 8888
	Grade 2 Veneer	\$ 9589	\$ 9693

2 TAPS

HS1060B12	Grade 1 Laminate	\$ 8980	\$ 9084
	Grade 2 Laminate	\$ 9135	\$ 9239
	Grade 1 Veneer	\$10,094	\$10,198
	Grade 2 Veneer	\$10,899	\$11,003

3 TAPS

HS1060B13	Grade 1 Laminate	\$10,290	\$10,394
	Grade 2 Laminate	\$10,445	\$10,549
	Grade 1 Veneer	\$11,404	\$11,508
	Grade 2 Veneer	\$12,209	\$12,313

▶ Specification Information, continued on next page



For Canadian Pricing
 Multiply U.S. Price by the Canadian price factor.
 ▶ See page 1 for details.

Host Collection Boat Shaped Tables with Two Bases *continued*

DESIGN F/P DESIGN AND VECTA DESIGN TEAM

Tip: Prices shown include top, TAP(s), and slim bases.
 ▶ See base options for flared bases, page 436

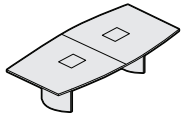
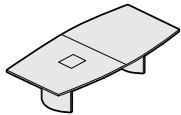
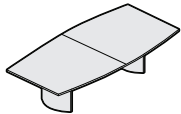

Tip: Last digit of style number indicates number of TAP(s).

Tip: For tech corridor, 10'L tables have four long doors and four short doors.



▶ Specification Information, continued from previous page

Specification Information

Style Number	Finish	U.S. Base Prices	
			
		Flat Wood Edge:	Bullnose Wood Edge:

10'L, 60"W Center, 48"W End Two Piece Top

0 TAP

HS1060B20	Grade 1 Laminate	\$ 6674	\$ 6778
	Grade 2 Laminate	\$ 6829	\$ 6933
	Grade 1 Veneer	\$ 7788	\$ 7892
	Grade 2 Veneer	\$ 8593	\$ 8697

1 TAP

HS1060B21	Grade 1 Laminate	\$ 7984	\$ 8088
	Grade 2 Laminate	\$ 8139	\$ 8243
	Grade 1 Veneer	\$ 9098	\$ 9202
	Grade 2 Veneer	\$ 9903	\$10,007

2 TAPS

HS1060B22	Grade 1 Laminate	\$ 9294	\$ 9398
	Grade 2 Laminate	\$ 9449	\$ 9553
	Grade 1 Veneer	\$10,408	\$10,512
	Grade 2 Veneer	\$11,213	\$11,317

▶ Specification Information, continued on next page



For Canadian Pricing
 Multiply U.S. Price by the Canadian price factor.
 ▶ See page 1 for details.

Host Collection Boat Shaped Tables with Two Bases

DESIGN F/P DESIGN AND VECTA DESIGN TEAM

Tip: Prices shown include top, TAP(s), and slim bases.
 ▶ See base options for flared bases, page 436

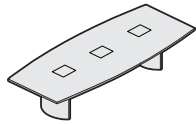
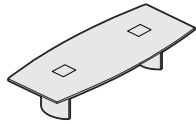
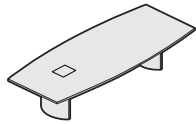
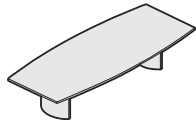

Tip: Last digit of style number indicates number of TAP(s).

Tip: For tech corridor, 12'L tables have four long doors and four short doors.



▶ Specification Information, continued from previous page

Specification Information

Style Number	Finish	U.S. Base Prices	
			
		Flat Wood Edge:	Bullnose Wood Edge:

12'L, 60"W Center, 48"W End One Piece Top

0 TAP

HS1260B10	Grade 1 Laminate	\$ 6821	\$ 6938
	Grade 2 Laminate	\$ 7007	\$ 7124
	Grade 1 Veneer	\$ 8175	\$ 8292
	Grade 2 Veneer	\$ 9142	\$ 9259

1 TAP

HS1260B11	Grade 1 Laminate	\$ 8130	\$ 8247
	Grade 2 Laminate	\$ 8316	\$ 8433
	Grade 1 Veneer	\$ 9484	\$ 9601
	Grade 2 Veneer	\$10,451	\$10,568

2 TAPS

HS1260B12	Grade 1 Laminate	\$ 9440	\$ 9557
	Grade 2 Laminate	\$ 9626	\$ 9743
	Grade 1 Veneer	\$10,794	\$10,911
	Grade 2 Veneer	\$11,761	\$11,878

3 TAPS

HS1260B13	Grade 1 Laminate	\$10,750	\$10,867
	Grade 2 Laminate	\$10,936	\$11,053
	Grade 1 Veneer	\$12,104	\$12,221
	Grade 2 Veneer	\$13,071	\$13,188

▶ Specification Information, continued on next page



For Canadian Pricing
 Multiply U.S. Price by the Canadian price factor.
 ▶ See page 1 for details.

Host Collection Boat Shaped Tables with Two Bases *continued*

DESIGN F/P DESIGN AND VECTA DESIGN TEAM

Tip: Prices shown include top, TAP(s), and slim bases.
 ▶ See base options for flared bases, page 436

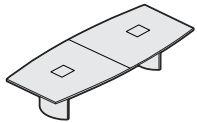
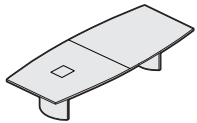
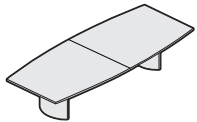

Tip: Last digit of style number indicates number of TAP(s).

Tip: For tech corridor, 12'L tables have four long doors and four short doors.



▶ Specification Information, continued from previous page

Specification Information

Style Number	Finish	U.S. Base Prices	
			
		Flat Wood Edge:	Bullnose Wood Edge:

12'L, 60"W Center, 48"W End Two Piece Top

0 TAP

HS1260B20	Grade 1 Laminate	\$ 7134	\$ 7251
	Grade 2 Laminate	\$ 7320	\$ 7437
	Grade 1 Veneer	\$ 8488	\$ 8605
	Grade 2 Veneer	\$ 9455	\$ 9572

1 TAP

HS1260B21	Grade 1 Laminate	\$ 8444	\$ 8561
	Grade 2 Laminate	\$ 8630	\$ 8747
	Grade 1 Veneer	\$ 9798	\$ 9915
	Grade 2 Veneer	\$10,765	\$10,882

2 TAPS

HS1260B22	Grade 1 Laminate	\$ 9754	\$ 9871
	Grade 2 Laminate	\$ 9940	\$10,057
	Grade 1 Veneer	\$11,108	\$11,225
	Grade 2 Veneer	\$12,075	\$12,192



For Canadian Pricing
 Multiply U.S. Price by the Canadian price factor.
 ▶ See page 1 for details.

Coalesse

Host Collection

Boat Shaped Tables with Two Bases

DESIGN F/P DESIGN AND VECTA DESIGN TEAM

Host Collection Boat Shaped Tables with Three Bases

DESIGN F/P DESIGN AND VECTA DESIGN TEAM

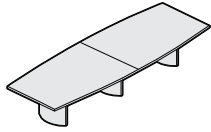

Tip: Shipped knocked down.

Tip: Grain direction for wood-grain laminate runs the length of the table.

Tip: Clips are provided with table. One clip per foot of table length.

Tip: The wood edge on a table top with woodgrain laminate may not match the top.

Tip: You must send a sample of reasonable size for Stain-to-Match.

Tip: 14'L and 16'L tables available with zero, one, two, or four TAP(s). 18'L and 20'L tables available with zero, one, two, four, or six TAP(s).

Tip: In addition to the data and audio/video AAPs available from Coalesse, other styles of AAPs are available through Extron Electronics. For an Extron dealer, call 1.800.633.9876.

Tip: See TAP options for electrical systems and faceplate list.

Standard Includes		Required to Specify
<ul style="list-style-type: none"> ▶ Need help? Product details, page 322 	<ul style="list-style-type: none"> • Top: 1/4" particle board core with laminate • Flat wood edge • TAP(s), if selected: 10"W x 12"L opening(s) trimmed with a flat solid wood profile and with brushed anodized aluminum TAP doors • Tech corridor: four aluminum beams for top support provide tracks for hinged aluminum doors that clip shut: satin anodized finish • Universal clip: black plastic • Three 27"W bases: wood veneer on MDF with aluminum universal bracket • Concealed leveling glides: non-marring, black plastic 	<ol style="list-style-type: none"> 1 Style number 2 Base selection 3 Laminate color number for table top, if selected 4 Wood color number for wood edge 5 Laminate color number for table top 6 Door color number for storage tray or TAP door, if selected: <ul style="list-style-type: none"> - 8043 Silver - 8044 Black 7 Options, if selected (see below) <p>▶ See <i>Surface Materials</i>, page 600.</p>

Options	U.S. Price	Required to Specify
Surface Materials <ul style="list-style-type: none"> • Grade 2 laminate • Grade 1 wood veneer • Grade 2 wood veneer • Stain-to-Match 	<ul style="list-style-type: none"> Prices at right Prices at right Prices at right No cost 	<ul style="list-style-type: none"> Specify with <i>Grade 2 laminate</i> and select color number. Specify with <i>Grade 1 wood veneer</i> and select color number. Specify with <i>Grade 2 wood veneer</i> and select color number. Specify with <i>Stain-to-Match</i>. <p>▶ Page 5</p>

Edges	Wood	U.S. Price	Required to Specify
	<ul style="list-style-type: none"> • Bullnose wood edge 	Prices at right	Specify with <i>bullnose wood edge</i> .

Bases	Options	U.S. Price	Required to Specify
<p>Slim Flared</p>	<ul style="list-style-type: none"> • Three slim bases • Two slim and one flared bases • One slim and two flared bases • Three flared bases 	<ul style="list-style-type: none"> No cost +\$ 693 +\$1386 +\$2079 	<ul style="list-style-type: none"> Specify with <i>three slim bases</i>. Specify with <i>two slim and one flared bases</i>. Specify with <i>one slim and two flared bases</i>. Specify with <i>three flared bases</i>.

TAP Electrical System with Faceplate Options	Options	U.S. Price	Required to Specify
<p>▶ Page 334</p> <p>Field Wired</p> <p>Cord and Plug</p> <p>Hardwired</p>	<ul style="list-style-type: none"> • Field-Wired tray (no electrical) <ul style="list-style-type: none"> - PAFW Field-Wired tray (no electrical) with blank AAPs - PDFW Field-Wired tray (no electrical) with two Data AAPs - PVFW Field-Wired tray (no electrical) with two of each Video/Audio and Data AAPs • Cord and Plug tray (10' cord) <ul style="list-style-type: none"> - PACP Cord and Plug tray with outlets and blank AAPs - PDCP Cord and Plug tray with outlets and two Data AAPs - PAVC Cord and Plug tray with outlets and two of each Video/Audio and Data AAPs • Hard-Wired tray (6' conduit) <ul style="list-style-type: none"> - PAHW Hard-Wired tray with outlets and blank AAPs - PDHW Hard-Wired tray with outlets and two Data AAPs - PAVH Hard-Wired tray with outlets and two of each Video/Audio and Data AAPs 	<ul style="list-style-type: none"> No cost No cost No cost 	<ul style="list-style-type: none"> Specify with <i>power data</i>, and select TAP type and TAP door color number. Specify with <i>power data</i>, and select TAP type and TAP door color number. Specify with <i>power data</i>, and select TAP type and TAP door color number.

▶ Options, continued on next page



For Canadian Pricing
 Multiply U.S. Price by the Canadian price factor.
 ▶ See page 1 for details.

Host Collection Boat Shaped Tables with Three Bases

DESIGN F/P DESIGN AND VECTA DESIGN TEAM

► Options, continued from previous page

Tip: For single TAP style numbers, the modular system tray is not available. Specify the hard-wired tray option.

Tip: If the specified table has multiple TAP(s), any one TAP can be replaced with a storage tray.

Tip: Wood veneer doors for storage tray or TAP will always be cross grain.

Tip: Connectrac must be the same wiring schematic as the table.

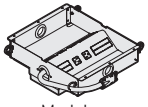
Options	U.S. Price	Required to Specify
TAP Electrical System with Faceplate Options ► Page 334  Modular	<ul style="list-style-type: none"> • Modular System tray (hardwire base power infeed) +\$119 each tray - PAMH Modular System tray with outlets and blank AAPs - PDMH Modular System tray with outlets and two Data AAPs - PVMH Modular System tray with outlets and two of each Video/Audio and Data AAPs 	Specify with <i>modular power data</i> , and select TAP type and TAP door color number.
Storage Tray ► Page 335	<ul style="list-style-type: none"> • Storage tray -\$500 	Specify with <i>storage tray</i> and select door color number.
Doors	<ul style="list-style-type: none"> • Storage tray wood veneer doors +\$250 per door • TAP wood veneer doors +\$250 per door 	Specify with <i>wood doors</i> .
Related Products	<ul style="list-style-type: none"> • Floor kit: Connectrac • Corridor shelf 	► Page 463 ► Page 463

TAP Locations

14'L, 60"W Center, 48"W End TAP Locations—Two piece top

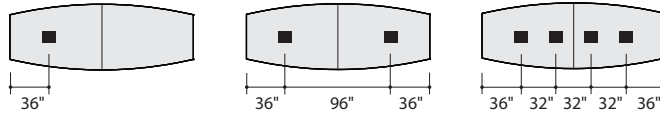

14'L, 60"W Center, 48"W End TAP Locations—Three piece top

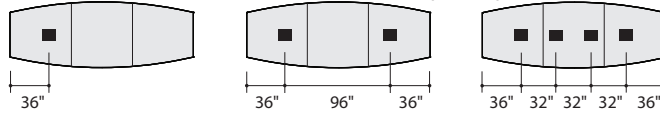

16'L, 60"W Center, 48"W End TAP Locations—Two piece top

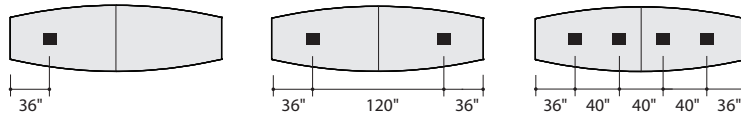

16'L, 60"W Center, 48"W End TAP Locations—Three piece top

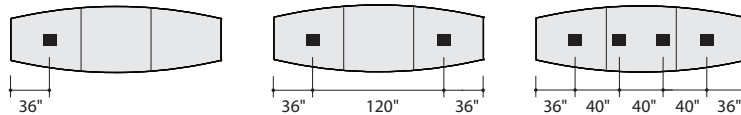

► Options, continued on next page

Host Collection



For Canadian Pricing
 Multiply U.S. Price by the Canadian price factor.
 ► See page 1 for details.

Host Collection Boat Shaped Tables with Three Bases *continued*

DESIGN F/P DESIGN AND VECTA DESIGN TEAM

► Options, continued from previous page

TAP Locations

18'L, 60"W Center, 48"W End TAP Locations—Two piece top

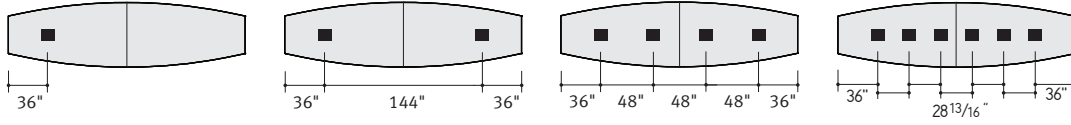

18'L, 60"W Center, 48"W End TAP Locations—Three piece top

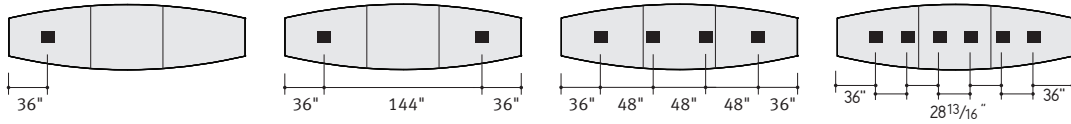

20'L, 60"W Center, 48"W End TAP Locations—Two piece top

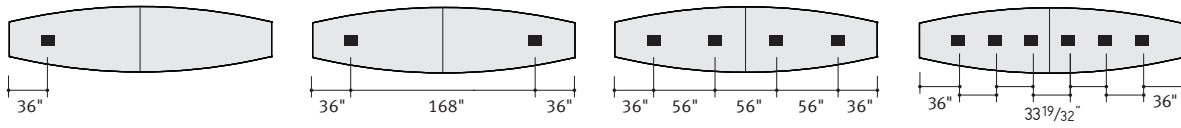

20'L, 60"W Center, 48"W End TAP Locations—Three piece top

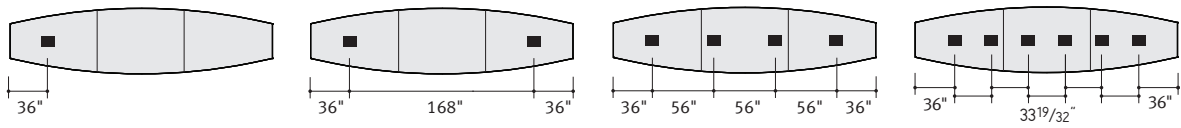

Host Collection Boat Shaped Tables with Three Bases

DESIGN F/P DESIGN AND VECTA DESIGN TEAM



Tip: Prices shown include top, TAP(s), and slim bases.
 ▶ See base options for flared bases, page 444

Tip: Last digit of style number indicates number of TAP(s).

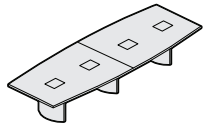
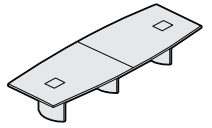
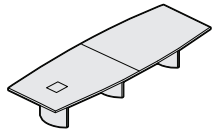
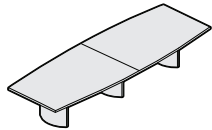
Tip: For tech corridor, 14'L tables have four long doors and four short doors.



Specification Information

Style Number	Finish	U.S. Base Prices	
			
		Flat Wood Edge:	Bullnose Wood Edge:

14'L, 60"W Center, 48"W End Two Piece Top

0 TAP

HS1460B20	Grade 1 Laminate	\$ 9406	\$ 9536
	Grade 2 Laminate	\$ 9623	\$ 9753
	Grade 1 Veneer	\$11,439	\$11,569
	Grade 2 Veneer	\$12,580	\$12,710

1 TAP

HS1460B21	Grade 1 Laminate	\$10,715	\$10,845
	Grade 2 Laminate	\$10,932	\$11,062
	Grade 1 Veneer	\$12,748	\$12,878
	Grade 2 Veneer	\$13,889	\$14,019

2 TAPS

HS1460B22	Grade 1 Laminate	\$12,025	\$12,155
	Grade 2 Laminate	\$12,242	\$12,372
	Grade 1 Veneer	\$14,058	\$14,188
	Grade 2 Veneer	\$15,199	\$15,329

4 TAPS

HS1460B24	Grade 1 Laminate	\$14,645	\$14,775
	Grade 2 Laminate	\$14,862	\$14,992
	Grade 1 Veneer	\$16,678	\$16,808
	Grade 2 Veneer	\$17,819	\$17,949

▶ Specification Information, continued on next page



For Canadian Pricing
 Multiply U.S. Price by the Canadian price factor.
 ▶ See page 1 for details.

Host Collection Boat Shaped Tables with Three Bases *continued*

DESIGN F/P DESIGN AND VECTA DESIGN TEAM

Tip: Prices shown include top, TAP(s), and slim bases.
 ▶ See base options for flared bases, page 444

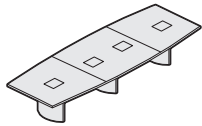
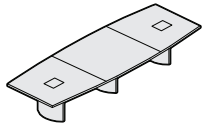
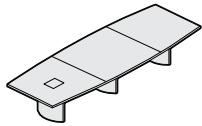
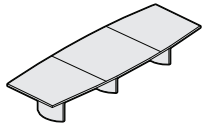

Tip: Last digit of style number indicates number of TAP(s).

Tip: For tech corridor, 14'L tables have four long doors and four short doors.



▶ Specification Information, continued from previous page

Specification Information

Style Number	Finish	U.S. Base Prices	
			
		Flat Wood Edge:	Bullnose Wood Edge:

14'L, 60"W Center, 48"W End Three Piece Top

0 TAP

HS1460B30	Grade 1 Laminate	\$ 9719	\$ 9849
	Grade 2 Laminate	\$ 9936	\$10,066
	Grade 1 Veneer	\$11,752	\$11,882
	Grade 2 Veneer	\$12,893	\$13,023

1 TAP

HS1460B31	Grade 1 Laminate	\$11,029	\$11,159
	Grade 2 Laminate	\$11,246	\$11,376
	Grade 1 Veneer	\$13,062	\$13,192
	Grade 2 Veneer	\$14,203	\$14,333

2 TAPS

HS1460B32	Grade 1 Laminate	\$12,339	\$12,469
	Grade 2 Laminate	\$12,556	\$12,686
	Grade 1 Veneer	\$14,372	\$14,502
	Grade 2 Veneer	\$15,513	\$15,643

4 TAPS

HS1460B34	Grade 1 Laminate	\$14,959	\$15,089
	Grade 2 Laminate	\$15,176	\$15,306
	Grade 1 Veneer	\$16,992	\$17,122
	Grade 2 Veneer	\$18,133	\$18,263

▶ Specification Information, continued on next page



For Canadian Pricing
 Multiply U.S. Price by the Canadian price factor.
 ▶ See page 1 for details.

Host Collection Boat Shaped Tables with Three Bases

DESIGN F/P DESIGN AND VECTA DESIGN TEAM

Tip: Prices shown include top, TAP(s), and slim bases.
 ▶ See base options for flared bases, page 444

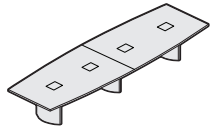
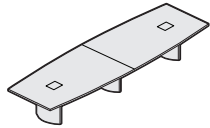
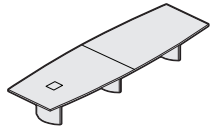
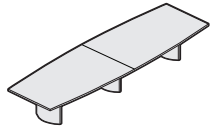

Tip: Last digit of style number indicates number of TAP(s).

Tip: For tech corridor, 16'L tables have eight long doors and four short doors.



▶ Specification Information, continued from previous page

Specification Information

Style Number	Finish	U.S. Base Prices	
			
		Flat Wood Edge:	Bullnose Wood Edge:

16'L, 60"W Center, 48"W End Two Piece Top

0 TAP

HS1660B20	Grade 1 Laminate	\$ 9820	\$ 9964
	Grade 2 Laminate	\$10,068	\$10,212
	Grade 1 Veneer	\$11,879	\$12,023
	Grade 2 Veneer	\$13,177	\$13,321

1 TAP

HS1660B21	Grade 1 Laminate	\$11,129	\$11,273
	Grade 2 Laminate	\$11,377	\$11,521
	Grade 1 Veneer	\$13,188	\$13,332
	Grade 2 Veneer	\$14,486	\$14,630

2 TAPS

HS1660B22	Grade 1 Laminate	\$12,439	\$12,583
	Grade 2 Laminate	\$12,687	\$12,831
	Grade 1 Veneer	\$14,498	\$14,642
	Grade 2 Veneer	\$15,796	\$15,940

4 TAPS

HS1660B24	Grade 1 Laminate	\$15,059	\$15,203
	Grade 2 Laminate	\$15,307	\$15,451
	Grade 1 Veneer	\$17,118	\$17,262
	Grade 2 Veneer	\$18,416	\$18,560

▶ Specification Information, continued on next page



For Canadian Pricing
 Multiply U.S. Price by the Canadian price factor.
 ▶ See page 1 for details.

Host Collection Boat Shaped Tables with Three Bases *continued*

DESIGN F/P DESIGN AND VECTA DESIGN TEAM

Tip: Prices shown include top, TAP(s), and slim bases.
 ▶ See base options for flared bases, page 444

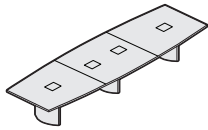
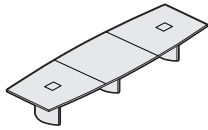
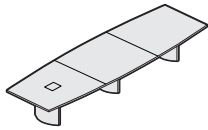
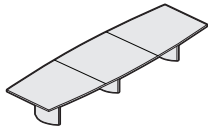

Tip: Last digit of style number indicates number of TAP(s).

Tip: For tech corridor, 16'L tables have eight long doors and four short doors.



▶ Specification Information, continued from previous page

Specification Information

Style Number	Finish	U.S. Base Prices	
			
		Flat Wood Edge:	Bullnose Wood Edge:

16'L, 60"W Center, 48"W End Three Piece Top

0 TAP

HS1660B30	Grade 1 Laminate	\$10,133	\$10,277
	Grade 2 Laminate	\$10,381	\$10,525
	Grade 1 Veneer	\$12,192	\$12,336
	Grade 2 Veneer	\$13,490	\$13,634

1 TAP

HS1660B31	Grade 1 Laminate	\$11,443	\$11,587
	Grade 2 Laminate	\$11,691	\$11,835
	Grade 1 Veneer	\$13,502	\$13,646
	Grade 2 Veneer	\$14,800	\$14,944

2 TAPS

HS1660B32	Grade 1 Laminate	\$12,753	\$12,897
	Grade 2 Laminate	\$13,001	\$13,145
	Grade 1 Veneer	\$14,812	\$14,956
	Grade 2 Veneer	\$16,110	\$16,254

4 TAPS

HS1660B34	Grade 1 Laminate	\$15,373	\$15,517
	Grade 2 Laminate	\$15,621	\$15,765
	Grade 1 Veneer	\$17,432	\$17,576
	Grade 2 Veneer	\$18,730	\$18,874

▶ Specification Information, continued on next page



For Canadian Pricing
 Multiply U.S. Price by the Canadian price factor.
 ▶ See page 1 for details.

Host Collection Boat Shaped Tables with Three Bases

DESIGN F/P DESIGN AND VECTA DESIGN TEAM

Tip: Prices shown include top, TAP(s), and slim bases.
 ▶ See base options for flared bases, page 444

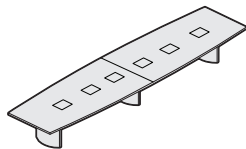
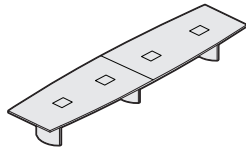
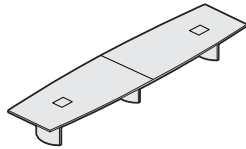
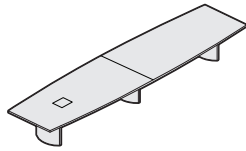
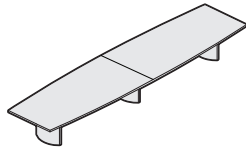

Tip: Last digit of style number indicates number of TAP(s).

Tip: For tech corridor, 18'L tables have eight long doors and four short doors.



▶ Specification Information, continued from previous page

Specification Information

Style Number	Finish	U.S. Base Prices	
			
		Flat Wood Edge:	Bullnose Wood Edge:

18"L, 60"W Center, 48"W End Two Piece Top

0 TAP

HS1860B20	Grade 1 Laminate	\$10,264	\$10,421
	Grade 2 Laminate	\$10,543	\$10,700
	Grade 1 Veneer	\$12,951	\$13,108
	Grade 2 Veneer	\$14,421	\$14,578

1 TAP

HS1860B21	Grade 1 Laminate	\$11,573	\$11,730
	Grade 2 Laminate	\$11,852	\$12,009
	Grade 1 Veneer	\$14,260	\$14,417
	Grade 2 Veneer	\$15,730	\$15,887

2 TAPS

HS1860B22	Grade 1 Laminate	\$12,883	\$13,040
	Grade 2 Laminate	\$13,162	\$13,319
	Grade 1 Veneer	\$15,570	\$15,727
	Grade 2 Veneer	\$17,040	\$17,197

4 TAPS

HS1860B24	Grade 1 Laminate	\$15,503	\$15,660
	Grade 2 Laminate	\$15,782	\$15,939
	Grade 1 Veneer	\$18,190	\$18,347
	Grade 2 Veneer	\$19,660	\$19,817

6 TAPS

HS1860B26	Grade 1 Laminate	\$18,123	\$18,280
	Grade 2 Laminate	\$18,402	\$18,559
	Grade 1 Veneer	\$20,810	\$20,967
	Grade 2 Veneer	\$22,280	\$22,437

▶ Specification Information, continued on next page

For Canadian Pricing
 Multiply U.S. Price by the Canadian price factor.
 ▶ See page 1 for details.

Host Collection Boat Shaped Tables with Three Bases *continued*

DESIGN F/P DESIGN AND VECTA DESIGN TEAM

Tip: Prices shown include top, TAP(s), and slim bases.
 ▶ See base options for flared bases, page 444

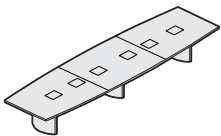
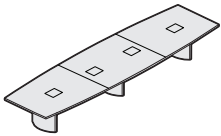
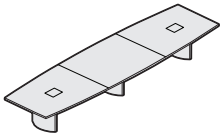
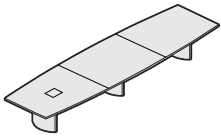
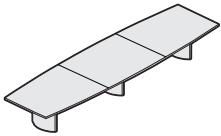

Tip: Last digit of style number indicates number of TAP(s).

Tip: For tech corridor, 18'L tables have eight long doors and four short doors.



▶ Specification Information, continued from previous page

Specification Information

Style Number	Finish	U.S. Base Prices	
			
		Flat Wood Edge:	Bullnose Wood Edge:

18'L, 60"W Center, 48"W End Three Piece Top

0 TAP

HS1860B30	Grade 1 Laminate	\$10,577	\$10,734
	Grade 2 Laminate	\$10,856	\$11,013
	Grade 1 Veneer	\$13,264	\$13,421
	Grade 2 Veneer	\$14,734	\$14,891

1 TAP

HS1860B31	Grade 1 Laminate	\$11,887	\$12,044
	Grade 2 Laminate	\$12,166	\$12,323
	Grade 1 Veneer	\$14,574	\$14,731
	Grade 2 Veneer	\$16,044	\$16,201

2 TAPS

HS1860B32	Grade 1 Laminate	\$13,197	\$13,354
	Grade 2 Laminate	\$13,476	\$13,633
	Grade 1 Veneer	\$15,884	\$16,041
	Grade 2 Veneer	\$17,354	\$17,511

4 TAPS

HS1860B34	Grade 1 Laminate	\$15,817	\$15,974
	Grade 2 Laminate	\$16,096	\$16,253
	Grade 1 Veneer	\$18,504	\$18,661
	Grade 2 Veneer	\$19,974	\$20,131

6 TAPS

HS1860B36	Grade 1 Laminate	\$18,437	\$18,594
	Grade 2 Laminate	\$18,716	\$18,873
	Grade 1 Veneer	\$21,124	\$21,281
	Grade 2 Veneer	\$22,594	\$22,751

▶ Specification Information, continued on next page



For Canadian Pricing
 Multiply U.S. Price by the Canadian price factor.
 ▶ See page 1 for details.

Host Collection Boat Shaped Tables with Three Bases

DESIGN F/P DESIGN AND VECTA DESIGN TEAM

Tip: Prices shown include top, TAP(s), and slim bases.
 ▶ See base options for flared bases, page 444

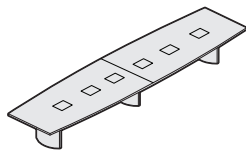
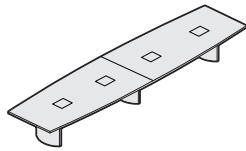
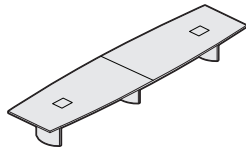
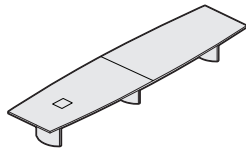
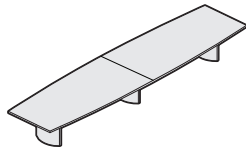

Tip: Last digit of style number indicates number of TAP(s).

Tip: For tech corridor, 20'L tables have eight long doors and four short doors.



▶ Specification Information, continued from previous page

Specification Information

Style Number	Finish	U.S. Base Prices	
			
		Flat Wood Edge:	Bullnose Wood Edge:

20'L, 60"W Center, 48"W End Two Piece Top

0 TAP			
HS2060B20	Grade 1 Laminate	\$10,679	\$10,849
	Grade 2 Laminate	\$10,989	\$11,159
	Grade 1 Veneer	\$13,394	\$13,564
	Grade 2 Veneer	\$15,019	\$15,189
1 TAP			
HS2060B21	Grade 1 Laminate	\$11,988	\$12,158
	Grade 2 Laminate	\$12,298	\$12,468
	Grade 1 Veneer	\$14,703	\$14,873
	Grade 2 Veneer	\$16,328	\$16,498
2 TAPS			
HS2060B22	Grade 1 Laminate	\$13,298	\$13,468
	Grade 2 Laminate	\$13,608	\$13,778
	Grade 1 Veneer	\$16,013	\$16,183
	Grade 2 Veneer	\$17,638	\$17,808
4 TAPS			
HS2060B24	Grade 1 Laminate	\$15,918	\$16,088
	Grade 2 Laminate	\$16,228	\$16,398
	Grade 1 Veneer	\$18,633	\$18,803
	Grade 2 Veneer	\$20,258	\$20,428
6 TAPS			
HS2060B26	Grade 1 Laminate	\$18,538	\$18,708
	Grade 2 Laminate	\$18,848	\$19,018
	Grade 1 Veneer	\$21,253	\$21,423
	Grade 2 Veneer	\$22,878	\$23,048

▶ Specification Information, continued on next page



For Canadian Pricing
 Multiply U.S. Price by the Canadian price factor.
 ▶ See page 1 for details.

Host Collection Boat Shaped Tables with Three Bases *continued*

DESIGN F/P DESIGN AND VECTA DESIGN TEAM



Tip: Prices shown include top, TAP(s), and slim bases.
 ▶ See base options for flared bases, page 444

Tip: Last digit of style number indicates number of TAP(s).

Tip: For tech corridor, 20'L tables have eight long doors and four short doors.

▶ Specification Information, continued from previous page

Specification Information

Style Number	Finish	U.S. Base Prices	
			
		Flat Wood Edge:	Bullnose Wood Edge:

20'L, 60"W Center, 48"W End Three Piece Top

0 TAP

HS2060B30	Grade 1 Laminate	\$10,992	\$11,162
	Grade 2 Laminate	\$11,302	\$11,472
	Grade 1 Veneer	\$13,707	\$13,877
	Grade 2 Veneer	\$15,332	\$15,502

1 TAP

HS2060B31	Grade 1 Laminate	\$12,302	\$12,472
	Grade 2 Laminate	\$12,612	\$12,782
	Grade 1 Veneer	\$15,017	\$15,187
	Grade 2 Veneer	\$16,642	\$16,812

2 TAPS

HS2060B32	Grade 1 Laminate	\$13,612	\$13,782
	Grade 2 Laminate	\$13,922	\$14,092
	Grade 1 Veneer	\$16,327	\$16,497
	Grade 2 Veneer	\$17,952	\$18,122

4 TAPS

HS2060B34	Grade 1 Laminate	\$16,232	\$16,402
	Grade 2 Laminate	\$16,542	\$16,712
	Grade 1 Veneer	\$18,947	\$19,117
	Grade 2 Veneer	\$20,572	\$20,742

6 TAPS

HS2060B36	Grade 1 Laminate	\$18,852	\$19,022
	Grade 2 Laminate	\$19,162	\$19,332
	Grade 1 Veneer	\$21,567	\$21,737
	Grade 2 Veneer	\$23,192	\$23,362

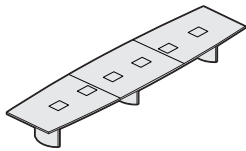
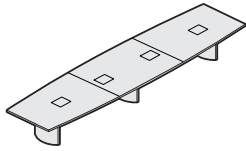
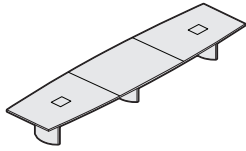
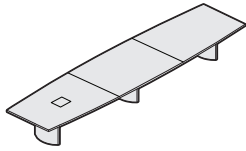
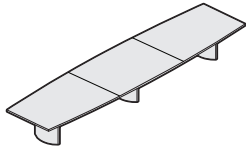

For Canadian Pricing
 Multiply U.S. Price by the Canadian price factor.
 ▶ See page 1 for details.

Coalesse

Host Collection

Boat Shaped Tables with Three Bases

DESIGN F/P DESIGN AND VECTA DESIGN TEAM

Host Collection Trapezoid Tables with Two Bases

DESIGN F/P DESIGN AND VECTA DESIGN TEAM

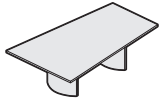

Tip: Shipped knocked down.

Tip: Grain direction for wood-grain laminate runs the length of the table.

Tip: See TAP options for electrical systems and faceplate list.

Tip: Clips are provided with table: One clip per foot of table length.

Tip: The wood edge on a table top with woodgrain laminate may not match the top.

Tip: You must send a sample of reasonable size for Stain-to-Match.

Standard Includes		Required to Specify
<ul style="list-style-type: none"> ▶ Need help? Product details, page 322 	<ul style="list-style-type: none"> • Top: 1/4" particle board core with laminate • Flat wood edge • TAP(s), if selected: 10"W x 12"L opening(s) trimmed with a flat solid wood profile and with brushed anodized aluminum TAP doors: • Tech corridor: two aluminum beams for top support provide tracks for hinged aluminum doors that clip shut: satin anodized finish • Universal clip: black plastic • Two 27"W bases: wood veneer on MDF with aluminum universal bracket • Concealed leveling glides: non-marring, black plastic 	<ol style="list-style-type: none"> 1 Style number 2 Base selection (see below) and wood color number for base 3 Laminate color number for table top, if selected 4 Wood color number for wood edge 5 Door color number for storage tray or TAP door, if selected: <ul style="list-style-type: none"> - 8043 Silver - 8044 Black 6 Options, if selected (see below) <p>▶ See <i>Surface Materials</i>, page 600.</p>

Options	U.S. Price	Required to Specify
Surface Materials <ul style="list-style-type: none"> • Grade 2 laminate • Grade 1 Wood veneer • Grade 2 wood veneer • Stain-to-Match 	<ul style="list-style-type: none"> Prices at right Prices at right Prices at right No cost 	<ul style="list-style-type: none"> Specify with <i>Grade 2 laminate</i> and select color number. Specify with <i>Grade 1 wood veneer</i> and select color number. Specify with <i>Grade 2 wood veneer</i> and select color number. Specify with <i>Stain-to-Match</i>. <p>▶ Page 5</p>

Edges	Wood	U.S. Price	Required to Specify
	<ul style="list-style-type: none"> • Bullnose wood edge • Horizon wood edge 	<ul style="list-style-type: none"> Prices at right Prices at right 	<ul style="list-style-type: none"> Specify with <i>bullnose wood edge</i>. Specify with <i>horizon wood edge</i>.

Bases	Options	U.S. Price	Required to Specify
<p>Slim Flared</p>	<ul style="list-style-type: none"> • Two slim bases • One slim and one flared base • Two flared bases 	<ul style="list-style-type: none"> No cost +\$ 693 +\$1386 	<ul style="list-style-type: none"> Specify with <i>two slim bases</i>. Specify with <i>one slim base and one flared base</i>. Specify with <i>two flared bases</i>.

TAP Electrical System with Faceplate Options	Options	U.S. Price	Required to Specify
<p>▶ Page 334</p> <p>Field Wired</p> <p>Cord and Plug</p> <p>Hardwired</p>	<ul style="list-style-type: none"> • Field-Wired tray (no electrical) <ul style="list-style-type: none"> - PAFW Field-Wired tray (no electrical) with blank AAPs - PDFW Field-Wired tray (no electrical) with two Data AAPs - PVFW Field-Wired tray (no electrical) with two of each Video/Audio and Data AAPs • Cord and Plug tray (10' cord) <ul style="list-style-type: none"> - PACP Cord and Plug tray with outlets and blank AAPs - PDCP Cord and Plug tray with outlets and two Data AAPs - PAVC Cord and Plug tray with outlets and two of each Video/Audio and Data AAPs • Hard-Wired tray (6' conduit) <ul style="list-style-type: none"> - PAHW Hard-Wired tray with outlets and blank AAPs - PDHW Hard-Wired tray with outlets and two Data AAPs - PAVH Hard-Wired tray with outlets and two of each Video/Audio and Data AAPs 	<ul style="list-style-type: none"> No cost No cost No cost 	<ul style="list-style-type: none"> Specify with <i>power data</i>, and select TAP type and TAP door color number. Specify with <i>power data</i>, and select TAP type and TAP door color number. Specify with <i>power data</i>, and select TAP type and TAP door color number.

▶ Options, continued on next page



For Canadian Pricing
 Multiply U.S. Price by the Canadian price factor.
 ▶ See page 1 for details.

Host Collection Trapezoid Tables with Two Bases

DESIGN F/P DESIGN AND VECTA DESIGN TEAM

Tip: For single TAP style numbers, the modular system tray is not available. Specify the hard-wired tray option.

Tip: If the specified table has multiple TAP(s), any one TAP can be replaced with a storage tray.

Tip: Wood veneer doors for storage tray or TAP will always be cross grain.

Tip: Connectrac must be the same wiring schematic as the table.

► Options, continued from previous page

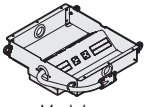
Options	U.S. Price	Required to Specify
TAP Electrical System with Faceplate Options ► Page 334  Modular	<ul style="list-style-type: none"> • Modular System tray (hardwire base power infeed) +\$119 each tray - PAMH Modular System tray with outlets and blank AAPs - PDMH Modular System tray with outlets and two Data AAPs - PVMH Modular System tray with outlets and two of each Video/Audio and Data AAPs 	Specify with <i>modular power data</i> , and select TAP type and TAP door color number.
Storage Tray ► Page 335	<ul style="list-style-type: none"> • Storage tray -\$500 	Specify with <i>storage tray</i> and select door color number.
Doors	<ul style="list-style-type: none"> • Storage tray wood veneer doors +\$250 per door • TAP wood veneer doors +\$250 per door 	Specify with <i>wood doors</i> .
Related Products	<ul style="list-style-type: none"> • Floor kit: Connectrac • Corridor shelf 	► Page 463 ► Page 463

TAP Locations

96"L x 42"W x 60"W TAP Locations—One piece top

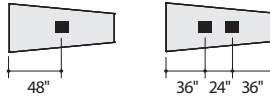

10'L x 42"W x 60"W TAP Locations—One piece top

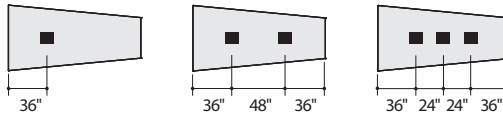

10'L x 42"W x 60"W TAP Locations—Two piece top

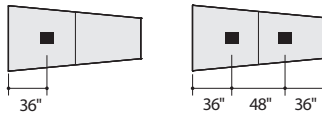

12'L x 42"W x 60"W TAP Locations—One piece top

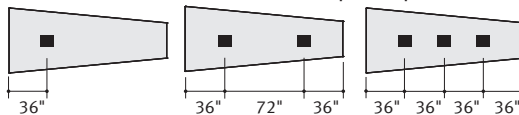

12'L x 42"W x 60"W TAP Locations—Two piece top

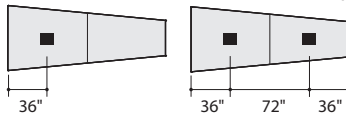

► Specification Information, on next page

Host Collection



For Canadian Pricing
 Multiply U.S. Price by the Canadian price factor.
 ► See page 1 for details.

Host Collection Trapezoid Tables with Two Bases *continued*

DESIGN F/P DESIGN AND VECTA DESIGN TEAM

Tip: Prices shown include top, TAP(s), and slim bases.
 ▶ See base options for flared bases, page 456

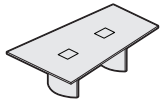
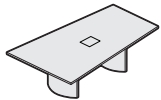
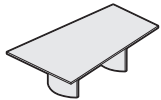

Tip: Last digit of style number indicates number of TAP(s).

Tip: For tech corridor, 96"L tables have two long doors and four short doors.



▶ Options, on previous page

Specification Information

Style Number	Finish	U.S. Base Prices		
				
		Flat Wood Edge:	Bullnose Wood Edge:	Horizon Wood Edge:

96"L x 42"W x 60"W One Piece Top

0 TAP

HS9660T10	Grade 1 Laminate	\$5755	\$5839	\$ 6926
	Grade 2 Laminate	\$5879	\$5963	\$ 7050
	Grade 1 Veneer	\$6342	\$6426	\$ 7513
	Grade 2 Veneer	\$6977	\$7061	\$ 8148

1 TAP

HS9660T11	Grade 1 Laminate	\$7064	\$7148	\$ 8235
	Grade 2 Laminate	\$7188	\$7272	\$ 8359
	Grade 1 Veneer	\$7651	\$7735	\$ 8822
	Grade 2 Veneer	\$8286	\$8370	\$ 9457

2 TAPS

HS9660T12	Grade 1 Laminate	\$8374	\$8458	\$ 9545
	Grade 2 Laminate	\$8498	\$8582	\$ 9669
	Grade 1 Veneer	\$8961	\$9045	\$10,132
	Grade 2 Veneer	\$9596	\$9680	\$10,767

▶ Specification Information, continued on next page



For Canadian Pricing
 Multiply U.S. Price by the Canadian price factor.
 ▶ See page 1 for details.

Host Collection Trapezoid Tables with Two Bases

DESIGN F/P DESIGN AND VECTA DESIGN TEAM

Tip: Prices shown include top, TAP(s), and slim bases.
 ▶ See base options for flared bases, page 456

Tip: Last digit of style number indicates number of TAP(s).

Tip: For tech corridor, 10'L tables have four long doors and four short doors.

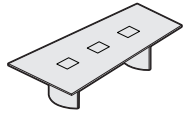
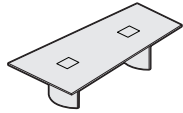
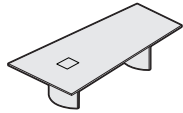
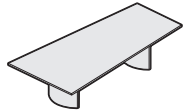

▶ Specification Information, continued from previous page

Specification Information

Style Number	Finish	U.S. Base Prices		
		Flat Wood Edge:	Bullnose Wood Edge:	Horizon Wood Edge:

10'L x 42"W x 60"W One Piece Top

0 TAP

Style Number	Grade	Flat Wood Edge	Bullnose Wood Edge	Horizon Wood Edge
HS1060T10	Grade 1 Laminate	\$ 6138	\$ 6242	\$ 7342
	Grade 2 Laminate	\$ 6293	\$ 6397	\$ 7497
	Grade 1 Veneer	\$ 6847	\$ 6951	\$ 8051
	Grade 2 Veneer	\$ 7640	\$ 7744	\$ 8844

1 TAP

Style Number	Grade	Flat Wood Edge	Bullnose Wood Edge	Horizon Wood Edge
HS1060T11	Grade 1 Laminate	\$ 7447	\$ 7551	\$ 8651
	Grade 2 Laminate	\$ 7602	\$ 7706	\$ 8806
	Grade 1 Veneer	\$ 8156	\$ 8260	\$ 9360
	Grade 2 Veneer	\$ 8949	\$ 9053	\$10,153

2 TAPS

Style Number	Grade	Flat Wood Edge	Bullnose Wood Edge	Horizon Wood Edge
HS1060T12	Grade 1 Laminate	\$ 8757	\$ 8861	\$ 9961
	Grade 2 Laminate	\$ 8912	\$ 9016	\$10,116
	Grade 1 Veneer	\$ 9466	\$ 9570	\$10,670
	Grade 2 Veneer	\$10,259	\$10,363	\$11,463

3 TAPS

Style Number	Grade	Flat Wood Edge	Bullnose Wood Edge	Horizon Wood Edge
HS1060T13	Grade 1 Laminate	\$10,067	\$10,171	\$11,271
	Grade 2 Laminate	\$10,222	\$10,326	\$11,426
	Grade 1 Veneer	\$10,776	\$10,880	\$11,980
	Grade 2 Veneer	\$11,569	\$11,673	\$12,773

▶ Specification Information, continued on next page



For Canadian Pricing
 Multiply U.S. Price by the Canadian price factor.
 ▶ See page 1 for details.

Host Collection Trapezoid Tables with Two Bases *continued*

DESIGN F/P DESIGN AND VECTA DESIGN TEAM

Tip: Prices shown include top, TAP(s), and slim bases.
 ▶ See base options for flared bases, page 456

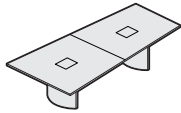
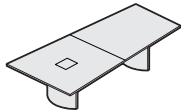
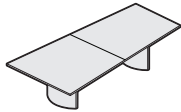

Tip: Last digit of style number indicates number of TAP(s).

Tip: For tech corridor, 10'L tables have four long doors and four short doors.



▶ Specification Information, continued from previous page

Specification Information

Style Number	Finish	U.S. Base Prices		
				
		Flat Wood Edge:	Bullnose Wood Edge:	Horizon Wood Edge:

10'L x 42"W x 60"W Two Piece Top

0 TAP

HS1060T20	Grade 1 Laminate	\$ 6451	\$ 6555	\$ 7655
	Grade 2 Laminate	\$ 6606	\$ 6710	\$ 7810
	Grade 1 Veneer	\$ 7160	\$ 7264	\$ 8364
	Grade 2 Veneer	\$ 7953	\$ 8057	\$ 9157

1 TAP

HS1060T21	Grade 1 Laminate	\$ 7761	\$ 7865	\$ 8965
	Grade 2 Laminate	\$ 7916	\$ 8020	\$ 9120
	Grade 1 Veneer	\$ 8470	\$ 8574	\$ 9674
	Grade 2 Veneer	\$ 9263	\$ 9367	\$10,467

2 TAPS

HS1060T22	Grade 1 Laminate	\$ 9071	\$ 9175	\$10,275
	Grade 2 Laminate	\$ 9226	\$ 9330	\$10,430
	Grade 1 Veneer	\$ 9780	\$ 9884	\$10,984
	Grade 2 Veneer	\$10,573	\$10,677	\$11,777

▶ Specification Information, continued on next page



For Canadian Pricing
 Multiply U.S. Price by the Canadian price factor.
 ▶ See page 1 for details.

Host Collection Trapezoid Tables with Two Bases

DESIGN F/P DESIGN AND VECTA DESIGN TEAM

Tip: Prices shown include top, TAP(s), and slim bases.
 ▶ See base options for flared bases, page 456

Tip: Last digit of style number indicates number of TAP(s).

Tip: For tech corridor, 12'L tables have four long doors and four short doors.

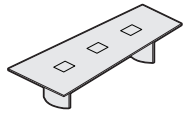
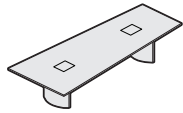
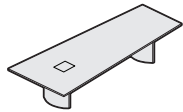
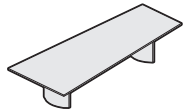

▶ Specification Information, continued from previous page

Specification Information

Style Number	Finish	U.S. Base Prices		
		Flat Wood Edge:	Bullnose Wood Edge:	Horizon Wood Edge:

12'L x 42"W x 60"W One Piece Top

0 TAP

HS1260T10	Grade 1 Laminate	\$ 6537	\$ 6654	\$ 7774
	Grade 2 Laminate	\$ 6723	\$ 6840	\$ 7960
	Grade 1 Veneer	\$ 7651	\$ 7768	\$ 8888
	Grade 2 Veneer	\$ 8611	\$ 8728	\$ 9848

1 TAP

HS1260T11	Grade 1 Laminate	\$ 7846	\$ 7963	\$ 9083
	Grade 2 Laminate	\$ 8032	\$ 8149	\$ 9269
	Grade 1 Veneer	\$ 8960	\$ 9077	\$10,197
	Grade 2 Veneer	\$ 9920	\$10,037	\$11,157

2 TAPS

HS1260T12	Grade 1 Laminate	\$ 9156	\$ 9273	\$10,393
	Grade 2 Laminate	\$ 9342	\$ 9459	\$10,579
	Grade 1 Veneer	\$10,270	\$10,387	\$11,507
	Grade 2 Veneer	\$11,230	\$11,347	\$12,467

3 TAPS

HS1260T13	Grade 1 Laminate	\$10,466	\$10,583	\$11,703
	Grade 2 Laminate	\$10,652	\$10,769	\$11,889
	Grade 1 Veneer	\$11,580	\$11,697	\$12,817
	Grade 2 Veneer	\$12,540	\$12,657	\$13,777

▶ Specification Information, continued on next page



For Canadian Pricing
 Multiply U.S. Price by the Canadian price factor.
 ▶ See page 1 for details.

Host Collection Trapezoid Tables with Two Bases *continued*

DESIGN F/P DESIGN AND VECTA DESIGN TEAM

Tip: Prices shown include top, TAP(s), and slim bases.
 ▶ See base options for flared bases, page 456

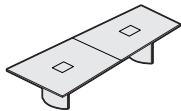
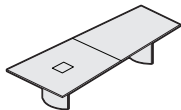
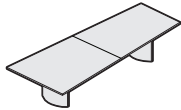

Tip: Last digit of style number indicates number of TAP(s).

Tip: For tech corridor, 12'L tables have four long doors and four short doors.



► Specification Information, continued from previous page

Specification Information

Style Number	Finish	U.S. Base Prices		
				
		Flat Wood Edge:	Bullnose Wood Edge:	Horizon Wood Edge:

12'L x 42"W x 60"W Two Piece Top

0 TAP

Style Number	Finish	Flat Wood Edge	Bullnose Wood Edge	Horizon Wood Edge
HS1260T20	Grade 1 Laminate	\$ 6850	\$ 6967	\$ 8087
	Grade 2 Laminate	\$ 7036	\$ 7153	\$ 8273
	Grade 1 Veneer	\$ 7964	\$ 8081	\$ 9201
	Grade 2 Veneer	\$ 8924	\$ 9041	\$10,161

1 TAP

Style Number	Finish	Flat Wood Edge	Bullnose Wood Edge	Horizon Wood Edge
HS1260T21	Grade 1 Laminate	\$ 8160	\$ 8277	\$ 9397
	Grade 2 Laminate	\$ 8346	\$ 8463	\$ 9583
	Grade 1 Veneer	\$ 9274	\$ 9391	\$10,511
	Grade 2 Veneer	\$10,234	\$10,351	\$11,471

2 TAPS

Style Number	Finish	Flat Wood Edge	Bullnose Wood Edge	Horizon Wood Edge
HS1260T22	Grade 1 Laminate	\$ 9470	\$ 9587	\$10,707
	Grade 2 Laminate	\$ 9656	\$ 9773	\$10,893
	Grade 1 Veneer	\$10,584	\$10,701	\$11,821
	Grade 2 Veneer	\$11,544	\$11,661	\$12,781



For Canadian Pricing
 Multiply U.S. Price by the Canadian price factor.
 ▶ See page 1 for details.

Floor Kit: Connectrac

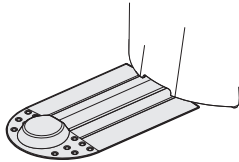

Tip: Shipped knocked down.

Standard Includes	Required to Specify
<p>▶ Need help? Product details, page 322</p> <ul style="list-style-type: none"> • Dome to cover floor monument (maximum size 5⁹/₁₀"W X 5⁹/₁₀"L X 3"H): black plastic • Low profile aluminum/PVC raceway to conceal wires from the dome to the table base <ul style="list-style-type: none"> - Aluminum raceway and removable aluminum cap for carpet strip: natural - Rigid PVC ramps run along both sides of raceway: black - Standard 4 foot length - Raceway can be field-cut to desired length • U.L. listed • ADA compliant 	<p>Style number</p>

Specification Information

Style Number	U.S. Price
HSFCON	\$479

Corridor Shelf

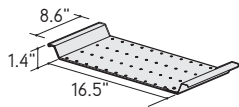

Standard Includes	Required to Specify
<p>▶ Need help? Product details, page 322</p> <ul style="list-style-type: none"> • Perforated steel shelf in silver power coat • Hangs from the lower rail on the beams to hold routers, hubs, line drivers, scalers and other technical equipment • 1/2" rack units of space, 2³/₄"H • Shipped assembled with adjustment screws 	<p>Style number</p>

Specification Information

Style Number	U.S. Price
HSFSHLF	\$81



For Canadian Pricing
 Multiply U.S. Price by the Canadian price factor.
 ▶ See page 1 for details.

Six Outlet Plug Strip

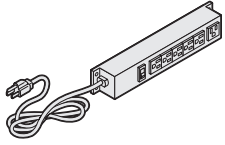

	Standard Includes	Required to Specify
▶ Need help? Product details, page 322	<ul style="list-style-type: none"> • Power strip with 15' cord and three-prong plug; black • Six power outlets • On-off switch • Surge suppressor • Dual lock adhesive strips for tech corridor installation 	Style number

Specification Information

Style Number	U.S. Price
793330	\$192

Corridor Power Kit, Modular

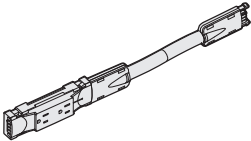

	Standard Includes	Required to Specify
▶ Need help? Product details, page 322	<ul style="list-style-type: none"> • Modular duplex receptacle • Dual lock adhesive strip 	Style number

Specification Information

Style Number	U.S. Price
HS4WXFRM	\$85

Tip: Corridor power kit can only be used when modular TAPs are specified.



For Canadian Pricing
 Multiply U.S. Price by the Canadian price factor.
 ▶ See page 1 for details.