



### Specifications

Sectional seating and tables designed with multiple back and side options of different height, thickness and material. Maple, Option A Exotic veneers and laminate are available on the back and sides. Differing heights and thicknesses create varying levels of privacy for the end user and can add architectural interest to large spaces. A flat back design allows the designer to specify the sections back-to-back. Formaldehyde free Catalyzed Polyurethane in all Cumberland finishes. An optional 0.5" solid surface top is also available on all thick walls or table surfaces. These products have been independently certified to meet or exceed ANSI/BIFMA X7.1/LEED EQ4.5 standards and as such can be used for LEED points. Seat depth is 20.75"



### Options – Specify:

- Top:** Maple veneer self-edge tops are standard. Thick walls are also available with a 0.5" Glacier White Solid Surface with an eased edge and matte finish.
- Wood:** Maple veneer is standard; Option A Exotic Veneers may be specified at an additional charge. Laminate is available upon special request.
- Corner Units:** Each Upholstered Corner Unit must be specified as Left Side Facing (LSF) or Right Side Facing (RSF).
- Finishes:** Standard and custom finishes with formaldehyde free Catalyzed Polyurethane topcoat. Cerused finishes are available on Ash for an additional charge of \$140 list per item. Note: All seating has a 1" wood platform at the bottom; so all pieces will require a finish choice.
- Metal:** Polished or Satin Stainless Steel. Statuary Bronze is available for an additional charge of \$375 list per item.
- Armrests:** Optional armrests can be attached to the end of any straight 1, 2 or 3 seat section. Specify as LSF, RSF or both sides. Additional cost of \$295 for each arm. These use the same fabric as specified on the seat and same metal finish as specified on legs.

### Overview and Application

#### Walls

- Back and side walls are Maple veneer. Option A exotic woods and laminate can also be specified. Option A exotic veneers have an upcharge.
- 4 heights; Bench-17", Chair-29", and 41" and 51" Walls.
- Two thicknesses of walls; thin is 1" and is the lower cost alternative. Thick are 7" and allows a more creative use of space as well as creating additional work surfaces for study or work materials.
- Different walls heights can be ganged together if that is the desired look.
- All items can be ganged with each other, but generally speaking if the desired look is to have all the backs flush, use the Thin with Thin and Thick with Thick. You can put Thin to Thick, but the Thick backs will be offset by 6". The seats are all the same depth.

#### Solid Surface tops

- ½" Solid surface material is available as an option on top of all thick walls and table surfaces. This adds ½" to the overall height of the table or wall. On the thick walls, this ½" sticks up above the upholstery.
- Glacier White is the standard solid surface color. Other Corian solid surface colors are available and Grades A-D are in the price list as Special Color upcharges. For other grades and colors please call for pricing.

#### Armrest Option

- Optional armrests can be attached to the end of any straight 1, 2 or 3 seat section. Specify as LSF, RSF or both sides. This will transform 2745-2748 into lounge chairs, 2749-2752 into 2-seat sofas and 2753-2756 into 3-seat sofas. Additional cost of \$295 for each arm. These use the same fabric as specified on the seat and same metal finish as specified on legs.

# Thick and Thin Modular

## Power Data Options

- **Table Top Power Data** is available in Satin, Polished or Statuary Bronze metal finishes. Unit contains 2-grounded simplex outlets, 15-amp circuit, (2) R45 cat 6 Data jacks, (1) RJ11 cat 3-phone jack, (1)- 3.5 mm stereo jack and (1) 15-pin VGA connector. All units have convenience receptacles for daisy chaining of multiple units. The device has a 10' power cord as a standard, but can be hard wired as an option upon request at no upcharge. Electrical connections and additional modules by customer. Unit is located in the center of the table.
- **Under Seat Mount Power Data** is only available in a black finish and contains (2) grounded simplex outlet, 15-amp circuit. The device has a 6' power cord and is not available hardwired. This unit is shipped loose and installed at job site in the desired location.
- **Ganged Airport Seating Power Data Arm** is available as an arm option. It is available in matte silver or black finish. Unit contains 2-grounded simplex outlets, 15-amp circuit, (1) USB Port, powered. The outlets have a 6' cord and the USB cord is 4' in length. Hardwiring is available as an option.

## Ganging Mechanisms and Installation Notes

- Each Thick & Thin item will ship with two ganging mechanisms by default.
- Ganging mechanisms, attached laptops, under seat power/data are all installed on site. Assembly instructions are provided.
- All items are shipped with levelers. Items will need to be leveled for the gaps between adjacent walls to be minimized and flush. Items need to be leveled before engaging ganging mechanisms.
- Inside Curved sections are quite large and ship assembled. Please check all entry clearances before ordering.

## Airport Seating

- Ganged seating allows for an infinite ganging of sections with a wide arm divider allowing a greater sense of privacy. The power data option with (2) 110 outlets and a powered USB port built into the arm allows users to power their laptops and charge PDAS and mobile phones.
- The Arm Dividers are options, (with and without power data) and need to be specified as a part number on orders.

## Overview and Features

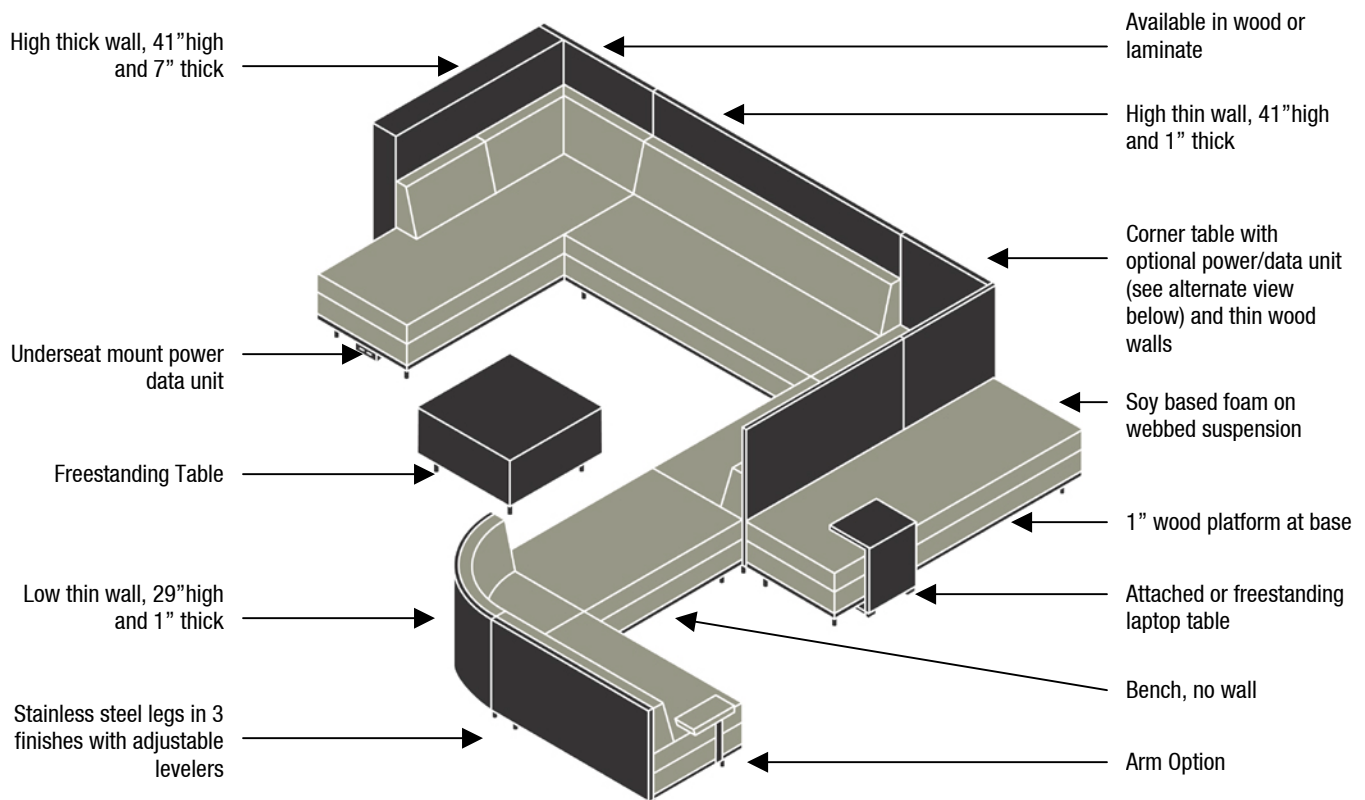

## Corner Unit Fabric Directions

In order to create a consistent pattern across seats in the configuration, 90 degree square or curved seating with corner units using directional patterned or striped fabric should have the direction of the fabric specified in writing and with a sketch at the time of order. Each corner unit needs to be described as either a Left Side Facing (LSF) or a Right Side Facing (RSF). In the absence of specific instructions, Cumberland reserves the right to upholster units at our discretion and we cannot guarantee a match with the configuration that you are using.

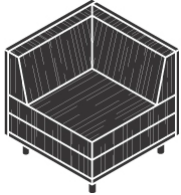

**Left Side Facing  
Fabric Orientation**

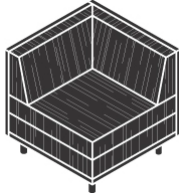

**Right Side Facing  
Fabric Orientation**

## Fabric Orientation and Direction

The default direction of a directional patterned or striped fabric on the seat is always front to back on the seat and up and down on the backs. On all three-seat sectionals with any directional patterned or striped fabric, the stripe will run back to front.

## Multiple Fabric Charges

Multiple fabrics may be specified on the seat and the back; a \$125 list price upcharge applies. Please provide a sketch or signify clearly on the order, which fabric is the back and which is the seat. When specifying multiple fabrics in different price groups, the higher price material will be used for calculating the price. Note: The vertical seat face cannot be specified in a different material than the seat top.

## Yardage Calculations

Yardage amounts are based on fabric that is plain (i.e. non-directional) and a full 54" width. Large repeats may affect the quantity of the fabric that is needed.

## Fabric and Leather Stretching

Some fabrics and all leathers naturally stretch with use and seat fabric tautness will vary depending upon the amount of stretch in the fabric/leather. Because of this natural stretch, the seat may appear loose with comfort wrinkles over time. We have engineered the products to minimize this, but in some cases and with some fabrics and leathers this is unavoidable and not the fault of manufacturing.

## Fire Code Seating

Our upholstery standard is to meet the requirements set forth in the State of California Bureau of Home Furnishings and Thermal Insulations Technical Bulletin 117. However for an additional charge we will add the required materials to meet the requirements set forth in the State of California Bureau of Home Furnishings and Thermal Insulations Technical Bulletin 133. Those upcharges are shown below in list price per item. If product testing or testing documentation is required an additional charge will apply.

# Thick and Thin Modular

## Information required to specify

1. Model Number: \_\_\_\_\_
2. Description: \_\_\_\_\_
3. Quantity: \_\_\_\_\_
4. Wood Species/Laminate: \_\_\_\_\_
5. Seat Fabric/Leather: \_\_\_\_\_
6. Corner Fabric Orientation: \_\_\_\_\_
7. Metal Finish: \_\_\_\_\_
8. Wood Finish Color: \_\_\_\_\_

## Standard Includes

1. Maple veneer in any of our standard finishes
2. Metal Legs in Polished or Satin stainless steel
3. Matching seat and back Fabric/Leather
4. CAL117 Fire Code

## Options

Numerous options exist for each piece. Determine the options using the list below and add to your specification.

## Seating Options and Upcharges

1. Veneer Species: \_\_\_\_\_
  - a. Option A Exotic Veneer: \_\_\_\_\_ Add upcharge from Item Price Matrix
2. Fabric Orientation on Corner Units:
  - a. Left Side Facing Corner Unit: \_\_\_\_\_ Add suffix LSF to Model Number
  - b. Right Side Facing Corner Unit: \_\_\_\_\_ Add suffix RSF to Model Number
3. Metal Finish: \_\_\_\_\_
  - a. Statuary Bronze: \_\_\_\_\_ Add \$375 upcharge to item price
4. Arm Rest Option:
  - a. Left Side Facing, Qty 1: \_\_\_\_\_ Specify model 2744-LSF, +\$295
  - b. Right Side Facing, Qty 1: \_\_\_\_\_ Specify model 2744-RSF, +\$295
  - c. Left and Right Side, Qty 2: \_\_\_\_\_ Specify model 2744-LR, +\$590
5. Contrasting Back Fabric/Leather:
  - a. Back Cushion Yardage (0-1.25 yards per piece): \_\_\_\_\_ Add \$150 upcharge to item price
  - b. Back Cushion Yardage (1.26-2.74 yards per piece): \_\_\_\_\_ Add \$175 upcharge to item price
  - c. Back Cushion Yardage (2.75-3.5 yards per piece): \_\_\_\_\_ Add \$200 upcharge to item price
6. Power/Data:
  - a. Under Seat Mount, Power Only, Black: \_\_\_\_\_ Specify model 2801, +\$350
7. Solid Surface Top for Thick Wall:
  - a. Glacier White Solid Surface: \_\_\_\_\_ Add upcharge from Item Price Matrix
  - b. Grade A-D Corian (Special Solid Surface): \_\_\_\_\_ Add upcharge from Item Price Matrix
8. CAL133 Fire Code:
  - a. Back Cushion Yardage (0-1.25 yards per piece): \_\_\_\_\_ Specify CAL133, +\$165 upcharge to item price
  - b. Back Cushion Yardage (1.26-2.74 yards per piece): \_\_\_\_\_ Specify CAL133, +\$266 upcharge to item price
  - c. Back Cushion Yardage (2.75-3.5 yards per piece): \_\_\_\_\_ Specify CAL133, +\$365 upcharge to item price
9. Bolsters:
  - a. Bolster, Qty 1: \_\_\_\_\_ Specify model 2799, See Item Price Matrix

## Table Options and Upcharges

1. Veneer Species: \_\_\_\_\_
  - a. Option A Exotic Veneer: \_\_\_\_\_ Use Option A Price from Item Price Matrix
2. Metal Finish: \_\_\_\_\_
  - a. Statuary Bronze: \_\_\_\_\_ Add \$375 upcharge to item price
3. Solid Surface Top for Thick Wall:
  - a. Glacier White Solid Surface: \_\_\_\_\_ Add upcharge from Item Price Matrix
  - b. Grade A-D Corian (Special Solid Surface): \_\_\_\_\_ Add upcharge from Item Price Matrix
4. Solid Surface top for Table Top Surface:
  - a. Glacier White Solid Surface: \_\_\_\_\_ Add upcharge from Item Price Matrix
  - b. Grade A-D Corian (Special Solid Surface): \_\_\_\_\_ Add upcharge from Item Price Matrix
5. Power/Data:
  - a. Under Seat Mount, Power Only, Black: \_\_\_\_\_ Specify model 2801, +\$350
  - b. Table Top Power/Data; finish matches legs: \_\_\_\_\_ Specify model 2802, +\$575

## Airport Seating Options and Upcharges

1. Armrest:
  - a. Non-Powered: \_\_\_\_\_ Specify Model 2798, +\$200
  - b. Powered, Black or Silver Unit: \_\_\_\_\_ Specify Model 2804 and Unit Color, +\$675

# Thick and Thin Modular

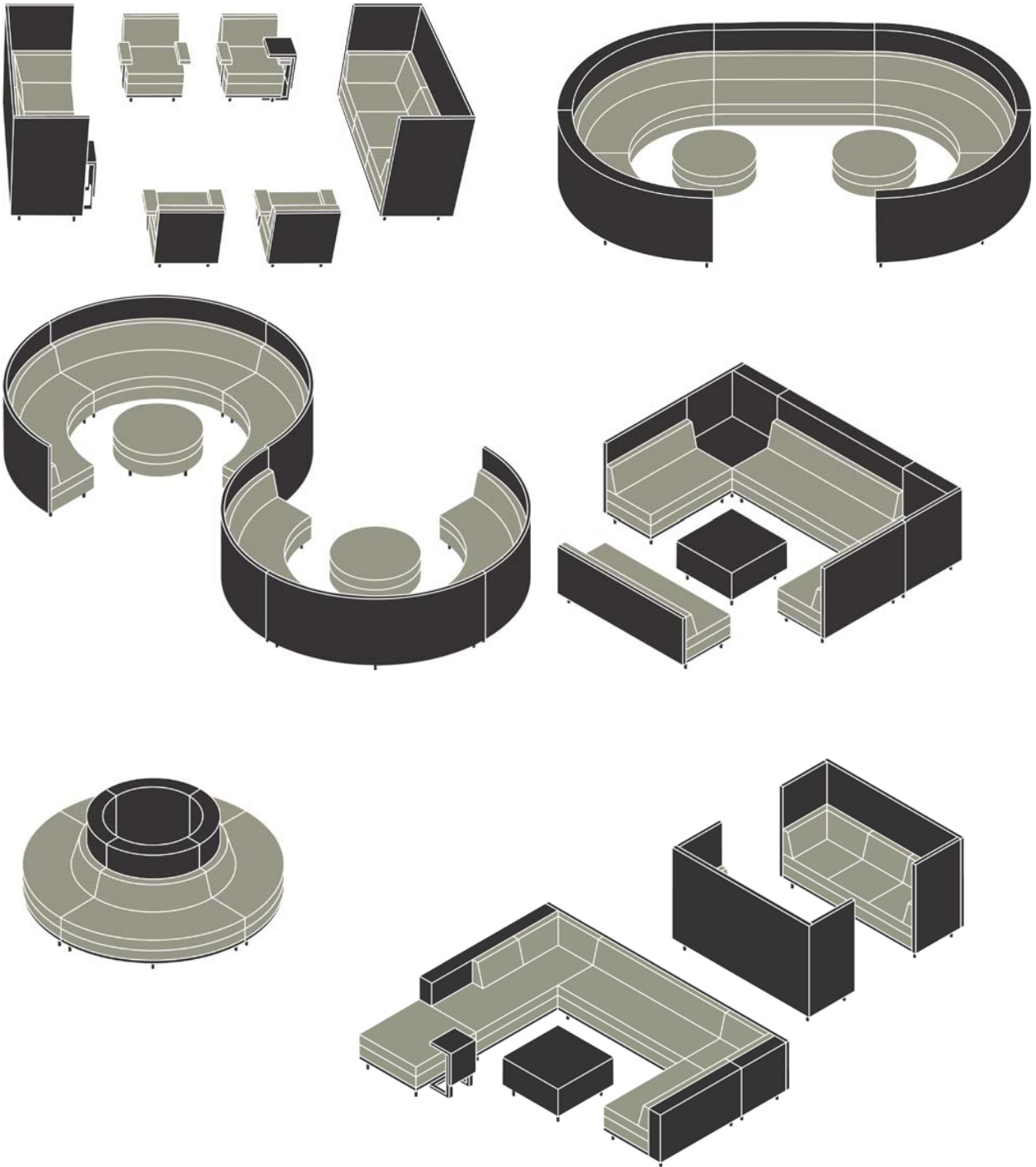

## Thick and Thin Modular

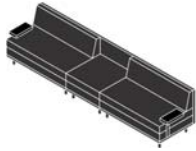

Model	Description	Price
2744	T&T ARM OPTION, LSF & RSF	590
2749	T&T DOUBLE SEAT, 29", THIN BACK.	1750
2784	T&T TABLE,SMALL, 29" THIN BACK.	1675
2749	T&T DOUBLE SEAT, 29", THIN BACK.	1750
2744	T&T ARM OPTION, UNIVERSAL	295
		<b>6060</b>



Model	Description	Price
2760	T&T DOUBLE SEAT BENCH,SMALL, FOR THIN WALLS.	1290
2719	T&T CORNER ,CURVED,29",90 DEG.,THIN BACK.	1890
2749	T&T DOUBLE SEAT, 29", THIN BACK.	1750
		<b>4930</b>

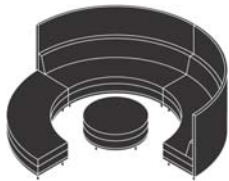



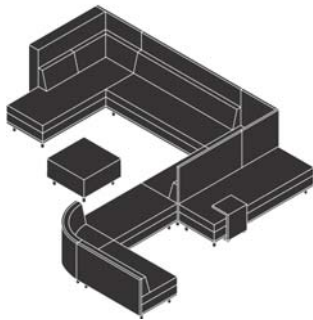

















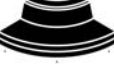





























Model	Description	Price
2733	T&T CORNER,LRG., IN. CURVE, 51", 90 DEG.,THIN WALL.	4490
2733	T&T CORNER,LRG., IN. CURVE, 51", 90 DEG.,THIN WALL.	4490
2728	T&T CORNER,LRG., IN. CURVE, 17", 90 DEG., BENCH.	1795
2764	T&T BENCH /OTTOMAN, 40" ROUND.	1400
		<b>12175</b>

















































Model	Description	Price
2749	T&T DOUBLE SEAT, 29", THIN BACK.	1750
2719	T&T CORNER ,CURVED,27",90 DEG.,THIN BACK..	1890
2760	T&T DOUBLE SEAT BENCH,SMALL, FOR THIN WALLS.	1290
2792	T&T TABLE,LAPTOP, ATTACHED.	1100
2762	T&T TRIPLE SEAT BENCH,SMALL, FOR THIN WALLS.	1690
2751	T&T DOUBLE SEAT, 41", THIN BACK.	2110
2768	T&T TABLE,SQ CORNER,41", THIN END AND BACK.	1975
2802	T&T PWR/DATA,6" SQ BOX FOR TABLE TOP MOUNTING.	575
2755	T&T TRIPLE SEAT, 41", THIN BACK	2990
2716	T&T CORNER,3SEAT,41", RH,PARTIAL THICK BACK,THIN END.	4300
2801	T&T PWR/DATA BOX, UNDERSEAT MOUNT.	350
2780	T&T TABLE,SQUARE,SMALL,NO BACK WALL.	1495
		<b>21515</b>

\*List Price, Listed in order from front to back

# Thick and Thin Modular

Square Corner Sections	Triple Seat Corner Sections	Curved Corner Sections	Inside Curved Sections	Outside Curved Sections	Straight Sections	Straight Sections Cont.
 2700	 2710	 2719	 2728	 2736	 2745	 2753
 2701	 2711	 2720	 2729	 2737	 2746	 2754
 2702	 2712	 2721	 2730	 2738	 2747	 2755
 2703	 2713	 2722	 2731	 2739	 2748	 2756
 2705	 2714	 2723	 2732	 2740	 2749	Privacy Sofa
 2706	 2715	 2724	 2733	 2741	 2750	 2794
 2707	 2716	 2725	 2734	 2742	 2751	
 2708	 2717	 2726		 2743	 2752	

# Thick and Thin Modular

Benches	Square Corner Tables	Curved Corner Tables	Straight Tables	Tables	Accessories	Airport Seating
 2758	 2766	 2771	 2784	 2779	Armrest  2744	 2795
 2759	 2805	 2772	 2785	 2780	Bolster  2799	 2797
 2760	 2806	 2773	 2786	 2781	Underseat Power  2801	 2796
 2761	 2767	 2774	 2787	 2782	Table Power  2802	Airport Armrest  2798
 2762	 2768	 2775		 2783	Attached Laptop Table  2792	Airport Armrest with Power  2804
 2763	 2807	 2776		 2789	Freestanding Laptop Table  2793	
 2764	 2809	 2777		 2790		
 2728	 2769	 2778		 2791		

Square Corner Units with Thick on one side and Thin on the other will allow for a transition from Thick walls to Thin walls at a corner. The default direction of a directional patterned or striped fabric on the seat is always front to back on the seat and up and down on the backs.

**Unique Product Options – Specify:**

- Fabric: In order to create a consistent pattern across seats in the configuration each corner unit needs to be described as either a Left Side Facing (LSF) or a Right Side Facing (RSF).
- Top: Thick walls can be specified with a ½" Corian top surface.

Model	Description	Yards			Fabric Grades					Veneer Upcharge	
		Back	Seat	Total	COM	1	2	3	4	Opt A Exotic Woods	
2700	1-Seat Corner, 29" Thin Back	1.75	2	3.75	1850	2236	2428	2619	2810	518	
		Sq Feet			Leather					Solid Surface Upcharge	
	Dimensions	Back	Seat	Total	COL	S	B			Std White	Special Color
	28"w x 28"d x 29"h	32	36	68	2128	4426	4594			N/A	N/A

Model	Description	Yards			Fabric Grades					Veneer Upcharge	
		Back	Seat	Total	COM	1	2	3	4	Opt A Exotic Woods	
2701	1-Seat Corner, 29" Thick LSF & Thin RSF Back	1.75	2	3.75	2260	2646	2838	3029	3220	633	
		Sq Feet			Leather					Solid Surface Upcharge	
	Dimensions	Back	Seat	Total	COL	S	B			Std White	Special Color
	34"w x 28"d x 29"h	32	36	68	2599	4897	5065			175	238

Model	Description	Yards			Fabric Grades					Veneer Upcharge	
		Back	Seat	Total	COM	1	2	3	4	Opt A Exotic Woods	
2702	1-Seat Corner, 29" Thin LSF & Thick RSF Back	1.75	2	3.75	2260	2646	2838	3029	3220	633	
		Sq Feet			Leather					Solid Surface Upcharge	
	Dimensions	Back	Seat	Total	COL	S	B			Std White	Special Color
	28"w x 34"d x 29"h	32	36	68	2599	4897	5065			175	

Model	Description	Yards			Fabric Grades					Veneer Upcharge	
		Back	Seat	Total	COM	1	2	3	4	Opt A Exotic Woods	
2703	1-Seat Corner, 29" Thick Back	1.75	2	3.75	2830	3216	3408	3599	3790	792	
		Sq Feet			Leather					Solid Surface Upcharge	
	Dimensions	Back	Seat	Total	COL	S	B			Std White	Special Color
	34"w x 34"w x 29"h	32	36	68	3255	5553	5721			350	475

# Thick and Thin Modular

Model	Description	Yards			Fabric Grades					Veneer Upcharge		
		Back	Seat	Total	COM	1	2	3	4	Opt A	Exotic Woods	
2705	1-Seat Corner, 41" Thin Back	1.75	2	3.75	2450	2836	3028	3219	3410	686		
		Sq Feet			Leather					Solid Surface Upcharge		
	<b>Dimensions</b>	Back	Seat	Total	COL	S	B				Std White	Special Color
	28"w x 28"d x 41"h	32	36	68	2818	5116	5284				N/A	N/A



Model	Description	Yards			Fabric Grades					Veneer Upcharge		
		Back	Seat	Total	COM	1	2	3	4	Opt A	Exotic Woods	
2706	1-Seat Corner, 41" Thick LSF & Thin RSF Back	1.75	2	3.75	2850	3236	3428	3619	3810	798		
		Sq Feet			Leather					Solid Surface Upcharge		
	<b>Dimensions</b>	Back	Seat	Total	COL	S	B				Std White	Special Color
	34"w x 28"d x 41"h	32	36	68	3278	5576	5744				175	238



Model	Description	Yards			Fabric Grades					Veneer Upcharge		
		Back	Seat	Total	COM	1	2	3	4	Opt A	Exotic Woods	
2707	1-Seat Corner, 41" Thin LSF & Thick RSF Back	1.75	2	3.75	2850	3236	3428	3619	3810	798		
		Sq Feet			Leather					Solid Surface Upcharge		
	<b>Dimensions</b>	Back	Seat	Total	COL	S	B				Std White	Special Color
	28"w x 34"d x 41"h	32	36	68	3278	5576	5744				175	238



Model	Description	Yards			Fabric Grades					Veneer Upcharge		
		Back	Seat	Total	COM	1	2	3	4	Opt A	Exotic Woods	
2708	1-Seat Corner, 41" Thick Back	1.75	2	3.75	3550	3936	4128	4319	4510	994		
		Sq Feet			Leather					Solid Surface Upcharge		
	<b>Dimensions</b>	Back	Seat	Total	COL	S	B				Std White	Special Color
	34"w x 34"w x 41"h	32	36	68	4083	6381	6549				350	475





To avoid the caterpillar effect with sectionals, Thick & Thin sofas, chaises and benches are offered in 2 and 3 seat sections. Triple seat sectionals are available with a partial length back wall or a full-length back wall. The partial back wall is a more economical choice if the back wall does not need to be extended beyond the section. Partial or full wall sectionals can be ganged with seat, table or bench units. On all three-seat sectionals with any directional patterned or striped fabric, the stripe or pattern will run back to front.

**Unique Product Options – Specify:**

Top: Thick walls can be specified with a ½" Corian top surface.

Model	Description	Yards			Fabric Grades					Veneer Upcharge	
		Back	Seat	Total	COM	1	2	3	4	Opt A	Exotic Woods
2710	3-Seat LH Corner, 29"	2.5	4.5	7	3470	4191	4548	4905	5262	972	
	Thin End & Partial										
	Thick Back	Sq Feet			Leather			Solid Surface Upcharge			
	Dimensions	Back	Seat	Total	COL	S	B	Std White	Special Color		
	76"w x 34"d x 29"h	45	72	117	3991	7438	7690	280	380		

Model	Description	Yards			Fabric Grades					Veneer Upcharge	
		Back	Seat	Total	COM	1	2	3	4	Opt A	Exotic Woods
2711	3-Seat LH Corner, 29"	2.5	4.5	7	3980	4701	5058	5415	5772	1114	
	Thin End & Full Thick										
	Back	Sq Feet			Leather			Solid Surface Upcharge			
	Dimensions	Back	Seat	Total	COL	S	B	Std White	Special Color		
	76"w x 34"d x 29"h	45	72	117	4577	8024	8276	315	428		

Model	Description	Yards			Fabric Grades					Veneer Upcharge	
		Back	Seat	Total	COM	1	2	3	4	Opt A	Exotic Woods
2712	3-Seat LH Corner, 41"	2.5	4.5	7	4300	5021	5378	5735	6092	1204	
	Thin End & Partial										
	Thick Back	Sq Feet			Leather			Solid Surface Upcharge			
	Dimensions	Back	Seat	Total	COL	S	B	Std White	Special Color		
	76"w x 34"d x 41"h	45	72	117	4945	8392	8644	280	380		

Model	Description	Yards			Fabric Grades					Veneer Upcharge	
		Back	Seat	Total	COM	1	2	3	4	Opt A	Exotic Woods
2713	3-Seat LH Corner, 41"	2.5	4.5	7	4690	5411	5768	6125	6482	1313	
	Thin End & Full Thick										
	Back	Sq Feet			Leather			Solid Surface Upcharge			
	Dimensions	Back	Seat	Total	COL	S	B	Std White	Special Color		
	76"w x 34"d x 41"h	45	72	117	5394	8841	9093	315	428		

# Thick and Thin Modular

Model	Description	Yards			Fabric Grades					Veneer Upcharge	
		Back	Seat	Total	COM	1	2	3	4	Opt A	Exotic Woods
2714	3-Seat RH Corner, 29" Thin End & Partial	2.5	4.5	7	3470	4191	4548	4905	5262	972	
	Thick Back	Sq Feet			Leather					Solid Surface Upcharge	
	Dimensions	Back	Seat	Total	COL	S	B			Std White	Special Color
	76"w x 34"d x 29"h	45	72	117	3991	7438	7690			280	380
2715	3-Seat RH Corner, 29" Thin End & Full Thick	2.5	4.5	7	3980	4701	5058	5415	5772	1114	
	Back	Sq Feet			Leather					Solid Surface Upcharge	
	Dimensions	Back	Seat	Total	COL	S	B			Std	Special
	76"w x 34"d x 29"h	45	72	117	4577	8024	8276			315	428
2716	3-Seat RH Corner, 41" Thin End & Partial	2.5	4.5	7	4300	5021	5378	5735	6092	1204	
	Thick Back	Sq Feet			Leather					Solid Surface Upcharge	
	Dimensions	Back	Seat	Total	COL	S	B			Std	Special
	76"w x 34"d x 41"h	45	72	117	4945	8392	8644			280	380
2717	3-Seat RH Corner, 41" Thin End & Full Thick	2.5	4.5	7	4690	5411	5768	6125	6482	1313	
	Back	Sq Feet			Leather					Solid Surface Upcharge	
	Dimensions	Back	Seat	Total	COL	S	B			Std	Special
	76"w x 34"d x 41"h	45	72	117	5394	8841	9093			315	428

Available in either 90 or 45-degree sections. 29" and 41" walls can be ganged together, if that is the desired effect. The default direction of a directional patterned or striped fabric on the seat is always front to back on the seat and up and down on the backs.

**Unique Product Options – Specify:**

Fabric: In order to create a consistent pattern across seats in the configuration each corner unit needs to be described as either a Left Side Facing (LSF) or a Right Side Facing (RSF).

Top: Thick walls can be specified with a ½" Corian top surface.

Model	Description	Yards			Fabric Grades				Veneer Upcharge	
		Back	Seat	Total	COM	1	2	3	4	Opt A Exotic Woods
2719	90° Curved Corner Seat, 29" Thin Back	1.25	3	4.25	1890	2328	2545	2761	2978	529
		Sq Feet			Leather			Solid Surface Upcharge		
	Dimensions	Back	Seat	Total	COL	S	B	Std White	Special Color	
	28"w x 28"d x 29"h	23	54	77	2174	4472	4640	N/A	N/A	

Model	Description	Yards			Fabric Grades				Veneer Upcharge	
		Back	Seat	Total	COM	1	2	3	4	Opt A Exotic Woods
2720	90° Curved Corner Seat, 29" Thick Back	1.25	3	4.25	2260	2698	2915	3131	3348	633
		Sq Feet			Leather			Solid Surface Upcharge		
	Dimensions	Back	Seat	Total	COL	S	B	Std White	Special Color	
	34"w x 34"d x 29"h	23	54	77	2599	4897	5065	420	570	

Model	Description	Yards			Fabric Grades				Veneer Upcharge	
		Back	Seat	Total	COM	1	2	3	4	Opt A Exotic Woods
2721	90° Curved Corner Seat, 41" Thin Back	1.25	3	4.25	2260	2698	2915	3131	3348	633
		Sq Feet			Leather			Solid Surface Upcharge		
	Dimensions	Back	Seat	Total	COL	S	B	Std White	Special Color	
	28"w x 28"d x 41"h	23	54	77	2599	4897	5065	N/A	N/A	

Model	Description	Yards			Fabric Grades				Veneer Upcharge	
		Back	Seat	Total	COM	1	2	3	4	Opt A Exotic Woods
2722	90° Curved Corner Seat, 41" Thick Back	1.25	3	4.25	2850	3288	3505	3721	3938	798
		Sq Feet			Leather			Solid Surface Upcharge		
	Dimensions	Back	Seat	Total	COL	S	B	Std White	Special Color	
	34"w x 34"d x 41"h	23	54	77	3278	5576	5744	420	570	

# Thick and Thin Modular

Model	Description	Yards			Fabric Grades					Veneer Upcharge	
		Back	Seat	Total	COM	1	2	3	4	Opt A	Exotic Woods
2723	45° Curved Corner Seat, 29" Thin Back	1.25	2.25	3.5	1200	1561	1739	1918	2096	336	
		Sq Feet			Leather					Solid Surface Upcharge	
	Dimensions	Back	Seat	Total	COL	S	B			Std White	Special Color
	28"w x 28"d x 29"h	22	40	62	1380	3678	3846			N/A	N/A
2724	45° Curved Corner Seat, 29" Thick Back	1.25	2.25	3.5	1695	2056	2234	2413	2591	475	
		Sq Feet			Leather					Solid Surface Upcharge	
	Dimensions	Back	Seat	Total	COL	S	B			Std White	Special Color
	34"w x 34"d x 29"h	22	40	62	1950	4248	4416			245	333
2725	45° Curved Corner Seat, 41" Thin Back	1.25	2.25	3.5	1780	2141	2319	2498	2676	498	
		Sq Feet			Leather					Solid Surface Upcharge	
	Dimensions	Back	Seat	Total	COL	S	B			Std White	Special Color
	28"w x 28"d x 41"h	22	40	62	2047	4345	4513			N/A	N/A
2726	45° Curved Corner Seat, 41" Thick Back	1.25	2.25	3.5	2330	2691	2869	3048	3226	652	
		Sq Feet			Leather					Solid Surface Upcharge	
	Dimensions	Back	Seat	Total	COL	S	B			Std White	Special Color
	34"w x 34"d x 41"h	22	40	62	2680	4978	5146			245	333

Inside Curved sections are quite large and ship assembled. Please check all entry clearances before ordering. All units have an inside radius of 40". The backless version has an outside radius of 67". The thin wall version has an outside radius of 68". The thick wall version has an outside radius of 74".

**Unique Product Options – Specify:**

Top: Thick walls can be specified with a ½" Corian top surface.

Model	Description	Yards			Fabric Grades					Veneer Upcharge	
		Back	Seat	Total	COM	1	2	3	4	Opt A	Exotic Woods
2728	90° Large Inside Curved Corner, Bench	0	6	6	1795	2413	2719	3025	3331	503	
		Sq Feet			Leather			Solid Surface Upcharge			
	<b>Dimensions</b>	Back	Seat	Total	COL	S	B	Std White	Special Color		
	95"w x 27"d x 17"h	0	110	110	2065	4363	4531	N/A	N/A		







Model	Description	Yards			Fabric Grades					Veneer Upcharge	
		Back	Seat	Total	COM	1	2	3	4	Opt A	Exotic Woods
2729	90° Large Inside Curved Corner, 29" Thin Back	3.25	5	8.25	2275	3125	3546	3966	4387	637	
		Sq Feet			Leather			Solid Surface Upcharge			
	<b>Dimensions</b>	Back	Seat	Total	COL	S	B	Std White	Special Color		
	96"w x 28"d x 29"h	55	90	145	2617	6064	6316	N/A	N/A		



Model	Description	Yards			Fabric Grades					Veneer Upcharge	
		Back	Seat	Total	COM	1	2	3	4	Opt A	Exotic Woods
2730	90° Large Inside Curved Corner, 29" Thick Back	3.25	5	8.25	3850	4700	5121	5541	5962	1078	
		Sq Feet			Leather			Solid Surface Upcharge			
	<b>Dimensions</b>	Back	Seat	Total	COL	S	B	Std White	Special Color		
	105"w x 34"d x 29"h	55	90	145	4428	7875	8127	770	1045		



## Thick and Thin Modular

Model	Description	Yards			Fabric Grades					Veneer Upcharge		
		Back	Seat	Total	COM	1	2	3	4	Opt A	Exotic Woods	
	2731	90° Large Inside	3.25	5	8.25	3390	4240	4661	5081	5502	949	
		Curved Corner, 41"										
		Thin Back	Sq Feet			Leather					Solid Surface Upcharge	
		Dimensions	Back	Seat	Total	COL	S	B	Std White	Special Color		
		96"w x 28"d x 41"h	55	90	145	3899	7346	7598	N/A	N/A		
	2732	90° Large Inside	3.25	5	8.25	4550	5400	5821	6241	6662	1274	
		Curved Corner, 41"										
		Thick Back	Sq Feet			Leather					Solid Surface Upcharge	
		Dimensions	Back	Seat	Total	COL	S	B	Std White	Special Color		
		105"w x 34"d x 41"h	55	90	145	5233	8680	8932	770	1045		
	2733	90° Large Inside	3.25	5	8.25	4490	5340	5761	6181	6602	1257	
		Curved Corner, 51"										
		Thin Back	Sq Feet			Leather					Solid Surface Upcharge	
		Dimensions	Back	Seat	Total	COL	S	B	Std White	Special Color		
		96"w x 28"d x 51"h	55	90	145	5164	8611	8863	N/A	N/A		
	2734	90° Large Inside	3.25	5	8.25	4950	5800	6221	6641	7062	1386	
		Curved Corner, 51"										
		Thick Back	Sq Feet			Leather					Solid Surface Upcharge	
		Dimensions	Back	Seat	Total	COL	S	B	Std White	Special Color		
		105"w x 34"d x 51"h	55	90	145	5693	9140	9392	770	1045		

Outside Curved sections are quite large and ship assembled. Please check all entry clearances before ordering. They are available in either 90 or 45-degree sections. All units have an outside radius of 55".

**Unique Product Options – Specify:**

Top: Thick walls can be specified with a ½" Corian top surface.

Model	Description	Yards			Fabric Grades					Veneer Upcharge	
		Back	Seat	Total	COM	1	2	3	4	Opt A	Exotic Wood
2736	90° Outside Curved Corner, 29" Thin Back	2	5.5	7.5	2175	2948	3330	3713	4095	609	
	<b>Dimensions</b>	<b>Sq Feet</b>			<b>Leather</b>			<b>Solid Surface Upcharge</b>			
		Back	Seat	Total	COL	S	B	Std White	Special Color		
	78"w x 28"d x 29"h	36	95	131	2502	5949	6201	N/A N/A			

Model	Description	Yards			Fabric Grades					Veneer Upcharge	
		Back	Seat	Total	COM	1	2	3	4	Opt A	Exotic Wood
2737	90° Outside Curved Corner, 29" Thick Back	2	5.5	7.5	3750	4523	4905	5288	5670	1050	
	<b>Dimensions</b>	<b>Sq Feet</b>			<b>Leather</b>			<b>Solid Surface Upcharge</b>			
		Back	Seat	Total	COL	S	B	Std White	Special Color		
	78"w x 34"d x 29"h	36	95	131	4313	7760	8012	420 570			

Model	Description	Yards			Fabric Grades					Veneer Upcharge	
		Back	Seat	Total	COM	1	2	3	4	Opt A	Exotic Wood
2738	90° Outside Curved Corner, 41" Thin Back	2	5.5	7.5	3290	4063	4445	4828	5210	921	
	<b>Dimensions</b>	<b>Sq Feet</b>			<b>Leather</b>			<b>Solid Surface Upcharge</b>			
		Back	Seat	Total	COL	S	B	Std White	Special Color		
	78"w x 28"d x 41"h	36	95	131	3784	7231	7483	N/A N/A			

Model	Description	Yards			Fabric Grades					Veneer Upcharge	
		Back	Seat	Total	COM	1	2	3	4	Opt A	Exotic Wood
2739	90° Outside Curved Corner, 41" Thick Back	2	5.5	7.5	4450	5223	5605	5988	6370	1246	
	<b>Dimensions</b>	<b>Sq Feet</b>			<b>Leather</b>			<b>Solid Surface Upcharge</b>			
		Back	Seat	Total	COL	S	B	Std White	Special Color		
	78"w x 34"d x 41"h	36	95	131	5118	8565	8817	420 570			

# Thick and Thin Modular

Model	Description	Yards			Fabric Grades					Veneer Upcharge	
		Back	Seat	Total	COM	1	2	3	4	Opt A	Exotic Woods
 2740	45° Outside Curved Corner, 29" Thin Back	1.5	3	4.5	1410	1874	2103	2333	2562	395	
		Sq Feet			Leather			Solid Surface Upcharge			
	Dimensions	Back	Seat	Total	COL	S	B	Std White	Special Color		
	42"w x 28"d x 29"h	28	27	55	1622	2771	2855	N/A	N/A		
 2741	45° Outside Curved Corner, 29" Thick Back	1.5	3	4.5	2100	2564	2793	3023	3252	588	
		Sq Feet			Leather			Solid Surface Upcharge			
	Dimensions	Back	Seat	Total	COL	S	B	Std White	Special Color		
	42"w x 34"d x 29"h	28	27	55	2415	3564	3648	245	331		
 2742	45° Outside Curved Corner, 41" Thin Back	1.5	3	4.5	2000	2464	2693	2923	3152	560	
		Sq Feet			Leather			Solid Surface Upcharge			
	Dimensions	Back	Seat	Total	COL	S	B	Std White	Special Color		
	42"w x 28"d x 41"h	28	27	55	2300	3449	3533	N/A	N/A		
 2743	45° Outside Curved Corner, 41" Thick Back	1.5	3	4.5	2600	3064	3293	3523	3752	728	
		Sq Feet			Leather			Solid Surface Upcharge			
	Dimensions	Back	Seat	Total	COL	S	B	Std White	Special Color		
	42"w x 34"d x 41"h	28	27	55	2990	4139	4223	245	331		

**Straight Sections**

Designed by Charlie Kane of XLG

**Thick and Thin Modular**

Straight sections are available in 24", 48" or 75" lengths.

**Unique Product Options – Specify:**

Top: Thick walls can be specified with a ½" Corian top surface.

Armrests: Optional armrests can be attached to the end of any straight 1, 2 or 3 seat section. Specify as LSF, RSF or both sides(LR). Arms use the same fabric as the seat and same metal as on legs.

Model	Description	Yards			Fabric Grades					Veneer Upcharge	
		Back	Seat	Total	COM	1	2	3	4	Opt A Exotic Woods	
 2745	Straight 1-Seat, 29" Thin Back	1.25	2	3.25	1295	1630	1796	1961	2127	363	
	<b>Dimensions</b>	<b>Sq Feet</b>			<b>Leather</b>					<b>Solid Surface Upcharge</b>	
	24"w x 28"d x 29"h	Back	Seat	Total	COL	S	B			Std White	Special Color
		27	36	63	1490	3788	3956			N/A	N/A

Model	Description	Yards			Fabric Grades					Veneer Upcharge	
		Back	Seat	Total	COM	1	2	3	4	Opt A Exotic Woods	
 2746	Straight 1-Seat, 29" Thick Back	1.25	2	3.25	1675	2010	2176	2341	2507	469	
	<b>Dimensions</b>	<b>Sq Feet</b>			<b>Leather</b>					<b>Solid Surface Upcharge</b>	
	24"w x 34"d x 29"h	Back	Seat	Total	COL	S	B			Std White	Special Color
		27	36	63	1927	4225	4393			140	190

Model	Description	Yards			Fabric Grades					Veneer Upcharge	
		Back	Seat	Total	COM	1	2	3	4	Opt A Exotic Woods	
 2747	Straight 1-Seat, 41" Thin Back	1.25	2	3.25	1405	1740	1906	2071	2237	393	
	<b>Dimensions</b>	<b>Sq Feet</b>			<b>Leather</b>					<b>Solid Surface Upcharge</b>	
	24"w x 28"d x 41"h	Back	Seat	Total	COL	S	B			Std White	Special Color
		27	36	63	1616	3914	4082			N/A	N/A

Model	Description	Yards			Fabric Grades					Veneer Upcharge	
		Back	Seat	Total	COM	1	2	3	4	Opt A Exotic Woods	
 2748	Straight 1-Seat, 41" Thick Back	1.25	2	3.25	1975	2310	2476	2641	2807	553	
	<b>Dimensions</b>	<b>Sq Feet</b>			<b>Leather</b>					<b>Solid Surface Upcharge</b>	
	24"w x 34"d x 41"h	Back	Seat	Total	COL	S	B			Std White	Special Color
		27	36	63	2272	4570	4738			140	190

Model	Description	Yards			Fabric Grades					Veneer Upcharge	
		Back	Seat	Total	COM	1	2	3	4	Opt A Exotic Woods	
 2749	Straight 2-Seat, 29" Thin Back	1.5	2.5	4	1750	2162	2366	2570	2774	490	
	<b>Dimensions</b>	<b>Sq Feet</b>			<b>Leather</b>					<b>Solid Surface Upcharge</b>	
	48"w x 28"d x 29"h	Back	Seat	Total	COL	S	B			Std White	Special Color
		30	42	72	2013	4311	4479			N/A	N/A

Model	Description	Yards			Fabric Grades					Veneer Upcharge	
		Back	Seat	Total	COM	1	2	3	4	Opt A Exotic Woods	
 2750	Straight 2-Seat, 29" Thick Back	1.5	2.5	4	2350	2762	2966	3170	3374	658	
	<b>Dimensions</b>	<b>Sq Feet</b>			<b>Leather</b>					<b>Solid Surface Upcharge</b>	
	48"w x 34"d x 29"h	Back	Seat	Total	COL	S	B			Std White	Special Color
		30	42	72	2703	5001	5169			280	380



**Benches**

Designed by Charlie Kane of XLG

# Thick and Thin Modular

Benches are available in 36", 48" and 75" lengths. All benches can be used separately or ganged. The 27" Depth benches align with the inside of both Thick and Thin walls. The 34" Depth benches align flush with the outside back of Thick walls.

Model	Description	Yards			Fabric Grades					Veneer Upcharge	
		Back	Seat	Total	COM	1	2	3	4	Opt A	Exotic Woods
2758	1-Seat Bench	0	3	3	975	1284	1437	1590	1743	273	



Dimensions	Sq Feet			Leather			Solid Surface Upcharge	
	Back	Seat	Total	COL	S	B	Std White	Special Color
36"w x 27"d x 17"h	0	60	60	1122	3420	3588	N/A	N/A

Model	Description	Yards			Fabric Grades					Veneer Upcharge	
		Back	Seat	Total	COM	1	2	3	4	Opt A	Exotic Woods
2759	1-Seat Bench for Thick Back	0	3	3	1075	1384	1537	1690	1843	301	



Dimensions	Sq Feet			Leather			Solid Surface Upcharge	
	Back	Seat	Total	COL	S	B	Std White	Special Color
36"w x 34"d x 17"h	0	60	60	1237	3535	3703	N/A	N/A

Model	Description	Yards			Fabric Grades					Veneer Upcharge	
		Back	Seat	Total	COM	1	2	3	4	Opt A	Exotic Woods
2760	2-Seat Bench	0	3	3	1290	1599	1752	1905	2058	361	





Dimensions	Sq Feet			Leather			Solid Surface Upcharge	
	Back	Seat	Total	COL	S	B	Std White	Special Color
48"w x 27"d x 17"h	0	60	60	1484	3782	3950	N/A	N/A

Model	Description	Yards			Fabric Grades					Veneer Upcharge	
		Back	Seat	Total	COM	1	2	3	4	Opt A	Exotic Woods
2761	2-Seat Bench for Thick Back	0	3	3	1590	1899	2052	2205	2358	445	

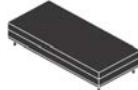

Dimensions	Sq Feet			Leather			Solid Surface Upcharge	
	Back	Seat	Total	COL	S	B	Std White	Special Color
48"w x 34"d x 17"h	0	60	60	1829	4127	4295	N/A	N/A

## Thick and Thin Modular

Model	Description	Yards			Fabric Grades					Veneer Upcharge	
		Back	Seat	Total	COM	1	2	3	4	Opt A	Exotic Woods
2762	3-Seat Bench	0	5	5	1690	2205	2460	2715	2970	473	
		Sq Feet			Leather					Solid Surface Upcharge	
	Dimensions	Back	Seat	Total	COL	S	B			Std White	Special Color
	75"w x 27"d x 17"h	0	95	95	1944	4242	4410			N/A	N/A
2763	3-Seat Bench for Thick Back	0	5	5	1790	2305	2560	2815	3070	501	
		Sq Feet			Leather					Solid Surface Upcharge	
	Dimensions	Back	Seat	Total	COL	S	B			Std White	Special Color
	75"w x 34"d x 17"h	0	95	95	2059	4357	4525			N/A	N/A
2764	Ottoman, 40" Round	0	4	4	1400	1812	2016	2220	2424	392	
		Sq Feet			Leather					Solid Surface Upcharge	
	Dimensions	Back	Seat	Total	COL	S	B			Std White	Special Color
	40"Dia x 17"h	0	80	80	1610	3908	4076			N/A	N/A
2728	90° Large Inside Curved Corner, Bench	0	6	6	1795	2413	2719	3025	3331	503	
		Sq Feet			Leather					Solid Surface Upcharge	
	Dimensions	Back	Seat	Total	COL	S	B			Std White	Special Color
	95"w x 27"d x 17"h	0	110	110	2065	4363	4531			N/A	N/A

Square Corner Table Units with Thick on one side and Thin on the other will allow for a transition from Thick walls to Thin walls at a corner.

**Unique Product Options – Specify:**

Top: Thick walls can be specified with a ½” Corian top surface.

Power/Data: Tables can be specified with an optional power data unit located in center of table.





Model	Description / Dimensions	Maple	Opt A	Glacier White Solid Surface		Special Color Solid Surface	
				Top Cap	Table Top	Top Cap	Table Top
2766	Sq Corner Table, 29" Thin Back	1675	2144	N/A	630	N/A	855
	 28"w x 28"d x 29"h						

Model	Description / Dimensions	Maple	Opt A	Glacier White Solid Surface		Special Color Solid Surface	
				Top Cap	Table Top	Top Cap	Table Top
2805	Sq Corner Table, 29" Thick LSF & Thin RSF Back	2260	2893	175	630	238	855
	 34"w x 28"d x 29"h						

Model	Description / Dimensions	Maple	Opt A	Glacier White Solid Surface		Special Color Solid Surface	
				Top Cap	Table Top	Top Cap	Table Top
2806	Sq Corner Table, 29" Thin LSF & Thick RSF Back	2260	2893	175	630	238	855
	 28"w x 34"d x 29"h						

Model	Description / Dimensions	Maple	Opt A	Glacier White Solid Surface		Special Color Solid Surface	
				Top Cap	Table Top	Top Cap	Table Top
2767	Sq Corner Table, 29" Thick Back	2475	3168	350	630	475	855
	 34"w x 34"d x 29"h						

## Thick and Thin Modular

Model	Description / Dimensions	Maple	Opt A	Glacier White Solid Surface		Special Color Solid Surface	
				Top Cap	Table Top	Top Cap	Table Top
2768	Sq Corner Table, 41" Thin Back	1975	2528	N/A	630	N/A	855
	 28"w x 28"d x 41"h						
2807	Sq Corner Table, 41" Thick LSF & Thin RSF Back	2560	3277	175	630	238	855
	 34"w x 28"d x 41"h						
2809	Sq Corner Table, 41" Thin LSF & Thick RSF Back	2560	3277	175	630	238	855
	 28"w x 34"d x 41"h						
2769	Sq Corner Table, 41" Thick Back	2960	3789	350	630	475	855
	 34"w x 34"d x 41"h						
<b>Model</b>	<b>Description</b>					<b>List</b>	
2802	Power/Data Box, 6"Sq Box for Table Top Install					475	
							

Curved Corner Units are available in either 90-degree or 45-degree sections.

**Unique Product Options – Specify:**

Top: Thick walls can be specified with a ½” Corian top surface.



Power/Data: Tables can be specified with an optional power data unit located in center of table.

Model	Description / Dimensions	Maple	Opt A	Glacier White Solid Surface Top Cap	Glacier White Solid Surface Table Top	Special Color Solid Surface Top Cap	Special Color Solid Surface Table Top
2771	90° Curved Corner Table, 29" Thin Back	1950	2496	N/A	630	N/A	855
							
	28"w x 28"d x 29"h						





Model	Description / Dimensions	Maple	Opt A	Glacier White Solid Surface Top Cap	Glacier White Solid Surface Table Top	Special Color Solid Surface Top Cap	Special Color Solid Surface Table Top
2772	90° Curved Corner Table, 29" Thick Back	2375	3040	420	630	570	855
							
	34"w x 34"d x 29"h						

Model	Description / Dimensions	Maple	Opt A	Glacier White Solid Surface Top Cap	Glacier White Solid Surface Table Top	Special Color Solid Surface Top Cap	Special Color Solid Surface Table Top
2773	90° Curved Corner Table, 41" Thin Back	2250	2880	N/A	630	N/A	855
							
	28"w x 28"d x 41"h						

Model	Description / Dimensions	Maple	Opt A	Glacier White Solid Surface Top Cap	Glacier White Solid Surface Table Top	Special Color Solid Surface Top Cap	Special Color Solid Surface Table Top
2774	90° Curved Corner Table, 41" Thick Back	2960	3789	420	630	570	855
							
	34"w x 34"d x 41"h						

Model	Description	List
2802	Power/Data Box, 6" Sq Box for Table Top Install	475
	 	

## Thick and Thin Modular

Model	Description / Dimensions	Maple	Opt A	Glacier White Solid Surface		Special Color Solid Surface	
				Top Cap	Table Top	Top Cap	Table Top
2775	45° Curved Corner Table, 29" Thin Back	1380	1766	N/A	420	N/A	510
	28"w x 28"d x 29"h						
2776	45° Curved Corner Table, 29" Thick Back	1695	2170	245	420	333	510
	34"w x 34"d x 29"h						
2777	45° Curved Corner Table, 41" Thin Back	1680	2150	N/A	420	N/A	510
	28"w x 28"d x 41"h						
2778	45° Curved Corner Table, 41" Thick Back	2130	2726	245	420	333	510
	34"w x 34"d x 41"h						

## Straight Tables

Designed by Charlie Kane of XLG

## Thick and Thin Modular

All tables can be used separately or ganged. They are available in three depths in order to coordinate with the different wall thickness offerings. The 27" Depth tables align with the inside of both Thick and Thin walls. The 28" Depth tables align flush with the outside of the Thin walls. The 34" Depth tables align flush with the outside back of Thick walls.

### Unique Product Options – *Specify:*

Top: Thick walls can be specified with a ½" Corian top surface.

Power/Data: Tables can be specified with an optional power data unit located in center of table.

Model	Description / Dimensions	Maple	Opt A	Glacier White Solid Surface Top Cap	Glacier White Solid Surface Table Top	Special Color Solid Surface Top Cap	Special Color Solid Surface Table Top
2779	Square Open Table for Benches	1375	1760	N/A	630	N/A	855
	27"w x 27"d x 17"h						







Model	Description / Dimensions	Maple	Opt A	Glacier White Solid Surface Top Cap	Glacier White Solid Surface Table Top	Special Color Solid Surface Top Cap	Special Color Solid Surface Table Top
2780	Square Open Table for Thin Back	1495	1914	N/A	630	N/A	855
	28"w x 28"d x 17"h						

Model	Description / Dimensions	Maple	Opt A	Glacier White Solid Surface Top Cap	Glacier White Solid Surface Table Top	Special Color Solid Surface Top Cap	Special Color Solid Surface Table Top
2781	Square Open Table for Thick Back	1675	2144	N/A	840	N/A	1140
	34"w x 34"d x 17"h						

Model	Description / Dimensions	Maple	Opt A	Glacier White Solid Surface Top Cap	Glacier White Solid Surface Table Top	Special Color Solid Surface Top Cap	Special Color Solid Surface Table Top
2782	Rectangular Open Table for Benches	1400	1792	N/A	630	N/A	855
	36"w x 27"d x 17"h						

Model	Dimensions	Maple	Opt A	Glacier White Solid Surface Top Cap	Glacier White Solid Surface Table Top	Special Color Solid Surface Top Cap	Special Color Solid Surface Table Top
2783	Rectangular Open Table for Benches	1700	2176	N/A	770	N/A	1045
	48"w x 27"d x 17"h						

## Thick and Thin Modular

Model	Description / Dimensions	Maple	Opt A	Glacier White Solid Surface		Special Color Solid Surface	
				Top Cap	Table Top	Top Cap	Table Top
2784	Table for 29" Thin Back	1675	2144	N/A	630	N/A	855
	 27"w x 28"d x 29"h						
2785	Table for 29" Thick Back	1800	2304	140	630	190	855
	 27"w x 34"d x 29"h						
2786	Table for 41" Thin Back	1825	2336	N/A	630	N/A	855
	 27"w x 28"d x 41"h						
2787	Table for 41" Thick Back	2175	2784	140	630	190	855
	 27"w x 34"d x 41"h						
<b>Model</b>	<b>Description</b>					<b>List</b>	
2802	Power/Data Box, 6"Sq Box for Table Top Install					475	
	 						

**Tables**

Designed by Charlie Kane of XLG

# Thick and Thin Modular

All tables can be used separately or ganged.

**Unique Product Options – Specify:**

Top: Thick walls can be specified with a ½” Corian top surface.

Power/Data: Tables can be specified with an optional power data unit located in center of table.

Model	Description / Dimensions	Maple	Opt A	Glacier White Solid Surface Top Cap	Glacier White Solid Surface Table Top	Special Color Solid Surface Top Cap	Special Color Solid Surface Table Top
2789	Table, 40" Round	2100	2688	N/A	910	N/A	1235



40" Dia x 17"h

Model	Description / Dimensions	Maple	Opt A	Glacier White Solid Surface Top Cap	Glacier White Solid Surface Table Top	Special Color Solid Surface Top Cap	Special Color Solid Surface Table Top
2790	90° Open Curved Corner Table for Benches	1650	2112	N/A	910	N/A	1235



27"w x 27"d x 17"h

Model	Description / Dimensions	Maple	Opt A	Glacier White Solid Surface Top Cap	Glacier White Solid Surface Table Top	Special Color Solid Surface Top Cap	Special Color Solid Surface Table Top
2791	45° Open Curved Corner Table for Benches	1390	1779	N/A	420	N/A	570



27"w x 27"d x 17"h

## Laptop Tables

Designed by Charlie Kane of XLG

# Thick and Thin Modular

Laptop tables are available in attached or freestanding styles. Attached Laptop tables can be positioned on any seat, bench or table and mounts to the underside of seat. It is shipped loose and installed on site at the desired location. Assembly instructions provided. Free standing Laptop tables can be positioned anywhere.

### Attached Laptop Table

Model	Dimensions	Maple	Opt A
2792	14"w x 12"d x 18"h	1100	1478



### Freestanding Laptop Table

Model	Dimensions	Maple	Opt A
2793	14"w x 12"d x 23"h	1350	1728



## Privacy Sofa

Designed by Charlie Kane of XLG

## Thick and Thin Modular

Privacy sofas feature 51" height backs, providing privacy from adjacent users and circulation. The backs and ends are flat allowing them to be seamlessly ganged together.

Model	Description	Yards			Fabric Grades					Veneer Upcharge
		Back	Seat	Total	COM	1	2	3	4	Opt A
2794	3-Seat Privacy Sofa, 51" Thin End & Back	3.25	4	7.25	5990	6737	7107	7476	7846	1677
	Dimensions	Sq Feet			Leather					
	80"w x 28"d x 51"h	Back	Seat	Total	COL	S	B			
		54	72	126	6889	10336	10588			

Accessories

Designed by Charlie Kane of XLG

# Thick and Thin Modular

Model	Description	YDS	SF	COM	COL	Fabric Grades				Leather	
						1	2	3	4	S	B
2799	Bolster Pillow, 20" Length	0.5	9	140	161	192	217	243	268	698	732



Model	Description	List
2744-L	Armrest w/ Metal Support, Left Side	295



2744-R	Armrest w/ Metal Support, Right Side	295
--------	--------------------------------------	-----



2744-LR	Armrest w/ Metal Support, Left & Right Sides	590
---------	--	-----



Model	Description	List
2801	Power/Data Box, Underseat Mount, Black	350



2802	Power/Data, 6" Sq Box for Table Top Install Polished, Satin or Statuary Bronze	575
------	---	-----



Model	Description	List
2804	Extra/Replacement Ganging Bracket, Qty 2	32

## Thick and Thin Modular

Ganged Airport seating allows for an infinite ganging of sections with an optional wide armrest divider allowing a greater sense of privacy. The Arm Rests are options (with and without power) and need to be specified as separate part numbers on orders. These use the same fabric as specified on the seat. The power data unit is built into the arm and allows users to power their laptops and charge PDAS and mobile phones. It is available in matte silver or black finish and contains 2-grounded simplex outlets, 15-amp circuit, (1) Powered USB port and a 4' power cord.

### Unique Product Options – Specify:

Armrest Specify Arms or No arms, powered or non-powered arms, Silver or Black power units in arms.

Model	Description	Yards			Fabric Grades					Veneer Upcharge
		Back	Seat	Total	COM	1	2	3	4	Opt A
2795	Airport LH Corner, 29" Thick End & Thin Back	2	2.5	4.5	2260	2724	2953	3183	3412	633
		Sq Feet			Leather			Solid Surface Upcharge		
	<b>Dimensions</b>	Back	Seat	Total	COL	S	B	Std	Special	
	39"w x 28"d x 29"h	36	45	81	2599	4897	5065	175	238	



Model	Description	Yards			Fabric Grades					Veneer Upcharge
		Back	Seat	Total	COM	1	2	3	4	Opt A
2797	Airport Center Seat, 29" Thin Back	1.5	2	3.5	1295	1656	1834	2013	2191	363
		Sq Feet			Leather			Solid Surface Upcharge		
	<b>Dimensions</b>	Back	Seat	Total	COL	S	B	Std	Special	
	29"w x 28"d x 29"h	27	36	63	1352	3650	3818	N/A	N/A	



Model	Description	Yards			Fabric Grades					Veneer Upcharge
		Back	Seat	Total	COM	1	2	3	4	Opt A
2796	Airport RH Corner, 29" Thick End & Thin Back	2	2.5	4.5	2260	2724	2953	3183	3412	633
		Sq Feet			Leather			Solid Surface Upcharge		
	<b>Dimensions</b>	Back	Seat	Total	COL	S	B	Std	Special	
	39"w x 28"d x 29"h	36	45	81	2599	4897	5065	175	238	



Model	Description/Dimensions	List
2798	Standard Armrest 10"w x 18"d x 5"h	200



Model	Description/Dimensions	List
2804	Powered Armrest 10"w x 18"d x 5"h	675



Updated: 02/01/2012