

General Illumination PTP-DIS-WM

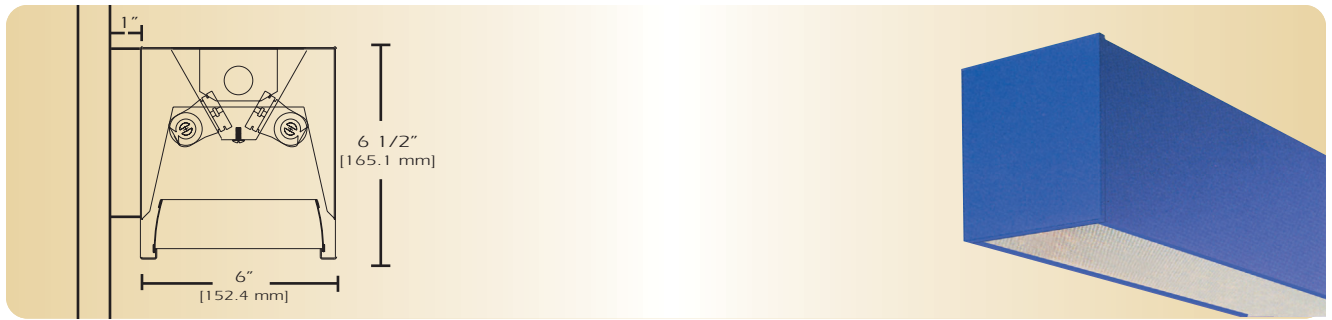

TYPE _____

FEATURES

The PTP architectural linear series is an extraordinarily efficient steel luminaire. The PTP DIS WM is designed with direct/indirect distribution for wall mounting. This series can be mounted individually, in perfectly aligned continuous rows or in any of combination of patterns. This series is available with an up light component and almost limitless variety of down light shielding. The PTP series is an ideal solution for open spaces and provides maximum design versatility.

SPECIFICATIONS

Housing: Die formed 20 gauge cold rolled steel welded construction, bottom of housing has a 3/8" regression for structural rigidity and conformity. Joiner ends are notched below the lamps for ease of installation and continuous baffle appearance. Obround slots 9/16" wide on top of housing provide indirect illumination. Finished end caps are laser cut 18 gauge cold rolled steel, with no exposed hardware or knockouts. Housing aligners provide precision alignment for continuous rows.

Reflector: Die formed 20-gauge cold rolled steel minimum 90% reflectivity finished in high gloss baked white enamel.

Shielding: Parabolic louver is semi-specular low iridescence aluminum 1 1/2" x 2" O.C. with 24 cells per 4' section.

Electrical: Ballast is electronic, high power factor, thermally protected class P, sound rated A, with less than 20% total harmonic distortion. The minimum number of ballasts will be used unless otherwise specified.

Mounting: Provided with wall mounting brackets measuring 5" square by 1" deep. Finished in white to match housing.

Finish: Fixture housing and steel components are finished in baked white enamel applied over a five-stage pretreatment process.

Lamps: Fixtures are provided for use with one or two 32 watt T8 lamps or 54 watt T5 HO lamps. (Supplied by Others)

Certification: Luminaires are U. L. Listed, C. S. A. certified and are Union Made in the United States of America. I.B.E.W.

ORDERING GUIDE

MODEL NO.	DIRECTION	SHIELDING	NO. OF LAMPS	LAMPS	MOUNTING	LENGTH	FINISH	VOLTAGE	OPTIONS
PTP	DIS								
PTP	DIS =Direct/Indirect Symmetric	PBL =Parabolic Louver SCB = Steel Cross Baffle PRS =Prismatic Acrylic WOA = White Opal Acrylic	1 = 1 2 = 2	17 T8 (2') 25 T8 (3') 32 T8 (4') 40 T8 (5') 28 T5 (4') 54 T5 HO (4')	WM = Wall See Accessories	2 = ft 3 = ft 4 = ft 5 = ft 6 = ft 8 = ft for other, please enter row length (eg. 48=48ft)	W = White CC = Custom Color	120v 277v	See Options Below

Example: **PTP-DIS-PBL-232T8-WM-4-W-120V**

PTP- direct indirect with parabolic louver for two 32 watt T8 lamps wall mounted four foot fixture finished in baked white enamel 120v electronic ballast less than 20% total harmonic distortion.

OPTIONS

- E10=** Electronic ballast, high power factor, thermally protected class P, sound rated A, < 10% total harmonic distortion
- PT3=** Parabolic reflector in semi-specular low iridescence aluminum
- DIM=** Dimming Ballast
- EPC=** Emergency Battery Pack
- EMC=** Emergency Circuit
- TCW=** Two Circuit Wiring
- OTH=** See Accessories for other options available

General Illumination PTP-DIS-WM

LINEAR SECTIONS AND SUSPENSION LOCATION

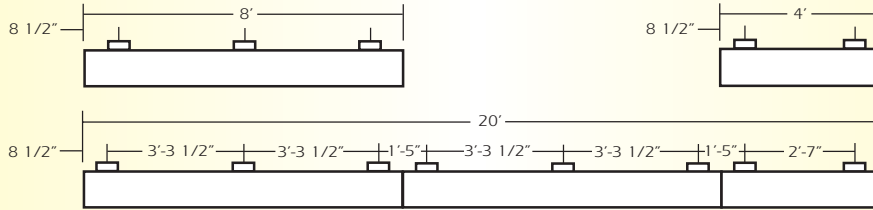

JOINERS

JB2

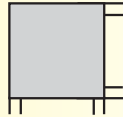

JB2-90° (Corner) Joiner Box

CORNERS

Corners and fixture extensions are custom fabricated to precise dimensions. Please indicate the specific requirements on the layout

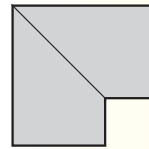

C2
90° Corner

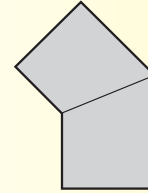

For any angular corner, ()° must be specified and dimensions must be included on the layout

()° AC
Angular Corner

INSTALLATION PREPARATION

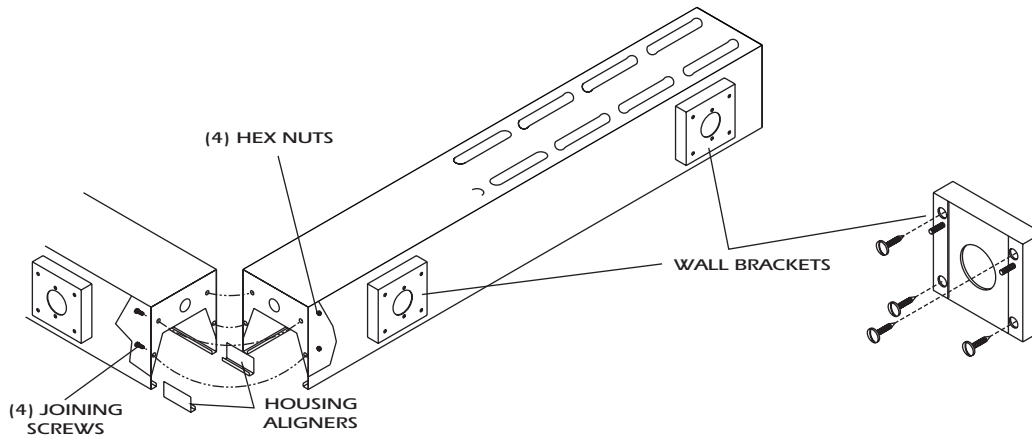

TYPICAL JOINT DETAIL

PHOTOMETRY

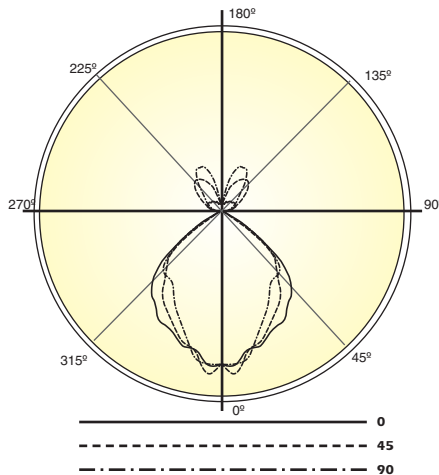

LAMP (2) 32W T8
LUMENS: 2900 PER LAMP
PARABOLIC LOUVER

Candela Distribution:

Vert. Angle	0	22.5	45	67.5	90
0	1108	1108	1108	1108	1108
5	1114	1175	1109	1107	1125
15	1016	995	950	947	999
25	919	859	775	744	776
35	827	737	619	697	834
45	691	551	589	645	757
55	270	277	326	352	471
65	34.3	30.9	64.5	122	196
75	15.9	12.8	17.0	16.8	27.0
85	3.57	2.57	2.50	1.41	2.62
95	19.9	11.9	11.2	14.1	15.2
105	74.3	48.4	40.0	43.8	43.8
115	103	113	81.7	72.4	77.2
125	108	188	126	118	126
135	95.4	268	175	163	173
145	92.7	288	299	223	200
155	75.1	243	356	349	346
165	56.0	167	288	332	339
175	60.3	85.2	113	130	192
180	57.2	57.2	57.2	57.2	57.2

Optical Distribution:
73% Direct: 27% Indirect

Coefficients of Utilization - Zonal Cavity Method:

pfc = 0.20

	.8	.7	.5	.3	.1	0												
pcc	.8	.7	.5	.3	.1	0												
pw	.7	.5	.3	.1	.5	.3	.1	.5	.3	.1	0							
RCR																		
0	55	55	55	55	53	53	53	53	47	47	47	42	42	42	38	38	38	36
1	51	50	48	46	49	47	46	44	43	42	41	39	38	37	35	34	34	32
2	48	44	41	39	45	42	40	38	38	36	35	35	33	32	31	30	29	28
3	44	39	36	33	41	38	35	32	34	32	30	31	29	28	28	27	26	24
4	40	35	32	29	38	34	30	28	31	28	26	28	26	24	26	24	23	21
5	37	32	28	25	35	30	27	24	28	25	23	26	23	21	23	22	20	19
6	34	29	25	22	33	28	24	21	25	22	20	23	21	19	21	19	18	17
7	32	26	22	20	30	25	21	19	23	20	18	21	19	17	20	18	16	15
8	30	24	20	17	28	23	19	17	21	18	16	20	17	15	18	16	14	13
9	28	22	18	16	26	21	18	15	19	17	14	18	16	14	17	15	13	12
10	26	20	16	14	25	19	16	14	18	15	13	17	14	12	15	13	12	11



Total Luminaire Optical Efficiency = 49.6%