

New Age Series

NAS-RND

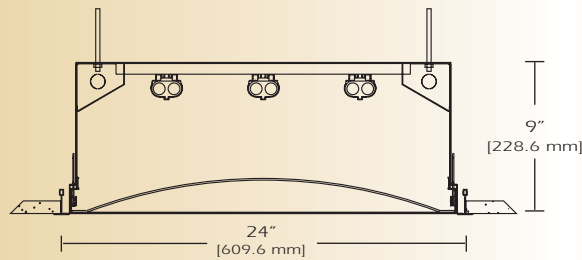

TYPE _____

FEATURES

The RND luminaire is available in two, three and four foot diameters with a precision spun ceiling trim. The recessed housing is engineered so that housing can be placed through the round aperture opening and assembled without any delay in ceiling finishing. The luminaire is uniformly illuminated with .125" thick white acrylic concaved lens with optional convex and flat lens. The RND is recommended for applications in open spaces, airport concourses, schools, retail and offices.

SPECIFICATIONS

Housing: Die formed two-piece square housing for flanged fixture and one piece for grid, constructed of 20 gauge cold rolled steel finished in baked white enamel. Housing has four 7/8" knockouts at corners of housing top for access. Flanged housing has a mounting angle 14" long on two sides for mounting rods (supplied by others). Grid housing has four holes at corners on top of housing for tie wire (supplied by others)

Trim: A plaster ring is supplied when fixture is mounted to dry wall or plaster ceiling. The circular face trim is provided to mount the circular doorframe.

Reflector: Die formed 20-gauge cold rolled steel 90% minimum reflectivity finished in low glare matte baked white enamel

Shielding: A white translucent acrylic diffuser is vacuum formed to permanently retain its concave dimension. The circular door frame twist locking clips permit hanging without tools, for relamping and cleaning.

Mounting: Standard installation is for two, three or four foot circular drywall ceiling. Optional trim is available for installations in grid ceiling. For mounting detail information consult factory.

Finish: Fixture housing and steel components are finished in baked white enamel applied over a five-stage pretreatment process.

Lamps: Fixtures are provided for use with T8, T5, T5HO or compact fluorescent lamps. (Supplied by Others)

Certification: Luminaires are U. L. Listed, C. S. A. certified and are Union Made in the United States of America I.B.E.W.

ORDERING GUIDE

MODEL NO.	NOMINAL DIAMETER	SHIELDING	NO. OF LAMPS	LAMP SIZE	MOUNTING	FINISH	VOLTAGE	OPTIONS
NAS-RND	2= 2 ft 3= 3 ft 4= 4 ft	CC= Concave CX= Convex FL= Flat	2 3 4 6 8	T8 T5 T5HO 40CF	G= Standard Lay-in Grid MG= Miniature Grid F= Flanged O=Other Specify	W= White CC= Custom Color	120v 277v	See Options Below

Example: **NAS-RND-4CC-632T8-F-W-120V**

New Age Round four foot diameter with six 32 watt T8 lamps flanged fixture finished in baked white enamel, with concave white acrylic diffuser, 120 volt electronic ballast less than 20% harmonics.

OPTIONS

- E10=** Electronic ballast, high power factor, thermally protected class P, sound rated A, < 10% total harmonic distortion
- DIM=** Dimming Ballast
- EPC=** Emergency Battery Pack
- EMC=** Emergency Circuit
- TCW=** Two Circuit Wiring
- OTH=** See Accessories for other options available

LINEAR SECTIONS AND SUSPENSION LOCATION

MOUNTING "G"

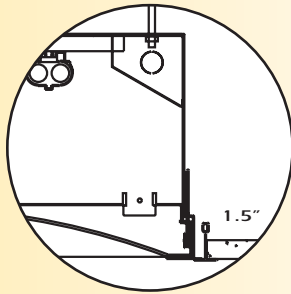

STD. 1 1/2" INVERTED "T" BAR

MOUNTING "MG"

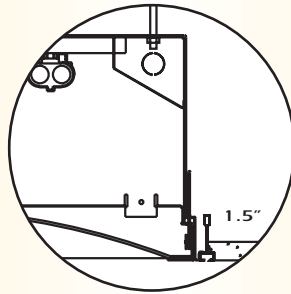

1 1/2" MINIATURE GRID CEILING

MOUNTING "F"

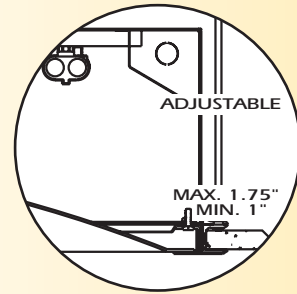

* PLASTER OR DRY WALL CEILING

* FIXTURES INSTALLED IN PLASTER OR DRY WALL REQUIRES PLASTER RING AND THE HOUSING IS SHIPPED IN TWO SECTIONS

INSTALLATION PREPARATION

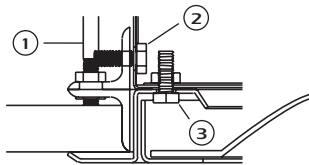
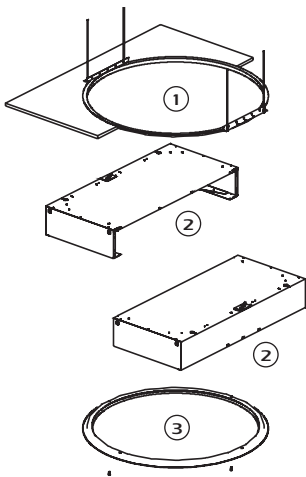

- ① SECURED PLASTER FRAME TO THE CEILING WITH RODS OR WIRE TIES. THE PLASTER FRAMES ARE SHIP PRIOR TO THE FIXTURE FOR CEILING PREPARATION.
- ② INSERT THE FIXTURE SECTIONS ONE AT A TIME. THE FIXTURE HOUSING IS FABRICATED IN TO MATING SECTIONS TO ALLOW ENTRY THROUGH THE PLASTER FRAME APERTURE, THE HOUSING IS FURNISHED WITH THE NECESSARY HARDWARE FOR FIELD ATTACHMENT.
- ③ INSTALL THE LENS FRAME ASSEMBLY TO THE FIXTURE HOUSING. THE LENS FRAME IS PROVIDED WITH HARDWARE AND IS TETHERED TO ALLOW ACCESS INSIDE THE FIXTURE. THE LENS DOOR IS SECURED WITH A BAYONET LOCKING ACTION.

TYPICAL CROSS SECTION

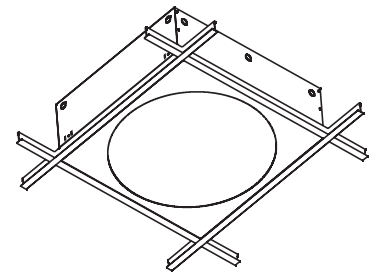
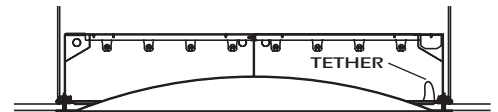

PHOTOMETRY

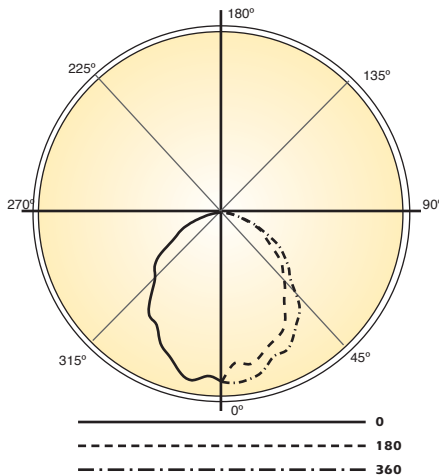

Candela Distribution:

Vert. Angle	0	90	180	270	360
0	1971	1971	1971	1971	1971
5	1911	1820	1727	1763	1911
10	1984	1914	1738	2010	1984
15	1912	1900	1765	1835	1912
20	1779	1799	1580	1807	1779
25	1681	1692	1429	1629	1681
30	1512	1615	1407	1612	1512
35	1466	1425	1245	1407	1466
40	1283	1277	1122	1262	1283
45	1098	1112	993	1145	1098
50	892	834	736	1017	1019
55	892	834	736	876	892
60	664	723	671	688	664
65	543	551	507	552	543
70	413	373	358	376	413
75	256	246	239	279	256
80	142	141	134	145	142
85	43.4	38.0	44.8	46.3	43.4
90	0.00	0.78	0.92	2.32	0.00

Optical Distribution:
100% Direct

LAMP (3) 40W C.F.
LUMENS: 3150 PER LAMP

Coefficients of Utilization - Zonal Cavity Method:

pfc = 0.20

	.8	.7	.5	.3	.1	0
0	60 60 60 60	59 59 59 59	56 56 56	54 54 54	51 51 51	50
1	55 53 51 49	54 52 50 48	50 48 47	48 47 45	46 45 44	43
2	50 46 43 40	49 46 42 40	44 41 39	42 40 38	41 39 37	36
3	46 41 37 34	45 40 36 34	39 36 33	37 35 32	36 34 32	31
4	42 36 32 29	41 36 32 29	34 31 28	33 30 28	32 30 27	26
5	39 33 28 25	38 32 28 25	31 27 24	30 27 24	29 26 24	23
6	36 29 25 22	35 29 25 22	28 24 21	27 24 21	26 23 21	20
7	33 27 22 19	33 26 22 19	25 22 19	25 21 19	24 21 19	18
8	31 24 20 17	30 24 20 17	23 20 17	23 19 17	22 19 17	16
9	29 22 18 15	28 22 18 15	21 18 15	21 18 15	20 17 15	14
10	27 21 17 14	27 20 17 14	20 16 14	19 16 14	19 16 14	13

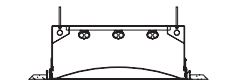

Total Luminaire Optical Efficiency = 50.9%