

FreeWall²

Montageanleitung

Assembly instruction

Notice de montage

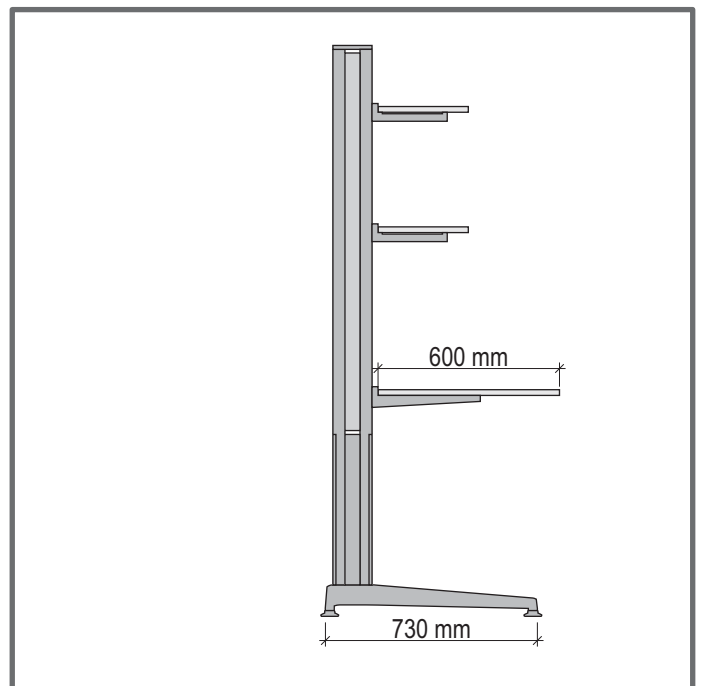
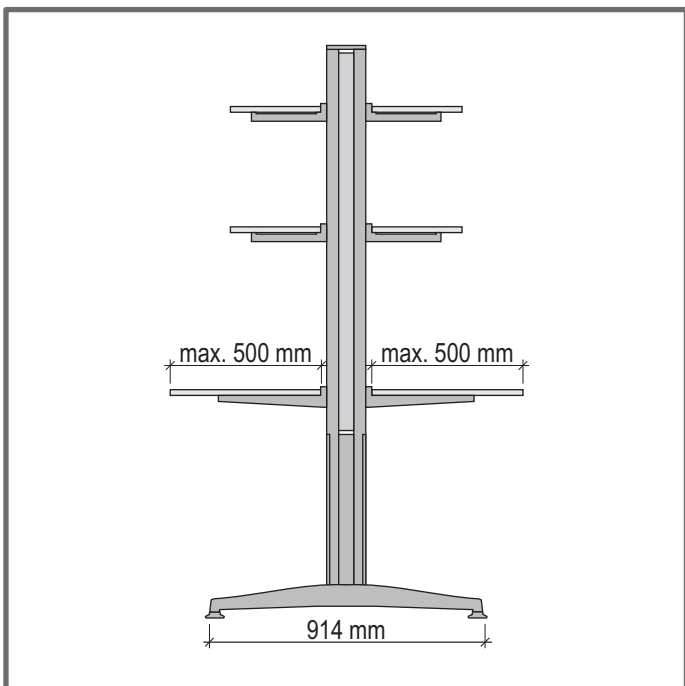
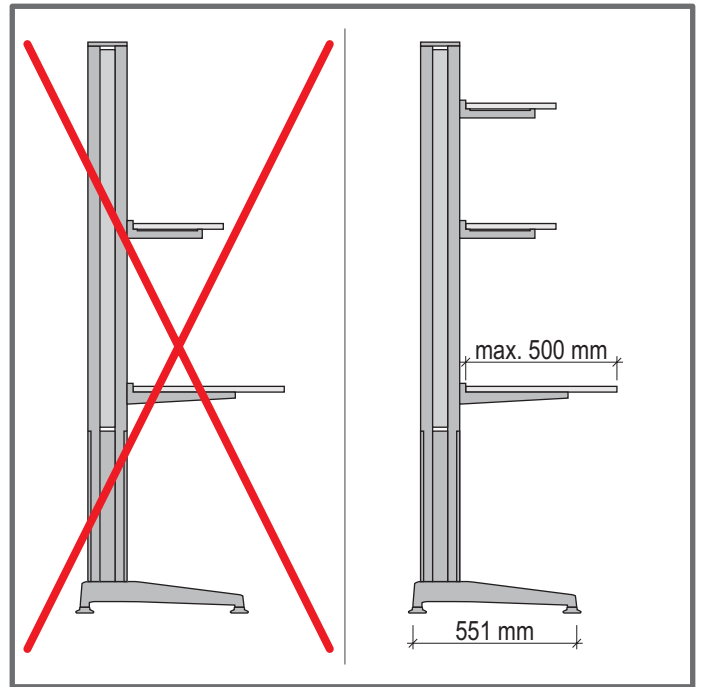
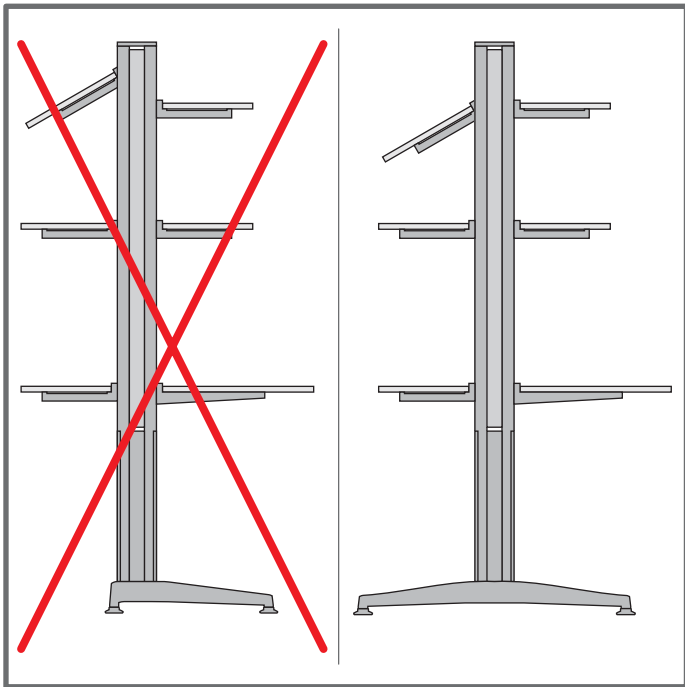

FreeWall2

Montageanleitung – Inhaltsverzeichnis

Assembly instructions – Table of contents

Notice de montage - Sommaire

	Seite/page/page
1.) Wand	3
2.) Plissee	6
3.) Board 30, 34, 40, 50 und 60	7
4.) Board TechTop 50, 60	8
5.) Board einhängen	9
6.) Orga-Paneel	10
7.) E-Box	11
8.) CPU-Halter	12
9.) Verkettung 45°	14
10.) Verkettung linear	16
11.) Druckertisch	18

1.) Wall	3
2.) Plissee	6
3.) Board 30, 34, 40, 50 and 60	7
4.) Board TechTop 50 and 60	8
5.) Board remount	9
6.) Orga-Panel	10
7.) E-box	11
8.) CPU-holder	12
9.) Junction 45°	14
10.) Junction linear	16
11.) Printer table	18

1.) Ecran	3
2.) Plissee	6
3.) Ètagerè 30, 34, 40, 50 et 60	7
4.) Ètagerè TechTop 50 et 60	8
5.) Ètagerè raccrocher	9
6.) Rail d'organisation	10
7.) E-box	11
8.) Ètagerè UC	12
9.) Liason 45°	14
10.) Liason linéaire	16
11.) Desserte	18

FreeWall2

Montageanleitung - Wand

Assembly instruction - wall

Notice de montage - ecran

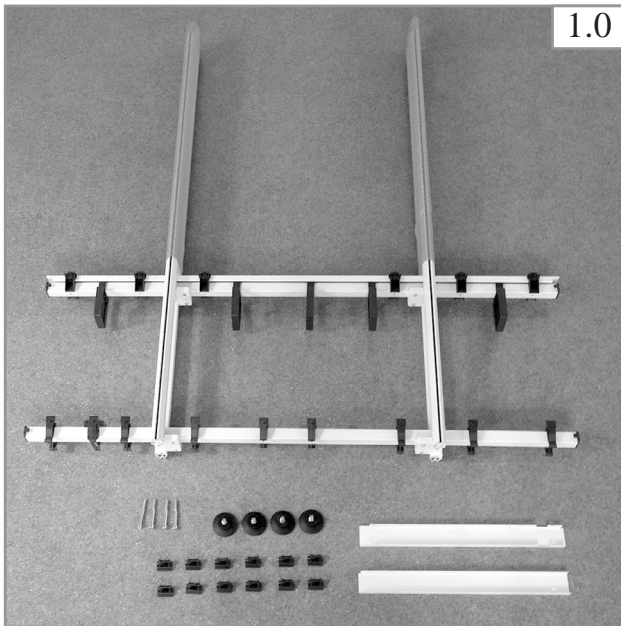

Verpackungsinhalt Gerüst (hier Typ 2+3)
 Frame packaging contents (type 2 + 3 shown here)
 Contenu de l'emballage Structure (ici type 2 + 3)

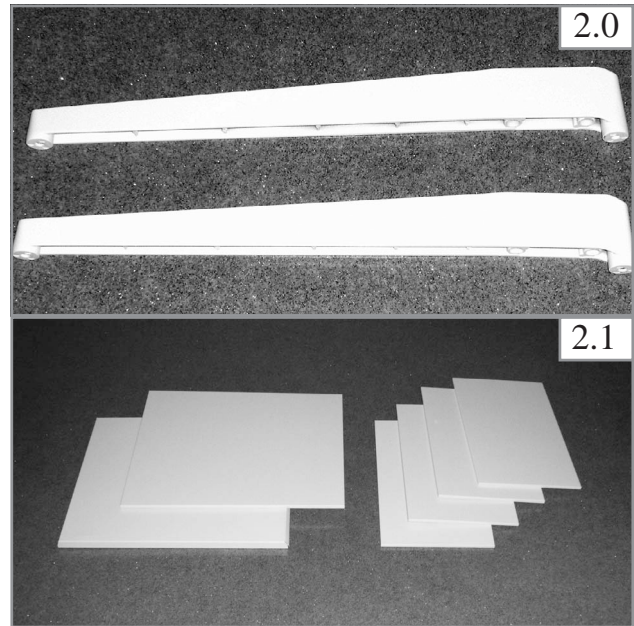

Verpackungsinhalt Ausleger/Kabelblenden
 Package contents – extension/cable covers
 Contenu de l'emballage Pied/cache-câbles

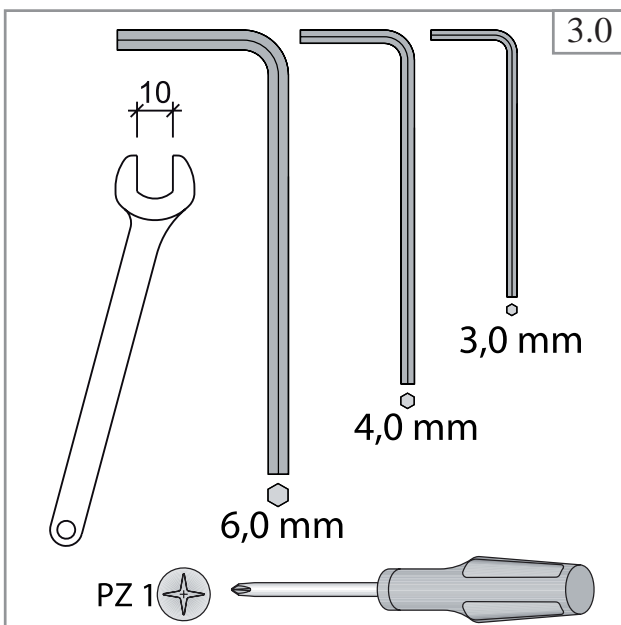

Benötigte Werkzeuge
 Tools required
 Outils nécessaires

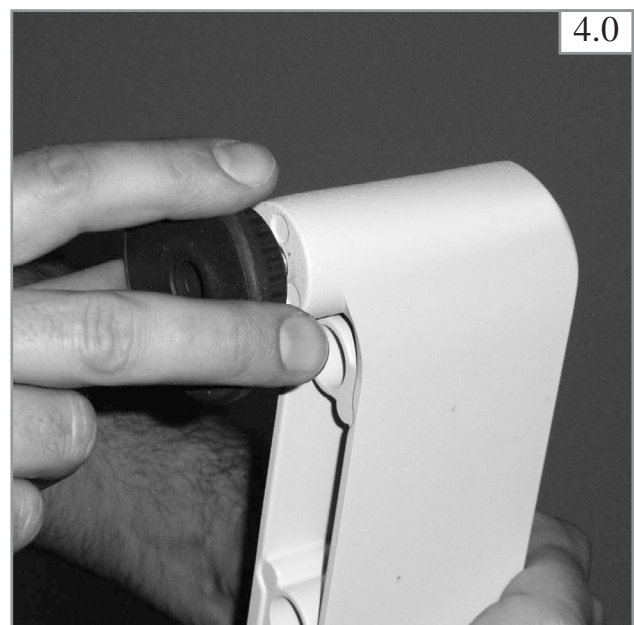

Stellschrauben in Ausleger schrauben
 Screw adjustable screws into extension
 Visser les vérins de réglage dans le pied.

FreeWall2

Montageanleitung - Wand

Assembly instruction - wall

Notice de montage - écran

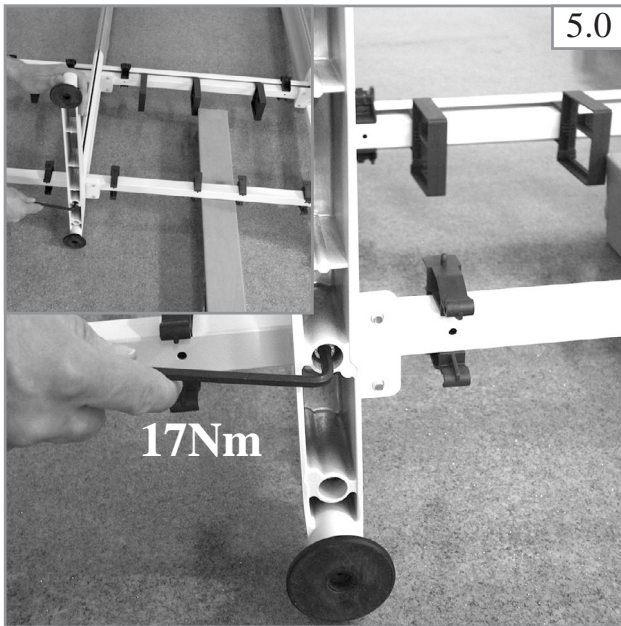

Ausleger mit Imbusschrauben an Gerüst schrauben.
Screw extension on to frame using allen keys.
Monter le pied sur la structure au moyen des vis à six pans creux.

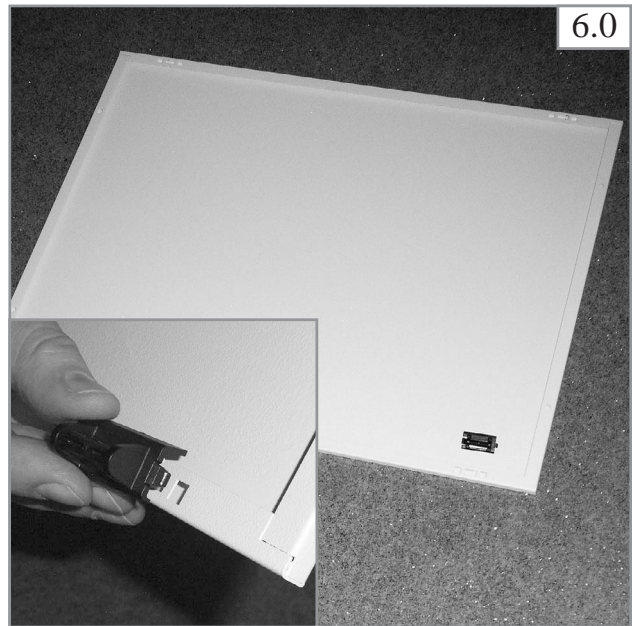

Blendeneinsatz einklipsen.
Attach cover insert.
Monter le clip de fixation sur le cache-câbles.

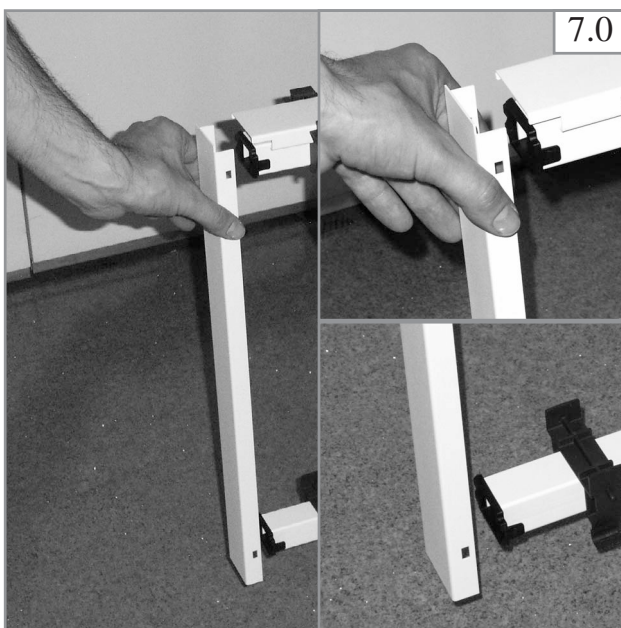

Seitenblende aufklipsen.
Clip on side panels.
Clipser le cache latéral sur la structure.



Kabelblenden einklipsen
Attach cable covers
Clipser les cache-câbles sur la structure.

FreeWall2

Montageanleitung - Wand

Assembly instruction - wall

Notice de montage - ecran

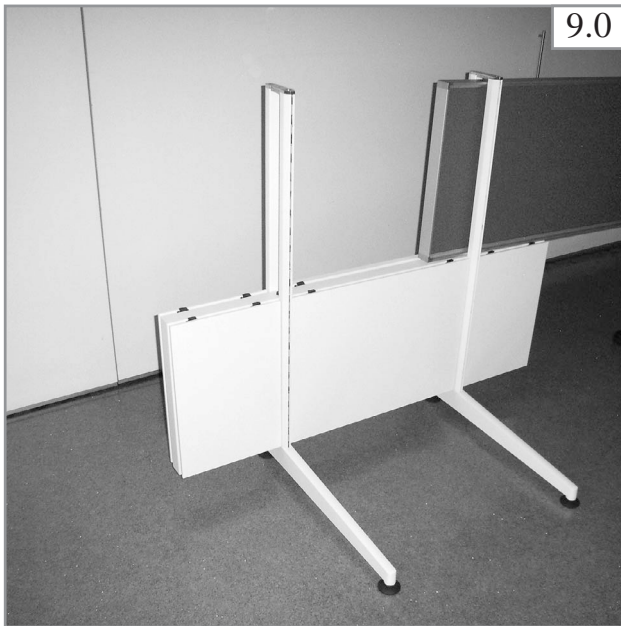

Panel seitlich einschieben.
Push in panel sideways.
Introduire le panneau par le côté.

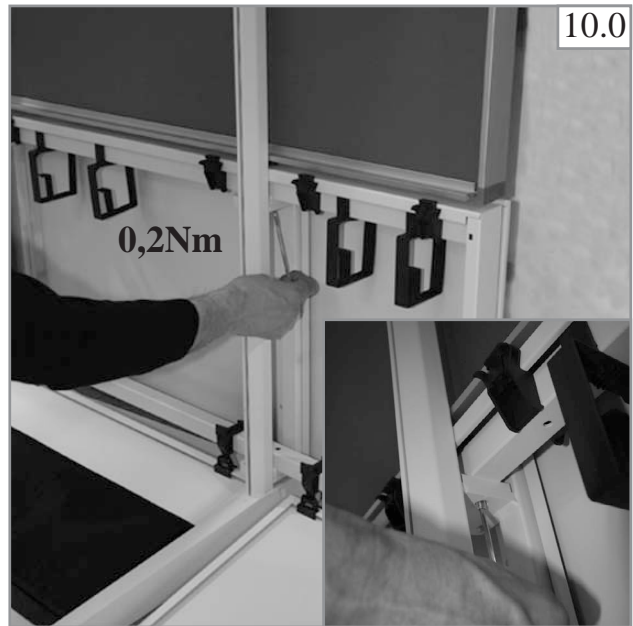

Panel von unten nivelieren.
Adjust panel level from below.
Niveler le panneau en bas.

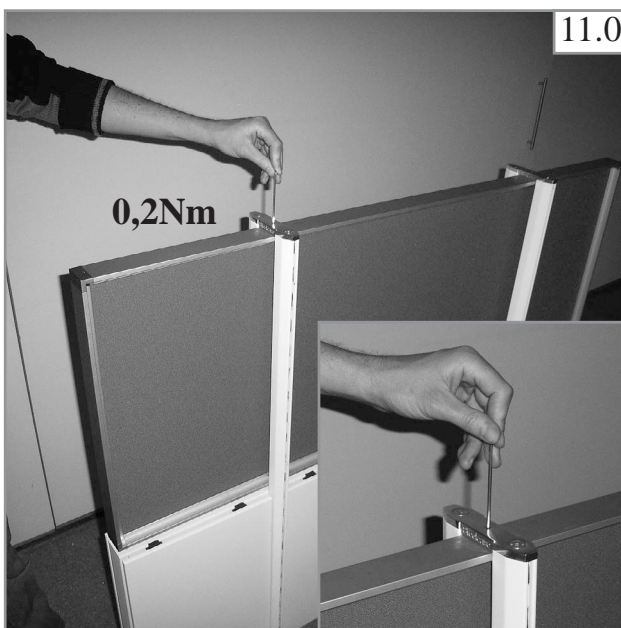

Panel von oben fixieren.
Fasten panel from above.
Fixer le panneau en haut.

FreeWall2

Montageanleitung - Plissee

Assembly instruction - Plissee

Notice de montage - Plissee

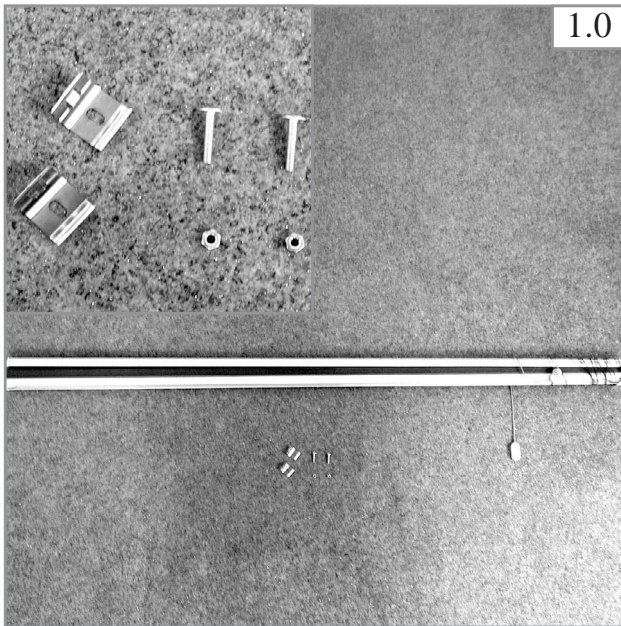

Verpackungsinhalt
packaging contents
Contenu de l'emballage

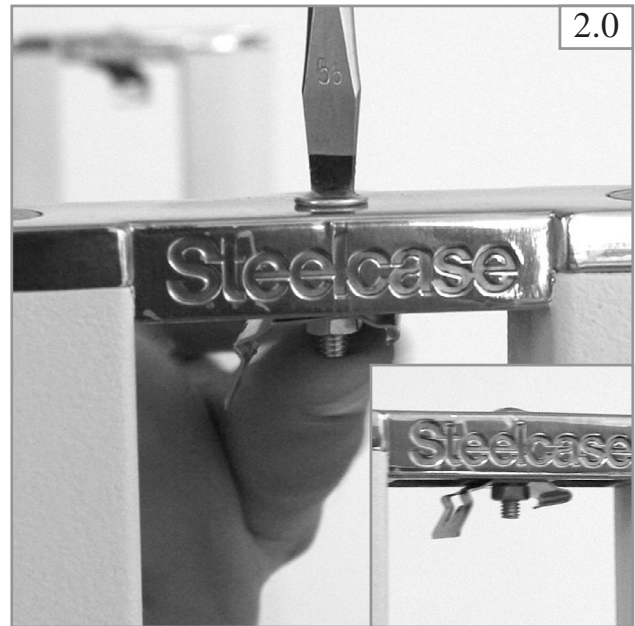

Halter an Brücke schrauben
Screw the support onto the profile
Visser le support au profilé

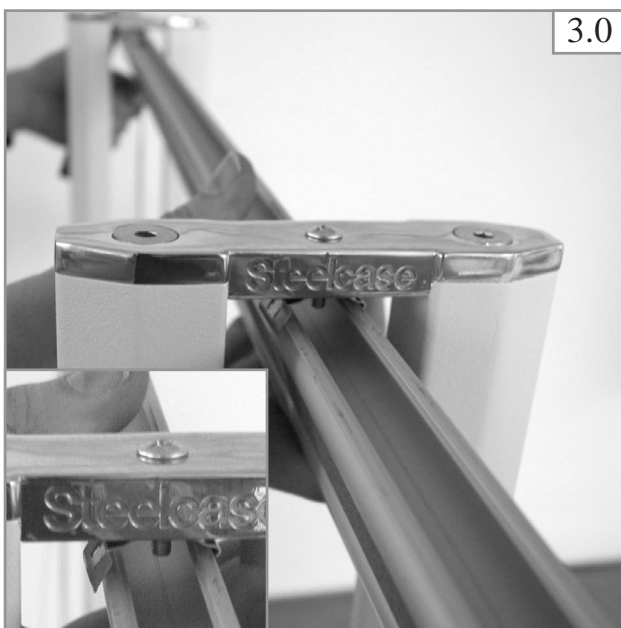

Plissee einklipsen
Fix the plissee
Clipser le plissee



Plissee seitlich ausrichten
Adjust the plissee on the side
Ajuster le plissee latéralement

FreeWall2

Montageanleitung - Board 30, 34, 40, 50 und 60

Assembly instruction - board 30, 34, 40, 50 and 60

Notice de montage - étagère 30, 34, 40, 50 et 60

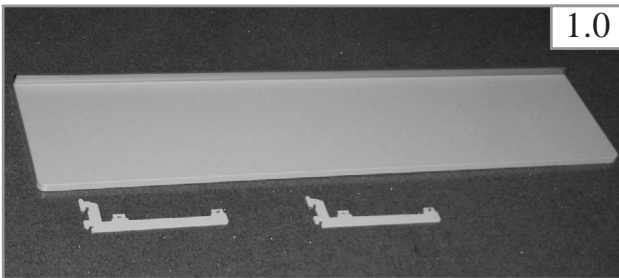

Verpackungsinhalt Board.
Board packaging contents
Contenu de l'emballage Etagère



Boardträger einstecken.
Insert board brackets.
Introduire les supports d'étagère dans les orifices.

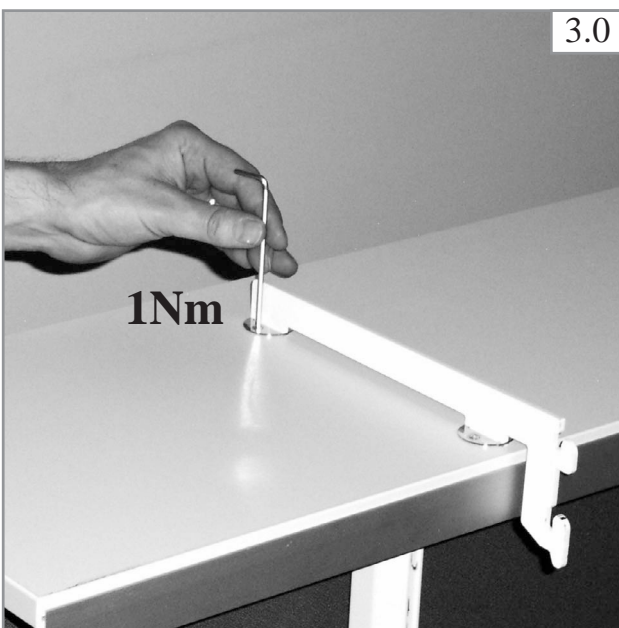

Boardträger fixieren.
Fasten board brackets.
Visser les supports.

FreeWall2

Montageanleitung - Board TechTop 50 und 60

Assembly instruction - board TechTop 50 and 60

Notice de montage - étagère TechTop 50 et 60

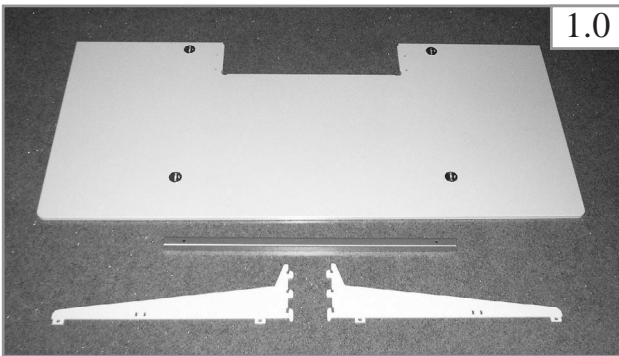

1.0

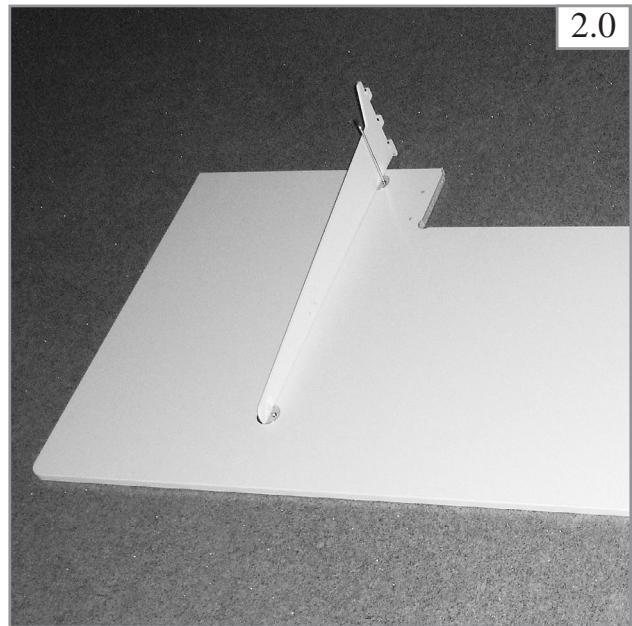

2.0

Verpackungsinhalt Board TechTop 50/60.
Board Tech Top 50/60 packaging contents.
Contenu de l'emballage Étagère TechTop 50/60.

Ersten Boardträger einstecken.
Insert first board bracket.
Monter le premier support d'étagère.

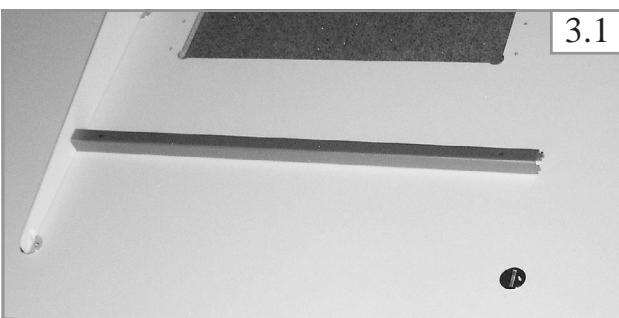

3.1

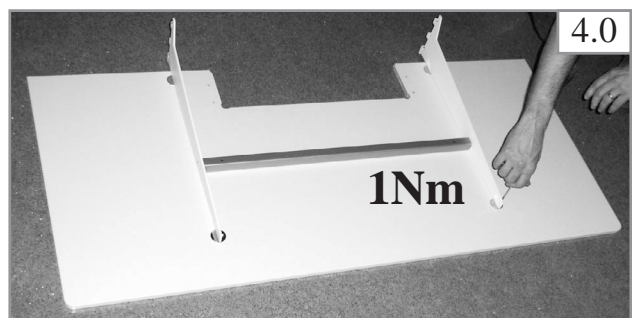

4.0

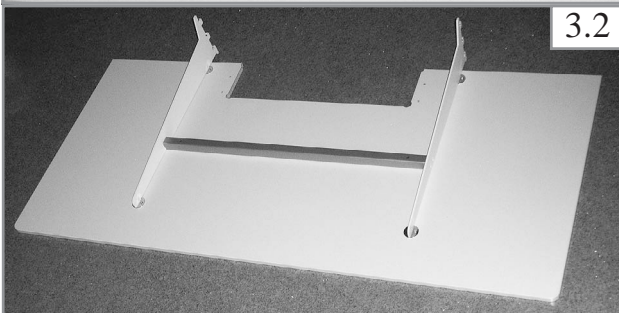

3.2

Traverse und 2. Boardträger einstecken.
Insert beam and second board bracket.
Monter la traverse et le deuxième support.

Boardträger fixieren.
Fasten board brackets.
Visser les supports.

FreeWall2

Montageanleitung - Board einhängen

Assembly instruction - board remount

Notice de montage - accrocher l'étagère

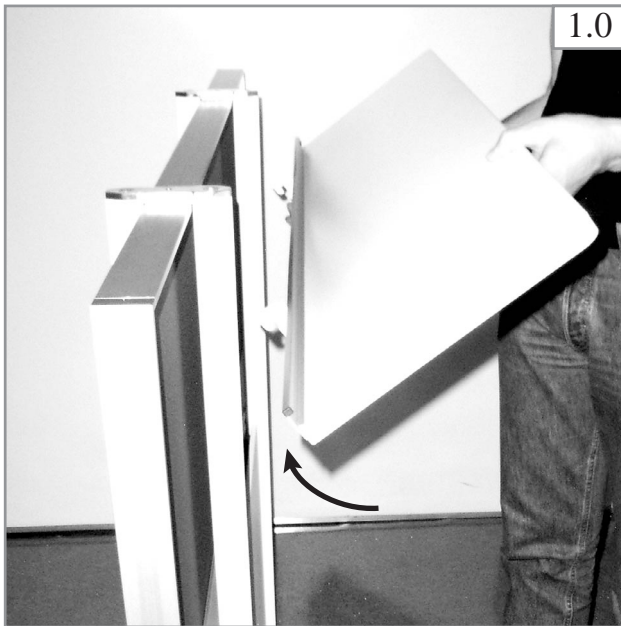

Board einhängen.
Suspend board.
Accrocher l'étagère.

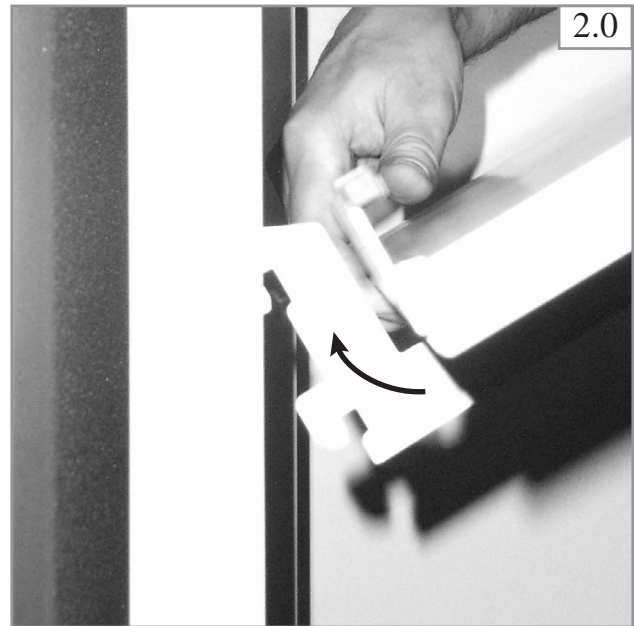

Board nach oben einhängen.
Suspend board upwards.
Introduire les crochets du support dans les montants

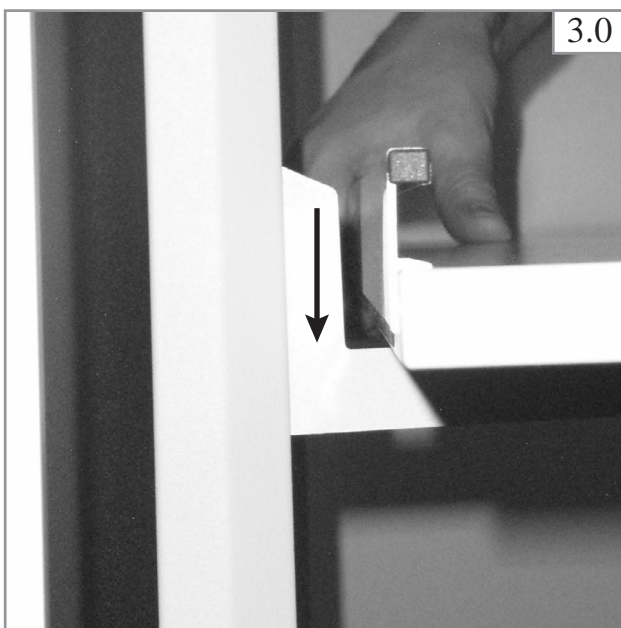

Board nach unten fixieren.
Clamp board downwards.
Abaisser le support pour le fixer.



Aushängesicherung einklipsen.
Attach retainer.
Bloquer la fixation avec le clip de sécurité.

FreeWall2

Montageanleitung - Orga-Paneel

Assembly instruction - orga-panel

Notice de montage - rail d'organisation

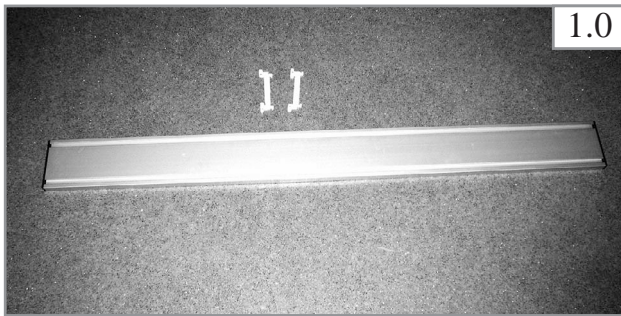

1.0

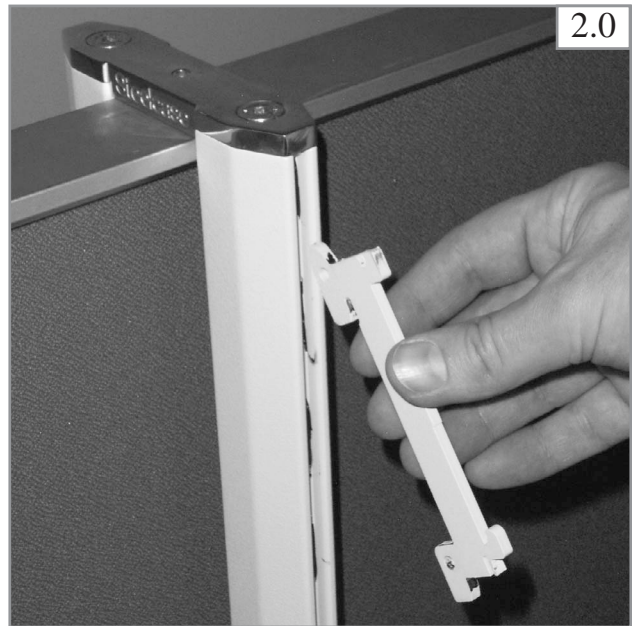

2.0

Verpackungsinhalt Orga-Paneel.
Orga panel packaging content
Contenu de l'emballage Rail porte-accessoires

Orga-Paneelträger einhängen.
Insert Orga panel brackets.
Monter les supports du rail.

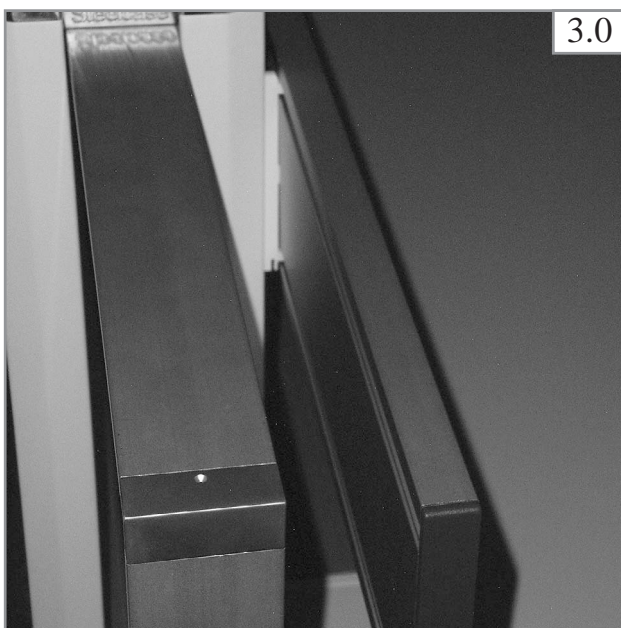

3.0

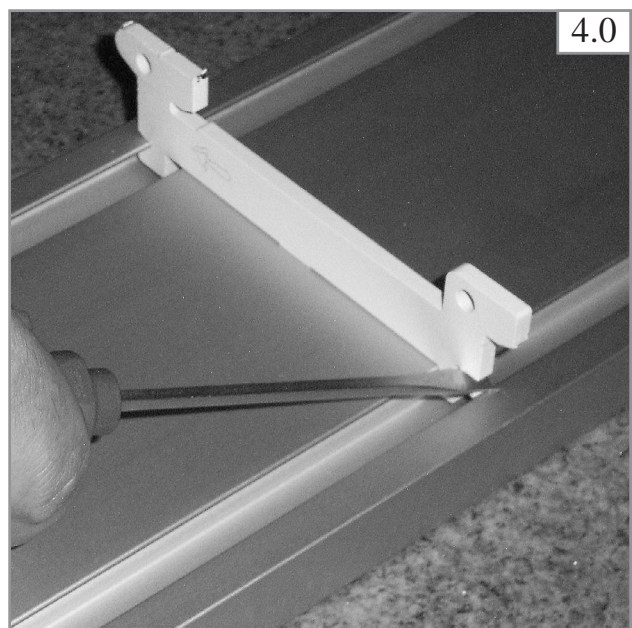

4.0

Orga-Paneel in Orga-Paneelträger einhängen.
Mount Orga panel on to Orga panel brackets.
Monter le rail porte-accessoires sur le support.

Sicherungslasche des Orga-Paneelträgers verklebmen.
Attach clamping plate for Orga panel brackets.
Bloquer le support de rail avec la languette de sécurité.

FreeWall2

Montageanleitung - E-Box

Assembly instruction - E-box

Notice de montage - E-box



1.0



2.0

Verpackungsinhalt E-Box
E-box packaging contents
Contenu de l'emballage E-Box

E-Box in Board einschieben.
Push E-box into board.
Glisser le E-Box dans l'étagère.



3.0

Befestigungswinkel einhängen.
Insert fixing angle.
Monter les crochets de fixation.



4.0

Befestigungswinkel festschrauben.
Secure fixing angle with screwdriver.
Visser les crochets de fixation.

FreeWall2

Montageanleitung - CPU-Halter

Assembly instruction - CPU-holder

Notice de montage - étagère UC

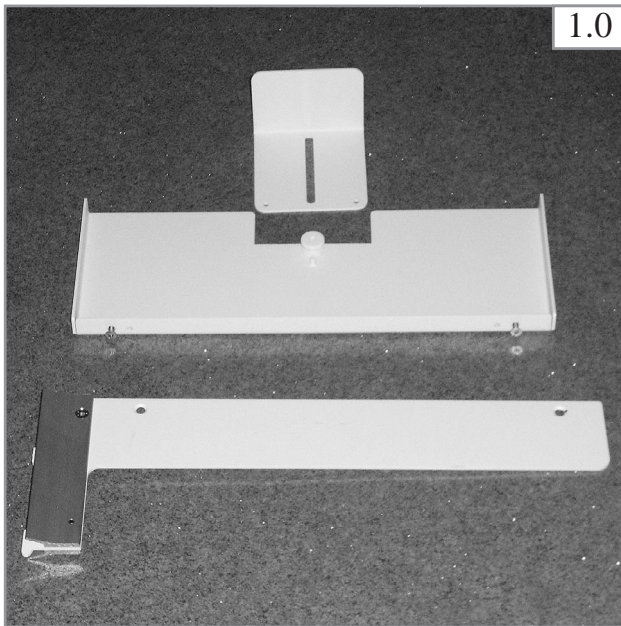

Verpackungsinhalt CPU-Halter
CPU holder packaging contents
Contenu de l'emballage Support UC

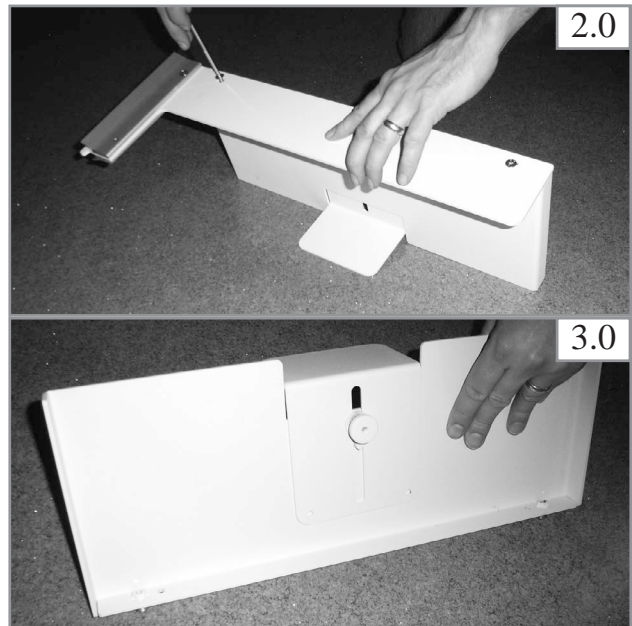

Befestigungsarm und Klemmwinkel an Bodenplatte
schrauben.
Screw fixing arm and clamp elements on to base shelf.

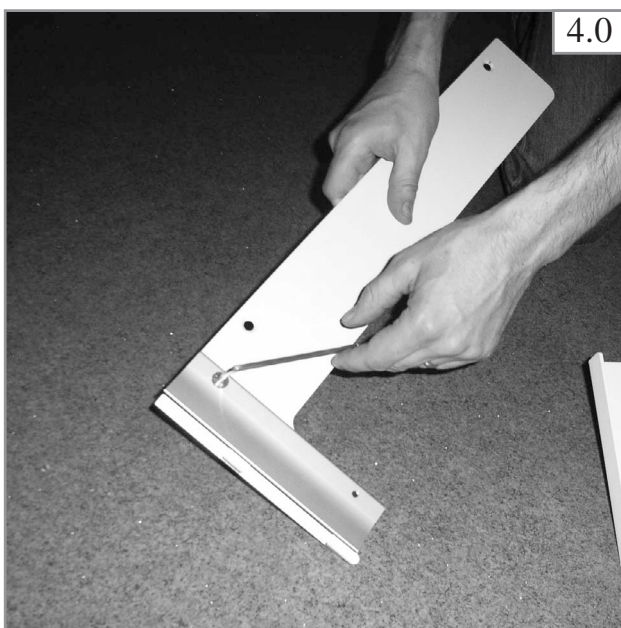

Klemmleiste lockern
Loosen terminal block.
Desserrer la plaque de serrage en alu

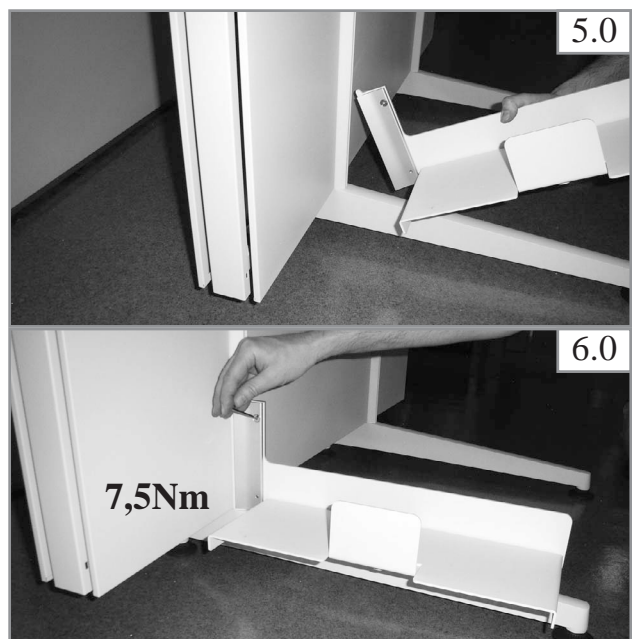

CPU-Halter einhängen und Alu-Klemmleiste festziehen.
Suspend CPU holder and secure aluminium terminal
block by pulling it tight.
Accrocher le support UC au montant de la structure
et serrer la plaque en alu.

FreeWall2

Montageanleitung - CPU-Halter

Assembly instruction - CPU-holder

Notice de montage - étagère UC

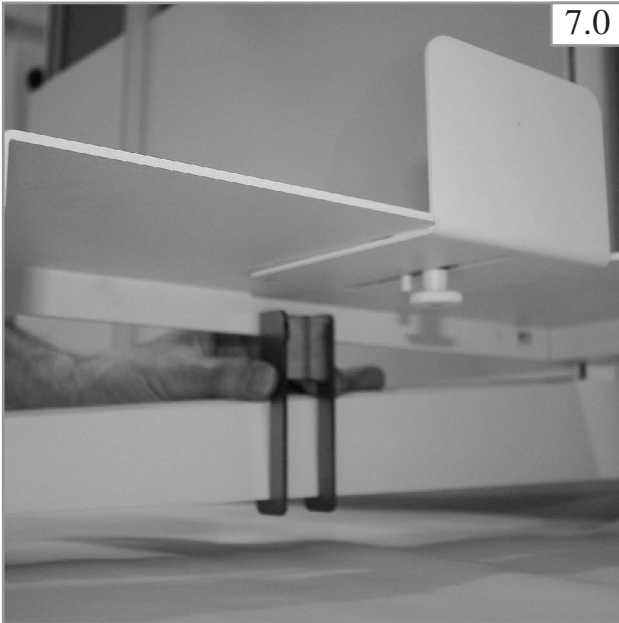

Haltehook einhängen.
Suspend fixation.
Accrocher fixation.

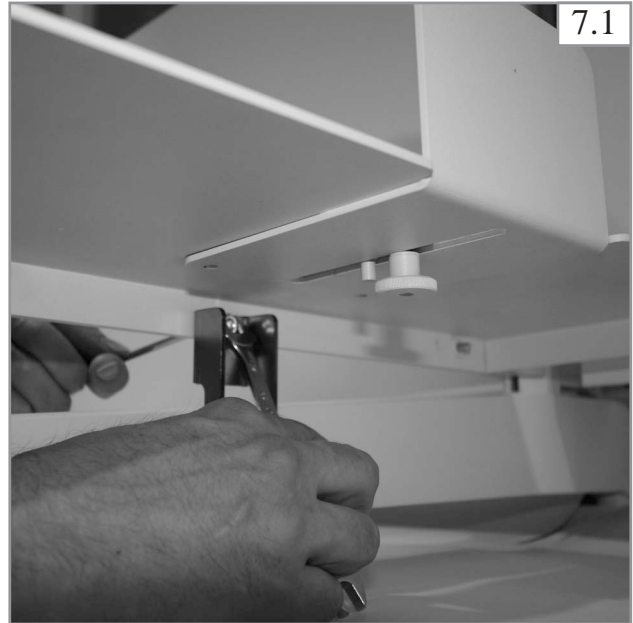

Haltehook festschrauben
Fasten fixation
Visser fixation

FreeWall2

Montageanleitung - Verkettung 45°

Assembly instruction - junction 45°

Notice de montage - liaison 45°

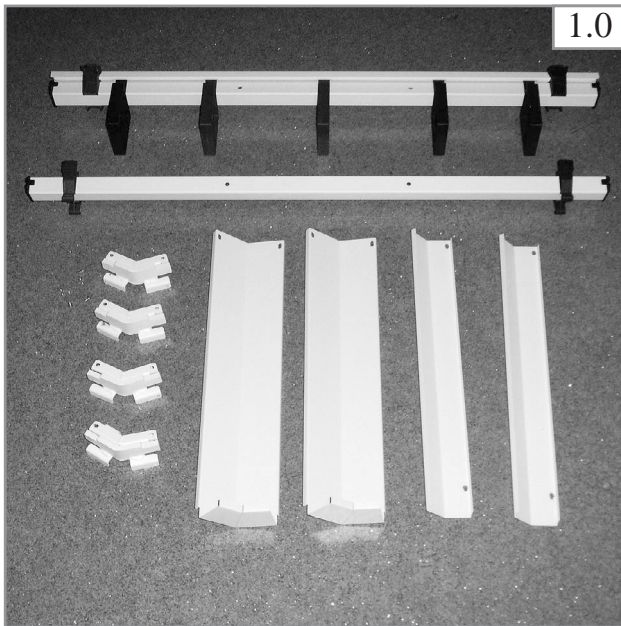

Verpackungsinhalt Verkettung 45°.
45° junction packaging contents
Contenu de l'emballage Liaison 45°

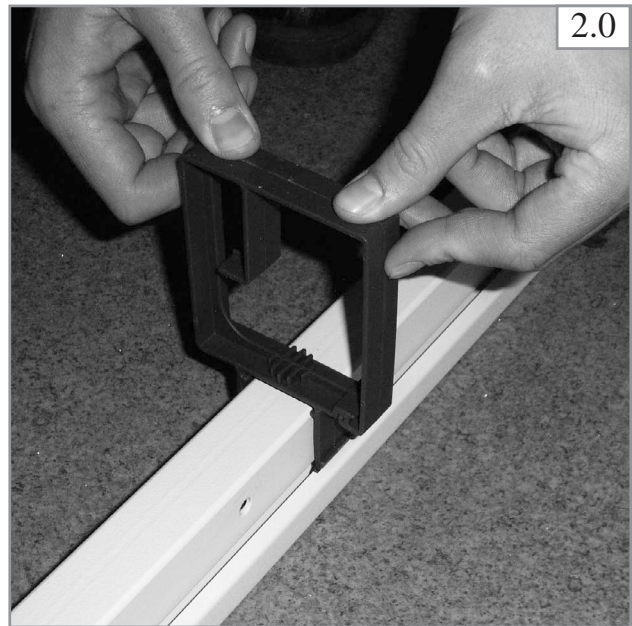

Kabelträger einklipsen.
Attach cable brackets.
Fixer les supports de câbles.

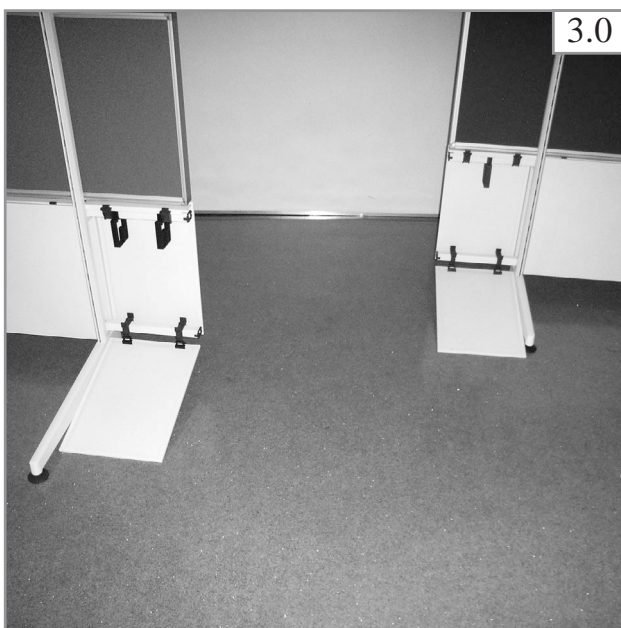

FreeWalls ausrichten und Kabelblenden öffnen.
Align FreeWalls and open cable covers.
Aligner les FreeWalls et ouvrir les cache-câbles.

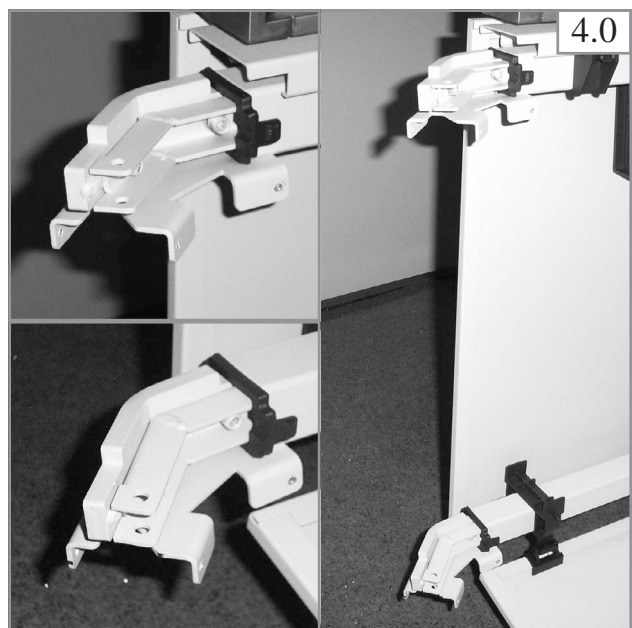

Verbinder in Profile einstecken.
Insert connectors into profile.
Introduire les connecteurs de liaison dans les profilés.

FreeWall2

Montageanleitung - Verkettung 45°

Assembly instruction - junction 45°

Notice de montage - liaison 45°

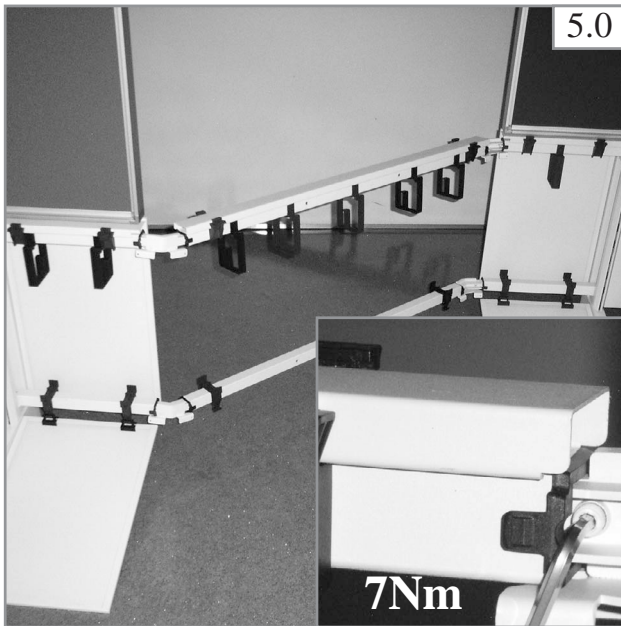

Verkettungsprofile in Verbinder stecken und festschrauben
Insert junction profile into connectors and screw tight.
Monter les profilés de liaison sur les connecteurs et visser.

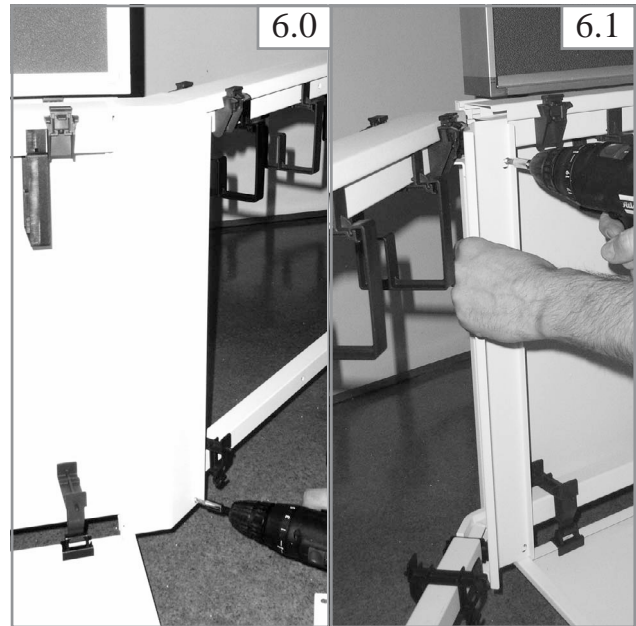

Blenden einhängen und verschrauben aussen/innen.
Suspend covers and tighten outside/inside.
Monter et visser les caches à l'intérieur et l'extérieur

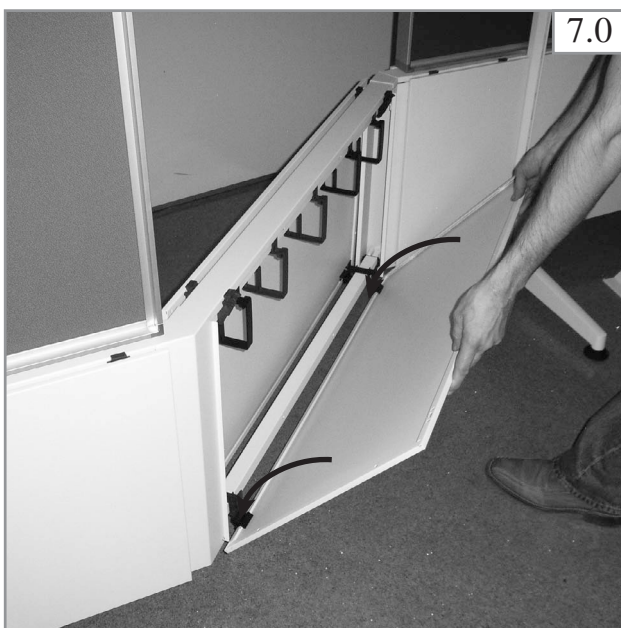

Kabelblenden einklipsen.
Attach cable covers.
Clipser les cache-câbles sur les profilés.



FreeWalls nivellieren.
Level out FreeWalls.
Niveler l'ensemble.

FreeWall2

Montageanleitung - Verkettung linear

Assembly instruction - junction linear

Notice de montage - liaison linéaire

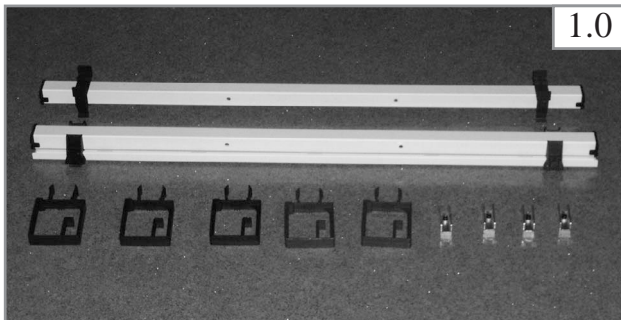

1.0

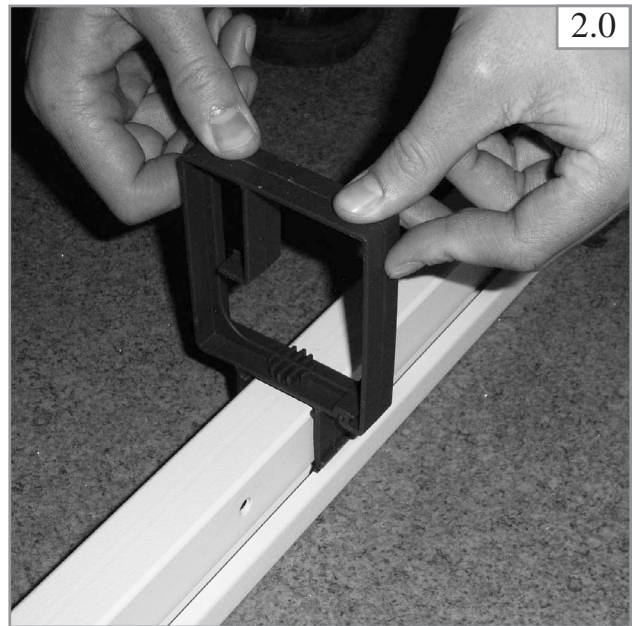

2.0

Verpackungsinhalt Verkettung linear
 Linear junction packaging contents
 Contenu de l'emballage Liaison linéaire

Kabelträger einklipsen.
 Attach cable brackets.
 Fixer les supports de câbles.

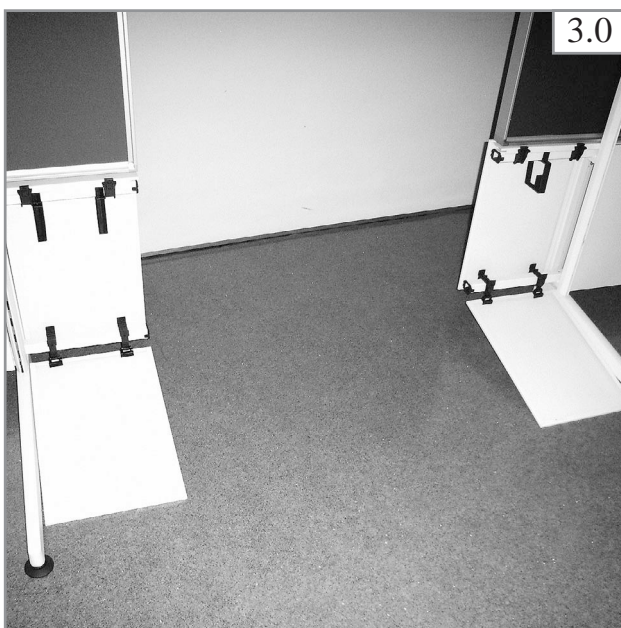

3.0

FreeWalls ausrichten und Kabelblenden öffnen.
 Align FreeWalls and open cable covers.
 Aligner les FreeWalls et ouvrir les cache-câbles.

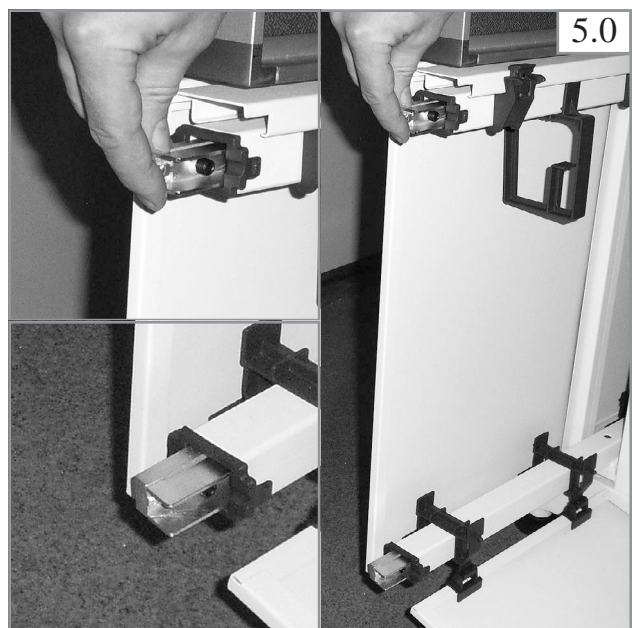

5.0

Verbinder in Profile stecken.
 Insert connectors into profile.
 Introduire les connecteurs de liaison dans les profilés.

FreeWall2

Montageanleitung - Verkettung linear

Assembly instruction - junction linear

Notice de montage - liaison linéaire

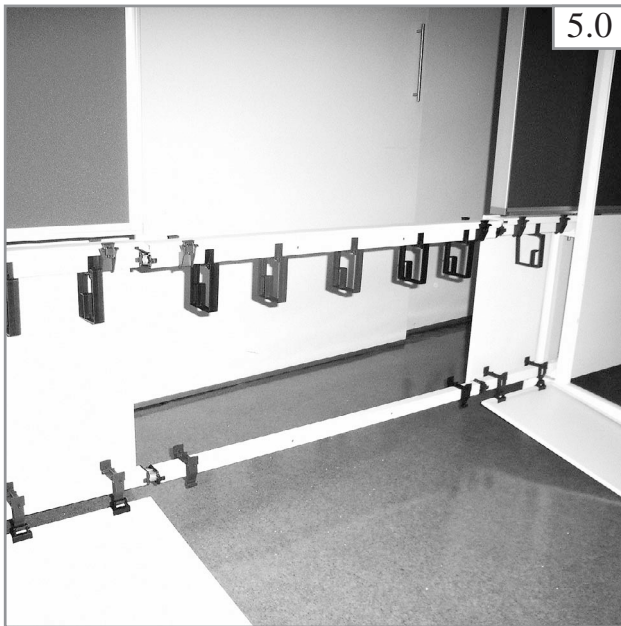

Verkettungsprofile in die Verbinder stecken.
Insert junction profile into connectors.
Monter les profilés de liaison sur les connecteurs.

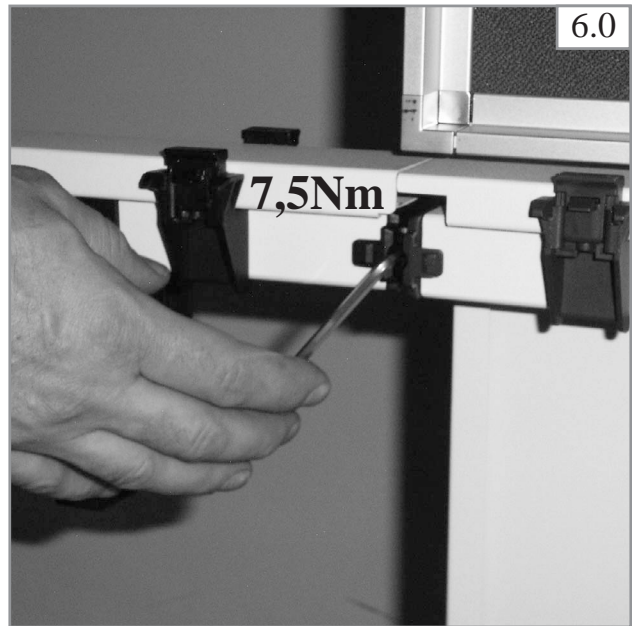

Verkettungsprofile festschrauben.
Screw junction profile tight.
Visser les profilés de liaison.

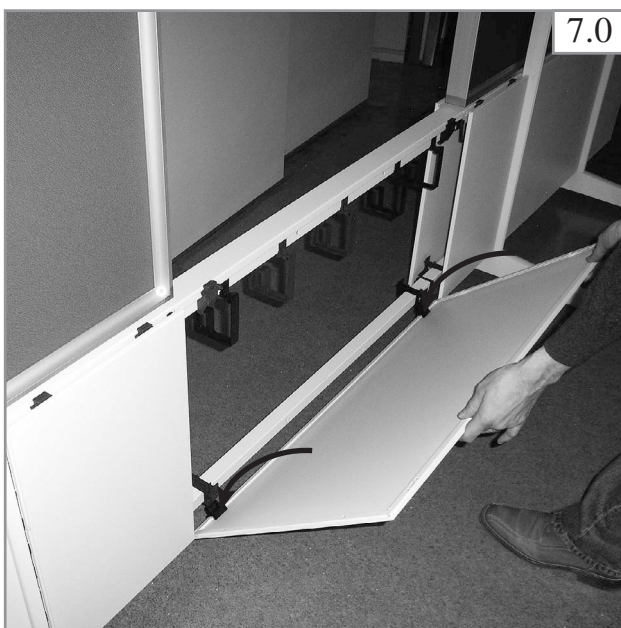

Kabelblenden einklipsen.
Attach cable covers.
Clipser les cache-câbles sur les profilés.



FreeWall nivelieren.
Level out FreeWall.
Niveler l'ensemble.

FreeWall2

Montageanleitung - Druckertisch

Assembly instruction - printer table

Notice de montage - desserte

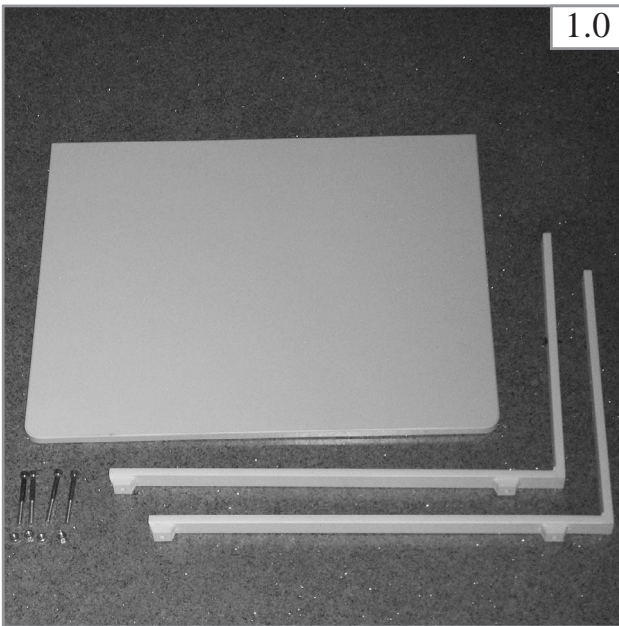

Verpackungsinhalt Druckertisch
Printer table packaging contents
Contenu de l'emballage Desserte

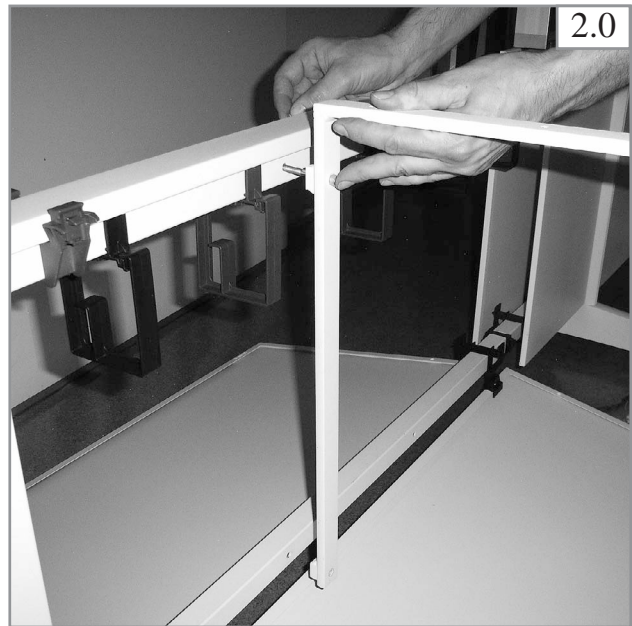

Boardträger an vorgegebener Position anschrauben.
Screw board brackets into required position.
Monter les supports à l'endroit prévu sur la structure.

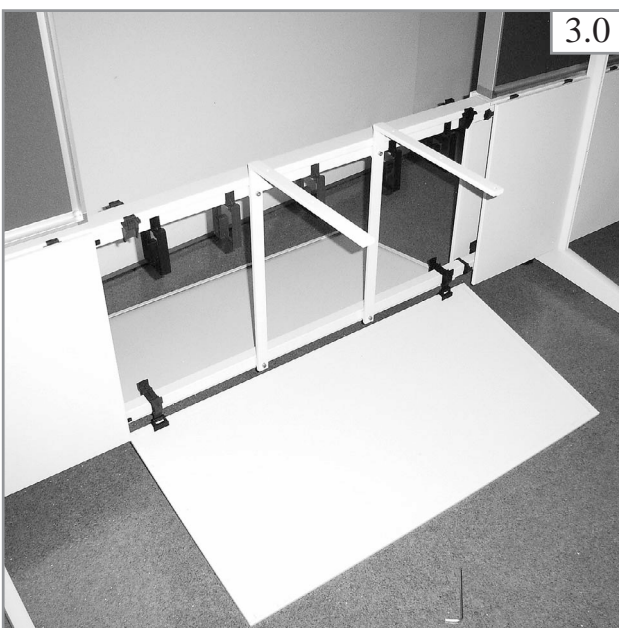

Fertig montierte Boardträger.
Board brackets assembled.
Vue des supports montés

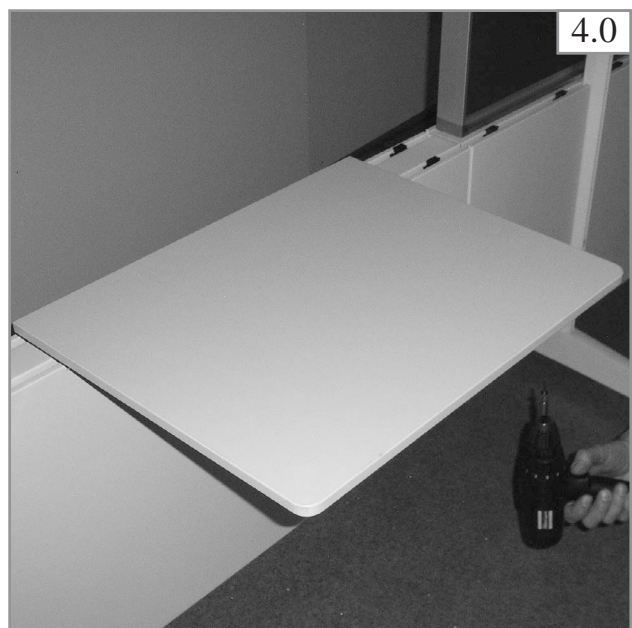

Druckerboard an Boardträger anschrauben.
Screw printer board on to board brackets.
Visser la desserte sur les supports.