

STEP 8: ROUTE CABLES

Cables

- Route cables through the central channel of the Track which runs from the Top Cap, through the Mounts and any Accessory Mount(s).
- Route through the Bottom Cap, which allows room for most common electrical plugs to pass through.

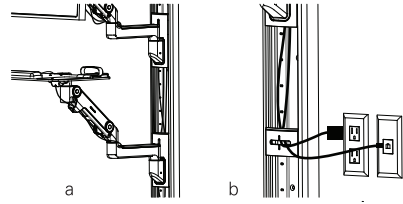

Note: Cable Openings can be used if wires need to exit Track at certain location along the Track.

Monitor Cables

- The M8 includes a cable management system to keep monitor cables organized and protected. Start by inserting cables into Cable Clip.
- Route cables across the bottom of the Upper Arm and around to the top of the Lower Arm. Insert cables into groove on top of the Lower Arm. Place Arm Cover onto the Lower Arm so that the grooves interlock. Slide Arm Cover up until it snaps in place.

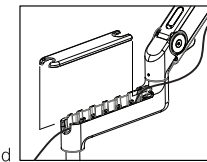
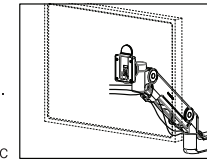

Keyboard and Mouse Cables

- The Keyboard includes a cable management system (underneath the Keyboard) to keep Keyboard cables organized and protected. Start by inserting cables into the top of the Upper Arm.
- Route cables across the bottom of the Upper Arm and around to the top of the Lower Arm. Insert cables into groove on top of the Lower Arm. Place Arm Cover onto the Lower Arm so that the grooves interlock. Slide Arm Cover up until it snaps into place.

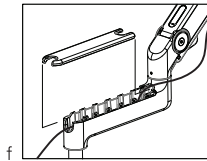
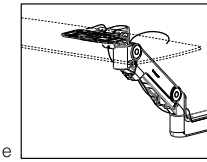

STEP 9: ATTACH CABLE COVERS (Cont.)

Attach Cable Covers

- Align one side of the Cover inside of the Track channel.
- Pushing at the top corner at the opposite side, feed the side into the channel, running the fingers down the side until the Cover is in place.

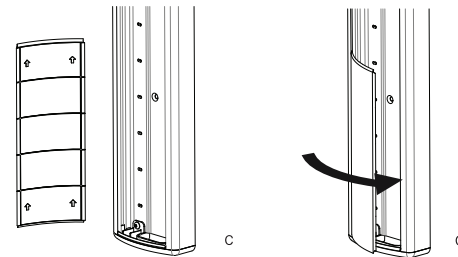

STEP 10: ATTACH CPU HOLDER OR ACCESSORY RAIL (Optional)

Attach CPU Holder

- Align the CPU Holder with the vertical holes in the center of the Accessory Mount. Attach with the two M6 Screws provided with the CPU Holder. Tighten with Hex Key D to secure.

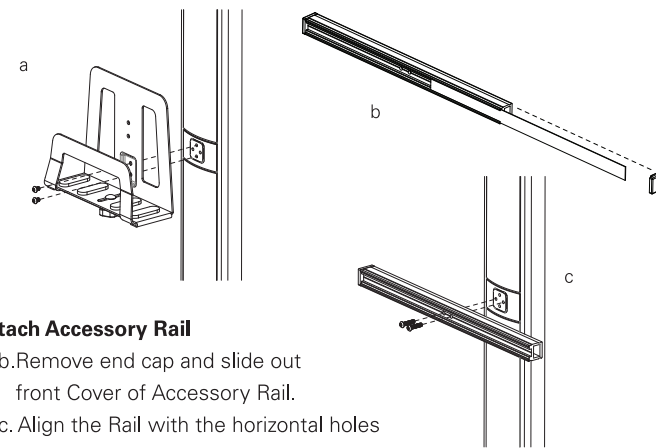

Attach Accessory Rail

- Remove end cap and slide out front Cover of Accessory Rail.
- Align the Rail with the horizontal holes in the center of the Accessory Mount. Attach with the two M6 Screws provided with the Accessory Rail. Tighten with Hex Key D to secure. Slide the front Cover back into the Accessory Rail and push in the end cap.

Note: Maximum load capacity for Accessory Rail is 20 lbs.

STEP 11: PLACE CPU INTO CPU HOLDER

- Loosen other Locking Knob (a) and place CPU into CPU Holder. Slide Front Bracket (b) inward so it sits tightly against CPU. Tighten Locking Knob to secure.

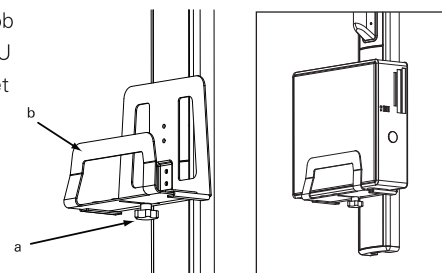

V6 INSTALLATION HARDWARE

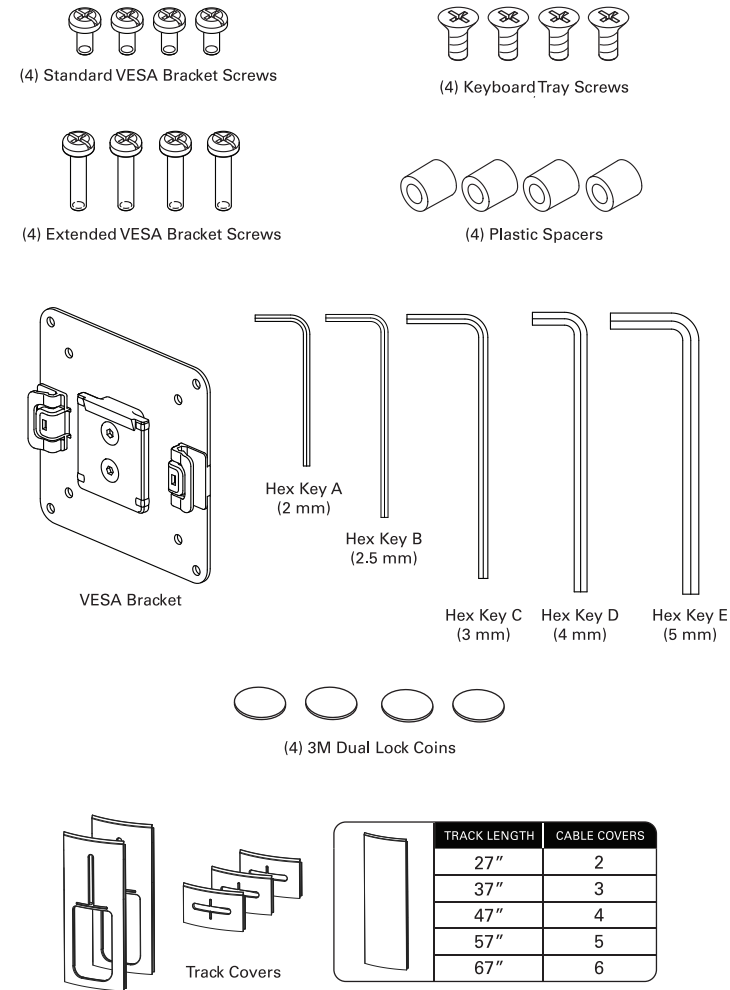

ADDITIONAL HARDWARE REQUIRED

Electric drill

OPTIONAL COMPONENTS

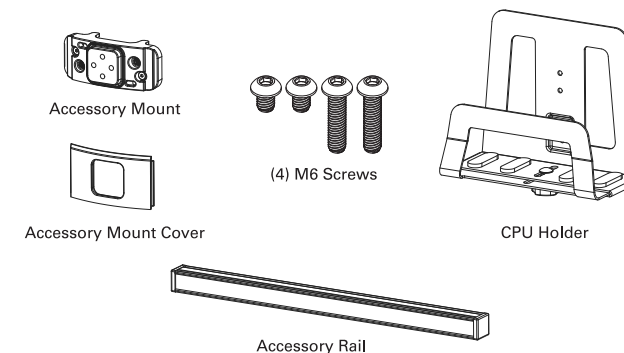

www.humanscalehealthcare.com

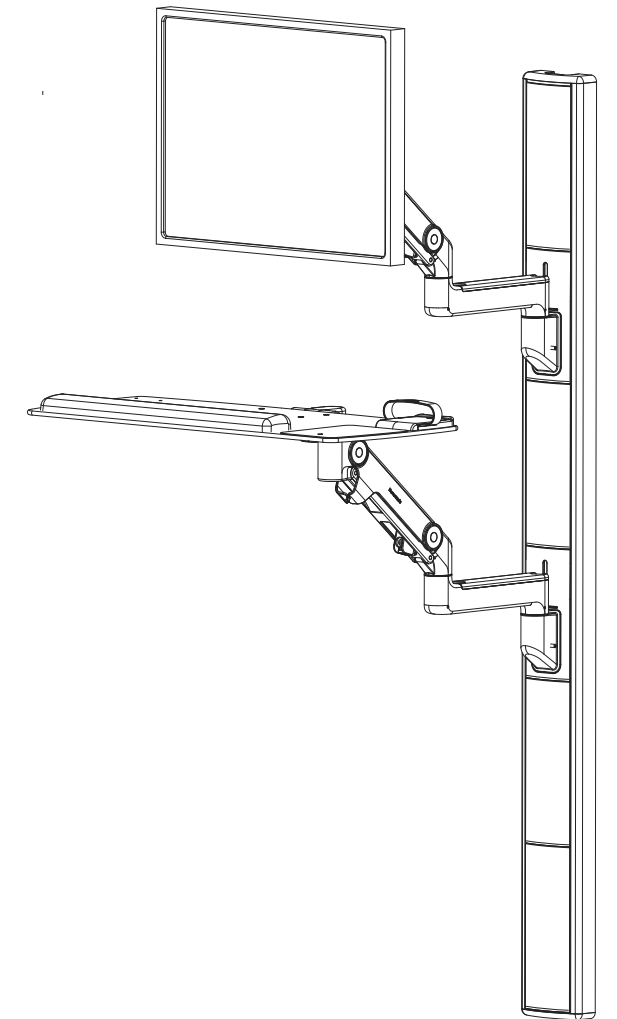

V6 Installation Instructions

The following instructions are based upon the fact that Covers are designed to be installed in a specific orientation in order to minimize openings between Covers. Covers have arrows on the back of them to indicate the top. A Cover should always go on top of the Cover below it. For this reason, it is recommended to install Covers starting at the bottom and working up to the top.

Cutting Cable Covers to Size to Accommodate Accessory Mounts and Cable Openings

- Snap the Cover at the desired location to break the plastic.
- Using scissors or a blade, cut through the overmold layer between the crack that was created.

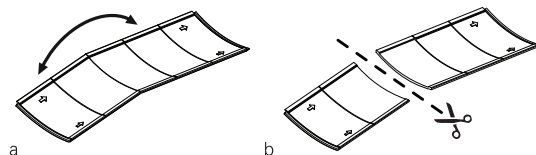

STEP 1: MOUNT TRACK TO WALL

a. For new construction, Track can be mounted to a wall stud or mounting board. For existing construction, test the wall by drilling a pilot hole to determine what fasteners are most suitable for installation. Be sure to drill the pilot hole in a spot that will be covered by the Track.

RECOMMENDATIONS:

For wood – Use 2" #10 (M5, 50 mm) flat-head wood screws.

For metal – Use 2 3/4" #10 (M5, 70 mm) flat-head self-tapping screws.

For drywall – Use 3/16" (M5) flat-head toggle bolts.

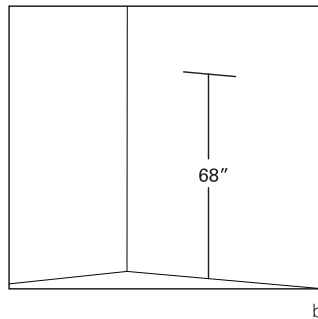

b. Choose the desired hole location for top fastener, ideally 68" (173 cm) off the floor for most tracks. For 67" Tracks, hole should be 78" off the floor. For 27" Tracks, hole should be 58" off the floor. Drill hole and install appropriate fastener.

TRACK LENGTH	HOLE HEIGHT
27"	58"
37"	68"
47"	
57"	
67"	78"

c. Hold Track against the wall and fasten using the appropriate fastener in pre-drilled hole.

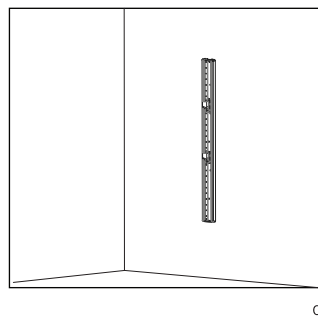

d. Use level to ensure Track is perfectly plumb. Mark the other mounting hole locations.

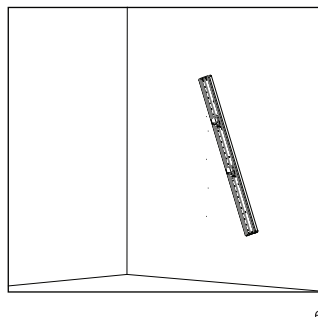

e. Pre-drill the remaining mounting holes and install appropriate fastener.

f. Fasten Track with appropriate fasteners in the remaining mounting holes. Be sure to fully tighten so fastener heads do not protrude beyond Track surface.

STEP 2: ADJUST ARM MOUNT LOCATION (Optional)

Assuming that the Track was mounted to the wall at the recommended height, the Arm Mounts will already be in the correct ergonomic position for the majority of people for standing use.

Change Position of Arm Mount Location

- Loosen the Friction Feet with Hex Key C.
- Slide each Mount up or down the Track to the desired location.
- Tighten the Feet. You must tighten down the Friction Feet in order to complete installation of the Arm Mount to the Track. The Arm Mount will not be able to support any weight if it is not tightened down first. Feet must be tightened down to a torque of 30 in-lbs. [3.4 Nm] to ensure safe operation.

Note: It is recommended to position the Mounts in a detent to allow for the best possible Cover fit in step 9.

Attach the Arm Mount Covers to the Arm Mounts

- Align one side of the Cover inside of the Track channel.
- Push in the Crush Rib on that side. By pushing at the top corner at the opposite side, feed the side into the channel, running fingers down the side and pushing in the Crush Rib at the bottom. Push on the middle of the Cover to engage the snap feature.

Note: User must install the Arm Mount Covers before the Arms otherwise they cannot be put onto the Track.

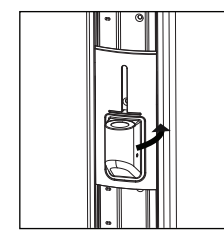
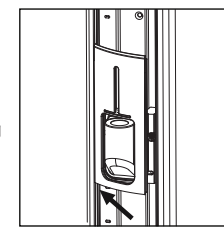
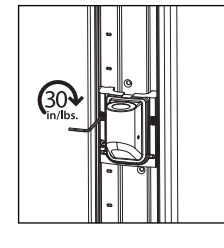
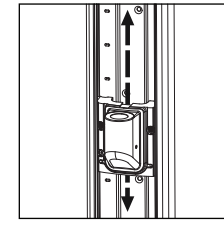
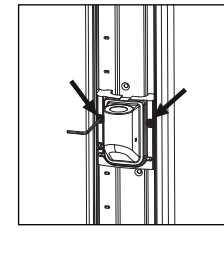

STEP 3: ATTACH MONITOR AND KEYBOARD ARMS

Attach Monitor Arm

- Remove Set Screws on Arm Mounts.
- Drop pin of Monitor Arm into hole of upper Arm Mount. Screw in the Set Screw with Hex Key B.

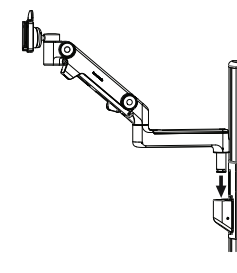
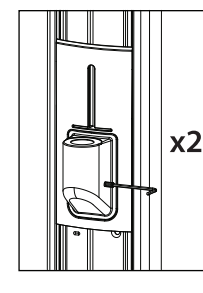

STEP 3: ATTACH MONITOR AND KEYBOARD ARMS (Contd.)

Attach Keyboard Arm

- Drop pin of Keyboard Arm into hole of lower Arm Mount. Screw in the Set Screw.

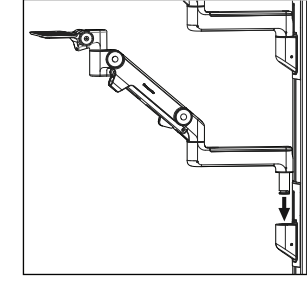

STEP 4: ATTACH KEYBOARD TRAY TO KEYBOARD ARM

- Place Keyboard Tray on top of Keyboard Arm and align holes.
- Fasten Keyboard Tray to Keyboard Arm using (4) Keyboard Tray Installation Screws.
- Snap Palm Rest into the holes on Keyboard Tray.

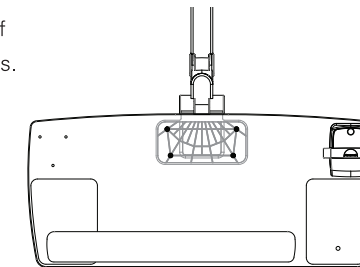

STEP 5: ATTACH KEYBOARD TO KEYBOARD TRAY

- Place (4) 3M Dual Lock Coins on the underside of Keyboard.
- Once attached, remove the film from the exposed sides of Dual Lock Coins and attach Keyboard Tray.

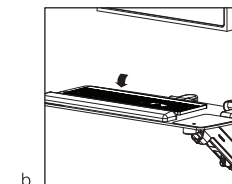
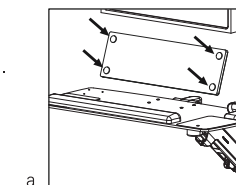

STEP 6: ATTACH MONITOR TO MONITOR ARM

- Slide VESA Bracket into Ball Joint until it clicks.
- To remove, depress Quick-Release Tab and slide monitor up and away from Arm.
- If security is required, tighten Security Screw using Hex Key A.

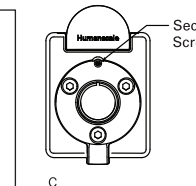
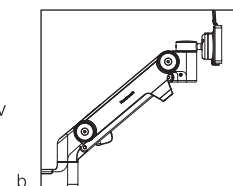
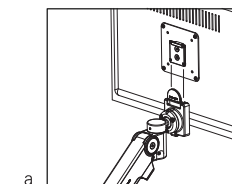

STEP 7: ATTACH ACCESSORY MOUNT TO TRACK (Optional)

Attach Accessory Mount to Track

- Vertically insert Accessory Mount into the Track cavity. Push down.
- Rotate the Mount until it is horizontal.
- The Spring Feet will engage, allowing the user to slide the Mount up or down to the desired position.
- Using Hex Key C, you must tighten down the Friction Feet in order to complete installation of the Accessory Mount to the Track. The Accessory Mount will not be able to support any weight if it is not tightened down first. Feet must be tightened down to a torque of 30 in-lbs. [3.4 Nm] to ensure safe operation.

Note: It is recommended to position the Mounts in a detent to allow for the best possible Cover fit in step 9.

Attach the Accessory Mount Cover to the Accessory Mount

- Note the up arrow on the back of the Cover to determine which end is up.
- Align one side of the Cover inside of the Track channel. Push in the Crush Rib on that side.
- By pushing at the top corner at the opposite side, feed the side into the channel, running fingers down the side and pushing in the Crush Rib at the bottom.

Note: You must install the Accessory Mount Cover before attaching accessories otherwise the Cover cannot be put onto the Track.

To remove the Accessory Mount, loosen the Feet (if necessary), push Accessory Mount into Track and rotate to pull out.

