

<b>DE</b>	Gebrauchsanleitung / Montageanleitung	<b>2</b>
<b>FR</b>	Mode d'emploi / Instructions de montage	<b>3</b>
<b>EN</b>	Instructions for use / assembly instructions	<b>4</b>
<b>IT</b>	Istruzioni per l'uso / Istruzioni per Installazione	<b>5</b>
<b>ES</b>	Modo de empleo / Instrucciones de montaje	<b>6</b>
<b>NL</b>	Gebruiksaanwijzing / Handleiding	<b>7</b>
<b>DK</b>	Brugsanvisning / Monteringsvejledning	<b>8</b>
<b>PT</b>	Instruções para uso / Manual de Instalação	<b>9</b>
<b>PL</b>	Instrukcja obsługi / Instrukcja montażu	<b>10</b>
<b>CS</b>	Návod k použití / Montážní návod	<b>11</b>
<b>SK</b>	Návod na použitie / Montážny návod	<b>12</b>
<b>ZH</b>	用户手册 / 组装说明	<b>13</b>
<b>RU</b>	Руководство пользователя / Инструкция по монтажу	<b>14</b>
<b>HU</b>	Használati útmutató / Szerelési útmutató	<b>15</b>
<b>FI</b>	Käyttöohje / Asennusohje	<b>16</b>
<b>SV</b>	Bruksanvisning / Monteringsanvisning	<b>17</b>
<b>LT</b>	Vartotojo instrukcija / Montavimo instrukcijos	<b>18</b>
<b>HR</b>	Upute za uporabu / Uputstva za instalaciju	<b>19</b>
<b>TR</b>	Kullanım kılavuzu / Montaj kılavuzu	<b>20</b>
<b>RO</b>	Manual de utilizare / Instrucțiuni de montare	<b>21</b>
<b>EL</b>	Οδηγίες χρήσης / Οδηγία συναρμολόγησης	<b>22</b>
<b>SL</b>	Navodilo za uporabo / Navodila za montažo	<b>23</b>
<b>ET</b>	Kasutusjuhend / Paigaldusjuhend	<b>24</b>
<b>LV</b>	Lietošanas pamācība / Montāžas instrukcija	<b>25</b>
<b>SR</b>	Uputstvo za upotrebu / Uputstvo za montažu	<b>26</b>
<b>NO</b>	Bruksanvisning / Montasjeveiledning	<b>27</b>
<b>BG</b>	Инструкция за употреба / Инструкция за употреба	<b>28</b>
<b>SQ</b>	Udhëzuesi i përdorimit / Udhëzime rreth montimit	<b>29</b>
<b>AR</b>	دليل الاستخدام / تعليمات التجميع	<b>30</b>

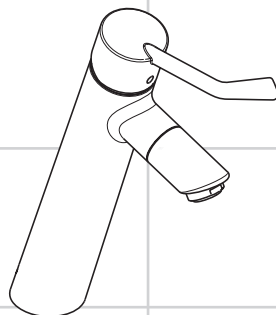

**Talis Care**  
32036000

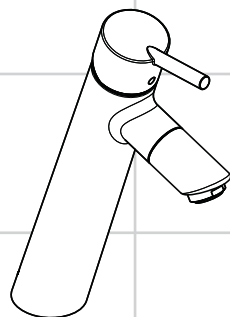

**Talis**  
32052000

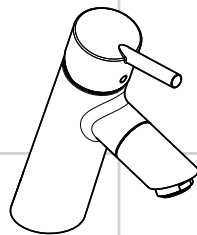

**Talis**  
32053000



## Sicherheitshinweise

- ⚠ Bei der Montage müssen zur Vermeidung von Quetsch- und Schnittverletzungen Handschuhe getragen werden.
- ⚠ Das Produkt darf nur zu Bade-, Hygiene- und Körperreinigungszwecken eingesetzt werden.
- ⚠ Große Druckunterschiede zwischen den Kalt- und Warmwasseranschlüssen müssen ausgeglichen werden.

## Montagehinweise

- Die Armatur muss nach den gültigen Normen montiert, gespült und geprüft werden.
- Bei Problemen mit dem Durchlauferhitzer oder wenn mehr Wasserdurchsatz gewünscht wird, kann der EcoSmart® (Durchflussbegrenzer), der hinter dem Luftsprudler sitzt, entfernt werden.
- Vor der Montage muss das Produkt auf Transportschäden untersucht werden. Nach dem Einbau werden keine Transport- oder Oberflächenschäden anerkannt.

## Technische Daten

### Armatur serienmäßig mit EcoSmart®

(Durchflussbegrenzer)

Betriebsdruck:	max. 1 MPa
Empfohlener Betriebsdruck:	0,1 – 0,5 MPa
Prüfdruck:	1,6 MPa
(1 MPa = 10 bar = 147 PSI)	
Heißwassertemperatur:	max. 80 °C
Empfohlene Heißwassertemperatur:	65 °C
Thermische Desinfektion:	max. 70 °C / 4 min

Hansgrohe Armaturen können in Verbindung mit hydraulisch und thermisch gesteuerten Durchlauferhitzern eingesetzt werden, wenn der Fließdruck mindestens 0,15 MPa beträgt.

Das Produkt ist ausschließlich für Trinkwasser konzipiert!

## Symbolerklärung



### Justierung

Einhandmischer mit Warmwasserbegrenzung, Justierung siehe Seite 38. In Verbindung mit Durchlauferhitzern ist eine Warmwassersperre nicht notwendig.



Kein essigsäurehaltiges Silikon verwenden!



### Reinigung

siehe beiliegende Broschüre.



### Maße (siehe Seite 34)



### Durchflussdiagramm

(siehe Seite 35)

- ① mit EcoSmart®
- ② ohne EcoSmart®



### Bedienung (siehe Seite 39)

Hansgrohe empfiehlt, morgens oder nach längeren Stagnationszeiten den ersten halben Liter nicht als Trinkwasser zu verwenden.



### Serviceteile (siehe Seite 36)



### Sonderzubehör

Montageschlüssel 58085000 (nicht im Lieferumfang enthalten)



Installationskit (nicht im Lieferumfang enthalten)





### Prüfzeichen (siehe Seite 40)



## Montage siehe Seite 31



## Consignes de sécurité

-  Lors du montage, porter des gants de protection pour éviter toute blessure par écrasement ou coupure.
-  Le système de douche ne doit servir qu'à se laver et à assurer l'hygiène corporelle.
-  Il est conseillé d'équilibrer les pressions de l'eau chaude et froide.

## Instructions pour le montage

- La robinetterie doit être installée, rincée et contrôlée conformément aux normes valables.
- En cas de problèmes avec le chauffe-eau, ou bien si le débit d'eau doit être plus important, il est possible d'enlever l'EcoSmart® (limiteur de débit) se trouvant derrière l'aérateur.
- Avant son montage, s'assurer que le produit n'a subi aucun dommage pendant le transport. Après le montage, tout dommage de transport ou de surface ne pourra pas être reconnu.

## Informations techniques

### Robinetterie équipée en série d'un EcoSmart® (limiteur de débit)

Pression de service autorisée:	max. 1 MPa
Pression de service conseillée:	0,1 – 0,5 MPa
Pression maximum de contrôle: (1 MPa = 10 bar = 147 PSI)	1,6 MPa
Température d'eau chaude:	max. 80 °C
Température recommandée:	65 °C
Désinfection thermique:	max. 70 °C / 4 min

Les mitigeurs Hansgrohe fonctionnent également en association à des chauffe-eau à commande hydraulique ou thermique à condition que la pression soit au minimum de 0,15 MPa.

Le produit est exclusivement conçu pour de l'eau potable!

## Description du symbole



### Étalonnage

Mitigeur avec limitation de la température: consulter la page 38 pour le réglage. Une limitation de la température n'est pas nécessaire quand le mitigeur est alimenté par un chauffe-eau instantané.



Ne pas utiliser de silicone contenant de l'acide acétique!



### Nettoyage

voir la brochure ci-jointe.



### Dimensions (voir page 34)



### Diagramme du débit (voir page 35)

- ① avec EcoSmart®
- ② sans EcoSmart®



### Instructions de service (voir page 39)

Hansgrohe recommande de ne pas utiliser le premier demi-litre le matin ou après une période de stagnation prolongée.



### Pièces détachées (voir pages 36)



### Accessoires en option

clé de montage 58085000 (ne fait pas partie de la fourniture)



Mastic d'installation (ne fait pas partie de la fourniture)





### Classification acoustique et débit (voir page 40)





## Safety Notes

-  Gloves should be worn during installation to prevent crushing and cutting injuries.
-  The shower system may only be used for bathing, hygienic and body cleansing purposes.
-  The hot and cold supplies must be of equal pressures.

## Installation Instructions

- The fitting must be installed, flushed and tested after the valid norms.
- If the instantaneous water heater causes problems or if you wish to increase the water flow, the EcoSmart® (flow limiter) located behind the aerator can be removed.
- Prior to installation, inspect the product for transport damages. After it has been installed, no transport or surface damage will be honoured.

## Technical Data

**This mixer series-produced with EcoSmart® (flow limiter)**

Operating pressure:	max. 1 MPa
Recommended operating pressure:	0,1 – 0,5 MPa
Test pressure:	1,6 MPa
(1 MPa = 10 bar = 147 PSI)	
Hot water temperature:	max. 80 °C
Recommended hot water temp.:	65 °C
Thermal disinfection:	max. 70 °C / 4 min

Hansgrohe mixers can be used together with hydraulically and thermally controlled continuous flow heaters if the flow pressure is at least 0,15 MPa.

The product is exclusively designed for drinking water!

## Symbol description



### Adjustment

To adjust the hot water limiter on single lever mixers, please see page 38. No adjustment is necessary when using a continuous flow water heater.



Do not use silicone containing acetic acid!



### Cleaning

see enclosed brochure.



### Dimensions (see page 34)



### Flow diagram (see page 35)

- ① with EcoSmart®
- ② without EcoSmart®



### Operation (see page 39)

Hansgrohe recommends not to use as drinking water the first half liter of water drawn in the morning or after a prolonged period of non-use.



### Spare parts (see page 36)



### Special accessories

special tool 58085000 (order as an extra)



Installation putty (order as an extra)





### Test certificate (see page 40)



## Assembly see page 31



## **Indicazioni sulla sicurezza**

-  Durante il montaggio, per evitare ferite da schiacciamento e da taglio bisogna indossare guanti protettivi.
-  Il sistema doccia deve essere utilizzato esclusivamente per l'igiene del corpo.
-  Attenzione! Compensare le differenze di pressione tra i collegamenti dell'acqua fredda e dell'acqua calda.

## **Istruzioni per il montaggio**

- La rubinetteria deve essere installata, pulita e testata secondo le istruzioni riportate!
- Nel caso di problemi con lo scaldacqua oppure nel caso si desiderasse più erogazione, si può eliminare il EcoSmart® (limitatore di flusso) che si trova dietro la valvola di aerazione.
- Prima del montaggio è necessario controllare che non ci siano stati danni durante il trasporto. Una volta eseguito il montaggio, non verranno riconosciuti eventuali danni di trasporto o delle superfici.

## **Dati tecnici**

**Questo miscelatore è dotato di serie del EcoSmart® (limitatore di flusso)**

Pressione d'uso:	max. 1 MPa
Pressione d'uso consigliata:	0,1 - 0,5 MPa
Pressione di prova:	1,6 MPa
(1 MPa = 10 bar = 147 PSI)	
Temperatura dell'acqua calda:	max. 80 °C
Temp. dell'acqua calda consigliata:	65 °C
Disinfezione termica:	max. 70 °C / 4 min

I miscelatori Hansgrohe possono venire usati con caldaie a "bassa pressione" se la pressione di flusso è almeno di 0,15 MPa.

Il prodotto è concepito esclusivamente per acqua potabile!

## **Descrizione simbolo**



### **Taratura**

Regolazione del limitatore di erogazione di acqua calda dei miscelatori monocomando, vedere pagina 38. In combinazione con le caldaie istantanee, il limitatore di erogazione di acqua calda non è necessario.



Non utilizzare silicone contenente acido acetico!



### **Pulitura**

vedi il prospetto accluso.



### **Ingombri (vedi pagg. 34)**



### **Diagramma flusso (vedi pagg. 35)**

- ① con EcoSmart®
- ② senza EcoSmart®



### **Procedura (vedi pagg. 39)**

Hansgrohe raccomanda, di mattina oppure dopo lunghi tempi di stagnazione, di non utilizzare il primo mezzo litro come acqua potabile.



### **Parti di ricambio (vedi pagg. 36)**



### **Accessori speciali**

chiave per montaggio 58085000 (non contenuto nel volume di fornitura)



Mastice d'installazione (non contenuto nel volume di fornitura)



### **Segno di verifica (vedi pagg. 40)**





## Indicaciones de seguridad

- ⚠ Durante el montaje deben utilizarse guantes para evitar heridas por aplastamiento o corte.
- ⚠ La grifería solo debe ser utilizada para fines de baño, higiene y limpieza corporal.
- ⚠ Grandes diferencias de presión en servicio entre agua fría y agua caliente deben equilibrarse.

## Indicaciones para el montaje

- El grifo tiene que ser instalado, probado y testado, según las normas en vigor.
- En caso de problemas con el calentador instantáneo o cuando se desee más caudal de agua puede quitarse el EcoSmart® (limitador de caudal), situado detrás del aireador.
- Antes del montaje se debe examinarse el producto contra daños de transporte. Después de la instalación so se reconoce ningún daño de transporte o de superficie.

## Datos técnicos

### Grifo, desde fábrica equipado con EcoSmart®

(limitador de caudal)

Presión en servicio: max. 1 MPa

Presión recomendada en servicio: 0,1 - 0,5 MPa

Presión de prueba: 1,6 MPa

(1 MPa = 10 bar = 147 PSI)

Temperatura del agua caliente: max. 80 °C

Temp. recomendada del agua caliente: 65 °C

Desinfección térmica: max. 70 °C / 4 min

Los mezcladores Hansgrohe pueden ser utilizados junto con calentadores continuos de agua que sean manejados de manera hidráulica o térmica, siempre que la presión en servicio ascienda a un mínimo de 0,15 MPa.

El producto ha sido concebido exclusivamente para agua potable.

## Descripción de símbolos



### Ajuste

Uso como mezclador monomando con limitación del caudal de agua caliente: ver ajuste en página 38. En combinación con calentadores instantáneos no es necesario limitar el caudal de agua caliente.



No utilizar silicona que contiene ácido acético!



### Limpiar

ver el folleto adjunto.



### Dimensiones (ver página 34)



### Diagrama de circulación (ver página 35)

① con EcoSmart®

② sin EcoSmart®



### Manejo (ver página 39)

Hansgrohe recomienda no utilizar el primer medio litro como agua potable por las mañanas o tras un largo periodo de inactividad.



### Repuestos (ver página 36)



### Opcional

Llave de montaje 58085000 (no incluido en el suministro)



Masilla (no incluido en el suministro)





Marca de verificación (ver página 40)



## Montaje ver página 31



## Veiligheidsinstructies

-  Bij de montage moeten ter voorkoming van kniel- en snijwonden handschoenen worden gedragen.
-  Het douchesysteem mag alleen voor het wassen, hygiënische doeleinden en voor de lichaamreiniging worden gebruikt.
-  Grote drukverschillen tussen de koud- en warmwater-toevoer dienen vermeden te worden.

## Montage-instructies

- Leidingen doorspoelen volgens Norm. De mengkraan vervolgens monteren en controleren.
- Wanneer problemen optreden bij doorloopgeisers of wanneer een grotere waterdoorvoer gewenst is, kan de EcoSmart® (doorstroombegrenzer) die achter de perlator is gemonteerd, makkelijk verwijderd worden.
- Vóór de montage moet het product gecontroleerd worden op transportschade. Na de inbouw wordt geen transport- of oppervlakteschade meer aanvaard.

## Technische gegevens

### Armatuur standaard met EcoSmart®

(doorstroombegrenzer)	
Werkdruk: max.	max. 1 MPa
Aanbevolen werkdruk:	0,1 - 0,5 MPa
Getest bij:	1,6 MPa
(1 MPa = 10 bar = 147 PSI)	
Temperatuur warm water:	max. 80 °C
Aanbevolen warm water temp.:	65 °C
Thermische desinfectie:	max. 70 °C / 4 min

Hansgrohe kranen kunnen samen met hydraulisch en thermisch gestuurde geisers gebruikt worden indien de uitstroomdruk min. 0,15 MPa bedraagt.

Het product is uitsluitend ontworpen voor drinkwater!

## Symboolbeschrijving



### Instellen

Eéngreepsmengkranen met warmwaterbegrenzing, instelling zie blz. 38. In combinatie met geisers is een warmwaterbegrenzing niet noodzakelijk.



Gebruik geen zuurhoudende silicone!



### Reinigen

zie bijgevoegde brochure.



### Maten (zie blz. 34)



### Doorstroomdiagram (zie blz. 35)

- ① met EcoSmart®
- ② zonder EcoSmart®



### Bediening (zie blz. 39)

Hansgrohe raadt aan om ,s morgens na langere stagnatietijden de eerste halve liter niet als drinkwater te gebruiken.



### Service onderdelen (zie blz. 36)



### Toebehoren

montagesleutel 58085000 (behoort niet tot het leveringspakket)



Kit (behoort niet tot het leveringspakket)



### Keurmerk (zie blz. 40)



## Montage zie blz. 31



## Sikkerhedsanvisninger

- △ Ved monteringen skal der bruges handsker for at undgå kvæstelser og snitsår.
- △ Brusersystemet må kun bruges til bade-, hygiejne og rengøringsformål.
- △ Større trykforskel mellem koldt og varmt vand bør udjævnes.

## Monteringsanvisninger

- Ifølge gældende regler, skal armaturet monteres, skylles igennem og afprøves.
- Ved problemer med gennemløbsvandvarmer eller hvis der ønskes mere vandgennemstrømning, kan EcoSmart® (gennemstrømningsbegrænseren), der sidder i perlatoren, fjernes.
- Før monteringen skal produktet kontrolleres for transportskader. Efter monteringen godkendes transportskader eller skader på overfladen ikke længere.

## Tekniske data

### Armaturet er forsynet med EcoSmart®

(gennemstrømningsbegrænser)

Driftstryk:	max. 1 MPa
Anbefalet driftstryk:	0,1 – 0,5 MPa
Prøvetryk:	1,6 MPa
(1 MPa = 10 bar = 147 PSI)	
Varmtvandstemperatur:	max. 80 °C
Anbefalet varmtvandstemperatur:	65 °C
Termisk desinfektion:	max. 70 °C / 4 min
Desinfecção térmica:	max. 70 °C / 4 min

Hansgrohe armaturer kan anvendes i forbindelse med hydraulisk- og termiskstyrede gennemstrømningsvandvarmere ved et vandtryk på 0,15 MPa.

Produktet er udelukkende beregnet til drikkevand!

## Symbolbeskrivelse



### Forindstilling

Etgrebsarmaturer med varmtvandsbegrænsning, justering se side 38. I forbindelse med gennemstrømningsvandvarmer er en varmtvandsbegrænsning ikke nødvendig.



Der må ikke benyttes eddikesyreholdig silikone!



### Rengøring

se venligst den vedlagte brochure.



### Målene (se s. 34)



### Gennemstrømningsdiagram (se s. 35)

- ① med EcoSmart®
- ② uden EcoSmart®



### Bediening (se s. 39)

Hansgrohe anbefaler at den første halve liter om morgenen eller efter længere stagneringstider ikke anvendes som drikkevand.



### Reserve dele (se s. 36)



### Specialtilbehør

Monteringsnøgle 58085000 (ikke med i leveringsomfang)



Kit (ikke med i leveringsomfang)





### Godkendelse (se s. 40)







## Avisos de segurança

-  Durante a montagem devem ser utilizadas luvas de protecção, de modo a evitar ferimentos resultantes de entalamentos e de cortes.
-  O sistema de duche só pode ser utilizado para fins de higiene pessoal.
-  Grandes diferenças entre as pressões das águas quente e fria devem ser compensadas.

## Avisos de montagem

- A misturadora deve ser instalada, purgada e testada de acordo com as normas em vigor.
- Em caso de problemas com o esquentador de água ou se desejar maior débito de água, é possível retirar o EcoSmart® (limitador de caudal), situado por trás do emulsor.
- Antes da montagem deve-se controlar o produto relativamente a danos de transporte. Após a montagem não são aceites quaisquer danos de transporte ou de superfície.

## Dados Técnicos

### Misturadoras produzidas em série com EcoSmart® (limitador de caudal)

Pressão de funcionamento:	max. 1 MPa
Pressão de func. recomendada:	0,1 – 0,5 MPa
Pressão testada:	1,6 MPa
(1 MPa = 10 bar = 147 PSI)	
Temperatura da água quente:	max. 80°C
Temp. água quente recomendada:	65°C

As misturadoras Hansgrohe podem ser utilizadas com esquentadores (de controlo térmico ou hidráulico) desde que a pressão de utilização seja, no mínimo, de 0,15 MPa.

Este produto foi única e exclusivamente concebido para água potável!

## Descrição do símbolo



### Afinação

Misturadora monocomando equipada com limitador de temperatura (vide pàg. 38). Em combinação com caldeira ou esquentador instantâneo o limitador de água quente não se aplica.



Não utilizar silicone que contenha ácido acético!



### Limpeza

consultar a seguinte brochura.



### Medidas (ver página 34)



### Fluxograma (ver página 35)

- ① com EcoSmart®
- ② sem EcoSmart®



### Funcionamento (ver página 39)

A Hansgrohe recomenda a não utilização do primeiro meio litro de água, de manhã ou após longas paragens, para fins de consumo.



### Peças de substituição (ver página 36)



### Acessórios especiais

Chave especial 58085000 (não incluído no volume de fornecimento)



Mástique (não incluído no volume de fornecimento)





### Marca de controlo (ver página 40)





## Wskazówki bezpieczeństwa

-  Aby uniknąć zranień, takich jak zgniecenia czy przecięcia, podczas montażu należy nosić rękawice.
-  Pysznic może być używany tylko do kąpieli, higieny i czyszczenia ciała.
-  Znaczne różnice ciśnień na dopływach ciepłej i zimnej wody muszą zostać wyrównane.

## Wskazówki montażowe

- Armatura musi być zamontowana, przepłukana i wypróbowana według obowiązujących norm.
- W przypadku problemów z przepływowymi podgrzewaczami wody lub jeśli chce się uzyskać większy przepływ wody, można usunąć EcoSmart® (ogranicznik przepływu) znajdujący się za napowietrzaczem.
- Przed montażem należy skontrolować produkt pod kątem szkód transportowych. Po montażu nie widać żadnych szkód transportowych ani szkód na powierzchni.

## Dane techniczne

### Armatura produkowana seryjnie z funkcją EcoSmart® (ogranicznik przepływu)

Ciśnienie robocze:	maks. 1 MPa
Zalecane ciśnienie robocze:	0,1 – 0,5 MPa
Ciśnienie próbne:	1,6 MPa
(1 MPa = 10 bary = 147 PSI)	
Temperatura wody gorącej:	maks. 80 °C
Zalecana temperatura wody gorącej:	65 °C
Dezynfekcja termiczna:	maks. 70 °C / 4 min

Armatura Hansgrohe może być stosowana z przepływowymi podgrzewaczami wody sterowanymi hydraulicznie i termicznie w przypadku, gdy ciśnienie przepływu wynosi co najmniej 0,15 MPa.

Produkt stworzono wyłącznie do wody pitnej!

## Opis symbolu



### Ustawianie

Mieszacz jednochwytowy z ogranicznikiem temperatury wody, ustawianie, patrz str. 38. W połączeniu z przepływowym podgrzewaczem wody ogranicznik temperatury wody nie jest konieczny.



Nie stosować silikonów zawierających kwas octowy!



### Czyszczenie

patrz dołączona broszura.



### Wymiary (patrz strona 34)



### Schemat przepływu (patrz strona 35)

- ① z EcoSmart®
- ② bez EcoSmart®



### Obsługa (patrz strona 39)

Hansgrohe zaleca, by z rana lub po dłuższym czasie niekorzystania, pierwsze pół litra wody nie używać jako wody pitnej.



### Części serwisowe (patrz strona 36)



### Wyposażenie specjalne

Klucz montażowy 58085000 (Nie jest częścią dostawy)



Kit instalatorski (Nie jest częścią dostawy)





### Znak jakości (patrz strona 40)



## Montaż patrz strona 31



## **Bezpečnostní pokyny**

-  Pro zabránění řezným zraněním a pohmožděninám je nutné při montáži nosit rukavice.
-  Produkt smí být používán pouze ke koupání a za účelem tělesné hygieny.
-  Je nutné vyrovnat velké rozdíly tlaku mezi přípoji studené a teplé vody.

## **Pokyny k montáži**

- Armatura se musí montovat, proplachovat a testovat podle platných norem.
- Při problémech s průtokovým ohřívačem, nebo když je požadován větší průtok, může být odstraněno zařízení EcoSmart® (omezovač průtoku), které je umístěno za perlátorem.
- Před montáží je třeba produkt zkontrolovat, zda nebyl při transportu poškozen. Po zabudování nebudou uznány žádné škody způsobené transportem nebo poškození povrchu.

## **Technické údaje**

### **Armatura je sériově vybavena zařízením**

**EcoSmart®** (omezovač průtoku)

Provozní tlak:	max. 1 MPa
Doporučený provozní tlak:	0,1 – 0,5 MPa
Zkušební tlak:	1,6 MPa
(1 MPa = 10 bar = 147 PSI)	
Teplota horké vody:	max. 80 °C
Doporučená teplota horké vody:	65 °C
Tepelná desinfekce:	max. 70 °C / 4 min

Armatury Hansgrohe je možno používat v kombinaci s hydraulicky a tepelně řízenými průtokovými ohřívači v případě, že tlak činí minimálně 0,15 MPa.

Výrobky Hansgrohe jsou vhodné pro přímý kontakt s pitnou vodou.

## **Popis symbolů**



### **Nastavení**

Páková baterie s omezením horké vody, seřízení viz. str. 38. Ve spojení s průtokovými ohřívači není uzávěr teplé vody nutný.



Nepoužívat silikon s obsahem kyseliny octové!



### **Čištění**

viz příložená brožura.



### **Rozměry** (viz strana 34)



### **Diagram průtoku** (viz strana 35)

- ① se zařízením EcoSmart®
- ② bez zařízením EcoSmart®



### **Ovládání** (viz strana 39)

Hansgrohe doporučuje ráno nebo po delších přestávkách nepoužívat prvního půl litru jako pitnou vodu.



### **Servisní díly** (viz strana 36)



### **Zvláštní příslušenství**

montážní klíč 58085000 (není součástí dodávky)



Instalační kit (není součástí dodávky)





### **Zkušební značka** (viz strana 40)



## **Montáž viz strana 31**



## Bezpečnostné pokyny

-  Pri montáži musíte nosiť rukavice, aby ste predišli pomliaždeninám a rezným poraneniam.
-  Produkt sa smie používať len na kúpanie a telesnú hygienu.
-  Veľké rozdiely v tlaku medzi prípojkami studenej a teplej vody musia byť vyrovnané.

## Pokyny pre montáž

- Armatúra sa musí montovať, preplachovať a testovať podľa platných noriem.
- Pri problémoch s prietokovým ohrievačom alebo ak je požadovaný väčší prietok vody, môže sa demontovať zariadenie EcoSmart® (obmedzovač prietoku), ktoré je umiestnené za perlátorom.
- Pred montážou musíte produkt skontrolovať, či nebol počas transportu poškodený. Po zabudovaní nebudú uznané žiadne škody spôsobené transportom alebo poškodenia povrchu.

## Technické údaje

### Armatúra je sériovo vybavená zariadením

**EcoSmart®** (obmedzovač prietoku)

Prevádzkový tlak:	max. 1 MPa
Doporučený prevádzkový tlak:	0,1 – 0,5 MPa
Skúšobný tlak:	1,6 MPa
(1 MPa = 10 bar = 147 PSI)	
Teplota teplej vody:	max. 80 °C
Doporučená teplota teplej vody:	65 °C
Termická dezinfekcia:	max. 70 °C / 4 min

Batérie Hansgrohe môžete používať v spojení s hydraulickými a tepelne ovládanými prietokovými ohrievačmi, ak je tlak minimálne 0,15 MPa.

Výrobok je koncipovaný výhradne pre pitnú vodu!

## Popis symbolov



### Nastavenie

Páková batéria s obmedzením teplej vody, nastavenie vid'.str. 38. V spojení s prietokovými ohrievačmi nie je uzáver teplej vody nutný.



Nepoužívať silikón s obsahom kyseliny octovej!



### Čistenie

nájdete v priloženej brožúre.



### Rozmery (vid' strana 34)



### Diagram prietoku (vid' strana 35)

- ① so zariadením EcoSmart®
- ② bez zariadenia EcoSmart®



### Obsluha (vid' strana 39)

Hansgrohe odporúča ráno a po dlhších dobách odstavky nepoužiť prvého pol litra vody ako pitnú vodu.



### Servisné diely (vid' strana 36)



### Zvláštne príslušenstvo

montážny kľúč 58085000 (nie je súčasťou dodávky)



Inštalčná súprava (nie je súčasťou dodávky)



**Osvedčenie o skúške** (vid' strana 40)





## 安全技巧

- △ 装配时为避免挤压和切割受伤，必须戴上手套。
- △ 淋浴系统只允许作为洗浴、卫生和洁身之用。
- △ 冷热水管间过大的压力差必须予以平衡。

## 安装提示

- 必须按照现行的规定安装，冲洗和测试产品。
- 如果使用即热式热水器时出现问题，或要求更大的水流量，可以把位于水波器后面的 EcoSmart®（流量限制器）拆除。
- 安装前必须检查产品是否受到运输损害。安装后将不认可运输损害或表面损伤。

## 技术参数

本龙头配有 EcoSmart®（流量限制器）

工作压强：最大 1 MPa

推荐工作压强：0,1 - 0,5 MPa

测试压强：1,6 MPa

(1 MPa = 10 bar = 147 PSI)

热水温度：最大 80° C

推荐热水温度：65° C

热力消毒：最大 70° C / 4 分钟

如果水压达到0,15 MPa以上，汉斯格雅双手柄龙头可以和液压式或热控式连续流热水器一起使用。

该产品专为饮用水设计！

## 符号说明



### 调节

带有热水控制器的单手柄龙头的调节方法，参见第 38 页。如果与连续流热水器一起使用，则不必作任何调节。



请勿使用含有乙酸的硅！

### 清洗

附有小手册



大小 (参见第 34 页)



### 流量示意图

(参见第 35 页)

① 带有 EcoSmart®

② 无 EcoSmart®



### 操作 (参见第 39 页)

汉斯格雅建议，清晨或在水流长时间停滞，前半升水不作饮用水使用。



备用零件 (参见第 36 页)



### 选装附件

专用工具 58085000 (不在供货范围内)



水管胶泥 (不在供货范围内)





检验标记 (参见第 40 页)



安装 参见第 31 页



## Указания по технике безопасности

-  Во время монтажа следует надеть перчатки во избежание прищемления и порезов.
-  Изделие разрешается использовать только в гигиенических целях: для принятия ванны и личной гигиены.
-  донного клапа. Перед установкой смесителя необходимо регулировочными кранами выровнять давление холодной и горячей воды при помощи вентилей регулирующих подачу воды в квартиру.

## Указания по монтажу

- Смеситель должен быть смонтирован по действующим нормам и в соответствии с настоящей инструкцией, проверен на герметичность и безупречность работы.
- Если возникнут проблемы с проточным бойлером или потребуется увеличить расход воды, то можно удалить EcoSmart® (ограничитель потока воды), который установлен за воздушным рассекателем.
- Перед монтажом следует проверить изделие на предмет повреждений при перевозке. После монтажа претензии о возмещении ущерба за повреждения при перевозке или повреждения поверхностей не принимаются.

## Технические данные

### Смесители этой серии серийно оснащаются EcoSmart® (ограничителем потока воды)

Рабочее давление: не более. 1 МПа  
 Рекомендуемое рабочее давление: 0,1 – 0,5 МПа  
 Давление: 1,6 МПа  
 (1 МПа = 10 bar = 147 PSI)  
 Температура горячей воды: не более. 80 °С  
 Рекомендуемая темп. гор. воды: 65 °С  
 Термическая дезинфекция: не более. 70 °С / 4 мин

Арматуры Hansgrohe могут использоваться в комбинации с проточными нагревателями с гидравлическим и термическим управлением, если давление истечения составляет не менее 0,15 МПа.

Изделие предназначено исключительно для питьевой воды!

## Описание символов



### Подгонка

Однорычажный смеситель имеет ограничитель расхода горячей воды (см. Стр. 38: юстировка).



Не применяйте силикон, содержащий уксусную кислоту.



### Очистка

см прилагаемая брошюра



### Размеры (см. стр. 34)



### Схема потока (см. стр. 35)

- ① С EcoSmart®
- ② Без EcoSmart®



### Эксплуатация (см. стр. 39)

Hansgrohe рекомендует по утрам либо после длительного перерыва в использовании не использовать первые поллитра воды для питья.



### Комплект (см. стр. 36)



### Специальные принадлежности

Монтажный ключ 58085000 (не включено в объем поставки!)



Монтаж подводки (не включено в объем поставки!)





### Знак технического контроля (см. стр. 40)





## Biztonsági utasítások

-  A szerelésnél a zúródások és vágási sérülések elkerülése érdekében kesztyűt kell viselni.
-  A terméket csak fürdéshez, mosakodáshoz, és egészségügyi tisztálkodáshoz szabad használni.
-  A hidegvíz- és a melegvíz-csatlakozások közötti nagy nyomáskülönbséget kikell egyenlíteni!

## Szerelési utasítások

- A csaptelepet az érvényben lévő előírásoknak megfelelően kell felszerelni, átöblíteni és ellenőrizni.
- Ha problémák adódnak az átfolyós vízmelegítővel vagy nagyobb átfolyó vízmennyiségre van szükség, akkor az EcoSmart® (átfolyáskorlátozó) eltávolítható a perlátor mögül.
- A szerelés előtt ellenőrizni kell, hogy a terméknek nincs-e szállítási sérülése. Beépítés után a szállítási- vagy felületi sérüléseket nem ismerik el.

## Műszaki adatok

### A csaptelep szériakivitelben el van látva EcoSmart® (átfolyáskorlátozó) berendezéssel

Üzemi nyomás:	max. 1 MPa
Ajánlott üzemi nyomás:	0,1 – 0,5 MPa
Nyomáspróba:	1,6 MPa
(1 MPa = 10 bar = 147 PSI)	
Forróvíz hőmérséklet:	max. 80 °C
Forróvíz javasolt hőmérséklete:	65 °C
Termikus fertőtlenítés:	max. 70 °C / 4 perc

A Hansgrohe csaptelepek hidraulikus és termikus vezérlésű átfolyós melegítővel kapcsolatban is használhatóak, ha az átfolyó nyomás legalább 0,15 MPa.

A terméket kizárólag ivóvízhez tervezték!

## Szimbólumok leírása



### Beállítás

Az egykaros, melegvíz-korlátozóval ellátott keverő csaptelep beállítását lásd a 38. oldalon. Az átfolyó rendszerű vízmelegítőknél nem szükséges a melegvíz-korlátozó.



Ne használjon ecetsavtartalmú szilikon!



### Tisztítás

lásd a mellékelt brosúrát.



### Méretet (lásd a 34. oldalon)



### Átfolyási diagram (lásd a 35. oldalon)

- ① EcoSmart® berendezéssel
- ② EcoSmart® nélkül



### Használat (lásd a 39. oldalon)

A Hansgrohe azt ajánlja, hogy hosszabb állási idő után az első fél liter vizet ne használja ivóvízként.



### Tartozékok (lásd a 36. oldalon)



### Egyéb tartozék

Szerelőkulcs 58085000 (a szállítási egység nem tartalmazza)



szaniter szilikon (a szállítási egység nem tartalmazza)



### Vizsgajel (lásd a 40. oldalon)



**Szerelés lásd a 31. oldalon**



## Turvallisuusohjeet

- ⚠ Asennuksessa on käytettävä käsineitä puristumien ja viiltojen aiheuttamien tapaturmien estämiseksi.
- ⚠ Suihkujärjestelmää saa käyttää ainoastaan kylpy-, hygienia- ja puhdistustarkoituksiin.
- ⚠ Suuret paine-erot kylmä- ja kuumavesiliitäntöjen välillä on tasattava.

## Asennusohjeet

- Kaluste on asennettava, huuhdeltava ja tarkastettava voimassa olevien määräysten mukaisesti.
- Jos läpivirtauskuumentimen kanssa on ongelmia tai jos halutaan suurempaa veden virtausmäärää, voidaan poreenmuodostajan takana oleva EcoSmart® (virtauksenrajoitin) poistaa.
- Ennen asennusta on tarkastettava tuotteen mahdolliset kuljetusvahingot. Asennuksen jälkeen kuljetus- ja pintavaurioita ei hyväksytä.

## Tekniset tiedot

### Kaluste on vakiona varustettu EcoSmart®

(virtauksenrajoittimella)

Käyttöpaine:	maks. 1 MPa
Suosittelut käyttöpaine:	0,1 – 0,5 MPa
Koestuspaine:	1,6 MPa
(1 MPa = 10 bar = 147 PSI)	
Kuuman veden lämpötila:	maks. 80 °C
Kuuman veden suosituslämpötila:	65 °C
Lämpödesinfektio:	maks. 70 °C / 4 min

Hansgrohe kalusteita voi käyttää hydraulisesti tai termisesti ohjattujen läpivirtauskuumentimien yhteydessä, jos virtauspaine on vähintään 0,15 MPa.

Tuote on suunniteltu käytettäväksi ainoastaan juomaveden kanssa!

## Merkin kuvaus



### Säätö

Yksivipuinen sekoittaja lämpimän veden rajoituksella, katso säätö sivulta 38. Lämpimän veden rajoitusta ei tarvita läpivirtauskuumentimen yhteydessä.



### Puhdistus

katso oheinen esite



### Mitat (katso sivu 34)



### Virtausdiagrammi (katso sivu 35)

- ① sisältää EcoSmart®
- ② ilman EcoSmart®



### Käyttö (katso sivu 39)

Hansgrohe suosittelee, että ensimmäistä puolta litraa ei käytetä juomavetenä aamuisin eikä silloin, kun laitetta ei ole käytetty pitkään aikaan.



### Varaosat (katso sivu 36)



### Erityisvaruste

Asennusavain 58085000 (ei kuulu toimitukseen)



Asennussarja (ei kuulu toimitukseen)





### Koestusmerkki (katso sivu 40)







## Säkerhetsanvisningar

-  Handskar ska bäras under monteringsarbetet så att man kan undvika kläm- och skärskadorna werden.
-  Produkten får bara användas till kroppshygien med bad och dusch.
-  Stora tryckskillnader mellan anslutningarna för varmt och kallt vatten måste utjämnas.

## Monteringsanvisningar

- Armaturen måste installeras, genomspolas och testas enligt gällande föreskrifter.
- Om det är problem med vattenberedaren eller om större vattenflöde önskas kan EcoSmart® (flödeskontroll) som sitter bakom perlatorn tas bort.
- Det måste undersökas om produkten har transportskador innan den monteras. Efter monteringen accepteras inga transport- eller ytskiktsskador.

## Tekniska data

### Blandare seriemässigt med EcoSmart®

(flödeskontroll)

Driftstryck:	max. 1 MPa
Rek. driftstryck:	0,1 – 0,5 MPa
Tryck vid provtryckning:	1,6 MPa
(1 MPa = 10 bar = 14,7 PSI)	
Varmvattentemperatur:	max. 80 °C
Rek. varmvattentemp.:	65 °C
Termisk desinfektion:	max. 70 °C / 4 min

Hansgrohe blandare kan användas tillsammans med hydrauliskt och termiskt styrda varmvattenberedare när flödestrycket uppgår till minst 0,15 MPa.

Produkten är enbart avsedd för dricksvatten!

## Symbolförklaring



### Justering

Enhandsblandare med varmvattenreglering, justering se sidan 38. Vid användning tillsammans med varmvattenberedare behövs ingen varmvattenreglering.



Använd inte silikon som innehåller ättiksyra!



### Rengöring

se den medföljande broschyren



### Måtten (se sidan 34)



### Flödesschema (se sidan 35)

- ① med EcoSmart®
- ② utan EcoSmart®



### Hantering (se sidan 39)

Hansgrohe rekommenderar att den första halvlitern inte används som dricksvatten på morgonen eller efter längre perioder utan användning.



### Reservdelar (se sidan 36)



### Specialtillbehör

Monteringsnyckel 58085000 (medföljer ej leveransen)



Installationskit (medföljer ej leveransen)





### Testsigill (se sidan 40)





## Saugumo technikos nurodymai

-  Apsaugai nuo užspaudimo ir įsijovimo montavimo metu mūvėkite pirštines.
-  Gaminys turi būti naudojamas tik maudymuisi, kūno higienai ir švarai palaikyti.
-  Turi būti išlyginti šalto ir karšto slėgio nelygumai.

## Montavimo instrukcija

- Maišytuvą privalo būti montuojamas ir išbandomas pagal veikiančias normas ir šią instrukciją.
- Jei yra problemų su momentiniu vandens šildytuvu ar neužtenka vandens srauto, galima pašalinti už aeratoriaus esantį „EcoSmart“ (vandens srauto ribotuvą).
- Prieš montuojant būtina patikrinti, ar gaminys nebuvo pažeistas transportavimo metu. Šumontavus pretenzijos dėl transportavimo ir paviršiaus pažeidimų nepriimamos.

## Techniniai duomenys

**Šios serijos maišytuvai turi EcoSmart®** (vandens srauto ribotuvą)

Darbinis slėgis: ne daugiau kaip 1 MPa

Rekomenduojamas slėgis: 0,1 – 0,5 MPa

Bandomasis slėgis: 1,6 MPa

(1 MPa = 10 barų = 147 PSI)

Karšto vandens temperatūra: ne daugiau kaip 80 °C

Rekomenduojama karšto vandens temperatūra: 65 °C

Terminis dezinfekavimas: ne daugiau kaip 70 °C / 4 min

„Hansgrohe“ maišytuvai gali būti naudojami su hidrauliškai ir termiškai reguliuojamais momentiniais šildikliais, kai vandens slėgis mažesnis kaip 0,15 MPa.

Produktas skirtas tik geriamajam vandeniui!

## Simbolio aprašymas



### Reguliuavimas

Vienos rankenėlės maišytuvus turi karšto vandens ribotuvą (nustatymą žr. psl. 38). Naudojant momentinį šildiklį karšto vandens ribotuvą nebūtina.



Nenaudokite silikono, kurio sudėtyje yra acto rūgšties!



### Valymas

žr. pridedamoje brošiūroje.



### Išmatavimai (žr. psl. 34)



### Pralaidumo diagrama

(žr. psl. 35)

① su EcoSmart®

② be EcoSmart®



### Eksplotacija (žr. psl. 39)

Naudojant po ilgesnės pertraukos, „Hansgrohe“ rekomenduoja pirmo pusės litro vandens nevirtoti kaip geriamojo.



### Atsarginės dalys (žr. psl. 36)



### Specialūs priedai

Montavimo raktas 58085000 (nėra pridedama)

Montavimo rinkinys (nėra pridedama)





### Bandymo pažyma (žr. psl. 40)



## Montavimas žr. psl. 31



## Sigurnosne upute

-  Prilikom montaže se radi sprječavanja prignječenja i posjekotina moraju nositi rukavice.
-  Proizvod se smije primjenjivati samo za kupanje, tuširanje i osobnu higijenu.
-  Velika razlika u pritisku između vruće i hladne vode mora biti izbalansirana.

## Upute za montažu

- Cijevi moraju biti postavljene, isprane i testirane prema važećim normama.
- Ako dolazi do problema s protočnim bojlerom ili se želi veći protok vode, može se ukloniti EcoSmart® (limitator protoka) lociran iza aeratora.
- Prije montaže mora se provjeriti je li proizvod oštećen prilikom transporta. Nakon ugradnje se ne priznaju nikakve reklamacije koje se odnose na površinska i transportna oštećenja.

## Tehnički podaci

### Armatura ima serijski ugrađen EcoSmart®

(limitator protoka)

Najveći dopušteni tlak:	tlak 1 MPa
Preporučeni tlak:	0,1 – 0,5 MPa
Probni tlak:	1,6 MPa
(1 MPa = 10 bar = 147 PSI)	
Temperatura vruće vode:	tlak 80 °C
Preporučena temperatura vruće vode:	65 °C
Termička dezinfekcija:	tlak 70 °C / 4 min

Hansgrohe armature mogu se koristiti u kombinaciji sa hidraulički i termički kontroliranim protočnim bojlerima ukoliko tlak iznosi najmanje 0,15 MPa.

Proizvod je koncipiran isključivo za pitku vodu!

## Opis simbola



### Regulacija

Da bi podesili limiter vruće vode na jednoručnim slavinama molimo Vas da pogledate stranicu 38. Podešavanje nije potrebno ako koristite protočni bojler.



Nemojte koristiti silikon koji sadrži octenu kiselinu!



### Čišćenje

se u priloženoj brošuri.



### Mjere (pogledaj stranicu 34)



### Dijagram protoka (pogledaj stranicu 35)

- ① s limitatorom EcoSmart®
- ② bez limitatora EcoSmart®



### Upotreba (pogledaj stranicu 39)

Hansgrohe preporuča da ujutro ili nakon duljeg nekorištenja prvih 1/2 litre vode ne upotrebljavate za piće.



### Rezervni dijelovi (pogledaj stranicu 36)



### Posebni pribor

ključ za montažu 58085000 (Nije sadržano u isporuci!)



Instalaterski kit (Nije sadržano u isporuci!)



### Oznaka testiranja (pogledaj stranicu 40)



## Sastavljanje pogledaj stranicu 31



## ! Güvenlik uyarıları

- ⚠ Montaj esnasında ezilme ve kesilme gibi yaralanmaları önlemek için eldiven kullanılmalıdır.
- ⚠ Duş sistemi yalnızca banyo, hijyen ve beden temizliği amaçları doğrultusunda kullanılabilir.
- ⚠ Sıcak ve soğuk su bağlantıları arasında büyük basınç farklılıkları varsa, bu basınç farklılıklarının dengelenmesi gerekir.

## Montaj açıklamaları

- Batarya monte edilmeli, geçerli normlardan sonra akis testi yapılmalıdır.
- Sürekli akışlı su ısıtıcıları ile birlikte kullanımında problemler söz konusu ise veya akan su miktarının daha fazla olması isteniyorsa, perlatörün arka tarafındaki EcoSmart® (akış sınırlayıcısı) sökülüp çıkarılabilir.
- Montaj işleminden önce ürün nakliye hasarları yönünden kontrol edilmelidir. Montaj işleminden sonra nakliye veya yüzey hasarları için sorumluluk üstlenilmemektedir.

## Teknik bilgiler

### Batarya EcoSmart® (akış sınırlayıcısı) ile birlikte seri olarak

İşletme basıncı:	azami 1 MPa
Tavsiye edilen işletme basıncı:	0,1 – 0,5 MPa
Kontrol basıncı:	1,6 MPa
(1 MPa = 10 bar = 147 PSI)	
Sıcak su sıcaklığı:	azami 80 °C
Tavsiye edilen su ısıtı:	65 °C
Termik dezenfeksiyon:	azami 70 °C / 4 dak

Hansgrohe bataryaları, akış basıncı en az 0,15 MPa olursa hidrolik ve termik kumandalı şofbenlerle bağlantılı olarak kullanılabilir.

Ürün sadece şebeke suyu için tasarlanmıştır!

## Simge açıklaması



### Ayarlama

Sıcak su sınırlayıcı özelliğine sahip tek kollu bataryanın ayarlanması için 38. sayfaya bakınız. Bir sürekli akışlı su ısıtıcısı ile birlikte kullanılırsa sıcak su sınırlayıcısına gerek kalmaz.



Asetik asit içeren silikon kullanmayın!



### Temizleme

birlikte verilen broşür



### Ölçüleri (Bakınız sayfa 34)



### Akış diyagramı (Bakınız sayfa 35)

- ① EcoSmart® dahil
- ② EcoSmart® hariç



### Kullanımı (Bakınız sayfa 39)

Hansgrohe sabahları uzun durgunluk süresi sonrasında ilk yarım litre suyun içme suyu olarak kullanılmamasını önerir.



### Yedek Parçalar (Bakınız sayfa 36)



### Özel aksesuarlar

Montaj anahtarı 58085000 (Teslimat kapsamına dahil değildir)

Montaj silikonu (Teslimat kapsamına dahil değildir)





### Kontrol işareti (Bakınız sayfa 40)





## Instrucțiuni de siguranță

-  La montare utilizați mănuși pentru evitarea contuziunilor și tăierii mâinilor.
-  Sistemul de duș poate fi utilizat doar pentru spălarea, menținerea igienei și curățarea corpului.
-  Diferențele de presiune mari între alimentarea cu apă rece și apă caldă trebuie echilibrate.

## Instrucțiuni de montare

- Bateria trebuie montată, clătită și verificată conform normelor în vigoare.
- Dacă apar probleme cu boilerul instant sau dacă doriți un debit de apă mai mare, puteți să demontați unitatea EcoSmart® (limitatorul de debit), care se află în spatele suflătorului de aer.
- Înainte de instalare verificați, dacă produsul prezintă deteriorări de transport. După instalare garanția nu acoperă deteriorările de transport și cele de suprafață.

## Date tehnice

### Bateria este dotată în serie cu EcoSmart®

(limitator de debit)

Presiune de funcționare:	max. 1 MPa
Presiune de funcționare recomandată:	0,1 – 0,5 MPa
Presiune de verificare:	1,6 MPa
(1 MPa = 10 bar = 147 PSI)	
Temperatura apei calde:	max. 80 °C
Temperatura recomandată a apei calde:	65 °C
Dezinfecție termică:	max. 70 °C / 4 min

Bateriile Hansgrohe pot fi utilizate cu boiler instant cu comandă termică sau hidraulică dacă presiunea apei de alimentare este de min. 0,15 MPa.

Produsul este destinat exclusiv pentru apă potabilă.

## Descrierea simbolurilor



### Reglare

Bateria monocomadă cu limitarea apei calde, pentru reglare vezi pag. 38. Dacă conectați bateria la un boiler instant nu este necesară instalarea unui opritor de apă caldă.



Nu utilizați silicon cu conținut de acid acetic!



### Curățare

vezi broșura alăturată.



### Dimensiuni (vezi pag. 34)



### Diagrama de debit (vezi pag. 35)

- ① cu EcoSmart®
- ② fără EcoSmart®



### Utilizare (vezi pag. 39)

Hansgrohe vă recomandă, ca dimineața sau după perioade mai lungi de pauză să nu folosiți prima jumătate de litru de apă pentru băut.



### Piese de schimb (vezi pag. 36)



### Accesorii opționale

Cheie pentru montare 58085000 (nu este inclus în setul livrat)



Chit de instalare (nu este inclus în setul livrat)





Certificat de testare (vezi pag. 40)



## Montare vezi pag. 31



## Υποδειξεις ασφαλείας

-  Για να αποφύγετε τραυματισμούς κατά τη συναρμολόγηση πρέπει να φοράτε γάντια.
-  Το προϊόν επιτρέπεται να χρησιμοποιείται μόνο σαν μέσο λουτρού, υγιεινής και καθαρισμού του σώματος.
-  Οι διαφορές της πίεσης μεταξύ της σύνδεσης κρύου και ζεστού νερού θα πρέπει να αντισταθμίζονται.

## Οδηγίες συναρμολόγησης

- Η μπαταρία πρέπει να τοποθετηθεί, να πλυθεί και να ελεγχθεί με βάση τους ισχύοντες κανόνες υδραυλικής τέχνης
- Εάν παρουσιαστεί πρόβλημα με τον ταχυθερμοσίφωνα ή όταν απαιτείται περισσότερο νερό, μπορεί να απομακρυνθεί ο EcoSmart® (μειωτής ροής), ο οποίος βρίσκεται πίσω από το φίλτρο του ρουζουνιού.
- Πριν τη συναρμολόγηση πρέπει να εξεταστεί το προϊόν για ζημιές μεταφοράς. Μετά την εγκατάσταση δεν αναγνωρίζονται ζημιές από τη μεταφορά ή επιφανειακές ζημιές.

## Τεχνικά Χαρακτηριστικά

### Μπαταρία μόνιμα εξοπλισμένη με EcoSmart®

(μειωτής ροής)	
Λειτουργία πίεσης:	έως 1 MPa
Συνιστώμενη λειτουργία πίεσης:	0,1 – 0,5 MPa
Πίεση ελέγχου:	1,6 MPa
(1 MPa = 10 bar = 147 PSI)	
Θερμοκρασία ζεστού νερού:	έως 80 °C
Συνιστώμενη θερμοκρασία ζεστού νερού:	65 °C
Θερμική απολύμανση:	έως 70 °C / 4 min

Οι βάνες Hansgrohe μπορούν να συνδυαστούν με ταχυθερμοσίφωνα υδραυλικού και θερμικού ελέγχου, όταν η πίεση ροής αριθμεί τουλάχιστον 0,15 MPa.

Το προϊόν έχει σχεδιαστεί αποκλειστικά για πόσιμο νερό!

## Περιγραφή συμβόλων



### Ρύθμιση

Για να προσαρμόσετε το δοσομετρητή ζεστού νερού σε αναμεικτικές μπαταρίες, παρακαλούμε δείτε τη ρύθμιση στη σελ. 38. Δεν είναι απαραίτητη η διάταξη φραγής ζεστού νερού σε συνδυασμό με ταχυθερμοσίφωνα.



Μην χρησιμοποιείτε σιλικόνη που περιέχει οξικό οξύ!



### Καθαρισμός

βλ. συνημμένο φυλλάδιο



### Διαστάσεις (βλ. σελίδα 34)



### Διάγραμμα ροής (βλ. σελίδα 35)

- ① με EcoSmart®
- ② χωρίς EcoSmart®



### Χειρισμός (βλ. σελίδα 39)

Η Hansgrohe συνιστά το πρώι ή μετά από μεγάλα χρονικά διαστήματα αχρησίας να μην χρησιμοποιείτε το πρώτο μισό λίτρο νερό σαν πόσιμο.



### Ανταλλακτικά (βλ. σελίδα 36)



### Ειδικά αξεσουάρ

Κλειδί συναρμολόγησης 58085000 (δεν περιλαμβάνεται στον παραδοτέο εξοπλισμό)



Κιτ εγκατάστασης (δεν περιλαμβάνεται στον παραδοτέο εξοπλισμό)





### Σήμα ελέγχου (βλ. σελίδα 40)





## Varnostna opozorila

-  Pri montaži je treba nositi rokavice, da se preprečijo poškodbe zaradi zmečkanja ali urezov.
-  Ta izdelek se sme uporabljati le z namenom umivanja, vzdrževanja higiene in telesne nege.
-  Velike razlike v tlaku med priključkom za mrzlo in priključkom za toplo vodo je potrebno izravnati.

## Instructions pour le montage

- Armatura je potrebno montirati, splakniti in testirati v skladu z veljavnimi predpisi.
- Če imate probleme s pretočnim grelnikom, ali če želite večji pretok vode, lahko odstranite EcoSmart® (omejevalnik pretoka), ki se nahaja za perlatorjem.
- Pred montažo je treba izdelek preveriti glede morebitnih transportnih poškodb. Po vgradnji transportne ali površinske poškodbe ne bodo več priznane.

## Tehnični podatki

### Armatura je serijsko opremljena z EcoSmart®

(omejevalnik pretoka)

Delovni tlak:	maks. 1 MPa
Priporočeni delovni tlak:	0,1 – 0,5 MPa
Preskusni tlak:	1,6 MPa
(1 MPa = 10 bar = 147 PSI)	
Temperatura tople vode:	maks. 80 °C
Priporočena temperatura tople vode:	65 °C
Termična dezinfekcija:	maks. 70 °C / 4 min

Armature Hansgrohe lahko uporabljate v povezavi s hidravlično in termično uravnavanimi pretočnimi grelniki, če je pretočni tlak najmanj 0,15 MPa.

Proizvod je zasnovan izključno za sanitarno vodo!

## Opis simbola



### Justiranje

Enoročne mešalne baterije z omejevalnikom tople vode, za justiranje glejte stran 38. V povezavi s pretočnimi grelniki zapora tople vode ni potrebna.



Ne smete uporabiti silikona, ki vsebuje acetno kislino!



### Čiščenje

glejte priloženi brošuri.



### Mere (glejte stran 34)



### Diagram pretoka (glejte stran 35)

- ① z omejevalnikom pretoka EcoSmart®
- ② brez omejevalnika pretoka EcoSmart®



### Upravljanje (glejte stran 39)

Hansgrohe priporoča, da zjutraj ali po daljšem času stagnacije prvega pol litra vode ne uporabite kot pitno vodo.



### Rezervni deli (glejte stran 36)



### Poseben pribor

Montažni ključ 58085000 (Ni vključeno)



Komplet za montažo (Ni vključeno)





### Preskusni znak (glejte stran 40)



## Montaža Glejte stran 31.



## Ohutusjuhised

-  Kandke paigaldamisel muljumis- ja löikevigastuste vältimiseks kindaid.
-  Toodet tohib kasutada ainult pesemis-, hügieeni- ja kehapihustamisesmärgidel.
-  Kui külma ja kuumu vee ühenduste surve on väga erinev, tuleb need tasakaalustada.

## Paigaldamisjuhised

- Seadmestiku paigaldamine, läbipesu ja kontrollimine peab toimuma vastavalt kehtivatele normidele.
- Kui esineb probleeme läbivooluoleiga või kui soovitakse, et vee läbivool oleks suurem, tuleks sõela taga asuv EcoSmart® (veehulgapiiraja) eemaldada.
- Enne paigaldamist tuleb toodet kontrollida transpordikahjustuste osas. Pärast paigaldamist ei tunnustata enam transpordi- või pinnakahjustuste kaebuseid.

## Tehnilised andmed

### Segistisari on toodetud koos EcoSmart®

(veehulgapiirajaga)

Töörõhk	maks. 1 MPa
Soovitavat töörõhk:	0,1 – 0,5 MPa
Kontrollsurve:	1,6 MPa
(1 MPa = 10 baari = 147 PSI)	
Kuumu vee temperatuur:	maks. 80 °C
Soovitavat kuumu vee temperatuur:	65 °C
Termiline desinfektsioon:	maks. 70 °C / 4 min

Hansgrohe segisteid võib kasutada koos hüdrauliliselt ja termiliselt juhivate boileritega, kui vee surve on vähemalt 0,15 MPa.

Toode on ette nähtud eranditult joogivee jaoks!

## Sümbolite kirjeldus



### Reguleerimine

Ühe juhtkangiga segisti kuumu vee piiraja reguleerimise kohta vt lk 38. Läbivoolu boilerite puhul pole reguleerimine vajalik.



Ärge kasutage äädikhapet sisaldavat silikooni!



### Puhastamine

vt kaasasolevast brošüürist.



### Mõõtude (vt lk 34)



### Läbivooludiagramm (vt lk 35)

- ① EcoSmart® olemas
- ② EcoSmart® puudub



### Kasutamine (vt lk 39)

Hansgrohe soovib mitte kasutada esimest poolt liitrit hommikuti või pärast pikemat seisakuaega joogiveena.



### Varuosad (vt lk 36)



### Spetsiaalne lisavarustus

Montaaživõti 58085000 (ei sisaldu komplektis)



Paigalduskomplekt (ei sisaldu komplektis)



### Kontrollsertifikaat (vt lk 40)





## Paigaldamine vt lk 31





## Drošības norādes

-  Montāžas laikā, lai izvairītos no saspiedumiem un iegriezumiem, nepieciešams nēsāt cimdus.
-  Šo produktu drīkst izmantot tikai, lai mazgātos, higiēnai un ķermeņa tīrīšanai.
-  Jāizlīdzina spiediena atšķirības starp aukstā un karstā ūdens pievadiem.

## Norādījumi montāžai

- Jaucējkrāns jāmontē, jāskalo un jāpārbauda atbilstoši spēkā esošajām normām.
- Ja rodas problēmas ar caurteces sildītāju vai ja ūdens plūsma nav pietiekami spēcīga, EcoSmart® (caurteces ierobežotāju), kas atrodas aiz aeratora, drīkst noņemt.
- Pirms montāžas nepieciešams pārbaudīt, vai produktam transportēšanas laikā nav radušies bojājumi. Pēc iebūvēšanas bojājumi, kas radušies transportēšanas laikā, vai virsmas bojājumi netiek atzīti.

## Tehniskie dati

### Jaucējkrāns tiek ražots kopā ar EcoSmart®

(caurteces ierobežotāju)

Darba spiediens:	maks. 1 MPa
leteicamais darba spiediens:	0,1 – 0,5 MPa
Pārbaudes spiediens:	1,6 MPa
(1 MPa = 10 bar = 147 PSI)	
Karstā ūdens temperatūra:	maks. 80 °C
leteicamā karstā ūdens temperatūra:	65 °C
Termiskā dezinfekcija :	maks. 70 °C / 4 min

Hansgrohe jaucējkrānus var izmantot kombinācijā ar hidrauliski un termiski vadāmiem caurteces sildītājiem, ja plūsmas spiediens ir vismaz 0,15 MPa.

Izstrādājums ir paredzēts tikai dzeramajam ūdenim!

## Simbolu nozīme



### Ieregulēšana

Viensvirs jaucējkrāns ar siltā ūdens ierobežošanu, ieregulēšanu skat. 38. lpp. Kombinācijā ar caurteces sildītāju karstā ūdens ierobežošana nav nepieciešama.



Neizmantojiet silikonu, kas satur etiķskābi!



### Tīrīšana

skatiet pievienotajā brošūrā.



### Izmērus (skat. 34. lpp.)



### Caurplūdes diagramma

(skat. 35. lpp.)

- ① ar EcoSmart®
- ② bez EcoSmart®



### Lietošana (skat. 39. lpp.)

Hansgrohe iesaka no rīta vai pēc ilgākiem pārtraukumiem nelietot pirmo puslitru ūdens dzeršanai.



### Rezerves daļas (skat. 36. lpp.)



### Speciāli aksesuāri

Montāžas atslēga 58085000 (komplektā netiek piegādāts)



Instalācijas piederumi (komplektā netiek piegādāts)





### Pārbaudes zīme (skat. 40. lpp.)





## Sigurnosne napomene

-  Prilikom montaže se radi sprečavanja prignječenja i posekotina moraju nositi rukavice.
-  Proizvod sme da se koristi samo za kupanje, tuširanje i ličnu higijenu.
-  Velika razlika u pritisku između vruće i hladne vode mora biti izbalansirana.

## Instrukcije za montažu

- Armatura mora biti postavljena, isprana i testirana prema važećim normama.
- Ukoliko se pojave problemi sa protočnim bojlerom ili se želi veći protok vode, onda EcoSmart® (ograničavač protoka vode), koji je smešten iza aeratora, može da se ukloni.
- Pre montaže se mora proveriti da li je proizvod oštećen pri transportu. Nakon ugradnje se ne priznaju nikakve reklamacije koje se odnose na površinska i transportna oštećenja.

## Tehnički podaci

### Ove armature imaju serijski ugrađen

**EcoSmart®** (ograničavač protoka vode)

Radni pritisak: maks. 1 MPa

Preporučeni radni pritisak: 0,1 – 0,5 MPa

Probni pritisak: 1,6 MPa

(1 MPa = 10 bar = 147 PSI)

Temperatura vruće vode: maks. 80 °C

Preporučena temperatura vruće vode: 65 °C

Termička dezinfekcija: maks. 70 °C / 4 min

Hansgrohe armature se mogu koristiti u kombinaciji s hidraulički i termički kontrolisanim protočnim bojlerima ukoliko pritisak iznosi najmanje 0,15 MPa.

Proizvod je koncipiran isključivo za pijaću vodu!

## Opis simbola



### Podešavanje

Da bi ste podesili ograničavač vruće vode na jednoručnim mešačima, molimo Vas da pogledate stranicu 38. Podešavanje nije potrebno ako koristite protočni bojler.



Nemojte koristiti silikon koji sadrži sirćetnu kiselinu!



### Čišćenje

vidi priloženoj brošuri.



### Mere (vidi stranu 34)



### Dijagram protoka (vidi stranu 35)

- ① sa ograničavačem EcoSmart®
- ② bez ograničavača EcoSmart®



### Rukovanje (vidi stranu 39)

Hansgrohe preporučuje da ujutru ili nakon dužeg nekorišćenja prvih pola litre vode ne koristite za piće.



### Rezervni delovi (vidi stranu 36)



### Poseban pribor

ključ za montažu 58085000 (Nije sadržano u isporuci)



Instalaterski komplet (Nije sadržano u isporuci)





### Ispitni znak (vidi stranu 40)



## Montaža vidi stranu 31



## Sikkerhets henvisninger

-  Bruk hansker under montasjen for å unngå klem- og kuttskader.
-  Dusjsystemet skal kun brukes for bade-, hygiene- og kroppshygiene.
-  Store trykkdifferanser mellom kaldt- og varmtvannstilkoblinger skal utlignes.

## Montagehenvisninger

- Armaturen skal monteres, spyles og sjekkes iht. gyldige standarder.
- Ved problemer med gjennomstrømningssovnen, eller når man ønsker en større vanngjennomstrømning, kan EcoSmart® (gjennomstrømningsbegrenser) fjernes. Den sitter bak luftdysene.
- Før montasjen skal produktet sjekkes for transportskader. Etter monteringen aksepteres ikke noen transport- eller overflateskader.

## Tekniske data

### Armatur er standardmessig utstyrt med EcoSmart® (gjennomstrømningsbegrenser)

Driftstrykk	maks. 1 MPa
Anbefalt driftstrykk:	0,1 – 0,5 MPa
Prøvetrykk	1,6 MPa
(1 MPa = 10 bar = 147 PSI)	
Varmtvannstemperatur	maks. 80 °C
Anbefalt temperatur for varmt vann	65 °C
Termisk desinfisering:	maks. 70 °C / 4 min

Armaturer fra Hansgrohe kan brukes sammen med hydraulisk og termisk styrte gjennomstrømningssovner når gjennomstrømningstrykket er på minst 0,15 MPa.

Produktet er utelukkende designet for drikkevann!

## Symbolbeskrivelse



### Justering

Enhåndblandebatteri med varmtvannsbegrensning. For justering se side 38. I forbindelse med en gjennomstrømningssovn er det ikke nødvendig med varmtvannsbegrensning.



Ikke bruk silikon som inneholder eddiksyre!



### Rengjøring

se vedlagt brosjyre.



### Mål (se side 34)



### Gjennomstrømningsdiagram (se side 35)

- ① med EcoSmart®
- ② uten EcoSmart®



### Betjening (se side 39)

Om morgen og etter lengre stagnasjonstider anbefaler Hansgrohe å ikke bruke den første halvliteren som drikkevann.



### Service deler (se side 36)



### Ekstratilbehør

Montasjenøkkel 58085000 (ikke med i leveransen)



Installasjonskitt (ikke med i leveransen)





### Prøvermerke (se side 40)



## Montasje se side 31



## Указания за безопасност

-  При монтажа трябва да се носят ръкавици, за да се избегнат наранявания поради притискане или порязване.
-  Позволено е използването на продукта само за къпане, хигиена и цели на почистване на тялото.
-  Големите разлики в налягането между изводите за студената и топлата вода трябва да се изравняват.

## Указания за монтаж

- Арматурата трябва да се монтира, промие и провери в съответствие с валидните норми.
- При проблеми с проточния нагревател или когато желаете по-голяма пропускателна способност на водата, може да отстраните EcoSmart® (ограничителя на протичане), който се намира зад аератора.
- Преди монтажа продуктът трябва да се провери за транспортни щети. След монтажа не се признават транспортни или повърхностни щети.

## Технически данни

### Арматурата е оборудвана серийно с EcoSmart® (ограничител на протичане)

Работно налягане:	макс. 1 МПа
Препоръчително работно налягане:	0,1 – 0,5 МПа
Контролно налягане:	1,6 МПа
(1 МПа = 10 bar = 147 PSI)	
Температура на горещата вода:	макс. 80 °C
Препоръчителна температура на горещата вода:	65 °C
Термична дезинфекция:	макс. 70 °C / 4 мин

Арматурите на Hansgrohe могат да се използват във връзка с хидравлично и термично управляеми проточни нагреватели, ако хидравличното налягане е минимум 0,15 МПа.

Продуктът е разработен само за питейна вода!

## Описание на символите



### Юстиране

Смесител с една ръкохватка с ограничител за топлата вода, юстирането вижте на стр. 38. Във връзка с проточни нагреватели не е необходима блокировка за топлата вода.



Не използвайте силикон, съдържащ оцетна киселина!



### Почистване

от приложената брошура.



### Размери (вижте стр. 34)



### Диаграма на потока (вижте стр. 35)

- ① с EcoSmart®
- ② без EcoSmart®



### Обслужване (вижте стр. 39)

Hansgrohe препоръчва, сутрин и след продължително спиране първият половин литър да не се използва като питейна вода.



### Сервизни части (вижте стр. 36)



### Специални принадлежности

Монтажен ключ 58085000 (не се съдържа в обема на доставка)



Инсталационен кит (не се съдържа в обема на доставка)





### Контролен знак (вижте стр. 40)



**Монтаж вижте стр. 31**



## Udhëzime sigurie

-  Për të evituar lëndimet e pickimeve ose të prerjeve gjatë procesit të montimit duhet që të vishni doreza.
-  Produkti duhet të përdoret vetëm qëllimet e banjave, të higjienës dhe të larjes së trupit.
-  Ndryshimet e mëdha të presionit mes lidhjeve të ujit të ftohtë dhe atij të ngrohtë duhen ekuilibruar.

## Udhëzime për montimin

- Armatura duhet montuar, shpërlarë dhe kontrolluar në bazë të normave të vlefshme.
- Nëse lindin probleme me ngrohësin e ujit ose nëse dëshironi të keni më shumë qarkullim uji, atëherë EcoSmart® (kufizuesi i qarkullimit të ujit), i cili ndodhet pas ajrosësit, mund të çmontohet.
- Përpara montimit duhet që produkti të kontrollohet për dëmtime nga transporti. Pas instalimit nuk do të njihet asnjë dëmtim nga transporti ose dëmtim i sipërfaqes.

## Të dhëna teknike

### Rubineti është i pajisur si standard me EcoSmart® (Kufizues qarkullimi)

Presioni gjatë punës	maks. 1 MPa
Presioni i rekomanduar:	0,1 – 0,5 MPa
Presioni për provë:	1,6 MPa
(1 MPa = 10 bar = 147 PSI)	
Temperatura e ujit të ngrohtë	maks. 80 °C
Temperatura e rekomanduar e ujit të ngrohtë:	65 °C
Dezinfektim Termik:	maks. 70 °C / 4 min

Armaturat e Hansgrohe mund të përdoren në kombinim me ngrohës elektrikë të ujit të drejtuar në mënyrë hidraulike ose termike nëse presioni i rrjedhjes është minimumi 0,15 MPa.

Produkti është projektuar ekskluzivisht për ujë të pijshëm!

## Përshkrimi i simbolit



### Justimi

Rubinet me ujë të përzier me kufizim të ujit të ngrohtë, justimi shih faqen 38. Në kombinim me ngrohësit elektrikë të ujit nuk ka nevojë për bllokadë të ujit të ngrohtë.



Mos përdorni silikon që në përbërje ka acid acetik.



### Pastrimi

shikoni broshurën bashkëngjitur.



### Përmasat (shih faqen 34)



### Diagrami i qarkullimit (shih faqen 35)

- ① me EcoSmart®
- ② pa EcoSmart®



### Përdorimi (shih faqen 39)

Hansgrohe rekomandon që në mëngjes ose pas periudhave të gjata që gjysmë litri i parë mos të pihet



### Pjesë ndërrimi (shih faqen 36)



### Pajisje të posaçme

Çelësi i montimit 58085000 (nuk përfshihet në vëllimin e furnizimit)



Stuko për instalim (nuk përfshihet në vëllimin e furnizimit)



### Shenja e kontrollit (shih faqen 40)





## وصف الرمز

لضبط محدد الماء الساخن في الخلاطات ذات المقبض الواحد، يرجى الرجوع إلى صفحة 38. ولا يلزم إجراء أي ضبط عند استخدام سخان مياه ذي تدفق مستمر.

هام! لا تستخدم السليكون الذي يحتوي على أحماض!



## التنظيف

راجع والكتيب المرفق



أبعاد (راجع صفحة 34)



رسم للمصرف (راجع صفحة 35)



① بـ EcoSmart®

② بدون EcoSmart®

التشغيل (راجع صفحة 39)



تتصح شركة هانزجرهوي Hansgrohe بعدم استخدام أول نصف لتر من الماء لغرض الشرب وذلك في الصباح أو بعد توقف استخدام الماء لفترات طويلة نسبياً.

قطع الغيار (راجع صفحة 36)



## ملحقات خاصة

مفتاح التركيب (58085000) غير مدرج مع المحتويات المسلمة

طقم تركيب (غير مدرج مع المحتويات المسلمة)



شهادة اختبار (راجع صفحة 40)



## تنبيهات الأمان

- ⚠ يجب ارتداء قفازات لليد أثناء التركيب لتجنب حدوث أضرار الإنحشار أو الجروح.
- ⚠ لا يجب استخدام نظام الدش إلا في أغراض الاستحمام والأغراض الصحية وأغراض تنظيف الجسم.
- ⚠ يجب أن يكون تيار الماء الساخن والماء البارد متعادلين في الضغط.

## تعليمات التركيب

- يجب تركيب الوصلة واستخدامها واختبارها وفقاً للمعايير المعمول بها.
- إذا تسبب سخان الماء الجاري في أية مشكلات أو في حالة الرغبة في وجود تدفق أكثر للماء، يجب فك EcoSmart® (محدد تدفق المياه) الموجود خلف تجهيزة التهوية.
- قبل القيام بعملية التركيب، يجب فحص المنتج للتأكد من خلوه من أية تلفيات ناتجة عن النقل. بعد القيام بعملية التركيب، لن يتم الاعتراف بوجود أية تلفيات سطحية أو تلفيات ناتجة عن عملية النقل.

## المواصفات الفنية

يتم بشكل قياسي إنتاج الخلاط هذا مع EcoSmart® (محدد تدفق المياه)

- ضغط التشغيل: الحد الأقصى 1 ميجاباسكال
- ضغط التشغيل الموصى به: 0,5 – 0,1 ميجاباسكال
- ضغط الاختبار: 1,6 ميجاباسكال
- (1 ميجاباسكال = 10 بار = 147 PSI)
- درجة حرارة الماء الساخن: الحد الأقصى 80°C
- درجة الحرارة الموصى بها للماء الساخن: 65°C
- تقييم حراري: الحد الأقصى 4 / 70°C الدقيقة

يمكن استخدام خلاطات هانزجرهوي مع سخانات تدفق الماء ذات التحكم الهيدروليكي و الحراري، مع ضغط تدفق لا يقل عن 0,15 ميجاباسكال.

المنتج مخصص فقط لماء الشرب!



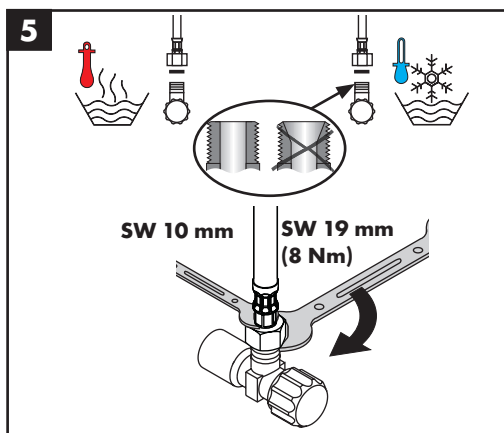
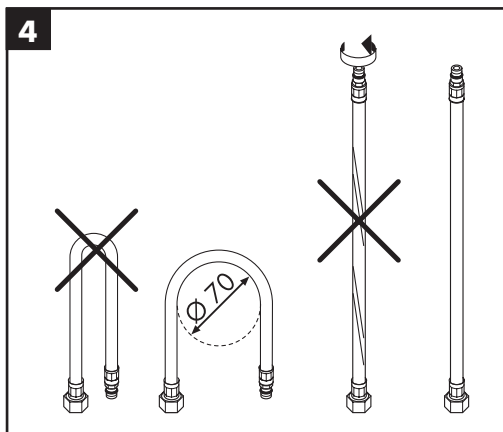
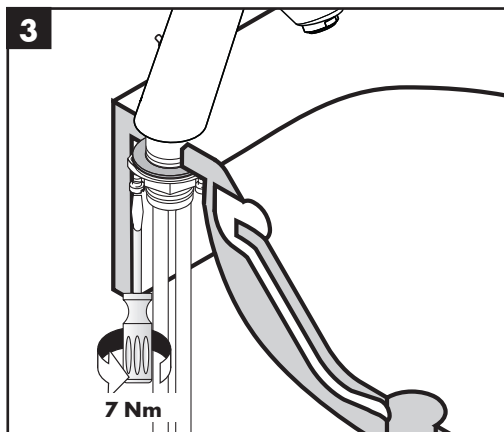
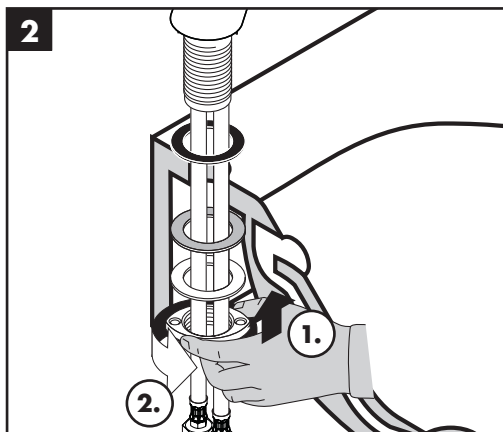
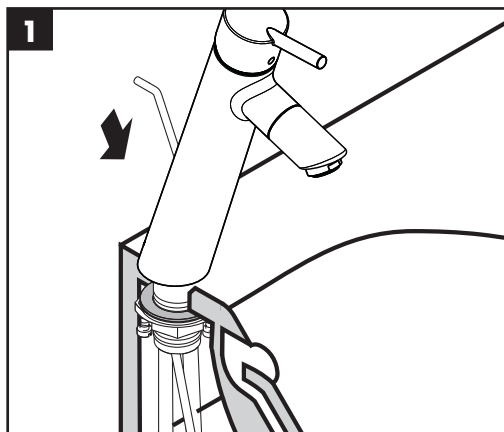

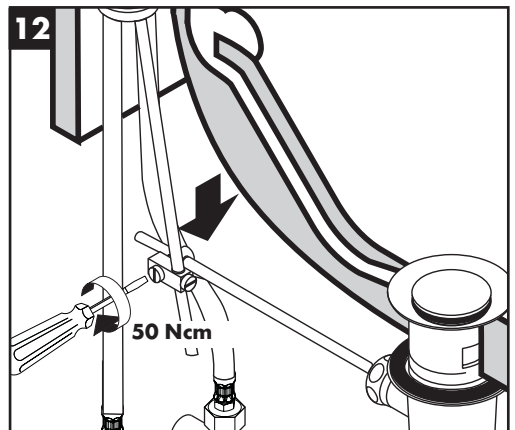
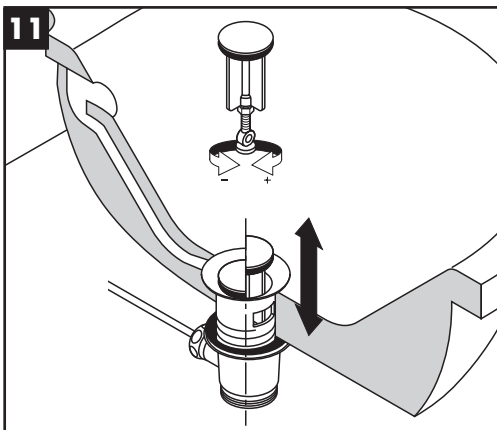
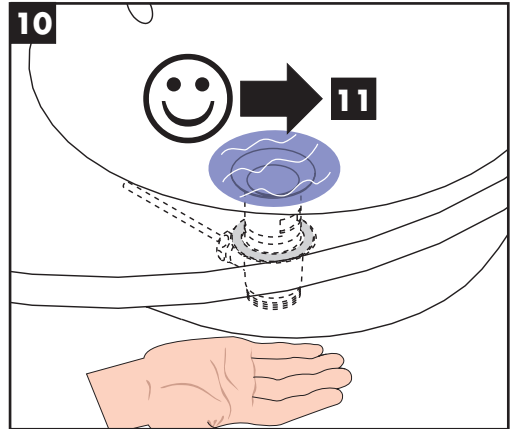
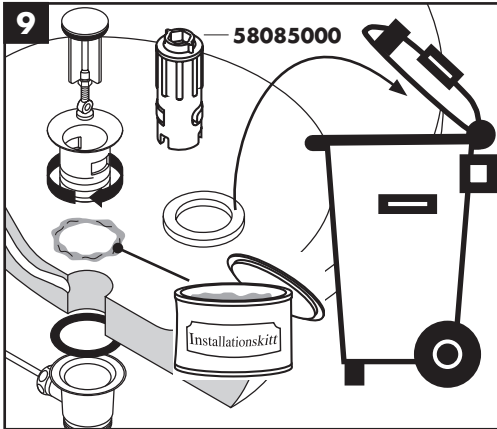
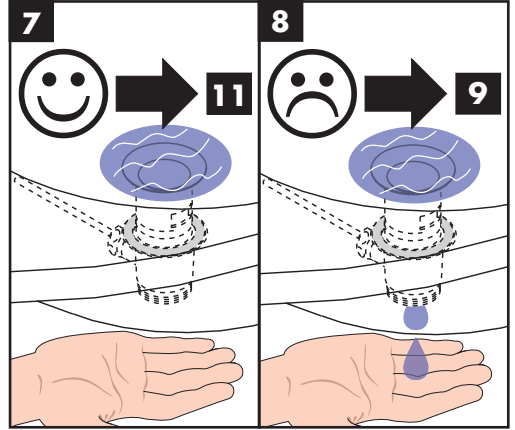
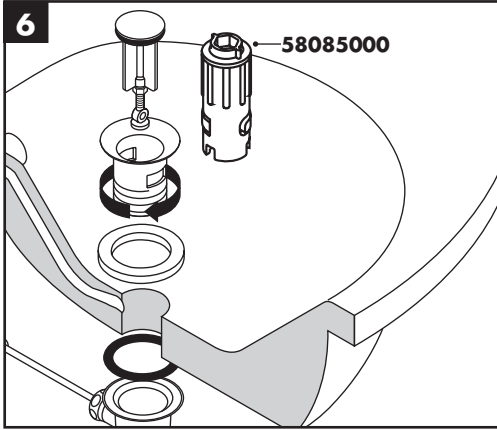



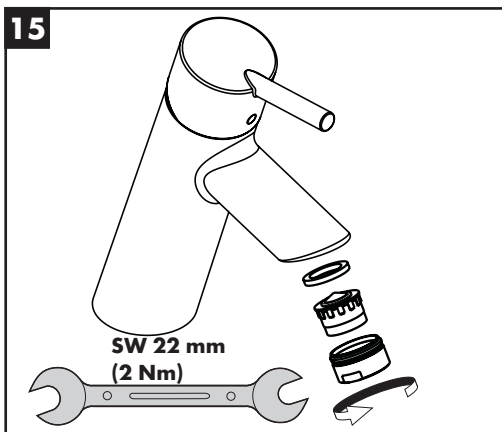
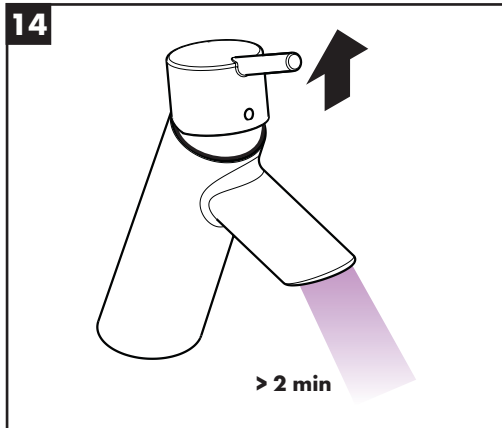
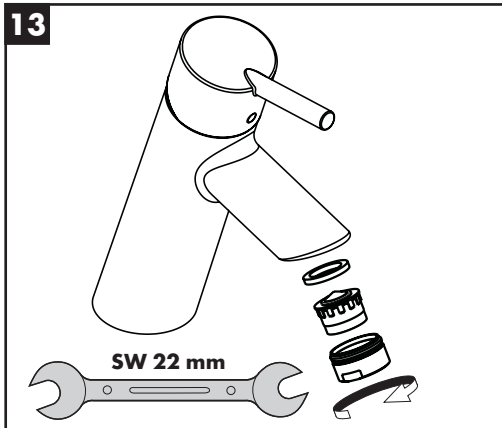



**Talis**  
32052000

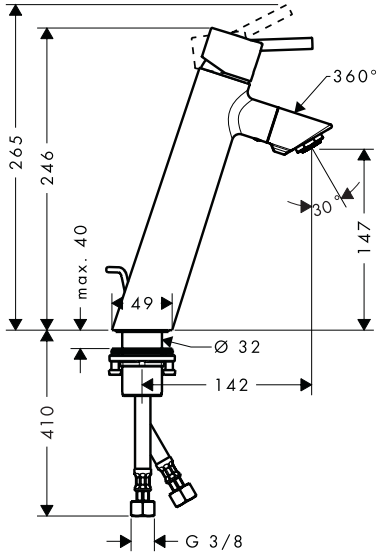

**Talis**  
32053000

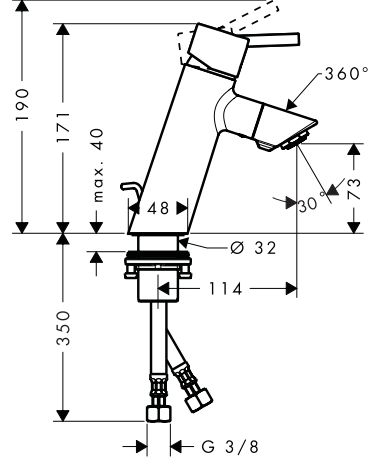

**Talis Care**  
32036000

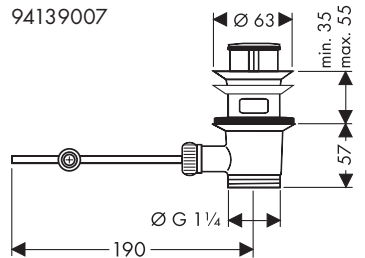
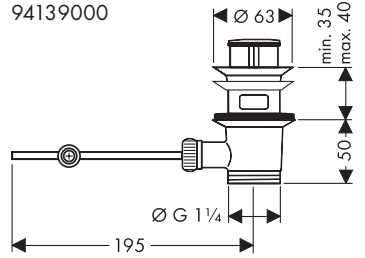
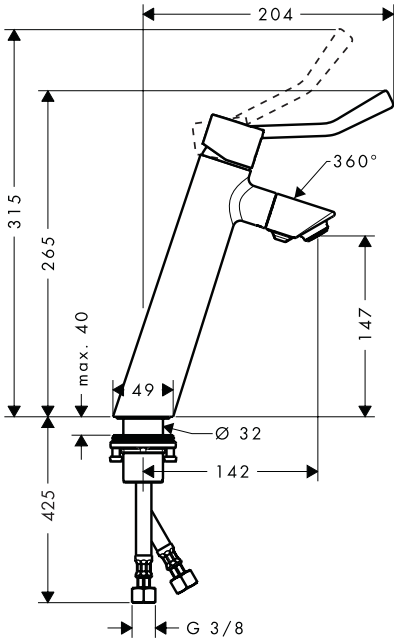



**Talis**

32052000 / 32053000

**Talis Care**

32036000

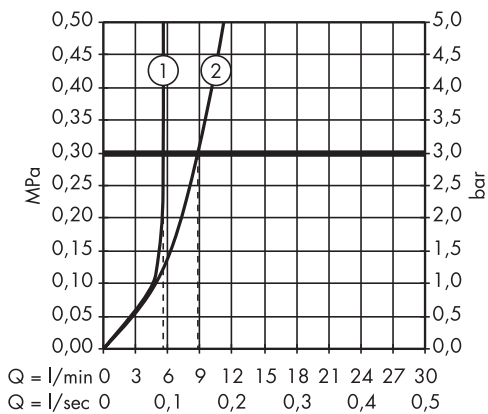



**Talis**

32052000 / 32053000

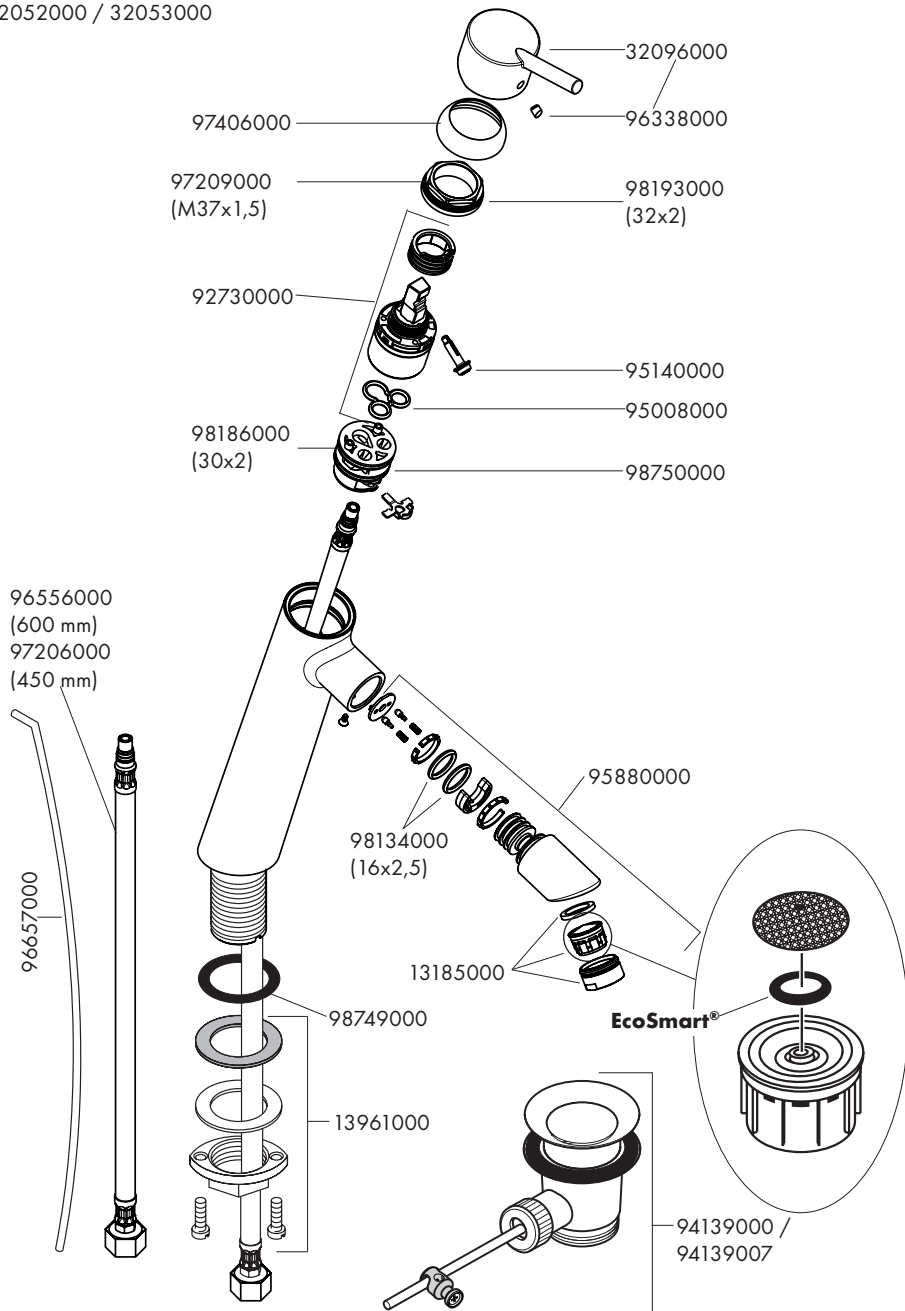



**Talis Care**  
32036000

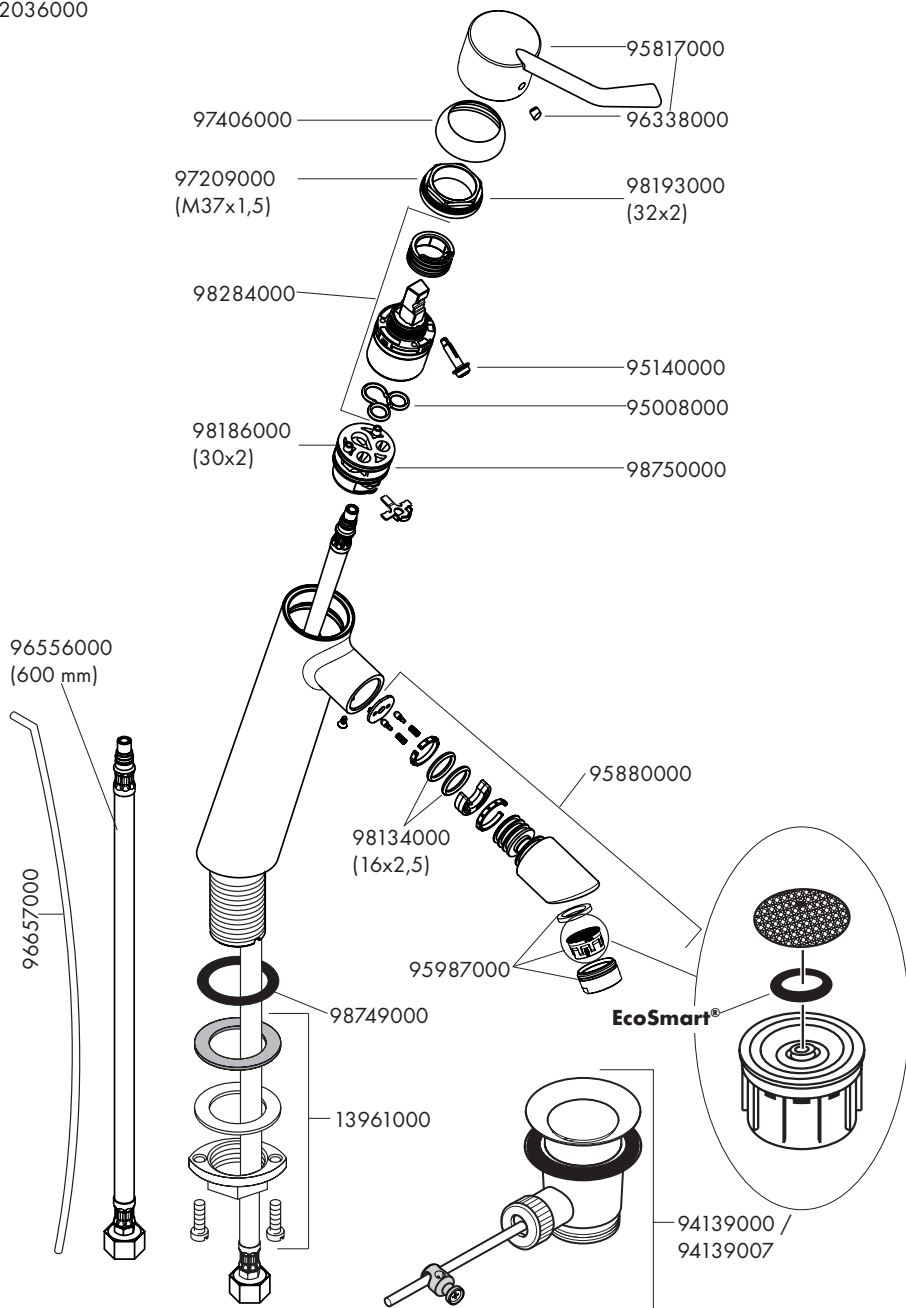

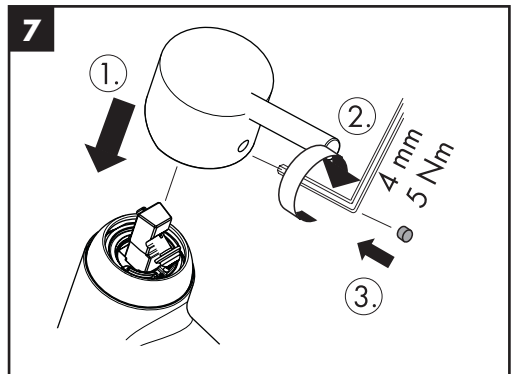
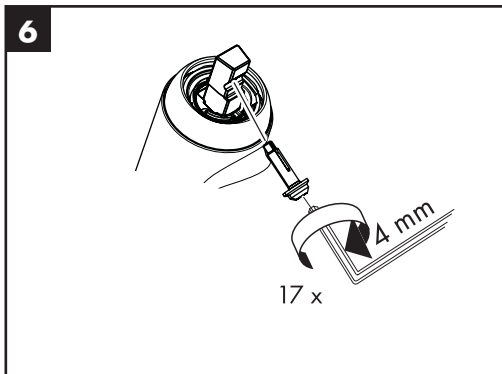
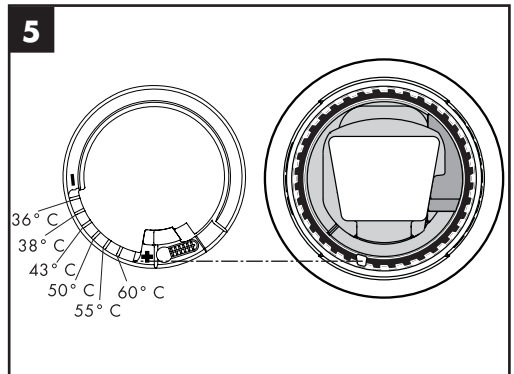
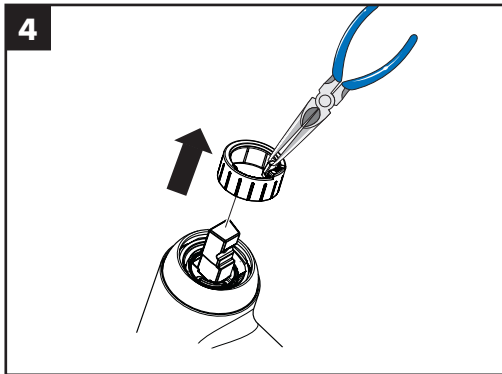
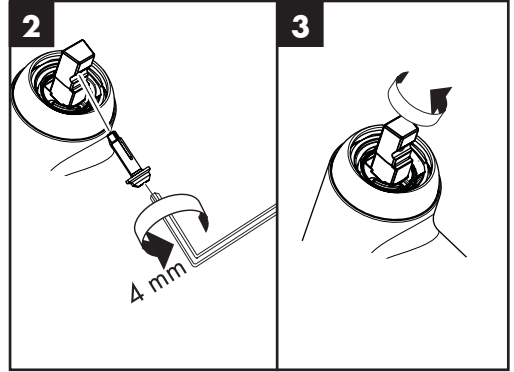
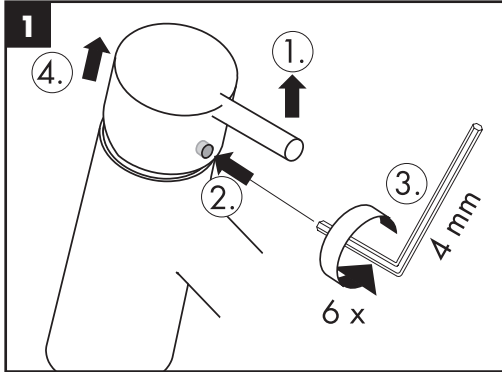

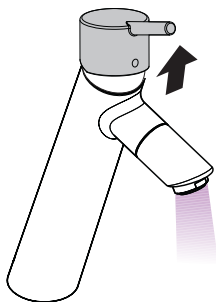

öffnen / ouvert / open / aperto / abierto / open / åbne /  
 abrir / otworzyć / otevřít / otvorit / 开 / открыть / nyitás /  
 avaaaminen / öppna / atidaryti / Отваранье / açmak /  
 deschide / ανοικτό / odpreti / avage / atvērt /  
 otvoriti / åpne / отваряне / hare / فتح

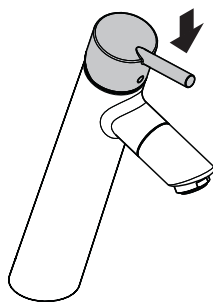

schließen / fermé / close / chiudere / cerrar / sluiten /  
 lukke / fechar / zamknąć / zavřít / uzavriť / 关 /  
 закрыть / bezárás / sulkeminen / stänga / uždaryti /  
 Zatvaranje / kapatmak / închide / κλειστό / zapreti /  
 sulgege / aizvērt / zatvori / lukke / затваряне / mbylle /  
 إغلاق

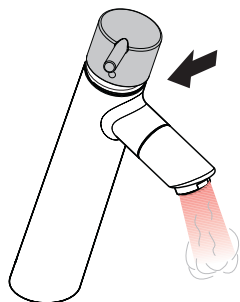

warm / chaud / hot / caldo / caliente / warm / varmt /  
 quente / ciepła / teplá / teplá / 热 / горячая / meleg /  
 lämmin / varmt / karštas / Vruća voda / sıcak / cald /  
 ζεστό / toplo / kuum / karsts / topla / varm /  
 тепло / i ngrohtë / ساخن

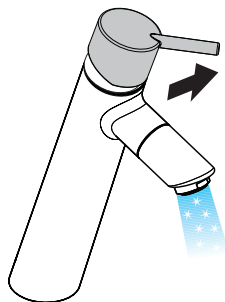

kalt / froid / cold / freddo / frío / koud / koldt / fria /  
 zimna / studená / studená / 冷 / холодная / hideg /  
 kylmä / kallt / šaltas / Hladno / soğuk / rece / krúo /  
 mrzlo / külm / auksts / hladno / kaldt / студено /  
 i ftohtë / بارد

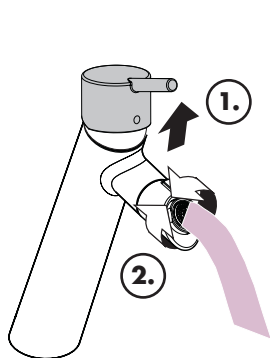

**Talis**  
 32052000  
**Talis Care**  
 32036000

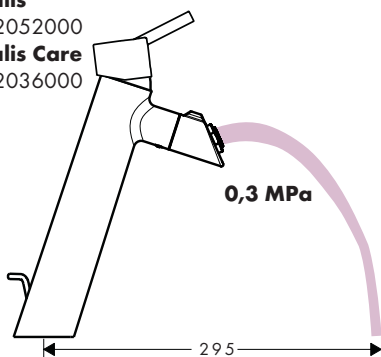

**Talis**  
 32053000

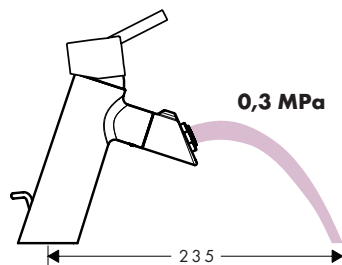



	P-IX	DVGW	SVGW	ACS	WRAS	KIWA	ETA
<b>32052000</b>	P-IX 7528/IO			X	X		VD 1.42/19940
<b>32053000</b>	P-IX 7528/IO			X	X		VD 1.42/19886
<b>32036000</b>	P-IX 19800/IO				X		VD 1.42/20149

