



Price List

Version 6: July 1, 2014



Company Statement

“Can you make ...?”

That’s how a lot of client phone calls to WCI begin. Designers and dealers know that we’re more than our catalog. We’re also the go-to collaborator for the custom designs other manufacturers are unable to handle.

For more than 75 years, we’ve been a creative and innovative partner to thousands of clients across the country and around the world. Whether it’s a café, bistro, conference room, corporate cafeteria, or that in-between space, our tables, banquettes, and seating are there for you. With all fabrication done at our Los Angeles factory our turnaround is perhaps the fastest in the industry.

WCI looks to the future inspired by its customer’s commitment to design, and is prepared to meet the ever-changing and rapidly expanding needs of the industries it serves.

Customers continually tell us, “You guys can do anything.” We think the customer is always right.

Take a look around our site at westcoastindustries.com, what you find might surprise you!

WCI
San Francisco, CA
800-243-3150

Table of Contents

2	Statement of Line
4	General Information
46	Pricing

Statement of Line

Dining | Multipurpose



Alumiline
48



Basic Round
50



Bolt Down
52



Capri
54



Corsica
56



Cozy Bar
58



Disc
60



Dunhill
68



Flat Round
78



Knobhill
86



Manhattan
88



Mark IV
90



Medici
98



Move
100



Parsons
102



Platform
104



Post Leg
112



Presidio
120



Regency
130



Scala
134



Siena
136



Slimline
138



Spacesaver
148



Toscana
150



Tulip
152



Tuscan
160

Statement of Line

Occasional



Cube
172



Cylinder
174



Disc
176



Move
180



Parsons
182



Platform
186



Tulip
188

Outdoor Tables



Arc
194



Basic Round
196



Bistro
198



Disc
200



Flat Round
202



Mark IV
204



Park
206



Platform
208



Sam Table
210



Tulip
212

Outdoor Chairs



Breeze
216



Courtyard
216



Piazza
216



Picnic
216



Polly
216



Sam Chair
217

General Information

5	Terms and Conditions
7	Warranties
8	Guaranteed Freight Program
10	GSA
12	Care and Maintenance

General Information | Terms and Conditions

Prices

Possession of this price list does not in itself constitute authority to sell and/or purchase product herein. All prices are LIST prices. Prices are effective with current date printed on the cover and supersede all other price lists. All accepted orders are subject to prevailing prices at time of order. WCI reserves the right to change prices or specifications without prior notice. Prices do not include tax or installation. Additional charges may apply on special requests for inside delivery, "call before," etc.

Minimum Order

WCI's minimum order is \$1,500 LIST, and orders under this amount will be subject to a \$150 service charge.

New Accounts

Customers who have purchased more than \$5,000 LIST in the last 12 months are eligible to seek terms with WCI. To establish an open account, submit a bank reference and at least three current open account references. Send full credit information along with complete address and telephone numbers to: West Coast Industries, Inc., 750 Battery St, Suite 100, San Francisco, CA 94111. Allow approximately two weeks for processing.

Credit and Payment Terms

Initial orders under \$2500 LIST require full amount in advance. Otherwise, unless credit has been established with WCI, terms will be a 50% deposit with order and balance paid in full prior to shipment. Payment terms for all customers with approved credit limits are net 30 days. Banquette orders require a 50% deposit with the order and the balance must be paid in full from date of shipment or within previously established and agreed to terms. Invoices must be paid within these terms in order to maintain open account status. Payments should be made to our main office in San Francisco. Past due accounts (over 30 days) are subject to an interest rate of 1.5% per month (18% per year), or the maximum amount permitted under local law. The customer will be liable for any costs incurred in collection of past due amounts, including attorneys' fees, whether or not a suit is filed. Charging purchases to an open account constitutes acceptance of our stated terms. WCI reserves the right to change terms without prior notice.

Acknowledgement

All orders are manufactured and shipped according to the acknowledgement and its terms and conditions. It is the customer's responsibility to note any discrepancies on the acknowledgement and to notify WCI immediately. The printed acknowledgement constitutes the final agreement between the customer and WCI, thus superseding all previous communications regarding the order.

Changes or Cancellations

Any changes to or cancellation of an order must be submitted to WCI in writing. Acknowledged orders for special, non-standard, and custom products cannot be cancelled. Approved change request orders may be subject to a revised production schedule and additional material and labor charges. Approved cancellation requests will be subject to restocking, material, and labor charges.

Orders

All orders must include WCI product model number, final material, and finish specifications for order entry.

Send your orders directly to:

Postal Service or Courier Service:

WCI
Attn: Order Entry
750 Battery St, Ste 100
San Francisco, CA 94111

Fax: 415-552-5368

Email: order@westcoastindustries.com

Duplicate orders that are received by mail (after being faxed or emailed) and not marked “confirmation” are the responsibility of the customer.

Designs and Specifications

All designs and specifications are subject to change without prior notice. Any item or material may be discontinued without prior notice. All weights and dimensions are approximate.

Tables

All tables manufactured by WCI are warranted to the original purchaser covering normal usage for a period of twelve years from the date of the original invoice. WCI will replace or repair (at our discretion) without cost to our customers any item found to be defective as a result of defective materials or workmanship. We will not, however, repair any item which has been abused or subjected to any use other than that which was originally intended for our product. Any repairs by the customer must receive specific written authorization from WCI before being executed on location to receive proper reimbursement for associated costs. In no event shall liability under this warranty exceed the original purchase price.

Electrical items not manufactured by WCI are covered for a period of one year.

Wood Furniture is made of natural variable raw material. Differences in grain characteristics and color among wood species are naturally occurring variations and are not within the control of WCI nor considered defects included in this warranty.

Plastic laminates, Corian®, 3Form, and acrylic are not warranted by WCI, but are warranted by the respective manufacturers under their specific warranty only.

Banquettes

WCI banquette frames are warranted to be free of defects in materials and workmanship covering normal usage to the original purchaser for a period of seven years from the date of the original invoice. WCI will replace or repair (at our discretion), without cost to our customers, any item found to be defective as a result of defective material or workmanship. This warranty does not apply to damage resulting from accident, misuse, abuse, alteration or negligence. Any repairs by the customer must receive specific written authorization from WCI before being executed on location to receive proper reimbursement for associated costs. WCI will not be liable for any additional charges sustained by the customer because of improper installation by others, usage or after market additions.

Plastic laminates and upholstery are not warranted by WCI, but are covered by laminate and textile manufacturers under their specific warranty only. Wood Furniture is made of natural variable raw material. Differences in grain characteristics and color among wood species are naturally occurring variations and are neither within the control of WCI, nor considered defects included in this warranty.

COM textiles and COL leathers are not warranted.

Outdoor

All outdoor products manufactured by WCI are warranted to the original purchaser covering normal usage for a period of one year from the date of the original invoice. WCI will replace or repair (at our discretion) without cost to our customers any item found to be defective as a result of defective material or workmanship. We will not, however, repair any item which has been abused or subjected to any use other than that which was originally intended for our product. Any repairs by the customer must receive specific written authorization from WCI before being executed on location to receive proper reimbursement for associated costs. In no event shall liability under this warranty exceed the original purchase price.

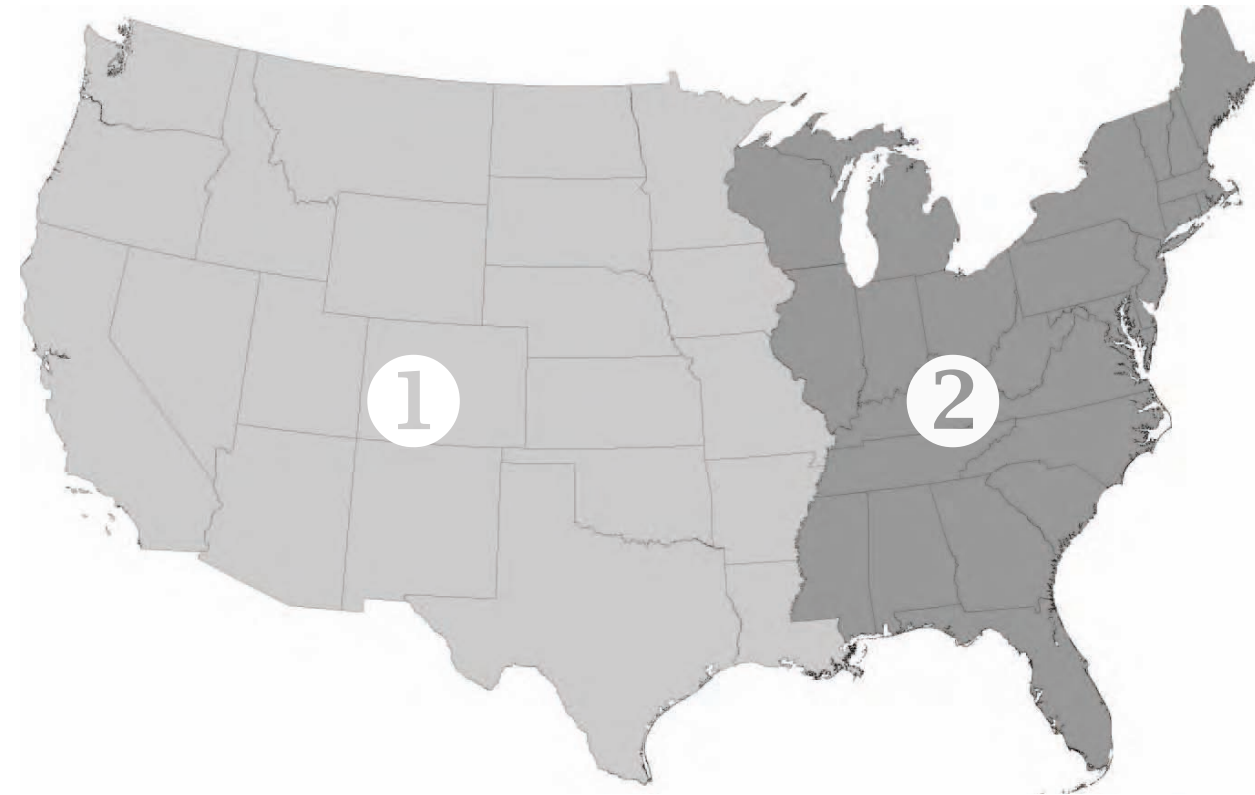

Zone 1: Add 5%	Zone 2: Add 10%
Arizona, Arkansas, California, Colorado, Hawaii, Idaho, Iowa, Kansas, Louisiana, Minnesota, Missouri, Montana, Nebraska, Nevada, New Mexico, North Dakota, Oklahoma, Oregon, South Dakota, Texas, Utah, Washington, and Wyoming.	Alabama, Connecticut, Delaware, Florida, Georgia, Illinois, Indiana, Kentucky, Maine, Maryland, Massachusetts, Michigan, Mississippi, New Hampshire, New Jersey, New York, North Carolina, Ohio, Pennsylvania, Rhode Island, South Carolina, Tennessee, Vermont, Virginia, West Virginia, and Wisconsin.

Tables and Outdoor

Tables and outdoor orders will be shipped F.O.B. factory. To calculate your guaranteed freight cost, refer to the map and zone matrix above. Zone percentage is calculated based on the total NET value of the order, and freight cost is included on invoices. WCI reserves the absolute right to determine the method of shipping unless special delivery instructions have been previously approved. Products shipped to Alaska, Hawaii, and Canada are F.O.B. factory, freight prepaid to port of embarkation, based on percentages as outlined above. Customer is responsible for freight charges from port of embarkation to final destination.

Banquettes

WCI Banquettes do not include freight. Banquettes are shipped F.O.B. factory, uncartoned for blanket wrap shipment. WCI will negotiate discounted freight rates on the customer's behalf, and will include those rates on the invoice.

Freight Claims

WCI will file freight claims for WCI tables and outdoor products only. In the event of damage and/or shortages, immediately call WCI at **800-243-3150** to initiate a freight claim and replacement or repair. Concealed damage must be reported in writing to the freight carrier and WCI within two business days. Failure to make a claim against WCI within five days will constitute acceptance of merchandise and waiver of any defects, shortages, or errors found upon inspection. The customer must file all freight claims for banquettes.

Normal Delivery

Normal delivery is on a dock to dock basis. Special requests, such as inside delivery, "call before," etc, should appear on the customer's purchase order and are subject to additional charges. Every attempt will be made by WCI to accommodate customers' requests. Delivery date is subject to strikes, accidents, availability of supplies, and any other causes beyond our control. WCI may stop and/or hold shipment if payment terms, account status, or credit are not satisfactory.

Will Call

Customers may choose to pick up orders at our factory. Customers will be notified when their order is ready for orders marked "will call." Pick up must be made within five business days or order will incur storage charges. Customer pick up is available between 8 AM and 2 PM PST. Please call WCI customer service at 800-243-3150 to schedule a customer pick-up.

Storage

Commencing on the ship date, there is a five business day grace period for all table and outdoor orders, during which there will be no storage fees. Following the grace period, there is a minimum storage charge of \$350 per month. Orders over \$10,000 will incur an additional 1.5% fee per month based on NET value of the order. In addition, a Storage Fee Agreement must be signed by customer and returned to customer service. Customers that are CBD (cash before delivery) must pay for all storage fees before the order is shipped.



General Services Administration

Federal Supply Service Authorized Federal Supply Schedule Price List

On-line access to contract ordering information, terms and conditions, up-to-date pricing, and the option to create an electronic delivery order are available through GSA Advantage!, a menu-driven database system. The internet address for GSA Advantage! is: www.gsaadvantage.com

FSC Group 71 Office Furniture	DUNS #: 05-034-8689
CONTRACT #: GS-28F-0023R	Cage Code #: 35FR2
CONTRACT PERIOD: May 3, 2010 through May 2, 2015	Tax ID: 94-1383497
SIN 711-11 Tables and accessories	Business Size: SMALL
SIN 711-12 System type tables and accessories*	

CONTRACTOR:

West Coast Industries, Inc.
 750 Battery Street Suite 100
 San Francisco, CA 94111
 Phone: (415) 621-6656
 Fax: (415) 552-5368
www.westcoastindustries.com

CONTRACT ADMINISTRATION:

West Coast Industries, Inc.
 750 Battery Street Suite 100
 San Francisco, CA 94111
 Phone: (415) 621-6656
 Fax: (415) 552-5368
 Email: gsa@westcoastindustries.com

Information for Ordering Activities

1a. Awarded SIN(s):

- 711-11 Tables and Accessories
- 711-12 System type tables and accessories*

1b. Identification of the lowest priced model number and lowest unit price for that model for each special item number awarded in contract.

- 2.** Maximum Order: \$200,000
- 3.** Minimum Order: \$100
- 4.** Geographic Coverage: 48 Contiguous United States
- 5.** Point(s) of Production: Los Angeles, CA 90021
- 6.** For single delivery orders, the GSA discount from list price as shown in this commercial price list will apply.
- 7.** Quantity Discounts: None Offered
- 8.** Prompt Payment Terms: Net 30 Days
- 9a&b.** Government credit cards NOT accepted
- 10.** Foreign Items: NOT APPLICABLE
- 11a.** Time of Delivery: 45 Days ARO

*Products under SIN 711-12 consist of items set aside exclusively for small businesses.



- 11b.** Expedited Delivery: Products are available for expedited delivery. Expedited delivery time is negotiated between Contractor and Ordering Agency.
- 11c.** Overnight and 2-day Delivery: Products are available for expedited delivery. Expedited delivery time is negotiated between Contractor and Ordering Agency.
- 11d.** Urgent Requirements: Products are available for expedited delivery. Expedited delivery time is negotiated between Contractor and Ordering Agency.
- 12.** F.O.B. Point(s): F.O.B. Factory, freight prepaid and added to invoice for deliveries within the 48 contiguous United States.
- 13a.** Ordering Address: West Coast Industries, Inc., 750 Battery Street, Suite 100, San Francisco, CA 94111
- 13b.** Ordering Procedures: For supplies and services, the ordering procedures, information on Blanket Purchase Agreements (BPA's), and sample BPA's can be found at the GSA/FSS Schedule homepage (fss.gsa.gov/schedules).
- 14.** Payment Address: West Coast Industries, Inc., 750 Battery Street, Suite 100, San Francisco, CA 94111
- 15.** Warranty Provision: All WCI products are warranted to the original purchaser covering normal usage for a period of one year from the date of original invoice.
- 16.** Export Packing Charges: To be negotiated between Contractor and Ordering Agency.
- 17.** Terms and Conditions of Government Purchase Card Acceptance (any thresholds above the micro-purchase level): SAME
- 18.** Terms and Conditions of Rental, Maintenance, and Repair: No merchandise will be accepted for return, repair or credit without the written approval from West Coast Industries' main office. Approved returns must be shipped with all freight charges prepaid. West Coast Industries does not accept collect freight shipments or shipments of returned merchandise where freight damage has occurred. Approved returns will be subject to a 20% restocking charge.
- 19.** Terms and Conditions of Installation: NOT APPLICABLE
- 20a.** Terms and Conditions of repair parts indicating date of parts price lists and any discounts from list prices: NOT APPLICABLE
- 20b.** Terms and Conditions for Any Other Services: NOT APPLICABLE
- 21.** List of Service and Distribution Points: NOT APPLICABLE
- 22.** List of Participating Dealers: Contact West Coast Industries
- 23.** Preventative Maintenance: NOT APPLICABLE
- 24.** Special Attributes Such as Environmental Attributes (e.g., recycled content, energy efficiency, and/or reduced pollutants): NOT APPLICABLE
- 25.** DUNS #: 05-034-8689
 Cage Code: 35FR2
 Fed ID: 94-1383497
- 26.** Active registration on the System for Award Management (SAM) database

Table Tops

Plastic Laminate and Ultrafoam Table Tops

Laminate topped tables should be cleaned with a mild, non-abrasive cleaner and cloth.

Wood Veneer and Butcher Block Table Tops

Wood must be treated as a breathing, living material. Like all organisms, it is subject to changes depending upon the environment in which it exists. The principal concern is the humidity in the surrounding atmosphere and its effect on the wood. Like many other materials, wood shrinks when it loses moisture and it swells when it absorbs it.

Keeping WCI wood finishes looking beautiful is easy. Simply wipe the table top clean with a soft damp cloth moistened with water, and then dry with a soft cloth.

Note: Do not use commercial cleaners, abrasives, solvents, Windex, 409, Ajax, etc. on the table top as this will wear away the acrylic waterborne enamel.

Spills should be wiped up promptly and wiped dry as described above. Spills should never be left on the finish overnight.

WCI wood finishes should be protected from excessive heat. A heat pad, coaster or trivet should be used to protect the table top from pots, pans, hot serving dishes, drinks, plates, etc.

3form® Chroma® Table Tops

Please follow this link: http://www.3-form.com/downloads/3form_matspec_chroma_rev030.pdf

Acrylic Table Tops

Acrylic table tops consist of specially formulated acrylic, providing a tough nonporous surface material with superior stain and UV light resistance. Color and material is consistent throughout the top, providing a renewable surface. Most dirt and residue can be removed by washing with warm soapy water, followed by rinsing with clean water and wiping down with a dry towel to eliminate water spots. Disinfecting acrylic table tops can be accomplished using (1) part household bleach mixed with (1) part water. Wash and rinse thoroughly, and wipe dry.

Minor scratches and burns on matte finish can be buffed out with a medium ScotchBrite pad, followed by wiping the area down with soapy water and towel dry. Minor scratches and burns on gloss finish can be buffed out with a white ScotchBrite pad, or wet sanded with 2000 grit sandpaper, followed by wiping area with soapy water and towel dry. Deep scratches and burns should be repaired by a professional fabricator.

Acrylic table tops have excellent heat resistant qualities; however, it is important, as with all table top materials, to minimize direct exposure to heat. WCI recommends using hot pads or trivets when placing hot objects on any acrylic table top.

Caution: Nail polish, nail polish remover, and any acetone based liquid will permanently stain and/or damage the acrylic table top. Chemicals such as paint remover, metal cleaner, oven cleaner, abrasive cleaner, and acid drain cleaner will also damage acrylic table tops and should not be used.

Corian® Table Tops

Please see: http://www2.dupont.com/Surfaces_Commercial/en_US/tech_info/care_and_maintenance/Corian.html

Table Bases

Powder Coat and Plated Bases

All powder coat and plated bases should be cleaned with a mild, non-abrasive cleaner and cloth. Users are urged to make periodic inspections to look for damage, loose screws and bolts, or other signs of structural fatigue incurred in daily handling, use, and abuse. Examination must include structural joints, corner blocks, welds, and any other stress points. Any product found to be damaged, defective or loose should be taken out of service immediately.

Metal Tables

All metal tables are suitable for indoor and outdoor applications. They have been pretreated and powder coat finished to resist the elements all year long without fading, rusting, or cracking.

For regular cleaning of the metal frames, use a solution of mild, non-abrasive soap and warm water. For more difficult stains, use a mild household cleaner. Avoid using abrasives and chemical cleaners. Always test a small area prior to cleaning. Do not pressure wash.

Chairs

Metal

All metal chairs are suitable for indoor and outdoor applications. They have been pretreated and powder coat finished to resist the elements all year long without fading, rusting or cracking.

For regular cleaning of the metal frames, use a solution of mild, non-abrasive soap and warm water. For more difficult stains, use a mild household cleaner. Avoid using abrasives and chemical cleaners. Always test a small area prior to cleaning. Do not pressure wash.

Polypropylene

Injection molded polypropylene chairs are suitable for indoor and outdoor applications. UV inhibitors in the polypropylene protect against sun rays.

To maintain the finish of polypropylene chairs, clean regularly with warm sudsy water – never use abrasive cleaners or boiling water.

For regular cleaning of the chair's metal frames, use a solution of mild, non-abrasive soap and warm water. For more difficult stains, use a mild household cleaner. Do not use abrasives and chemical cleaners. Always test a small area prior to cleaning. Do not pressure wash.

Synthetic Rattan

The Piazza chairs have woven synthetic rattan backs and seats. To maintain the rattan, clean regularly with warm sudsy water – never use abrasive cleaner or boiling water. Do not pressure-wash or use petroleum based solvents or cleaners as this will damage the synthetic rattan.

General Maintenance

Our customers are urged to make periodic inspections to look for damage, loose screws and bolts or other signs of structural fatigue incurred in daily use. Examination must include structural joints, corner blocks, welds and any other stress points. Any product found to be damaged, defective or loose should be taken out of service immediately.

Product Specifications

- 15 How to Order a Table
- 16 Material and Finish Codes
- 19 Bases
- 22 Occasional Bases and Tables
- 23 Outdoor Bases and Tables
- 24 Outdoor Chairs
- 25 Tops
- 27 Edge Profiles
- 30 Laminate Reference Guide
- 32 Corian® Reference Guide
- 33 Wood Grain and Patterns
- 34 Grommet Locations
- 35 ADA Tables
- 36 Banquettes

Product Specifications | How to Order a Table

- DI36RDWWFLMBK** This model number represents a table with a Disc series matte black powder coat base, a 36" round 1.25" thick wood veneer top with a .125" flat wood edge profile.
- WNM WNM** The top material and finish options specify a wood veneer natural maple top with a wood veneer natural maple edge.
- 42AH** The table options specify an alternate height base with a 42" overall table height.

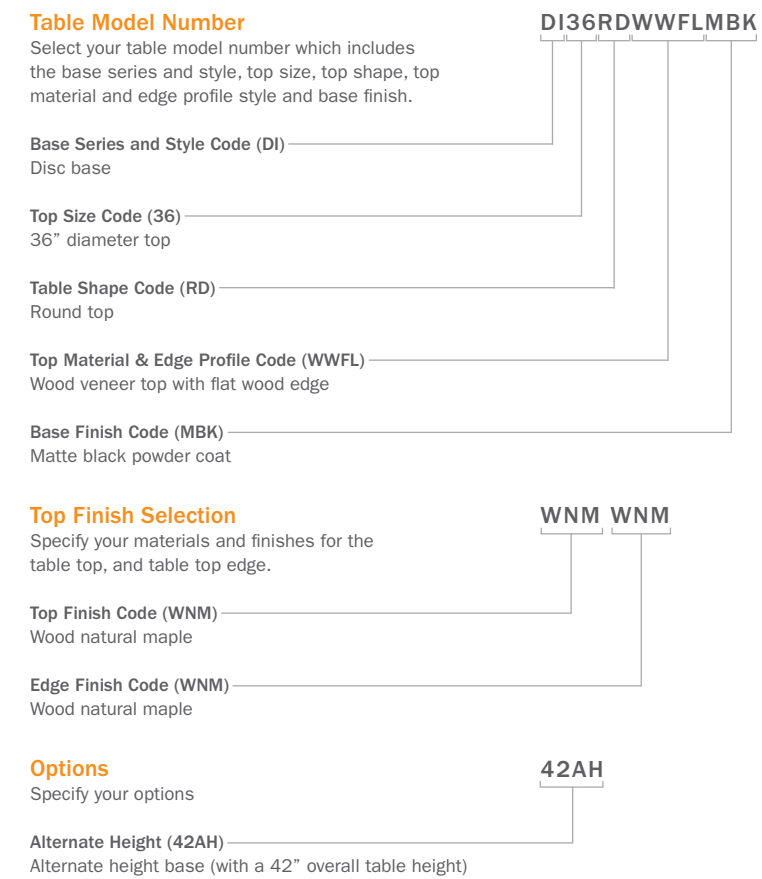

Base Finishes

Powder Coat

Solid Colors

MWH	White
MLG	Light Gray
MMG	Medium Gray
MDG	Dark Gray
MBK	Matte Black

Metallics

MSL	Silver
MGR	Graphite
MCH	Champagne
MDT	Dark Tone

Textures

MST	Stucco
MIG	Iron Glimmer
MWR	Black Wrinkle
MRB	Rubbed Bronze
MAN	Anthracite

Aluminum

MAA	Anodized Aluminum
MPA	Polished Aluminum
MSA	Satin Aluminum

Plated

Standard Plated

MPC	Polished Chrome
MSC	Satin Chrome

Premium Plated

MPB	Polished Brass
MSB	Satin Brass
MAB	Antique Brass
MPO	Polished Copper
MSO	Satin Copper
MSZ	Statuary Bronze

Hot Rolled Steel

MHS	Hot Rolled Steel with Clear Coat (move table only)
------------	---

Custom

CPC	Custom Powder Coat
------------	--------------------

Surface Materials

Laminate See WCI Laminate Reference Guide, Page 30

Wood

Maple

WNM	Natural Maple
WHM	Honey Maple
WEM	Ebony Maple

Oak

WNO	Natural Oak
WMO	Medium Oak
WEO	Ebony Oak

Cherry

WNC	Natural Cherry
WMC	Medium Cherry
WEC	Ebony Cherry
WMA	Mahogany over Cherry

Walnut

WNW	Natural Walnut
WMW	Medium Walnut
WDW	Dark Walnut

Maple Butcher Block

BNM	Natural Maple
BEM	Ebony Maple
BNC	Natural Cherry Over Maple
BMA	Mahogany Over Maple

Ultrafoam

ULFP	Flat White PVC Edge
ULFR	Unfinished Edge

Acrylic

Opaque

AWQ	White Quartz
ABQ	Black Quarry
AMD	Moon Dust
AKH	Khaki
AGD	Gold Dust
AGV	Gravel

Translucent

AGL	Glacier
ATR	Terrain
AGY	Golden Ray

Surface Materials

Corian® See WCI Corian® Reference Guide, Page 32

3form® Chroma® See 3form® website for additional colors

FAE	Aloe
FAC	Atlantic
FCA	Camel
FEG	Eggplant
FGH	Ghost
FMA	Marmalade
FMS	Moss
FPW	Pewter
FSB	Sable
FSY	Sassy

Metal Solid & Mesh

MES	Solid*
MEM	Mesh (Park & Bistro tables only)
MSS	Scalloped Pattern (Sam table only)

Powder Coat

Solid Colors

MWH	White
MLG	Light Gray
MMG	Medium Gray
MDG	Dark Gray
MBK	Matte Black

Metallics

MSL	Silver
MGR	Graphite
MCH	Champagne
MDT	Dark Tone

Textures

MST	Stucco
MIG	Iron Glimmer
MWR	Black Wrinkle
MRB	Rubbed Bronze
MAN	Anthracite

*Available on select tables only.

Edge Materials

Laminate See WCI Laminate Reference Guide, Page 30

Vinyl & PVC

VWH	White
VLG	Light Gray
VMG	Medium Gray
VDG	Dark Gray
VBK	Black
VDT	Dark Tone

Metal

MPR	Polished Aluminum Ribbed
MSR	Satin Aluminum Ribbed
MPA	Polished Aluminum
MSA	Satin Aluminum

Wood

Maple	
WNM	Natural Maple
WHM	Honey Maple
WEM	Ebony Maple
Oak	
WNO	Natural Oak
WMO	Medium Oak
WEO	Ebony Oak
Cherry	
WNC	Natural Cherry
WMC	Medium Cherry
WEC	Ebony Cherry
WMA	Mahogany Over Cherry
Walnut	
WNW	Natural Walnut
WMW	Medium Walnut
WDW	Dark Walnut
Maple Butcher Block	
BNM	Natural Maple
BEM	Ebony Maple
BNC	Natural Cherry Over Maple
BMA	Mahogany Over Maple

Ultrafoam

ULFP	Flat White PVC Edge
ULFR	Raw Edge

Chair Materials (Seat and Back)

Molded Polypropylene

Standard Colors	
PWH	White
Supplemental Colors	
PGR	Green
PIV	Ivory
POR	Orange
PRD	Red
PYE	Yellow

Synthetic Rattan

RBK	Black
RHN	Honey

Metal

Aluminum	
MPA	Polished Aluminum

Chair Finishes (Frame)

Metal

Aluminum	
MPA	Polished Aluminum

Powder Coat

Metallics	
MSL	Silver

Dining and Multipurpose

AL



Aluline

Standard Base Height: 28"
 Base: 26", 32" & 39" X-base and 26" T-base configurations, cast aluminum
 Column: 2.5" or 3" diameter, aluminum tubing
 Top Plate: 7.625" or 15" square steel
 Standard Glide: Black nylon (GNY) on powder coated bases, nickel plated glide (GNP) standard on satin (MSA) and polished (MPA) aluminum bases
 Standard Finish: Powder coated
 Optional Finishes: Polished or satin aluminum.

BA



Basic Round

Standard Base Height: 28"
 Base: 14", 17", 20", 22" & 28" diameter cast iron, also available with decorative steel cover plate for powder coating and plating.
 (L=light, M=medium, H=heavy weight)
 Column: 3", 3.5" or 6" diameter, steel tubing
 Top Plate: 7.625" or 15" square steel
 Standard Glide: White nylon carpet glide (GNC)
 Standard Finish: Cast iron in black wrinkle (MWR)
 Optional Finishes: Powder coated and plating

JB

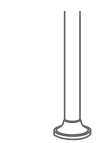

Bolt Down

(JB) J Bolt-down Base
 (TB) Trumpet Bolt-down Base
 (BB) Beehive Bolt-down Base
 (FB) Florentine Bolt-down Base
 Standard Base Height: 28"
 Floor Plate: 6.75" diameter steel with four .375" diameter holes; fasteners to attach base to floor are not included.
 Cover Plate: 8" diameter steel, finish to match column
 Column: 3" diameter, steel tubing
 Top Plate: 7.625" square steel
 Standard Finish: Powder coated
 Optional Finish: Plated

CA

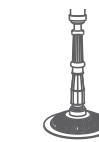

Capri

Standard Base Height: 28"
 Base: 15.25" diameter cast iron
 Column: Cast iron
 Top Plate: 7.625" square steel
 Standard Glide: White nylon carpet glide (GNC)
 Standard Finish: Powder coated

CR



Corsica

Standard Base Height: 28"
 Base: 15.25" & 24" diameter cast iron
 Column: Cast iron
 Top Plate: 7.625" or 15" square steel
 Standard Glide: White nylon carpet glide (GNC)
 Standard Finish: Powder coated

CB



Cozy Bar

Standard Base Height: 41"
 Base: 17", 20" x 22" diameter cast iron, also available with decorative steel cover plate for powder coating and plating.
 Footring: Made from 1" diameter steel tubing mounted to base
 Footring Finish: Polished (MPC) and satin (MSC) chrome
 Column: 3" diameter, steel tubing
 Top Plate: 7.625" square steel
 Standard Glide: White nylon carpet glide (GNC)
 Standard Finish: Cast iron in black wrinkle (MWR)
 Optional Finishes: Powder coated and plated

DI



Disc

Standard Base Height: 28"
 Base: 18", 22" & 26" diameter .375" thick steel plate
 Column: 2" or 3" diameter, steel tubing
 Top Plate: 7.625" or 15" square steel
 Standard Glide: White nylon carpet glide (GNC)
 Standard Finish: Powder coated
 Optional Finish: Plated

DU









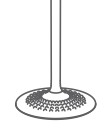

Dunhill

Standard Base Height: 28"
 Base: 18", 24", 30" & 36" X-base configurations, 18", 24" & 30" T-base configurations with a single column. Double column T-bases are available 30" or 36" wide, .5" x 2.5" solid steel bar
 Column: 2", 2.25", 3" or 3.25" diameter, steel tubing
 Top Plate: 7.625", 10.75" or 15" square steel
 Standard Glide: Black octagon (GNO)
 Standard Finish: Powder coated
 Optional Finish: Plated

Product Specifications | Bases

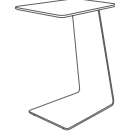

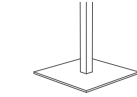

Dining and Multipurpose

FR	Flat Round
	<p>Standard Base Height: 28"</p> <p>Base: 18", 22" & 26" diameter cast iron with decorative steel cover plate</p> <p>Column: 3", 3.5" or 6" diameter, steel tubing</p> <p>Top Plate: 7.625", 10.75" or 15" square steel</p> <p>Standard Glide: Black octagon (GNO)</p> <p>Standard Finish: Powder coated</p> <p>Optional Finish: Plated</p>
KN	Knobhill
	<p>Standard Base Height: 28"</p> <p>Base: 18" or 24" diameter (L=light, M=medium, H=heavy, XH= extra heavy weight) cast iron with steel decorative cover plate</p> <p>Column: 2" or 2.25" diameter, steel tubing</p> <p>Top Plate: 7.625", 10.75" or 15" square steel</p> <p>Standard Glide: White nylon carpet glide (GNC)</p> <p>Standard Finish: Powder coated</p> <p>Optional Finish: Plated</p>
MH	Manhattan
	<p>Standard Base Height: 28"</p> <p>Base: 20", 24" or 30" diameter cast iron</p> <p>Column: 3", 3.5" or 4" diameter, steel tubing</p> <p>Top Plate: 7.625", 10.75" or 15" square steel</p> <p>Standard Glide: Black octagon (GNO)</p> <p>Standard Finish: Powder coated</p>
MA	Mark IV
	<p>Standard Base Height: 28"</p> <p>Base: 24", 30" & 36" X-base, 27" V-base and 18" & 30" T-base configurations, cast aluminum</p> <p>Column: 2", 2.5" or 3" diameter, aluminum tubing</p> <p>Top Plate: 7.625" or 15" square steel</p> <p>Standard Glide: Black nylon (GNY) on powder coated bases, nickel plated glide (GNP) standard on satin (MSA) and polished (MPA) aluminum bases</p> <p>Standard Finish: Powder coated</p> <p>Optional Finishes: Polished or satin aluminum</p>
ME	Medici
	<p>Standard Base Height: 28"</p> <p>Base: 18" cast iron X-base</p> <p>Column: Cast iron</p> <p>Top Plate: 7.625" square steel</p> <p>Standard Glide: White nylon carpet glide (GNC)</p> <p>Standard Finish: Powder coated</p>

MOV	Move
	<p>Overall Table Height: 25"</p> <p>Dimensions: 18" Depth, 13" Width, 15" Width</p> <p>Top: Laminate, wood veneer, 3form Chroma, Corian®</p> <p>Standard Glide: 2.25" Round Teflon Glide</p> <p>Standard Finish: Powder coated or clear coated hot rolled steel</p> <p>Optional Finish: Plated (polished not available)</p>
PA	Parsons
	<p>Overall Table Height: 29"</p> <p>Legs: 2.5" x 2.5" solid lumber</p> <p>Apron: 2.5" high</p> <p>Legs & Apron: Laminate or wood</p> <p>Top: Laminate or wood veneer</p> <p>Standard Glide: Nickel plated glide (GNP)</p>
PL	Platform
	<p>Standard Base Height: 28"</p> <p>Base: 18", 22" & 26" square .375" thick steel plate</p> <p>Column: 2" or 3" square steel tubing</p> <p>Top Plate: 7.625" or 15" square steel</p> <p>Standard Glide: White nylon carpet glide (GNC)</p> <p>Standard Finish: Powder coated</p> <p>Optional Finish: Plated</p>
PO	Post Leg
	<p>Standard Base Height: 28"</p> <p>Leg: 1.5", 2.5" or 3" diameter steel tubing</p> <p>Top Plate: 4.25" or 6" square steel</p> <p>Standard Glide: Nickel plated with white nylon bottom (GNN)</p> <p>Standard Finish: Powder coated</p> <p>Optional Finish: Plated</p>
PR	Presidio
	<p>Standard Base Height: 28"</p> <p>Base: 18", 24", 30" & 36" X-bases. 18", 24" & 30" T-base configurations with a single column. Double column T-bases are available 30" or 36" wide, .5" x 2.5" solid steel bar</p> <p>Column: 2.25" or 3" diameter, steel tubing</p> <p>Top Plate: 7.625", 10.75" or 15" square steel</p> <p>Standard Glide: Puck (PUC) glide finish to match base finish. Powder coat (PUCPC) and plated (PUCPL)</p> <p>Standard Finish: Powder coated</p> <p>Optional Finish: Plated</p>

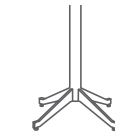
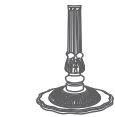
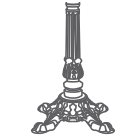
Product Specifications | Bases

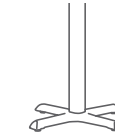
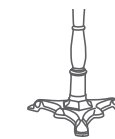
Dining and Multipurpose

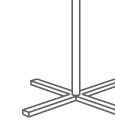
RG	Regency
	<p>Standard Base Height: 28"</p> <p>Base: 18", 24", 30" X-base configurations, .5" solid steel, tapering from 2.5" high to 1.25" high. 36" & 48" X-base configurations, 1" solid steel, tapering from 3" high to 1.25" high.</p> <p>21" x 42" & 24" x 48" scissor-base configurations, 1" solid steel, tapering from 3" high to 1.25" high.</p> <p>Column: 2.5" or 3.5" diameter steel tubing</p> <p>Top Plate: 7.625" or 15" square steel, 15" x 24" & 18" x 36" flat iron</p> <p>Standard Glide: Nickel plated glide (GNP)</p> <p>Standard Finish: Powder coated</p> <p>Optional Finish: Plated</p>
SC	Scala
	<p>Standard Base Height: 28"</p> <p>Base: 19.5" diameter cast iron</p> <p>Column: Cast iron</p> <p>Top Plate: 10.75" square steel</p> <p>Standard Glide: White nylon carpet glide (GNC)</p> <p>Standard Finish: Powder coated</p>
SI	Siena
	<p>Standard Base Height: 28"</p> <p>Base: 23.75" cast iron X-base</p> <p>Column: Cast iron</p> <p>Top Plate: 10.75" square steel</p> <p>Standard Glide: White nylon carpet glide (GNC)</p> <p>Standard Finish: Powder coated</p>
SL	Slimline
	<p>Standard Base Height: 28"</p> <p>Base: 18", 24", 30" & 36" X-bases. 18", 24" & 30" T-base configurations with a single column. Double column T-bases are available 30" or 36" wide. 1.75" diameter steel tubing</p> <p>Column: 1.75" & 3.5" diameter, steel tubing</p> <p>Top Plate: 7.625", 10.75" or 15" square steel</p> <p>Standard Glide: Nickel plated with white nylon bottom (GNN)</p> <p>Standard Finish: Powder coated</p> <p>Optional Finish: Plated</p>
SV	Spacesaver
	<p>Standard Base Height: 28"</p> <p>Base: 22", 30" & 36" X-base, 24" x 30" spider base and 18" & 22" T-base configurations, cast iron</p> <p>Column: 3" diameter, steel tubing</p> <p>Top Plate: 7.625" or 15" square steel</p> <p>Glide: Nylon glide (GSV)</p> <p>Standard Finish: Cast iron in black wrinkle (MWR)</p> <p>Optional Finish: Powder coated</p>
TO	Toscana
	<p>Standard Base Height: 28"</p> <p>Base: 23.75" cast iron 3-prong</p> <p>Column: Cast iron</p> <p>Top Plate: 7.625" square steel</p> <p>Standard Glide: White nylon carpet glide (GNC)</p> <p>Standard Finish: Powder coated</p>
TL	Tulip
	<p>Standard Base Height: 28"</p> <p>Base: 18" or 24" diameter (L=light, M=medium, H=heavy, XH= extra heavy weight) cast iron with decorative steel cover plate.</p> <p>Column: 2" or 2.25" diameter, steel tubing</p> <p>Top Plate: 7.625", 10.75" or 15" square steel</p> <p>Standard Glide: White nylon carpet glide (GNC)</p> <p>Standard Finish: Powder coated</p> <p>Optional Finish: Plated</p>
TU	Tuscan
	<p>Standard Base Height: 28"</p> <p>Base: 18", 24", 30" & 36" X-bases. 18", 24" & 30" T-base configurations with a single column. Double column T-bases are available 30" or 36" wide. 1" x 2" steel rectangle tubing</p> <p>Column: 2" or 3" diameter, steel tubing</p> <p>Top Plate: 7.625", 10.75" or 15" square steel</p> <p>Standard Glide: Black octagon (GNO)</p> <p>Standard Finish: Powder coated</p> <p>Optional Finish: Plated</p>

Product Specifications | Occasional Bases and Tables

Occasional Tables

CU Cube

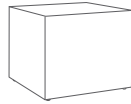

Overall Table Heights: 16", 18", 20" & 24"
Material: Laminate or wood construction
Standard Glide: Nickel plated glide (GNP)

CY Cylinder



Overall Table Heights: 16", 18", 20" & 24"
Material: Laminate or wood construction
Standard Glide: Nickel plated glide (GNP)

DI Disc

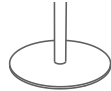

Occasional Base Heights: 16", 18" or 20"
Base: 18" & 22" diameter .375" thick steel plate
Column: 2" diameter, steel tubing
Top Plate: 7.625" square steel
Standard Glide: White nylon carpet glide (GNC)
Standard Finish: Powder coated
Optional Finish: Plated

MOV Move



Overall Table Height: 25"
Dimensions: 18" Depth, 13" Width, 15" Width
Top: Laminate, wood veneer, 3form Chroma, Corian®
Standard Glide: 2.25" Round Teflon Glide
Standard Finish: Powder coated or clear coated hot rolled steel
Optional Finish: Plated (polished not available)

PA Parsons



Overall Occasional Table Heights: 16", 18", 20", 24"
Legs: 2.5" x 2.5" solid lumber
Apron: 2.5" high
Material: Laminate or wood construction
Standard Glide: Nickel plated glide (GNP)

PL Platform

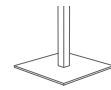

Occasional Base Heights: 16", 18" or 20"
Base: 18" & 22" square .375" thick steel plate
Column: 2" square steel tubing
Top Plate: 7.625" square steel
Standard Glide: White nylon carpet glide (GNC)
Standard Finish: Powder coated
Optional Finish: Plated

TL Tulip



Occasional Base Heights: 16", 18" or 20"
Base: 18" or 24" diameter (L=light, M=medium, H=heavy weight) cast iron with decorative steel cover plate.
Column: 2" or 2.25" diameter, steel tubing
Top Plate: 7.625" or 10.75" square steel
Standard Glide: White nylon carpet glide (GNC)
Standard Finish: Powder coated
Optional Finish: Plated

Product Specifications | Outdoor Bases and Tables

Outdoor Tables

ARC Arc



Overall Table Height: 29.25"
Base: 4 leg steel base
Column: 1.5" square steel tubing
Top Plate: Tilt-top mechanism
Top: Solid metal (MES)
Standard Glide: Adjustable nylon glide
Standard Finish: Powder coated silver (MSL)
 Some assembly required

BA Basic Round



Standard Base Height: 28"
Base: 14", 17", 20", 22" & 28" diameter cast iron, also available with decorative steel cover plate for powder coating (L=light, M=medium, H=heavy weight)
Column: 3", 3.5" or 6" diameter, steel tubing
Top Plate: 7.625" or 15" square steel
Standard Glide: Superlevel glide (GSL)
Standard Finish: Cast iron in black wrinkle (MWR)
Optional Finish: Powder coated

BI Bistro



Overall Table Height: 28.75"
Base: 4 leg steel base
Top: Solid (MES) or mesh (MEM) metal top
Standard Glide: Fixed nylon glide
Standard Finish: Powder coated

DI Disc



Standard Base Height: 28"
Base: 18", 22" & 26" diameter .375" thick steel plate
Column: 2" or 3" diameter, steel tubing
Top Plate: 7.625" or 15" square steel
Standard Glide: Black octagon (GNO)
Standard Finish: Powder coated

FR Flat Round

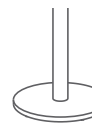

Standard Base Height: 28"
Base: 18", 22" & 26" diameter cast iron with decorative aluminum cover plate
Column: 3" or 6" diameter, aluminum tubing
Top Plate: 7.625", 10.75" or 15" square steel
Standard Glide: Superlevel glide (GSL)
Standard Finish: Powder coated
Optional Finish: Anodized Aluminum

MA Mark IV



Standard Base Height: 28"
Base: 24", 30" & 36" X-base, 27" V-base and 18" & 30" T-base configurations, cast aluminum
Column: 2" or 3" diameter, aluminum tubing
Top Plate: 7.625" or 15" square steel
Standard Glide: Superlevel glide (GSL)
Standard Finish: Powder coated
Optional Finish: Anodized Aluminum

PK Park



Overall Table Height: 29"
Base: 4 leg steel base
Top: Mesh (MEM) metal top
Standard Glide: Fixed nylon glide
Standard Finish: Powder coated silver (MSL)
 Includes 1.5625" umbrella hole

PL Platform

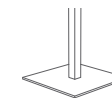

Standard Base Height: 28"
Base: 18", 22" & 26" square .375" thick steel plate
Column: 2" or 3" square steel tubing
Top Plate: 7.625" or 15" square steel
Standard Glide: Black octagon (GNO)
Standard Finish: Powder coated

SM Sam Table



Overall Table Height: 29.125" & 42"
Base: Clear coated polished aluminum X- base
Column: 2.5" diameter aluminum tubing
Top: Stainless steel with scalloped pattern (MSS)
Standard Glide: Adjustable nylon glide
Standard Finish: Stainless steel with scalloped pattern top with a clear coated polished aluminum base
 Some assembly required

TL Tulip





Standard Base Height: 28"
Base: 18" or 24" diameter (L=light, M=medium, H=heavy, XH= extra heavy weight) cast iron with decorative steel cover plate
Column: 2" or 2.25" diameter, steel tubing
Top Plate: 7.625", 10.75" or 15" square steel
Standard Glide: Superlevel glide (GSL)
Standard Finish: Powder coated

Outdoor Chairs

BZCA	Breeze
	<p>Arm Chair</p> <p>Stacks: 6 high</p> <p>Width: 20.5"</p> <p>Depth: 24"</p> <p>Height: 32.25"</p> <p>Weight: 12.5 lb.</p> <p>Standard Finish: Powder coated silver (MSL)</p>

PLCS	Polly
	<p>Side Chair</p> <p>Stacks: 6 high</p> <p>Width: 21.5"</p> <p>Depth: 25.5"</p> <p>Height: 32.5"</p> <p>Weight: 8 lb.</p> <p>Standard Finish: Polypropylene white (PWH)</p>

CYCA	Courtyard
	<p>Arm Chair</p> <p>Stacks: 6 high</p> <p>Width: 20.5"</p> <p>Depth: 20.5"</p> <p>Height: 33"</p> <p>Weight: 15 lb.</p> <p>Standard Finish: Powder coated silver (MSL)</p>

SMCS	Sam
	<p>Side Chair</p> <p>Stacks: 8 high</p> <p>Width: 17.5"</p> <p>Depth: 21.5"</p> <p>Height: 30.5"</p> <p>Weight: 9 lb.</p> <p>Standard Finish: Clear coated polished aluminum (MPA) only</p>

PZCA	Piazza
	<p>Arm Chair</p> <p>Stacks: 8 high</p> <p>Width: 22"</p> <p>Depth: 25"</p> <p>Height: 29.5"</p> <p>Weight: 9 lb.</p> <p>Standard Finish: Clear coated polished aluminum frame with black (RBK) or honey (RHN) synthetic rattan woven seats and backs</p>

SMCA	Sam
	<p>Arm Chair</p> <p>Stacks: 8 high</p> <p>Width: 21.5"</p> <p>Depth: 25.5"</p> <p>Height: 32.5"</p> <p>Weight: 9 lb.</p> <p>Standard Finish: Clear coated polished aluminum (MPA) only</p>

PZCB	Piazza
	<p>Bar Arm Chair</p> <p>Width: 21"</p> <p>Depth: 22"</p> <p>Seat Height: 30"</p> <p>Overall Chair Height: 39"</p> <p>Weight: 10 lb.</p> <p>Standard Finish: Clear coated polished aluminum frame with black (RBK) or honey (RHN) synthetic rattan woven seats and backs</p>

SMCB	Sam
	<p>Bar Arm Chair</p> <p>Width: 21"</p> <p>Depth: 22"</p> <p>Seat Height: 30"</p> <p>Overall Chair Height: 39"</p> <p>Weight: 10 lb.</p> <p>Standard Finish: Clear coated polished aluminum (MPA) only</p>

PCCA	Picnic
	<p>Arm Chair</p> <p>Stacks: 6 high</p> <p>Width: 22"</p> <p>Depth: 21"</p> <p>Height: 31"</p> <p>Weight: 11.5 lb.</p> <p>Standard Finish: Powder coated silver (MSL)</p>

Laminate Top Construction

Standard 1.25" thick core material, consisting of a NAUF Particle Board (45.5 lb/ft3), MDF (46 lb/ft3), or 1" thick Birch Plywood (40 lb/ft3) core, surfaced with a laminate face. The core material is determined by the specified edge profile. A moisture-resistant backing sheet is laminated to the underside of the top. All complete tables (consisting of a top and base) have steel threaded inserts for metal-to-metal mounting of the top to the base, allowing ease of installation. Tops sold separately do not have steel threaded inserts. Table tops over 96" in length have steel support to prevent bowing. All top dimensions are nominal and may vary up to 0.75," depending on the edge treatment. If a critical size is required (± 0.0625 "), dimensions should be specified in writing.

Wood Veneer Top Construction

Standard 1.25" thick core material, consisting of a NAUF Particle Board (45.5 lb/ft3), MDF (46 lb/ft3), or Birch Plywood (40 lb/ft3) core, surfaced with a book matched veneer face. A moisture-resistant backing sheet is laminated to the underside of the top. All complete tables (consisting of a top and base) have steel threaded inserts for metal-to-metal mounting of the top to the base, allowing ease of installation. Tops sold separately do not have steel threaded inserts. Table tops over 96" in length have steel support to prevent bowing. All top dimensions are nominal and may vary up to 0.75," depending on the edge treatment. If a critical size is required (± 0.0625 "), dimensions should be specified in writing.

Butcher Block Top Construction

Butcher Block Tops have an eased edge with 1.3125" wide finger jointed strips. Tops are 1.375 thick and 1.875" thick on 60" and 72" tops. Tops are constructed from solid maple and have 0.75" tolerance.

Laminate Surfaces

See Laminate Reference Guide, Page 30.

Wood Surface Finish

All wood products are finished in semi-gloss, acrylic waterborne enamel providing a 40% sheen finish using a multi-step process of hand sanding, staining, and sealing that provides superior water and alcohol resistance. Custom sheens are available upon request; please contact WCI Customer Service for a quote.

Ultrafoam Surfaces

Standard 1" thick balanced construction consisting of NAUF – Particle Board (45.5 lb/ft3) core surfaced with a permanently bonded fire-retardant, expanded polyvinyl chloride pad. Ultrafoam tops are available with white vinyl T-mold or raw edges, and are recommended for use with tablecloth only. Ultrafoam tops create a slightly cushioned surface that is impervious to grease, foods, acids, and alcohol. Ultrafoam tops absorb sound and eliminate the need for silencer cloth, double linen or other padding. All complete tables (tables consisting of a top and base) have steel threaded inserts for metal-to-metal mounting of the top to the base, allowing ease of installation. Tops sold separately do not have steel threaded inserts. Table tops over 96" in length have steel support to prevent bowing. All top dimensions are nominal and may vary up to 0.75" depending on the edge treatment. If a critical size is required (± 0.0625 "), dimensions should be specified in writing.

3Form® Chroma® Surfaces

Standard 1" ($\pm 10\%$) thick with 0.75" moisture resistant marine grade plywood sub-top for indoor and outdoor use. 3form® Chroma® (74.3 lb/ft3) is produced from optical grade engineered resin with high UV resistance consisting of 30% recycled, 12% pre-consumer, and 18% post-consumer content, and is certified according to the GREENGAURD® Indoor Air Quality Certification Program for Low Emitting Products. The surface of Chroma® features renewable matte texture that can be easily refinished throughout its lifetime. All top dimensions are nominal and may vary up to 0.75" depending on the edge treatment. If a critical size is required (± 0.0625 "), dimensions should be specified in writing.

Product Specifications | Tops

Acrylic Surfaces

Standard 1.25" thick with moisture resistant marine grade plywood sub-top. Specially formulated acrylic provides a tough, nonporous surface material with superior stain and UV resistance. Color and material is consistent throughout the top, providing a renewable surface. Acrylic surfaces are not predrilled to accept table bases. All top dimensions are nominal and may vary up to 0.75" depending on the edge treatment. If a critical size is required (± 0.0625 "), dimensions must be specified in writing.

Corian® Surfaces

Standard 1"x1" thick built-up edge on 0.5" thick Corian® (106.1 lb/ft³) with a steel sub-frame and a 0.75" X 1.5" steel tube finished with standard matte black powder coat. Corian® is a solid surface material from DuPont composed of 33% of Poly Methyl Methacrylate and 67% of Natural Minerals like Alumina Trihydrate. Corian®, along with its adhesives and sealants, are certified by GREENGUARD®, providing a complete surfacing system with low amounts of VOC (volatile organic compounds). All complete tables (tables consisting of a top and base) will have steel threaded inserts for metal-to-metal mounting of the top to the base, allowing ease of installation. Steel sub-frames are designed to fit only WCI's standard bases, and, consequently, all top only requests must be processed as a custom product. All top dimensions are nominal and may vary up to 0.75" depending on the edge treatment. If a critical size is required (± 0.0625 "), dimensions must be specified in writing.

Vinyl T-Mold Edges

Vinyl edges provide an impact-resistant edge. All vinyl T-molding corners have a 2" radius.

PVC Edges

PVC edges provide an impact-resistant edge. All PVC corners are square.

Metal Edges

Metal edges are extruded 6063 Aluminum, allowing for strength and durability. Standard finishes are polished and satin aluminum. All metal edges have a 2" radius.

Wood Edges

Wood edges are offered in solid maple, oak, cherry, and walnut. Other wood species are available upon request; please contact WCI Customer Service for a quote.

Overall Table Heights

Overall table heights vary according to top specification. WCI standard base height is 28". Add top thickness to determine overall table height. For alternate height (AH) tables, the height specification refers to the overall height of the table when ordering a complete table, or the overall height of the base when ordering base only.

Product Specifications | Edge Profiles

Self Edge

LLSE	Self Laminate Edge
	1.25" thick edge is banded with matching standard grade top plastic laminate. Square and rectangle tops standard with square corners Available on 1.25" thick top

LLSE3	Self Laminate Edge
	1.75" thick edge is banded with matching standard grade top plastic laminate Square and rectangle tops standard with square corners Available on 1.25" thick top

Vinyl Edges

LVFL	Flat Vinyl T-Mold Edge
	.125" x 1.25" flat vinyl edge Square and rectangle tops standard with 2" radius corners Available on 1.25" thick top Available in 6 colors

LVBP	Bumper Vinyl T-Mold Edge
	.1875" x 1.25" rounded vinyl bumper edge Square and rectangle tops standard with 2" radius corners Available on 1.25" thick top Available in 6 colors

PVC Edge

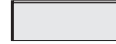
LPVC	Flat PVC Edge
	.125" x 1.25" flat pvc edge Square and rectangle tops standard with square corners Available on 1.25" thick top Available in 6 colors

Metal Edges

LMFL	Flat Metal T-Mold Edge
	.125" x 1.25" flat aluminum edge Square and rectangle tops standard with 2" radius corners Available on 1.25" thick top Available in polished (MPA) or satin (MSA) finishes

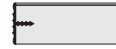
LMRB	Ribbed Metal T-Mold Edge
	.125" x 1.25" ribbed aluminum edge Square and rectangle tops standard with 2" radius corners Available on 1.25" thick top Available in polished (MPR) or satin (MSR) finishes

Product Specifications | Edge Profiles

Wood Edges Group A

LW = Laminate top with a wood edge
WW = Wood top with a wood edge

LWFL & WWFL	Flat Wood Edge
	.125" thick flat wood edge, eased corners Square and rectangle tops standard with square corners Available on 1.25" thick top Available in 4 wood species and 13 stains

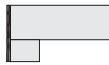
LWFL3 & WWFL3	Flat 3 Edge
	.125" x 1.75" thick flat wood edge Square and rectangle tops standard with square corners Available on 1.25" thick top Available in 4 wood species and 13 stains

LWPI & WWPI	Pivot Wood Edge
	.25" x 1.25" pivot wood edge Square and rectangle tops standard with square corners Available on 1.25" thick top Available in 4 wood species and 13 stains

LWTP & WWTP	Tapered Ply Edge
	1" thick exposed Baltic Birch plywood edge with a reverse beveled tapered profile Square and rectangle tops standard with square corners Available on 1" thick top Top surface available in 4 wood species and 13 stains

LWFP & WWFP	Flat Ply Edge
	1" thick exposed Baltic Birch plywood edge with a flat profile Square and rectangle tops standard with square corners Available on 1" thick top Top surface available in 4 wood species and 13 stains

Wood Edges Group B

LW = Laminate top with a wood edge
WW = Wood top with a wood edge

LWSQ & WWSQ	Square Wood Edge
	1.25" x 1.25" flat square wood edge Square and rectangle tops standard with square corners Available on 1.25" thick top Available in 4 wood species and 13 stains

LWSQ3 & WWSQ3	Square 3 Wood Edge
	1.75" x 1.75" thick square wood edge Square and rectangle tops standard with square corners Available on 1.25" thick top Available in 4 wood species and 13 stains

LWAR & WWAR	Arc Wood Edge
	.75" x 1.25" arc wood edge Square and rectangle tops standard with square corners Available on 1.25" thick top Available in 4 wood species and 13 stains

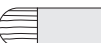
LWBN & WWBN	Bullnose Wood Edge
	1.25" x 1.25" bullnose wood edge Square and rectangle tops standard with square corners Available on 1.25" thick top Available in 4 wood species and 13 stains

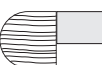
LWBN3 & WWBN3	Bullnose 3 Wood Edge
	1.75" x 1.75" thick bullnose wood edge Square and rectangle tops standard with square corners Available on 1.25" thick top Available in 4 wood species and 13 stains

LWPR & WWPR	Prism Wood Edge
	1.25" x 1.25" prism wood edge Square and rectangle tops standard with square corners Available on 1.25" thick top Available in 4 wood species and 13 stains

Product Specifications | Edge Profiles

Butcher Block Edges

BBFL	Butcher Block Flat Edge
	1.3125" finger jointed strips x 1.375" thick, 1.875" thick on 60" diameter tops only Square and rectangle tops standard with square corners Available on 1.375" thick top Available in maple and 4 stains

BBBN	Butcher Block Bullnose Edge
	1.3125" finger jointed strips x 1.375" thick, 1.875" thick on 60" diameter tops only Square and rectangle tops standard with .5" radius corners Available on 1.375" thick top Available in maple and 4 stains

Ultrafoam Edges

ULFP	Ultrafoam PVC Edge
	.039" x 1" flat PVC edge Square and rectangle tops standard with square corners Available on 1" thick top

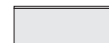
ULFR	Ultrafoam Raw Edge
	1" ultrafoam top with raw edge Square and rectangle tops standard with square corners Available on 1" thick top

Acrylic Edge

AAOP & AATL	Acrylic Opaque / Acrylic Translucent Tops With Waterfall Edges
	1.25" acrylic top with waterfall edge Square and rectangle tops standard with 3" radius corners

Corian® Edges

C1FL & C2FL	Corian® Flat Edge
	.5" thick Corian® material with 1" thick edge Square and rectangle tops standard with .125" radius corners

C1BN & C2BN	Corian® Bullnose Edge
	.5" thick Corian® material with 1" thick edge Square and rectangle tops standard with .5" radius corners

C1PR & C2PR	Corian® Prism Edge
	.5" thick Corian® material with 1" thick edge Square and rectangle tops standard with square corners

3form Chroma Edges

3FFL	3form® Chroma® Flat Edge
	1" thick Chroma material Square and rectangle tops standard with .125" radius corners Available in 10 Chroma colors

3FBN	3form® Chroma® Bullnose Edge
	1" thick Chroma material Square and rectangle tops standard with .5" radius corners Available in 10 Chroma colors

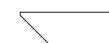
3FPR	3form® Chroma® Prism Edge
	1" thick Chroma material Square and rectangle tops standard with square corners Available in 10 Chroma colors

3FRB	3form® Chroma® Reverse Bevel Edge (Outdoor Only)
	1" thick Chroma material Square and rectangle tops standard with square corners Available in 10 Chroma colors

Move Edge (Move Table Only)

LMOV	Ply Move Edge
	.5" thick exposed Baltic Birch plywood edge Standard with .63" radius corners

WMOV	Veneer Move Edge
	.5" thick wood edge Standard with .63" radius corners Available in 4 wood species and 13 stains

CMOV	Corian® Move Edge
	.5" thick Corian® material Standard with .63" radius corners

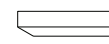
3MOV	3form® Chroma® Move Edge
	.5" thick 3form Chroma material Standard with .63" radius corners Available in 10 Chroma colors

Product Specifications | Laminate Reference Guide

WCI offers over 800 standard laminates from Nevamar, Formica, Wilsonart, and Pionite. Laminates from other manufacturers and non-standard laminates are available, and require special pricing from WCI's Customer Service Department. Please contact WCI Customer Service at **800-243-3150** for all special laminate requests.

Please note: Laminate manufacturers change their product offerings frequently and sometimes without advanced notification. For this reason, a standard laminate may not be available. Please contact the laminate manufacturers for current offerings.

Note: Other laminate manufacturers are available, such as Arborite® , Laminart® , and Abet Laminati® .

Wilsonart®	Identifying Code
Standard Finishes	
Matte	60
Fine Velvet Texture	38
Standard Selections	
Solids	
Woodgrains	
Non-standard Selections (require quote)	
Solids-Gloss/Filmed	
Decorative Metals	
Non-standard Finishes (require quote)	
Gloss	01
Textured Gloss	07
Linearity	18
High Wear	HW
Quarry	52
Fine Grain	78
Soft Grain	12
Premium High Definition	35/45/55
Chalk Board	137
Chemsurf® Chemical-Resistant	390
Fire Rated	604, 605, 607
Marker Board	136/336

Pionite	Identifying Code
Standard Finishes	
Suede	N

Pionite	Identifying Code
Standard Selections	
Solids	
Patterns	
Stones	
Woodgrains	
Non-standard Finishes (require quote)	
Ashwood	Z
Hi_Brite	H
Soft Leather	C
Embossed Leather	L
Slate	W
Granite	R
Stone X	V
Super Matte	F

Nevamar	Identifying Code
Standard Finishes	
Textured	T
Standard Selections	
Solids	
Patterns	
Stones	
Woodgrains	
Patterns	
Non-standard Finishes (require quote)	
Crystal	CR
Chemarmor	CA
Polished Velvet	PV
Super Matte	SM

Formica®	Identifying Code
Standard Finishes	
Matte	58
Microdot	MC
Non-standard Selections (require quote)	
Color Core 2	C
Non-standard Finishes (require quote)	
Artisan	43
Crystal	42
Etchings	46
Honed	77
Naturelle (vertical use only)	NT
Radiance	RD
Sculpted (vertical use only)	SP

Product Specifications | Laminate Reference Guide

WCI materials have been carefully matched to the closest industry standards available in laminates. Color match accuracy varies with material and available colors. Please request WCI sample(s) for true colors.

WCI Color Match Recommendations

Material	Color	WCI Code	Manufacturer	Reference Number & Color	
Vinyl Edges (including PVC)	White	VWH	Wilsonart	D354-60 Designer White	
	Light Gray	VLG	Nevamar	S6003T Dove Gray	
	Medium Gray	VMG	Wilsonart	D92-60 Dove Gray	
	Dark Gray	VDG	Nevamar	S6054T Wrought Iron	
	Black	VBK	Formica	909-58 Black Matte	
	Dark Tone	VDT	Wilsonart	D91-60 Slate Gray	
Wood Veneer Tops and Solid Wood Edges	Maple	Natural Maple	WNM	Wilsonart	7911-60 Manitoba Maple
		Honey Maple	WGM	Wilsonart	7925-38 Monticello Maple
		Ebony Maple	WHM	Wilsonart	7944K-01 Madagascar
	Oak	Natural Oak	WNO	Formica	8844WR Aged Ash
		Medium Oak	WMO	Nevamar	WM8110T Golden Ash
		Ebony Oak	WEO	Wilsonart	7944K-01 Madagascar
	Cherry	Natural Cherry	WNC	Wilsonart	7925-38 Monticello Maple
		Medium Cherry	WMC	Wilsonart	7919-78 Amber Cherry
		Ebony Cherry	WEC	Wilsonart	1595-60 Black
		Mahogany Over Cherry	WMA	Wilsonart	7122K-07 Empire Mahogany
Walnut	Natural Walnut	WNW	Wilsonart	7110K-78 Montana Walnut	
	Medium Walnut	WMW	Wilsonart	W313A-60 Gunstock Walnut	
	Dark Walnut	WDW	Pionite	HP359-H Thunderstorm	

Product Specifications | Corian® Reference Guide

Corian® is a solid surface material created by DuPont, composed of acrylic polymer and alumina trihydrate. Corian®, along with its adhesives and sealants, are certified by the GREENGUARD® Environmental Institute, providing a complete surfacing system with low-VOC.

Corian® tops are not sold separately as a standard product. All top only requests must be processed as a custom product. The under structure of indoor and outdoor Corian® tops consists of a steel sub-frame with a .75" x 1.5" steel tube finished with standard black matte powder coating. Sizes vary, depending on top size. Steel sub-frames are equipped with steel-threaded inserts to allow for metal to metal mounting of the top to the base. Steel sub-frames are designed to fit only WCI's standard bases.

All top dimensions are nominal and may vary up to .75" depending on the edge treatment. If a critical size is required (+/- .0625), dimensions must be specified in writing.

Due to random veining, material transparency, directional metallic flakes, and unique colors, seams and glue lines may be visible on tops larger than 30"W x 72"L in certain series of Corian® solid surface materials. Please refer to the lists below for colors that may present fabrication issues.

Private Collection Series

Seams may be visible at joints due to random veining patterns

Allspice	Hazelnut	Sagebrush
Arrowroot	Hickory Smoke	Sandalwood
Basil	Jasmine	Sonora
Burled Beach	Juniper	Sorrel
Cinnabar	Lava Rock	Thyme
Clam Shell	Natural Gray	Tumbleweed
Earth	Raincloud	Vanero White
Ecru	Rosemary	Verde
Elderberry	Saffron	Witch Hazel

Illumination Series

Seams will be visible when backlit, may be slightly visible when not backlit

Arctic Ice	Blueberry Ice	Lime Ice
Arctic Mint	Glacier Ice	Mint Ice

Metallic Series

Due to directional metallic flakes in each sheet seams will be visible

Anthracite	Copperite	Olivite
Aqualite	Graylite	Silverite
Azurite		

Difficult Colors to Seam

Glue line at joint may be visible

Graphic Blue	Night Sky	Sand
Nocturne	Sun	

Product Specifications | Wood Grain and Patterns

WCI wood veneer is bookmatched as standard.

For custom veneer patterns contact customer service at 415-261-6656 for quotation.

WCI Standard

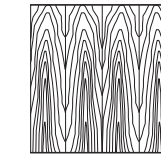

Bookmatched

Custom Patterns

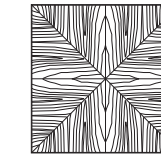

Reverse diamond

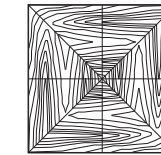

Box diamond

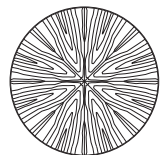

Sunburst

Long grain is standard on all WCI tables.

All tables larger than 10' will be made in two or more sections depending on total length.

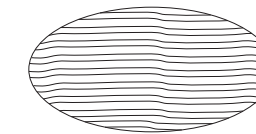

Long grain is standard on all WCI oval table tops

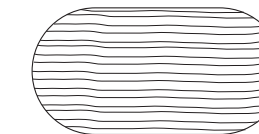

Long grain is standard on all WCI racetrack tables.

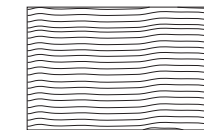

Long grain is standard on all WCI rectangle tables.

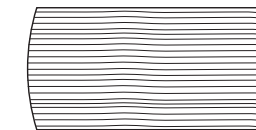

Long grain is standard on all WCI arc rectangle tables.

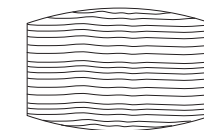

Long grain is standard on all WCI boat-shaped tables.

Product Specifications | Grommet Locations

Specify the desired grommet location using the chart below.
For custom locations please submit a sketch for location feasibility and verification.

Grommet Locations For Radius Tops.

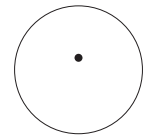

Location "A"

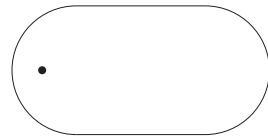

Location "B"

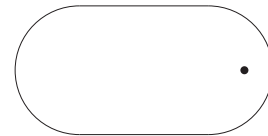

Location "C"



Location "D"

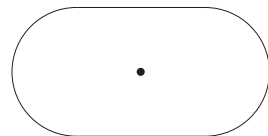

Location "E"

Grommet Locations For Square Corner Tops.

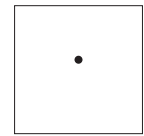

Location "A"

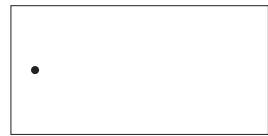

Location "B"



Location "C"

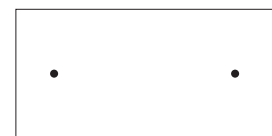

Location "D"

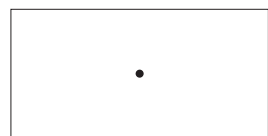

Location "E"

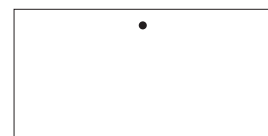

Location "F"

*For custom grommet locations, please submit a drawing with dimensions for placement.

Product Specifications | ADA Tables

Wheelchair Access

To comply with ADA regulations for wheelchair access to tables WCI recommends a minimum clearance of 27" from the floor to the bottom of the table; a minimum 30" barrier free width and a minimum barrier free depth of 19".

In addition there must be a minimum of 30" unobstructed space from the table edge. Overall table height cannot exceed 34".

For more information on ADA requirements, the following websites may be useful:

National Network of ADA Centers: www.adata.org

U.S. Justice Department - ADA Home Page: www.ada.gov

ABA and ABA Guidelines Home Page: www.access-board.gov/ada-aba

Minimum Clearance Recommendations

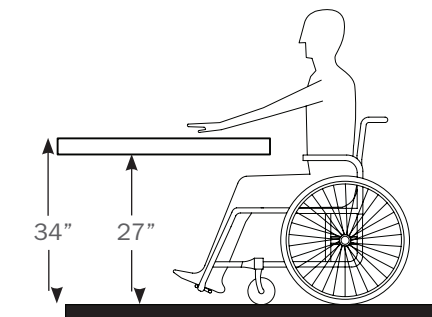
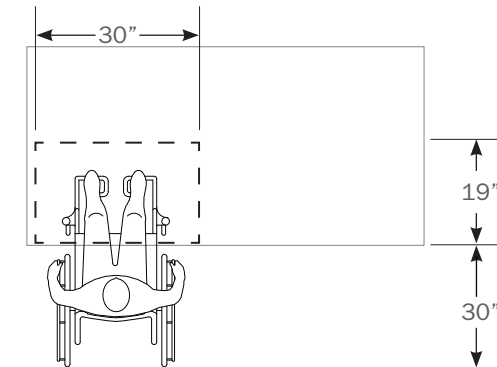

WCI ADA Table Recommendations

42" x 42" Post leg square table (P04242SQ)

23" x 39" Bistro ADA rectangle table (BI2339RE0D)

30" x 48" T-base rectangle table (DUT3048RE, ALT3048RE, MAT3048RE, PRT3048RE, SLT3048RE, SVT3048RE, TUT3048RE)

ADA Logo

The ADA logo is standard on the Bistro Outdoor rectangle table. The blue ADA symbol is 1.75" high x 5" wide and is inset from the front table edge on the right-hand side (from seated position).

Drawing is not to scale.

Please offer this table
to our customers
with disabilities



Product Specifications | Banquettes

- Coil-spring construction provides no hard edges and uniform support for comfort and durability.
 - Removable seat allows ease of re-upholstery.
 - Back pitch and seat depth can be specified to meet specific applications and price points.
 - Multi-functional banquettes can be designed for both Hospitality and Contract environments.
 - Foams used in fabrication are flame retardant and pass: CAL 117 and TB-133.
 - LEED compliant materials available upon request.
 - Shop drawings are submitted by WCI design/engineering staff for final approval before fabrication commences.
- **Back Support:** 2.5" polyfoam over .125" plywood backing
 - **Seat:** Removable with 2" polyfoam with bonded Dacron
 - Insulpad and coil springs
 - **Seat Platform:** .75" CDX exterior grade plywood
 - **Booth Platform:** .75" CDX exterior grade plywood
 - **Other services are available at a minimal charge including:** field dimensioning (including templates when necessary), delivery and installation.

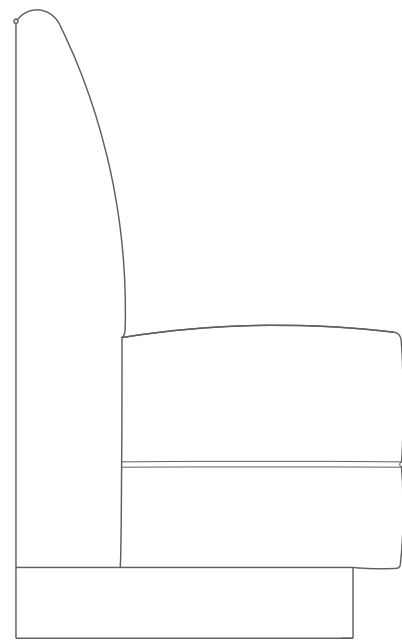
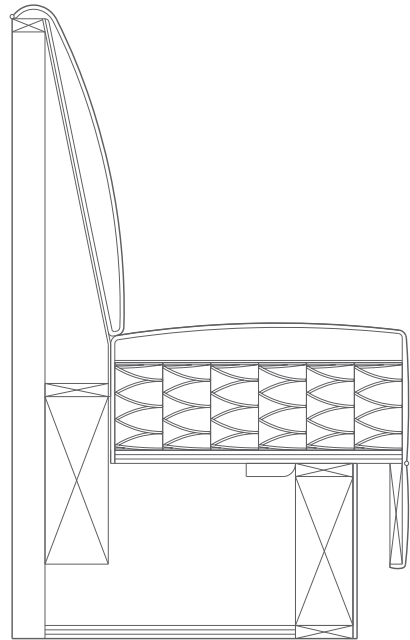

Product Specifications | Banquettes

Standard Configurations



Single

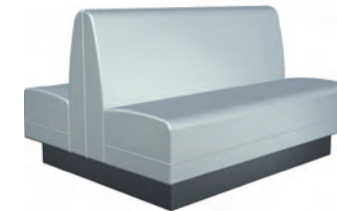

Double

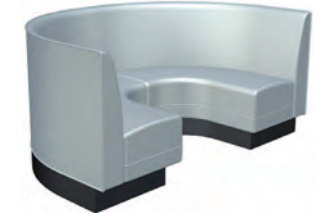

U - Shaped

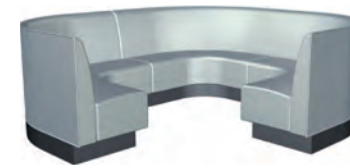

3/4 Circle

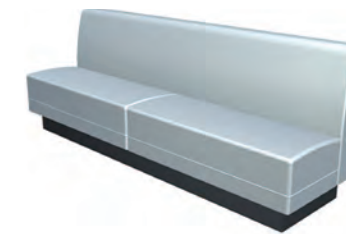

Straight



L - Shaped

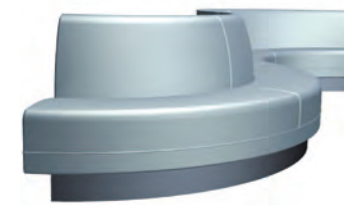

Custom Curved

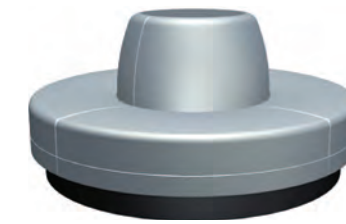

Rotunda

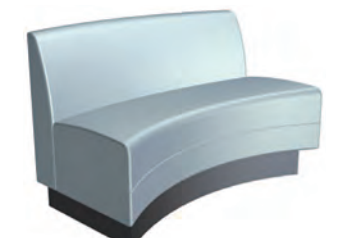

Ellipse

Custom shapes are available upon request.

Images shown are representations of standard WCI banquette configurations



Inside Back Styles

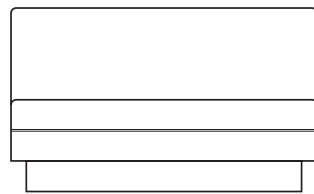

Plain upholstered (standard)

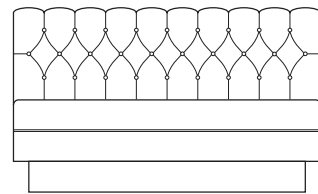

Diamond tufted

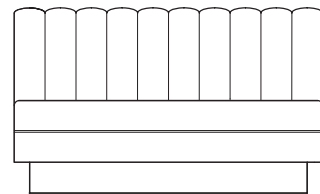

3" – 6" wide vertical channels

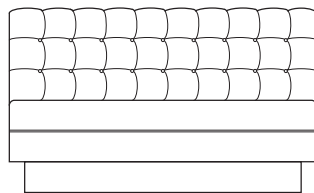

Biscuit tufted

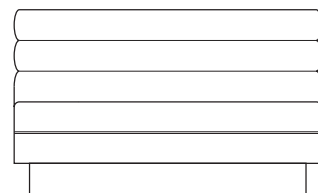

6" wide horizontal channels

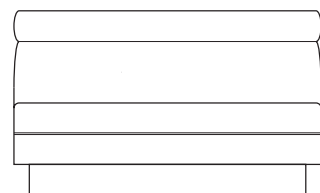

Plain back with 4" – 6" wide headroll

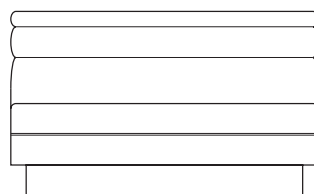

Graduating width horizontal channels

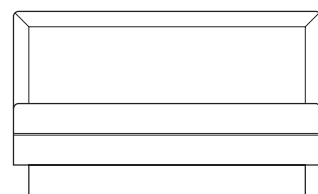

Plain back with 3" wide picture frame headroll

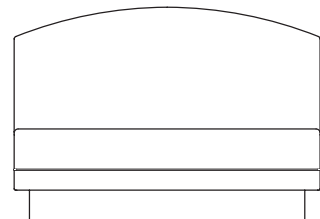

High rise curved back



End Panel Styles

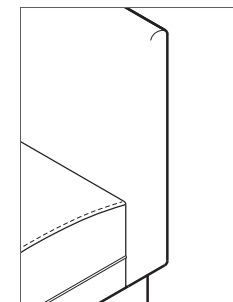

Wrap-around upholstered (standard)

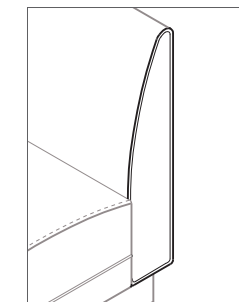

Self upholstered with welt all around

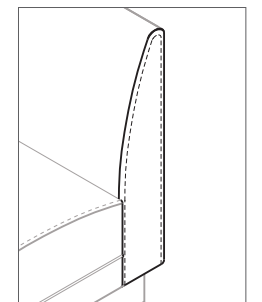

Self upholstered with french stitch

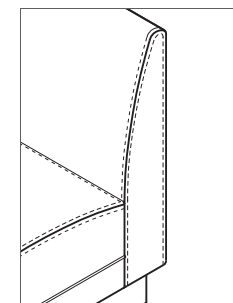

Self upholstered with baseball stitch

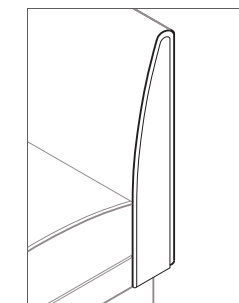

Applied upholstered end panel with welt all around

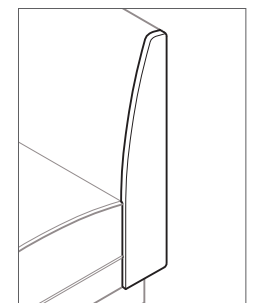

Applied .75" self edge plastic laminate or wood veneer end panel



Seat Styles

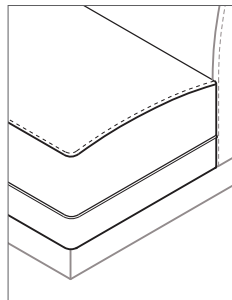

Plain upholstered with french stitch on all seat top edges (standard)

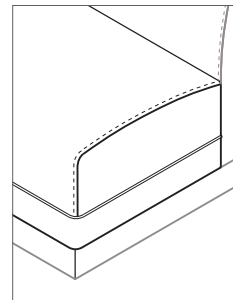

Waterfall upholstered front and back edges with french stitch on ends

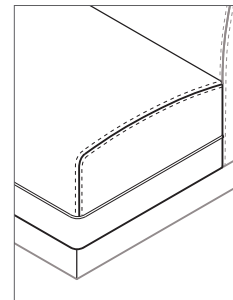

Waterfall upholstered front and back edges with baseball stitch on ends

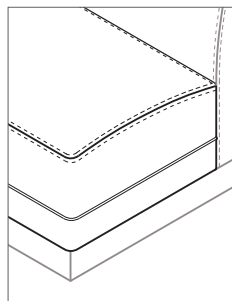

Plain upholstered with baseball stitch on all seat top edges

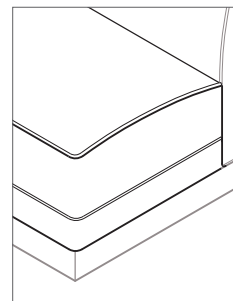

Plain upholstered with welt on all seat top edges

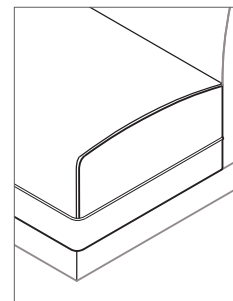

Waterfall upholstered front and back edges with welt on ends



Seat Apron Styles

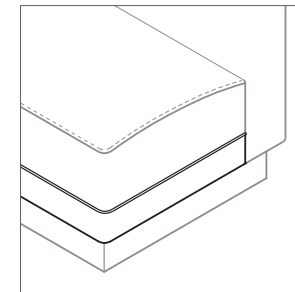

Flush seat apron (standard)

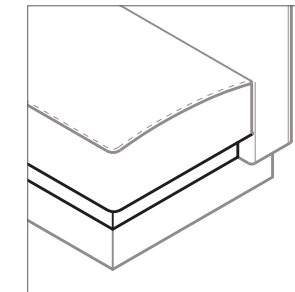

Recessed seat apron



Kickbase and Leg Styles

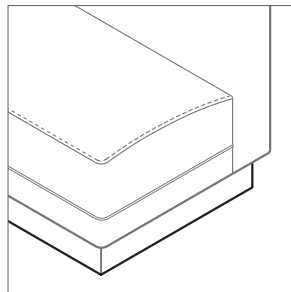

Enclosed kickbase square corners, square or slanted profile (standard)

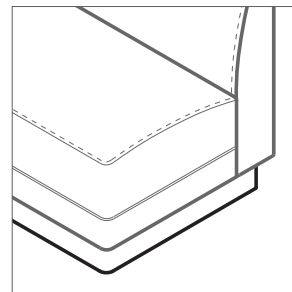

Enclosed kickbase radius corners

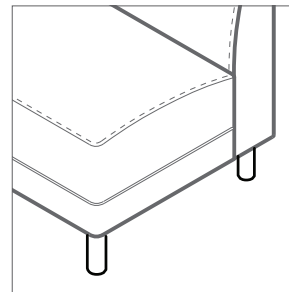

Metal or wooden post legs

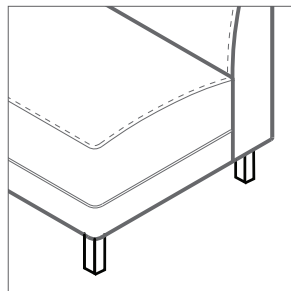

Metal or wooden square post legs

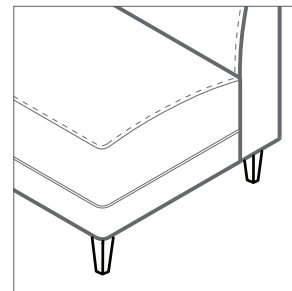

Tapered wooden legs

A recessed kickbase can be used in conjunction with leg supports for additional stability.

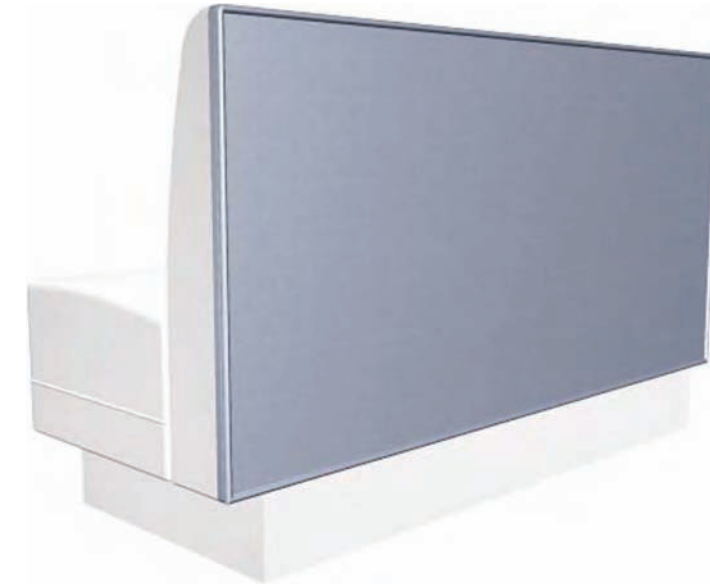

Outside Back Styles

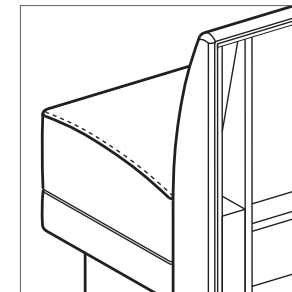

Unfinished (standard)

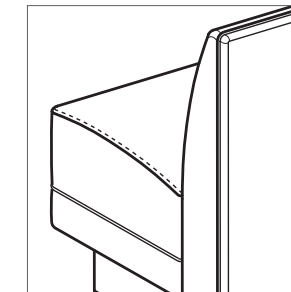

Plain upholstered with welt

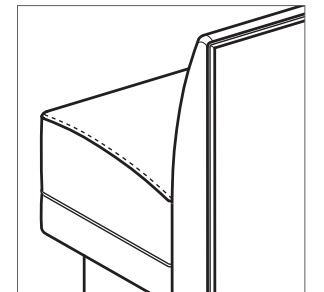

Applied .75" thick self edge plastic laminate or wood veneer back with welt

Product Specifications | Banquette Specification Form

When requesting quotations for banquettes please provide the following information:

Project Name _____

Project Location _____

Requested Delivery Date _____

Contact Information _____

Choose Standard Banquette Configuration (Please See Page 37)

Specify Banquette Design Details & Finishes (Please See Pages 38-43)

Overall Height _____

Inside Back Style _____ Finish _____

End Panel Style _____ Finish _____

Seat Style _____ Finish _____

Apron Style _____ Finish _____

Base Style _____ Finish _____

Outside Back Style _____ Finish _____

Notes _____

*Please submit a floor plan for quantity and dimensions.
For questions, please call customer service at 800-243-3150

To submit your quote request, please e-mail this completed form to: banquette_quotes@westcoastindustries.com

Notes

Pricing

Dining and Multipurpose

48	Alumiline
50	Basic Round
52	Bolt Down
54	Capri
56	Corsica
58	Cozy Bar
60	Disc
68	Dunhill
78	Flat Round
86	Knobhill
88	Manhattan
90	Mark IV
98	Medici
100	Move
102	Parsons
104	Platform
112	Post Leg
120	Presidio
130	Regency
134	Scala
136	Siena
138	Slimline
148	Spacesaver
150	Toscana
152	Tulip
160	Tuscan

Pricing

Occasional

172	Cube
174	Cylinder
176	Disc
180	Move
182	Parsons
186	Platform
188	Tulip

Outdoor Tables and Chairs

194	Arc
196	Basic Round
198	Bistro
200	Disc
202	Flat Round
204	Mark IV
206	Park
208	Platform
210	Sam
212	Tulip
215	Chairs
219	Base and Top Matrix
231	Base Only Pricing
241	Top Only Pricing
250	Options

Laminate Tops Wood Veneer Tops

Self Edge	Vinyl Edges	PVC Edges	Metal Edges	Wood Edges Group A	Wood Edges Group B	Wood Edges Group A	Wood Edges Group B
LLSE Self Edge	LVFL Flat LVBP Bumper	LPVC PVC	LMFL Flat LMRB Ribbed	LWFL Flat LWTP Tapered Ply LWFP Flat Ply	LWSQ Square LWAR Arc LWBN Bullnose LWPR Prism LWPI Pivot	WWFL Flat WWTP Tapered Ply WWFP Flat Ply	WWSQ Square WWAR Arc WWBN Bullnose WWPR Prism WWPI Pivot

Specialty Tops

Butcher Block	Ultrafoam	Acrylic	Corian Group A,B	Corian Group C,D	3form Chroma
BBFL Flat BBBN Bullnose	ULFP PVC ULFR Raw	AAOP Opaque AATL Translucent	C1FL Flat C1BN Bullnose C1PR Prism	C2FL Flat C2BN Bullnose C2PR Prism	3FFL Flat 3FBN Bullnose 3FPR Prism

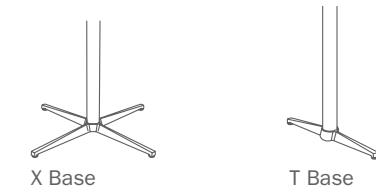

Options

Base Finishes		
Standard Powder Coat	use finish code	n/c
Polished or Satin Aluminum (per base)	use finish code	\$152
Custom Powder Coat (set-up charge)	CPC	\$363

Base Options		
Alternate Height Base (per column)	AH	\$66
Super Level Glides (per base)	GSL	\$34
Custom Top Plate Size	CTPS	\$

Top Materials and Finishes		
Standard Laminates	use manufacturers finish code	n/c
Premium Laminates	PRL	\$
Custom Wood Veneer	CWV	\$
Special Pattern Veneer	SPV	\$
Stain to Match (set-up charge)	STM	\$412

Top Options		
Custom Size	CS	\$
Custom Shape	CSH	\$
Custom Radius Corner	CRC	\$
3" Radius Corner (per corner) (laminates self edge, ultrafoam, Corian®, 3form chroma)	CRL3	\$34
3" Wood Radius Corner (per corner) (not available in LWFL, WWFL, LWPI and WWPI)	CRW3	\$82

Edge Options		
1.75" Thick Edge (per table) (see edge details for specific profiles)	175E	15%

Complete Table List Pricing

Top Shape	Top Size	Base Qty.	Base Style	Model #	\$							
Round	30	1	X	ALX30RD	609	609	671	704	870	1,051	870	1,138
	36	1	X	ALX36RD	779	779	851	897	1,086	1,296	1,112	1,401
	42	1	X	ALX42RD	880	880	960	960	1,202	1,460	1,296	1,586
	48	1	X	ALX48RD	1,188	1,188	1,279	1,306	1,546	1,842	1,657	1,991
	54	1	X	ALX54RD	1,299	1,299	1,404	1,433	1,762	2,373	1,900	2,587
	60	1	X	ALX60RD	1,476	1,476	1,589	1,643	1,882	2,456	2,241	2,682
Square	24 24	1	X	ALX2424SQ	549	549	605	659	757	926	767	998
	30 30	1	X	ALX3030SQ	609	609	677	724	870	1,051	870	1,138
	36 36	1	X	ALX3636SQ	779	779	847	916	1,076	1,296	1,112	1,401
	42 42	1	X	ALX4242SQ	868	868	944	993	1,202	1,460	1,296	1,586
	48 48	1	X	ALX4848SQ	1,190	1,190	1,279	1,338	1,546	1,842	1,657	1,991
Rectangle	24 30	1	X	ALX2430RE	578	578	625	637	818	1,004	899	1,084
	30 36	1	X	ALX3036RE	742	742	787	802	1,024	1,222	1,096	1,318
	30 42	1	X	ALX3042RE	777	777	829	847	1,119	1,341	1,201	1,452
	30 48	1	X	ALX3048RE	814	814	870	890	1,164	1,405	1,255	1,524
	30 60	2	T	ALT3060RE	1,015	1,015	1,079	1,103	1,395	1,671	1,498	1,807
	30 72	2	T	ALT3072RE	1,083	1,083	1,160	1,187	1,471	1,784	1,585	1,934
	36 60	2	T	ALT3660RE	1,080	1,080	1,153	1,177	1,453	1,749	1,564	1,897
	36 72	2	T	ALT3672RE	1,163	1,163	1,240	1,268	1,581	1,916	1,706	2,085

\$					
1,160	642	1,617	1,346	1,610	2,663
1,557	822	2,168	1,784	2,142	3,663
2,082	934	2,819	2,175	2,652	4,799
2,562	1,254	3,880	2,824	3,427	6,308
-	1,384	4,983	3,308	4,056	-
-	1,530	6,197	3,859	4,771	-
984	582	1,161	989	1,142	1,630
1,253	642	1,622	1,241	1,469	2,618
1,675	822	2,175	1,666	1,985	3,611
2,267	923	2,827	2,035	2,459	4,735
2,778	1,256	3,890	2,670	3,215	6,247
1,101	601	1,373	1,105	1,288	2,212
1,495	775	1,967	1,471	1,738	3,136
1,740	817	2,210	1,609	1,919	3,574
1,800	860	2,459	1,761	2,113	4,002
2,218	1,072	3,108	2,167	2,605	4,958
2,523	1,151	3,850	2,453	2,974	5,830
2,486	1,146	3,850	2,459	2,978	5,838
2,838	1,241	4,433	2,786	3,404	6,824

How to Order

Table Model Number					Top Finish Selection		Options
ALX Base Series	36 Top Size	RD Top Shape	WWSQ Top Material Edge Profile	MBK Base Finish	WMW Top Finish	WMW Edge Finish	GSL Super Level Glides
An ALX36RDWWSQMBK is an Alumiline series 36" round table with a black powder coat X-base and a wood veneer 1.25" thick top with a 1.25" square wood edge profile.					The codes: WMW WMW specify a medium walnut top, with a medium walnut edge.		The code: GSL specifies super level glides.

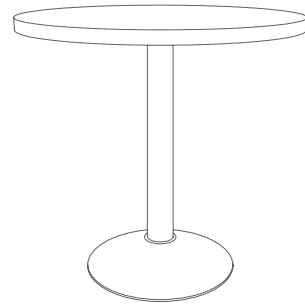

Laminate Tops				Wood Veneer Tops			
Self Edge	Vinyl Edges	PVC Edges	Metal Edges	Wood Edges Group A	Wood Edges Group B	Wood Edges Group A	Wood Edges Group B
LLSE Self Edge	LVFL Flat	LPVC PVC	LMFL Flat	LWFL Flat	LWSQ Square	WWFL Flat	WWSQ Square
	LVBP Bumper		LMRB Ribbed	LWTP Tapered Ply	LWAR Arc	WWTP Tapered Ply	WWAR Arc
				LWFP Flat Ply	LWBN Bullnose	WWBN Bullnose	
					LWPR Prism	WWPR Prism	
					LWPI Pivot	WWPI Pivot	

Specialty Tops					
Butcher Block	Ultrafoam	Acrylic	Corian Group A,B	Corian Group C,D	3form Chroma
BBFL Flat	ULFP PVC	AAOP Opaque	C1FL Flat	C2FL Flat	3FFL Flat
BBBN Bullnose	ULFR Raw	AATL Translucent	C1BN Bullnose	C2BN Bullnose	3FBN Bullnose
			C1PR Prism	C2PR Prism	3FPR Prism

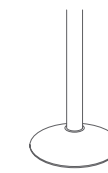

Options

Base Finishes		
Standard Black Wrinkle	MWR	n/c
Powder Coat	use finish code	\$110
Polished or Satin Chrome (per base)	use finish code	\$194
Premium Plated (per base)	use finish code	\$194
Custom Powder Coat (set-up charge)	CPC	\$363

Base Options		
Alternate Height Base (per column)	AH	\$66
Super Level Glides (per base)	GSL	\$34
Custom Top Plate Size	CTPS	\$194
6" Column (black wrinkle and powder coat)	COL6	\$194
6" Column (polished or satin chrome)	COLP6	\$248
6" Column (premium plated)	COLPP6	\$386
6" Column (veneer)	COLV6	\$386

Top Materials and Finishes		
Standard Laminates	use manufacturers finish code	n/c
Premium Laminates	PRL	\$194
Custom Wood Veneer	CWV	\$194
Special Pattern Veneer	SPV	\$194
Stain to Match (set-up charge)	STM	\$412

Top Options		
Custom Size	CS	\$194
Custom Shape	CSH	\$194
Custom Radius Corner	CRC	\$194
3" Radius Corner (per corner)	CRL3	\$34
(laminite self edge, ultrafoam, Corian®, 3form chroma)		
3" Wood Radius Corner (per corner)	CRW3	\$82
(not available in LWFL, WWFL, LWPI and WWPI)		

Edge Options		
1.75" Thick Edge (per table)	175E	15%
(see edge details for specific profiles)		

Complete Table List Pricing

	Top Size	Base Qty.	Base Style	Model #	\$								
Round	24	1	17L	BA17L24RD	334	334	384	432	542	711	552	783	
	30	1	17M	BA17M30RD	424	424	486	519	685	866	685	953	
	36	1	20M	BA20M36RD	534	534	606	652	841	1,051	867	1,156	
	42	1	22L	BA22L42RD	630	630	710	710	952	1,210	1,046	1,336	
	48	1	22M	BA22M48RD	768	768	859	886	1,126	1,422	1,237	1,571	
	54	1	22H	BA22H54RD	914	914	1,019	1,048	1,377	1,988	1,515	2,202	
	60	1	28H	BA28H60RD	1,221	1,221	1,334	1,388	1,627	2,201	1,986	2,427	
Square	24	24	1	17L	BA17L2424SQ	334	334	390	444	542	711	552	783
	30	30	1	17M	BA17M3030SQ	424	424	492	539	685	866	685	953
	36	36	1	20M	BA20M3636SQ	534	534	602	671	831	1,051	867	1,156
	42	42	1	22M	BA22M4242SQ	653	653	729	778	987	1,245	1,081	1,371
	48	48	1	22H	BA22H4848SQ	805	805	894	953	1,161	1,457	1,272	1,606
Rectangle	24	30	1	17M	BA17M2430RE	393	393	452	452	633	819	714	899
	24	36	1	20M	BA20M2436RE	452	452	518	518	726	907	792	995
	24	42	1	22L	BA22L2442RE	480	480	540	540	762	961	832	1,056
	24	48	1	22M	BA22M2448RE	550	550	624	624	869	1,091	949	1,196
	24	60	2	17L	BA17L2460RE	667	667	748	748	1,008	1,261	1,097	1,381
	24	72	2	17L	BA17L2472RE	725	725	819	819	1,105	1,395	1,208	1,533
	30	36	1	20M	BA20M3036RE	497	497	557	557	779	977	851	1,073
	30	42	1	22L	BA22L3042RE	527	527	597	597	869	1,091	951	1,202
	30	48	1	22M	BA22M3048RE	599	599	675	675	949	1,190	1,040	1,309
	30	60	2	17M	BA17M3060RE	795	795	883	883	1,175	1,451	1,278	1,587
	30	72	2	17M	BA17M3072RE	863	863	967	967	1,251	1,564	1,365	1,714
	36	42	1	22M	BA22M3642RE	610	610	688	688	959	1,204	1,052	1,324
	36	48	1	22M	BA22M3648RE	650	650	733	733	1,013	1,274	1,110	1,402
	36	60	2	20M	BA20M3660RE	920	920	1,017	1,017	1,293	1,589	1,404	1,737
	36	72	2	20M	BA20M3672RE	1,003	1,003	1,108	1,108	1,421	1,756	1,546	1,925

How to Order

Table Model Number					Top Finish Selection		Options
BA20M Base Series	36 Top Size	RD Top Shape	WWSQ Top Material Edge Profile	MBK Base Finish	WMW Top Finish	WMW Edge Finish	GSL Super Level Glides
A BA20M36RDWWSQMBK is a Basic Round series 36" round table with a black powder coated, medium weight round base, medium weight base and a wood veneer 1.25" thick top with a 1.25" square wood edge profile.					The codes: WMW WMW specify a medium walnut top, with a medium walnut edge.		The code: GSL specifies super level glides.

Laminate Tops				Wood Veneer Tops			
Self Edge	Vinyl Edges	PVC Edges	Metal Edges	Wood Edges Group A	Wood Edges Group B	Wood Edges Group A	Wood Edges Group B
LLSE Self Edge	LVFL Flat	LPVC PVC	LMFL Flat	LWFL Flat	LWSQ Square	WWFL Flat	WWSQ Square
	LVBP Bumper		LMRB Ribbed	LWTP Tapered Ply	LWAR Arc	WWTP Tapered Ply	WWAR Arc
				LWFP Flat Ply	LWBN Bullnose	WWFP Flat Ply	WWBN Bullnose
					LWPR Prism		WWPR Prism
					LWPI Pivot		WWPI Pivot

Specialty Tops					
Butcher Block	Ultrafoam	Acrylic	Corian Group A,B	Corian Group C,D	3form Chroma
BBFL Flat	ULFP PVC	AAOP Opaque	C1FL Flat	C2FL Flat	3FFL Flat
BBBN Bullnose	ULFR Raw	AATL Translucent	C1BN Bullnose	C2BN Bullnose	3FBN Bullnose
			C1PR Prism	C2PR Prism	3FPR Prism

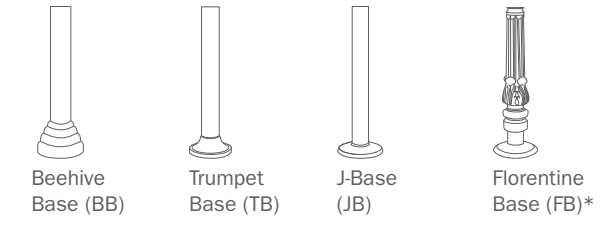

Complete Table List Pricing

	Top Size	Base Qty.	Model #	\$							
Round	24	1	XX24RD	409	409	459	507	617	786	627	858
	30	1	XX30RD	469	469	531	564	730	911	730	998
	36	1	XX36RD	549	549	621	667	856	1,066	882	1,171
	42	1	XX42RD	650	650	730	730	972	1,230	1,066	1,356
	48	1	XX48RD	753	753	844	871	1,111	1,407	1,222	1,556
Square	24 24	1	XX2424SQ	409	409	465	519	617	786	627	858
	30 30	1	XX3030SQ	469	469	537	584	730	911	730	998
	36 36	1	XX3636SQ	549	549	617	686	846	1,066	882	1,171
	42 42	1	XX4242SQ	638	638	714	763	972	1,230	1,066	1,356
	48 48	1	XX4848SQ	755	755	844	903	1,111	1,407	1,222	1,556
Rectangle	24 30	1	XX2430RE	438	438	485	497	678	864	759	944
	24 36	1	XX2436RE	467	467	519	533	741	922	807	1,010
	24 42	1	XX2442RE	500	500	545	560	782	981	852	1,076
	24 48	1	XX2448RE	535	535	591	609	854	1,076	934	1,181
	24 60	2	XX2460RE	817	817	877	898	1,158	1,411	1,247	1,531
	24 72	2	XX2472RE	875	875	945	969	1,255	1,545	1,358	1,683
	30 36	1	XX3036RE	512	512	557	572	794	992	866	1,088
	30 42	1	XX3042RE	547	547	599	617	889	1,111	971	1,222
	30 48	1	XX3048RE	584	584	640	660	934	1,175	1,025	1,294
	30 60	2	XX3060RE	885	885	949	973	1,265	1,541	1,368	1,677
	30 72	2	XX3072RE	953	953	1,030	1,057	1,341	1,654	1,455	1,804
	36 42	1	XX3642RE	595	595	654	673	944	1,189	1,037	1,309
	36 48	1	XX3648RE	635	635	697	718	998	1,259	1,095	1,387
	36 60	2	XX3660RE	950	950	1,023	1,047	1,323	1,619	1,434	1,767
	36 72	2	XX3672RE	1,033	1,033	1,110	1,138	1,451	1,786	1,576	1,955

Replace ___ with specific Bolt Down Base Code. Refer to page 53.

\$					
774	428	1,019	934	1,111	1,523
1,020	502	1,477	1,206	1,470	2,523
1,327	592	1,938	1,554	1,912	3,433
1,852	704	2,589	1,945	2,422	4,569
2,127	819	3,445	2,389	2,992	5,873
844	442	1,021	849	1,002	1,490
1,113	502	1,482	1,101	1,329	2,478
1,445	592	1,945	1,436	1,755	3,381
2,037	693	2,597	1,805	2,229	4,505
2,343	821	3,455	2,235	2,780	5,812
961	461	1,233	965	1,148	2,072
1,095	496	1,517	1,078	1,294	2,399
1,289	532	1,642	1,189	1,442	2,735
1,344	572	1,827	1,303	1,591	3,068
1,813	864	-	1,768	2,121	4,000
2,064	932	-	2,007	2,430	4,665
1,265	545	1,737	1,241	1,508	2,906
1,510	587	1,980	1,379	1,689	3,344
1,570	630	2,229	1,531	1,883	3,772
2,088	942	2,978	2,037	2,475	4,828
2,393	1,021	3,720	2,323	2,844	5,700
1,724	642	-	1,759	1,936	3,941
1,790	691	2,632	2,087	2,171	4,447
2,356	1,016	3,720	2,329	2,848	5,708
2,708	1,111	4,303	2,656	3,274	6,694

Options

Base Finishes		
Standard Powder Coat	use finish code	n/c
Polished or Satin Chrome (per base)	use finish code	\$59
Premium Plated (per base)	use finish code	Ⓛ
Custom Powder Coat (set-up charge)	CPC	\$363

Base Options		
Alternate Height Base (per column) (BB, TB, JB)	AH	\$66
Alternate Height Base (per column) (FB)	AH	\$166

Custom Top Plate Size	CTPS	Ⓛ
-----------------------	------	---

Top Materials and Finishes		
Standard Laminates	use manufacturers finish code	n/c
Premium Laminates	PRL	Ⓛ
Custom Wood Veneer	CWV	Ⓛ
Special Pattern Veneer	SPV	Ⓛ
Stain to Match (set-up charge)	STM	\$412

Top Options		
Custom Size	CS	Ⓛ
Custom Shape	CSH	Ⓛ
Custom Radius Corner	CRC	Ⓛ
3" Radius Corner (per corner)	CRL3	\$34
(laminates self edge, ultrafoam, Corian®, 3form chroma)		
3" Wood Radius Corner (per corner)	CRW3	\$82
(not available in LWFL, WWFL, LWPI and WWPI)		

Edge Options		
1.75" Thick Edge (per table)	175E	15%
(see edge details for specific profiles)		

*Florentine Bolt Down base design (Code FB) add \$166 to current published prices.

How to Order

Table Model Number					Top Finish Selection		Options
BB Base Series	36 Top Size	RD Top Shape	WWSQ Top Material Edge Profile	MBK Base Finish	WMW Top Finish	WMW Edge Finish	AH Alternate Height Base
A BB36RDWWSQMBK is a (Beehive) Bolt Down series 36" round table with a black powder coat bolt down base and a wood veneer 1.25" thick top with a 1.25" square wood edge profile.					The codes: WMW WMW specify a medium walnut top, with a medium walnut edge.		The code: AH specifies alternate height base.

Laminate Tops				Wood Veneer Tops			
Self Edge	Vinyl Edges	PVC Edges	Metal Edges	Wood Edges Group A	Wood Edges Group B	Wood Edges Group A	Wood Edges Group B
LLSE Self Edge	LVFL Flat	LPVC PVC	LMFL Flat	LWFL Flat	LWSQ Square	WWFL Flat	WWSQ Square
	LVBP Bumper		LMRB Ribbed	LWTP Tapered Ply	LWAR Arc	WWTP Tapered Ply	WWAR Arc
				LWFP Flat Ply	LWBN Bullnose	WWFP Flat Ply	WWBN Bullnose
					LWPR Prism		WWPR Prism
					LWPI Pivot		WWPI Pivot

Butcher Block	Ultrafoam	Acrylic	Corian Group A,B	Corian Group C,D	3form Chroma
BBFL Flat	ULFP PVC	AAOP Opaque	C1FL Flat	C2FL Flat	3FFL Flat
BBBN Bullnose	ULFR Raw	AATL Translucent	C1BN Bullnose	C2BN Bullnose	3FBN Bullnose
			C1PR Prism	C2PR Prism	3FPR Prism

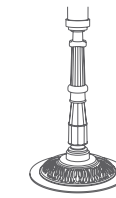

Complete Table List Pricing

	Top Size	Base Qty.	Model #	\$								
Round	24	1	CA24RD	506	506	556	604	714	883	724	955	
	30	1	CA30RD	566	566	628	661	827	1,008	827	1,095	
Square	24	24	1	CA2424SQ	506	506	562	616	714	883	724	955
	30	30	1	CA3030SQ	566	566	634	681	827	1,008	827	1,095
Rectangle	24	30	1	CA2430RE	535	535	582	594	776	961	856	1,042

\$					
871	525	1,116	1,031	1,208	1,620
1,117	599	1,575	1,303	1,567	2,620
941	539	1,118	946	1,099	1,587
1,210	599	1,579	1,198	1,426	2,575
1,058	558	1,330	1,062	1,245	2,169

Options

Base Finishes		use finish code	n/c
Standard Powder Coat			n/c
Custom Powder Coat (set-up charge)		CPC	\$363
Base Options			
Alternate Height Base (per column)	AH		\$166
Super Level Glides (per base)	GSL		\$34
Custom Top Plate Size	CTPS		Ⓛ
Top Materials and Finishes		use manufacturers finish code	n/c
Standard Laminates			n/c
Premium Laminates		PRL	Ⓛ
Custom Wood Veneer		CWV	Ⓛ
Special Pattern Veneer		SPV	Ⓛ
Stain to Match (set-up charge)		STM	\$412
Top Options			
Custom Size	CS		Ⓛ
Custom Shape	CSH		Ⓛ
Custom Radius Corner	CRC		Ⓛ
3" Radius Corner (per corner)	CRL3		\$34
(laminate self edge, ultrafoam, Corian®, 3form chroma)			
3" Wood Radius Corner (per corner)	CRW3		\$82
(not available in LWFL, WWFL, LWPI and WWPI)			
Edge Options			
1.75" Thick Edge (per table)	175E		15%
(see edge details for specific profiles)			

How to Order

Table Model Number					Top Finish Selection		Options
CA Base Series	36 Top Size	RD Top Shape	WWSQ Top Material Edge Profile	MBK Base Finish	WMW Top Finish	WMW Edge Finish	GSL Super Level Glides
A CA36RDWWSQMBK is a Capri series 36" round table with a black powder coat round base and a wood veneer 1.25" thick top with a 1.25" square wood edge profile.					The codes: WMW WMW specify a medium walnut top, with a medium walnut edge.		The code: GSL specifies super level glides.

Laminate Tops				Wood Veneer Tops			
Self Edge	Vinyl Edges	PVC Edges	Metal Edges	Wood Edges Group A	Wood Edges Group B	Wood Edges Group A	Wood Edges Group B
LLSE Self Edge	LVFL Flat	LPVC PVC	LMFL Flat	LWFL Flat	LWSQ Square	WWFL Flat	WWSQ Square
	LVBP Bumper		LMRB Ribbed	LWTP Tapered Ply	LWAR Arc	WWTP Tapered Ply	WWAR Arc
				LWFP Flat Ply	LWBN Bullnose	WWFP Flat Ply	WWBN Bullnose
					LWPR Prism		WWPR Prism
				LWPI Pivot			WWPI Pivot

Butcher Block	Ultrafoam	Acrylic	Corian Group A,B	Corian Group C,D	3form Chroma
BBFL Flat	ULFP PVC	AAOP Opaque	C1FL Flat	C2FL Flat	3FFL Flat
BBBN Bullnose	ULFR Raw	AATL Translucent	C1BN Bullnose	C2BN Bullnose	3FBN Bullnose
			C1PR Prism	C2PR Prism	3FPR Prism

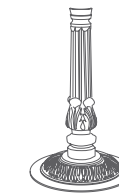

Options

Base Finishes		use finish code	n/c
Standard Powder Coat			n/c
Custom Powder Coat (set-up charge)		CPC	\$363

Base Options			
Alternate Height Base (per column)	AH		\$166
Super Level Glides (per base)	GSL		\$34
Custom Top Plate Size	CTPS		Ⓛ

Top Materials and Finishes		use manufacturers finish code	n/c
Standard Laminates			n/c
Premium Laminates	PRL		Ⓛ
Custom Wood Veneer	CWV		Ⓛ
Special Pattern Veneer	SPV		Ⓛ
Stain to Match (set-up charge)	STM		\$412

Top Options			
Custom Size	CS		Ⓛ
Custom Shape	CSH		Ⓛ
Custom Radius Corner	CRC		Ⓛ
3" Radius Corner (per corner)	CRL3		\$34
(laminates self edge, ultrafoam, Corian®, 3form chroma)			
3" Wood Radius Corner (per corner)	CRW3		\$82
(not available in LWFL, WWFL, LWPI and WWPI)			

Edge Options			
1.75" Thick Edge (per table)	175E		15%
(see edge details for specific profiles)			

Complete Table List Pricing

	Top Size	Base Qty.	Model #	\$							
Round	24	1	CR24RD	672	672	722	770	880	1,049	890	1,121
	30	1	CR30RD	732	732	794	827	993	1,174	993	1,261
	36	1	CR36RD	957	957	1,029	1,075	1,264	1,474	1,290	1,579
	42	1	CR42RD	1,058	1,058	1,138	1,138	1,380	1,638	1,474	1,764
	48	1	CR48RD	1,161	1,161	1,251	1,279	1,519	1,815	1,630	1,964
	54	1	CR54RD	1,272	1,272	1,377	1,406	1,735	2,346	1,873	2,560
	60	1	CR60RD	1,449	1,449	1,562	1,616	1,854	2,429	2,214	2,655
Square	24 24	1	CR2424SQ	672	672	728	782	880	1,049	890	1,121
	30 30	1	CR3030SQ	732	732	800	847	993	1,174	993	1,261
	36 36	1	CR3636SQ	957	957	1,025	1,094	1,254	1,474	1,290	1,579
	42 42	1	CR4242SQ	1,046	1,046	1,122	1,171	1,380	1,638	1,474	1,764
	48 48	1	CR4848SQ	1,163	1,163	1,251	1,310	1,519	1,815	1,630	1,964
Rectangle	24 30	1	CR2430RE	701	701	748	760	941	1,127	1,022	1,207
	24 36	1	CR2436RE	875	875	927	941	1,149	1,330	1,214	1,418
	24 42	1	CR2442RE	908	908	953	967	1,190	1,389	1,260	1,484
	24 48	1	CR2448RE	943	943	999	1,017	1,262	1,484	1,342	1,589
	30 36	1	CR3036RE	920	920	964	980	1,202	1,400	1,274	1,496
	30 42	1	CR3042RE	955	955	1,007	1,025	1,297	1,519	1,379	1,630
	30 48	1	CR3048RE	992	992	1,048	1,068	1,342	1,583	1,433	1,702
	36 42	1	CR3642RE	1,002	1,002	1,062	1,081	1,352	1,597	1,445	1,717
	36 48	1	CR3648RE	1,043	1,043	1,105	1,126	1,406	1,667	1,503	1,795

\$					
1,037	691	1,282	1,197	1,374	1,786
1,283	765	1,740	1,469	1,733	2,786
1,735	1,000	2,346	1,961	2,320	3,840
2,260	1,112	2,997	2,353	2,829	4,976
2,535	1,227	3,853	2,797	3,400	6,281
-	1,357	4,956	3,281	4,029	-
-	1,503	6,170	3,832	4,744	-
1,107	705	1,284	1,112	1,265	1,753
1,376	765	1,745	1,364	1,592	2,741
1,853	1,000	2,353	1,844	2,163	3,789
2,445	1,101	3,005	2,213	2,637	4,913
2,751	1,229	3,863	2,643	3,188	6,219
1,224	724	1,496	1,228	1,411	2,335
1,503	904	1,924	1,486	1,702	2,807
1,696	940	2,050	1,597	1,850	3,143
1,752	980	2,235	1,710	1,999	3,476
1,673	953	2,145	1,649	1,916	3,314
1,918	995	2,387	1,787	2,097	3,752
1,978	1,037	2,637	1,939	2,291	4,180
2,132	1,050	-	2,167	2,344	4,349
2,198	1,099	3,040	2,494	2,579	4,855

How to Order

Table Model Number					Top Finish Selection		Options
CR Base Series	36 Top Size	RD Top Shape	WWSQ Top Material Edge Profile	MBK Base Finish	WMW Top Finish	WMW Edge Finish	GSL Super Level Glides
A CR36RDWWSQMBK is a Corsica series 36" round table with a black powder coat round base and a wood veneer 1.25" thick top with a 1.25" square wood edge profile.					The codes: WMW WMW specify a medium walnut top, with a medium walnut edge.		The code: GSL specifies super level glides.

Laminate Tops				Wood Veneer Tops			
Self Edge	Vinyl Edges	PVC Edges	Metal Edges	Wood Edges Group A	Wood Edges Group B	Wood Edges Group A	Wood Edges Group B
LLSE Self Edge	LVFL Flat	LPVC PVC	LMFL Flat	LWFL Flat	LWSQ Square	WWFL Flat	WWSQ Square
	LVBP Bumper		LMRB Ribbed	LWTP Tapered Ply	LWAR Arc	WWTP Tapered Ply	WWAR Arc
				LWFP Flat Ply	LWBN Bullnose	WWFP Flat Ply	WWBN Bullnose
					LWPR Prism		WWPR Prism
				LWPI Pivot			WWPI Pivot

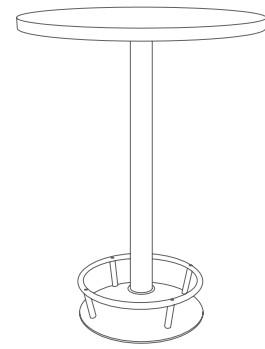

Complete Table List Pricing

Round	Top Size	Base Qty.	Overall Table Height	Model #	\$							
	24	1	42	CB24RD	679	679	729	777	887	1,056	897	1,128
	30	1	42	CB30RD	739	739	801	834	1,000	1,181	1,000	1,268
	36	1	42	CB36RD	879	879	951	997	1,186	1,396	1,212	1,501
	42	1	42	CB42RD	1,075	1,075	1,155	1,155	1,397	1,655	1,491	1,781
	48	1	42	CB48RD	1,178	1,178	1,269	1,296	1,536	1,832	1,647	1,981



Butcher Block	Ultrafoam	Acrylic	Corian Group A,B	Corian Group C,D	3form Chroma
BBFL Flat	ULFP PVC	AAOP Opaque	C1FL Flat	C2FL Flat	3FFL Flat
BBBN Bullnose	ULFR Raw	AATL Translucent	C1BN Bullnose	C2BN Bullnose	3FBN Bullnose
			C1PR Prism	C2PR Prism	3FPR Prism

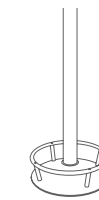

Options

Base Finishes		
Standard Black Wrinkle	MWR	n/c
Powder Coat	use finish code	\$152
Polished or Satin Chrome (per base)	use finish code	\$273
Premium Plated (per base)	use finish code	\$
Custom Powder Coat (set-up charge)	CPC	\$363
Footring Finish: Polished or Satin Chrome	use finish code	n/c

Base Options		
Alternate Height Base (per column)	AH	\$66
Super Level Glides (per base)	GSL	\$34
Custom Top Plate Size	CTPS	\$

Top Materials and Finishes		
Standard Laminates	use manufacturers finish code	n/c
Premium Laminates	PRL	\$
Custom Wood Veneer	CWV	\$
Special Pattern Veneer	SPV	\$
Stain to Match (set-up charge)	STM	\$412

Top Options		
Custom Size	CS	\$
Custom Shape	CSH	\$
Custom Radius Corner	CRC	\$
3" Radius Corner (per corner)	CRL3	\$34
(laminates self edge, ultrafoam, Corian®, 3form chroma)		
3" Wood Radius Corner (per corner)	CRW3	\$82
(not available in LWFL, WWFL, LWPI and WWPI)		

Edge Options		
1.75" Thick Edge (per table)	175E	15%
(see edge details for specific profiles)		

\$					
1,044	698	1,289	1,204	1,381	1,793
1,290	772	1,747	1,476	1,740	2,793
1,657	922	2,268	1,884	2,242	3,763
2,277	1,129	3,014	2,370	2,847	4,994
2,552	1,244	3,870	2,814	3,417	6,298

How to Order

Table Model Number					Top Finish Selection		Options
CB Base Series	36 Top Size	RD Top Shape	WWSQ Top Material Edge Profile	MBK Base Finish	WMW Top Finish	WMW Edge Finish	GSL Super Level Glides
A CB36RDWWSQMBK is a Cozy Bar series 36" round table with a black powder coat round base and a wood veneer 1.25" thick top with a 1.25" square wood edge profile.					The codes: WMW WMW specify a medium walnut top, with a medium walnut edge.		The code: GSL specifies super level glides.

Laminate Tops				Wood Veneer Tops			
Self Edge	Vinyl Edges	PVC Edges	Metal Edges	Wood Edges Group A	Wood Edges Group B	Wood Edges Group A	Wood Edges Group B
LLSE Self Edge	LVFL Flat	LPVC PVC	LMFL Flat	LWFL Flat	LWSQ Square	WWFL Flat	WWSQ Square
	LVBP Bumper		LMRB Ribbed	LWTP Tapered Ply	LWAR Arc	WWTP Tapered Ply	WWAR Arc
				LWFP Flat Ply	LWBN Bullnose	WWFP Flat Ply	WWBN Bullnose
					LWPR Prism		WWPR Prism
				LWPI Pivot			WWPI Pivot

Specialty Tops				
Butcher Block	Ultrafoam	Acrylic	Corian Group A,B	Corian Group C,D
BBFL Flat	ULFP PVC	AAOP Opaque	C1FL Flat	C2FL Flat
BBBN Bullnose	ULFR Raw	AATL Translucent	C1BN Bullnose	C2BN Bullnose
			C1PR Prism	C2PR Prism
				3FFL Flat
				3FBN Bullnose
				3FPR Prism

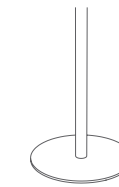

Options

Base Finishes		
Standard Powder Coat	use finish code	n/c
Polished or Satin Chrome (per base)	use finish code	\$213
Premium Plated (per base)	use finish code	\$
Custom Powder Coat (set-up charge)	CPC	\$363

Base Options		
Alternate Height Base (per column)	AH	\$66
Nylon Octagon Glides (per base)	GNO	\$34
Custom Top Plate Size	CTPS	\$
6" Column (black wrinkle and powder coat)	COL6	\$194
6" Column (polished or satin chrome)	COLP6	\$248
6" Column (premium plated)	COLPP6	\$
6" Column (veneer)	COLV6	\$386

Top Materials and Finishes		
Standard Laminates	use manufacturers finish code	n/c
Premium Laminates	PL	\$
Custom Wood Veneer	CWV	\$
Special Pattern Veneer	SPV	\$
Stain to Match (set-up charge)	STM	\$412

Top Options		
Custom Size	CS	\$
Custom Shape	CSH	\$
Custom Radius Corner	CRC	\$
3" Radius Corner (per corner)	CRL3	\$34
(laminate self edge, ultrafoam, Corian®, 3form chroma)		
3" Wood Radius Corner (per corner)	CRW3	\$82
(not available in LWFL, WWFL, LWPI and WWPI)		

Grommets		
2" Round Metal Grommet - Matte Black	GMBK	\$138
2" Round Metal Grommet - Satin Chrome	GMSC	\$138
2" Round Metal Grommet - Polished Chrome	GMPC	\$138
2" Round Plastic Grommet - Matte Black	GPMBK	\$44
Grommet location	use location code	n/c

Edge Options		
1.75" Thick Edge (per table)	175E	15%
(see edge details for specific profiles)		

Complete Table List Pricing

	Top Size	Base Qty.	Model #	\$								
Round	24	1	DI24RD	624	624	674	722	832	1,001	842	1,073	
	30	1	DI30RD	684	684	746	779	945	1,126	945	1,213	
	36	1	DI36RD	924	924	996	1,042	1,231	1,441	1,257	1,546	
	42	1	DI42RD	1,025	1,025	1,105	1,105	1,347	1,605	1,441	1,731	
	48	1	DI48RD	1,253	1,253	1,344	1,371	1,611	1,907	1,722	2,056	
	54	1	DI54RD	1,364	1,364	1,469	1,498	1,827	2,438	1,965	2,652	
	60	1	DI60RD	1,541	1,541	1,654	1,708	1,947	2,521	2,306	2,747	
Oval	36	72	2	DI3672OV	1,494	1,494	1,545	1,570	1,753	1,975	1,926	2,142
	42	54	2	DI4254OV	1,471	1,471	1,498	1,562	1,703	2,030	1,854	2,090
	42	78	2	DI4278OV	2,083	2,083	2,124	2,169	2,317	2,538	2,460	2,707
	42	84	2	DI4284OV	2,139	2,139	2,193	2,237	2,367	2,618	2,513	2,797
	48	78	2	DI4878OV	2,424	2,424	2,481	2,527	2,650	2,899	2,802	3,082
	48	96	2	DI4896OV	2,600	2,600	2,656	2,706	2,798	3,070	3,160	3,477
Racetrack	30	60	2	DI3060RA	1,327	1,327	1,385	1,407	1,697	1,975	1,798	2,143
	30	72	2	DI3072RA	1,395	1,395	1,467	1,492	1,771	2,115	1,884	2,247
	30	84	2	DI3084RA	1,625	1,625	1,689	1,730	1,868	2,354	1,994	2,551
	30	96	2	DI3096RA	1,695	1,695	1,767	1,811	1,962	2,568	2,092	2,755
	36	60	2	DI3660RA	1,713	1,713	1,781	1,803	2,073	2,380	2,184	2,540
	36	72	2	DI3672RA	1,793	1,793	1,872	1,897	2,205	2,548	2,332	2,719
	36	84	2	DI3684RA	2,030	2,030	2,109	2,151	2,305	2,775	2,449	2,999
	36	96	2	DI3696RA	2,110	2,110	2,203	2,244	2,412	3,001	2,567	3,178
	42	72	2	DI4272RA	1,877	1,877	1,951	1,982	2,266	2,661	2,337	2,945
	42	84	2	DI4284RA	2,131	2,131	2,198	2,242	2,365	2,916	2,511	3,236
	42	96	2	DI4296RA	2,227	2,227	2,296	2,345	2,488	3,114	2,651	3,511

Continued on next page

How to Order

Table Model Number					Top Finish Selection		Options
DI Base Series	36 Top Size	RD Top Shape	WWSQ Top Material Edge Profile	MBK Base Finish	WMW Top Finish	WMW Edge Finish	AH Alternate Height Base
A DI36RDWWSQMBK is a Disc series 36" round table with a black powder coat round base and a wood veneer 1.25" thick top with a 1.25" square wood edge profile.					The codes: WMW WMW specify a medium walnut top, with a medium walnut edge.		The code: AH specifies alternate height base.

Laminate Tops				Wood Veneer Tops			
Self Edge	Vinyl Edges	PVC Edges	Metal Edges	Wood Edges Group A	Wood Edges Group B	Wood Edges Group A	Wood Edges Group B
LLSE Self Edge	LVFL Flat	LPVC PVC	LMFL Flat	LWFL Flat	LWSQ Square	WWFL Flat	WWSQ Square
	LVBP Bumper		LMRB Ribbed	LWTP Tapered Ply	LWAR Arc	WWTP Tapered Ply	WWAR Arc
				LWFP Flat Ply	LWBN Bullnose	WWFP Flat Ply	WWBN Bullnose
					LWPR Prism		WWPR Prism
					LWPI Pivot		WWPI Pivot

Specialty Tops					
Butcher Block	Ultrafoam	Acrylic	Corian Group A,B	Corian Group C,D	3form Chroma
BBFL Flat	ULFP PVC	AAOP Opaque	C1FL Flat	C2FL Flat	3FFL Flat
BBBN Bullnose	ULFR Raw	AATL Translucent	C1BN Bullnose	C2BN Bullnose	3FBN Bullnose
			C1PR Prism	C2PR Prism	3FPR Prism

Complete Table List Pricing

	Top Size	Base Qty.	Model #	\$							
Racetrack	48 96	2	DI4896RA	2,580	2,580	2,660	2,710	2,940	3,591	3,309	3,817
	48 120	2	DI48120RA	2,792	2,792	2,893	2,955	3,183	3,930	3,613	4,270
	48 144	3	DI48144RA	3,775	3,775	3,890	3,967	4,208	5,018	4,720	5,443
	48 168	3	DI48168RA	3,990	3,990	4,113	4,200	4,459	5,387	5,035	5,869
Oval	60 120	2	DI60120RA	3,064	3,064	3,173	3,249	3,364	4,270	3,813	4,667
	60 144	3	DI60144RA	4,099	4,099	4,200	4,292	4,547	5,387	4,879	5,856
	60 168	3	DI60168RA	4,364	4,364	4,475	4,580	4,841	5,782	5,513	6,632
Square	24 24	1	DI2424SQ	624	624	680	734	832	1,001	842	1,073
	30 30	1	DI3030SQ	684	684	752	799	945	1,126	945	1,213
	36 36	1	DI3636SQ	924	924	992	1,061	1,221	1,441	1,257	1,546
	42 42	1	DI4242SQ	1,013	1,013	1,089	1,138	1,347	1,605	1,441	1,731
	48 48	1	DI4848SQ	1,255	1,255	1,344	1,403	1,611	1,907	1,722	2,056
Rectangle	24 30	1	DI2430RE	653	653	700	712	893	1,079	974	1,159
	24 36	1	DI2436RE	842	842	894	908	1,116	1,297	1,182	1,385
	24 42	1	DI2442RE	875	875	920	935	1,157	1,356	1,227	1,451
	24 48	1	DI2448RE	910	910	966	984	1,229	1,451	1,309	1,556
	24 60	2	DI2460RE	1,247	1,247	1,307	1,328	1,588	1,841	1,677	1,961
	24 72	2	DI2472RE	1,305	1,305	1,375	1,399	1,685	1,975	1,788	2,113
	24 84	2	DI2484RE	1,522	1,522	1,587	1,627	1,767	2,255	1,880	2,430
	24 96	2	DI2496RE	1,580	1,580	1,651	1,695	1,849	2,376	1,971	2,566
	30 36	1	DI3036RE	887	887	932	947	1,169	1,367	1,241	1,463
	30 42	1	DI3042RE	922	922	974	992	1,264	1,486	1,346	1,597
	30 48	1	DI3048RE	1,084	1,084	1,140	1,160	1,434	1,675	1,525	1,794
	30 60	2	DI3060RE	1,315	1,315	1,379	1,403	1,695	1,971	1,798	2,107
	30 72	2	DI3072RE	1,383	1,383	1,460	1,487	1,771	2,084	1,885	2,234
	30 84	2	DI3084RE	1,615	1,615	1,681	1,726	1,866	2,354	1,989	2,537
	30 96	2	DI3096RE	1,685	1,685	1,758	1,806	1,961	2,527	2,097	2,732

Continued on next page

How to Order

Table Model Number				Top Finish Selection		Options	
DI Base Series	4896 Top Size	RA Top Shape	WWSQ Top Material Edge Profile	MBK Base Finish	WMW Top Finish	WMW Edge Finish	GMBK Matte Black Grommet
A DI4896RAWWSQMBK is a Disc series 48" x 96" racetrack table with two black powder coat round bases and a wood veneer 1.25" thick top with a 1.25" square wood edge profile.				The codes: WMW WMW specify a medium walnut top, with a medium walnut edge.		The code: GMBK specifies a matte black 2" diameter metal grommet.	
						E Location "E"	
						The code: E specifies the location of the grommet.	

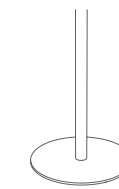

Options

Base Finishes		
Standard Powder Coat	use finish code	n/c
Polished or Satin Chrome (per base)	use finish code	\$213
Premium Plated (per base)	use finish code	\$
Custom Powder Coat (set-up charge)	CPC	\$363

Base Options		
Alternate Height Base (per column)	AH	\$66
Nylon Octagon Glides (per base)	GNO	\$34
Custom Top Plate Size	CTPS	\$
6" Column (black wrinkle and powder coat)	COL6	\$194
6" Column (polished or satin chrome)	COLP6	\$248
6" Column (premium plated)	COLPP6	\$
6" Column (veneer)	COLV6	\$386

Top Materials and Finishes		
Standard Laminates	use manufacturers finish code	n/c
Premium Laminates	PL	\$
Custom Wood Veneer	CWV	\$
Special Pattern Veneer	SPV	\$
Stain to Match (set-up charge)	STM	\$412

Top Options		
Custom Size	CS	\$
Custom Shape	CSH	\$
Custom Radius Corner	CRC	\$
3" Radius Corner (per corner)	CRL3	\$34
(laminates self edge, ultrafoam, Corian®, 3form chroma)		
3" Wood Radius Corner (per corner)	CRW3	\$82
(not available in LWFL, WWFL, LWPI and WWPI)		

Grommets		
2" Round Metal Grommet - Matte Black	GMBK	\$138
2" Round Metal Grommet - Satin Chrome	GMSC	\$138
2" Round Metal Grommet - Polished Chrome	GMPC	\$138
2" Round Plastic Grommet - Matte Black	GPMBK	\$44
Grommet location	use location code	n/c

Edge Options		
1.75" Thick Edge (per table)	175E	15%
(see edge details for specific profiles)		

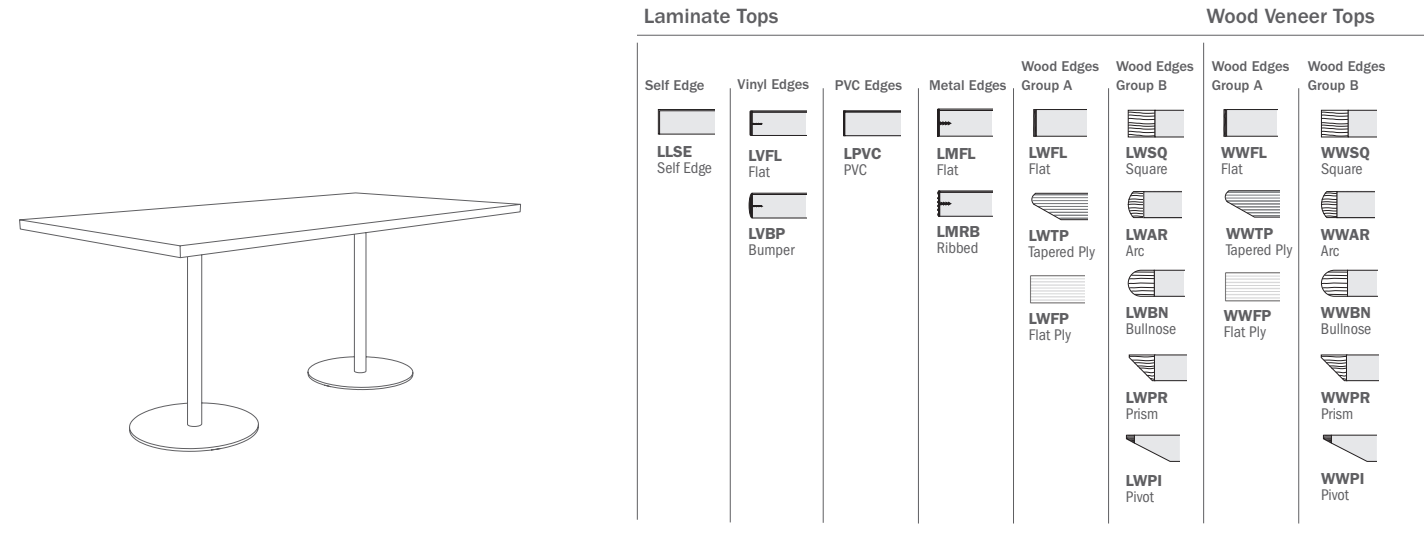

Laminate Tops

Wood Veneer Tops

Self Edge LLSE Self Edge	Vinyl Edges LVFL Flat LVBP Bumper	PVC Edges LPVC PVC	Metal Edges LMFL Flat LMRB Ribbed	Wood Edges Group A LWFL Flat LWTP Tapered Ply LWFP Flat Ply	Wood Edges Group B LWSQ Square LWAR Arc LWBN Bullnose LWPR Prism LWPI Pivot	Wood Edges Group A WWFL Flat WWTP Tapered Ply WWBN Bullnose WWPR Prism WWPI Pivot	Wood Edges Group B WWSQ Square WWAR Arc WWBN Bullnose WWPR Prism WWPI Pivot
---------------------------------------	--	---------------------------------	--	--	--	--	--

Specialty Tops

Butcher Block BBFL Flat BBBN Bullnose	Ultrafoam ULFP PVC ULFR Raw	Acrylic AAOP Opaque AATL Translucent	Corian Group A,B C1FL Flat C1BN Bullnose C1PR Prism	Corian Group C,D C2FL Flat C2BN Bullnose C2PR Prism	3form Chroma 3FFL Flat 3FBN Bullnose 3FPR Prism
--	--	---	--	--	--

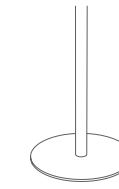

Options

Base Finishes		
Standard Powder Coat	use finish code	n/c
Polished or Satin Chrome (per base)	use finish code	\$213
Premium Plated (per base)	use finish code	\$363
Custom Powder Coat (set-up charge)	CPC	\$363

Base Options		
Alternate Height Base (per column)	AH	\$66
Nylon Octagon Glides (per base)	GNO	\$34
Custom Top Plate Size	CTPS	\$
6" Column (black wrinkle and powder coat)	COL6	\$194
6" Column (polished or satin chrome)	COLP6	\$248
6" Column (premium plated)	COLPP6	\$
6" Column (venerer)	COLV6	\$386

Top Materials and Finishes		
Standard Laminates	use manufacturers finish code	n/c
Premium Laminates	PL	\$
Custom Wood Veneer	CWV	\$
Special Pattern Veneer	SPV	\$
Stain to Match (set-up charge)	STM	\$412

Top Options		
Custom Size	CS	\$
Custom Shape	CSH	\$
Custom Radius Corner	CRC	\$
3" Radius Corner (per corner)	CRL3	\$34
(laminate self edge, ultrafoam, Corian®, 3form chroma)		
3" Wood Radius Corner (per corner)	CRW3	\$82
(not available in LWFL, WWFL, LWPI and WWPI)		

Grommets		
2" Round Metal Grommet - Matte Black	GMBK	\$138
2" Round Metal Grommet - Satin Chrome	GMSC	\$138
2" Round Metal Grommet - Polished Chrome	GMPC	\$138
2" Round Plastic Grommet - Matte Black	GPMBK	\$44
Grommet location	use location code	n/c

Edge Options		
1.75" Thick Edge (per table)	175E	15%
(see edge details for specific profiles)		

Complete Table List Pricing

	Top Size	Base Qty.	Model #	\$							
Rectangle	36 42	1	DI3642RE	970	970	1,029	1,048	1,319	1,564	1,412	1,684
	36 48	1	DI3648RE	1,135	1,135	1,197	1,218	1,498	1,759	1,595	1,887
	36 60	2	DI3660RE	1,700	1,700	1,773	1,797	2,073	2,369	2,184	2,517
	36 72	2	DI3672RE	1,783	1,783	1,860	1,888	2,201	2,536	2,326	2,705
	36 84	2	DI3684RE	2,028	2,028	2,097	2,143	2,305	2,771	2,445	2,968
	36 96	2	DI3696RE	2,110	2,110	2,193	2,237	2,410	2,945	2,563	3,164
	42 72	2	DI4272RE	2,117	2,117	2,182	2,215	2,516	2,911	2,587	3,004
	42 84	2	DI4284RE	2,373	2,373	2,443	2,492	2,630	3,138	2,866	3,451
	42 96	2	DI4296RE	2,467	2,467	2,544	2,597	2,751	3,364	3,008	3,494
	48 96	2	DI4896RE	2,578	2,578	2,653	2,708	2,936	3,591	3,309	3,796
48 120	2	DI48120RE	2,790	2,790	2,888	2,955	3,179	3,817	3,613	4,101	
48 144	3	DI48144RE	3,755	3,755	3,850	3,930	4,175	4,821	4,677	5,212	
48 168	3	DI48168RE	3,983	3,983	4,083	4,175	4,406	5,103	4,967	5,538	
60 120	2	DI60120RE	3,051	3,051	3,143	3,224	3,399	4,043	3,817	4,441	
60 144	3	DI60144RE	4,051	4,051	4,154	4,251	4,518	5,103	5,107	5,629	
60 168	3	DI60168RE	4,360	4,360	4,433	4,545	4,801	5,727	5,461	6,406	
Arc Rectangle	30 60	2	DI3060AR	1,328	1,328	1,383	1,405	1,662	1,975	1,798	2,119
	30 72	2	DI3072AR	1,419	1,419	1,469	1,494	1,776	2,173	1,884	2,247
	30 84	2	DI3084AR	1,597	1,597	1,678	1,718	1,866	2,315	1,992	2,551
	30 96	2	DI3096AR	1,670	1,670	1,757	1,800	1,975	2,512	2,092	2,755
	36 60	2	DI3660AR	1,733	1,733	1,775	1,797	2,073	2,435	2,184	2,540
	36 72	2	DI3672AR	1,836	1,836	1,884	1,910	2,198	2,606	2,326	2,719
	36 84	2	DI3684AR	2,015	2,015	2,100	2,141	2,305	2,775	2,445	2,974
	36 96	2	DI3696AR	2,100	2,100	2,193	2,233	2,412	3,029	2,567	3,178

Continued on next page

How to Order

Table Model Number				Top Finish Selection		Options	
DI Base Series	3642 Top Size	RE Top Shape	WWSQ Top Material Edge Profile	MBK Base Finish	WMW Top Finish	WMW Edge Finish	GMBK Matte Black Grommet
							E Location "E"
A DI3642REWWSQMBK is a Disc series 36" x 42" rectangle table with a black powder coat round base and a wood veneer 1.25" thick top with a 1.25" square wood edge profile.				The codes: WMW WMW specify a medium walnut top, with a medium walnut edge.		The code: GMBK specifies a matte black 2" diameter metal grommet.	
						The code: E specifies the location of the grommet.	

Laminate Tops				Wood Veneer Tops			
Self Edge	Vinyl Edges	PVC Edges	Metal Edges	Wood Edges Group A	Wood Edges Group B	Wood Edges Group A	Wood Edges Group B
LLSE Self Edge	LVFL Flat	LPVC PVC	LMFL Flat	LWFL Flat	LWSQ Square	WWFL Flat	WWSQ Square
	LVBP Bumper		LMRB Ribbed	LWTP Tapered Ply	LWAR Arc	WWTP Tapered Ply	WWAR Arc
				LWFP Flat Ply	LWBN Bullnose	WWFP Flat Ply	WWBN Bullnose
					LWPR Prism		WWPR Prism
					LWPI Pivot		WWPI Pivot

Butcher Block	Ultrafoam	Acrylic	Corian Group A,B	Corian Group C,D	3form Chroma
BBFL Flat	ULFP PVC	AAOP Opaque	C1FL Flat	C2FL Flat	3FFL Flat
BBBN Bullnose	ULFR Raw	AATL Translucent	C1BN Bullnose	C2BN Bullnose	3FBN Bullnose
			C1PR Prism	C2PR Prism	3FPR Prism

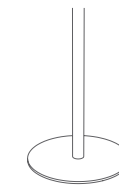

Options

Base Finishes	use finish code	n/c
Standard Powder Coat		n/c
Polished or Satin Chrome (per base)	use finish code	\$213
Premium Plated (per base)	use finish code	\$
Custom Powder Coat (set-up charge)	CPC	\$363

Complete Table List Pricing

Top Size	Base Qty.	Model #	\$								
Arc Rectangle	42 72	2	DI4272AR	1,982	1,982	2,004	2,040	2,266	2,712	2,337	3,001
	42 84	2	DI4284AR	2,110	2,110	2,193	2,237	2,353	2,974	2,616	3,262
	42 96	2	DI4296AR	2,207	2,207	2,294	2,342	2,493	3,172	2,758	3,511
	48 96	2	DI4896AR	2,600	2,600	2,654	2,704	2,936	3,648	3,309	3,875
	48 120	2	DI48120AR	2,774	2,774	2,893	2,955	3,179	3,988	3,613	4,270
	48 144	3	DI48144AR	3,734	3,734	3,856	3,930	4,216	5,076	4,728	5,502
	48 168	3	DI48168AR	3,956	3,956	4,083	4,167	4,461	5,556	5,037	5,905
	60 120	2	DI60120AR	3,037	3,037	3,182	3,259	3,422	4,298	3,842	4,644
	60 144	3	DI60144AR	4,043	4,043	4,187	4,278	4,597	5,443	4,901	6,114
	60 168	3	DI60168AR	4,319	4,319	4,465	4,570	4,885	5,840	5,224	6,504

\$						
-	-	-	-	-	-	-
-	-	-	-	-	-	-
-	-	-	-	-	-	-
-	-	-	-	-	-	-
-	-	-	-	-	-	-
-	-	-	-	-	-	-
-	-	-	-	-	-	-
-	-	-	-	-	-	-
-	-	-	-	-	-	-
-	-	-	-	-	-	-

Base Options		
Alternate Height Base (per column)	AH	\$66
Nylon Octagon Glides (per base)	GNO	\$34
Custom Top Plate Size	CTPS	\$
6" Column (black wrinkle and powder coat)	COL6	\$194
6" Column (polished or satin chrome)	COLP6	\$248
6" Column (premium plated)	COLPP6	\$
6" Column (veneer)	COLV6	\$386

Top Materials and Finishes		n/c
Standard Laminates	use manufacturers finish code	n/c
Premium Laminates	PL	\$
Custom Wood Veneer	CWV	\$
Special Pattern Veneer	SPV	\$
Stain to Match (set-up charge)	STM	\$412

Top Options		
Custom Size	CS	\$
Custom Shape	CSH	\$
Custom Radius Corner	CRC	\$
3" Radius Corner (per corner)	CRL3	\$34
(laminate self edge, ultrafoam, Corian®, 3form chroma)		
3" Wood Radius Corner (per corner)	CRW3	\$82
(not available in LWFL, WWFL, LWPI and WWPI)		

Grommets		
2" Round Metal Grommet - Matte Black	GMBK	\$138
2" Round Metal Grommet - Satin Chrome	GMSC	\$138
2" Round Metal Grommet - Polished Chrome	GMPC	\$138
2" Round Plastic Grommet - Matte Black	GPMBK	\$44
Grommet location	use location code	n/c

Edge Options		
1.75" Thick Edge (per table)	175E	15%
(see edge details for specific profiles)		

How to Order

Table Model Number				Top Finish Selection		Options	
DI Base Series	4272 Top Size	AR Top Shape	WWSQ Top Material Edge Profile	MBK Base Finish	WMW Top Finish	WMW Edge Finish	GMBK Matte Black Grommet
A DI4272ARWWSQMBK is a Disc series 42" x 72" arc rectangle table with two black powder coat round bases and a wood veneer 1.25" thick top with a 1.25" square wood edge profile.				The codes: WMW WMW specify a medium walnut top, with a medium walnut edge.		The code: GMBK specifies a matte black 2" diameter metal grommet.	
						The code: E specifies the location of the grommet.	



Laminate Tops

Self Edge	Vinyl Edges	PVC Edges	Metal Edges	Wood Edges Group A	Wood Edges Group B
LLSE Self Edge	LVFL Flat LVBP Bumper	LPVC PVC Edge	LMFL Flat LMRB Ribbed	LWFL Flat LWTP Tapered Ply LWFP Flat Ply	LWSQ Square LWAR Arc LWBN Bullnose LWPR Prism LWPI Pivot

Wood Veneer Tops

Wood Edges Group A	Wood Edges Group B
WWFL Flat WWTP Tapered Ply WWFP Flat Ply	WWSQ Square WWAR Arc WWBN Bullnose WWPR Prism WWPI Pivot

Specialty Tops

Butcher Block	Ultrafoam	Acrylic	Corian Group A,B	Corian Group C,D	3form Chroma
BBFL Flat BBBN Bullnose	ULFP PVC ULFR Raw	AAOP Opaque AATL Translucent	C1FL Flat C1BN Bullnose C1PR Prism	C2FL Flat C2BN Bullnose C2PR Prism	3FFL Flat 3FBN Bullnose 3FPR Prism

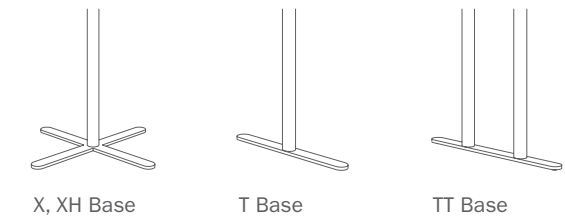

Options

Base Finishes		
Standard Powder Coat	use finish code	n/c
Polished or Satin Chrome (per base)	use finish code	\$213
Premium Plated (per base)	use finish code	Ⓛ
Custom Powder Coat (set-up charge)	CPC	\$363

Base Options		
Alternate Height Base (per column)	AH	\$66
Super Level Glides (per base)	GSL	\$34
Powder Coated Puck Style Glides (per base)	GPUPC	\$138
Polished or Satin Chrome Puck Style Glides (per base)	GPUPL	\$166
Locking Casters 2" Twin Wheel (qty. 4)	TWC2	\$56
Tilt-top - (standard cable release)	TMX/TMT	\$270 X-base/ \$418 T-base
Folding	FM	\$270 T-base

Top Materials and Finishes		
Standard Laminates	use manufacturers finish code	n/c
Premium Laminates	PRL	Ⓛ
Custom Wood Veneer	CWV	Ⓛ
Special Pattern Veneer	SPV	Ⓛ
Stain to Match (set-up charge)	STM	\$412

Top Options		
Custom Size	CS	Ⓛ
Custom Shape	CSH	Ⓛ
Custom Radius Corner	CRC	Ⓛ
3" Radius Corner (per corner)	CRL3	\$34
(laminate self edge, ultrafoam, Corian®, 3form chroma)		
3" Wood Radius Corner (per corner)	CRW3	\$82
(not available in LWFL, WWFL, LWPI and WWPI)		
Ganging Clips (1 set includes 2 male and 2 female clips)	GC	\$148

Grommets		
2" Round Metal Grommet - Matte Black	GMBK	\$138
2" Round Metal Grommet - Satin Chrome	GMSC	\$138
2" Round Metal Grommet - Polished Chrome	GMPC	\$138
2" Round Plastic Grommet - Matte Black	GPMBK	\$44
Grommet location	use location code	n/c

Edge Options		
1.75" Thick Edge (per table)	175E	15%

Modesty Panels		
Fixed Modesty Panel Laminate (48,60,72)	MODLFX	\$248
Fixed Modesty Panel Veneer (48,60,72)	MODVFX	\$386
Folding Modesty Panel Laminate (48,60,72)	MODLFL	\$330
Folding Modesty Veneer (48,60,72)	MODVFL	\$468

Wire Management		
J-Trough (horizontal mount) - Matte Black	WMJ	\$116
Legway Wire Manager (vertical mount) - Matte Black	WML	\$56

Data and Power		
Recessed Power and Data Module Two	DPBS2	\$396
Recessed Power and Data Module Four	DPBS4	\$688
Retractable Power and Data Module Two	DPAS2	\$606
Retractable Power and Data Module Three	DPAS3	\$688
Under Top Mounted Power and Data Module Two	DPUS2	\$358

Other		
Table Truck for Folding Tables	TRK	\$1512

Complete Table List Pricing

	Top Size	Base Qty.	Base Style	Model #	\$								
Round	24	1	X	DUX24RD	659	659	709	757	867	1,036	877	1,108	
	30	1	X	DUX30RD	787	787	849	882	1,048	1,229	1,048	1,316	
	36	1	X	DUX36RD	933	933	1,005	1,051	1,240	1,450	1,266	1,555	
	42	1	X	DUX42RD	1,034	1,034	1,114	1,114	1,356	1,614	1,450	1,740	
	48	1	X	DUX48RD	1,203	1,203	1,294	1,321	1,561	1,857	1,672	2,006	
	54	1	XH	DUX54RD	1,378	1,378	1,483	1,512	1,841	2,452	1,979	2,666	
	60	1	XH	DUXH60RD	1,555	1,555	1,668	1,722	1,961	2,535	2,320	2,761	
Oval	36	72	2	T	DUT3672OV	1,304	1,304	1,355	1,380	1,563	1,785	1,736	1,952
	42	54	2	T	DUT4254OV	1,281	1,281	1,308	1,372	1,513	1,840	1,664	1,900
	42	78	2	T	DUT4278OV	1,573	1,573	1,614	1,659	1,807	2,028	1,950	2,197
	42	84	2	T	DUT4284OV	1,629	1,629	1,683	1,727	1,857	2,108	2,003	2,287
	48	78	2	TT	DUTT4878OV	1,776	1,776	1,833	1,879	2,002	2,251	2,154	2,434
	48	96	2	TT	DUTT4896OV	1,952	1,952	2,008	2,058	2,150	2,422	2,512	2,829
Racetrack	30	60	2	T	DUT3060RA	1,073	1,073	1,131	1,153	1,443	1,721	1,544	1,889
	30	72	2	T	DUT3072RA	1,141	1,141	1,213	1,238	1,517	1,861	1,630	1,993
	30	84	2	T	DUT3084RA	1,371	1,371	1,435	1,476	1,614	2,100	1,740	2,297
	30	96	2	T	DUT3096RA	1,441	1,441	1,513	1,557	1,708	2,314	1,838	2,501
	36	60	2	T	DUT3660RA	1,203	1,203	1,271	1,293	1,563	1,870	1,674	2,030
	36	72	2	T	DUT3672RA	1,283	1,283	1,362	1,387	1,695	2,038	1,822	2,209
	36	84	2	T	DUT3684RA	1,520	1,520	1,599	1,641	1,795	2,265	1,939	2,489
	36	96	2	TT	DUTT3696RA	1,712	1,712	1,805	1,846	2,014	2,603	2,169	2,780
	42	72	2	TT	DUTT4272RA	1,479	1,479	1,553	1,584	1,868	2,263	1,939	2,547
	42	84	2	TT	DUTT4284RA	1,733	1,733	1,800	1,844	1,967	2,518	2,113	2,838
	42	96	2	TT	DUTT4296RA	1,829	1,829	1,898	1,947	2,090	2,716	2,253	3,113

Continued on next page

How to Order

Table Model Number					Top Finish Selection		Options
DUX Base Series	36 Top Size	RD Top Shape	WWSQ Top Material Edge Profile	MBK Base Finish	WMW Top Finish	WMW Edge Finish	AH Alternate Height Base
A DUX36RDWWSQMBK is a Dunhill series 36" round table with a black powder coat X-base and a wood veneer 1.25" thick top with a 1.25" square wood edge profile.					The codes: WMW WMW specify a medium walnut top, with a medium walnut edge.		The code: AH specifies alternate height base.

Laminate Tops				Wood Veneer Tops			
Self Edge	Vinyl Edges	PVC Edges	Metal Edges	Wood Edges Group A	Wood Edges Group B	Wood Edges Group A	Wood Edges Group B
LLSE Self Edge	LVFL Flat	LPVC PVC Edge	LMFL Flat	LWFL Flat	LWSQ Square	WWFL Flat	WWSQ Square
	LVBP Bumper		LMRB Ribbed	LWTP Tapered Ply	LWAR Arc	WWTP Tapered Ply	WWAR Arc
				LWFP Flat Ply	LWBN Bullnose	WWFP Flat Ply	WWBN Bullnose
					LWPR Prism		WWPR Prism
					LWPI Pivot		WWPI Pivot

Specialty Tops					
Butcher Block	Ultrafoam	Acrylic	Corian Group A,B	Corian Group C,D	3form Chroma
BBFL Flat	ULFP PVC	AAOP Opaque	C1FL Flat	C2FL Flat	3FFL Flat
BBBN Bullnose	ULFR Raw	AATL Translucent	C1BN Bullnose	C2BN Bullnose	3FBN Bullnose
			C1PR Prism	C2PR Prism	3FPR Prism

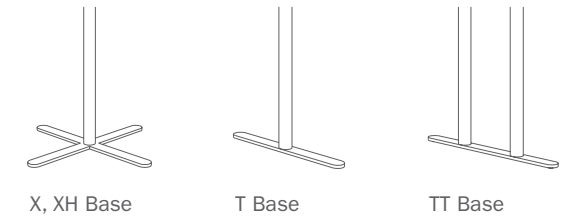

Options

Base Finishes		
Standard Powder Coat	use finish code	n/c
Polished or Satin Chrome (per base)	use finish code	\$213
Premium Plated (per base)	use finish code	Ⓛ
Custom Powder Coat (set-up charge)	CPC	\$363

Base Options		
Alternate Height Base (per column)	AH	\$66
Super Level Glides (per base)	GSL	\$34
Powder Coated Puck Style Glides (per base)	GPUPC	\$138
Polished or Satin Chrome Puck Style Glides (per base)	GPUL	\$166
Locking Casters 2" Twin Wheel (qty. 4)	TWC2	\$56
Tilt-top - (standard cable release)	TMX/TMT	\$270 X-base/ \$418 T-base
Folding	FM	\$270 T-base

Top Materials and Finishes		
Standard Laminates	use manufacturers finish code	n/c
Premium Laminates	PRL	Ⓛ
Custom Wood Veneer	CWV	Ⓛ
Special Pattern Veneer	SPV	Ⓛ
Stain to Match (set-up charge)	STM	\$412

Top Options		
Custom Size	CS	Ⓛ
Custom Shape	CSH	Ⓛ
Custom Radius Corner	CRC	Ⓛ
3" Radius Corner (per corner)	CRL3	\$34
(laminates self edge, ultrafoam, Corian®, 3form chroma)		
3" Wood Radius Corner (per corner)	CRW3	\$82
(not available in LWFL, WWFL, LWPI and WWPI)		
Ganging Clips (1 set includes 2 male and 2 female clips)	GC	\$148

Grommets		
2" Round Metal Grommet - Matte Black	GMBK	\$138
2" Round Metal Grommet - Satin Chrome	GMSC	\$138
2" Round Metal Grommet - Polished Chrome	GMPC	\$138
2" Round Plastic Grommet - Matte Black	GPMBK	\$44
Grommet location	use location code	n/c

Edge Options		
1.75" Thick Edge (per table)	175E	15%

Modesty Panels		
Fixed Modesty Panel Laminate (48,60,72)	MODLFX	\$248
Fixed Modesty Panel Veneer (48,60,72)	MODVFX	\$386
Folding Modesty Panel Laminate (48,60,72)	MODFL	\$330
Folding Modesty Veneer (48,60,72)	MODVFL	\$468

Wire Management		
J-Trough (horizontal mount) - Matte Black	WMJ	\$116
Legway Wire Manager (vertical mount) - Matte Black	WML	\$56

Data and Power		
Recessed Power and Data Module Two	DPBS2	\$396
Recessed Power and Data Module Four	DPBS4	\$688
Retractable Power and Data Module Two	DPAS2	\$606
Retractable Power and Data Module Three	DPAS3	\$688
Under Top Mounted Power and Data Module Two	DPUS2	\$358

Other		
Table Truck for Folding Tables	TRK	\$1512

Complete Table List Pricing

	Top Size	Base Qty.	Base Style	Model #	\$							
Racetrack	48 96	2	TT	DUTT4896RA	1,996	1,996	2,076	2,126	2,356	3,007	2,725	3,233
	48 120	2	TT	DUTT48120RA	2,208	2,208	2,309	2,371	2,599	3,346	3,029	3,686
	48 144	3	TT	DUTT48144RA	2,899	2,899	3,014	3,091	3,332	4,142	3,844	4,567
	48 168	3	TT	DUTT48168RA	3,114	3,114	3,237	3,324	3,583	4,511	4,159	4,993
Square	24 24	1	X	DUX2424SQ	659	659	715	769	867	1,036	877	1,108
	30 30	1	X	DUX3030SQ	787	787	855	902	1,048	1,229	1,048	1,316
	36 36	1	X	DUX3636SQ	933	933	1,001	1,070	1,230	1,450	1,266	1,555
	42 42	1	X	DUX4242SQ	1,088	1,088	1,164	1,213	1,422	1,680	1,516	1,806
Rectangle	48 48	1	X	DUX4848SQ	1,205	1,205	1,294	1,353	1,561	1,857	1,672	2,006
	18 48	2	T	DUT1848RE	813	813	864	879	982	1,231	1,048	1,259
	18 60	2	T	DUT1860RE	863	863	923	941	1,062	1,344	1,126	1,402
	18 72	2	T	DUT1872RE	910	910	976	997	1,146	1,458	1,214	1,544
	18 84	2	T	DUT1884RE	1,062	1,062	1,114	1,146	1,291	1,599	1,385	1,729
	18 96	2	T	DUT1896RE	1,146	1,146	1,193	1,231	1,348	1,712	1,447	1,834
	24 30	1	X	DUX2430RE	756	756	803	815	996	1,182	1,077	1,262
	24 36	1	X	DUX2436RE	851	851	903	917	1,125	1,306	1,191	1,394
	24 42	1	X	DUX2442RE	884	884	929	944	1,166	1,365	1,236	1,460
	24 48	1	X	DUX2448RE	919	919	975	993	1,238	1,460	1,318	1,565
	24 60	2	T	DUT2460RE	929	929	989	1,010	1,270	1,523	1,359	1,643
	24 72	2	T	DUT2472RE	987	987	1,057	1,081	1,367	1,657	1,470	1,795
	24 84	2	T	DUT2484RE	1,204	1,204	1,269	1,309	1,449	1,937	1,562	2,112
	24 96	2	T	DUT2496RE	1,262	1,262	1,333	1,377	1,531	2,058	1,653	2,248

Continued on next page

How to Order

Table Model Number					Top Finish Selection		Options
DUT	3672	RA	WWSQ	MBK	WMW	WMW	TWC2
Base Series	Top Size	Top Shape	Top Material Edge Profile	Base Finish	Top Finish	Edge Finish	Casters

A DUT3672RAWWSQMBK is a Dunhill series 36"x 72" racetrack table with two black powder coated T-bases and a wood veneer 1.25" thick top with a 1.25" square wood edge profile.

The codes: WMW WMW specify a medium walnut top, with a medium walnut edge.

The code: TWC2 specifies 2" twin wheel locking casters.

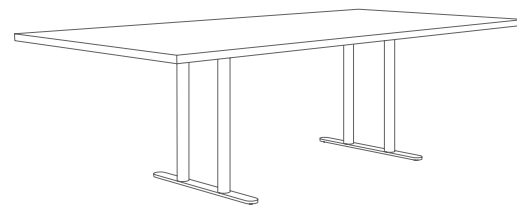

Laminate Tops

Self Edge	Vinyl Edges	PVC Edges	Metal Edges
LLSE Self Edge	LVFL Flat LVBP Bumper	LPVC PVC Edge	LMFL Flat LMRB Ribbed

Wood Veneer Tops

Wood Edges Group A	Wood Edges Group B	Wood Edges Group A	Wood Edges Group B
LWFL Flat LWTP Tapered Ply LWFP Flat Ply	LWSQ Square LWAR Arc LWBN Bullnose LWPR Prism LWPI Pivot	WWFL Flat WWTP Tapered Ply WWFP Flat Ply	WWSQ Square WWAR Arc WWBN Bullnose WWPR Prism WWPI Pivot

Specialty Tops

Butcher Block	Ultrafoam	Acrylic	Corian Group A,B	Corian Group C,D	3form Chroma
BBFL Flat BBBN Bullnose	ULFP PVC ULFR Raw	AAOP Opaque AATL Translucent	C1FL Flat C1BN Bullnose C1PR Prism	C2FL Flat C2BN Bullnose C2PR Prism	3FFL Flat 3FBN Bullnose 3FPR Prism

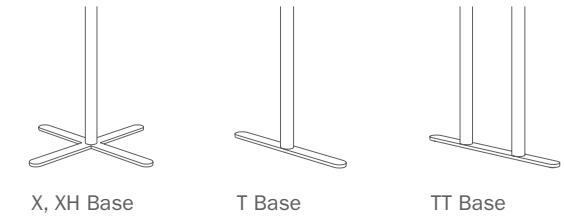

Options

Base Finishes		
Standard Powder Coat	use finish code	n/c
Polished or Satin Chrome (per base)	use finish code	\$213
Premium Plated (per base)	use finish code	\$
Custom Powder Coat (set-up charge)	CPC	\$363

Base Options		
Alternate Height Base (per column)	AH	\$66
Super Level Glides (per base)	GSL	\$34
Powder Coated Puck Style Glides (per base)	GPUPC	\$138
Polished or Satin Chrome Puck Style Glides (per base)	GPULC	\$166
Locking Casters 2" Twin Wheel (qty. 4)	TWC2	\$56
Tilt-top - (standard cable release)	TMX/TMT	\$270 X-base/ \$418 T-base
Folding	FM	\$270 T-base

Top Materials and Finishes		
Standard Laminates	use manufacturers finish code	n/c
Premium Laminates	PRL	\$
Custom Wood Veneer	CWV	\$
Special Pattern Veneer	SPV	\$
Stain to Match (set-up charge)	STM	\$412

Top Options		
Custom Size	CS	\$
Custom Shape	CSH	\$
Custom Radius Corner	CRC	\$
3" Radius Corner (per corner)	CRL3	\$34
(laminate self edge, ultrafoam, Corian®, 3form chroma)		
3" Wood Radius Corner (per corner)	CRW3	\$82
(not available in LWFL, WWFL, LWPI and WWPI)		
Ganging Clips (1 set includes 2 male and 2 female clips)	GC	\$148

Grommets		
2" Round Metal Grommet - Matte Black	GMBK	\$138
2" Round Metal Grommet - Satin Chrome	GMSC	\$138
2" Round Metal Grommet - Polished Chrome	GMPC	\$138
2" Round Plastic Grommet - Matte Black	GPMBK	\$44
Grommet location	use location code	n/c

Edge Options		
1.75" Thick Edge (per table)	175E	15%

Modesty Panels		
Fixed Modesty Panel Laminate (48,60,72)	MODLFX	\$248
Fixed Modesty Panel Veneer (48,60,72)	MODVFX	\$386
Folding Modesty Panel Laminate (48,60,72)	MODFL	\$330
Folding Modesty Veneer (48,60,72)	MODVFL	\$468

Wire Management		
J-Trough (horizontal mount) - Matte Black	WMJ	\$116
Legway Wire Manager (vertical mount) - Matte Black	WML	\$56

Data and Power		
Recessed Power and Data Module Two	DPBS2	\$396
Recessed Power and Data Module Four	DPBS4	\$688
Retractable Power and Data Module Two	DPAS2	\$606
Retractable Power and Data Module Three	DPAS3	\$688
Under Top Mounted Power and Data Module Two	DPUS2	\$358

Other		
Table Truck for Folding Tables	TRK	\$1512

Complete Table List Pricing

Top Size	Base Qty.	Base Style	Model #	\$									
Rectangle	30	36	1	X	DUX3036RE	896	896	941	956	1,178	1,376	1,250	1,472
	30	42	1	X	DUX3042RE	931	931	983	1,001	1,273	1,495	1,355	1,606
	30	48	1	X	DUX3048RE	1,034	1,034	1,090	1,110	1,384	1,625	1,475	1,744
	30	60	2	T	DUT3060RE	1,061	1,061	1,125	1,149	1,441	1,717	1,544	1,853
	30	72	2	T	DUT3072RE	1,129	1,129	1,206	1,233	1,517	1,830	1,631	1,980
	30	84	2	T	DUT3084RE	1,361	1,361	1,427	1,472	1,612	2,100	1,735	2,283
	30	96	2	T	DUT3096RE	1,431	1,431	1,504	1,552	1,707	2,273	1,843	2,478
	36	42	2	T	DUT3642RE	1,055	1,055	1,114	1,133	1,404	1,649	1,497	1,769
	36	48	2	T	DUT3648RE	1,095	1,095	1,157	1,178	1,458	1,719	1,555	1,847
	36	60	2	T	DUT3660RE	1,190	1,190	1,263	1,287	1,563	1,859	1,674	2,007
	36	72	2	T	DUT3672RE	1,273	1,273	1,350	1,378	1,691	2,026	1,816	2,195
	36	84	2	T	DUT3684RE	1,518	1,518	1,587	1,633	1,795	2,261	1,935	2,458
	36	96	2	TT	DUTT3696RE	1,712	1,712	1,795	1,839	2,012	2,547	2,165	2,766
	42	72	2	TT	DUTT4272RE	1,469	1,469	1,534	1,567	1,868	2,263	1,939	2,356
	42	84	2	TT	DUTT4284RE	1,725	1,725	1,795	1,844	1,982	2,490	2,218	2,803
	42	96	2	TT	DUTT4296RE	1,819	1,819	1,896	1,949	2,103	2,716	2,360	2,846
	48	96	2	TT	DUTT4896RE	1,994	1,994	2,069	2,124	2,352	3,007	2,725	3,212
	48	120	2	TT	DUTT48120RE	2,206	2,206	2,304	2,371	2,595	3,233	3,029	3,517
	48	144	3	TT	DUTT48144RE	2,879	2,879	2,974	3,054	3,299	3,945	3,801	4,336
	48	168	3	TT	DUTT48168RE	3,107	3,107	3,207	3,299	3,530	4,227	4,091	4,662
	60	120	2	TT	DUTT60120RE	2,467	2,467	2,559	2,640	2,815	3,459	3,233	3,857
	60	144	3	TT	DUTT60144RE	3,175	3,175	3,278	3,375	3,642	4,227	4,231	4,753
	60	168	3	TT	DUTT60168RE	3,484	3,484	3,557	3,669	3,925	4,851	4,585	5,530

Continued on next page

*T-bases can be specified on 30" x 42" and 30" x 48" rectangle tables, please refer to Base Only Pricing (pg. 231) and Top Only Pricing (pg. 231)

Top Only Pricing

X-bases are recommended for dining applications.

How to Order

Table Model Number					Top Finish Selection		Options	
DUT Base Series	3672 Top Size	RE Top Shape	WWSQ Top Material Edge Profile	MBK Base Finish	WMW Top Finish	WMW Edge Finish	GMBK Matte Black Grommet	E Location "E"
A DUT3672REWWSQMBK is a Dunhill series 36" x 72" rectangle table with two black powder coated T-bases and a wood veneer 1.25" thick top with a 1.25" square wood edge profile.					The codes: WMW WMW specify a medium walnut top, with a medium walnut edge.		The code: GMBK specifies a matte black 2" diameter metal grommet.	The code: E specifies the location of the grommet.

Laminate Tops				Wood Veneer Tops			
Self Edge	Vinyl Edges	PVC Edges	Metal Edges	Wood Edges Group A	Wood Edges Group B	Wood Edges Group A	Wood Edges Group B
LLSE Self Edge	LVFL Flat LVBP Bumper	LPVC PVC Edge	LMFL Flat LMRB Ribbed	LWFL Flat LWTP Tapered Ply LWFP Flat Ply	LWSQ Square LWAR Arc LWBN Bullnose LWPR Prism LWPI Pivot	WWFL Flat WWTP Tapered Ply WWFP Flat Ply	WWSQ Square WWAR Arc WWBN Bullnose WWPR Prism WWPI Pivot

Complete Table List Pricing

	Top Size	Base Qty.	Base Style	Model #	\$							
Half Round	24 48	2	T	DUT2448HR	875	875	925	941	1,065	1,318	1,128	1,365
	30 60	2	T	DUT3060HR	1,074	1,074	1,142	1,165	1,283	1,579	1,367	1,713
	36 72	2	T	DUT3672HR	1,289	1,289	1,370	1,396	1,513	1,870	1,721	1,983
Arc Rectangle	30 60	2	T	DUT3060AR	1,074	1,074	1,129	1,151	1,408	1,721	1,544	1,865
	30 72	2	T	DUT3072AR	1,165	1,165	1,215	1,240	1,522	1,919	1,630	1,993
	30 84	2	T	DUT3084AR	1,343	1,343	1,424	1,464	1,612	2,061	1,738	2,297
	30 96	2	T	DUT3096AR	1,416	1,416	1,503	1,546	1,721	2,258	1,838	2,501
	36 60	2	T	DUT3660AR	1,223	1,223	1,265	1,287	1,563	1,925	1,674	2,030
	36 72	2	T	DUT3672AR	1,326	1,326	1,374	1,400	1,688	2,096	1,816	2,209
	36 84	2	T	DUT3684AR	1,505	1,505	1,590	1,631	1,795	2,265	1,935	2,464
	36 96	2	TT	DUTT3696AR	1,702	1,702	1,795	1,835	2,014	2,631	2,169	2,780
	42 72	2	TT	DUTT4272AR	1,584	1,584	1,606	1,642	1,868	2,314	1,939	2,603
	42 84	2	TT	DUTT4284AR	1,712	1,712	1,795	1,839	1,955	2,576	2,218	2,864
	42 96	2	TT	DUTT4296AR	1,809	1,809	1,896	1,944	2,095	2,774	2,360	3,113
	48 96	2	TT	DUTT4896AR	2,016	2,016	2,070	2,120	2,352	3,064	2,725	3,291
	48 120	2	TT	DUTT48120AR	2,190	2,190	2,309	2,371	2,595	3,404	3,029	3,686
	48 144	3	TT	DUTT48144AR	2,858	2,858	2,980	3,054	3,340	4,200	3,852	4,626
	48 168	3	TT	DUTT48168AR	3,080	3,080	3,207	3,291	3,585	4,680	4,161	5,029

Continued on next page

How to Order

Table Model Number				Top Finish Selection		Options	
DUTT Base Series	4272 Top Size	AR Top Shape	WWSQ Top Material Edge Profile	MBK Base Finish	WMW Top Finish	WMW Edge Finish	GMBK Matte Black Grommet
A DUTT4272ARWWSQMBK is a Dunhill series 42" x 72" arc rectangle table with two black powder coated TT-bases and a wood veneer 1.25" thick top with a 1.25" square wood edge profile.				The codes: WMW WMW specify a medium walnut top, with a medium walnut edge.		The code: GMBK specifies a matte black 2" diameter metal grommet.	
						C Location "C"	
						The code: C specifies the location of the grommet.	

Butcher Block	Ultrafoam	Acrylic	Corian Group A,B	Corian Group C,D	3form Chroma
BBFL Flat BBBN Bullnose	ULFP PVC ULFR Raw	AAOP Opaque AATL Translucent	C1FL Flat C1BN Bullnose C1PR Prism	C2FL Flat C2BN Bullnose C2PR Prism	3FFL Flat 3FBN Bullnose 3FPR Prism

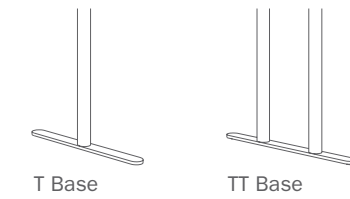

Options

Base Finishes		
Standard Powder Coat	use finish code	n/c
Polished or Satin Chrome (per base)	use finish code	\$213
Premium Plated (per base)	use finish code	\$
Custom Powder Coat (set-up charge)	CPC	\$363

Base Options		
Alternate Height Base (per column)	AH	\$66
Super Level Glides (per base)	GSL	\$34
Powder Coated Puck Style Glides (per base)	GPUPC	\$138
Polished or Satin Chrome Puck Style Glides (per base)	GPUPL	\$166
Locking Casters 2" Twin Wheel (qty. 4)	TWC2	\$56
Tilt-top - (standard cable release)	TMX/TMT	\$270 X-base/ \$418 T-base
Folding	FM	\$270 T-base

Top Materials and Finishes		
Standard Laminates	use manufacturers finish code	n/c
Premium Laminates	PRL	\$
Custom Wood Veneer	CWV	\$
Special Pattern Veneer	SPV	\$
Stain to Match (set-up charge)	STM	\$412

Top Options		
Custom Size	CS	\$
Custom Shape	CSH	\$
Custom Radius Corner	CRC	\$
3" Radius Corner (per corner)	CRL3	\$34
(laminate self edge, ultrafoam, Corian®, 3form chroma)		
3" Wood Radius Corner (per corner)	CRW3	\$82
(not available in LWFL, WWFL, LWPI and WWPI)		
Ganging Clips (1 set includes 2 male and 2 female clips)	GC	\$148

Grommets		
2" Round Metal Grommet - Matte Black	GMBK	\$138
2" Round Metal Grommet - Satin Chrome	GMSC	\$138
2" Round Metal Grommet - Polished Chrome	GMPC	\$138
2" Round Plastic Grommet - Matte Black	GPMBK	\$44
Grommet location	use location code	n/c

Edge Options		
1.75" Thick Edge (per table)	175E	15%

Modesty Panels		
Fixed Modesty Panel Laminate (48,60,72)	MODLFX	\$248
Fixed Modesty Panel Veneer (48,60,72)	MODVFX	\$386
Folding Modesty Panel Laminate (48,60,72)	MODFL	\$330
Folding Modesty Veneer (48,60,72)	MODVFL	\$468

Wire Management		
J-Trough (horizontal mount) - Matte Black	WMJ	\$116
Legway Wire Manager (vertical mount) - Matte Black	WML	\$56

Data and Power		
Recessed Power and Data Module Two	DPBS2	\$396
Recessed Power and Data Module Four	DPBS4	\$688
Retractable Power and Data Module Two	DPAS2	\$606
Retractable Power and Data Module Three	DPAS3	\$688
Under Top Mounted Power and Data Module Two	DPUS2	\$358

Other		
Table Truck for Folding Tables	TTRK	\$1512

Laminate Tops				Wood Veneer Tops			
Self Edge	Vinyl Edges	PVC Edges	Metal Edges	Wood Edges Group A	Wood Edges Group B	Wood Edges Group A	Wood Edges Group B
LLSE Self Edge	LVFL Flat	LPVC PVC Edge	LMFL Flat	LWFL Flat	LWSQ Square	WWFL Flat	WWSQ Square
	LVBP Bumper		LMRB Ribbed	LWTP Tapered Ply	LWAR Arc	WWTP Tapered Ply	WWAR Arc
				LWFP Flat Ply	LWBN Bullnose	WWFP Flat Ply	WWBN Bullnose
					LWPR Prism		WWPR Prism
					LWPI Pivot		WWPI Pivot

Complete Table List Pricing

	Top Size	Base Qty.	Base Style	Model #	\$							
Arc Rectangle	60 120	2	TT	DUTT60120AR	2,453	2,453	2,598	2,675	2,838	3,714	3,258	4,060
	60 144	3	TT	DUTT60144AR	3,167	3,167	3,311	3,402	3,721	4,567	4,025	5,238
	60 168	3	TT	DUTT60168AR	3,443	3,443	3,589	3,694	4,009	4,964	4,348	5,628
Boat Shape	36 42 72	2	T	DUTT3672BS	1,691	1,691	1,656	1,703	1,937	2,361	2,096	2,573
	36 48 84	2	TT	DUTT3684BS	1,918	1,918	1,983	2,039	2,344	2,739	2,539	2,986
	36 48 96	2	TT	DUTT3696BS	2,037	2,037	2,101	2,158	2,510	2,857	2,726	3,115
	36 48 120	2	TT	DUTT36120BS	2,274	2,274	2,351	2,422	2,893	3,126	3,157	3,418
	36 48 144	3	TT	DUTT36144BS	2,929	2,929	3,018	3,104	3,765	4,005	4,086	4,357
	36 48 168	3	TT	DUTT36168BS	3,155	3,155	3,267	3,365	4,100	4,226	4,464	4,606

How to Order

Table Model Number					Top Finish Selection		Options	
DUTT Base Series	364884 Top Size	BS Top Shape	WWSQ Top Material Edge Profile	MBK Base Finish	WMW Top Finish	WMW Edge Finish	GMBK Matte Black Grommet	G Location "G"
A DUTT364884BSWWSQMBK is a Dunhill series 36" x 48" X 84" boat shape table with two black powder coat TT-bases and a wood veneer 1.25" thick top with a 1.25" square wood edge profile.					The codes: WMW WMW specify a medium walnut top, with a medium walnut edge.		The code: GMBK specifies a matte black 2" diameter metal grommet.	The code: G specifies the location of the grommet.

Specialty Tops					
Butcher Block	Ultrafoam	Acrylic	Corian Group A,B	Corian Group C,D	3form Chroma
BBFL Flat	ULFP PVC	AAOP Opaque	C1FL Flat	C2FL Flat	3FFL Flat
BBBN Bullnose	ULFR Raw	AATL Translucent	C1BN Bullnose	C2BN Bullnose	3FBN Bullnose
			C1PR Prism	C2PR Prism	3FPR Prism

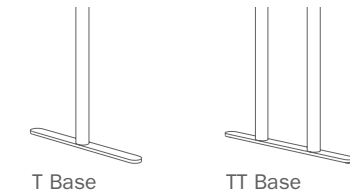

Options

Base Finishes		
Standard Powder Coat	use finish code	n/c
Polished or Satin Chrome (per base)	use finish code	\$213
Premium Plated (per base)	use finish code	\$
Custom Powder Coat (set-up charge)	CPC	\$363
Base Options		
Alternate Height Base (per column)	AH	\$66
Super Level Glides (per base)	GSL	\$34
Powder Coated Puck Style Glides (per base)	GPUPC	\$138
Polished or Satin Chrome Puck Style Glides (per base)	GPUPL	\$166
Locking Casters 2" Twin Wheel (qty. 4)	TWC2	\$56
Tilt-top - (standard cable release)	TMX/TMT	\$270 X-base/ \$418 T-base
Folding	FM	\$270 T-base

Top Materials and Finishes		
Standard Laminates	use manufacturers finish code	n/c
Premium Laminates	PRL	\$
Custom Wood Veneer	CWV	\$
Special Pattern Veneer	SPV	\$
Stain to Match (set-up charge)	STM	\$412

Top Options		
Custom Size	CS	\$
Custom Shape	CSH	\$
Custom Radius Corner	CRC	\$
3" Radius Corner (per corner)	CRL3	\$34
(laminate self edge, ultrafoam, Corian®, 3form chroma)		
3" Wood Radius Corner (per corner)	CRW3	\$82
(not available in LWFL, WWFL, LWPI and WWPI)		
Ganging Clips (1 set includes 2 male and 2 female clips)	GC	\$148

Grommets		
2" Round Metal Grommet - Matte Black	GMBK	\$138
2" Round Metal Grommet - Satin Chrome	GMSC	\$138
2" Round Metal Grommet - Polished Chrome	GMPC	\$138
2" Round Plastic Grommet - Matte Black	GPMBK	\$44
Grommet location	use location code	n/c

Edge Options		
1.75" Thick Edge (per table)	175E	15%

Modesty Panels		
Fixed Modesty Panel Laminate (48,60,72)	MODLFX	\$248
Fixed Modesty Panel Veneer (48,60,72)	MODVFX	\$386
Folding Modesty Panel Laminate (48,60,72)	MODLFL	\$330
Folding Modesty Veneer (48,60,72)	MODVFL	\$468

Wire Management		
J-Trough (horizontal mount) - Matte Black	WMJ	\$116
Legway Wire Manager (vertical mount) - Matte Black	WML	\$56

Data and Power		
Recessed Power and Data Module Two	DPBS2	\$396
Recessed Power and Data Module Four	DPBS4	\$688
Retractable Power and Data Module Two	DPAS2	\$606
Retractable Power and Data Module Three	DPAS3	\$688
Under Top Mounted Power and Data Module Two	DPUS2	\$358

Other		
Table Truck for Folding Tables	TRK	\$1512

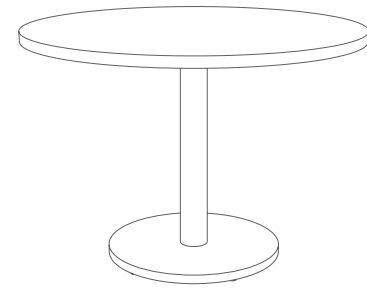

Laminate Tops				Wood Veneer Tops			
Self Edge	Vinyl Edges	PVC Edges	Metal Edges	Wood Edges Group A	Wood Edges Group B	Wood Edges Group A	Wood Edges Group B
LLSE Self Edge	LVFL Flat	LPVC PVC	LMFL Flat	LWFL Flat	LWSQ Square	WWFL Flat	WWSQ Square
	LVBP Bumper		LMRB Ribbed	LWTP Tapered Ply	LWAR Arc	WWTP Tapered Ply	WWAR Arc
				LWFP Flat Ply	LWBN Bullnose	WWFP Flat Ply	WWBN Bullnose
					LWPR Prism		WWPR Prism
					LWPI Pivot		WWPI Pivot

Specialty Tops				
Butcher Block	Ultrafoam	Acrylic	Corian Group A,B	Corian Group C,D
BBFL Flat	ULFP PVC	AAOP Opaque	C1FL Flat	C2FL Flat
BBBN Bullnose	ULFR Raw	AATL Translucent	C1BN Bullnose	C2BN Bullnose
			C1PR Prism	C2PR Prism
				3FFL Flat
				3FBN Bullnose
				3FPR Prism

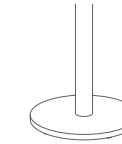

Options

Base Finishes		
Standard Powder Coat	use finish code	n/c
Polished or Satin Chrome (per base)	use finish code	\$194
Premium Plated (per base)	use finish code	Ⓢ
Custom Powder Coat (set-up charge)	CPC	\$363

Base Options		
Alternate Height Base (per column)	AH	\$66
Super Level Glides (per base)	GSL	\$34
Custom Top Plate Size	CTPS	Ⓢ
6" Column (black wrinkle and powder coat)	COL6	\$194
6" Column (polished or satin chrome)	COLP6	\$248
6" Column (premium plated)	COLPP6	Ⓢ
6" Column (veneer)	COLV6	\$386

Top Materials and Finishes		
Standard Laminates	use manufacturers finish code	n/c
Premium Laminates	PRL	Ⓢ
Custom Wood Veneer	CWV	Ⓢ
Special Pattern Veneer	SPV	Ⓢ
Stain to Match (set-up charge)	STM	\$412

Top Options		
Custom Size	CS	Ⓢ
Custom Shape	CSH	Ⓢ
Custom Radius Corner	CRC	Ⓢ
3" Radius Corner (per corner)	CRL3	\$34
(laminate self edge, ultrafoam, Corian®, 3form chroma)		
3" Wood Radius Corner (per corner)	CRW3	\$82
(not available in LWFL, WWFL, LWPI and WWPI)		

Grommets		
2" Round Metal Grommet - Matte Black	GMBK	\$138
2" Round Metal Grommet - Satin Chrome	GMSC	\$138
2" Round Metal Grommet - Polished Chrome	GMPC	\$138
2" Round Plastic Grommet - Matte Black	GPMBK	\$44
Grommet location	use location code	n/c

Edge Options		
1.75" Thick Edge (per table)	175E	15%
(see edge details for specific profiles)		

Complete Table List Pricing

	Top Size	Base Qty.	Model #	\$							
Round	24	1	FR24RD	559	559	609	657	767	936	777	1,008
	30	1	FR30RD	619	619	681	714	880	1,061	880	1,148
	36	1	FR36RD	699	699	771	817	1,006	1,216	1,032	1,321
	42	1	FR42RD	920	920	1,000	1,000	1,242	1,500	1,336	1,626
	48	1	FR48RD	1,023	1,023	1,114	1,141	1,381	1,677	1,492	1,826
	54	1	FR54RD	1,134	1,134	1,239	1,268	1,597	2,208	1,735	2,422
	60	1	FR60RD	1,411	1,411	1,524	1,578	1,817	2,391	2,176	2,617
Oval	36	72	FR3672OV	1,364	1,364	1,415	1,440	1,623	1,845	1,796	2,012
	42	54	FR4254OV	1,341	1,341	1,368	1,432	1,573	1,900	1,724	1,960
	42	78	FR4278OV	1,873	1,873	1,914	1,959	2,107	2,328	2,250	2,497
	42	84	FR4284OV	1,929	1,929	1,983	2,027	2,157	2,408	2,303	2,587
	48	78	FR4878OV	2,164	2,164	2,221	2,267	2,390	2,639	2,542	2,822
	48	96	FR4896OV	2,340	2,340	2,396	2,446	2,538	2,810	2,900	3,217
Racetrack	30	60	FR3060RA	1,197	1,197	1,255	1,277	1,567	1,845	1,668	2,013
	30	72	FR3072RA	1,265	1,265	1,337	1,362	1,641	1,985	1,754	2,117
	30	84	FR3084RA	1,495	1,495	1,559	1,600	1,738	2,224	1,864	2,421
	30	96	FR3096RA	1,565	1,565	1,637	1,681	1,832	2,438	1,962	2,625
	36	60	FR3660RA	1,263	1,263	1,331	1,353	1,623	1,930	1,734	2,090
	36	72	FR3672RA	1,343	1,343	1,422	1,447	1,755	2,098	1,882	2,269
	36	84	FR3684RA	1,580	1,580	1,659	1,701	1,855	2,325	1,999	2,549
	36	96	FR3696RA	1,660	1,660	1,753	1,794	1,962	2,551	2,117	2,728
	42	72	FR4272RA	1,667	1,667	1,741	1,772	2,056	2,451	2,127	2,735
	42	84	FR4284RA	1,921	1,921	1,988	2,032	2,155	2,706	2,301	3,026
	42	96	FR4296RA	2,017	2,017	2,086	2,135	2,278	2,904	2,441	3,301

Continued on next page

How to Order

Table Model Number				Top Finish Selection		Options
FR	36	RD	WWSQ	MBK	WMW	GSL
Base Series	Top Size	Top Shape	Top Material Edge Profile	Base Finish	Top Finish Edge Finish	Super Level Glides
A FR36RDWWSQMBK is a Flat Round series 36" round table with a black powder coat round base and a wood veneer 1.25" thick top with a 1.25" square wood edge profile.				The codes: WMW WMW specify a medium walnut top, with a medium walnut edge.		The code: GSL specifies super level glides.

Laminate Tops				Wood Veneer Tops			
Self Edge	Vinyl Edges	PVC Edges	Metal Edges	Wood Edges Group A	Wood Edges Group B	Wood Edges Group A	Wood Edges Group B
LLSE Self Edge	LVFL Flat	LPVC PVC	LMFL Flat	LWFL Flat	LWSQ Square	WWFL Flat	WWSQ Square
	LVBP Bumper		LMRB Ribbed	LWTP Tapered Ply	LWAR Arc	WWTP Tapered Ply	WWAR Arc
				LWFP Flat Ply	LWBN Bullnose	WWFP Flat Ply	WWBN Bullnose
					LWPR Prism		WWPR Prism
					LWPI Pivot		WWPI Pivot

Butcher Block	Ultrafoam	Acrylic	Corian Group A,B	Corian Group C,D	3form Chroma
BBFL Flat	ULFP PVC	AAOP Opaque	C1FL Flat	C2FL Flat	3FFL Flat
BBBN Bullnose	ULFR Raw	AATL Translucent	C1BN Bullnose	C2BN Bullnose	3FBN Bullnose
			C1PR Prism	C2PR Prism	3FPR Prism

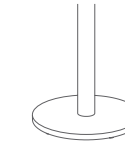

Options

Base Finishes		
Standard Powder Coat	use finish code	n/c
Polished or Satin Chrome (per base)	use finish code	\$194
Premium Plated (per base)	use finish code	\$
Custom Powder Coat (set-up charge)	CPC	\$363

Base Options		
Alternate Height Base (per column)	AH	\$66
Super Level Glides (per base)	GSL	\$34
Custom Top Plate Size	CTPS	\$
6" Column (black wrinkle and powder coat)	COL6	\$194
6" Column (polished or satin chrome)	COLP6	\$248
6" Column (premium plated)	COLPP6	\$
6" Column (veneer)	COLV6	\$386

Top Materials and Finishes		
Standard Laminates	use manufacturers finish code	n/c
Premium Laminates	PRL	\$
Custom Wood Veneer	CWV	\$
Special Pattern Veneer	SPV	\$
Stain to Match (set-up charge)	STM	\$412

Top Options		
Custom Size	CS	\$
Custom Shape	CSH	\$
Custom Radius Corner	CRC	\$
3" Radius Corner (per corner)	CRL3	\$34
(laminate self edge, ultrafoam, Corian®, 3form chroma)		
3" Wood Radius Corner (per corner)	CRW3	\$82
(not available in LWFL, WWFL, LWPI and WWPI)		

Grommets		
2" Round Metal Grommet - Matte Black	GMBK	\$138
2" Round Metal Grommet - Satin Chrome	GMSC	\$138
2" Round Metal Grommet - Polished Chrome	GMPC	\$138
2" Round Plastic Grommet - Matte Black	GPMBK	\$44
Grommet location	use location code	n/c

Edge Options		
1.75" Thick Edge (per table)	175E	15%
(see edge details for specific profiles)		

Complete Table List Pricing

	Top Size	Base Qty.	Model #	\$							
Racetrack	48 96	2	FR4896RA	2,120	2,120	2,200	2,250	2,480	3,131	2,849	3,357
	48 120	2	FR48120RA	2,332	2,332	2,433	2,495	2,723	3,470	3,153	3,810
	48 144	3	FR48144RA	3,085	3,085	3,200	3,277	3,518	4,328	4,030	4,753
	48 168	3	FR48168RA	3,300	3,300	3,423	3,510	3,769	4,697	4,345	5,179
Square	60 120	2	FR60120RA	2,804	2,804	2,913	2,989	3,104	4,010	3,553	4,407
	60 144	3	FR60144RA	3,709	3,709	3,810	3,902	4,157	4,997	4,489	5,466
	60 168	3	FR60168RA	3,974	3,974	4,085	4,190	4,451	5,392	5,123	6,242
Rectangle	24 24	1	FR2424SQ	559	559	615	669	767	936	777	1,008
	30 30	1	FR3030SQ	619	619	687	734	880	1,061	880	1,148
	36 36	1	FR3636SQ	699	699	767	836	996	1,216	1,032	1,321
	42 42	1	FR4242SQ	908	908	984	1,033	1,242	1,500	1,336	1,626
	48 48	1	FR4848SQ	1,125	1,125	1,214	1,273	1,481	1,777	1,592	1,926
Rectangle	24 30	1	FR2430RE	588	588	635	647	828	1,014	909	1,094
	24 36	1	FR2436RE	617	617	669	683	891	1,072	957	1,160
	24 42	1	FR2442RE	770	770	815	830	1,052	1,251	1,122	1,346
	24 48	1	FR2448RE	805	805	861	879	1,124	1,346	1,204	1,451
	24 60	2	FR2460RE	1,117	1,117	1,177	1,198	1,458	1,711	1,547	1,831
	24 72	2	FR2472RE	1,175	1,175	1,245	1,269	1,555	1,845	1,658	1,983
	24 84	2	FR2484RE	1,392	1,392	1,457	1,497	1,637	2,125	1,750	2,300
	24 96	2	FR2496RE	1,450	1,450	1,521	1,565	1,719	2,246	1,841	2,436
	30 36	1	FR3036RE	662	662	707	722	944	1,142	1,016	1,238
	30 42	1	FR3042RE	817	817	869	887	1,159	1,381	1,241	1,492
	30 48	1	FR3048RE	854	854	910	930	1,204	1,445	1,295	1,564
	30 60	2	FR3060RE	1,185	1,185	1,249	1,273	1,565	1,841	1,668	1,977
	30 72	2	FR3072RE	1,253	1,253	1,330	1,357	1,641	1,954	1,755	2,104
	30 84	2	FR3084RE	1,485	1,485	1,551	1,596	1,736	2,224	1,859	2,407
	30 96	2	FR3096RE	1,555	1,555	1,628	1,676	1,831	2,397	1,967	2,602

Continued on next page

How to Order

Table Model Number				Top Finish Selection		Options	
FR Base Series	4896 Top Size	RA Top Shape	WWSQ Top Material Edge Profile	MBK Base Finish	WMW Top Finish	WMW Edge Finish	GMBK Matte Black Grommet
A FR4896RAWWSQMBK is a Flat Round series 48" x 96" racetrack table with two black powder coat rounds bases and a wood veneer 1.25" thick top with a 1.25" square wood edge profile.				The codes: WMW WMW specify a medium walnut top, with a medium walnut edge.		The code: GMBK specifies a matte black 2" diameter metal grommet.	
						C Location "C"	
						The code: C specifies the location of the grommet.	

Laminate Tops				Wood Veneer Tops			
Self Edge	Vinyl Edges	PVC Edges	Metal Edges	Wood Edges Group A	Wood Edges Group B	Wood Edges Group A	Wood Edges Group B
LLSE Self Edge	LVFL Flat	LPVC PVC	LMFL Flat	LWFL Flat	LWSQ Square	WWFL Flat	WWSQ Square
	LVBP Bumper		LMRB Ribbed	LWTP Tapered Ply	LWAR Arc	WWTP Tapered Ply	WWAR Arc
				LWFP Flat Ply	LWBN Bullnose	WWBN Bullnose	WWBN Bullnose
					LWPR Prism	WWPR Prism	WWPR Prism
					LWPI Pivot	WWPI Pivot	WWPI Pivot

Complete Table List Pricing

	Top Size	Base Qty.	Model #	\$								
Rectangle	36	42	1	FR3642RE	865	865	924	943	1,214	1,459	1,307	1,579
	36	48	1	FR3648RE	905	905	967	988	1,268	1,529	1,365	1,657
	36	60	2	FR3660RE	1,250	1,250	1,323	1,347	1,623	1,919	1,734	2,067
	36	72	2	FR3672RE	1,333	1,333	1,410	1,438	1,751	2,086	1,876	2,255
	36	84	2	FR3684RE	1,578	1,578	1,647	1,693	1,855	2,321	1,995	2,518
	36	96	2	FR3696RE	1,660	1,660	1,743	1,787	1,960	2,495	2,113	2,714
	42	72	2	FR4272RE	1,657	1,657	1,722	1,755	2,056	2,451	2,127	2,544
	42	84	2	FR4284RE	1,913	1,913	1,983	2,032	2,170	2,678	2,406	2,991
	42	96	2	FR4296RE	2,007	2,007	2,084	2,137	2,291	2,904	2,548	3,034
	48	96	2	FR4896RE	2,118	2,118	2,193	2,248	2,476	3,131	2,849	3,336
48	120	2	FR48120RE	2,330	2,330	2,428	2,495	2,719	3,357	3,153	3,641	
48	144	3	FR48144RE	3,065	3,065	3,160	3,240	3,485	4,131	3,987	4,522	
48	168	3	FR48168RE	3,293	3,293	3,393	3,485	3,716	4,413	4,277	4,848	
60	120	2	FR60120RE	2,791	2,791	2,883	2,964	3,139	3,783	3,557	4,181	
60	144	3	FR60144RE	3,661	3,661	3,764	3,861	4,128	4,713	4,717	5,239	
60	168	3	FR60168RE	3,970	3,970	4,043	4,155	4,411	5,337	5,071	6,016	
Arc Rectangle	30	60	2	FR3060AR	1,198	1,198	1,253	1,275	1,532	1,845	1,668	1,989
	30	72	2	FR3072AR	1,289	1,289	1,339	1,364	1,646	2,043	1,754	2,117
	30	84	2	FR3084AR	1,467	1,467	1,548	1,588	1,736	2,185	1,862	2,421
	30	96	2	FR3096AR	1,540	1,540	1,627	1,670	1,845	2,382	1,962	2,625
	36	60	2	FR3660AR	1,283	1,283	1,325	1,347	1,623	1,985	1,734	2,090
	36	72	2	FR3672AR	1,386	1,386	1,434	1,460	1,748	2,156	1,876	2,269
	36	84	2	FR3684AR	1,565	1,565	1,650	1,691	1,855	2,325	1,995	2,524
	36	96	2	FR3696AR	1,650	1,650	1,743	1,783	1,962	2,579	2,117	2,728

Continued on next page

Specialty Tops					
Butcher Block	Ultrafoam	Acrylic	Corian Group A,B	Corian Group C,D	3form Chroma
BBFL Flat	ULFP PVC	AAOP Opaque	C1FL Flat	C2FL Flat	3FFL Flat
BBBN Bullnose	ULFR Raw	AATL Translucent	C1BN Bullnose	C2BN Bullnose	3FBN Bullnose
			C1PR Prism	C2PR Prism	3FPR Prism

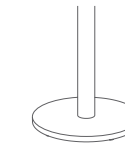

Options

Base Finishes		
Standard Powder Coat	use finish code	n/c
Polished or Satin Chrome (per base)	use finish code	\$194
Premium Plated (per base)	use finish code	\$
Custom Powder Coat (set-up charge)	CPC	\$363

Base Options		
Alternate Height Base (per column)	AH	\$66
Super Level Glides (per base)	GSL	\$34
Custom Top Plate Size	CTPS	\$
6" Column (black wrinkle and powder coat)	COL6	\$194
6" Column (polished or satin chrome)	COLP6	\$248
6" Column (premium plated)	COLPP6	\$
6" Column (veneer)	COLV6	\$386

Top Materials and Finishes		
Standard Laminates	use manufacturers finish code	n/c
Premium Laminates	PRL	\$
Custom Wood Veneer	CWV	\$
Special Pattern Veneer	SPV	\$
Stain to Match (set-up charge)	STM	\$412

Top Options		
Custom Size	CS	\$
Custom Shape	CSH	\$
Custom Radius Corner	CRC	\$
3" Radius Corner (per corner)	CRL3	\$34
(laminates self edge, ultrafoam, Corian®, 3form chroma)		
3" Wood Radius Corner (per corner)	CRW3	\$82
(not available in LWFL, WWFL, LWPI and WWPI)		

Grommets		
2" Round Metal Grommet - Matte Black	GMBK	\$138
2" Round Metal Grommet - Satin Chrome	GMSC	\$138
2" Round Metal Grommet - Polished Chrome	GMPC	\$138
2" Round Plastic Grommet - Matte Black	GPMBK	\$44
Grommet location	use location code	n/c

Edge Options		
1.75" Thick Edge (per table)	175E	15%
(see edge details for specific profiles)		

How to Order

Table Model Number				Top Finish Selection		Options		
FR	3642	RE	WWSQ	MBK	WMW	WMW	GMBK	G
Base Series	Top Size	Top Shape	Top Material Edge Profile	Base Finish	Top Finish	Edge Finish	Matte Black Grommet	Location "G"
A FR3642REWWSQMBK is a Flat Round series 36" x 42" rectangle table with a black powder coat round base and a wood veneer 1.25" thick top with a 1.25" square wood edge profile.					The codes: WMW WMW specify a medium walnut top, with a medium walnut edge.		The code: GMBK specifies a matte black 2" diameter metal grommet.	The code: G specifies the location of the grommet.

Laminate Tops				Wood Veneer Tops			
Self Edge	Vinyl Edges	PVC Edges	Metal Edges	Wood Edges Group A	Wood Edges Group B	Wood Edges Group A	Wood Edges Group B
LLSE Self Edge	LVFL Flat	LPVC PVC	LMFL Flat	LWFL Flat	LWSQ Square	WWFL Flat	WWSQ Square
	LVBP Bumper		LMRB Ribbed	LWTP Tapered Ply	LWAR Arc	WWTP Tapered Ply	WWAR Arc
				LWFP Flat Ply	LWBN Bullnose	WWFP Flat Ply	WWBN Bullnose
					LWPR Prism		WWPR Prism
					LWPI Pivot		WWPI Pivot

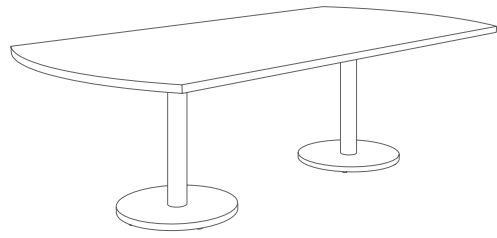

Specialty Tops				
Butcher Block	Ultrafoam	Acrylic	Corian Group A,B	Corian Group C,D
BBFL Flat	ULFP PVC	AAOP Opaque	C1FL Flat	C2FL Flat
BBBN Bullnose	ULFR Raw	AATL Translucent	C1BN Bullnose	C2BN Bullnose
			C1PR Prism	C2PR Prism
				3FFL Flat
				3FBN Bullnose
				3FPR Prism

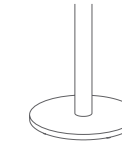

Complete Table List Pricing

	Top Size	Base Qty.	Model #	\$								
Arc Rectangle	42	72	2	FR4272AR	1,772	1,772	1,794	1,830	2,056	2,502	2,127	2,791
	42	84	2	FR4284AR	1,900	1,900	1,983	2,027	2,143	2,764	2,406	3,052
	42	96	2	FR4296AR	1,997	1,997	2,084	2,132	2,283	2,962	2,548	3,301
	48	96	2	FR4896AR	2,140	2,140	2,194	2,244	2,476	3,188	2,849	3,415
	48	120	2	FR48120AR	2,314	2,314	2,433	2,495	2,719	3,528	3,153	3,810
	48	144	3	FR48144AR	3,044	3,044	3,166	3,240	3,526	4,386	4,038	4,812
	48	168	3	FR48168AR	3,266	3,266	3,393	3,477	3,771	4,866	4,347	5,215
	60	120	2	FR60120AR	2,777	2,777	2,922	2,999	3,162	4,038	3,582	4,384
	60	144	3	FR60144AR	3,653	3,653	3,797	3,888	4,207	5,053	4,511	5,724
	60	168	3	FR60168AR	3,929	3,929	4,075	4,180	4,495	5,450	4,834	6,114



\$					
-	-	-	-	-	-
-	-	-	-	-	-
-	-	-	-	-	-
-	-	-	-	-	-
-	-	-	-	-	-
-	-	-	-	-	-
-	-	-	-	-	-
-	-	-	-	-	-
-	-	-	-	-	-

Options

Base Finishes		
Standard Powder Coat	use finish code	n/c
Polished or Satin Chrome (per base)	use finish code	\$194
Premium Plated (per base)	use finish code	\$
Custom Powder Coat (set-up charge)	CPC	\$363

Base Options		
Alternate Height Base (per column)	AH	\$66
Super Level Glides (per base)	GSL	\$34
Custom Top Plate Size	CTPS	\$
6" Column (black wrinkle and powder coat)	COL6	\$194
6" Column (polished or satin chrome)	COLP6	\$248
6" Column (premium plated)	COLPP6	\$
6" Column (veneer)	COLV6	\$386

Top Materials and Finishes		
Standard Laminates	use manufacturers finish code	n/c
Premium Laminates	PRL	\$
Custom Wood Veneer	CWV	\$
Special Pattern Veneer	SPV	\$
Stain to Match (set-up charge)	STM	\$412

Top Options		
Custom Size	CS	\$
Custom Shape	CSH	\$
Custom Radius Corner	CRC	\$
3" Radius Corner (per corner)	CRL3	\$34
(laminates self edge, ultrafoam, Corian®, 3form chroma)		
3" Wood Radius Corner (per corner)	CRW3	\$82
(not available in LWFL, WWFL, LWPI and WWPI)		

Grommets		
2" Round Metal Grommet - Matte Black	GMBK	\$138
2" Round Metal Grommet - Satin Chrome	GMSC	\$138
2" Round Metal Grommet - Polished Chrome	GMPC	\$138
2" Round Plastic Grommet - Matte Black	GPMBK	\$44
Grommet location	use location code	n/c

Edge Options		
1.75" Thick Edge (per table)	175E	15%
(see edge details for specific profiles)		

How to Order

Table Model Number				Top Finish Selection		Options	
FR Base Series	4272 Top Size	AR Top Shape	WWSQ Top Material Edge Profile	MBK Base Finish	WMW Top Finish	WMW Edge Finish	GMBK Matte Black Grommet
A FR4272ARWWSQMBK is a Flat Round series 42" x 72" arc rectangle table with two black powder coat round bases and a wood veneer 1.25" thick top with a 1.25" square wood edge profile.				The codes: WMW WMW specify a medium walnut top, with a medium walnut edge.		The code: GMBK specifies a matte black 2" diameter metal grommet.	
						The code: G specifies the location of the grommet.	

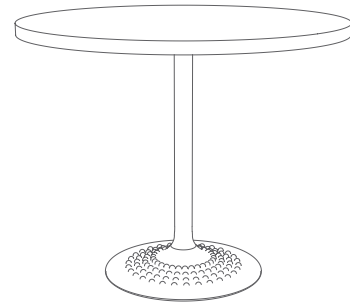

Laminate Tops				Wood Veneer Tops			
Self Edge	Vinyl Edges	PVC Edges	Metal Edges	Wood Edges Group A	Wood Edges Group B	Wood Edges Group A	Wood Edges Group B
LLSE Self Edge	LVFL Flat LVBP Bumper	LPVC PVC	LMFL Flat LMRB Ribbed	LWFL Flat LWTP Tapered Ply LWFP Flat Ply	LWSQ Square LWAR Arc LWBN Bullnose LWPR Prism LWPI Pivot	WWFL Flat WWTP Tapered Ply WWFP Flat Ply	WWSQ Square WWAR Arc WWBN Bullnose WWPR Prism WWPI Pivot

Specialty Tops					
Butcher Block	Ultrafoam	Acrylic	Corian Group A,B	Corian Group C,D	3form Chroma
BBFL Flat BBBN Bullnose	ULFP PVC ULFR Raw	AAOP Opaque AATL Translucent	C1FL Flat C1BN Bullnose C1PR Prism	C2FL Flat C2BN Bullnose C2PR Prism	3FFL Flat 3FBN Bullnose 3FPR Prism

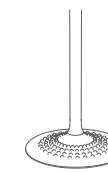

Options

Base Finishes		
Powder Coat	use finish code	n/c
Polished or Satin Chrome (per base)	use finish code	\$194
Premium Plated (per base)	use finish code	Ⓛ
Custom Powder Coat (set-up charge)	CPC	\$363

Base Options		
Alternate Height Base (per column)	AH	\$66
Super Level Glides (per base)	GSL	\$34
Custom Top Plate Size	CTPS	Ⓛ

Top Materials and Finishes		
Standard Laminates	use manufacturers finish code	n/c
Premium Laminates	PRL	Ⓛ
Custom Wood Veneer	CWV	Ⓛ
Special Pattern Veneer	SPV	Ⓛ
Stain to Match (set-up charge)	STM	\$412

Top Options		
Custom Size	CS	Ⓛ
Custom Shape	CSH	Ⓛ
Custom Radius Corner	CRC	Ⓛ
3" Radius Corner (per corner)	CRL3	\$34
3" Wood Radius Corner (per corner)	CRW3	\$82
(not available in LWFL, WWFL, LWPI and WWPI)		

Edge Options		
1.75" Thick Edge (per table)	175E	15%
(see edge details for specific profiles)		

Complete Table List Pricing

	Top Size	Base Qty.	Model #	\$							
Round	24	1	KN24RD	629	629	679	727	837	1,006	847	1,078
	30	1	KN30RD	719	719	781	814	980	1,161	980	1,248
	36	1	KN36RD	829	829	901	947	1,136	1,346	1,162	1,451
	42	1	KN42RD	960	960	1,040	1,040	1,282	1,540	1,376	1,666
	48	1	KN48RD	1,093	1,093	1,184	1,211	1,451	1,747	1,562	1,896
	54	1	KN54RD	1,244	1,244	1,349	1,378	1,707	2,318	1,845	2,532
60	1	KN60RD	1,421	1,421	1,534	1,588	1,827	2,401	2,186	2,627	
Square	24 24	1	KN2424SQ	629	629	685	739	837	1,006	847	1,078
	30 30	1	KN3030SQ	719	719	787	834	980	1,161	980	1,248
	36 36	1	KN3636SQ	829	829	897	966	1,126	1,346	1,162	1,451
	42 42	1	KN4242SQ	978	978	1,054	1,103	1,312	1,570	1,406	1,696
	48 48	1	KN4848SQ	1,135	1,135	1,224	1,283	1,491	1,787	1,602	1,936
Rectangle	24 30	1	KN2430RE	688	688	735	747	928	1,114	1,009	1,194
	24 36	1	KN2436RE	747	747	799	813	1,021	1,202	1,087	1,290
	24 42	1	KN2442RE	810	810	855	870	1,092	1,291	1,162	1,386
	24 48	1	KN2448RE	875	875	931	949	1,194	1,416	1,274	1,521
	30 36	1	KN3036RE	792	792	837	852	1,074	1,272	1,146	1,368
	30 42	1	KN3042RE	857	857	909	927	1,199	1,421	1,281	1,532
	30 48	1	KN3048RE	924	924	980	1,000	1,274	1,515	1,365	1,634
	36 42	1	KN3642RE	905	905	964	983	1,254	1,499	1,347	1,619
	36 48	1	KN3648RE	975	975	1,037	1,058	1,338	1,599	1,435	1,727

How to Order

Table Model Number					Top Finish Selection		Options
KN Base Series	36 Top Size	RD Top Shape	WWSQ Top Material Edge Profile	MBK Base Finish	WMW Top Finish	WMW Edge Finish	GSL Super Level Glides
A KN36RDWWSQMBK is a Knobhill series 36" round table with a black powder coat round base and a wood veneer 1.25" thick top with a 1.25" square wood edge profile.					The codes: WMW WMW specify a medium walnut top, with a medium walnut edge.		The code: GSL specifies super level glides.

Laminate Tops				Wood Veneer Tops			
Self Edge	Vinyl Edges	PVC Edges	Metal Edges	Wood Edges Group A	Wood Edges Group B	Wood Edges Group A	Wood Edges Group B
LLSE Self Edge	LVFL Flat	LPVC PVC	LMFL Flat	LWFL Flat	LWSQ Square	WWFL Flat	WWSQ Square
	LVBP Bumper		LMRB Ribbed	LWTP Tapered Ply	LWAR Arc	WWTP Tapered Ply	WWAR Arc
				LWFP Flat Ply	LWBN Bullnose	WWFP Flat Ply	WWBN Bullnose
					LWPR Prism		WWPR Prism
					LWPI Pivot		WWPI Pivot

Butcher Block	Ultrafoam	Acrylic	Corian Group A,B	Corian Group C,D	3form Chroma
BBFL Flat	ULFP PVC	AAOP Opaque	C1FL Flat	C2FL Flat	3FFL Flat
BBBN Bullnose	ULFR Raw	AATL Translucent	C1BN Bullnose	C2BN Bullnose	3FBN Bullnose
			C1PR Prism	C2PR Prism	3FPR Prism

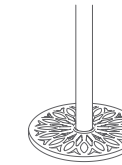

Complete Table List Pricing

	Top Size	Base Qty.	Model #	\$							
Round	24	1	MH24RD	439	439	489	537	647	816	657	888
	30	1	MH30RD	499	499	561	594	760	941	760	1,028
	36	1	MH36RD	629	629	701	747	936	1,146	962	1,251
	42	1	MH42RD	730	730	810	810	1,052	1,310	1,146	1,436
	48	1	MH48RD	933	933	1,024	1,051	1,291	1,587	1,402	1,736
	54	1	MH54RD	1,044	1,044	1,149	1,178	1,507	2,118	1,645	2,332
	60	1	MH60RD	1,221	1,221	1,334	1,388	1,627	2,201	1,986	2,427
Square	24 24	1	MH2424SQ	439	439	495	549	647	816	657	888
	30 30	1	MH3030SQ	499	499	567	614	760	941	760	1,028
	36 36	1	MH3636SQ	629	629	697	766	926	1,146	962	1,251
	42 42	1	MH4242SQ	718	718	794	843	1,052	1,310	1,146	1,436
	48 48	1	MH4848SQ	935	935	1,024	1,083	1,291	1,587	1,402	1,736
Rectangle	24 30	1	MH2430RE	468	468	515	527	708	894	789	974
	24 36	1	MH2436RE	547	547	599	613	821	1,002	887	1,090
	24 42	1	MH2442RE	580	580	625	640	862	1,061	932	1,156
	24 48	1	MH2448RE	615	615	671	689	934	1,156	1,014	1,261
	30 36	1	MH3036RE	592	592	637	652	874	1,072	946	1,168
	30 42	1	MH3042RE	627	627	679	697	969	1,191	1,051	1,302
	30 48	1	MH3048RE	664	664	720	740	1,014	1,255	1,105	1,374
	36 42	1	MH3642RE	675	675	734	753	1,024	1,269	1,117	1,389
	36 48	1	MH3648RE	815	815	877	898	1,178	1,439	1,275	1,567

\$					
804	458	1,049	964	1,141	1,553
1,050	532	1,507	1,236	1,500	2,553
1,407	672	2,018	1,634	1,992	3,513
1,932	784	2,669	2,025	2,502	4,649
2,307	999	3,625	2,569	3,172	6,053
-	1,129	4,728	3,053	3,801	-
-	1,275	5,942	3,604	4,516	-
874	472	1,051	879	1,032	1,520
1,143	532	1,512	1,131	1,359	2,508
1,525	672	2,025	1,516	1,835	3,461
2,117	773	2,677	1,885	2,309	4,585
2,523	1,001	3,635	2,415	2,960	5,992
991	491	1,263	995	1,178	2,102
1,175	576	1,597	1,158	1,374	2,479
1,369	612	1,722	1,269	1,522	2,815
1,424	652	1,907	1,383	1,671	3,148
1,345	625	1,817	1,321	1,588	2,986
1,590	667	2,060	1,459	1,769	3,424
1,650	710	2,309	1,611	1,963	3,852
1,804	722	-	1,839	2,016	4,021
1,970	871	2,812	2,267	2,351	4,627

Options

Base Finishes		use finish code	n/c
Powder Coat			n/c
Custom Powder Coat (set-up charge)		CPC	\$363
Base Options			
Alternate Height Base (per column)	AH		\$66
Super Level Glides (per base)	GSL		\$34
Custom Top Plate Size	CTPS		Ⓛ
Top Materials and Finishes		use manufacturers finish code	n/c
Standard Laminates			n/c
Premium Laminates	PRL		Ⓛ
Custom Wood Veneer	CWV		Ⓛ
Special Pattern Veneer	SPV		Ⓛ
Stain to Match (set-up charge)	STM		\$412
Top Options			
Custom Size	CS		Ⓛ
Custom Shape	CSH		Ⓛ
Custom Radius Corner	CRC		Ⓛ
3" Radius Corner (per corner)	CRL3		\$34
(laminite self edge, ultrafoam, Corian®, 3form chroma)			
3" Wood Radius Corner (per corner)	CRW3		\$82
(not available in LWFL, WWFL, LWPI and WWPI)			
Edge Options			
1.75" Thick Edge (per table)	175E		15%
(see edge details for specific profiles)			

How to Order

Table Model Number					Top Finish Selection		Options
MH Base Series	36 Top Size	RD Top Shape	WWSQ Top Material Edge Profile	MBK Base Finish	WMW Top Finish	WMW Edge Finish	GSL Super Level Glides
A MH36RDWWSQMBK is a Manhattan series 36" round table with a black powder coat round base and a wood veneer 1.25" thick top with a 1.25" square wood edge profile.					The codes: WMW WMW specify a medium walnut top, with a medium walnut edge.		The code: GSL specifies super level glides.

Laminate Tops				Wood Veneer Tops			
Self Edge	Vinyl Edges	PVC Edges	Metal Edges	Wood Edges Group A	Wood Edges Group B	Wood Edges Group A	Wood Edges Group B
LLSE Self Edge	LVFL Flat LVBP Bumper	LPVC PVC	LMFL Flat LMRB Ribbed	LWFL Flat LWTP Tapered Ply LWFP Flat Ply	LWSQ Square LWAR Arc LWBN Bullnose LWPR Prism LWPI Pivot	WWFL Flat WWTP Tapered Ply WWFP Flat Ply	WWSQ Square WWAR Arc WWBN Bullnose WWPR Prism WWPI Pivot

Specialty Tops					
Butcher Block	Ultrafoam	Acrylic	Corian Group A,B	Corian Group C,D	3form Chroma
BBFL Flat BBBN Bullnose	ULFP PVC ULFR Raw	AAOP Opaque AATL Translucent	C1FL Flat C1BN Bullnose C1PR Prism	C2FL Flat C2BN Bullnose C2PR Prism	3FFL Flat 3FBN Bullnose 3FPR Prism

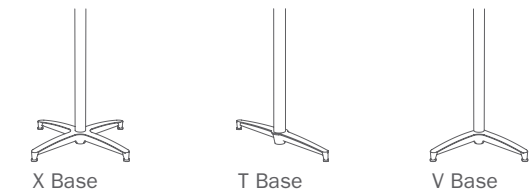

Options

Base Finishes		
Standard Powder Coat	use finish code	n/c
Polished or Satin Aluminum (per base)	use finish code	\$152
Custom Powder Coat (set-up charge)	CPC	\$363

Base Options		
Alternate Height Base (per column)	AH	\$66
Super Level Glides (per base)	GSL	\$34
Locking Casters 2" Twin Wheel (qty. 4)	TWC2	\$56
Tilt-top - (standard cable release)	TMX/TMT	\$270 X-base/ \$418 T-base
Folding	FM	\$270 T-base

Top Materials and Finishes		
Standard Laminates	use manufacturers finish code	n/c
Premium Laminates	PRL	Ⓢ
Custom Wood Veneer	CWV	Ⓢ
Special Pattern Veneer	SPV	Ⓢ
Stain to Match (set-up charge)	STM	\$412

Top Options		
Custom Size	CS	Ⓢ
Custom Shape	CSH	Ⓢ
Custom Radius Corner	CRC	Ⓢ
3" Radius Corner (per corner)	CRL3	\$34
(laminates self edge, ultrafoam, Corian®, 3form chroma)		
3" Wood Radius Corner (per corner)	CRW3	\$82
(not available in LWFL, WWFL, LWPI and WWPI)		
Ganging Clips (1 set includes 2 male and 2 female clips)	GC	\$148

Grommets		
2" Round Metal Grommet - Matte Black	GMBK	\$138
2" Round Metal Grommet - Satin Chrome	GMSC	\$138
2" Round Metal Grommet - Polished Chrome	GMPC	\$138
2" Round Plastic Grommet - Matte Black	GPMBK	\$44
Grommet location	use location code	n/c

Edge Options		
1.75" Thick Edge (per table)	175E	15%
(see edge details for specific profiles)		

Complete Table List Pricing

	Top Size	Base Qty.	Base Style	Model #	\$							
Round	30	1	X	MAX30RD	589	589	651	684	850	1,031	850	1,118
	36	1	X	MAX36RD	769	769	841	887	1,076	1,286	1,102	1,391
	42	1	X	MAX42RD	870	870	950	950	1,192	1,450	1,286	1,576
	48	1	X	MAX48RD	1,073	1,073	1,164	1,191	1,431	1,727	1,542	1,876
	54	1	X	MAX54RD	1,184	1,184	1,289	1,318	1,647	2,258	1,785	2,472
	60	1	X	MAX60RD	1,361	1,361	1,474	1,528	1,767	2,341	2,126	2,567
Oval	36 72	2	V	MAV3672OV	1,264	1,264	1,315	1,340	1,523	1,745	1,696	1,912
	42 54	2	T	MAT4254OV	1,331	1,331	1,358	1,422	1,563	1,890	1,714	1,950
	42 78	2	T	MAT4278OV	1,623	1,623	1,664	1,709	1,857	2,078	2,000	2,247
	42 84	2	T	MAT4284OV	1,679	1,679	1,733	1,777	1,907	2,158	2,053	2,337
	48 78	2	T	MAT4878OV	1,714	1,714	1,771	1,817	1,940	2,189	2,092	2,372
	48 96	2	T	MAT4896OV	1,890	1,890	1,946	1,996	2,088	2,360	2,450	2,767
Racetrack	30 60	2	V	MAV3060RA	1,097	1,097	1,155	1,177	1,467	1,745	1,568	1,913
	30 72	2	V	MAV3072RA	1,165	1,165	1,237	1,262	1,541	1,885	1,654	2,017
	30 84	2	V	MAV3084RA	1,395	1,395	1,459	1,500	1,638	2,124	1,764	2,321
	30 96	2	V	MAV3096RA	1,465	1,465	1,537	1,581	1,732	2,338	1,862	2,525
	36 60	2	V	MAV3660RA	1,163	1,163	1,231	1,253	1,523	1,830	1,634	1,990
	36 72	2	V	MAV3672RA	1,243	1,243	1,322	1,347	1,655	1,998	1,782	2,169
	36 84	2	V	MAV3684RA	1,480	1,480	1,559	1,601	1,755	2,225	1,899	2,449
	36 96	2	V	MAV3696RA	1,560	1,560	1,653	1,694	1,862	2,451	2,017	2,628
	42 72	2	T	MAT4272RA	1,417	1,417	1,491	1,522	1,806	2,201	1,877	2,485
	42 84	2	T	MAT4284RA	1,671	1,671	1,738	1,782	1,905	2,456	2,051	2,776
	42 96	2	T	MAT4296RA	1,767	1,767	1,836	1,885	2,028	2,654	2,191	3,051
	48 96	2	T	MAT4896RA	1,870	1,870	1,950	2,000	2,230	2,881	2,599	3,107

Continued on next page

How to Order

Table Model Number					Top Finish Selection		Options
MAX	36	RD	WWSQ	MBK	WMW	WMW	AH
Base Series	Top Size	Top Shape	Top Material Edge Profile	Base Finish	Top Finish	Edge Finish	Alternate Height Base
A MAX36RDWWSQMBK is a Mark IV series 36" round table with a black powder coat X-base and a wood veneer 1.25" thick top with a 1.25" square wood edge profile.					The codes: WMW WMW specify a medium walnut top, with a medium walnut edge.		The code: AH specifies alternate height base.

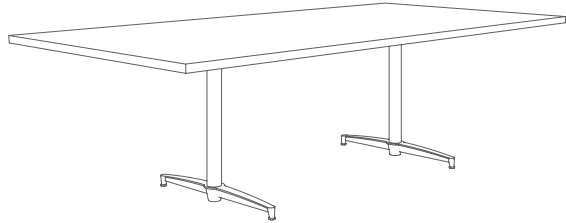

Laminate Tops

Self Edge	Vinyl Edges	PVC Edges	Metal Edges
LLSE Self Edge	LVFL Flat LVBP Bumper	LPVC PVC	LMFL Flat LMRB Ribbed

Wood Veneer Tops

Wood Edges Group A	Wood Edges Group B	Wood Edges Group A	Wood Edges Group B
LWFL Flat LWTP Tapered Ply LWFP Flat Ply	LWSQ Square LWAR Arc LWBN Bullnose LWPR Prism LWPI Pivot	WWFL Flat WWTP Tapered Ply WWFP Flat Ply	WWSQ Square WWAR Arc WWBN Bullnose WWPR Prism WWPI Pivot

Specialty Tops

Butcher Block	Ultrafoam	Acrylic	Corian Group A,B	Corian Group C,D	3form Chroma
BBFL Flat BBBN Bullnose	ULFP PVC ULFR Raw	AAOP Opaque AATL Translucent	C1FL Flat C1BN Bullnose C1PR Prism	C2FL Flat C2BN Bullnose C2PR Prism	3FFL Flat 3FBN Bullnose 3FPR Prism

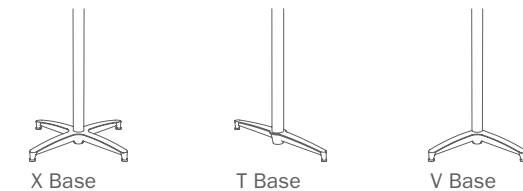

Options

Base Finishes	use finish code	n/c
Standard Powder Coat		n/c
Polished or Satin Aluminum (per base)	use finish code	\$152
Custom Powder Coat (set-up charge)	CPC	\$363

Base Options		
Alternate Height Base (per column)	AH	\$66
Super Level Glides (per base)	GSL	\$34
Locking Casters 2" Twin Wheel (qty. 4)	TWC2	\$56
Tilt-top - (standard cable release)	TMX/TMT	\$270 X-base/ \$418 T-base
Folding	FM	\$270 T-base

Top Materials and Finishes	use manufacturers finish code	n/c
Standard Laminates	PRL	Ⓛ
Premium Laminates	CWV	Ⓛ
Custom Wood Veneer	SPV	Ⓛ
Special Pattern Veneer	STM	\$412
Stain to Match (set-up charge)		

Top Options		
Custom Size	CS	Ⓛ
Custom Shape	CSH	Ⓛ
Custom Radius Corner	CRC	Ⓛ
3" Radius Corner (per corner)	CRL3	\$34
(laminate self edge, ultrafoam, Corian®, 3form chroma)		
3" Wood Radius Corner (per corner)	CRW3	\$82
(not available in LWFL, WWFL, LWPI and WWPI)		
Ganging Clips (1 set includes 2 male and 2 female clips)	GC	\$148

Grommets		
2" Round Metal Grommet - Matte Black	GMBK	\$138
2" Round Metal Grommet - Satin Chrome	GMSC	\$138
2" Round Metal Grommet - Polished Chrome	GMPC	\$138
2" Round Plastic Grommet - Matte Black	GPMBK	\$44
Grommet location	use location code	n/c

Edge Options		
1.75" Thick Edge (per table)	175E	15%
(see edge details for specific profiles)		

Complete Table List Pricing

	Top Size	Base Qty.	Base Style	Model #	\$							
Square	24 24	1	X	MAX2424SQ	529	529	585	639	737	906	747	978
	30 30	1	X	MAX3030SQ	589	589	657	704	850	1,031	850	1,118
	36 36	1	X	MAX3636SQ	769	769	837	906	1,066	1,286	1,102	1,391
	42 42	1	X	MAX4242SQ	958	958	1,034	1,083	1,292	1,550	1,386	1,676
	48 48	1	X	MAX4848SQ	1,075	1,075	1,164	1,223	1,431	1,727	1,542	1,876
Rectangle	18 48	2	T	MAT1848RE	791	791	842	857	960	1,209	1,026	1,237
	18 60	2	T	MAT1860RE	841	841	901	919	1,040	1,322	1,104	1,380
	18 72	2	T	MAT1872RE	888	888	954	975	1,124	1,436	1,192	1,522
	18 84	2	T	MAT1884RE	1,040	1,040	1,092	1,124	1,269	1,577	1,363	1,707
	18 96	2	T	MAT1896RE	1,124	1,124	1,171	1,209	1,326	1,690	1,425	1,812
	24 30	1	X	MAX2430RE	558	558	605	617	798	984	879	1,064
	24 36	1	X	MAX2436RE	687	687	739	753	961	1,142	1,027	1,230
	24 42	1	X	MAX2442RE	720	720	765	780	1,002	1,201	1,072	1,296
	24 48	2	T	MAT2448RE	845	845	901	919	1,164	1,386	1,244	1,491
	24 60	2	T	MAT2460RE	907	907	967	988	1,248	1,501	1,337	1,621
	24 72	2	T	MAT2472RE	965	965	1,035	1,059	1,345	1,635	1,448	1,773
	24 84	2	T	MAT2484RE	1,182	1,182	1,247	1,287	1,427	1,915	1,540	2,090
	24 96	2	T	MAT2496RE	1,240	1,240	1,311	1,355	1,509	2,036	1,631	2,226
	30 36	1	X	MAX3036RE	732	732	777	792	1,014	1,212	1,086	1,308
	30 42	1	X	MAX3042RE	767	767	819	837	1,109	1,331	1,191	1,442
	30 48	1	X	MAX3048RE	804	804	860	880	1,154	1,395	1,245	1,514
	30 60	2	V	MAV3060RE	1,085	1,085	1,149	1,173	1,465	1,741	1,568	1,877
	30 72	2	V	MAV3072RE	1,153	1,153	1,230	1,257	1,541	1,854	1,655	2,004
	30 84	2	V	MAV3084RE	1,385	1,385	1,451	1,496	1,636	2,124	1,759	2,307
	30 96	2	V	MAV3096RE	1,455	1,455	1,528	1,576	1,731	2,297	1,867	2,502

Continued on next page

How to Order

Table Model Number					Top Finish Selection		Options
MAT Base Series	2448 Top Size	RE Top Shape	WWSQ Top Material Edge Profile	MBK Base Finish	WMW Top Finish	WMW Edge Finish	TWC2 Casters
A MAT2448REWWSQMBK is a Mark IV series 24" x 48" rectangle table with two black powder coat T-bases and a wood veneer 1.25" thick top with a 1.25" square wood edge profile.					The codes: WMW WMW specify a medium walnut top, with a medium walnut edge.		The code: TWC2 specifies 2" twin wheel locking casters.

Laminate Tops

Wood Veneer Tops

Self Edge: LLSE Self Edge

Vinyl Edges: LVFL Flat, LVBP Bumper

PVC Edges: LPVC PVC

Metal Edges: LMLF Flat, LMRB Ribbed

Wood Edges Group A: LWFL Flat, LWTP Tapered Ply, LWFP Flat Ply

Wood Edges Group B: LWSQ Square, LWAR Arc, LWBN Bullnose, LWPR Prism, LWPI Pivot

Wood Edges Group A: WWFL Flat, WWTP Tapered Ply, WWFP Flat Ply

Wood Edges Group B: WWSQ Square, WWAR Arc, WWBN Bullnose, WWPR Prism, WWPI Pivot

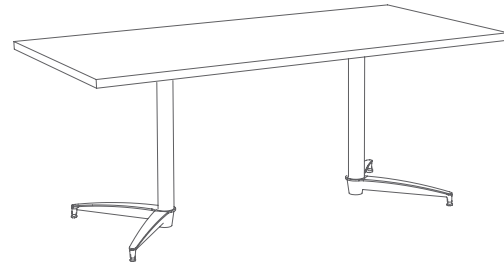

Specialty Tops

Butcher Block: BBFL Flat, BBBN Bullnose

Ultrafoam: ULFP PVC, ULFR Raw

Acrylic: AAOP Opaque, AATL Translucent

Corian Group A,B: C1FL Flat, C1BN Bullnose, C1PR Prism

Corian Group C,D: C2FL Flat, C2BN Bullnose, C2PR Prism

3form Chroma: 3FFL Flat, 3FBN Bullnose, 3FPR Prism

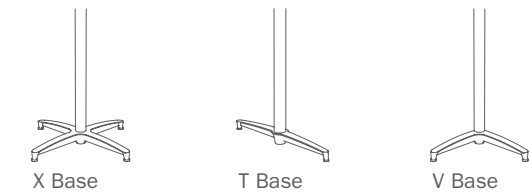

Complete Table List Pricing

	Top Size	Base Qty.	Base Style	Model #	\$							
Rectangle	36 42	1	X	MAX3642RE	915	915	974	993	1,264	1,509	1,357	1,629
	36 48	1	X	MAX3648RE	955	955	1,017	1,038	1,318	1,579	1,415	1,707
	36 60	2	V	MAV3660RE	1,150	1,150	1,223	1,247	1,523	1,819	1,634	1,967
	36 72	2	V	MAV3672RE	1,233	1,233	1,310	1,338	1,651	1,986	1,776	2,155
	36 84	2	V	MAV3684RE	1,478	1,478	1,547	1,593	1,755	2,221	1,895	2,418
	36 96	2	V	MAV3696RE	1,560	1,560	1,643	1,687	1,860	2,395	2,013	2,614
	42 72	2	T	MAT4272RE	1,407	1,407	1,472	1,505	1,806	2,201	1,877	2,294
	42 84	2	T	MAT4284RE	1,663	1,663	1,733	1,782	1,920	2,428	2,156	2,741
	42 96	2	T	MAT4296RE	1,757	1,757	1,834	1,887	2,041	2,654	2,298	2,784
Half Round	24 48	2	T	MAT2448HR	853	853	903	919	1,043	1,296	1,106	1,343
	30 60	2	T	MAT3060HR	988	988	1,056	1,079	1,197	1,493	1,281	1,627
	36 72	2	T	MAT3672HR	1,339	1,339	1,420	1,446	1,563	1,920	1,771	2,033
Arc Rectangle	30 60	2	V	MAV3060AR	1,098	1,098	1,153	1,175	1,432	1,745	1,568	1,889
	30 72	2	V	MAV3072AR	1,189	1,189	1,239	1,264	1,546	1,943	1,654	2,017
	30 84	2	V	MAV3084AR	1,367	1,367	1,448	1,488	1,636	2,085	1,762	2,321
	30 96	2	V	MAV3096AR	1,440	1,440	1,527	1,570	1,745	2,282	1,862	2,525
	36 60	2	V	MAV3660AR	1,183	1,183	1,225	1,247	1,523	1,885	1,634	1,990
	36 72	2	V	MAV3672AR	1,286	1,286	1,334	1,360	1,648	2,056	1,776	2,169
	36 84	2	V	MAV3684AR	1,465	1,465	1,550	1,591	1,755	2,225	1,895	2,424
	36 96	2	V	MAV3696AR	1,550	1,550	1,643	1,683	1,862	2,479	2,017	2,628

Continued on next page

\$					
2,044	962	-	2,079	2,256	4,261
2,110	1,011	2,952	2,407	2,491	4,767
2,556	1,216	3,920	2,529	3,048	5,908
2,908	1,311	4,503	2,856	3,474	6,894
3,258	1,531	5,719	-	-	-
3,603	1,628	6,055	-	-	-
-	1,494	-	-	-	-
-	1,726	-	-	-	-
-	1,837	6,892	-	-	-
-	1,958	-	-	-	-
-	-	-	-	-	-
-	-	-	-	-	-
-	-	-	-	-	-
-	-	-	-	-	-
-	-	-	-	-	-
-	-	-	-	-	-
-	-	-	-	-	-
-	-	-	-	-	-

Options

Base Finishes	use finish code	n/c
Standard Powder Coat	use finish code	\$152
Polished or Satin Aluminum (per base)	use finish code	\$363
Custom Powder Coat (set-up charge)	CPC	

Base Options		
Alternate Height Base (per column)	AH	\$66
Super Level Glides (per base)	GSL	\$34
Locking Casters 2" Twin Wheel (qty. 4)	TWC2	\$56
Tilt-top - (standard cable release)	TMX/TMT	\$270 X-base/ \$418 T-base
Folding	FM	\$270 T-base

Top Materials and Finishes	use manufacturers finish code	n/c
Standard Laminates	PRL	Ⓛ
Premium Laminates	CWV	Ⓛ
Custom Wood Veneer	SPV	Ⓛ
Special Pattern Veneer	STM	\$412
Stain to Match (set-up charge)		

Top Options		
Custom Size	CS	Ⓛ
Custom Shape	CSH	Ⓛ
Custom Radius Corner	CRC	Ⓛ
3" Radius Corner (per corner)	CRL3	\$34
(laminate self edge, ultrafoam, Corian®, 3form chroma)		
3" Wood Radius Corner (per corner)	CRW3	\$82
(not available in LWFL, WWFL, LWPI and WWPI)		
Ganging Clips (1 set includes 2 male and 2 female clips)	GC	\$148

Grommets		
2" Round Metal Grommet - Matte Black	GMBK	\$138
2" Round Metal Grommet - Satin Chrome	GMSC	\$138
2" Round Metal Grommet - Polished Chrome	GMPC	\$138
2" Round Plastic Grommet - Matte Black	GPMBK	\$44
Grommet location	use location code	n/c

Edge Options		
1.75" Thick Edge (per table)	175E	15%
(see edge details for specific profiles)		

How to Order

Table Model Number				Top Finish Selection		Options	
MAV Base Series	3672 Top Size	RE Top Shape	WWSQ Top Material Edge Profile	MBK Base Finish	WMW Top Finish	WMW Edge Finish	GMBK Matte Black Grommet
A MAV3672REWWSQMBK is a Mark IV series 36" x 72" rectangle table with two black powder coat V-bases and a wood veneer 1.25" thick top with a 1.25" square wood edge profile.					The codes: WMW WMW specify a medium walnut top, with a medium walnut edge.		The code: GMBK specifies a matte black 2" diameter metal grommet.
							The code: E specifies the location of the grommet.

Laminate Tops				Wood Veneer Tops			
Self Edge	Vinyl Edges	PVC Edges	Metal Edges	Wood Edges Group A	Wood Edges Group B	Wood Edges Group A	Wood Edges Group B
LLSE Self Edge	LVFL Flat	LPVC PVC	LMFL Flat	LWFL Flat	LWSQ Square	WWFL Flat	WWSQ Square
	LVBP Bumper		LMRB Ribbed	LWTP Tapered Ply	LWAR Arc	WWTP Tapered Ply	WWAR Arc
				LWFP Flat Ply	LWBN Bullnose	WWFP Flat Ply	WWBN Bullnose
					LWPR Prism		WWPR Prism
					LWPI Pivot		WWPI Pivot

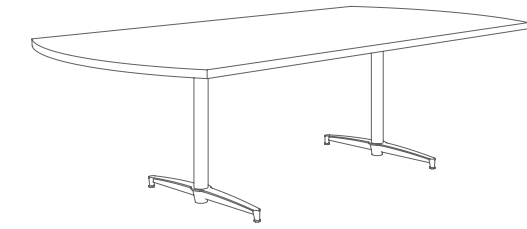

Specialty Tops				
Butcher Block	Ultrafoam	Acrylic	Corian Group A,B	Corian Group C,D
BBFL Flat	ULFP PVC	AAOP Opaque	C1FL Flat	C2FL Flat
BBBN Bullnose	ULFR Raw	AATL Translucent	C1BN Bullnose	C2BN Bullnose
			C1PR Prism	C2PR Prism
				3FPR Prism

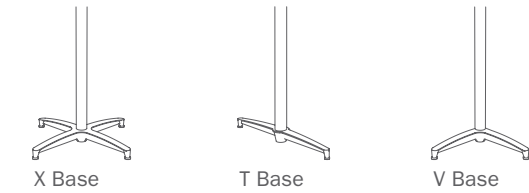

Complete Table List Pricing

	Top Size	Base Qty.	Base Style	Model #	\$							
Arc Rectangle	42 72	2	T	MAT4272AR	1,522	1,522	1,544	1,580	1,806	2,252	1,877	2,541
	42 84	2	T	MAT4284AR	1,650	1,650	1,733	1,777	1,893	2,514	2,156	2,802
	42 96	2	T	MAT4296AR	1,747	1,747	1,834	1,882	2,033	2,712	2,298	3,051
	48 96	2	T	MAT4896AR	1,890	1,890	1,944	1,994	2,226	2,938	2,599	3,165
Boat Shape	36 42 72	2	V	MAV3672BS	1,651	1,651	1,616	1,663	1,897	2,321	2,056	2,533
	36 48 84	2	T	MAT3684BS	1,856	1,856	1,921	1,977	2,282	2,677	2,477	2,924
	36 48 96	2	T	MAT3696BS	1,975	1,975	2,039	2,096	2,448	2,795	2,664	3,053

\$							
-	-	-	-	-	-	-	-
-	-	-	-	-	-	-	-
-	-	-	-	-	-	-	-
-	-	-	-	-	-	-	-

Options

Base Finishes		
Standard Powder Coat	use finish code	n/c
Polished or Satin Aluminum (per base)	use finish code	\$152
Custom Powder Coat (set-up charge)	CPC	\$363

Base Options		
Alternate Height Base (per column)	AH	\$66
Super Level Glides (per base)	GSL	\$34
Locking Casters 2" Twin Wheel (qty. 4)	TWC2	\$56
Tilt-top - (standard cable release)	TMX/TMT	\$270 X-base/ \$418 T-base
Folding	FM	\$270 T-base

Top Materials and Finishes		
Standard Laminates	use manufacturers finish code	n/c
Premium Laminates	PRL	Ⓛ
Custom Wood Veneer	CWV	Ⓛ
Special Pattern Veneer	SPV	Ⓛ
Stain to Match (set-up charge)	STM	\$412

Top Options		
Custom Size	CS	Ⓛ
Custom Shape	CSH	Ⓛ
Custom Radius Corner	CRC	Ⓛ
3" Radius Corner (per corner)	CRL3	\$34
(laminate self edge, ultrafoam, Corian®, 3form chroma)		
3" Wood Radius Corner (per corner)	CRW3	\$82
(not available in LWFL, WWFL, LWPI and WWPI)		
Ganging Clips (1 set includes 2 male and 2 female clips)	GC	\$148

Grommets		
2" Round Metal Grommet - Matte Black	GMBK	\$138
2" Round Metal Grommet - Satin Chrome	GMSC	\$138
2" Round Metal Grommet - Polished Chrome	GMPC	\$138
2" Round Plastic Grommet - Matte Black	GPMBK	\$44
Grommet location	use location code	n/c

Edge Options		
1.75" Thick Edge (per table)	175E	15%
(see edge details for specific profiles)		

How to Order

Table Model Number					Top Finish Selection		Options	
MAT Base Series	4296 Top Size	AR Top Shape	WWSQ Top Material Edge Profile	MBK Base Finish	WMW Top Finish	WMW Edge Finish	GMBK Matte Black Grommet	G Location "G"
A MAT4296ARWWSQMBK is a Mark IV series 42" x 96" arc rectangle table with two black powder coat T-bases and a wood veneer 1.25" thick top with a 1.25" square wood edge profile.					The codes: WMW WMW specify a medium walnut top, with a medium walnut edge.		The code: GMBK specifies a matte black 2" diameter metal grommet.	The code: G specifies the location of the grommet.

Laminate Tops				Wood Veneer Tops			
Self Edge	Vinyl Edges	PVC Edges	Metal Edges	Wood Edges Group A	Wood Edges Group B	Wood Edges Group A	Wood Edges Group B
LLSE Self Edge	LVFL Flat	LPVC PVC	LMFL Flat	LWFL Flat	LWSQ Square	WWFL Flat	WWSQ Square
	LVBP Bumper		LMRB Ribbed	LWTP Tapered Ply	LWAR Arc	WWTP Tapered Ply	WWAR Arc
				LWFP Flat Ply	LWBN Bullnose	WWFP Flat Ply	WWBN Bullnose
					LWPR Prism		WWPR Prism
					LWPI Pivot		WWPI Pivot

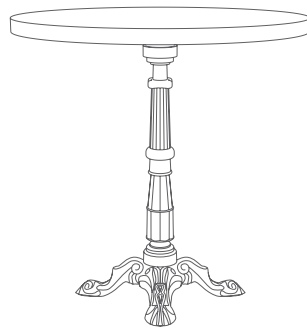

Complete Table List Pricing

	Top Size	Base Qty.	Model #	\$							
Round	24	1	ME24RD	489	489	539	588	697	866	707	938
	30	1	ME30RD	549	549	611	644	810	991	810	1,078
Square	24 24	1	ME2424SQ	490	490	545	600	697	866	707	938
	30 30	1	ME3030SQ	549	549	617	664	810	991	810	1,078
Rectangle	24 30	1	ME2430RE	518	518	566	578	759	944	839	1,025

Specialty Tops

Butcher Block	Ultrafoam	Acrylic	Corian Group A,B	Corian Group C,D	3form Chroma
BBFL Flat	ULFP PVC	AAOP Opaque	C1FL Flat	C2FL Flat	3FFL Flat
BBBN Bullnose	ULFR Raw	AATL Translucent	C1BN Bullnose	C2BN Bullnose	3FBN Bullnose
			C1PR Prism	C2PR Prism	3FPR Prism

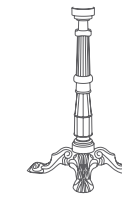

Options

Base Finishes		
Standard Powder Coat	use finish code	n/c
Custom Powder Coat (set-up charge)	CPC	\$363
Base Options		
Alternate Height Base (per column)	AH	\$166
Super Level Glides (per base)	GSL	\$34
Custom Top Plate Size	CTPS	Ⓛ
Top Materials and Finishes		
Standard Laminates	use manufacturers finish code	n/c
Premium Laminates	PRL	Ⓛ
Custom Wood Veneer	CWV	Ⓛ
Special Pattern Veneer	SPV	Ⓛ
Stain to Match (set-up charge)	STM	\$412
Top Options		
Custom Size	CS	Ⓛ
Custom Shape	CSH	Ⓛ
Custom Radius Corner	CRC	Ⓛ
3" Radius Corner (per corner)	CRL3	\$34
(laminates self edge, ultrafoam, Corian®, 3form chroma)		
3" Wood Radius Corner (per corner)	CRW3	\$82
(not available in LWFL, WWFL, LWPI and WWPI)		
Edge Options		
1.75" Thick Edge (per table)	175E	15%
(see edge details for specific profiles)		

\$					
854	508	1,099	1,014	1,191	1,603
1,101	582	1,558	1,286	1,550	2,603
924	522	1,101	930	1,082	1,570
1,193	582	1,562	1,181	1,410	2,558
1,041	541	1,313	1,045	1,228	2,153

How to Order

Table Model Number					Top Finish Selection		Options
ME Base Series	36 Top Size	RD Top Shape	WWSQ Top Material Edge Profile	MBK Base Finish	WMW Top Finish	WMW Edge Finish	GSL Super Level Glides
A ME36RDWWSQMBK is a Medici series 36" round table with black powder coat decorative base and a wood veneer 1.25" thick top with a 1.25" square wood edge profile.					The codes: WMW WMW specify a medium walnut top, with a medium walnut edge.		The code: GSL specifies super level glides.

Move Tops

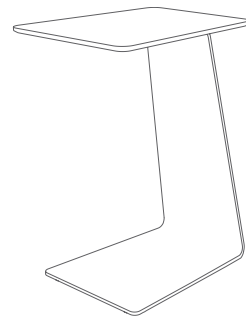

Laminate LMOV Ply	Veneer WMOV Wood	Corian Group A, B, C CMOV Corian	3form Chroma 3MOV Chroma
--------------------------------	-------------------------------	--	--

Complete Table List Pricing

Trapezoid	Top Size			Table Height	Model #	\$	688	760	780	906
	18	13	15	25						
					MOV					

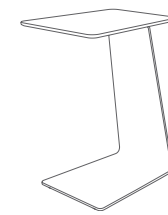

Options

Base Finishes		
Powder Coat	use finish code	n/c
Satin Chrome (per base)	use finish code	\$400
Premium Plated (per base)*	use finish code	Ⓛ
Custom Powder Coat (set-up charge)	CPC	\$363

Top Materials and Finishes		
Standard Laminates	use manufacturers finish code	n/c
Premium Laminates	PRL	Ⓛ
Custom Wood Veneer	CWV	Ⓛ
Stain to Match (set-up charge)	STM	\$412

*Premium plated polished not available on Move tables.

How to Order

Table Model Number			Top Finish Selection
MOV Table Series	WMOV Top Material	MBK Base Finish	WNM Top Finish

A MOVWMOVMBK is a Move table with a matte black powder coat base and a wood veneer top.

The code: WNM specifies a natural maple top.

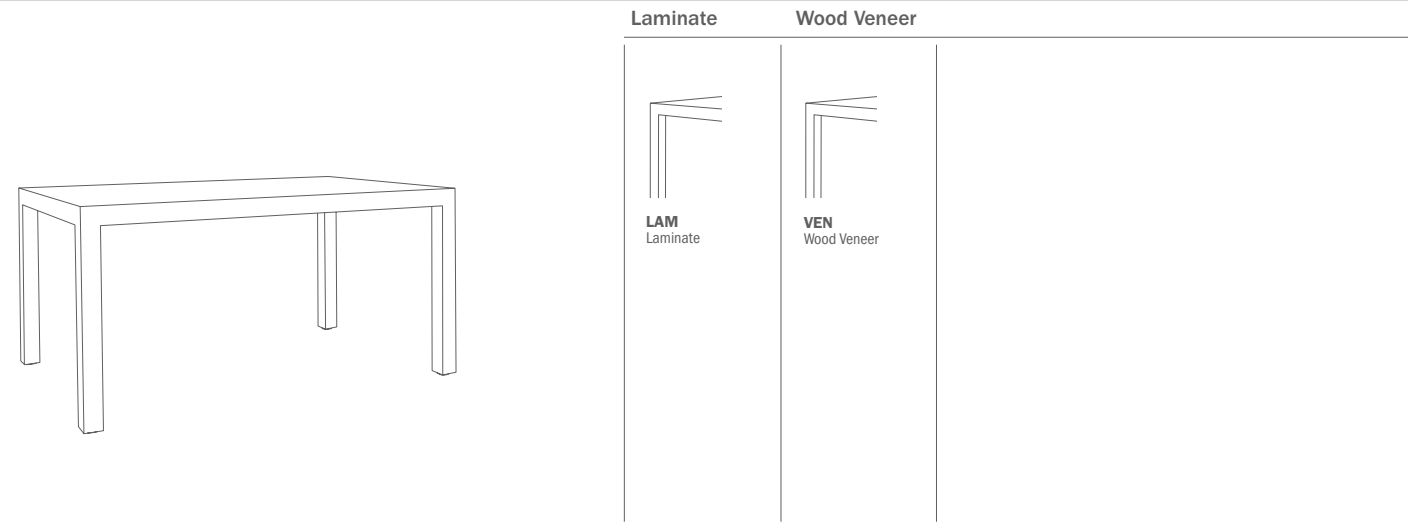

Complete Table List Pricing

	Top Size	Overall Table Height	Model #	\$	
Square	24 24	29"	PA2424SQ	1,441	1,988
	30 30	29"	PA3030SQ	1,575	2,171
	36 36	29"	PA3636SQ	1,785	2,429
	42 42	29"	PA4242SQ	1,977	2,712
	48 48	29"	PA4848SQ	2,180	3,104
Rectangle	24 30	29"	PA2430RE	1,477	2,053
	24 36	29"	PA2436RE	1,548	2,139
	24 42	29"	PA2442RE	1,620	2,226
	24 48	29"	PA2448RE	1,673	2,275
	24 60	29"	PA2460RE	1,867	2,566
	24 72	29"	PA2472RE	2,022	2,753
	30 36	29"	PA3036RE	1,633	2,242
	30 42	29"	PA3042RE	1,708	2,375
	30 48	29"	PA3048RE	1,838	2,530
	30 60	29"	PA3060RE	2,002	2,740
	30 72	29"	PA3072RE	2,183	3,035
	36 42	29"	PA3642RE	1,828	2,528
	36 48	29"	PA3648RE	1,950	2,716
	36 60	29"	PA3660RE	2,150	3,000
	36 72	29"	PA3672RE	2,348	3,260

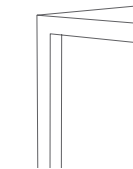

Options

Base Options		
Alternate Table Height - Below 29" (per table)	PAH1	\$300
Alternate Table Height - Above 29" (per table)	PAH2	\$900

Top Materials and Finishes		
Standard Laminates	use manufacturers finish code	n/c
Premium Laminates	PRL	Ⓛ
Custom Wood Veneer	CWV	Ⓛ
Special Pattern Veneer	SPV	Ⓛ
Stain to Match (set-up charge)	STM	\$412

Top Options		
Custom Size	CS	Ⓛ
Custom Shape	CSH	Ⓛ

How to Order

Table Model Number				Finish Selection	Options
PA Base Series	3636 Top Size	SQ Top Shape	VEN Material	WNW Top, edge and leg finish	PAH1 Alternate Height Base - Below 29"
A PA3636SQLAM is a Parsons series 36" x 36" square table with wood veneer top, edge and legs.				The code: WNW specifies a natural walnut top.	The code: PAH1 specifies alternate height base below 29".

Laminate Tops				Wood Veneer Tops			
Self Edge	Vinyl Edges	PVC Edges	Metal Edges	Wood Edges Group A	Wood Edges Group B	Wood Edges Group A	Wood Edges Group B
LLSE Self Edge	LVFL Flat	LPVC PVC	LMFL Flat	LWFL Flat	LWSQ Square	WWFL Flat	WWSQ Square
	LVBWP Bumper		LMRB Ribbed	LWTP Tapered Ply	LWAR Arc	WWTP Tapered Ply	WWAR Arc
				LWFP Flat Ply	LWBN Bullnose	WWFP Flat Ply	WWBN Bullnose
					LWPR Prism		WWPR Prism
				LWPI Pivot			WWPI Pivot

Specialty Tops				
Butcher Block	Ultrafoam	Acrylic	Corian Group A,B	Corian Group C,D
BBFL Flat	ULFP PVC	AAOP Opaque	C1FL Flat	C2FL Flat
BBBN Bullnose	ULFR Raw	AATL Translucent	C1BN Bullnose	C2BN Bullnose
			C1PR Prism	C2PR Prism
				3FFL Flat
				3FBN Bullnose
				3FPR Prism

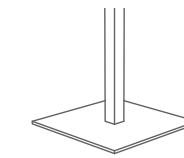

Single Column Base

Options

Base Finishes		
Standard Powder Coat	use finish code	n/c
Polished or Satin Chrome (per base)	use finish code	\$194
Premium Plated (per base)	use finish code	Ⓢ
Custom Powder Coat (set-up charge)	CPC	\$363

Base Options		
Alternate Height Base (per column)	AH	\$66
Nylon Octagon Glides (per base)	GNO	\$34
Custom Top Plate Size	CTPS	Ⓢ

Top Materials and Finishes		
Standard Laminates	use manufacturers finish code	n/c
Premium Laminates	PL	Ⓢ
Custom Wood Veneer	CWV	Ⓢ
Special Pattern Veneer	SPV	Ⓢ
Stain to Match (set-up charge)	STM	\$412

Top Options		
Custom Size	CS	Ⓢ
Custom Shape	CSH	Ⓢ
Custom Radius Corner	CRC	Ⓢ
3" Radius Corner (per corner)	CRL3	\$34
(laminate self edge, ultrafoam, Corian®, 3form chroma)		
3" Wood Radius Corner (per corner)	CRW3	\$82
(not available in LWFL, WWFL, LWPI and WWPI)		

Grommets		
2" Round Metal Grommet - Matte Black	GMBK	\$138
2" Round Metal Grommet - Satin Chrome	GMSC	\$138
2" Round Metal Grommet - Polished Chrome	GMPC	\$138
2" Round Plastic Grommet - Matte Black	GPMBK	\$44
Grommet location	use location code	n/c

Edge Options		
1.75" Thick Edge (per table)	175E	15%
(see edge details for specific profiles)		

Complete Table List Pricing

	Top Size	Base Qty.	Model #	\$								
Round	24	1	PL24RD	624	624	674	722	832	1,001	842	1,073	
	30	1	PL30RD	684	684	746	779	945	1,126	945	1,213	
	36	1	PL36RD	924	924	996	1,042	1,231	1,441	1,257	1,546	
	42	1	PL42RD	1,025	1,025	1,105	1,105	1,347	1,605	1,441	1,731	
	48	1	PL48RD	1,253	1,253	1,344	1,371	1,611	1,907	1,722	2,056	
	54	1	PL54RD	1,364	1,364	1,469	1,498	1,827	2,438	1,965	2,652	
60	1	PL60RD	1,541	1,541	1,654	1,708	1,947	2,521	2,306	2,747		
Racetrack	30	60	2	PL3060RA	1,327	1,327	1,385	1,407	1,697	1,975	1,798	2,143
	30	72	2	PL3072RA	1,395	1,395	1,467	1,492	1,771	2,115	1,884	2,247
	30	84	2	PL3084RA	1,625	1,625	1,689	1,730	1,868	2,354	1,994	2,551
	30	96	2	PL3096RA	1,695	1,695	1,767	1,811	1,962	2,568	2,092	2,755
	36	60	2	PL3660RA	1,713	1,713	1,781	1,803	2,073	2,380	2,184	2,540
	36	72	2	PL3672RA	1,793	1,793	1,872	1,897	2,205	2,548	2,332	2,719
	36	84	2	PL3684RA	2,030	2,030	2,109	2,151	2,305	2,775	2,449	2,999
	36	96	2	PL3696RA	2,110	2,110	2,203	2,244	2,412	3,001	2,567	3,178
	42	72	2	PL4272RA	1,877	1,877	1,951	1,982	2,266	2,661	2,337	2,945
	42	84	2	PL4284RA	2,131	2,131	2,198	2,242	2,365	2,916	2,511	3,236
	42	96	2	PL4296RA	2,227	2,227	2,296	2,345	2,488	3,114	2,651	3,511
	48	96	2	PL4896RA	2,580	2,580	2,660	2,710	2,940	3,591	3,309	3,817
	48	120	2	PL48120RA	2,792	2,792	2,893	2,955	3,183	3,930	3,613	4,270
	48	144	3	PL48144RA	3,775	3,775	3,890	3,967	4,208	5,018	4,720	5,443
	48	168	3	PL48168RA	3,990	3,990	4,113	4,200	4,459	5,387	5,035	5,869
	60	120	2	PL60120RA	3,064	3,064	3,173	3,249	3,364	4,270	3,813	4,667
	60	144	3	PL60144RA	4,099	4,099	4,200	4,292	4,547	5,387	4,879	5,856
	60	168	3	PL60168RA	4,364	4,364	4,475	4,580	4,841	5,782	5,513	6,632

Continued on next page

How to Order

Table Model Number				Top Finish Selection		Options
PL Base Series	36 Top Size	RD Top Shape	WWSQ Top Material Edge Profile	MBK Base Finish	WMW Top Finish	WMW Edge Finish
A PL36RDWWSQMBK is a Platform series 36" round table with a black powder coat square base and a wood veneer 1.25" thick top with a 1.25" square wood edge profile.				The codes: WMW WMW specify a medium walnut top, with a medium walnut edge.		The code: AH specifies alternate height base.

Laminate Tops				Wood Veneer Tops			
Self Edge	Vinyl Edges	PVC Edges	Metal Edges	Wood Edges Group A	Wood Edges Group B	Wood Edges Group A	Wood Edges Group B
LLSE Self Edge	LVFL Flat	LPVC PVC	LMFL Flat	LWFL Flat	LWSQ Square	WWFL Flat	WWSQ Square
	LVBK Bumper		LMRB Ribbed	LWTP Tapered Ply	LWAR Arc	WWTP Tapered Ply	WWAR Arc
				LWFP Flat Ply	LWBN Bullnose	WWFP Flat Ply	WWBN Bullnose
					LWPR Prism		WWPR Prism
					LWPI Pivot		WWPI Pivot

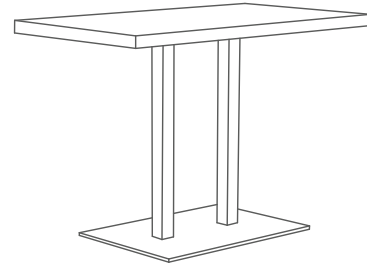

Specialty Tops				
Butcher Block	Ultrafoam	Acrylic	Corian Group A,B	Corian Group C,D
BBFL Flat	ULFP PVC	AAOP Opaque	C1FL Flat	C2FL Flat
BBBN Bullnose	ULFR Raw	AATL Translucent	C1BN Bullnose	C2BN Bullnose
			C1PR Prism	C2PR Prism
				3FFL Flat
				3FBN Bullnose
				3FPR Prism

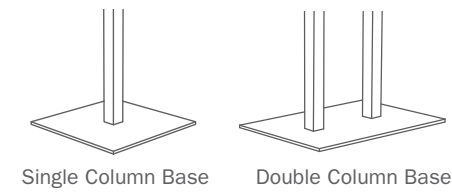

Complete Table List Pricing

	Top Size	Base Qty.	Model #	\$							
Square	24 24	1	PL2424SQ	624	624	680	734	832	1,001	842	1,073
	30 30	1	PL3030SQ	684	684	752	799	945	1,126	945	1,213
	36 36	1	PL3636SQ	924	924	992	1,061	1,221	1,441	1,257	1,546
	42 42	1	PL4242SQ	1,013	1,013	1,089	1,138	1,347	1,605	1,441	1,731
	48 48	1	PL4848SQ	1,255	1,255	1,344	1,403	1,611	1,907	1,722	2,056
Rectangle	24 30	1	PL2430RE	653	653	700	712	893	1,079	974	1,159
	24 36	1	PL2436RE	842	842	894	908	1,116	1,297	1,182	1,385
	24 42	1	PL2442RE	875	875	920	935	1,157	1,356	1,227	1,451
	24 42	1	PLD2442RE	1,067	1,067	1,112	1,127	1,349	1,549	1,419	1,644
	24 48	1	PLD2448RE	910	910	966	984	1,229	1,451	1,309	1,556
	24 48	1	PLD2448RE	1,102	1,102	1,159	1,176	1,421	1,644	1,502	1,748
	24 60	2	PL2460RE	870	1,247	1,307	1,328	1,588	1,841	1,677	1,961
	24 72	2	PL2472RE	1,305	1,305	1,375	1,399	1,685	1,975	1,788	2,113
	24 84	2	PL2484RE	1,522	1,522	1,587	1,627	1,767	2,255	1,880	2,430
	24 96	2	PL2496RE	1,580	1,580	1,651	1,695	1,849	2,376	1,971	2,566
	30 36	1	PL3036RE	887	887	932	947	1,169	1,367	1,241	1,463
	30 42	1	PL3042RE	922	922	974	992	1,264	1,486	1,346	1,597
	30 42	1	PLD3042RE	1,115	1,115	1,167	1,185	1,456	1,679	1,539	1,789
	30 48	1	PL3048RE	1,084	1,084	1,140	1,160	1,434	1,675	1,525	1,794
	30 48	1	PLD3048RE	1,152	1,152	1,208	1,228	1,502	1,743	1,592	1,862
	30 60	2	PL3060RE	1,315	1,315	1,379	1,403	1,695	1,971	1,798	2,107
	30 72	2	PL3072RE	1,383	1,383	1,460	1,487	1,771	2,084	1,885	2,234
	30 84	2	PL3084RE	1,615	1,615	1,681	1,726	1,866	2,354	1,989	2,537
	30 96	2	PL3096RE	1,685	1,685	1,758	1,806	1,961	2,527	2,097	2,732
	36 42	1	PL3642RE	970	970	1,029	1,048	1,319	1,564	1,412	1,684
	36 42	1	PLD3642RE	1,162	1,162	1,221	1,240	1,512	1,757	1,605	1,876
36 48	1	PL3648RE	1,135	1,135	1,197	1,218	1,498	1,759	1,595	1,887	

Continued on next page

\$					
1,059	657	1,236	1,064	1,217	1,705
1,328	717	1,697	1,316	1,544	2,693
1,820	967	2,320	1,811	2,130	3,756
2,412	1,068	2,972	2,180	2,604	4,880
2,843	1,321	3,955	2,735	3,280	6,312
1,176	676	1,448	1,180	1,363	2,287
1,470	871	1,892	1,453	1,669	2,774
1,664	907	2,017	1,564	1,817	3,110
1,856	1,100	2,210	1,756	2,010	3,302
1,719	947	2,202	1,678	1,966	3,443
1,911	1,140	2,395	1,870	2,158	3,636
2,243	1,294	-	2,198	2,551	4,430
2,494	1,362	-	2,437	2,860	5,095
2,677	1,554	-	-	-	-
2,860	1,622	-	-	-	-
1,640	920	2,112	1,616	1,883	3,281
1,885	962	2,355	1,754	2,064	3,719
2,078	1,154	2,547	1,947	2,257	3,912
2,070	1,130	2,729	2,031	2,383	4,272
2,138	1,197	2,796	2,098	2,450	4,340
2,518	1,372	3,408	2,467	2,905	5,258
2,823	1,451	4,150	2,753	3,274	6,130
3,006	1,656	-	-	-	-
3,189	1,738	-	-	-	-
2,099	1,017	-	2,134	2,311	4,316
2,292	1,210	-	2,327	2,503	4,508
2,290	1,191	3,132	2,587	2,671	4,947

Options

Base Finishes		
Standard Powder Coat	use finish code	n/c
Polished or Satin Chrome (per base)	use finish code	\$194
Premium Plated (per base)	use finish code	Ⓛ
Custom Powder Coat (set-up charge)	CPC	\$363

Base Options		
Alternate Height Base (per column)	AH	\$66
Nylon Octagon Glides (per base)	GNO	\$34
Custom Top Plate Size	CTPS	Ⓛ

Top Materials and Finishes		
Standard Laminates	use manufacturers finish code	n/c
Premium Laminates	PL	Ⓛ
Custom Wood Veneer	CWV	Ⓛ
Special Pattern Veneer	SPV	Ⓛ
Stain to Match (set-up charge)	STM	\$412

Top Options		
Custom Size	CS	Ⓛ
Custom Shape	CSH	Ⓛ
Custom Radius Corner	CRC	Ⓛ
3" Radius Corner (per corner)	CRL3	\$34
(laminated self edge, ultrafoam, Corian®, 3form chroma)		
3" Wood Radius Corner (per corner)	CRW3	\$82
(not available in LWFL, WWFL, LWPI and WWPI)		

Grommets		
2" Round Metal Grommet - Matte Black	GMBK	\$138
2" Round Metal Grommet - Satin Chrome	GMSC	\$138
2" Round Metal Grommet - Polished Chrome	GMPC	\$138
2" Round Plastic Grommet - Matte Black	GPMBK	\$44
Grommet location	use location code	n/c

Edge Options		
1.75" Thick Edge (per table)	175E	15%
(see edge details for specific profiles)		

How to Order

Table Model Number				Top Finish Selection		Options	
PL Base Series	3636 Top Size	SQ Top Shape	WWSQ Top Material Edge Profile	MBK Base Finish	WMW Top Finish	WMW Edge Finish	GMBK Matte Black Grommet
							E Location "E"
A PL3636SQWWSQMBK is a Platform series 36" x 36" square table with a black powder coat square base and a wood veneer 1.25" thick top with a 1.25" square wood edge profile.				The codes: WMW WMW specify a medium walnut top, with a medium walnut edge.		The code: GMBK specifies a matte black 2" diameter metal grommet.	
						The code: E specifies the location of the grommet.	

Laminate Tops				Wood Veneer Tops			
Self Edge	Vinyl Edges	PVC Edges	Metal Edges	Wood Edges Group A	Wood Edges Group B	Wood Edges Group A	Wood Edges Group B
LLSE Self Edge	LVFL Flat LVBP Bumper	LPVC PVC	LMFL Flat LMRB Ribbed	LWFL Flat LWTP Tapered Ply LWFP Flat Ply	LWSQ Square LWAR Arc LWBN Bullnose LWPR Prism LWPI Pivot	WWFL Flat WWTP Tapered Ply WWFP Flat Ply	WWSQ Square WWAR Arc WWBN Bullnose WWPR Prism WWPI Pivot

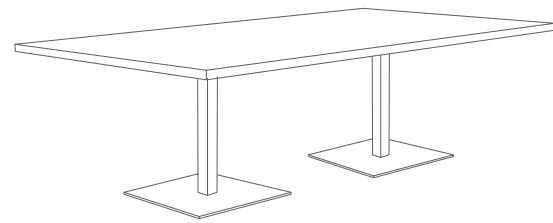

Specialty Tops					
Butcher Block	Ultrafoam	Acrylic	Corian Group A,B	Corian Group C,D	3form Chroma
BBFL Flat BBBN Bullnose	ULFP PVC ULFR Raw	AAOP Opaque AATL Translucent	C1FL Flat C1BN Bullnose C1PR Prism	C2FL Flat C2BN Bullnose C2PR Prism	3FFL Flat 3FBN Bullnose 3FPR Prism

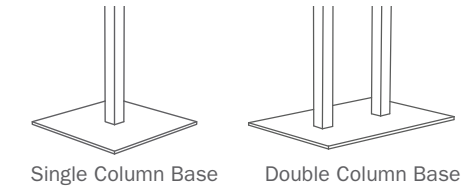

Options

Base Finishes		
Standard Powder Coat	use finish code	n/c
Polished or Satin Chrome (per base)	use finish code	\$194
Premium Plated (per base)	use finish code	Ⓛ
Custom Powder Coat (set-up charge)	CPC	\$363

Base Options		
Alternate Height Base (per column)	AH	\$66
Nylon Octagon Glides (per base)	GNO	\$34
Custom Top Plate Size	CTPS	Ⓛ

Top Materials and Finishes		
Standard Laminates	use manufacturers finish code	n/c
Premium Laminates	PL	Ⓛ
Custom Wood Veneer	CWV	Ⓛ
Special Pattern Veneer	SPV	Ⓛ
Stain to Match (set-up charge)	STM	\$412

Top Options		
Custom Size	CS	Ⓛ
Custom Shape	CSH	Ⓛ
Custom Radius Corner	CRC	Ⓛ
3" Radius Corner (per corner)	CRL3	\$34
(laminate self edge, ultrafoam, Corian®, 3form chroma)		
3" Wood Radius Corner (per corner)	CRW3	\$82
(not available in LWFL, WWFL, LWPI and WWPI)		

Grommets		
2" Round Metal Grommet - Matte Black	GMBK	\$138
2" Round Metal Grommet - Satin Chrome	GMSC	\$138
2" Round Metal Grommet - Polished Chrome	GMPC	\$138
2" Round Plastic Grommet - Matte Black	GPMBK	\$44
Grommet location	use location code	n/c

Edge Options		
1.75" Thick Edge (per table)	175E	15%
(see edge details for specific profiles)		

Complete Table List Pricing

	Top Size	Base Qty.	Model #	\$							
Rectangle	36 48	1	PLD3648RE	1,203	1,203	1,265	1,286	1,565	1,827	1,662	1,954
	36 60	2	PL3660RE	1,700	1,700	1,773	1,797	2,073	2,369	2,184	2,517
	36 72	2	PL3672RE	1,783	1,783	1,860	1,888	2,201	2,536	2,326	2,705
	36 84	2	PL3684RE	2,028	2,028	2,097	2,143	2,305	2,771	2,445	2,968
	36 96	2	PL3696RE	2,110	2,110	2,193	2,237	2,410	2,945	2,563	3,164
	42 72	2	PL4272RE	2,117	2,117	2,182	2,215	2,516	2,911	2,587	3,004
	42 84	2	PL4284RE	2,373	2,373	2,443	2,492	2,630	3,138	2,866	3,451
	42 96	2	PL4296RE	2,467	2,467	2,544	2,597	2,751	3,364	3,008	3,494
	48 96	2	PL4896RE	2,578	2,578	2,653	2,708	2,936	3,591	3,309	3,796
	48 120	2	PL48120RE	2,790	2,790	2,888	2,955	3,179	3,817	3,613	4,101
	48 144	3	PL48144RE	3,755	3,755	3,850	3,930	4,175	4,821	4,677	5,212
	48 168	3	PL48168RE	3,983	3,983	4,083	4,175	4,406	5,103	4,967	5,538
60 120	2	PL60120RE	3,051	3,051	3,143	3,224	3,399	4,043	3,817	4,441	
60 144	3	PL60144RE	4,051	4,051	4,154	4,251	4,518	5,103	5,107	5,629	
60 168	3	PL60168RE	4,360	4,360	4,433	4,545	4,801	5,727	5,461	6,406	
Arc Rectangle	30 60	2	PL3060AR	1,328	1,328	1,383	1,405	1,662	1,975	1,798	2,119
	30 72	2	PL3072AR	1,419	1,419	1,469	1,494	1,776	2,173	1,884	2,247
	30 84	2	PL3084AR	1,597	1,597	1,678	1,718	1,866	2,315	1,992	2,551
	30 96	2	PL3096AR	1,670	1,670	1,757	1,800	1,975	2,512	2,092	2,755
	36 60	2	PL3660AR	1,733	1,733	1,775	1,797	2,073	2,435	2,184	2,540
	36 72	2	PL3672AR	1,836	1,836	1,884	1,910	2,198	2,606	2,326	2,719
	36 84	2	PL3684AR	2,015	2,015	2,100	2,141	2,305	2,775	2,445	2,974

Continued on next page

How to Order

Table Model Number				Top Finish Selection		Options		
PL Base Series	4272 Top Size	RE Top Shape	WWSQ Top Material Edge Profile	MBK Base Finish	WMW Top Finish	WMW Edge Finish	GMBK Matte Black Grommet	E Location "E"
A PL4272REWWSQMBK is a Platform series 42" x 72" rectangle table with two black powder coat square bases and a wood veneer 1.25" thick top with a 1.25" square wood edge profile.					The codes: WMW WMW specify a medium walnut top, with a medium walnut edge.		The code: GMBK specifies a matte black 2" diameter metal grommet.	The code: E specifies the location of the grommet.

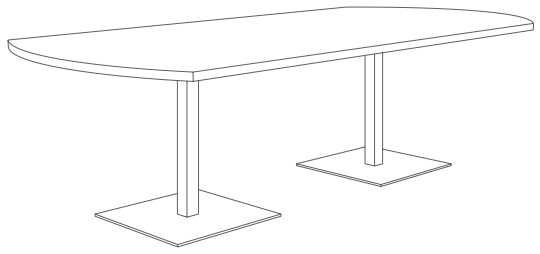

Laminate Tops

Self Edge	Vinyl Edges	PVC Edges	Metal Edges
LLSE Self Edge	LVFL Flat LVBP Bumper	LPVC PVC	LMFL Flat LMRB Ribbed

Wood Veneer Tops

Wood Edges Group A	Wood Edges Group B	Wood Edges Group A	Wood Edges Group B
LWFL Flat LWTP Tapered Ply LWFP Flat Ply	LWSQ Square LWAR Arc LWBN Bullnose LWPR Prism LWPI Pivot	WWFL Flat WWTP Tapered Ply WWFP Flat Ply	WWSQ Square WWAR Arc WWBN Bullnose WWPR Prism WWPI Pivot

Specialty Tops

Butcher Block	Ultrafoam	Acrylic	Corian Group A,B	Corian Group C,D	3form Chroma
BBFL Flat BBBN Bullnose	ULFP PVC ULFR Raw	AAOP Opaque AATL Translucent	C1FL Flat C1BN Bullnose C1PR Prism	C2FL Flat C2BN Bullnose C2PR Prism	3FFL Flat 3FBN Bullnose 3FPR Prism

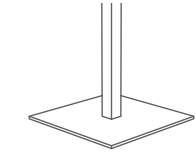

Single Column Base

Options

Base Finishes		
Standard Powder Coat	use finish code	n/c
Polished or Satin Chrome (per base)	use finish code	\$194
Premium Plated (per base)	use finish code	Ⓛ
Custom Powder Coat (set-up charge)	CPC	\$363

Base Options		
Alternate Height Base (per column)	AH	\$66
Nylon Octagon Glides (per base)	GNO	\$34
Custom Top Plate Size	CTPS	Ⓛ

Top Materials and Finishes		
Standard Laminates	use manufacturers finish code	n/c
Premium Laminates	PL	Ⓛ
Custom Wood Veneer	CWV	Ⓛ
Special Pattern Veneer	SPV	Ⓛ
Stain to Match (set-up charge)	STM	\$412

Top Options		
Custom Size	CS	Ⓛ
Custom Shape	CSH	Ⓛ
Custom Radius Corner	CRC	Ⓛ
3" Radius Corner (per corner)	CRL3	\$34
(laminate self edge, ultrafoam, Corian®, 3form chroma)		
3" Wood Radius Corner (per corner)	CRW3	\$82
(not available in LWFL, WWFL, LWPI and WWPI)		

Grommets		
2" Round Metal Grommet - Matte Black	GMBK	\$138
2" Round Metal Grommet - Satin Chrome	GMSC	\$138
2" Round Metal Grommet - Polished Chrome	GMPC	\$138
2" Round Plastic Grommet - Matte Black	GPMBK	\$44
Grommet location	use location code	n/c

Edge Options		
1.75" Thick Edge (per table)	175E	15%
<i>(see edge details for specific profiles)</i>		

Complete Table List Pricing

	Top Size	Base Qty.	Model #	\$							
Arc Rectangle	36 96	2	PL3696AR	2,100	2,100	2,193	2,233	2,412	3,029	2,567	3,178
	42 72	2	PL4272AR	1,982	1,982	2,004	2,040	2,266	2,712	2,337	3,001
	42 84	2	PL4284AR	2,110	2,110	2,193	2,237	2,353	2,974	2,616	3,262
	42 96	2	PL4296AR	2,207	2,207	2,294	2,342	2,493	3,172	2,758	3,511
	48 96	2	PL4896AR	2,600	2,600	2,654	2,704	2,936	3,648	3,309	3,875
	48 120	2	PL48120AR	2,774	2,774	2,893	2,955	3,179	3,988	3,613	4,270
	48 144	3	PL48144AR	3,734	3,734	3,856	3,930	4,216	5,076	4,728	5,502
	48 168	3	PL48168AR	3,956	3,956	4,083	4,167	4,461	5,556	5,037	5,905
	60 120	2	PL60120AR	3,037	3,037	3,182	3,259	3,422	4,298	3,842	4,644
	60 144	3	PL60144AR	4,043	4,043	4,187	4,278	4,597	5,443	4,901	6,114
60 168	3	PL60168AR	4,319	4,319	4,465	4,570	4,885	5,840	5,224	6,504	

How to Order

Table Model Number				Top Finish Selection		Options	
PL Base Series	4296 Top Size	AR Top Shape	WWSQ Top Material Edge Profile	MBK Base Finish	WMW Top Finish	WMW Edge Finish	GMBK Matte Black Grommet
A PL4296ARWWSQMBK is a Platform series 42" x 96" arc rectangle table with two black powder coat square bases and a wood veneer 1.25" thick top with a 1.25" square wood edge profile.				The codes: WMW WMW specify a medium walnut top, with a medium walnut edge.		The code: GMBK specifies a matte black 2" diameter metal grommet.	
						E Location "E"	
						The code: E specifies the location of the grommet.	

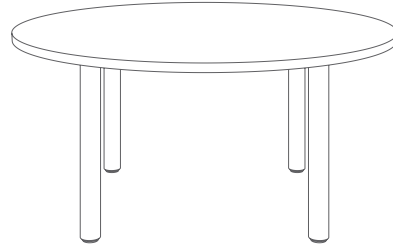

Laminate Tops				Wood Veneer Tops			
Self Edge	Vinyl Edges	PVC Edges	Metal Edges	Wood Edges Group A	Wood Edges Group B	Wood Edges Group A	Wood Edges Group B
LLSE Self Edge	LVFL Flat LVBP Bumper	LPVC PVC	LMFL Flat LMRB Ribbed	LWFL Flat LWTP Tapered Ply LWFP Flat Ply	LWSQ Square LWAR Arc LWBN Bullnose LWPR Prism LWPI Pivot	WWFL Flat WWTP Tapered Ply WWFP Flat Ply	WWSQ Square WWAR Arc WWBN Bullnose WWPR Prism WWPI Pivot

Butcher Block	Ultrafoam	Acrylic	Corian Group A,B	Corian Group C,D	3form Chroma
BBFL Flat BBBN Bullnose	ULFP PVC ULFR Raw	AAOP Opaque AATL Translucent	C1FL Flat C1BN Bullnose C1PR Prism	C2FL Flat C2BN Bullnose C2PR Prism	3FFL Flat 3FBN Bullnose 3FPR Prism

Complete Table List Pricing

Top Size	Base Qty.	Model #	\$							
Round										
36	4	P036RD	949	949	1,021	1,067	1,256	1,466	1,282	1,571
42	4	P042RD	1,090	1,090	1,170	1,170	1,412	1,670	1,506	1,796
48	4	P048RD	1,193	1,193	1,284	1,311	1,551	1,847	1,662	1,996
54	4	P054RD	1,304	1,304	1,409	1,438	1,767	2,378	1,905	2,592
60	4	P060RD	1,481	1,481	1,594	1,648	1,887	2,461	2,246	2,687
Oval										
36 72	4	P03672OV	1,244	1,244	1,295	1,320	1,503	1,725	1,676	1,892
42 54	4	P04254OV	1,261	1,261	1,288	1,352	1,493	1,820	1,644	1,880
42 78	4	P04278OV	1,553	1,553	1,594	1,639	1,787	2,008	1,930	2,177
42 84	4	P04284OV	1,609	1,609	1,663	1,707	1,837	2,088	1,983	2,267
48 78	4	P04878OV	1,644	1,644	1,701	1,747	1,870	2,119	2,022	2,302
48 96	4	P04896OV	1,820	1,820	1,876	1,926	2,018	2,290	2,380	2,697
Racetrack										
30 60	4	P03060RA	1,077	1,077	1,135	1,157	1,447	1,725	1,548	1,893
30 72	4	P03072RA	1,145	1,145	1,217	1,242	1,521	1,865	1,634	1,997
30 84	4	P03084RA	1,375	1,375	1,439	1,480	1,618	2,104	1,744	2,301
30 96	4	P03096RA	1,445	1,445	1,517	1,561	1,712	2,318	1,842	2,505
36 60	4	P03660RA	1,143	1,143	1,211	1,233	1,503	1,810	1,614	1,970
36 72	4	P03672RA	1,223	1,223	1,302	1,327	1,635	1,978	1,762	2,149
36 84	4	P03684RA	1,460	1,460	1,539	1,581	1,735	2,205	1,879	2,429
36 96	4	P03696RA	1,540	1,540	1,633	1,674	1,842	2,431	1,997	2,608
42 72	4	P04272RA	1,347	1,347	1,421	1,452	1,736	2,131	1,807	2,415
42 84	4	P04284RA	1,601	1,601	1,668	1,712	1,835	2,386	1,981	2,706
42 96	4	P04296RA	1,697	1,697	1,766	1,815	1,958	2,584	2,121	2,981

Continued on next page

\$					
1,727	992	2,338	1,954	2,312	3,833
2,292	1,144	3,029	2,385	2,862	5,009
2,567	1,259	3,885	2,829	3,432	6,313
-	1,389	4,988	3,313	4,061	-
-	1,535	6,202	3,864	4,776	-
-	-	-	-	-	-
-	-	4,097	-	-	-
-	-	5,484	-	-	-
-	-	-	-	-	-
-	-	6,262	-	-	-
-	-	-	-	-	-
-	-	-	-	-	-
-	-	-	-	-	-
-	-	-	-	-	-
-	-	-	-	-	-
-	-	-	-	-	-
-	-	-	-	-	-
-	-	-	-	-	-
-	-	-	-	-	-

Options

Base Finishes		
Powder Coat	use finish code	n/c
Polished or Satin Chrome (per leg)	use finish code	\$62
Premium Plated (per leg)	use finish code	Ⓛ
Custom Powder Coat (set-up charge)	CPC	\$363

Base Options		
Alternate Height Base (per leg)	AH	\$66
Floor Fastener Glide (per leg)	FFG	\$34
Locking Casters 2" Twin Wheel (qty. 4)	TWC2	\$56

Top Materials and Finishes		
Standard Laminates	use manufacturers finish code	n/c
Premium Laminates	PRL	Ⓛ
Custom Wood Veneer	CWV	Ⓛ
Special Pattern Veneer	SPV	Ⓛ
Stain to Match (set-up charge)	STM	\$412

Top Options		
Custom Size	CS	Ⓛ
Custom Shape	CSH	Ⓛ
Custom Radius Corner	CRC	Ⓛ
3" Radius Corner (per corner)	CRL3	\$34
(laminates self edge, ultrafoam, Corian®, 3form chroma)		
3" Wood Radius Corner (per corner)	CRW3	\$82
(not available in LWFL, WWFL, LWPI and WWPI)		

Grommets		
2" Round Metal Grommet - Matte Black	GMBK	\$138
2" Round Metal Grommet - Satin Chrome	GMSC	\$138
2" Round Metal Grommet - Polished Chrome	GMPC	\$138
2" Round Plastic Grommet - Matte Black	GPMBK	\$44
Grommet location	use location code	n/c

Edge Options		
1.75" Thick Edge (per table)	175E	15%
(see edge details for specific profiles)		

How to Order

Table Model Number				Top Finish Selection		Options	
PO	36	RD	WWSQ	MBK	WMW	WMW	AH
Base Series	Top Size	Top Shape	Top Material Edge Profile	Base Finish	Top Finish	Edge Finish	Alternate Height Base

A P036RDWWSQMBK is a Post Leg series 36" round table with four black powder coat post legs and a wood veneer 1.25" thick top with a 1.25" square wood edge profile.

The codes: WMW WMW specify a medium walnut top, with a medium walnut edge.

The code: AH specifies alternate height base.

Laminate Tops				Wood Veneer Tops			
Self Edge	Vinyl Edges	PVC Edges	Metal Edges	Wood Edges Group A	Wood Edges Group B	Wood Edges Group A	Wood Edges Group B
LLSE Self Edge	LVFL Flat	LPVC PVC	LMFL Flat	LWFL Flat	LWSQ Square	WWFL Flat	WWSQ Square
	LVBWP Bumper		LMRB Ribbed	LWTP Tapered Ply	LWAR Arc	WWTP Tapered Ply	WWAR Arc
				LWFP Flat Ply	LWBN Bullnose	WWFP Flat Ply	WWBN Bullnose
					LWPR Prism		WWPR Prism
					LWPI Pivot		WWPI Pivot

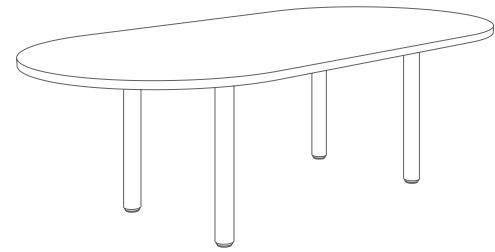

Complete Table List Pricing

	Top Size	Base Qty.	Model #	\$							
Racetrack	48 96	4	PO4896RA	1,800	1,800	1,880	1,930	2,160	2,811	2,529	3,037
	48 120	6	PO48120RA	2,342	2,342	2,443	2,505	2,733	3,480	3,163	3,820
	48 144	6	PO48144RA	2,605	2,605	2,720	2,797	3,038	3,848	3,550	4,273
	48 168	6	PO48168RA	2,820	2,820	2,943	3,030	3,289	4,217	3,865	4,699
	60 120	6	PO60120RA	2,614	2,614	2,723	2,799	2,914	3,820	3,363	4,217
	60 144	6	PO60144RA	2,929	2,929	3,030	3,122	3,377	4,217	3,709	4,686
60 168	6	PO60168RA	3,194	3,194	3,305	3,410	3,671	4,612	4,343	5,462	
Square	36 36	4	PO3636SQ	949	949	1,017	1,086	1,246	1,466	1,282	1,571
	42 42	4	PO4242SQ	1,078	1,078	1,154	1,203	1,412	1,670	1,506	1,796
	48 48	4	PO4848SQ	1,195	1,195	1,284	1,343	1,551	1,847	1,662	1,996
Rectangle	30 60	4	PO3060RE	1,065	1,065	1,129	1,153	1,445	1,721	1,548	1,857
	30 72	4	PO3072RE	1,133	1,133	1,210	1,237	1,521	1,834	1,635	1,984
	30 84	4	PO3084RE	1,365	1,365	1,431	1,476	1,616	2,104	1,739	2,287
	30 96	4	PO3096RE	1,435	1,435	1,508	1,556	1,711	2,277	1,847	2,482
	36 42	4	PO3642RE	995	995	1,054	1,073	1,344	1,589	1,437	1,709
	36 48	4	PO3648RE	1,035	1,035	1,097	1,118	1,398	1,659	1,495	1,787
	36 60	4	PO3660RE	1,130	1,130	1,203	1,227	1,503	1,799	1,614	1,947
	36 72	4	PO3672RE	1,213	1,213	1,290	1,318	1,631	1,966	1,756	2,135
	36 84	4	PO3684RE	1,458	1,458	1,527	1,573	1,735	2,201	1,875	2,398
	36 96	4	PO3696RE	1,540	1,540	1,623	1,667	1,840	2,375	1,993	2,594
	42 72	4	PO4272RE	1,337	1,337	1,402	1,435	1,736	2,131	1,807	2,224
	42 84	4	PO4284RE	1,593	1,593	1,663	1,712	1,850	2,358	2,086	2,671
	42 96	4	PO4296RE	1,687	1,687	1,764	1,817	1,971	2,584	2,228	2,714

Continued on next page

Specialty Tops					
Butcher Block	Ultrafoam	Acrylic	Corian Group A,B	Corian Group C,D	3form Chroma
BBFL Flat	ULFP PVC	AAOP Opaque	C1FL Flat	C2FL Flat	3FFL Flat
BBBN Bullnose	ULFR Raw	AATL Translucent	C1BN Bullnose	C2BN Bullnose	3FBN Bullnose
			C1PR Prism	C2PR Prism	3FPR Prism

\$					
-	-	-	-	-	-
-	-	-	-	-	-
-	-	-	-	-	-
-	-	-	-	-	-
-	-	-	-	-	-
1,845	992	2,345	1,836	2,155	3,781
2,477	1,133	3,037	2,245	2,669	4,945
2,783	1,261	3,895	2,675	3,220	6,252
2,268	1,122	3,158	2,217	2,655	5,008
2,573	1,201	3,900	2,503	3,024	5,880
2,756	1,406	-	-	-	-
2,939	1,488	-	-	-	-
2,124	1,042	-	2,159	2,336	4,341
2,190	1,091	3,032	2,487	2,571	4,847
2,536	1,196	3,900	2,509	3,028	5,888
2,888	1,291	4,483	2,836	3,454	6,874
3,238	1,511	5,699	-	-	-
3,583	1,608	6,035	-	-	-
-	1,424	-	-	-	-
-	1,656	-	-	-	-
-	1,767	6,822	-	-	-

Options

Base Finishes		
Powder Coat	use finish code	n/c
Polished or Satin Chrome (per leg)	use finish code	\$62
Premium Plated (per leg)	use finish code	Ⓛ
Custom Powder Coat (set-up charge)	CPC	\$363

Base Options		
Alternate Height Base (per leg)	AH	\$66
Floor Fastener Glide (per leg)	FFG	\$34
Locking Casters 2" Twin Wheel (qty. 4)	TWC2	\$56

Top Materials and Finishes		
Standard Laminates	use manufacturers finish code	n/c
Premium Laminates	PRL	Ⓛ
Custom Wood Veneer	CWV	Ⓛ
Special Pattern Veneer	SPV	Ⓛ
Stain to Match (set-up charge)	STM	\$412

Top Options		
Custom Size	CS	Ⓛ
Custom Shape	CSH	Ⓛ
Custom Radius Corner	CRC	Ⓛ
3" Radius Corner (per corner)	CRL3	\$34
(laminate self edge, ultrafoam, Corian®, 3form chroma)		
3" Wood Radius Corner (per corner)	CRW3	\$82
(not available in LWFL, WWFL, LWPI and WWPI)		

Grommets		
2" Round Metal Grommet - Matte Black	GMBK	\$138
2" Round Metal Grommet - Satin Chrome	GMSC	\$138
2" Round Metal Grommet - Polished Chrome	GMPC	\$138
2" Round Plastic Grommet - Matte Black	GPMBK	\$44
Grommet location	use location code	n/c

Edge Options		
1.75" Thick Edge (per table)	175E	15%
(see edge details for specific profiles)		

How to Order

Table Model Number				Top Finish Selection		Options	
PO Base Series	4896 Top Size	RA Top Shape	WWSQ Top Material Edge Profile	MBK Base Finish	WMW Top Finish	WMW Edge Finish	GMBK Matte Black Grommet
A PO4896RAWWSQMBK is a Post Leg series 48" x 96" racetrack table with four black powder coat post legs and a wood veneer 1.25" thick top with a 1.25" square wood edge profile.				The codes: WMW WMW specify a medium walnut top, with a medium walnut edge.		The code: GMBK specifies a matte black 2" diameter metal grommet.	
						E Location "E"	
						The code: E specifies the location of the grommet.	

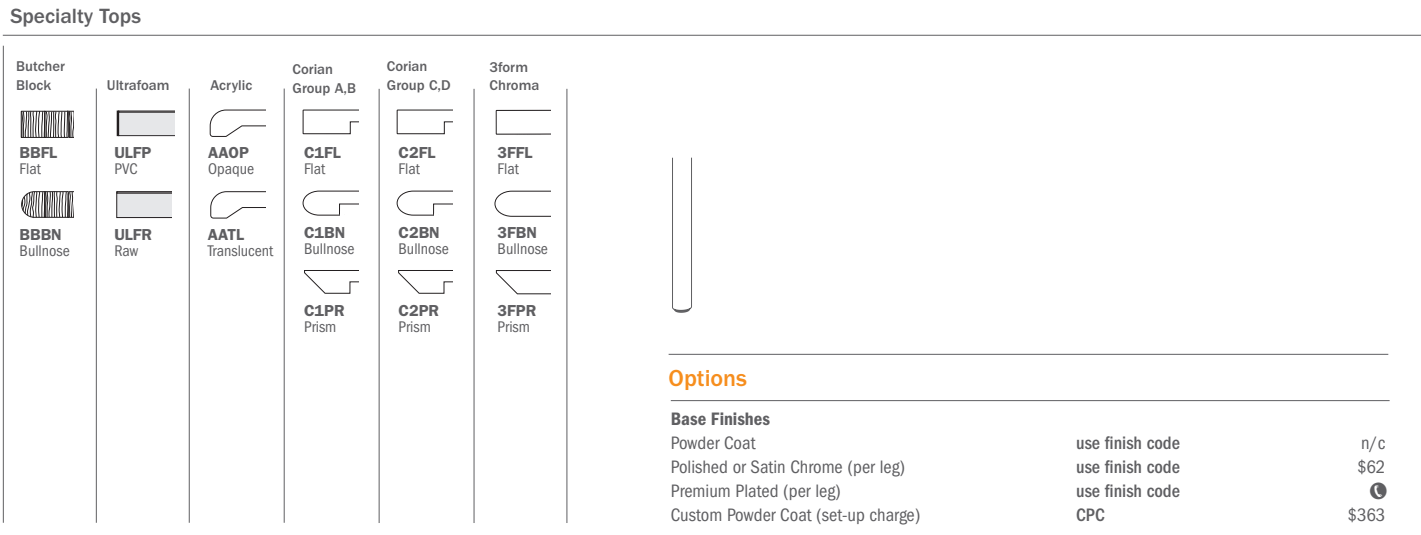
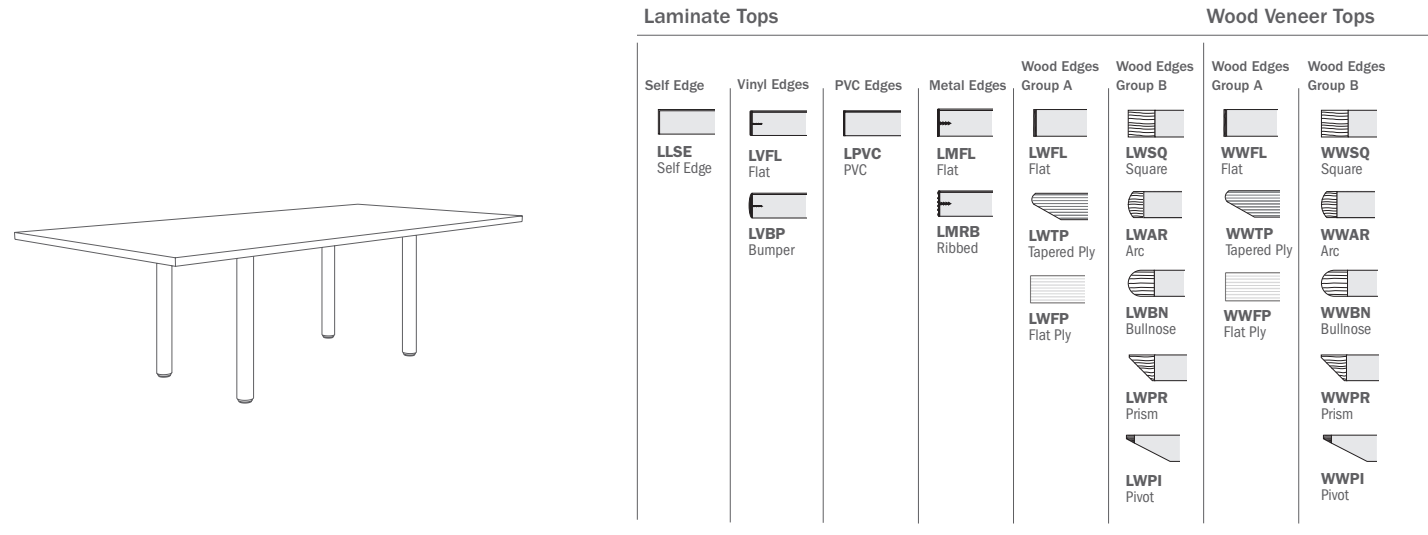

Complete Table List Pricing

	Top Size	Base Qty.	Model #	\$							
Rectangle	48 96	4	PO4896RE	1,798	1,798	1,873	1,928	2,156	2,811	2,529	3,016
	48 120	6	PO48120RE	2,340	2,340	2,438	2,505	2,729	3,367	3,163	3,651
	48 144	6	PO48144RE	2,585	2,585	2,680	2,760	3,005	3,651	3,507	4,042
	48 168	6	PO48168RE	2,813	2,813	2,913	3,005	3,236	3,933	3,797	4,368
	60 120	6	PO60120RE	2,601	2,601	2,693	2,774	2,949	3,593	3,367	3,991
	60 144	6	PO60144RE	2,881	2,881	2,984	3,081	3,348	3,933	3,937	4,459
60 168	6	PO60168RE	3,190	3,190	3,263	3,375	3,631	4,557	4,291	5,236	
Arc Rectangle	30 60	4	PO3060AR	1,078	1,078	1,133	1,155	1,412	1,725	1,548	1,869
	30 72	4	PO3072AR	1,169	1,169	1,219	1,244	1,526	1,923	1,634	1,997
	30 84	4	PO3084AR	1,347	1,347	1,428	1,468	1,616	2,065	1,742	2,301
	30 96	4	PO3096AR	1,420	1,420	1,507	1,550	1,725	2,262	1,842	2,505
	36 60	4	PO3660AR	1,163	1,163	1,205	1,227	1,503	1,865	1,614	1,970
	36 72	4	PO3672AR	1,266	1,266	1,314	1,340	1,628	2,036	1,756	2,149
	36 84	4	PO3684AR	1,445	1,445	1,530	1,571	1,735	2,205	1,875	2,404
	36 96	4	PO3696AR	1,530	1,530	1,623	1,663	1,842	2,459	1,997	2,608
	42 72	4	PO4272AR	1,452	1,452	1,474	1,510	1,736	2,182	1,807	2,471
	42 84	4	PO4284AR	1,580	1,580	1,663	1,707	1,823	2,444	2,086	2,732
	42 96	4	PO4296AR	1,677	1,677	1,764	1,812	1,963	2,642	2,228	2,981
	48 96	4	PO4896AR	1,820	1,820	1,874	1,924	2,156	2,868	2,529	3,095
	48 120	6	PO48120AR	2,324	2,324	2,443	2,505	2,729	3,538	3,163	3,820
	48 144	6	PO48144AR	2,564	2,564	2,686	2,760	3,046	3,906	3,558	4,332
48 168	6	PO48168AR	2,786	2,786	2,913	2,997	3,291	4,386	3,867	4,735	

Continued on next page

Options		
Base Finishes		
Powder Coat	use finish code	n/c
Polished or Satin Chrome (per leg)	use finish code	\$62
Premium Plated (per leg)	use finish code	\$
Custom Powder Coat (set-up charge)	CPC	\$363
Base Options		
Alternate Height Base (per leg)	AH	\$66
Floor Fastener Glide (per leg)	FFG	\$34
Locking Casters 2" Twin Wheel (qty. 4)	TWC2	\$56
Top Materials and Finishes		
Standard Laminates	use manufacturers finish code	n/c
Premium Laminates	PRL	\$
Custom Wood Veneer	CWV	\$
Special Pattern Veneer	SPV	\$
Stain to Match (set-up charge)	STM	\$412
Top Options		
Custom Size	CS	\$
Custom Shape	CSH	\$
Custom Radius Corner	CRC	\$
3" Radius Corner (per corner)	CRL3	\$34
(laminate self edge, ultrafoam, Corian®, 3form chroma)		
3" Wood Radius Corner (per corner)	CRW3	\$82
(not available in LWFL, WWFL, LWPI and WWPI)		
Grommets		
2" Round Metal Grommet - Matte Black	GMBK	\$138
2" Round Metal Grommet - Satin Chrome	GMSC	\$138
2" Round Metal Grommet - Polished Chrome	GMPC	\$138
2" Round Plastic Grommet - Matte Black	GPMBK	\$44
Grommet location	use location code	n/c
Edge Options		
1.75" Thick Edge (per table)	175E	15%
(see edge details for specific profiles)		

How to Order

Table Model Number				Top Finish Selection		Options	
PO Base Series	4896 Top Size	RE Top Shape	WWSQ Top Material Edge Profile	MBK Base Finish	WMW Top Finish	WMW Edge Finish	GMBK Matte Black Grommet
A PO4896REWWSQMBK is a Post Leg series 48" x 96" rectangle table with four black powder coat post legs and a wood veneer 1.25" thick top with a 1.25" square wood edge profile.					The codes: WMW WMW specify a medium walnut top, with a medium walnut edge.		The code: GMBK specifies a matte black 2" diameter metal grommet.
							The code: E specifies the location of the grommet.

Laminate Tops Wood Veneer Tops

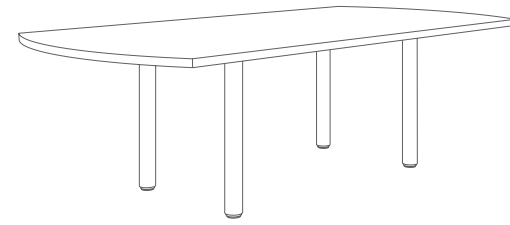
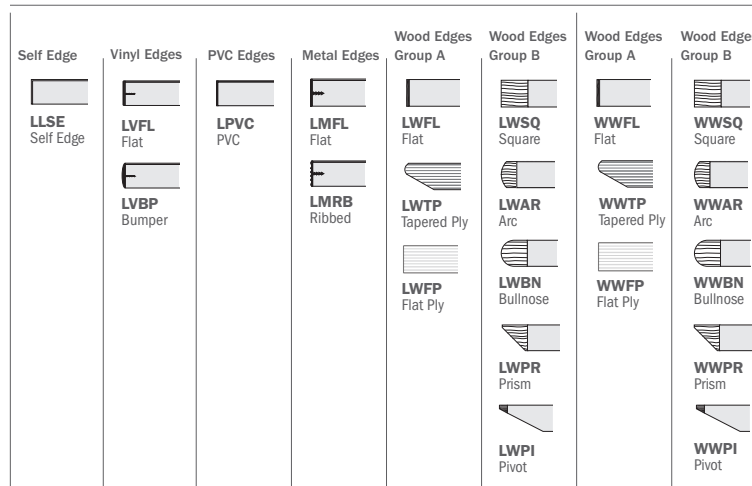

Complete Table List Pricing

	Top Size		Base Qty.	Model #	\$								
Arc Rectangle	60	120	6	P060120AR	2,587	2,587	2,732	2,809	2,972	3,848	3,392	4,194	
	60	144	6	P060144AR	2,873	2,873	3,017	3,108	3,427	4,273	3,731	4,944	
	60	168	6	P060168AR	3,149	3,149	3,295	3,400	3,715	4,670	4,054	5,334	
Boat Shape	36	42	72	4	P03672BS	1,671	1,671	1,636	1,683	1,917	2,341	2,076	2,553
	36	48	84	4	P03684BS	1,786	1,786	1,851	1,907	2,212	2,607	2,407	2,854
	36	48	96	4	P03696BS	1,905	1,905	1,969	2,026	2,378	2,725	2,594	2,983
	36	48	120	6	P036120BS	2,472	2,472	2,549	2,620	3,091	3,324	3,355	3,616
	36	48	144	6	P036144BS	2,731	2,731	2,820	2,906	3,567	3,807	3,888	4,159
	36	48	168	6	P036168BS	2,957	2,957	3,069	3,167	3,902	4,028	4,266	4,408

Specialty Tops

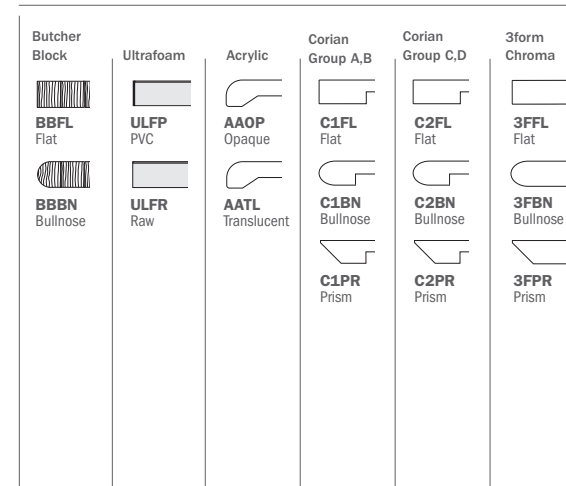

Options

Base Finishes		
Powder Coat	use finish code	n/c
Polished or Satin Chrome (per leg)	use finish code	\$62
Premium Plated (per leg)	use finish code	\$
Custom Powder Coat (set-up charge)	CPC	\$363

Base Options		
Alternate Height Base (per leg)	AH	\$66
Floor Fastener Glide (per leg)	FFG	\$34
Locking Casters 2" Twin Wheel (qty. 4)	TWC2	\$56

Top Materials and Finishes		
Standard Laminates	use manufacturers finish code	n/c
Premium Laminates	PRL	\$
Custom Wood Veneer	CWV	\$
Special Pattern Veneer	SPV	\$
Stain to Match (set-up charge)	STM	\$412

Top Options		
Custom Size	CS	\$
Custom Shape	CSH	\$
Custom Radius Corner	CRC	\$
3" Radius Corner (per corner)	CRL3	\$34
(laminate self edge, ultrafoam, Corian®, 3form chroma)		
3" Wood Radius Corner (per corner)	CRW3	\$82
(not available in LWFL, WWFL, LWPI and WWPI)		

Grommets		
2" Round Metal Grommet - Matte Black	GMBK	\$138
2" Round Metal Grommet - Satin Chrome	GMSC	\$138
2" Round Metal Grommet - Polished Chrome	GMPC	\$138
2" Round Plastic Grommet - Matte Black	GPMBK	\$44
Grommet location	use location code	n/c

Edge Options		
1.75" Thick Edge (per table)	175E	15%
(see edge details for specific profiles)		

How to Order

Table Model Number					Top Finish Selection		Options	
PO Base Series	60120 Top Size	AR Top Shape	WWSQ Top Material Edge Profile	MBK Base Finish	WMW Top Finish	WMW Edge Finish	GMBK Matte Black Grommet	G Location "G"
A P060120ARWWSQMBK is a Post Leg series 60" x 120" arc rectangle table with six black powder coat post legs and a wood veneer 1.25" thick top with a 1.25" square wood edge profile.					The codes: WMW WMW specifies a medium walnut top, with a medium walnut edge.		The code: GMBK specifies a matte black 2" diameter metal grommet.	
							The code: G specifies the location of the grommet.	

Laminate Tops				Wood Veneer Tops			
Self Edge	Vinyl Edges	PVC Edges	Metal Edges	Wood Edges Group A	Wood Edges Group B	Wood Edges Group A	Wood Edges Group B
LLSE Self Edge	LVFL Flat LVBP Bumper	LPVC PVC	LMFL Flat LMRB Ribbed	LWFL Flat LWTP Tapered Ply LWFP Flat Ply	LWSQ Square LWAR Arc LWBN Bullnose LWPR Prism LWPI Pivot	WWFL Flat WWTP Tapered Ply WWFP Flat Ply	WWSQ Square WWAR Arc WWBN Bullnose WWPR Prism WWPI Pivot



Specialty Tops					
Butcher Block	Ultrafoam	Acrylic	Corian Group A,B	Corian Group C,D	3form Chroma
BBFL Flat BBBN Bullnose	ULFP PVC ULFR Raw	AAOP Opaque AATL Translucent	C1FL Flat C1BN Bullnose C1PR Prism	C2FL Flat C2BN Bullnose C2PR Prism	3FFL Flat 3FBN Bullnose 3FPR Prism

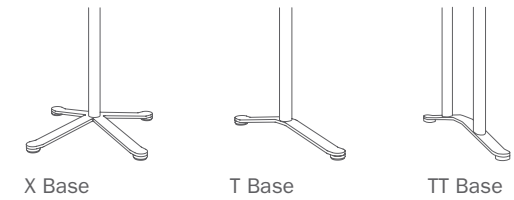

Options

Base Finishes		
Standard Powder Coat	use finish code	n/c
Polished or Satin Chrome (per base)	use finish code	\$213
Premium Plated (per base)	use finish code	Ⓛ
Custom Powder Coat (set-up charge)	CPC	\$363

Base Options		
Alternate Height Base (per column)	AH	\$66

Top Materials and Finishes		
Standard Laminates	use manufacturers finish code	n/c
Premium Laminates	PRL	Ⓛ
Custom Wood Veneer	CWV	Ⓛ
Special Pattern Veneer	SPV	Ⓛ
Stain to Match (set-up charge)	STM	\$412

Top Options		
Custom Size	CS	Ⓛ
Custom Shape	CSH	Ⓛ
Custom Radius Corner	CRC	Ⓛ
3" Radius Corner (per corner)	CRL3	\$34
(laminate self edge, ultrafoam, Corian®, 3form chroma)		
3" Wood Radius Corner (per corner)	CRW3	\$82
(not available in LWFL, WWFL, LWPI and WWPI)		

Grommets		
2" Round Metal Grommet - Matte Black	GMBK	\$138
2" Round Metal Grommet - Satin Chrome	GMSC	\$138
2" Round Metal Grommet - Polished Chrome	GMPC	\$138
2" Round Plastic Grommet - Matte Black	GPMBK	\$44
Grommet location	use location code	n/c

Edge Options		
1.75" Thick Edge (per table)	175E	15%
(see edge details for specific profiles)		

Complete Table List Pricing

	Top Size	Base Qty.	Base Style	Model #	\$								
Round	24	1	X	PRX24RD	1,114	1,114	1,164	1,212	1,322	1,491	1,332	1,563	
	30	1	X	PRX30RD	1,234	1,234	1,296	1,329	1,495	1,676	1,495	1,763	
	36	1	X	PRX36RD	1,364	1,364	1,436	1,482	1,671	1,881	1,697	1,986	
	42	1	X	PRX42RD	1,465	1,465	1,545	1,545	1,787	2,045	1,881	2,171	
	48	1	X	PRX48RD	1,733	1,733	1,824	1,851	2,091	2,387	2,202	2,536	
	54	1	X	PRX54RD	1,844	1,844	1,949	1,978	2,307	2,918	2,445	3,132	
	60	1	X	PRX60RD	2,021	2,021	2,134	2,188	2,427	3,001	2,786	3,227	
Oval	36	72	2	T	PRT36720V	1,824	1,824	1,875	1,900	2,083	2,305	2,256	2,472
	42	54	2	T	PRT42540V	1,801	1,801	1,828	1,892	2,033	2,360	2,184	2,420
	42	78	2	T	PRT42780V	2,093	2,093	2,134	2,179	2,327	2,548	2,470	2,717
	42	84	2	T	PRT42840V	2,149	2,149	2,203	2,247	2,377	2,628	2,523	2,807
	48	78	2	TT	PRTT48780V	2,284	2,284	2,341	2,387	2,510	2,759	2,662	2,942
	48	96	2	TT	PRTT48960V	2,460	2,460	2,516	2,566	2,658	2,930	3,020	3,337
Racetrack	30	60	2	T	PRT3060RA	1,557	1,557	1,615	1,637	1,927	2,205	2,028	2,373
	30	72	2	T	PRT3072RA	1,625	1,625	1,697	1,722	2,001	2,345	2,114	2,477
	30	84	2	T	PRT3084RA	1,855	1,855	1,919	1,960	2,098	2,584	2,224	2,781
	30	96	2	T	PRT3096RA	1,925	1,925	1,997	2,041	2,192	2,798	2,322	2,985
	36	60	2	T	PRT3660RA	1,723	1,723	1,791	1,813	2,083	2,390	2,194	2,550
	36	72	2	T	PRT3672RA	1,803	1,803	1,882	1,907	2,215	2,558	2,342	2,729
	36	84	2	T	PRT3684RA	2,040	2,040	2,119	2,161	2,315	2,785	2,459	3,009
	36	96	2	TT	PRT3696RA	2,220	2,220	2,313	2,354	2,522	3,111	2,677	3,288
	42	72	2	TT	PRTT4272RA	1,987	1,987	2,061	2,092	2,376	2,771	2,447	3,055
	42	84	2	TT	PRTT4284RA	2,241	2,241	2,308	2,352	2,475	3,026	2,621	3,346
	42	96	2	TT	PRTT4296RA	2,337	2,337	2,406	2,455	2,598	3,224	2,761	3,621

Continued on next page

How to Order

Table Model Number				Top Finish Selection		Options
PRX Base Series	36 Top Size	RD Top Shape	WWSQ Top Material Edge Profile	MBK Base Finish	WMW Top Finish	WMW Edge Finish
A PRX36RDWWSQMBK is a Presidio series 36" round table with a black powder coat X-base and a wood veneer 1.25" thick top with a 1.25" square wood edge profile.				The codes: WMW WMW specify a medium walnut top, with a medium walnut edge.		The code: AH specifies alternate height base.

Laminate Tops				Wood Veneer Tops			
Self Edge	Vinyl Edges	PVC Edges	Metal Edges	Wood Edges Group A	Wood Edges Group B	Wood Edges Group A	Wood Edges Group B
LLSE Self Edge	LVFL Flat	LPVC PVC	LMFL Flat	LWFL Flat	LWSQ Square	WWFL Flat	WWSQ Square
	LVBWP Bumper		LMRB Ribbed	LWTP Tapered Ply	LWAR Arc	WWTP Tapered Ply	WWAR Arc
				LWFP Flat Ply	LWBN Bullnose	WWFP Flat Ply	WWBN Bullnose
					LWPR Prism		WWPR Prism
					LWPI Pivot		WWPI Pivot

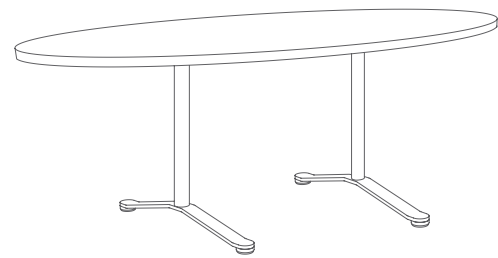

Specialty Tops				
Butcher Block	Ultrafoam	Acrylic	Corian Group A,B	Corian Group C,D
BBFL Flat	ULFP PVC	AAOP Opaque	C1FL Flat	C2FL Flat
BBBN Bullnose	ULFR Raw	AATL Translucent	C1BN Bullnose	C2BN Bullnose
			C1PR Prism	C2PR Prism
				3FFL Flat
				3FBN Bullnose
				3FPR Prism

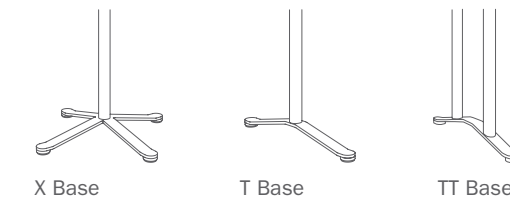

Options

Base Finishes		
Standard Powder Coat	use finish code	n/c
Polished or Satin Chrome (per base)	use finish code	\$213
Premium Plated (per base)	use finish code	Ⓛ
Custom Powder Coat (set-up charge)	CPC	\$363

Base Options		
Alternate Height Base (per column)	AH	\$66

Top Materials and Finishes		
Standard Laminates	use manufacturers finish code	n/c
Premium Laminates	PRL	Ⓛ
Custom Wood Veneer	CWV	Ⓛ
Special Pattern Veneer	SPV	Ⓛ
Stain to Match (set-up charge)	STM	\$412

Top Options		
Custom Size	CS	Ⓛ
Custom Shape	CSH	Ⓛ
Custom Radius Corner	CRC	Ⓛ
3" Radius Corner (per corner)	CRL3	\$34
(laminate self edge, ultrafoam, Corian®, 3form chroma)		
3" Wood Radius Corner (per corner)	CRW3	\$82
(not available in LWFL, WWFL, LWPI and WWPI)		

Grommets		
2" Round Metal Grommet - Matte Black	GMBK	\$138
2" Round Metal Grommet - Satin Chrome	GMSC	\$138
2" Round Metal Grommet - Polished Chrome	GMPC	\$138
2" Round Plastic Grommet - Matte Black	GPMBK	\$44
Grommet location	use location code	n/c

Edge Options		
1.75" Thick Edge (per table)	175E	15%
(see edge details for specific profiles)		

Complete Table List Pricing

	Top Size	Base Qty.	Base Style	Model #	\$							
Racetrack	48 96	2	TT	PRTT4896RA	2,610	2,610	2,690	2,740	2,970	3,621	3,339	3,847
	48 120	2	TT	PRTT48120RA	2,822	2,822	2,923	2,985	3,213	3,960	3,643	4,300
	48 144	3	TT	PRTT48144RA	3,820	3,820	3,935	4,012	4,253	5,063	4,765	5,488
	48 168	3	TT	PRTT48168RA	4,035	4,035	4,158	4,245	4,504	5,432	5,080	5,914
	60 120	2	TT	PRTT60120RA	3,094	3,094	3,203	3,279	3,394	4,300	3,843	4,697
	60 144	3	TT	PRTT60144RA	4,144	4,144	4,245	4,337	4,592	5,432	4,924	5,901
60 168	3	TT	PRTT60168RA	4,409	4,409	4,520	4,625	4,886	5,827	5,558	6,677	
Square	24 24	1	X	PRX2424SQ	1,114	1,114	1,170	1,224	1,322	1,491	1,332	1,563
	30 30	1	X	PRX3030SQ	1,234	1,234	1,302	1,349	1,495	1,676	1,495	1,763
	36 36	1	X	PRX3636SQ	1,364	1,364	1,432	1,501	1,661	1,881	1,697	1,986
	42 42	1	X	PRX4242SQ	1,618	1,618	1,694	1,743	1,952	2,210	2,046	2,336
	48 48	1	X	PRX4848SQ	1,735	1,735	1,824	1,883	2,091	2,387	2,202	2,536
Rectangle	18 48	2	T	PRT1848RE	1,261	1,261	1,312	1,327	1,430	1,679	1,496	1,707
	18 60	2	T	PRT1860RE	1,311	1,311	1,371	1,389	1,510	1,792	1,574	1,850
	18 72	2	T	PRT1872RE	1,358	1,358	1,424	1,445	1,594	1,906	1,662	1,992
	18 84	2	T	PRT1884RE	1,510	1,510	1,562	1,594	1,739	2,047	1,833	2,177
	18 96	2	T	PRT1896RE	1,594	1,594	1,641	1,679	1,796	2,160	1,895	2,282
	24 30	1	X	PRX2430RE	1,203	1,203	1,250	1,262	1,443	1,629	1,524	1,709
	24 36	1	X	PRX2436RE	1,282	1,282	1,334	1,348	1,556	1,737	1,622	1,825
	24 42	1	X	PRX2442RE	1,315	1,315	1,360	1,375	1,597	1,796	1,667	1,891
	24 48	1	X	PRX2448RE	1,350	1,350	1,406	1,424	1,669	1,891	1,749	1,996
	24 60	2	T	PRT2460RE	1,377	1,377	1,437	1,458	1,718	1,971	1,807	2,091
	24 72	2	T	PRT2472RE	1,435	1,435	1,505	1,529	1,815	2,105	1,918	2,243
	24 84	2	T	PRT2484RE	1,652	1,652	1,717	1,757	1,897	2,385	2,010	2,560
	24 96	2	T	PRT2496RE	1,710	1,710	1,781	1,825	1,979	2,506	2,101	2,696

Continued on next page

How to Order

Table Model Number				Top Finish Selection		Options	
PRT Base Series	2460 Top Size	RE Top Shape	WWSQ Top Material Edge Profile	MBK Base Finish	WMW Top Finish	WMW Edge Finish	GMBK Matte Black Grommet
A PRT2460REWWSQMBK is a Presidio series 24" x 60" rectangle table with two black powder coat T-bases and a wood veneer 1.25" thick top with a 1.25" square wood edge profile.				The codes: WMW WMW specify a medium walnut top, with a medium walnut edge.		The code: GMBK specifies a matte black 2" diameter metal grommet.	
						E Location "E"	
						The code: E specifies the location of the grommet.	

Laminate Tops				Wood Veneer Tops			
Self Edge	Vinyl Edges	PVC Edges	Metal Edges	Wood Edges Group A	Wood Edges Group B	Wood Edges Group A	Wood Edges Group B
LLSE Self Edge	LVFL Flat	LPVC PVC	LMFL Flat	LWFL Flat	LWSQ Square	WWFL Flat	WWSQ Square
	LVBWP Bumper		LMRB Ribbed	LWTP Tapered Ply	LWAR Arc	WWTP Tapered Ply	WWAR Arc
				LWFP Flat Ply	LWBN Bullnose	WWFP Flat Ply	WWBN Bullnose
					LWPR Prism		WWPR Prism
					LWPI Pivot		WWPI Pivot

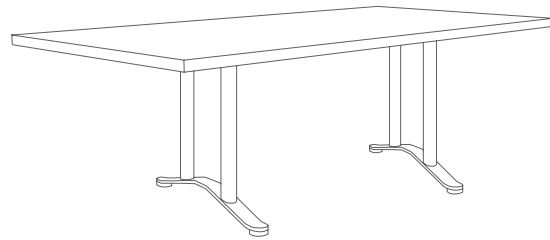

Specialty Tops					
Butcher Block	Ultrafoam	Acrylic	Corian Group A,B	Corian Group C,D	3form Chroma
BBFL Flat	ULFP PVC	AAOP Opaque	C1FL Flat	C2FL Flat	3FFL Flat
BBBN Bullnose	ULFR Raw	AATL Translucent	C1BN Bullnose	C2BN Bullnose	3FBN Bullnose
			C1PR Prism	C2PR Prism	3FPR Prism

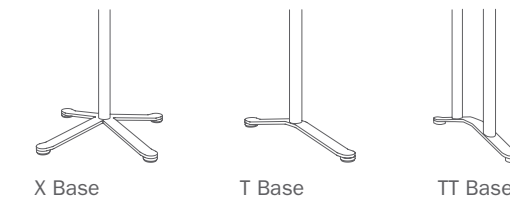

Complete Table List Pricing

Top Size	Base Qty.	Base Style	Model #	\$								
30 36	1	X	PRX3036RE	1,327	1,327	1,372	1,387	1,609	1,807	1,681	1,903	
30 42	1	X	PRX3042RE	1,362	1,362	1,414	1,432	1,704	1,926	1,786	2,037	
30 48	1	X	PRX3048RE	1,564	1,564	1,620	1,640	1,914	2,155	2,005	2,274	
30 60	2	T	PRT3060RE	1,545	1,545	1,609	1,633	1,925	2,201	2,028	2,337	
30 72	2	T	PRT3072RE	1,613	1,613	1,690	1,717	2,001	2,314	2,115	2,464	
30 84	2	T	PRT3084RE	1,845	1,845	1,911	1,956	2,096	2,584	2,219	2,767	
30 96	2	T	PRT3096RE	1,915	1,915	1,988	2,036	2,191	2,757	2,327	2,962	
36 42	2	T	PRT3642RE	1,575	1,575	1,634	1,653	1,924	2,169	2,017	2,289	
36 48	2	T	PRT3648RE	1,615	1,615	1,677	1,698	1,978	2,239	2,075	2,367	
36 60	2	T	PRT3660RE	1,710	1,710	1,783	1,807	2,083	2,379	2,194	2,527	
36 72	2	T	PRT3672RE	1,793	1,793	1,870	1,898	2,211	2,546	2,336	2,715	
36 84	2	T	PRT3684RE	2,038	2,038	2,107	2,153	2,315	2,781	2,455	2,978	
36 96	2	TT	PRT3696RE	2,220	2,220	2,303	2,347	2,520	3,055	2,673	3,274	
42 72	2	TT	PRTT4272RE	1,977	1,977	2,042	2,075	2,376	2,771	2,447	2,864	
42 84	2	TT	PRTT4284RE	2,233	2,233	2,303	2,352	2,490	2,998	2,726	3,311	
42 96	2	TT	PRTT4296RE	2,327	2,327	2,404	2,457	2,611	3,224	2,868	3,354	
48 96	2	TT	PRTT4896RE	2,608	2,608	2,683	2,738	2,966	3,621	3,339	3,826	
48 120	2	TT	PRTT48120RE	2,820	2,820	2,918	2,985	3,209	3,847	3,643	4,131	
48 144	3	TT	PRTT48144RE	3,800	3,800	3,895	3,975	4,220	4,866	4,722	5,257	
48 168	3	TT	PRTT48168RE	4,028	4,028	4,128	4,220	4,451	5,148	5,012	5,583	
60 120	2	TT	PRTT60120RE	3,081	3,081	3,173	3,254	3,429	4,073	3,847	4,471	
60 144	3	TT	PRTT60144RE	4,096	4,096	4,199	4,296	4,563	5,148	5,152	5,674	
60 168	3	TT	PRTT60168RE	4,405	4,405	4,478	4,590	4,846	5,772	5,506	6,451	

Continued on next page

*T-bases can be specified on 30" x 42" and 30" x 48" rectangle tables, please refer to Base Only Pricing (p.220) and Top Only Pricing (p.230).

X-bases are recommended for dining applications.

\$					
2,080	1,360	2,552	2,056	2,323	3,721
2,325	1,402	2,795	2,194	2,504	4,159
2,550	1,610	3,209	2,511	2,863	4,752
2,748	1,602	3,638	2,697	3,135	5,488
3,053	1,681	4,380	2,983	3,504	6,360
3,236	1,886	-	-	-	-
3,419	1,968	-	-	-	-
2,704	1,622	-	2,739	2,916	4,921
2,770	1,671	3,612	3,067	3,151	5,427
3,116	1,776	4,480	3,089	3,608	6,468
3,468	1,871	5,063	3,416	4,034	7,454
3,818	2,091	6,279	-	-	-
4,263	2,288	6,715	-	-	-
-	2,064	-	-	-	-
-	2,296	-	-	-	-
-	2,407	7,462	-	-	-
-	2,698	-	-	-	-
-	-	-	-	-	-
-	-	-	-	-	-
-	-	-	-	-	-

Options

Base Finishes		
Standard Powder Coat	use finish code	n/c
Polished or Satin Chrome (per base)	use finish code	\$213
Premium Plated (per base)	use finish code	Ⓛ
Custom Powder Coat (set-up charge)	CPC	\$363

Base Options		
Alternate Height Base (per column)	AH	\$66

Top Materials and Finishes		
Standard Laminates	use manufacturers finish code	n/c
Premium Laminates	PRL	Ⓛ
Custom Wood Veneer	CWV	Ⓛ
Special Pattern Veneer	SPV	Ⓛ
Stain to Match (set-up charge)	STM	\$412

Top Options		
Custom Size	CS	Ⓛ
Custom Shape	CSH	Ⓛ
Custom Radius Corner	CRC	Ⓛ
3" Radius Corner (per corner)	CRL3	\$34
(laminate self edge, ultrafoam, Corian®, 3form chroma)		
3" Wood Radius Corner (per corner)	CRW3	\$82
(not available in LWFL, WWFL, LWPI and WWPI)		

Grommets		
2" Round Metal Grommet - Matte Black	GMBK	\$138
2" Round Metal Grommet - Satin Chrome	GMSC	\$138
2" Round Metal Grommet - Polished Chrome	GMPC	\$138
2" Round Plastic Grommet - Matte Black	GPMBK	\$44
Grommet location	use location code	n/c

Edge Options		
1.75" Thick Edge (per table)	175E	15%
(see edge details for specific profiles)		

How to Order

Table Model Number				Top Finish Selection		Options	
PRTT Base Series	4272 Top Size	RE Top Shape	WWSQ Top Material Edge Profile	MBK Base Finish	WMW Top Finish	WMW Edge Finish	GMBK Matte Black Grommet
A PRTT4272REWWSQMBK is a Presidio series 42" x 72" rectangle table with two black powder coat TT-bases and a wood veneer 1.25" thick top with a 1.25" square wood edge profile.				The codes: WMW WMW specify a medium walnut top, with a medium walnut edge.		The code: GMBK specifies a matte black 2" diameter metal grommet.	
						The code: E specifies the location of the grommet.	

Laminate Tops				Wood Veneer Tops			
Self Edge	Vinyl Edges	PVC Edges	Metal Edges	Wood Edges Group A	Wood Edges Group B	Wood Edges Group A	Wood Edges Group B
LLSE Self Edge	LVFL Flat LVBP Bumper	LPVC PVC	LMFL Flat LMRB Ribbed	LWFL Flat LWTP Tapered Ply LWFP Flat Ply	LWSQ Square LWAR Arc LWBN Bullnose LWPR Prism LWPI Pivot	WWFL Flat WWTP Tapered Ply WWFP Flat Ply	WWSQ Square WWAR Arc WWBN Bullnose WWPR Prism WWPI Pivot

Specialty Tops					
Butcher Block	Ultrafoam	Acrylic	Corian Group A,B	Corian Group C,D	3form Chroma
BBFL Flat BBBN Bullnose	ULFP PVC ULFR Raw	AAOP Opaque AATL Translucent	C1FL Flat C1BN Bullnose C1PR Prism	C2FL Flat C2BN Bullnose C2PR Prism	3FFL Flat 3FBN Bullnose 3FPR Prism

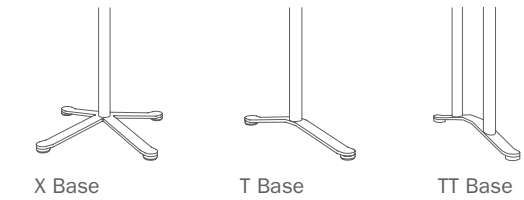

Options

Base Finishes		
Standard Powder Coat	use finish code	n/c
Polished or Satin Chrome (per base)	use finish code	\$213
Premium Plated (per base)	use finish code	Ⓛ
Custom Powder Coat (set-up charge)	CPC	\$363

Base Options		
Alternate Height Base (per column)	AH	\$66

Top Materials and Finishes		
Standard Laminates	use manufacturers finish code	n/c
Premium Laminates	PRL	Ⓛ
Custom Wood Veneer	CWV	Ⓛ
Special Pattern Veneer	SPV	Ⓛ
Stain to Match (set-up charge)	STM	\$412

Top Options		
Custom Size	CS	Ⓛ
Custom Shape	CSH	Ⓛ
Custom Radius Corner	CRC	Ⓛ
3" Radius Corner (per corner)	CRL3	\$34
(laminate self edge, ultrafoam, Corian®, 3form chroma)		
3" Wood Radius Corner (per corner) (not available in LWFL, WWFL, LWPI and WWPI)	CRW3	\$82

Grommets		
2" Round Metal Grommet - Matte Black	GMBK	\$138
2" Round Metal Grommet - Satin Chrome	GMSC	\$138
2" Round Metal Grommet - Polished Chrome	GMPC	\$138
2" Round Plastic Grommet - Matte Black	GPMBK	\$44
Grommet location	use location code	n/c

Edge Options		
1.75" Thick Edge (per table) (see edge details for specific profiles)	175E	15%

Complete Table List Pricing

	Top Size	Base Qty.	Base Style	Model #	\$							
Half Round	24 48	2	T	PRT2448HR	1,323	1,323	1,373	1,389	1,513	1,766	1,576	1,813
	30 60	2	T	PRT3060HR	1,558	1,558	1,626	1,649	1,767	2,063	1,851	2,197
	36 72	2	T	PRT3672HR	1,809	1,809	1,890	1,916	2,033	2,390	2,241	2,503
Arc Rectangle	30 60	2	T	PRT3060AR	1,558	1,558	1,613	1,635	1,892	2,205	2,028	2,349
	30 72	2	T	PRT3072AR	1,649	1,649	1,699	1,724	2,006	2,403	2,114	2,477
	30 84	2	T	PRT3084AR	1,827	1,827	1,908	1,948	2,096	2,545	2,222	2,781
	30 96	2	T	PRT3096AR	1,900	1,900	1,987	2,030	2,205	2,742	2,322	2,985
	36 60	2	T	PRT3660AR	1,743	1,743	1,785	1,807	2,083	2,445	2,194	2,550
	36 72	2	T	PRT3672AR	1,846	1,846	1,894	1,920	2,208	2,616	2,336	2,729
	36 84	2	T	PRT3684AR	2,025	2,025	2,110	2,151	2,315	2,785	2,455	2,984
	36 96	2	TT	PRT3696AR	2,210	2,210	2,303	2,343	2,522	3,139	2,677	3,288
	42 72	2	TT	PRTT4272AR	2,092	2,092	2,114	2,150	2,376	2,822	2,447	3,111
	42 84	2	TT	PRTT4284AR	2,220	2,220	2,303	2,347	2,463	3,084	2,726	3,372
	42 96	2	TT	PRTT4296AR	2,317	2,317	2,404	2,452	2,603	3,282	2,868	3,621
	48 96	2	TT	PRTT4896AR	2,630	2,630	2,684	2,734	2,966	3,678	3,339	3,905
	48 120	2	TT	PRTT48120AR	2,804	2,804	2,923	2,985	3,209	4,018	3,643	4,300
	48 144	3	TT	PRTT48144AR	3,779	3,779	3,901	3,975	4,261	5,121	4,773	5,547
	48 168	3	TT	PRTT48168AR	4,001	4,001	4,128	4,212	4,506	5,601	5,082	5,950
	60 120	2	TT	PRTT60120AR	3,067	3,067	3,212	3,289	3,452	4,328	3,872	4,674
	60 144	3	TT	PRTT60144AR	4,088	4,088	4,232	4,323	4,642	5,488	4,946	6,159
	60 168	3	TT	PRTT60168AR	4,364	4,364	4,510	4,615	4,930	5,885	5,269	6,549

Continued on next page

How to Order

Table Model Number				Top Finish Selection		Options	
PRTT Base Series	4272 Top Size	AR Top Shape	WWSQ Top Material Edge Profile	MBK Base Finish	WMW Top Finish	WMW Edge Finish	GMBK Matte Black Grommet
A PRTT4272ARWWSQMBK is a Presidio series 42" x 72" arc rectangle table with two black powder coat TT-bases and a wood veneer 1.25" thick top with a 1.25" square wood edge profile.				The codes: WMW WMW specify a medium walnut top, with a medium walnut edge.		The code: GMBK specifies a matte black 2" diameter metal grommet.	
						The code: C specifies the location of the grommet.	

Laminate Tops				Wood Veneer Tops			
Self Edge	Vinyl Edges	PVC Edges	Metal Edges	Wood Edges Group A	Wood Edges Group B	Wood Edges Group A	Wood Edges Group B
LLSE Self Edge	LVFL Flat	LPVC PVC	LMFL Flat	LWFL Flat	LWSQ Square	WWFL Flat	WWSQ Square
	LVBP Bumper		LMRB Ribbed	LWTP Tapered Ply	LWAR Arc	WWTP Tapered Ply	WWAR Arc
				LWFP Flat Ply	LWBN Bullnose	WWFP Flat Ply	WWBN Bullnose
					LWPR Prism		WWPR Prism
					LWPI Pivot		WWPI Pivot

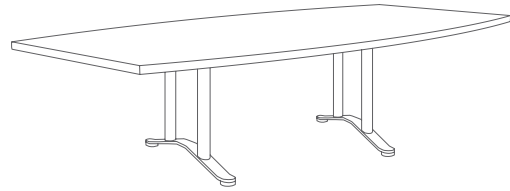

Specialty Tops				
Butcher Block	Ultrafoam	Acrylic	Corian Group A,B	Corian Group C,D
BBFL Flat	ULFP PVC	AAOP Opaque	C1FL Flat	C2FL Flat
BBBN Bullnose	ULFR Raw	AATL Translucent	C1BN Bullnose	C2BN Bullnose
			C1PR Prism	C2PR Prism
				3FFL Flat
				3FBN Bullnose
				3FPR Prism

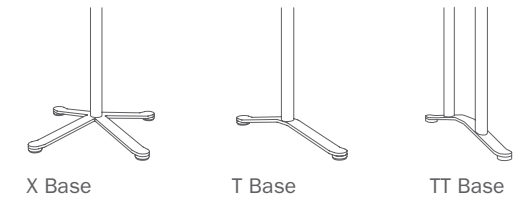

Complete Table List Pricing

Boat Shape	Top Size	Base Qty.	Base Style	Model #	\$							
	36 42 72	2	T	PRT3672BS	2,211	2,211	2,176	2,223	2,457	2,881	2,616	3,093
	36 48 84	2	TT	PRTT3684BS	2,426	2,426	2,491	2,547	2,852	3,247	3,047	3,494
	36 48 96	2	TT	PRTT3696BS	2,545	2,545	2,609	2,666	3,018	3,365	3,234	3,623
	36 48 120	2	TT	PRTT36120BS	2,782	2,782	2,859	2,930	3,401	3,634	3,665	3,926
	36 48 144	3	TT	PRTT36144BS	3,691	3,691	3,780	3,866	4,527	4,767	4,848	5,119
	36 48 168	3	TT	PRTT36168BS	3,917	3,917	4,029	4,127	4,862	4,988	5,226	5,368

\$						
-	-	-	-	-	-	-
-	-	-	-	-	-	-
-	-	-	-	-	-	-
-	-	-	-	-	-	-
-	-	-	-	-	-	-
-	-	-	-	-	-	-

Options

Base Finishes			
Standard Powder Coat		use finish code	n/c
Polished or Satin Chrome (per base)		use finish code	\$213
Premium Plated (per base)		use finish code	Ⓢ
Custom Powder Coat (set-up charge)		CPC	\$363

Base Options			
Alternate Height Base (per column)		AH	\$66

Top Materials and Finishes			
Standard Laminates		use manufacturers finish code	n/c
Premium Laminates		PRL	Ⓢ
Custom Wood Veneer		CWV	Ⓢ
Special Pattern Veneer		SPV	Ⓢ
Stain to Match (set-up charge)		STM	\$412

Top Options			
Custom Size		CS	Ⓢ
Custom Shape		CSH	Ⓢ
Custom Radius Corner		CRC	Ⓢ
3" Radius Corner (per corner)		CRL3	\$34
(laminates self edge, ultrafoam, Corian®, 3form chroma)			
3" Wood Radius Corner (per corner)		CRW3	\$82
(not available in LWFL, WWFL, LWPI and WWPI)			

Grommets			
2" Round Metal Grommet - Matte Black		GMBK	\$138
2" Round Metal Grommet - Satin Chrome		GMSC	\$138
2" Round Metal Grommet - Polished Chrome		GMPC	\$138
2" Round Plastic Grommet - Matte Black		GPMBK	\$44
Grommet location		use location code	n/c

Edge Options			
1.75" Thick Edge (per table)		175E	15%
(see edge details for specific profiles)			

How to Order

Table Model Number					Top Finish Selection		Options	
PRT Base Series	364272 Top Size	BS Top Shape	WWSQ Top Material Edge Profile	MBK Base Finish	WMW Top Finish	WMW Edge Finish	GMBK Matte Black Grommet	G Location "G"
A PRTT364272BSWWSQMBK is a Presidio series 36" x 42" x 72" boat shape table with two black powder coat T-bases and a wood veneer 1.25" thick top with a 1.25" square wood edge profile.					The codes: WMW WMW specify a medium walnut top, with a medium walnut edge.		The code: GMBK specifies a matte black 2" diameter metal grommet.	The code: G specifies the location of the grommet.



Laminate Tops

Self Edge	Vinyl Edges	PVC Edges	Metal Edges
LLSE Self Edge	LVFL Flat LVBP Bumper	LPVC PVC	LMFL Flat LMRB Ribbed

Wood Veneer Tops

Wood Edges Group A	Wood Edges Group B	Wood Edges Group A	Wood Edges Group B
LWFL Flat LWTP Tapered Ply LWFP Flat Ply	LWSQ Square LWAR Arc LWBN Bullnose LWPR Prism LWPI Pivot	WWFL Flat WWTP Tapered Ply WWFP Flat Ply	WWSQ Square WWAR Arc WWBN Bullnose WWPR Prism WWPI Pivot

Specialty Tops

Butcher Block	Ultrafoam	Acrylic	Corian Group A,B	Corian Group C,D	3form Chroma
BBFL Flat BBBN Bullnose	ULFP PVC ULFR Raw	AAOP Opaque AATL Translucent	C1FL Flat C1BN Bullnose C1PR Prism	C2FL Flat C2BN Bullnose C2PR Prism	3FFL Flat 3FBN Bullnose 3FPR Prism

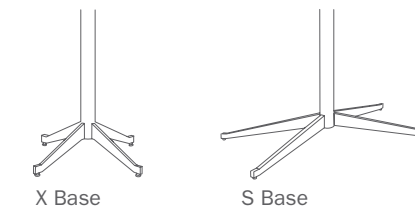

Options

Base Finishes		
Standard Powder Coat	use finish code	n/c
Polished or Satin Chrome (per base)	use finish code	\$363
Premium Plated (per base)	use finish code	\$
Custom Powder Coat (set-up charge)	CPC	\$363

Base Options		
Alternate Height Base (per column)	AH	\$66
Super Level Glides (per base)	GSL	\$34

Top Materials and Finishes		
Standard Laminates	use manufacturers finish code	n/c
Premium Laminates	PRL	\$
Custom Wood Veneer	CWV	\$
Special Pattern Veneer	SPV	\$412
Stain to Match (set-up charge)	STM	\$412

Top Options		
Custom Size	CS	\$
Custom Shape	CSH	\$
Custom Radius Corner	CRC	\$
3" Radius Corner (per corner)	CRL3	\$34
(laminates self edge, ultrafoam, Corian®, 3form chroma)		
3" Wood Radius Corner (per corner)	CRW3	\$82
(not available in LWFL, WWFL, LWPI and WWPI)		

Grommets		
2" Round Metal Grommet - Matte Black	GMBK	\$138
2" Round Metal Grommet - Satin Chrome	GMSC	\$138
2" Round Metal Grommet - Polished Chrome	GMPC	\$138
2" Round Plastic Grommet - Matte Black	GPMBK	\$44
Grommet location	use location code	n/c

Edge Options		
1.75" Thick Edge (per table)	175E	15%
(see edge details for specific profiles)		

Complete Table List Pricing

	Top Size	Base Qty.	Base Style	Model #	\$							
Round	30	1	X	RGX30RD	1,109	1,109	1,171	1,204	1,370	1,551	1,370	1,638
	36	1	X	RGX36RD	1,259	1,259	1,331	1,377	1,566	1,776	1,592	1,881
	42	1	X	RGX42RD	1,360	1,360	1,440	1,440	1,682	1,940	1,776	2,066
	48	1	X	RGX48RD	2,513	2,513	2,604	2,631	2,871	3,167	2,982	3,316
	54	1	X	RGX54RD	2,624	2,624	2,729	2,758	3,087	3,698	3,225	3,912
	60	1	X	RGX60RD	2,801	2,801	2,914	2,968	3,207	3,781	3,566	4,007
Oval	36 72	1	S	RGS36720V	3,224	3,224	3,275	3,300	3,483	3,705	3,656	3,872
	42 54	1	S	RGS42540V	3,201	3,201	3,228	3,292	3,433	3,760	3,584	3,820
	42 78	1	S	RGS42780V	3,493	3,493	3,534	3,579	3,727	3,948	3,870	4,117
	42 84	1	S	RGS42840V	3,649	3,649	3,703	3,747	3,877	4,128	4,023	4,307
	48 78	1	S	RGS48780V	3,684	3,684	3,741	3,787	3,910	4,159	4,062	4,342
	48 96	1	S	RGS48960V	3,860	3,860	3,916	3,966	4,058	4,330	4,420	4,737
Racetrack	30 72	1	S	RGS3072RA	3,125	3,125	3,197	3,222	3,501	3,845	3,614	3,977
	30 84	1	S	RGS3084RA	3,355	3,355	3,419	3,460	3,598	4,084	3,724	4,281
	30 96	1	S	RGS3096RA	3,425	3,425	3,497	3,541	3,692	4,298	3,822	4,485
	36 60	1	S	RGS3660RA	3,123	3,123	3,191	3,213	3,483	3,790	3,594	3,950
	36 72	1	S	RGS3672RA	3,203	3,203	3,282	3,307	3,615	3,958	3,742	4,129
	36 84	1	S	RGS3684RA	3,540	3,540	3,619	3,661	3,815	4,285	3,959	4,509
	36 96	1	S	RGS3696RA	3,620	3,620	3,713	3,754	3,922	4,511	4,077	4,688
	42 72	1	S	RGS4272RA	3,287	3,287	3,361	3,392	3,676	4,071	3,747	4,355
	42 84	1	S	RGS4284RA	3,641	3,641	3,708	3,752	3,875	4,426	4,021	4,746
	42 96	1	S	RGS4296RA	3,737	3,737	3,806	3,855	3,998	4,624	4,161	5,021
	48 96	1	S	RGS4896RA	3,840	3,840	3,920	3,970	4,200	4,851	4,569	5,077

Continued on next page

How to Order

Table Model Number				Top Finish Selection		Options
RGS Base Series	3672 Top Size	OV Top Shape	WWSQ Top Material Edge Profile	MBK Base Finish	WMW Top Finish	WMW Edge Finish
A RGS36720VWWSQMBK is a Regency series 36" X 72" oval table with a black powder coat scissor base and a wood veneer 1.25" thick top with a 1.25" square wood edge profile.				The codes: WMW WMW specify a medium walnut top, with a medium walnut edge.		The code: AH specifies alternate height base.

Laminate Tops				Wood Veneer Tops			
Self Edge	Vinyl Edges	PVC Edges	Metal Edges	Wood Edges Group A	Wood Edges Group B	Wood Edges Group A	Wood Edges Group B
LLSE Self Edge	LVFL Flat	LPVC PVC	LMFL Flat	LWFL Flat	LWSQ Square	WWFL Flat	WWSQ Square
	LVBP Bumper		LMRB Ribbed	LWTP Tapered Ply	LWAR Arc	WWTP Tapered Ply	WWAR Arc
				LWFP Flat Ply	LWBN Bullnose	WWFP Flat Ply	WWBN Bullnose
					LWPR Prism		WWPR Prism
					LWPI Pivot		WWPI Pivot



Specialty Tops				
Butcher Block	Ultrafoam	Acrylic	Corian Group A,B	Corian Group C,D
BBFL Flat	ULFP PVC	AAOP Opaque	C1FL Flat	C2FL Flat
BBBN Bullnose	ULFR Raw	AATL Translucent	C1BN Bullnose	C2BN Bullnose
			C1PR Prism	C2PR Prism
				3FFL Flat
				3FBN Bullnose
				3FPR Prism

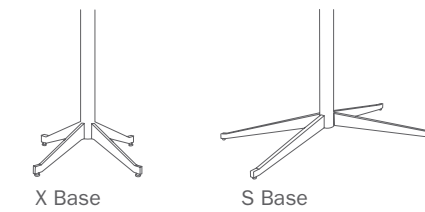

Complete Table List Pricing

	Top Size	Base Qty.	Base Style	Model #	\$							
Square	30 30	1	X	RGX3030SQ	1,109	1,109	1,177	1,224	1,370	1,551	1,370	1,638
	36 36	1	X	RGX3636SQ	1,259	1,259	1,327	1,396	1,556	1,776	1,592	1,881
	42 42	1	X	RGX4242SQ	2,398	2,398	2,474	2,523	2,732	2,990	2,826	3,116
	48 48	1	X	RGX4848SQ	2,515	2,515	2,604	2,663	2,871	3,167	2,982	3,316
Rectangle	30 48	1	X	RGX3048RE	1,294	1,294	1,350	1,370	1,644	1,885	1,735	2,004

\$					
1,753	1,142	2,122	1,741	1,969	3,118
2,155	1,302	2,655	2,146	2,465	4,091
3,797	2,453	4,357	3,565	3,989	6,265
4,103	2,581	5,215	3,995	4,540	7,572
2,280	1,340	2,939	2,241	2,593	4,482

Options

Base Finishes		
Standard Powder Coat	use finish code	n/c
Polished or Satin Chrome (per base)	use finish code	\$363
Premium Plated (per base)	use finish code	\$
Custom Powder Coat (set-up charge)	CPC	\$363

Base Options		
Alternate Height Base (per column)	AH	\$66
Super Level Glides (per base)	GSL	\$34

Top Materials and Finishes		
Standard Laminates	use manufacturers finish code	n/c
Premium Laminates	PRL	\$
Custom Wood Veneer	CWV	\$
Special Pattern Veneer	SPV	\$
Stain to Match (set-up charge)	STM	\$412

Top Options		
Custom Size	CS	\$
Custom Shape	CSH	\$
Custom Radius Corner	CRC	\$
3" Radius Corner (per corner)	CRL3	\$34
(laminates self edge, ultrafoam, Corian®, 3form chroma)		
3" Wood Radius Corner (per corner)	CRW3	\$82
(not available in LWFL, WWFL, LWPI and WWPI)		

Grommets		
2" Round Metal Grommet - Matte Black	GMBK	\$138
2" Round Metal Grommet - Satin Chrome	GMSC	\$138
2" Round Metal Grommet - Polished Chrome	GMPC	\$138
2" Round Plastic Grommet - Matte Black	GPMBK	\$44
Grommet location	use location code	n/c

Edge Options		
1.75" Thick Edge (per table)	175E	15%
(see edge details for specific profiles)		

How to Order

Table Model Number					Top Finish Selection		Options
RGX Base Series	3030 Top Size	SQ Top Shape	WWSQ Top Material Edge Profile	MBK Base Finish	WMW Top Finish	WMW Edge Finish	AH Alternate Height Base
A RGX3030SQWWSQMBK is a Regency series 30" x 30" square table with a black powder coat X-base and a wood veneer 1.25" thick top with a 1.25" square wood edge profile.					The codes: WMW WMW specify a medium walnut top, with a medium walnut edge.		The code: AH specifies alternate height base.

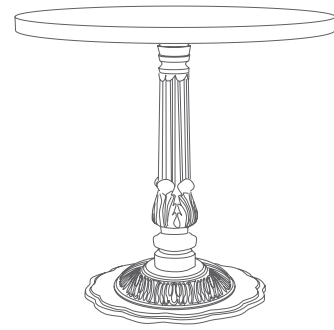

Laminate Tops Wood Veneer Tops

Self Edge	Vinyl Edges	PVC Edges	Metal Edges	Wood Edges Group A	Wood Edges Group B	Wood Edges Group A	Wood Edges Group B
LLSE Self Edge	LVFL Flat LVBP Bumper	LPVC PVC	LMFL Flat LMRB Ribbed	LWFL Flat LWTP Tapered Ply LWFP Flat Ply	LWSQ Square LWAR Arc LWBN Bullnose LWPR Prism LWPI Pivot	WWFL Flat WWTP Tapered Ply WWFP Flat Ply	WWSQ Square WWAR Arc WWBN Bullnose WWPR Prism WWPI Pivot

Specialty Tops

Butcher Block	Ultrafoam	Acrylic	Corian Group A,B	Corian Group C,D	3form Chroma
BBFL Flat BBBN Bullnose	ULFP PVC ULFR Raw	AAOP Opaque AATL Translucent	C1FL Flat C1BN Bullnose C1PR Prism	C2FL Flat C2BN Bullnose C2PR Prism	3FFL Flat 3FBN Bullnose 3FPR Prism

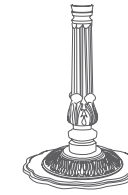

Options

Base Finishes		
Standard Powder Coat	use finish code	n/c
Custom Powder Coat (set-up charge)	CPC	\$363
Base Options		
Alternate Height Base (per column)	AH	\$166
Super Level Glides (per base)	GSL	\$34
Custom Top Plate Size	CTPS	Ⓛ
Top Materials and Finishes		
Standard Laminates	use manufacturers finish code	n/c
Premium Laminates	PRL	Ⓛ
Custom Wood Veneer	CWV	Ⓛ
Special Pattern Veneer	SPV	Ⓛ
Stain to Match (set-up charge)	STM	\$412

Complete Table List Pricing

	Top Size	Base Qty.	Model #	\$							
Round	24	1	SC24RD	790	790	839	888	998	1,167	1,008	1,239
	30	1	SC30RD	850	850	911	945	1,111	1,292	1,111	1,379
	36	1	SC36RD	930	930	1,002	1,048	1,237	1,447	1,263	1,552
	42	1	SC42RD	1,031	1,031	1,111	1,111	1,353	1,611	1,447	1,737
	48	1	SC48RD	1,134	1,134	1,224	1,251	1,492	1,788	1,603	1,937
Square	24 24	1	SC2424SQ	790	790	846	900	998	1,167	1,008	1,239
	30 30	1	SC3030SQ	850	850	918	965	1,111	1,292	1,111	1,379
	36 36	1	SC3636SQ	930	930	998	1,067	1,227	1,447	1,263	1,552
Rectangle	24 30	1	SC2430RE	819	819	866	878	1,059	1,245	1,139	1,325
	24 36	1	SC2436RE	847	847	900	913	1,121	1,302	1,187	1,391
	24 42	1	SC2442RE	880	880	925	940	1,162	1,362	1,232	1,457
	24 48	1	SC2448RE	915	915	972	990	1,234	1,457	1,315	1,562
	30 36	1	SC3036RE	893	893	937	953	1,174	1,373	1,247	1,469
	30 42	1	SC3042RE	928	928	980	998	1,269	1,492	1,352	1,602
	30 48	1	SC3048RE	965	965	1,021	1,041	1,315	1,556	1,405	1,675
	36 42	1	SC3642RE	975	975	1,034	1,053	1,325	1,570	1,418	1,689
	36 48	1	SC3648RE	1,016	1,016	1,078	1,099	1,378	1,640	1,476	1,768

\$					
1,154	808	1,399	1,315	1,491	1,903
1,401	883	1,858	1,586	1,850	2,904
1,708	973	2,319	1,934	2,292	3,813
2,233	1,084	2,969	2,326	2,802	4,949
2,508	1,199	3,825	2,770	3,373	6,254
1,224	822	1,401	1,230	1,383	1,870
1,494	883	1,862	1,481	1,710	2,858
1,825	973	2,325	1,817	2,135	3,762
1,341	842	1,613	1,345	1,529	2,453
1,475	876	1,897	1,459	1,675	2,780
1,669	913	2,023	1,570	1,823	3,115
1,724	953	2,208	1,683	1,971	3,449
1,646	926	2,117	1,621	1,889	3,286
1,891	967	2,360	1,760	2,070	3,725
1,951	1,010	2,609	1,911	2,263	4,153
2,105	1,023	-	2,140	2,317	4,321
2,171	1,071	3,013	2,467	2,552	4,828

Top Options		
Custom Size	CS	Ⓛ
Custom Shape	CSH	Ⓛ
Custom Radius Corner	CRC	Ⓛ
3" Radius Corner (per corner)	CRL3	\$34
(laminates self edge, ultrafoam, Corian®, 3form chroma)		
3" Wood Radius Corner (per corner)	CRW3	\$82
(not available in LWFL, WWFL, LWPI and WWPI)		

Edge Options		
1.75" Thick Edge (per table)	175E	15%
<i>(see edge details for specific profiles)</i>		

How to Order

Table Model Number					Top Finish Selection		Options
SC Base Series	36 Top Size	RD Top Shape	WWSQ Top Material Edge Profile	MBK Base Finish	WMW Top Finish	WMW Edge Finish	GSL Super Level Glides
A SC36RDWWSQMBK is a Scala series 36" round table with a decorative black powder coat base and a wood veneer 1.25" thick top with a 1.25" square wood edge profile.					The codes: WMW WMW specify a medium walnut top, with a medium walnut edge.		The code: GSL specifies super level glides.

Laminate Tops				Wood Veneer Tops			
Self Edge	Vinyl Edges	PVC Edges	Metal Edges	Wood Edges Group A	Wood Edges Group B	Wood Edges Group A	Wood Edges Group B
LLSE Self Edge	LVFL Flat	LPVC PVC	LMFL Flat	LWFL Flat	LWSQ Square	WWFL Flat	WWSQ Square
	LVBP Bumper		LMRB Ribbed	LWTP Tapered Ply	LWAR Arc	WWTP Tapered Ply	WWAR Arc
				LWFP Flat Ply	LWBN Bullnose	WWFP Flat Ply	WWBN Bullnose
					LWPR Prism		WWPR Prism
				LWPI Pivot			WWPI Pivot

Butcher Block	Ultrafoam	Acrylic	Corian Group A,B	Corian Group C,D	3form Chroma
BBFL Flat	ULFP PVC	AAOP Opaque	C1FL Flat	C2FL Flat	3FFL Flat
BBBN Bullnose	ULFR Raw	AATL Translucent	C1BN Bullnose	C2BN Bullnose	3FBN Bullnose
			C1PR Prism	C2PR Prism	3FPR Prism

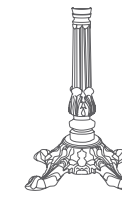

Complete Table List Pricing

	Top Size	Base Qty.	Model #	\$							
Round	30	1	SI30RD	715	715	777	810	976	1,157	976	1,244
	36	1	SI36RD	796	796	868	913	1,102	1,312	1,128	1,417
	42	1	SI42RD	896	896	977	977	1,218	1,476	1,312	1,602
	48	1	SI48RD	999	999	1,090	1,117	1,357	1,653	1,468	1,802
	54	1	SI54RD	1,110	1,110	1,216	1,245	1,573	2,185	1,711	2,398
Square	30 30	1	SI3030SQ	715	715	783	830	976	1,157	976	1,244
	36 36	1	SI3636SQ	796	796	863	932	1,092	1,312	1,128	1,417
	42 42	1	SI4242SQ	884	884	960	1,009	1,218	1,476	1,312	1,602
	48 48	1	SI4848SQ	1,001	1,001	1,090	1,149	1,357	1,653	1,468	1,802
Rectangle	30 36	1	SI3036RE	758	758	803	818	1,040	1,238	1,112	1,334
	30 42	1	SI3042RE	793	793	846	863	1,135	1,357	1,217	1,468
	30 48	1	SI3048RE	830	830	887	907	1,180	1,422	1,271	1,540
	36 42	1	SI3642RE	841	841	900	919	1,191	1,436	1,283	1,555
	36 48	1	SI3648RE	882	882	944	964	1,244	1,505	1,341	1,633

\$					
1,266	748	1,724	1,452	1,716	2,769
1,573	839	2,185	1,800	2,158	3,679
2,098	950	2,835	2,191	2,668	4,815
2,373	1,065	3,691	2,635	3,238	6,120
-	1,195	4,794	3,119	3,868	-
1,359	748	1,728	1,347	1,575	2,724
1,691	839	2,191	1,682	2,001	3,627
2,283	939	2,843	2,051	2,475	4,751
2,590	1,067	3,701	2,481	3,027	6,058
1,512	791	1,983	1,487	1,754	3,152
1,757	833	2,226	1,625	1,935	3,590
1,816	876	2,475	1,777	2,129	4,018
1,970	888	-	2,006	2,182	4,187
2,036	937	2,878	2,333	2,417	4,693

Options

Base Finishes		use finish code	n/c
Standard Powder Coat			n/c
Custom Powder Coat (set-up charge)		CPC	\$363
Base Options			
Alternate Height Base (per column)	AH		\$166
Super Level Glides (per base)	GSL		\$34
Custom Top Plate Size	CTPS		Ⓛ
Top Materials and Finishes		use manufacturers finish code	n/c
Standard Laminates			n/c
Premium Laminates	PRL		Ⓛ
Custom Wood Veneer	CWV		Ⓛ
Special Pattern Veneer	SPV		Ⓛ
Stain to Match (set-up charge)	STM		\$412
Top Options			
Custom Size	CS		Ⓛ
Custom Shape	CSH		Ⓛ
Custom Radius Corner	CRC		Ⓛ
3" Radius Corner (per corner)	CRL3		\$34
(laminates self edge, ultrafoam, Corian®, 3form chroma)			
3" Wood Radius Corner (per corner)	CRW3		\$82
(not available in LWFL, WWFL, LWPI and WWPI)			
Edge Options			
1.75" Thick Edge (per table)	175E		15%
(see edge details for specific profiles)			

How to Order

Table Model Number					Top Finish Selection		Options
SI Base Series	36 Top Size	RD Top Shape	WWSQ Top Material Edge Profile	MBK Base Finish	WMW Top Finish	WMW Edge Finish	GSL Super Level Glides
A SI36RDWWSQMBK is a Siena series 36" round table with a decorative black powder coat base and a wood veneer 1.25" thick top with a 1.25" square wood edge profile.					The codes: WMW WMW specify a medium walnut top, with a medium walnut edge.		The code: GSL specifies super level glides.

Laminate Tops				Wood Veneer Tops			
Self Edge	Vinyl Edges	PVC Edges	Metal Edges	Wood Edges Group A	Wood Edges Group B	Wood Edges Group A	Wood Edges Group B
LLSE Self Edge	LVFL Flat LVBP Bumper	LPVC PVC	LMFL Flat LMRB Ribbed	LWFL Flat LWTP Tapered Ply LWFP Flat Ply	LWSQ Square LWAR Arc LWBN Bullnose LWPR Prism LWPI Pivot	WWFL Flat WWTP Tapered Ply WWFP Flat Ply	WWSQ Square WWAR Arc WWBN Bullnose WWPR Prism WWPI Pivot

Complete Table List Pricing

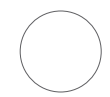
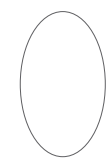
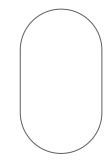
	Top Size	Base Qty.	Base Style	Model #	\$								
	24	1	X	SLX24RD	519	519	569	617	727	896	737	968	
	30	1	X	SLX30RD	634	634	696	729	895	1,076	895	1,163	
	36	1	X	SLX36RD	769	769	841	887	1,076	1,286	1,102	1,391	
	42	1	X	SLX42RD	870	870	950	950	1,192	1,450	1,286	1,576	
	48	1	X	SLX48RD	1,058	1,058	1,149	1,176	1,416	1,712	1,527	1,861	
	54	1	X	SLX54RD	1,169	1,169	1,274	1,303	1,632	2,243	1,770	2,457	
	60	1	X	SLX60RD	1,346	1,346	1,459	1,513	1,752	2,326	2,111	2,552	
	36	72	2	T	SLT3672OV	1,174	1,174	1,225	1,250	1,433	1,655	1,822	
	42	54	2	T	SLT4254OV	1,151	1,151	1,178	1,242	1,383	1,710	1,534	1,770
	42	78	2	T	SLT4278OV	1,443	1,443	1,484	1,529	1,677	1,898	1,820	2,067
	42	84	2	T	SLT4284OV	1,499	1,499	1,553	1,597	1,727	1,978	1,873	2,157
	48	78	2	TT	SLTT4878OV	1,654	1,654	1,711	1,757	1,880	2,129	2,032	2,312
	48	96	2	TT	SLTT4896OV	1,830	1,830	1,886	1,936	2,028	2,300	2,390	2,707
	30	60	2	T	SLT3060RA	937	937	995	1,017	1,307	1,585	1,408	1,753
	30	72	2	T	SLT3072RA	1,005	1,005	1,077	1,102	1,381	1,725	1,494	1,857
	30	84	2	T	SLT3084RA	1,235	1,235	1,299	1,340	1,478	1,964	1,604	2,161
	30	96	2	T	SLT3096RA	1,305	1,305	1,377	1,421	1,572	2,178	1,702	2,365
	36	60	2	T	SLT3660RA	1,073	1,073	1,141	1,163	1,433	1,740	1,544	1,900
	36	72	2	T	SLT3672RA	1,153	1,153	1,232	1,257	1,565	1,908	1,692	2,079
	36	84	2	T	SLT3684RA	1,390	1,390	1,469	1,511	1,665	2,135	1,809	2,359
	36	96	2	TT	SLTT3696RA	1,590	1,590	1,683	1,724	1,892	2,481	2,047	2,658
	42	72	2	TT	SLTT4272RA	1,357	1,357	1,431	1,462	1,746	2,141	1,817	2,425
	42	84	2	TT	SLTT4284RA	1,611	1,611	1,678	1,722	1,845	2,396	1,991	2,716
	42	96	2	TT	SLTT4296RA	1,707	1,707	1,776	1,825	1,968	2,594	2,131	2,991

Continued on next page

How to Order

Table Model Number					Top Finish Selection		Options
SLX Base Series	36 Top Size	RD Top Shape	WWSQ Top Material Edge Profile	MBK Base Finish	WMW Top Finish	WMW Edge Finish	AH Alternate Height Base
A SLX36RDWWSQMBK is a Slimline series 36" round table with a black powder coat X-base and a wood veneer 1.25" thick top with a 1.25" square wood edge profile.					The codes: WMW WMW specify a medium walnut top, with a medium walnut edge.		The code: AH specifies alternate height base.

Butcher Block	Ultrafoam	Acrylic	Corian Group A,B	Corian Group C,D	3form Chroma
BBFL Flat BBBN Bullnose	ULFP PVC ULFR Raw	AAOP Opaque AATL Translucent	C1FL Flat C1BN Bullnose C1PR Prism	C2FL Flat C2BN Bullnose C2PR Prism	3FFL Flat 3FBN Bullnose 3FPR Prism

\$	\$	\$	\$	\$	\$
884	538	1,129	1,044	1,221	1,633
1,185	667	1,642	1,371	1,635	2,688
1,547	812	2,158	1,774	2,132	3,653
2,072	924	2,809	2,165	2,642	4,789
2,432	1,124	3,750	2,694	3,297	6,178
-	1,254	4,853	3,178	3,926	-
-	1,400	6,067	3,729	4,641	-
-	-	-	-	-	-
-	-	3,987	-	-	-
-	-	5,374	-	-	-
-	-	-	-	-	-
-	-	6,272	-	-	-
-	-	-	-	-	-
-	-	-	-	-	-
-	-	-	-	-	-
-	-	-	-	-	-
-	-	-	-	-	-
-	-	-	-	-	-
-	-	-	-	-	-
-	-	-	-	-	-
-	-	-	-	-	-
-	-	-	-	-	-

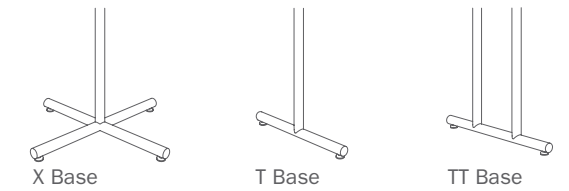

Options

Base Finishes	use finish code	n/c
Standard Powder Coat		n/c
Polished or Satin Chrome (per base)	use finish code	\$114
Premium Plated (per base)	use finish code	\$
Custom Powder Coat (set-up charge)	CPC	\$363

Base Options		
Alternate Height Base (per column)	AH	\$66
Super Level Glides (per base)	GSL	\$34
Locking Casters 2" Twin Wheel (qty. 4)	TWC2	\$56
Tilt-top - (standard cable release)	TMX/TMT	\$270 X-base/ \$418 T-base
Folding	FM	\$270 T-base

Top Materials and Finishes	use manufacturers finish code	n/c
Standard Laminates		n/c
Premium Laminates	PRL	\$
Custom Wood Veneer	CWV	\$
Special Pattern Veneer	SPV	\$
Stain to Match (set-up charge)	STM	\$412

Top Options		
Custom Size	CS	\$
Custom Shape	CSH	\$
Custom Radius Corner	CRC	\$
3" Radius Corner (per corner)	CRL3	\$34
(laminate self edge, ultrafoam, Corian®, 3form chroma)		
3" Wood Radius Corner (per corner)	CRW3	\$82
(not available in LWFL, WWFL, LWPI and WWPI)		
Ganging Clips (1 set includes 2 male and 2 female clips)	GC	\$148

Grommets		
2" Round Metal Grommet - Matte Black	GMBK	\$138
2" Round Metal Grommet - Satin Chrome	GMSC	\$138
2" Round Metal Grommet - Polished Chrome	GMPC	\$138
2" Round Plastic Grommet - Matte Black	GPMBK	\$44
Grommet location	use location code	n/c

Edge Options		
1.75" Thick Edge (per table)	175E	15%
(see edge details for specific profiles)		

Modesty Panels		
Fixed Modesty Panel Laminate (48,60,72)	MODLFX	\$248
Fixed Modesty Panel Veneer (48,60,72)	MODVFX	\$386
Folding Modesty Panel Laminate (48,60,72)	MODLFL	\$330
Folding Modesty Veneer (48,60,72)	MODVFL	\$468

Wire Management		
J-Trough (horizontal mount) - Matte Black	WMJ	\$116
Legway Wire Manager (vertical mount) - Matte Black	WML	\$56

Data and Power		
Recessed Power and Data Module Two	DPBS2	\$396
Recessed Power and Data Module Four	DPBS4	\$688
Retractable Power and Data Module Two	DPAS2	\$606
Retractable Power and Data Module Three	DPAS3	\$688
Under Top Mounted Power and Data Module Two	DPUS2	\$358

Other		
Table Truck for Folding Tables	TTRK	\$1512

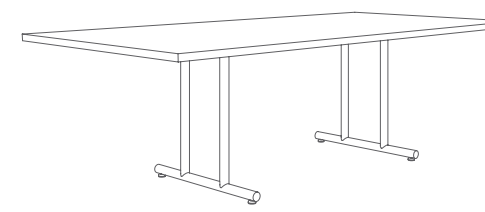

Laminate Tops				Wood Veneer Tops			
Self Edge	Vinyl Edges	PVC Edges	Metal Edges	Wood Edges Group A	Wood Edges Group B	Wood Edges Group A	Wood Edges Group B
LLSE Self Edge	LVFL Flat LVBP Bumper	LPVC PVC	LMFL Flat LMRB Ribbed	LWFL Flat LWTP Tapered Ply LWFP Flat Ply	LWSQ Square LWAR Arc LWBN Bullnose LWPR Prism LWPI Pivot	WWFL Flat WWTP Tapered Ply WWFP Flat Ply	WWSQ Square WWAR Arc WWBN Bullnose WWPR Prism WWPI Pivot

Butcher Block	Ultrafoam	Acrylic	Corian Group A,B	Corian Group C,D	3form Chroma
BBFL Flat BBBN Bullnose	ULFP PVC ULFR Raw	AAOP Opaque AATL Translucent	C1FL Flat C1BN Bullnose C1PR Prism	C2FL Flat C2BN Bullnose C2PR Prism	3FFL Flat 3FBN Bullnose 3FPR Prism

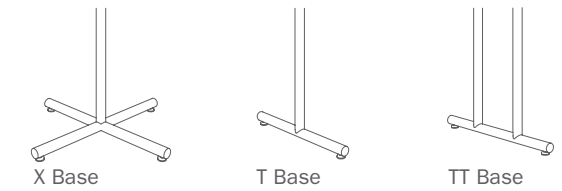

Complete Table List Pricing

Rectangle	Top Size	Base Qty.	Base Style	Model #	\$								
	30	36	1	X	SLX3036RE	732	732	777	792	1,014	1,212	1,086	1,308
	30	42	1	X	SLX3042RE	767	767	819	837	1,109	1,331	1,191	1,442
	30	48	1	X	SLX3048RE	889	889	945	965	1,239	1,480	1,330	1,599
	30	60	2	T	SLT3060RE	925	925	989	1,013	1,305	1,581	1,408	1,717
	30	72	2	T	SLT3072RE	993	993	1,070	1,097	1,381	1,694	1,495	1,844
	30	84	2	T	SLT3084RE	1,225	1,225	1,291	1,336	1,476	1,964	1,599	2,147
	30	96	2	T	SLT3096RE	1,295	1,295	1,368	1,416	1,571	2,137	1,707	2,342
	36	42	2	T	SLT3642RE	925	925	984	1,003	1,274	1,519	1,367	1,639
	36	48	2	T	SLT3648RE	965	965	1,027	1,048	1,328	1,589	1,425	1,717
	36	60	2	T	SLT3660RE	1,060	1,060	1,133	1,157	1,433	1,729	1,544	1,877
	36	72	2	T	SLT3672RE	1,143	1,143	1,220	1,248	1,561	1,896	1,686	2,065
	36	84	2	T	SLT3684RE	1,388	1,388	1,457	1,503	1,665	2,131	1,805	2,328
	36	96	2	TT	SLTT3696RE	1,590	1,590	1,673	1,717	1,890	2,425	2,043	2,644
	42	72	2	TT	SLTT4272RE	1,347	1,347	1,412	1,445	1,746	2,141	1,817	2,234
	42	84	2	TT	SLTT4284RE	1,603	1,603	1,673	1,722	1,860	2,368	2,096	2,681
	42	96	2	TT	SLTT4296RE	1,697	1,697	1,774	1,827	1,981	2,594	2,238	2,724
	48	96	2	TT	SLTT4896RE	1,878	1,878	1,953	2,008	2,236	2,891	2,609	3,096
	48	120	2	TT	SLTT48120RE	2,090	2,090	2,188	2,255	2,479	3,117	2,913	3,401
	48	144	3	TT	SLTT48144RE	2,705	2,705	2,800	2,880	3,125	3,771	3,627	4,162
	48	168	3	TT	SLTT48168RE	2,933	2,933	3,033	3,125	3,356	4,053	3,917	4,488
	60	120	2	TT	SLTT60120RE	2,351	2,351	2,443	2,524	2,699	3,343	3,117	3,741
	60	144	3	TT	SLTT60144RE	3,001	3,001	3,104	3,201	3,468	4,053	4,057	4,579
	60	168	3	TT	SLTT60168RE	3,310	3,310	3,383	3,495	3,751	4,677	4,411	5,356

Continued on next page

*T-bases can be specified on 30" x 42" and 30" x 48" rectangle tables, please refer to Base Only Pricing (p.231) and Top Only Pricing (p.241).
X-bases are recommended for dining applications.

How to Order

Table Model Number					Top Finish Selection		Options	
SLTT Base Series	4896 Top Size	RE Top Shape	WWSQ Top Material Edge Profile	MBK Base Finish	WMW Top Finish	WMW Edge Finish	GMBK Matte Black Grommet	E Location "E"
A SLTT4896REWWSQMBK is a Slimline series 48" x 96" rectangle table with two black powder coat TT-bases and a wood veneer 1.25" thick top with a 1.25" square wood edge profile.					The codes: WMW WMW specify a medium walnut top, with a medium walnut edge.		The code: GMBK specifies a matte black 2" diameter metal grommet.	The code: E specifies the location of the grommet.

\$	\$	\$	\$	\$	\$
1,485	765	1,957	1,461	1,728	3,126
1,730	807	2,200	1,599	1,909	3,564
1,875	935	2,534	1,836	2,188	4,077
2,128	982	3,018	2,077	2,515	4,868
2,433	1,061	3,760	2,363	2,884	5,740
2,616	1,266	-	-	-	-
2,799	1,348	-	-	-	-
2,054	972	-	2,089	2,266	4,271
2,120	1,021	2,962	2,417	2,501	4,777
2,466	1,126	3,830	2,439	2,958	5,818
2,818	1,221	4,413	2,766	3,384	6,804
3,168	1,441	5,629	-	-	-
3,633	1,658	6,085	-	-	-
-	1,434	-	-	-	-
-	1,666	-	-	-	-
-	1,777	6,832	-	-	-
-	1,968	-	-	-	-
-	-	-	-	-	-
-	-	-	-	-	-
-	-	-	-	-	-
-	-	-	-	-	-
-	-	-	-	-	-
-	-	-	-	-	-
-	-	-	-	-	-

Options

Base Finishes		
Standard Powder Coat	use finish code	n/c
Polished or Satin Chrome (per base)	use finish code	\$114
Premium Plated (per base)	use finish code	\$
Custom Powder Coat (set-up charge)	CPC	\$363

Base Options		
Alternate Height Base (per column)	AH	\$66
Super Level Glides (per base)	GSL	\$34
Locking Casters 2" Twin Wheel (qty. 4)	TWC2	\$56
Tilt-top - (standard cable release)	TMX/TMT	\$270 X-base/ \$418 T-base
Folding	FM	\$270 T-base

Top Materials and Finishes		
Standard Laminates	use manufacturers finish code	n/c
Premium Laminates	PRL	\$
Custom Wood Veneer	CWV	\$
Special Pattern Veneer	SPV	\$
Stain to Match (set-up charge)	STM	\$412

Top Options		
Custom Size	CS	\$
Custom Shape	CSH	\$
Custom Radius Corner	CRC	\$
3" Radius Corner (per corner)	CRL3	\$34
(laminate self edge, ultrafoam, Corian®, 3form chroma)		
3" Wood Radius Corner (per corner)	CRW3	\$82
(not available in LWFL, WWFL, LWPI and WWPI)		
Ganging Clips (1 set includes 2 male and 2 female clips)	GC	\$148

Grommets		
2" Round Metal Grommet - Matte Black	GMBK	\$138
2" Round Metal Grommet - Satin Chrome	GMSC	\$138
2" Round Metal Grommet - Polished Chrome	GMPC	\$138
2" Round Plastic Grommet - Matte Black	GPMBK	\$44
Grommet location	use location code	n/c

Edge Options		
1.75" Thick Edge (per table)	175E	15%
(see edge details for specific profiles)		

Modesty Panels		
Fixed Modesty Panel Laminate (48,60,72)	MODLFX	\$248
Fixed Modesty Panel Veneer (48,60,72)	MODVFX	\$386
Folding Modesty Panel Laminate (48,60,72)	MODLFL	\$330
Folding Modesty Veneer (48,60,72)	MODVFL	\$468

Wire Management		
J-Trough (horizontal mount) - Matte Black	WMJ	\$116
Legway Wire Manager (vertical mount) - Matte Black	WML	\$56

Data and Power		
Recessed Power and Data Module Two	DPBS2	\$396
Recessed Power and Data Module Four	DPBS4	\$688
Retractable Power and Data Module Two	DPAS2	\$606
Retractable Power and Data Module Three	DPAS3	\$688
Under Top Mounted Power and Data Module Two	DPUS2	\$358

Other		
Table Truck for Folding Tables	TTRK	\$1512

Laminate Tops				Wood Veneer Tops			
Self Edge	Vinyl Edges	PVC Edges	Metal Edges	Wood Edges Group A	Wood Edges Group B	Wood Edges Group A	Wood Edges Group B
LLSE Self Edge	LVFL Flat	LPVC PVC	LMFL Flat	LWFL Flat	LWSQ Square	WWFL Flat	WWSQ Square
	LVBP Bumper		LMRB Ribbed	LWTP Tapered Ply	LWAR Arc	WWTP Tapered Ply	WWAR Arc
				LWFP Flat Ply	LWBN Bullnose	WWFP Flat Ply	WWBN Bullnose
					LWPR Prism		WWPR Prism
					LWPI Pivot		WWPI Pivot

Specialty Tops				
Butcher Block	Ultrafoam	Acrylic	Corian Group A,B	Corian Group C,D
BBFL Flat	ULFP PVC	AAOP Opaque	C1FL Flat	C2FL Flat
BBBN Bullnose	ULFR Raw	AATL Translucent	C1BN Bullnose	C2BN Bullnose
			C1PR Prism	C2PR Prism
				3FFL Flat
				3FBN Bullnose
				3FPR Prism

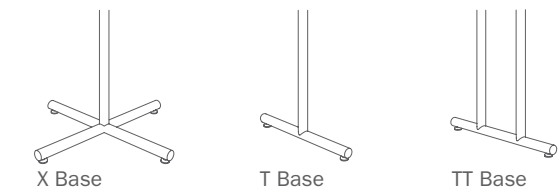

Complete Table List Pricing

	Top Size		Base Qty.	Base Style	Model #	\$							
Arc Rectangle	60	120	2	TT	SLTT60120AR	2,337	2,337	2,482	2,559	2,722	3,598	3,142	3,944
	60	144	3	TT	SLTT60144AR	2,993	2,993	3,137	3,228	3,547	4,393	3,851	5,064
	60	168	3	TT	SLTT60168AR	3,269	3,269	3,415	3,520	3,835	4,790	4,174	5,454
Boat Shape	36	42	2	T	SLT3672BS	1,561	1,561	1,526	1,573	1,807	2,231	1,966	2,443
	36	48	2	TT	SLTT3684BS	1,796	1,796	1,861	1,917	2,222	2,617	2,417	2,864
	36	48	2	TT	SLTT3696BS	1,915	1,915	1,979	2,036	2,388	2,735	2,604	2,993
	36	48	2	TT	SLTT36120BS	2,152	2,152	2,229	2,300	2,771	3,004	3,035	3,296
	36	48	3	TT	SLTT36144BS	2,746	2,746	2,835	2,921	3,582	3,822	3,903	4,174
	36	48	3	TT	SLTT36168BS	2,972	2,972	3,084	3,182	3,917	4,043	4,281	4,423

How to Order

Table Model Number				Top Finish Selection		Options	
SLTT Base Series	364884 Top Size	AR Top Shape	WWSQ Top Material Edge Profile	MBK Base Finish	WMW Top Finish	WMW Edge Finish	GMBK Matte Black Grommet
A SLTT364884ARWWSQMBK is a Slimline series 36" x 48" x 84" arc rectangle table with two black powder coat TT-bases and a wood veneer 1.25" thick top with a 1.25" square wood edge profile.				The codes: WMW WMW specify a medium walnut top, with a medium walnut edge.		The code: GMBK specifies a matte black 2" diameter metal grommet.	
						The code: G specifies the location of the grommet.	

\$	\$	\$	\$	\$	\$	\$
-	-	-	-	-	-	-
-	-	-	-	-	-	-
-	-	-	-	-	-	-
-	-	-	-	-	-	-
-	-	-	-	-	-	-
-	-	-	-	-	-	-
-	-	-	-	-	-	-

Options

Base Finishes	use finish code	n/c
Standard Powder Coat		n/c
Polished or Satin Chrome (per base)	use finish code	\$114
Premium Plated (per base)	use finish code	\$
Custom Powder Coat (set-up charge)	CPC	\$363

Base Options		
Alternate Height Base (per column)	AH	\$66
Super Level Glides (per base)	GSL	\$34
Locking Casters 2" Twin Wheel (qty. 4)	TWC2	\$56
Tilt-top - (standard cable release)	TMX/TMT	\$270 X-base/ \$418 T-base
Folding	FM	\$270 T-base

Top Materials and Finishes	use manufacturers finish code	n/c
Standard Laminates		n/c
Premium Laminates	PRL	\$
Custom Wood Veneer	CWV	\$
Special Pattern Veneer	SPV	\$
Stain to Match (set-up charge)	STM	\$412

Top Options		
Custom Size	CS	\$
Custom Shape	CSH	\$
Custom Radius Corner	CRC	\$
3" Radius Corner (per corner)	CRL3	\$34
(laminates self edge, ultrafoam, Corian®, 3form chroma)		
3" Wood Radius Corner (per corner)	CRW3	\$82
(not available in LWFL, WWFL, LWPI and WWPI)		
Gangging Clips (1 set includes 2 male and 2 female clips)	GC	\$148

Grommets		
2" Round Metal Grommet - Matte Black	GMBK	\$138
2" Round Metal Grommet - Satin Chrome	GMSC	\$138
2" Round Metal Grommet - Polished Chrome	GMPC	\$138
2" Round Plastic Grommet - Matte Black	GPMBK	\$44
Grommet location	use location code	n/c

Edge Options		
1.75" Thick Edge (per table)	175E	15%
(see edge details for specific profiles)		

Modesty Panels		
Fixed Modesty Panel Laminate (48,60,72)	MODLFX	\$248
Fixed Modesty Panel Veneer (48,60,72)	MODVFX	\$386
Folding Modesty Panel Laminate (48,60,72)	MODFL	\$330
Folding Modesty Veneer (48,60,72)	MODVFL	\$468

Wire Management		
J-Trough (horizontal mount) - Matte Black	WMJ	\$116
Legway Wire Manager (vertical mount) - Matte Black	WML	\$56

Data and Power		
Recessed Power and Data Module Two	DPBS2	\$396
Recessed Power and Data Module Four	DPBS4	\$688
Retractable Power and Data Module Two	DPAS2	\$606
Retractable Power and Data Module Three	DPAS3	\$688
Under Top Mounted Power and Data Module Two	DPUS2	\$358

Other		
Table Truck for Folding Tables	TRK	\$1512

Laminate Tops Wood Veneer Tops

Self Edge	Vinyl Edges	PVC Edges	Metal Edges	Wood Edges Group A	Wood Edges Group B	Wood Edges Group A	Wood Edges Group B
LLSE Self Edge	LVFL Flat LVBP Bumper	LPVC PVC	LMFL Flat LMRB Ribbed	LWFL Flat LWTP Tapered Ply LWFP Flat Ply	LWSQ Square LWAR Arc LWBN Bullnose LWPR Prism LWPI Pivot	WWFL Flat WWTP Tapered Ply WWFP Flat Ply	WWSQ Square WWAR Arc WWBN Bullnose WWPR Prism WWPI Pivot

Specialty Tops

Butcher Block	Ultrafoam	Acrylic	Corian Group A,B	Corian Group C,D	3form Chroma
BBFL Flat BBBN Bullnose	ULFP PVC ULFR Raw	AAOP Opaque AATL Translucent	C1FL Flat C1BN Bullnose C1PR Prism	C2FL Flat C2BN Bullnose C2PR Prism	3FFL Flat 3FBN Bullnose 3FPR Prism

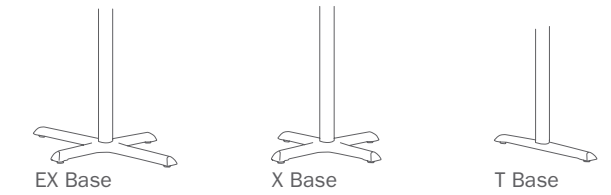

Options

Base Finishes		
Standard Black Wrinkle	MWR	n/c
Powder Coat	use finish code	\$110
Custom Powder Coat (set-up charge)	CPC	\$363

Base Options		
Alternate Height Base (per column)	AH	\$66
Super Level Glides (per base)	GSL	\$34
Custom Top Plate Size	CTPS	\$

Top Materials and Finishes		
Standard Laminates	use manufacturers finish code	n/c
Premium Laminates	PRL	\$
Custom Wood Veneer	CWV	\$
Special Pattern Veneer	SPV	\$
Stain to Match (set-up charge)	STM	\$412

Top Options		
Custom Size	CS	\$
Custom Shape	CSH	\$
Custom Radius Corner	CRC	\$
3" Radius Corner (per corner) (laminates self edge, ultrafoam, Corian®, 3form chroma)	CRL3	\$34
3" Wood Radius Corner (per corner) (not available in LWFL, WWFL, LWPI and WWPI)	CRW3	\$82

Edge Options		
1.75" Thick Edge (per table) (see edge details for specific profiles)	175E	15%

Complete Table List Pricing

	Top Size	Base Qty.	Base Style	Model #	\$							
Round	24	1	X	SVX24RD	319	319	369	417	527	696	537	768
	30	1	X	SVX30RD	379	379	441	474	640	821	640	908
	36	1	X	SVX36RD	479	479	551	597	786	996	812	1,101
	42	1	X	SVX42RD	580	580	660	660	902	1,160	996	1,286
	48	1	X	SVX48RD	798	798	889	916	1,156	1,452	1,267	1,601
	54	1	X	SVX54RD	909	909	1,014	1,043	1,372	1,983	1,510	2,197
	60	1	X	SVX60RD	1,086	1,086	1,199	1,253	1,492	2,066	1,851	2,292
Square	24 24	1	X	SVX2424SQ	319	319	375	429	527	696	537	768
	30 30	1	X	SVX3030SQ	379	379	447	494	640	821	640	908
	36 36	1	X	SVX3636SQ	479	479	547	616	776	996	812	1,101
	42 42	1	X	SVX4242SQ	683	683	759	808	1,017	1,275	1,111	1,401
	48 48	1	X	SVX4848SQ	800	800	889	948	1,156	1,452	1,267	1,601
Rectangle	24 30	1	X	SVX2430RE	348	348	395	407	588	774	669	854
	24 36	1	EX	SVEX2436RE	407	407	459	473	681	862	747	950
	24 42	1	EX	SVEX2442RE	440	440	485	500	722	921	792	1,016
	24 48	1	EX	SVEX2448RE	475	475	531	549	794	1,016	874	1,121
	24 60	2	T	SVT2460RE	557	557	618	639	899	1,152	987	1,272
	24 72	2	T	SVT2472RE	615	615	685	710	996	1,285	1,098	1,424
	30 36	1	EX	SVEX3036RE	452	452	497	512	734	932	806	1,028
	30 42	1	EX	SVEX3042RE	487	487	539	557	829	1,051	911	1,162
	30 48	1	EX	SVEX3048RE	524	524	580	600	874	1,115	965	1,234
	30 60	2	T	SVT3060RE	655	655	719	743	1,035	1,311	1,138	1,447
	30 72	2	T	SVT3072RE	723	723	800	827	1,111	1,424	1,225	1,574
	36 42	1	EX	SVEX3642RE	535	535	594	613	884	1,129	977	1,249
	36 48	1	EX	SVEX3648RE	575	575	637	658	938	1,199	1,035	1,327
	36 60	2	T	SVT3660RE	720	720	793	817	1,093	1,389	1,204	1,537
	36 72	2	T	SVT3672RE	803	803	880	908	1,221	1,556	1,346	1,725

\$					
684	338	929	844	1,021	1,433
930	412	1,387	1,116	1,380	2,433
1,257	522	1,868	1,484	1,842	3,363
1,782	634	2,519	1,875	2,352	4,499
2,172	864	3,490	2,434	3,037	5,918
-	994	4,593	2,918	3,666	-
-	1,140	5,807	3,469	4,381	-
754	352	931	759	912	1,400
1,023	412	1,392	1,011	1,239	2,388
1,375	522	1,875	1,366	1,685	3,311
2,082	738	2,642	1,850	2,274	4,550
2,388	866	3,500	2,280	2,825	5,857
871	371	1,143	875	1,058	1,982
1,035	436	1,457	1,018	1,234	2,339
1,229	472	1,582	1,129	1,382	2,675
1,284	512	1,767	1,243	1,531	3,008
1,554	605	-	1,508	1,861	3,741
1,804	672	-	1,747	2,171	4,406
1,205	485	1,677	1,181	1,448	2,846
1,450	527	1,920	1,319	1,629	3,284
1,510	570	2,169	1,471	1,823	3,712
1,858	712	2,748	1,807	2,245	4,598
2,163	791	3,490	2,093	2,614	5,470
1,664	582	-	1,699	1,876	3,881
1,730	631	2,572	2,027	2,111	4,387
2,126	786	3,490	2,099	2,618	5,478
2,478	881	4,073	2,426	3,044	6,464

How to Order

Table Model Number					Top Finish Selection		Options
SVX Base Series	36 Top Size	RD Top Shape	WWSQ Top Material Edge Profile	MBK Base Finish	WMW Top Finish	WMW Edge Finish	GSL Super Level Glides
A SVX36RDWWSQMBK is a Spacesaver series 36" round table with a black powder coat X-base and a wood veneer 1.25" thick top with a 1.25" square wood edge profile.					The codes: WMW WMW specify a medium walnut top, with a medium walnut edge.		The code: GSL specifies super level glides.

Laminate Tops				Wood Veneer Tops			
Self Edge	Vinyl Edges	PVC Edges	Metal Edges	Wood Edges Group A	Wood Edges Group B	Wood Edges Group A	Wood Edges Group B
LLSE Self Edge	LVFL Flat	LPVC PVC	LMFL Flat	LWFL Flat	LWSQ Square	WWFL Flat	WWSQ Square
	LVBP Bumper		LMRB Ribbed	LWTP Tapered Ply	LWAR Arc	WWTP Tapered Ply	WWAR Arc
				LWFP Flat Ply	LWBN Bullnose	WWFP Flat Ply	WWBN Bullnose
					LWPR Prism		WWPR Prism
					LWPI Pivot		WWPI Pivot

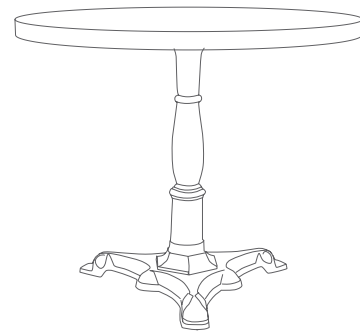

Complete Table List Pricing

	Top Size	Base Qty.	Model #	\$							
Round	30	1	T030RD	669	669	731	764	930	1,111	930	1,198
	36	1	T036RD	749	749	821	867	1,056	1,266	1,082	1,371
	42	1	T042RD	850	850	930	930	1,172	1,430	1,266	1,556
Square	30 30	1	T03030SQ	669	669	737	784	930	1,111	930	1,198
	36 36	1	T03636SQ	749	749	817	886	1,046	1,266	1,082	1,371
	42 42	1	T04242SQ	838	838	914	963	1,172	1,430	1,266	1,556
Rectangle	30 36	1	T03036RE	712	712	757	772	994	1,192	1,066	1,288
	30 42	1	T03042RE	747	747	799	817	1,089	1,311	1,171	1,422

Butcher Block	Ultrafoam	Acrylic	Corian Group A,B	Corian Group C,D	3form Chroma
BBFL Flat	ULFP PVC	AAOP Opaque	C1FL Flat	C2FL Flat	3FFL Flat
BBBN Bullnose	ULFR Raw	AATL Translucent	C1BN Bullnose	C2BN Bullnose	3FBN Bullnose
			C1PR Prism	C2PR Prism	3FPR Prism

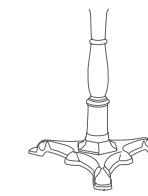

Options

Base Finishes		
Standard Powder Coat	use finish code	n/c
Custom Powder Coat (set-up charge)	CPC	\$363
Base Options		
Alternate Height Base (per column)	AH	\$166
Super Level Glides (per base)	GSL	\$34
Custom Top Plate Size	CTPS	Ⓛ
Top Materials and Finishes		
Standard Laminates	use manufacturers finish code	n/c
Premium Laminates	PRL	Ⓛ
Custom Wood Veneer	CWV	Ⓛ
Special Pattern Veneer	SPV	Ⓛ
Stain to Match (set-up charge)	STM	\$412
Top Options		
Custom Size	CS	Ⓛ
Custom Shape	CSH	Ⓛ
Custom Radius Corner	CRC	Ⓛ
3" Radius Corner (per corner)	CRL3	\$34
(laminates self edge, ultrafoam, Corian®, 3form chroma)		
3" Wood Radius Corner (per corner)	CRW3	\$82
(not available in LWFL, WWFL, LWPI and WWPI)		
Edge Options		
1.75" Thick Edge (per table)	175E	15%
<i>(see edge details for specific profiles)</i>		

\$					
1,220	702	1,677	1,406	1,670	2,723
1,527	792	2,138	1,754	2,112	3,633
2,052	904	2,789	2,145	2,622	4,769
1,313	702	1,682	1,301	1,529	2,678
1,645	792	2,145	1,636	1,955	3,581
2,237	893	2,797	2,005	2,429	4,705
1,465	745	1,937	1,441	1,708	3,106
1,710	787	2,180	1,579	1,889	3,544

How to Order

Table Model Number					Top Finish Selection		Options
TO Base Series	36 Top Size	RD Top Shape	WWSQ Top Material Edge Profile	MBK Base Finish	WMW Top Finish	WMW Edge Finish	GSL Super Level Glides
A T036RDWWSQMBK is a Toscana series 36" round table with a decorative black powder coat base and a wood veneer 1.25" thick top with a 1.25" square wood edge profile.					The codes: WMW WMW specify a medium walnut top, with a medium walnut edge.		The code: GSL specifies super level glides.

Laminate Tops				Wood Veneer Tops			
Self Edge	Vinyl Edges	PVC Edges	Metal Edges	Wood Edges Group A	Wood Edges Group B	Wood Edges Group A	Wood Edges Group B
LLSE Self Edge	LVFL Flat	LPVC PVC	LMFL Flat	LWFL Flat	LWSQ Square	WWFL Flat	WWSQ Square
	LVBP Bumper		LMRB Ribbed	LWTP Tapered Ply	LWAR Arc	WWTP Tapered Ply	WWAR Arc
				LWFP Flat Ply	LWBN Bullnose	WWFP Flat Ply	WWBN Bullnose
					LWPR Prism		WWPR Prism
					LWPI Pivot		WWPI Pivot

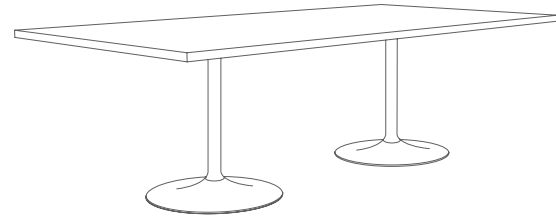

Specialty Tops					
Butcher Block	Ultrafoam	Acrylic	Corian Group A,B	Corian Group C,D	3form Chroma
BBFL Flat	ULFP PVC	AAOP Opaque	C1FL Flat	C2FL Flat	3FFL Flat
BBBN Bullnose	ULFR Raw	AATL Translucent	C1BN Bullnose	C2BN Bullnose	3FBN Bullnose
			C1PR Prism	C2PR Prism	3FPR Prism



Options

Base Finishes		
Standard Powder Coat	use finish code	n/c
Polished or Satin Chrome (per base)	use finish code	\$194
Premium Plated (per base)	use finish code	Ⓛ
Custom Powder Coat (set-up charge)	CPC	\$363

Base Options		
Alternate Height Base (per column)	AH	\$66
Super Level Glides (per base)	GSL	\$34
Custom Top Plate Size	CTPS	Ⓛ

Top Materials and Finishes		
Standard Laminates	use manufacturers finish code	n/c
Premium Laminates	PRL	Ⓛ
Custom Wood Veneer	CWV	Ⓛ
Special Pattern Veneer	SPV	Ⓛ
Stain to Match (set-up charge)	STM	\$412

Top Options		
Custom Size	CS	Ⓛ
Custom Shape	CSH	Ⓛ
Custom Radius Corner	CRC	Ⓛ
3" Radius Corner (per corner)	CRL3	\$34
(laminates self edge, ultrafoam, Corian®, 3form chroma)		
3" Wood Radius Corner (per corner)	CRW3	\$82
(not available in LWFL, WWFL, LWPI and WWPI)		

Grommets		
2" Round Metal Grommet - Matte Black	GMBK	\$138
2" Round Metal Grommet - Satin Chrome	GMSC	\$138
2" Round Metal Grommet - Polished Chrome	GMPC	\$138
2" Round Plastic Grommet - Matte Black	GPMBK	\$44
Grommet location	use location code	n/c

Edge Options		
1.75" Thick Edge (per table)	175E	15%
(see edge details for specific profiles)		

Complete Table List Pricing

	Top Size	Base Qty.	Base Style	Model #	\$								
Rectangle	36 42	1	24M	TL24M3642RE	1,140	1,140	1,199	1,218	1,489	1,734	1,582	1,854	
	36 48	1	24H	TL24H3648RE	1,295	1,295	1,357	1,378	1,658	1,919	1,755	2,047	
	36 60	2	18H	TL18H3660RE	1,960	1,960	2,033	2,057	2,333	2,629	2,444	2,777	
	36 72	2	18H	TL18H3672RE	2,043	2,043	2,120	2,148	2,461	2,796	2,586	2,965	
	36 84	2	18H	TL18H3684RE	2,288	2,288	2,357	2,403	2,565	3,031	2,705	3,228	
	36 96	2	18H	TL18H3696RE	2,370	2,370	2,453	2,497	2,670	3,205	2,823	3,424	
	42 72	2	24M	TL24M4272RE	2,207	2,207	2,272	2,305	2,606	3,001	2,677	3,094	
	42 84	2	24M	TL24M4284RE	2,463	2,463	2,533	2,582	2,720	3,228	2,956	3,541	
	42 96	2	24M	TL24M4296RE	2,557	2,557	2,634	2,687	2,841	3,454	3,098	3,584	
	48 96	2	24H	TL24H4896RE	2,898	2,898	2,973	3,028	3,256	3,911	3,629	4,116	
	48 120	2	24H	TL24H48120RE	3,110	3,110	3,208	3,275	3,499	4,137	3,933	4,421	
	48 144	3	24H	TL24H48144RE	4,235	4,235	4,330	4,410	4,655	5,301	5,157	5,692	
48 168	3	24H	TL24H48168RE	4,463	4,463	4,563	4,655	4,886	5,583	5,447	6,018		
Arc Rectangle	60 120	2	24XH	TL24XH60120RE	3,441	3,441	3,533	3,614	3,789	4,433	4,207	4,831	
	60 144	3	24XH	TL24XH60144RE	4,636	4,636	4,739	4,836	5,103	5,688	5,692	6,214	
	60 168	3	24XH	TL24XH60168RE	4,945	4,945	5,018	5,130	5,386	6,312	6,046	6,991	
	30 60	2	18M	TL18M3060AR	1,768	1,768	1,823	1,845	2,102	2,415	2,238	2,559	
	30 72	2	18M	TL18M3072AR	1,859	1,859	1,909	1,934	2,216	2,613	2,324	2,687	
	30 84	2	18M	TL18M3084AR	2,037	2,037	2,118	2,158	2,306	2,755	2,432	2,991	
	30 96	2	18M	TL18M3096AR	2,110	2,110	2,197	2,240	2,415	2,952	2,532	3,195	
	36 60	2	18H	TL18H3660AR	1,993	1,993	2,035	2,057	2,333	2,695	2,444	2,800	
	36 72	2	18H	TL18H3672AR	2,096	2,096	2,144	2,170	2,458	2,866	2,586	2,979	
	36 84	2	18H	TL18H3684AR	2,275	2,275	2,360	2,401	2,565	3,035	2,705	3,234	
	36 96	2	18H	TL18H3696AR	2,360	2,360	2,453	2,493	2,672	3,289	2,827	3,438	

Continued on next page

How to Order

Table Model Number					Top Finish Selection		Options	
TL24M Base Series	4272 Top Size	RE Top Shape	WWSQ Top Material Edge Profile	MBK Base Finish	WMW Top Finish	WMW Edge Finish	GMBK Matte Black Grommet	G Location "G"
A TL24M4272REWWSQMBK is a Tulip series 42" x 72" rectangle table with two black powder coat, medium-weighted round bases and a wood veneer 1.25" thick top with a 1.25" square wood edge profile.					The codes: WMW WMW specify a medium walnut top, with a medium walnut edge.		The code: GMBK specifies a matte black 2" diameter metal grommet.	The code: G specifies the location of the grommet.

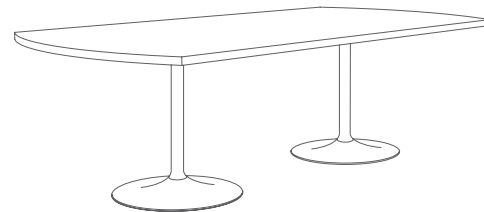

Laminate Tops

Self Edge	Vinyl Edges	PVC Edges	Metal Edges
LLSE Self Edge	LVFL Flat LVBP Bumper	LPVC PVC	LMFL Flat LMRB Ribbed

Wood Veneer Tops

Wood Edges Group A	Wood Edges Group B	Wood Edges Group A	Wood Edges Group B
LWFL Flat LWTP Tapered Ply LWFP Flat Ply	LWSQ Square LWAR Arc LWBN Bullnose LWPR Prism LWPI Pivot	WWFL Flat WWTP Tapered Ply WWFP Flat Ply	WWSQ Square WWAR Arc WWBN Bullnose WWPR Prism WWPI Pivot

Specialty Tops

Butcher Block	Ultrafoam	Acrylic	Corian Group A,B	Corian Group C,D	3form Chroma
BBFL Flat BBBN Bullnose	ULFP PVC ULFR Raw	AAOP Opaque AATL Translucent	C1FL Flat C1BN Bullnose C1PR Prism	C2FL Flat C2BN Bullnose C2PR Prism	3FFL Flat 3FBN Bullnose 3FPR Prism



Options

Base Finishes			
Standard Powder Coat		use finish code	n/c
Polished or Satin Chrome (per base)		use finish code	\$194
Premium Plated (per base)		use finish code	Ⓛ
Custom Powder Coat (set-up charge)		CPC	\$363

Base Options			
Alternate Height Base (per column)		AH	\$66
Super Level Glides (per base)		GSL	\$34
Custom Top Plate Size		CTPS	Ⓛ

Top Materials and Finishes			
Standard Laminates		use manufacturers finish code	n/c
Premium Laminates		PRL	Ⓛ
Custom Wood Veneer		CWV	Ⓛ
Special Pattern Veneer		SPV	Ⓛ
Stain to Match (set-up charge)		STM	\$412

Top Options			
Custom Size		CS	Ⓛ
Custom Shape		CSH	Ⓛ
Custom Radius Corner		CRC	Ⓛ
3" Radius Corner (per corner)		CRL3	\$34
3" Wood Radius Corner (per corner)		CRW3	\$82
(not available in LWFL, WWFL, LWPI and WWPI)			

Grommets			
2" Round Metal Grommet - Matte Black		GMBK	\$138
2" Round Metal Grommet - Satin Chrome		GMSC	\$138
2" Round Metal Grommet - Polished Chrome		GMPC	\$138
2" Round Plastic Grommet - Matte Black		GPMBK	\$44
Grommet location		use location code	n/c

Edge Options			
1.75" Thick Edge (per table)		175E	15%
(see edge details for specific profiles)			

Complete Table List Pricing

	Top Size	Base Qty.	Base Style	Model #	\$								
Arc Rectangle	42	72	2	24M	TL24M4272AR	2,322	2,322	2,344	2,380	2,606	3,052	2,677	3,341
	42	84	2	24M	TL24M4284AR	2,450	2,450	2,533	2,577	2,693	3,314	2,956	3,602
	42	96	2	24M	TL24M4296AR	2,547	2,547	2,634	2,682	2,833	3,512	3,098	3,851
	48	96	2	24H	TL24H4896AR	2,920	2,920	2,974	3,024	3,256	3,968	3,629	4,195
	48	120	2	24H	TL24H48120AR	3,094	3,094	3,213	3,275	3,499	4,308	3,933	4,590
	48	144	3	24H	TL24H48144AR	4,214	4,214	4,336	4,410	4,696	5,556	5,208	5,982
	48	168	3	24H	TL24H48168AR	4,436	4,436	4,563	4,647	4,941	6,036	5,517	6,385
	60	120	2	24XH	TL24XH60120AR	3,427	3,427	3,572	3,649	3,812	4,688	4,232	5,034
	60	144	3	24XH	TL24XH60144AR	4,628	4,628	4,772	4,863	5,182	6,028	5,486	6,699
	60	168	3	24XH	TL24XH60168AR	4,904	4,904	5,050	5,155	5,470	6,425	5,809	7,089

How to Order

Table Model Number					Top Finish Selection		Options	
TL24M Base Series	4272 Top Size	AR Top Shape	WWSQ Top Material Edge Profile	MBK Base Finish	WMW Top Finish	WMW Edge Finish	GMBK Matte Black Grommet	G Location "G"
A TL24M4272ARWWSQMBK is a Tulip series 42" x 72" arc rectangle table with two black powder coat, medium-weighted round bases and a wood veneer 1.25" thick top with a 1.25" square wood edge profile.					The codes: WMW WMW specify a medium walnut top, with a medium walnut edge.		The code: GMBK specifies a matte black 2" diameter metal grommet.	The code: G specifies the location of the grommet.



Laminate Tops

Self Edge LLSE Self Edge	Vinyl Edges LVFL Flat LVBP Bumper	PVC Edges LPVC PVC	Metal Edges LMFL Flat LMRB Ribbed	Wood Edges Group A LWFL Flat LWTP Tapered Ply LWFP Flat Ply	Wood Edges Group B LWSQ Square LWAR Arc LWBN Bullnose LWPR Prism LWPI Pivot
------------------------------------	--	------------------------------	--	---	---

Wood Veneer Tops

Wood Edges Group A WVFL Flat WVTP Tapered Ply WVFP Flat Ply	Wood Edges Group B WWSQ Square WWAR Arc WWBN Bullnose WWPR Prism WWPI Pivot
---	---

Specialty Tops

Butcher Block BBFL Flat BBBN Bullnose	Ultrafoam ULFP PVC ULFR Raw	Acrylic AAOP Opaque AATL Translucent	Corian Group A,B C1FL Flat C1BN Bullnose C1PR Prism	Corian Group C,D C2FL Flat C2BN Bullnose C2PR Prism	3form Chroma 3FFL Flat 3FBN Bullnose 3FPR Prism
--	--	---	---	---	---

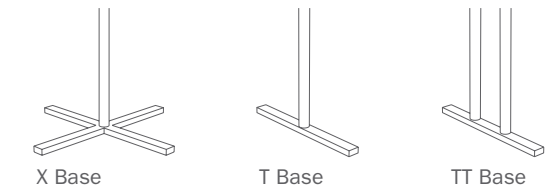

Options

Base Finishes		
Standard Powder Coat	use finish code	n/c
Polished or Satin Chrome (per base)	use finish code	\$114
Premium Plated (per base)	use finish code	\$
Custom Powder Coat (set-up charge)	CPC	\$363

Base Options			
Alternate Height Base (per column)	AH		\$66
Super Level Glides (per base)	GSL		\$34
Locking Casters 2" Twin Wheel (qty. 4)	TWC2		\$56
Tilt-top - (standard cable release)	TMX/TMT	\$270 X-base/ \$418 T-base	
Folding	FM	\$270 T-base	

Top Materials and Finishes			
Standard Laminates	use manufacturers finish code		n/c
Premium Laminates	PRL		\$
Custom Wood Veneer	CWV		\$
Special Pattern Veneer	SPV		\$
Stain to Match (set-up charge)	STM		\$412

Top Options			
Custom Size	CS		\$
Custom Shape	CSH		\$
Custom Radius Corner	CRC		\$
3" Radius Corner (per corner)	CRL3		\$34
(laminates self edge, ultrafoam, Corian®, 3form chroma)			
3" Wood Radius Corner (per corner)	CRW3		\$82
(not available in LWFL, WWFL, LWPI and WWPI)			
Ganging Clips (1 set includes 2 male and 2 female clips)	GC		\$148

Grommets			
2" Round Metal Grommet - Matte Black	GMBK		\$138
2" Round Metal Grommet - Satin Chrome	GMSC		\$138
2" Round Metal Grommet - Polished Chrome	GMPC		\$138
2" Round Plastic Grommet - Matte Black	GPMBK		\$44
Grommet location	use location code		n/c

Edge Options			
1.75" Thick Edge (per table)	175E		15%
(see edge details for specific profiles)			

Modesty Panels			
Fixed Modesty Panel Laminate (48,60,72)	MODLFX		\$248
Fixed Modesty Panel Veneer (48,60,72)	MODVFX		\$386
Folding Modesty Panel Laminate (48,60,72)	MODFL		\$330
Folding Modesty Veneer (48,60,72)	MODVFL		\$468

Wire Management			
J-Trough (horizontal mount) - Matte Black	WMJ		\$116
Legway Wire Manager (vertical mount) - Matte Black	WML		\$56

Data and Power			
Recessed Power and Data Module Two	DPBS2		\$396
Recessed Power and Data Module Four	DPBS4		\$688
Retractable Power and Data Module Two	DPAS2		\$606
Retractable Power and Data Module Three	DPAS3		\$688
Under Top Mounted Power and Data Module Two	DPUS2		\$358

Other			
Table Truck for Folding Tables	TRK		\$1512

Complete Table List Pricing

	Top Size	Base Qty.	Base Style	Model #	\$							
Round	24	1	X	TUX24RD	514	514	564	612	722	891	732	963
	30	1	X	TUX30RD	629	629	691	724	890	1,071	890	1,158
	36	1	X	TUX36RD	779	779	851	897	1,086	1,296	1,112	1,401
	42	1	X	TUX42RD	880	880	960	960	1,202	1,460	1,296	1,586
	48	1	X	TUX48RD	1,053	1,053	1,144	1,171	1,411	1,707	1,522	1,856
	54	1	X	TUX54RD	1,164	1,164	1,269	1,298	1,627	2,238	1,765	2,452
	60	1	X	TUX60RD	1,341	1,341	1,454	1,508	1,747	2,321	2,106	2,547
Oval	36	72	2	TUT36720V	889	889	940	965	1,148	1,370	1,321	1,537
	42	54	2	TUT42540V	866	866	893	957	1,098	1,425	1,249	1,485
	42	78	2	TUT42780V	1,158	1,158	1,199	1,244	1,392	1,613	1,535	1,782
	42	84	2	TUT42840V	1,214	1,214	1,268	1,312	1,442	1,693	1,588	1,872
	48	78	2	TUTT48780V	1,309	1,309	1,366	1,412	1,535	1,784	1,687	1,967
	48	96	2	TUTT48960V	1,485	1,485	1,541	1,591	1,683	1,955	2,045	2,362
	Racetrack	30	60	2	TUT3060RA	692	692	750	772	1,062	1,340	1,163
30		72	2	TUT3072RA	760	760	832	857	1,136	1,480	1,249	1,612
30		84	2	TUT3084RA	990	990	1,054	1,095	1,233	1,719	1,359	1,916
30		96	2	TUT3096RA	1,060	1,060	1,132	1,176	1,327	1,933	1,457	2,120
36		60	2	TUT3660RA	788	788	856	878	1,148	1,455	1,259	1,615
36		72	2	TUT3672RA	868	868	947	972	1,280	1,623	1,407	1,794
36		84	2	TUT3684RA	1,105	1,105	1,184	1,226	1,380	1,850	1,524	2,074
36		96	2	TUTT3696RA	1,245	1,245	1,338	1,379	1,547	2,136	1,702	2,313
42		72	2	TUTT4272RA	1,012	1,012	1,086	1,117	1,401	1,796	1,472	2,080
42		84	2	TUTT4284RA	1,266	1,266	1,333	1,377	1,500	2,051	1,646	2,371
42		96	2	TUTT4296RA	1,362	1,362	1,431	1,480	1,623	2,249	1,786	2,646

Continued on next page

How to Order

Table Model Number					Top Finish Selection		Options
TUX Base Series	36 Top Size	RD Top Shape	WWSQ Top Material Edge Profile	MBK Base Finish	WMW Top Finish	WMW Edge Finish	AH Alternate Height Base
A TUX36RDWWSQMBK is a Tuscan series 36" round table with a black powder coat X-base and a wood veneer 1.25" thick top with a 1.25" square wood edge profile.					The codes: WMW WMW specify a medium walnut top, with a medium walnut edge.		AH Alternate Height Base

Laminate Tops				Wood Veneer Tops			
Self Edge	Vinyl Edges	PVC Edges	Metal Edges	Wood Edges Group A	Wood Edges Group B	Wood Edges Group A	Wood Edges Group B
LLSE Self Edge	LVFL Flat	LPVC PVC	LMFL Flat	LWFL Flat	LWSQ Square	WWFL Flat	WWSQ Square
	LVBP Bumper		LMRB Ribbed	LWTP Tapered Ply	LWAR Arc	WWTP Tapered Ply	WWAR Arc
				LWFP Flat Ply	LWBN Bullnose	WWFP Flat Ply	WWBN Bullnose
					LWPR Prism		WWPR Prism
					LWPI Pivot		WWPI Pivot

Butcher Block	Ultrafoam	Acrylic	Corian Group A,B	Corian Group C,D	3form Chroma
BBFL Flat	ULFP PVC	AAOP Opaque	C1FL Flat	C2FL Flat	3FFL Flat
BBBN Bullnose	ULFR Raw	AATL Translucent	C1BN Bullnose	C2BN Bullnose	3FBN Bullnose
			C1PR Prism	C2PR Prism	3FPR Prism

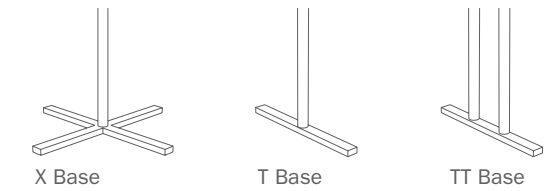

Options

Base Finishes		
Standard Powder Coat	use finish code	n/c
Polished or Satin Chrome (per base)	use finish code	\$114
Premium Plated (per base)	use finish code	Ⓢ
Custom Powder Coat (set-up charge)	CPC	\$363

Base Options		
Alternate Height Base (per column)	AH	\$66
Super Level Glides (per base)	GSL	\$34
Locking Casters 2" Twin Wheel (qty. 4)	TWC2	\$56
Tilt-top - (standard cable release)	TMX/TMT	\$270 X-base/ \$418 T-base
Folding	FM	\$270 T-base

Top Materials and Finishes		
Standard Laminates	use manufacturers finish code	n/c
Premium Laminates	PRL	Ⓢ
Custom Wood Veneer	CWV	Ⓢ
Special Pattern Veneer	SPV	Ⓢ
Stain to Match (set-up charge)	STM	\$412

Top Options		
Custom Size	CS	Ⓢ
Custom Shape	CSH	Ⓢ
Custom Radius Corner	CRC	Ⓢ
3" Radius Corner (per corner)	CRL3	\$34
(laminates self edge, ultrafoam, Corian®, 3form chroma)		
3" Wood Radius Corner (per corner)	CRW3	\$82
(not available in LWFL, WWFL, LWPI and WWPI)		
Ganging Clips (1 set includes 2 male and 2 female clips)	GC	\$148

Grommets		
2" Round Metal Grommet - Matte Black	GMBK	\$138
2" Round Metal Grommet - Satin Chrome	GMSC	\$138
2" Round Metal Grommet - Polished Chrome	GMPC	\$138
2" Round Plastic Grommet - Matte Black	GPMBK	\$44
Grommet location	use location code	n/c

Edge Options		
1.75" Thick Edge (per table)	175E	15%
(see edge details for specific profiles)		

Modesty Panels		
Fixed Modesty Panel Laminate (48,60,72)	MODLFX	\$248
Fixed Modesty Panel Veneer (48,60,72)	MODVFX	\$386
Folding Modesty Panel Laminate (48,60,72)	MODLFL	\$330
Folding Modesty Veneer (48,60,72)	MODVFL	\$468

Wire Management		
J-Trough (horizontal mount) - Matte Black	WMJ	\$116
Legway Wire Manager (vertical mount) - Matte Black	WML	\$56

Data and Power		
Recessed Power and Data Module Two	DPBS2	\$396
Recessed Power and Data Module Four	DPBS4	\$688
Retractable Power and Data Module Two	DPAS2	\$606
Retractable Power and Data Module Three	DPAS3	\$688
Under Top Mounted Power and Data Module Two	DPUS2	\$358

Other		
Table Truck for Folding Tables	TRK	\$1512

Complete Table List Pricing

	Top Size	Base Qty.	Base Style	Model #	\$								
Racetrack	48 96	2	TT	TUTT4896RA	1,500	1,500	1,580	1,630	1,860	2,511	2,229	2,737	
	48 120	2	TT	TUTT48120RA	1,712	1,712	1,813	1,875	2,103	2,850	2,533	3,190	
	48 144	3	TT	TUTT48144RA	2,155	2,155	2,270	2,347	2,588	3,398	3,100	3,823	
	48 168	3	TT	TUTT48168RA	2,370	2,370	2,493	2,580	2,839	3,767	3,415	4,249	
	60 120	2	TT	TUTT60120RA	1,984	1,984	2,093	2,169	2,284	3,190	2,733	3,587	
60 144	3	TT	TUTT60144RA	2,479	2,479	2,580	2,672	2,927	3,767	3,259	4,236		
60 168	3	TT	TUTT60168RA	2,744	2,744	2,855	2,960	3,221	4,162	3,893	5,012		
Square	24 24	1	X	TUX2424SQ	514	514	570	624	722	891	732	963	
	30 30	1	X	TUX3030SQ	629	629	697	744	890	1,071	890	1,158	
	36 36	1	X	TUX3636SQ	779	779	847	916	1,076	1,296	1,112	1,401	
	42 42	1	X	TUX4242SQ	938	938	1,014	1,063	1,272	1,530	1,366	1,656	
	48 48	1	X	TUX4848SQ	1,055	1,055	1,144	1,203	1,411	1,707	1,522	1,856	
Rectangle	18 48	2	T	TUT1848RE	461	461	512	527	630	879	696	907	
	18 60	2	T	TUT1860RE	511	511	571	589	710	992	774	1,050	
	18 72	2	T	TUT1872RE	558	558	624	645	794	1,106	862	1,192	
	18 84	2	T	TUT1884RE	710	710	762	794	939	1,247	1,033	1,377	
	18 96	2	T	TUT1896RE	794	794	841	879	996	1,360	1,095	1,482	
	24 30	1	X	TUX2430RE	598	598	645	657	838	1,024	919	1,104	
	24 36	1	X	TUX2436RE	697	697	749	763	971	1,152	1,037	1,240	
	24 42	1	X	TUX2442RE	730	730	775	790	1,012	1,211	1,082	1,306	
	24 48	1	X	TUX2448RE	765	765	821	839	1,084	1,306	1,164	1,411	
	24 60	2	T	TUT2460RE	577	577	637	658	918	1,171	1,007	1,291	
	24 72	2	T	TUT2472RE	635	635	705	729	1,015	1,305	1,118	1,443	
	24 84	2	T	TUT2484RE	852	852	917	957	1,097	1,585	1,210	1,760	
	24 96	2	T	TUT2496RE	910	910	981	1,025	1,179	1,706	1,301	1,896	

Continued on next page

How to Order

Table Model Number					Top Finish Selection		Options	
TUT Base Series	3660 Top Size	RA Top Shape	WWSQ Top Material Edge Profile	MBK Base Finish	WMW Top Finish	WMW Edge Finish	GMBK Matte Black Grommet	E Location "E"
A TUT3660RAWWSQMBK is a Tuscan series 36" x 60" racetrack table with two black powder coat T-bases and a wood veneer 1.25" thick top with a 1.25" square wood edge profile.					The codes: WMW WMW specify a medium walnut top, with a medium walnut edge.		The code: GMBK specifies a matte black 2" diameter metal grommet.	The code: E specifies the location of the grommet.

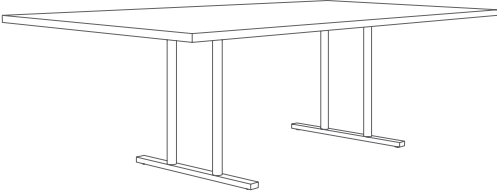

Laminate Tops				Wood Veneer Tops			
Self Edge	Vinyl Edges	PVC Edges	Metal Edges	Wood Edges Group A	Wood Edges Group B	Wood Edges Group A	Wood Edges Group B
LLSE Self Edge	LVFL Flat LVBP Bumper	LPVC PVC	LMFL Flat LMRB Ribbed	LWFL Flat LWTP Tapered Ply LWFP Flat Ply	LWSQ Square LWAR Arc LWBN Bullnose LWPR Prism LWPI Pivot	WWFL Flat WWTP Tapered Ply WWFP Flat Ply	WWSQ Square WWAR Arc WWBN Bullnose WWPR Prism WWPI Pivot

Butcher Block	Ultrafoam	Acrylic	Corian Group A,B	Corian Group C,D	3form Chroma
BBFL Flat BBBN Bullnose	ULFP PVC ULFR Raw	AAOP Opaque AATL Translucent	C1FL Flat C1BN Bullnose C1PR Prism	C2FL Flat C2BN Bullnose C2PR Prism	3FFL Flat 3FBN Bullnose 3FPR Prism

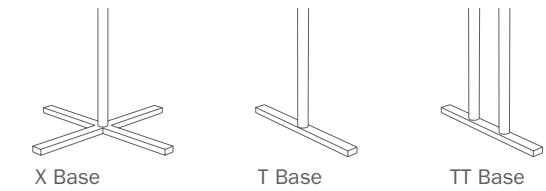

Options

Base Finishes		
Standard Powder Coat	use finish code	n/c
Polished or Satin Chrome (per base)	use finish code	\$114
Premium Plated (per base)	use finish code	\$
Custom Powder Coat (set-up charge)	CPC	\$363

Base Options		
Alternate Height Base (per column)	AH	\$66
Super Level Glides (per base)	GSL	\$34
Locking Casters 2" Twin Wheel (qty. 4)	TWC2	\$56
Tilt-top - (standard cable release)	TMX/TMT	\$270 X-base/ \$418 T-base
Folding	FM	\$270 T-base

Top Materials and Finishes		
Standard Laminates	use manufacturers finish code	n/c
Premium Laminates	PRL	\$
Custom Wood Veneer	CWV	\$
Special Pattern Veneer	SPV	\$
Stain to Match (set-up charge)	STM	\$412

Top Options		
Custom Size	CS	\$
Custom Shape	CSH	\$
Custom Radius Corner	CRC	\$
3" Radius Corner (per corner)	CRL3	\$34
(laminates self edge, ultrafoam, Corian®, 3form chroma)		
3" Wood Radius Corner (per corner)	CRW3	\$82
(not available in LWFL, WWFL, LWPI and WWPI)		
Ganging Clips (1 set includes 2 male and 2 female clips)	GC	\$148

Grommets		
2" Round Metal Grommet - Matte Black	GMBK	\$138
2" Round Metal Grommet - Satin Chrome	GMSC	\$138
2" Round Metal Grommet - Polished Chrome	GMPC	\$138
2" Round Plastic Grommet - Matte Black	GPMBK	\$44
Grommet location	use location code	n/c

Edge Options		
1.75" Thick Edge (per table)	175E	15%
(see edge details for specific profiles)		

Modesty Panels		
Fixed Modesty Panel Laminate (48,60,72)	MODLFX	\$248
Fixed Modesty Panel Veneer (48,60,72)	MODVFX	\$386
Folding Modesty Panel Laminate (48,60,72)	MODLFL	\$330
Folding Modesty Veneer (48,60,72)	MODVFL	\$468

Wire Management		
J-Trough (horizontal mount) - Matte Black	WMJ	\$116
Legway Wire Manager (vertical mount) - Matte Black	WML	\$56

Data and Power		
Recessed Power and Data Module Two	DPBS2	\$396
Recessed Power and Data Module Four	DPBS4	\$688
Retractable Power and Data Module Two	DPAS2	\$606
Retractable Power and Data Module Three	DPAS3	\$688
Under Top Mounted Power and Data Module Two	DPUS2	\$358

Other		
Table Truck for Folding Tables	TRK	\$1512

Complete Table List Pricing

Top Size	Base Qty.	Base Style	Model #	\$									
Rectangle	30	36	1	X	TUX3036RE	742	742	787	802	1,024	1,222	1,096	1,318
	30	42	1	X	TUX3042RE	777	777	829	847	1,119	1,341	1,201	1,452
	30	48	1	X	TUX3048RE	884	884	940	960	1,234	1,475	1,325	1,594
	30	60	2	T	TUT3060RE	680	680	744	768	1,060	1,336	1,163	1,472
	30	72	2	T	TUT3072RE	748	748	825	852	1,136	1,449	1,250	1,599
	30	84	2	T	TUT3084RE	980	980	1,046	1,091	1,231	1,719	1,354	1,902
	30	96	2	T	TUT3096RE	1,050	1,050	1,123	1,171	1,326	1,892	1,462	2,097
	36	42	2	T	TUT3642RE	640	640	699	718	989	1,234	1,082	1,354
	36	48	2	T	TUT3648RE	680	680	742	763	1,043	1,304	1,140	1,432
	36	60	2	T	TUT3660RE	775	775	848	872	1,148	1,444	1,259	1,592
	36	72	2	T	TUT3672RE	858	858	935	963	1,276	1,611	1,401	1,780
	36	84	2	T	TUT3684RE	1,103	1,103	1,172	1,218	1,380	1,846	1,520	2,043
	36	96	2	TT	TUTT3696RE	1,245	1,245	1,328	1,372	1,545	2,080	1,698	2,299
	42	72	2	TT	TUTT4272RE	1,002	1,002	1,067	1,100	1,401	1,796	1,472	1,889
	42	84	2	TT	TUTT4284RE	1,258	1,258	1,328	1,377	1,515	2,023	1,751	2,336
	42	96	2	TT	TUTT4296RE	1,352	1,352	1,429	1,482	1,636	2,249	1,893	2,379
	48	96	2	TT	TUTT4896RE	1,498	1,498	1,573	1,628	1,856	2,511	2,229	2,716
	48	120	2	TT	TUTT48120RE	1,710	1,710	1,808	1,875	2,099	2,737	2,533	3,021
	48	144	3	TT	TUTT48144RE	2,135	2,135	2,230	2,310	2,555	3,201	3,057	3,592
	48	168	3	TT	TUTT48168RE	2,363	2,363	2,463	2,555	2,786	3,483	3,347	3,918
	60	120	2	TT	TUTT60120RE	1,971	1,971	2,063	2,144	2,319	2,963	2,737	3,361
	60	144	3	TT	TUTT60144RE	2,431	2,431	2,534	2,631	2,898	3,483	3,487	4,009
	60	168	3	TT	TUTT60168RE	2,740	2,740	2,813	2,925	3,181	4,107	3,841	4,786

Continued on next page

*T-bases can be specified on 30" x 42" and 30" x 48" rectangle tables, please refer to Base Only Pricing (p.231) and Top Only Pricing (p.241).

X-bases are recommended for dining applications.

How to Order

Table Model Number					Top Finish Selection		Options	
TUTT Base Series	4896 Top Size	RE Top Shape	WWSQ Top Material Edge Profile	MBK Base Finish	WMW Top Finish	WMW Edge Finish	GMBK Matte Black Grommet	E Location "E"
A TUTT4896REWWSQMBK is a Tuscan series 48" x 96" rectangle table with two black powder coat TT-bases and a wood veneer 1.25" thick top with a 1.25" square wood edge profile.					The codes: WMW WMW specify a medium walnut top, with a medium walnut edge.		The code: GMBK specifies a matte black 2" diameter metal grommet.	
							The code: E specifies the location of the grommet.	

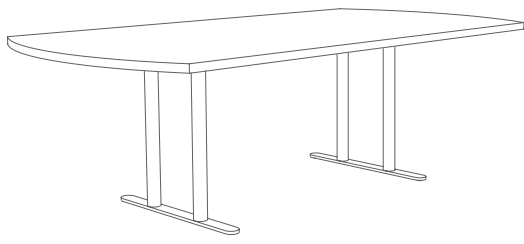

Laminate Tops				Wood Veneer Tops			
Self Edge	Vinyl Edges	PVC Edges	Metal Edges	Wood Edges Group A	Wood Edges Group B	Wood Edges Group A	Wood Edges Group B
LLSE Self Edge	LVFL Flat LVBP Bumper	LPVC PVC	LMFL Flat LMRB Ribbed	LWFL Flat LWTP Tapered Ply LWFP Flat Ply	LWSQ Square LWAR Arc LWBN Bullnose LWPR Prism LWPI Pivot	WWFL Flat WWTP Tapered Ply WWFP Flat Ply	WWSQ Square WWAR Arc WWBN Bullnose WWPR Prism WWPI Pivot

Specialty Tops					
Butcher Block	Ultrafoam	Acrylic	Corian Group A,B	Corian Group C,D	3form Chroma
BBFL Flat BBBN Bullnose	ULFP PVC ULFR Raw	AAOP Opaque AATL Translucent	C1FL Flat C1BN Bullnose C1PR Prism	C2FL Flat C2BN Bullnose C2PR Prism	3FFL Flat 3FBN Bullnose 3FPR Prism

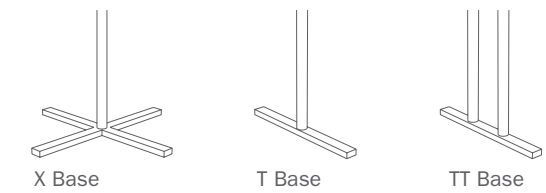

Options

Base Finishes		
Standard Powder Coat	use finish code	n/c
Polished or Satin Chrome (per base)	use finish code	\$114
Premium Plated (per base)	use finish code	Ⓢ
Custom Powder Coat (set-up charge)	CPC	\$363

Base Options		
Alternate Height Base (per column)	AH	\$66
Super Level Glides (per base)	GSL	\$34
Locking Casters 2" Twin Wheel (qty. 4)	TWC2	\$56
Tilt-top - (standard cable release)	TMX/TMT	\$270 X-base/ \$418 T-base
Folding	FM	\$270 T-base

Top Materials and Finishes		
Standard Laminates	use manufacturers finish code	n/c
Premium Laminates	PRL	Ⓢ
Custom Wood Veneer	CWV	Ⓢ
Special Pattern Veneer	SPV	Ⓢ
Stain to Match (set-up charge)	STM	\$412

Top Options		
Custom Size	CS	Ⓢ
Custom Shape	CSH	Ⓢ
Custom Radius Corner	CRC	Ⓢ
3" Radius Corner (per corner)	CRL3	\$34
(laminates self edge, ultrafoam, Corian®, 3form chroma)		
3" Wood Radius Corner (per corner)	CRW3	\$82
(not available in LWFL, WWFL, LWPI and WWPI)		
Ganging Clips (1 set includes 2 male and 2 female clips)	GC	\$148

Grommets		
2" Round Metal Grommet - Matte Black	GMBK	\$138
2" Round Metal Grommet - Satin Chrome	GMSC	\$138
2" Round Metal Grommet - Polished Chrome	GMPC	\$138
2" Round Plastic Grommet - Matte Black	GPMBK	\$44
Grommet location	use location code	n/c

Edge Options		
1.75" Thick Edge (per table)	175E	15%
(see edge details for specific profiles)		

Modesty Panels		
Fixed Modesty Panel Laminate (48,60,72)	MODLFX	\$248
Fixed Modesty Panel Veneer (48,60,72)	MODVFX	\$386
Folding Modesty Panel Laminate (48,60,72)	MODLFL	\$330
Folding Modesty Veneer (48,60,72)	MODVFL	\$468

Wire Management		
J-Trough (horizontal mount) - Matte Black	WMJ	\$116
Legway Wire Manager (vertical mount) - Matte Black	WML	\$56

Data and Power		
Recessed Power and Data Module Two	DPBS2	\$396
Recessed Power and Data Module Four	DPBS4	\$688
Retractable Power and Data Module Two	DPAS2	\$606
Retractable Power and Data Module Three	DPAS3	\$688
Under Top Mounted Power and Data Module Two	DPUS2	\$358

Other		
Table Truck for Folding Tables	TTRK	\$1512

Complete Table List Pricing

	Top Size	Base Qty.	Base Style	Model #	\$							
Half Round	24 48	2	T	TUT2448HR	523	523	573	589	713	966	776	1,013
	30 60	2	T	TUT3060HR	693	693	761	784	902	1,198	986	1,332
	36 72	2	T	TUT3672HR	874	874	955	981	1,098	1,455	1,306	1,568
Arc Rectangle	30 60	2	T	TUT3060AR	693	693	748	770	1,027	1,340	1,163	1,484
	30 72	2	T	TUT3072AR	784	784	834	859	1,141	1,538	1,249	1,612
	30 84	2	T	TUT3084AR	962	962	1,043	1,083	1,231	1,680	1,357	1,916
	30 96	2	T	TUT3096AR	1,035	1,035	1,122	1,165	1,340	1,877	1,457	2,120
	36 60	2	T	TUT3660AR	808	808	850	872	1,148	1,510	1,259	1,615
	36 72	2	T	TUT3672AR	911	911	959	985	1,273	1,681	1,401	1,794
	36 84	2	T	TUT3684AR	1,090	1,090	1,175	1,216	1,380	1,850	1,520	2,049
	36 96	2	TT	TUTT3696AR	1,235	1,235	1,328	1,368	1,547	2,164	1,702	2,313
	42 72	2	TT	TUTT4272AR	1,117	1,117	1,139	1,175	1,401	1,847	1,472	2,136
	42 84	2	TT	TUTT4284AR	1,245	1,245	1,328	1,372	1,488	2,109	1,751	2,397
	42 96	2	TT	TUTT4296AR	1,342	1,342	1,429	1,477	1,628	2,307	1,893	2,646
	48 96	2	TT	TUTT4896AR	1,520	1,520	1,574	1,624	1,856	2,568	2,229	2,795
	48 120	2	TT	TUTT48120AR	1,694	1,694	1,813	1,875	2,099	2,908	2,533	3,190
	48 144	3	TT	TUTT48144AR	2,114	2,114	2,236	2,310	2,596	3,456	3,108	3,882
	48 168	3	TT	TUTT48168AR	2,336	2,336	2,463	2,547	2,841	3,936	3,417	4,285

Continued on next page

How to Order

Table Model Number				Top Finish Selection		Options		
TUTT Base Series	4896 Top Size	AR Top Shape	WWSQ Top Material Edge Profile	MBK Base Finish	WMW Top Finish	WMW Edge Finish	GMBK Matte Black Grommet	C Location "C"
A TUTT4896ARWWSQMBK is a Tuscan series 48" x 96" arc rectangle table with two black powder coat TT-bases and a wood veneer 1.25" thick top with a 1.25" square wood edge profile.				The codes: WMW WMW specify a medium walnut top, with a medium walnut edge.		The code: GMBK specifies a matte black 2" diameter metal grommet.		The code: C specifies the location of the grommet.

Laminate Tops				Wood Veneer Tops			
Self Edge	Vinyl Edges	PVC Edges	Metal Edges	Wood Edges Group A	Wood Edges Group B	Wood Edges Group A	Wood Edges Group B
LLSE Self Edge	LVFL Flat	LPVC PVC	LMFL Flat	LWFL Flat	LWSQ Square	WWFL Flat	WWSQ Square
	LVBP Bumper		LMRB Ribbed	LWTP Tapered Ply	LWAR Arc	WWTP Tapered Ply	WWAR Arc
				LWFP Flat Ply	LWBN Bullnose	WWFP Flat Ply	WWBN Bullnose
					LWPR Prism		WWPR Prism
					LWPI Pivot		WWPI Pivot

Complete Table List Pricing

	Top Size	Base Qty.	Base Style	Model #	\$							
	60 120	2	TT	TUTT60120AR	1,957	1,957	2,102	2,179	2,342	3,218	2,762	3,564
	60 144	3	TT	TUTT60144AR	2,423	2,423	2,567	2,658	2,977	3,823	3,281	4,494
	60 168	3	TT	TUTT60168AR	2,699	2,699	2,845	2,950	3,265	4,220	3,604	4,884
	36 42 72	2	T	TUTT3672BS	1,276	1,276	1,241	1,288	1,522	1,946	1,681	2,158
	36 48 84	2	TT	TUTT3684BS	1,451	1,451	1,516	1,572	1,877	2,272	2,072	2,519
	36 48 96	2	TT	TUTT3696BS	1,570	1,570	1,634	1,691	2,043	2,390	2,259	2,648
	36 48 120	2	TT	TUTT36120BS	1,807	1,807	1,884	1,955	2,426	2,659	2,690	2,951
	36 48 144	3	TT	TUTT36144BS	2,229	2,229	2,318	2,403	3,064	3,305	3,385	3,657
	36 48 168	3	TT	TUTT36168BS	2,455	2,455	2,566	2,665	3,400	3,526	3,764	3,906

How to Order

Table Model Number					Top Finish Selection		Options	
TUTT Base Series	3648120 Top Size	BS Top Shape	WWSQ Top Material Edge Profile	MBK Base Finish	WMW Top Finish	WMW Edge Finish	GMBK Matte Black Grommet	G Location "G"
A TUTT3648120BSWWSQMBK is a Tuscan series 36" x 48" x 120" boat shape table with two black powder coat TT-bases and a wood veneer 1.25" thick top with a 1.25" square wood edge profile.					The codes: WMW WMW specifies a medium walnut top, with a medium walnut edge.		The code: GMBK specifies a matte black 2" diameter metal grommet.	The code: G specifies the location of the grommet.

Butcher Block	Ultrafoam	Acrylic	Corian Group A,B	Corian Group C,D	3form Chroma
BBFL Flat	ULFP PVC	AAOP Opaque	C1FL Flat	C2FL Flat	3FFL Flat
BBBN Bullnose	ULFR Raw	AATL Translucent	C1BN Bullnose	C2BN Bullnose	3FBN Bullnose
			C1PR Prism	C2PR Prism	3FPR Prism

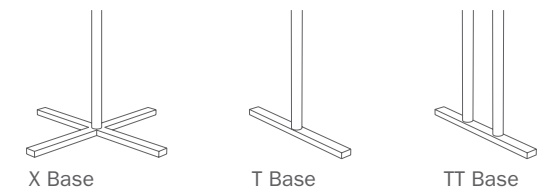

Options

Base Finishes		
Standard Powder Coat	use finish code	n/c
Polished or Satin Chrome (per base)	use finish code	\$114
Premium Plated (per base)	use finish code	Ⓢ
Custom Powder Coat (set-up charge)	CPC	\$363

Base Options		
Alternate Height Base (per column)	AH	\$66
Super Level Glides (per base)	GSL	\$34
Locking Casters 2" Twin Wheel (qty. 4)	TWC2	\$56
Tilt-top - (standard cable release)	TMX/TMT	\$270 X-base/ \$418 T-base
Folding	FM	\$270 T-base

Top Materials and Finishes		
Standard Laminates	use manufacturers finish code	n/c
Premium Laminates	PRL	Ⓢ
Custom Wood Veneer	CWV	Ⓢ
Special Pattern Veneer	SPV	Ⓢ
Stain to Match (set-up charge)	STM	\$412

Top Options		
Custom Size	CS	Ⓢ
Custom Shape	CSH	Ⓢ
Custom Radius Corner	CRC	Ⓢ
3" Radius Corner (per corner)	CRL3	\$34
(laminat self edge, ultrafoam, Corian®, 3form chroma)		
3" Wood Radius Corner (per corner)	CRW3	\$82
(not available in LWFL, WWFL, LWPI and WWPI)		
Ganging Clips (1 set includes 2 male and 2 female clips)	GC	\$148

Grommets		
2" Round Metal Grommet - Matte Black	GMBK	\$138
2" Round Metal Grommet - Satin Chrome	GMSC	\$138
2" Round Metal Grommet - Polished Chrome	GMPC	\$138
2" Round Plastic Grommet - Matte Black	GPMBK	\$44
Grommet location	use location code	n/c

Edge Options		
1.75" Thick Edge (per table)	175E	15%
(see edge details for specific profiles)		

Modesty Panels		
Fixed Modesty Panel Laminate (48,60,72)	MODLFX	\$248
Fixed Modesty Panel Veneer (48,60,72)	MODVFX	\$386
Folding Modesty Panel Laminate (48,60,72)	MODLFL	\$330
Folding Modesty Veneer (48,60,72)	MODVFL	\$468

Wire Management		
J-Trough (horizontal mount) - Matte Black	WMJ	\$116
Legway Wire Manager (vertical mount) - Matte Black	WML	\$56

Data and Power		
Recessed Power and Data Module Two	DPBS2	\$396
Recessed Power and Data Module Four	DPBS4	\$688
Retractable Power and Data Module Two	DPAS2	\$606
Retractable Power and Data Module Three	DPAS3	\$688
Under Top Mounted Power and Data Module Two	DPUS2	\$358

Other		
Table Truck for Folding Tables	TRK	\$1512

Occasional Tables

172	Cube
174	Cylinder
176	Disc
180	Move
182	Parsons
186	Platform
188	Tulip

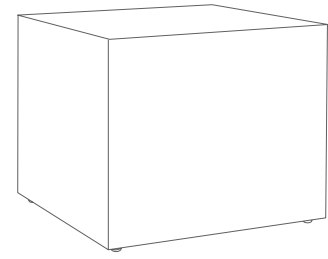

Laminate Wood Veneer

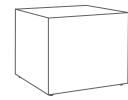

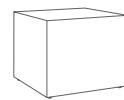

LAM
Laminate



VEN
Wood Veneer

Complete Table List Pricing

	Top Size		Table Height	Model #	\$	
Square 	18	18	18	CU1818SQ18	610	868
	18	18	20	CU1818SQ20	656	930
	18	18	24	CU1818SQ24	722	1,011
	20	20	18	CU2020SQ18	670	944
	20	20	20	CU2020SQ20	719	1,008
	20	20	24	CU2020SQ24	789	1,094
	24	24	18	CU2424SQ18	769	1,073
	24	24	20	CU2424SQ20	822	1,141
	24	24	24	CU2424SQ24	900	1,235
Rectangle 	20	30	18	CU2030RE18	786	1,087
	20	30	20	CU2030RE20	840	1,156
	24	36	16	CU2436RE16	873	1,175
	24	36	18	CU2436RE18	932	1,249
	24	48	16	CU2448RE16	1,005	1,337
	24	48	18	CU2448RE18	1,071	1,418

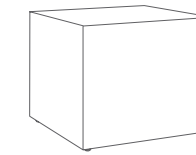

Options

Base Options		
Kick Base (laminate)	KBL	\$276
Kick Base (veneer)	KBV	\$358
Top Materials and Finishes		
Standard Laminates	use manufacturers finish code	n/c
Standard Wood Veneer	use wood surface code	n/c
Premium Laminates	PRL	🕒
Custom Wood Veneer	CWV	🕒
Special Pattern Veneer	SPV	🕒
Stain to Match (set-up charge)	STM	\$412

How to Order

Table Model Number					Finish Selection		Options	
CU Base Series	2020 Top Size	SQ Top Shape	18 Table Height	VEN Material	WNM Wood Natural Maple Veneer	KBL Laminate Kick Base	Formica® 909-58 Black Laminate	
A CU2020SQ18VEN is a Cube occasional table, 20" x 20" square x 18" high with wood veneer.					The code: WNM specifies wood natural maple veneer.		The code: KBL specifies a 2" high x 1" deep laminate kick base.	
							The code: Formica 909-58 specifies the manufacturer and color of the laminate used on the kick base.	

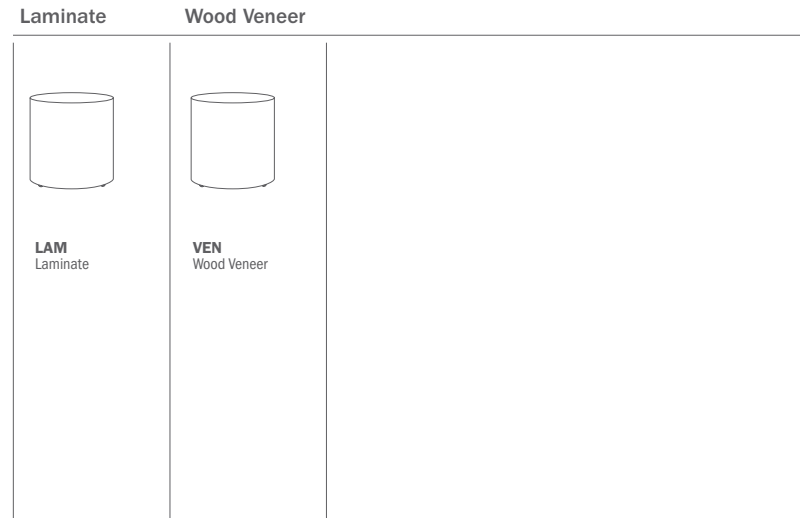
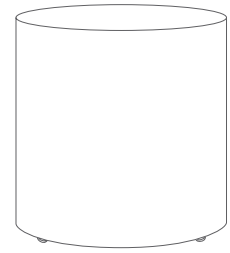

Complete Table List Pricing

	Top Size	Table Height	Model #	\$	
Round	18	18	CY18RD18	776	976
	18	20	CY18RD20	822	1,037
	18	24	CY18RD24	900	1,132
	20	18	CY20RD18	817	1,032
	20	20	CY20RD20	866	1,096
	20	24	CY20RD24	950	1,197
	24	18	CY24RD18	871	1,129
	24	20	CY24RD20	924	1,199
	24	24	CY24RD24	1,018	1,308
	30	16	CY30RD16	1,074	1,355
	30	18	CY30RD18	1,145	1,443
	30	20	CY30RD20	1,217	1,530
	30	24	CY30RD24	1,346	1,677
	36	18	CY36RD18	1,253	1,567
	36	20	CY36RD20	1,335	1,666
	36	24	CY36RD24	1,485	1,834



Options

Base Options		
Kick Base (laminated)	KBL	\$276
Kick Base (veneer)	KBV	\$358

Top Materials and Finishes		
Standard Laminates	use manufacturers finish code	n/c
Standard Wood Veneer	use wood surface code	n/c
Premium Laminates	PRL	🕒
Custom Wood Veneer	CWV	🕒
Special Pattern Veneer	SPV	🕒
Stain to Match (set-up charge)	STM	\$412

How to Order

Table Model Number					Finish Selection	Options	
CY Base Series	24 Top Size	RD Top Shape	18 Table Height	VEN Material	WNM Wood Natural Maple Veneer	KBL Laminated Kick Base	Formica® 909-58 Black Laminated
A CY24RD18VEN is a Cylinder occasional table, 24" round x 18" high with wood veneer.					The code: WNM specifies wood natural maple veneer.	The code: KB specifies a 2" high x 1" deep laminated kick base.	The code: Formica 909-58 specifies the manufacturer and color of the laminate used on the kick base.

Laminate Tops		Wood Veneer Tops			
Self Edge Vinyl Edges	Wood Edges Group A	Wood Edges Group B	Wood Edges Group A	Wood Edges Group B	
LLSE Self Edge	LWFL Flat	LWBN Bullnose	WWFL Flat	WWBN Bullnose	
	LWTP Tapered Ply	LWPR Prism	WWTP Tapered Ply	WWPR Prism	
	LWFP Flat Ply	LWPI Pivot	WWFP Flat Ply	WWPI Pivot	
		LWSQ Square		WWSQ Square	

Specialty Tops			
Acrylic	Corian Group A,B	Corian Group C,D	3form Chroma
AAOP Opaque	C1FL Flat	C2FL Flat	3FFL Flat
AATL Translucent	C1BN Bullnose	C2BN Bullnose	3FBN Bullnose
	C1PR Prism	C2PR Prism	3FPR Prism

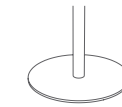

Options

Base Finishes		
Standard Powder Coat	use finish code	n/c
Polished or Satin Chrome (per base)	use finish code	\$213
Premium Plated (per base)	use finish code	Ⓛ
Custom Powder Coat (set-up charge)	CPC	\$363

Top Materials and Finishes		
Standard Laminates	use manufacturers finish code	n/c
Premium Laminates	PRL	Ⓛ
Custom Wood Veneer	CWV	Ⓛ
Special Pattern Veneer	SPV	Ⓛ
Stain to Match (set-up charge)	STM	\$412

Top Options		
Custom Size	CS	Ⓛ
Custom Shape	CSH	Ⓛ
Custom Radius Corner	CRC	Ⓛ
3" Radius Corner (per corner)	CRL3	\$34
(laminates self edge, ultrafoam, Corian®, 3form chroma)		
3" Wood Radius Corner (per corner)	CRW3	\$82
(not available in LWFL, WWFL, LWPI and WWPI)		

Complete Table List Pricing

	Top Size	Table Height	Base Qty.	Model #	\$				
Round	20	16	1	DI20RD16	666	849	979	833	1,033
	20	18	1	DI20RD18	666	849	979	833	1,033
	20	20	1	DI20RD20	666	849	979	833	1,033
	24	16	1	DI24RD16	690	898	1,067	833	1,139
	24	18	1	DI24RD18	690	898	1,067	833	1,139
	24	20	1	DI24RD20	690	898	1,067	833	1,139
	30	16	1	DI30RD16	750	1,011	1,192	1,011	1,279
	30	18	1	DI30RD18	750	1,011	1,192	1,011	1,279
	36	16	1	DI36RD16	990	1,297	1,507	1,323	1,612
	36	18	1	DI36RD18	990	1,297	1,507	1,323	1,612
	42	16	1	DI42RD16	1,091	1,413	1,671	1,507	1,797
	42	18	1	DI42RD18	1,091	1,413	1,671	1,507	1,797
Square	20	20	16	DI2020SQ16	664	847	998	836	1,042
	20	20	18	DI2020SQ18	664	847	998	836	1,042
	20	20	20	DI2020SQ20	664	847	998	836	1,042
	24	24	16	DI2424SQ16	690	898	1,067	908	1,139
	24	24	18	DI2424SQ18	690	898	1,067	908	1,139
	24	24	20	DI2424SQ20	690	898	1,067	908	1,139
	30	30	16	DI3030SQ16	750	1,011	1,192	1,011	1,279
	30	30	18	DI3030SQ18	750	1,011	1,192	1,011	1,279
	36	36	16	DI3636SQ16	990	1,287	1,507	1,323	1,612
	36	36	18	DI3636SQ18	990	1,287	1,507	1,323	1,612

Continued on next page

\$			
-	1,122	1,257	1,607
-	1,122	1,257	1,607
-	1,122	1,257	1,607
1,300	1,215	1,392	1,804
1,300	1,215	1,392	1,804
1,300	1,215	1,392	1,804
1,758	1,487	1,751	2,804
1,758	1,487	1,751	2,804
2,379	1,995	2,353	3,874
2,379	1,995	2,353	3,874
3,030	2,386	2,863	5,010
3,030	2,386	2,863	5,010
-	1,052	1,167	1,465
-	1,052	1,167	1,465
-	1,052	1,167	1,465
1,302	1,130	1,283	1,771
1,302	1,130	1,283	1,771
1,302	1,130	1,283	1,771
1,763	1,382	1,610	2,759
1,763	1,382	1,610	2,759
2,386	1,877	2,196	3,822
2,386	1,877	2,196	3,822

How to Order

Table Model Number						Top Finish Selection	
DI Base Series	24 Top Size	RD Top Shape	18 Table Height	AAOP Material	MBK Base Finish	AWQ Top Finish	

A DI24RD18AAOPMBK is a Disc series 24" round x 18" high round occasional table with a black powder coat round base and an opaque acrylic 1.25" thick top with a waterfall edge profile.

The codes: AWQ specify a white quartz acrylic top.

Laminate Tops		Wood Veneer Tops			
Self Edge Vinyl Edges	Wood Edges Group A	Wood Edges Group B	Wood Edges Group A	Wood Edges Group B	
LLSE Self Edge	LWFL Flat	LWBN Bullnose	WWFL Flat	WWBN Bullnose	
	LWTP Tapered Ply	LWPR Prism	WWTP Tapered Ply	WWPR Prism	
	LWFP Flat Ply	LWPI Pivot	WWFP Flat Ply	WWPI Pivot	
		LWSQ Square		WWSQ Square	

Specialty Tops			
Acrylic	Corian Group A,B	Corian Group C,D	3form Chroma
AAOP Opaque	C1FL Flat	C2FL Flat	3FFL Flat
AATL Translucent	C1BN Bullnose	C2BN Bullnose	3FBN Bullnose
	C1PR Prism	C2PR Prism	3FPR Prism

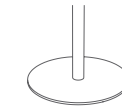

Options

Base Finishes		
Standard Powder Coat	use finish code	n/c
Polished or Satin Chrome (per base)	use finish code	\$213
Premium Plated (per base)	use finish code	Ⓛ
Custom Powder Coat (set-up charge)	CPC	\$330

Top Materials and Finishes		
Standard Laminates	use manufacturers finish code	n/c
Premium Laminates	PRL	Ⓛ
Custom Wood Veneer	CWW	Ⓛ
Special Pattern Veneer	SPV	Ⓛ
Stain to Match (set-up charge)	STM	\$412

Complete Table List Pricing

	Top Size	Table Height	Base Qty.	Model #	\$					
Square	42	42	16	1	DI4242SQ16	1,079	1,413	1,671	1,507	1,797
	42	42	18	1	DI4242SQ18	1,079	1,413	1,671	1,507	1,797
Rectangle	20	30	16	1	DI2030RE16	693	903	1,077	916	1,153
	20	30	18	1	DI2030RE18	693	903	1,077	916	1,153
	20	36	16	1	DI2036RE16	711	939	1,136	969	1,227
	20	36	18	1	DI2036RE18	711	939	1,136	969	1,227
	30	36	16	1	DI3036RE16	953	1,235	1,433	1,307	1,529
	30	36	18	1	D3036RE18	953	1,235	1,433	1,307	1,529
	30	42	16	1	DI3042RE16	988	1,330	1,552	1,412	1,663
	30	42	18	1	DI3042RE18	988	1,330	1,552	1,412	1,663
	30	48	16	1	DI3048RE16	1,150	1,500	1,741	1,591	1,860
	30	48	18	1	D3048RE18	1,150	1,500	1,741	1,591	1,860
Oval	20	36	16	1	DI2036OV16	785	1,004	1,128	1,030	1,177
	20	36	18	1	DI2036OV18	785	1,004	1,128	1,030	1,177
	24	42	16	1	DI2442OV16	992	1,246	1,402	1,315	1,475
	24	42	18	1	DI2442OV18	992	1,246	1,402	1,315	1,475
	30	48	16	1	DI3048OV16	1,217	1,561	1,742	1,630	1,815
	30	48	18	1	DI3048OV18	1,217	1,561	1,742	1,630	1,815

\$				
3,038	2,246	2,670	4,946	
3,038	2,246	2,670	4,946	

-	1,142	1,300	2,003
-	1,142	1,300	2,003

-	1,208	1,392	2,254
-	1,208	1,392	2,254

2,178	1,682	1,949	3,347
2,178	1,682	1,949	3,347

2,421	1,820	2,130	3,785
2,421	1,820	2,130	3,785

2,795	2,097	2,449	4,338
2,795	2,097	2,449	4,338

-	1,413	1,618	-
-	1,413	1,618	-

-	1,815	2,091	-
-	1,815	2,091	-

-	2,285	2,667	-
-	2,285	2,667	-

How to Order

Table Model Number				
DI Base Series	4242 Top Size	SQ Top Shape	18 Table Height	WWFL Material
				MBK Base Finish

Top Finish Selection	
WMW Top Finish	WMW Edge Finish

A DI4242SQ18WWFLMBK is a Disc series 42" x 42" square x 18" high occasional table with a black powder coat round base and a wood veneer 1.25" thick top with a .125" flat wood edge profile.

The codes: WMW WMW specify a medium walnut top, with a medium walnut edge.

Move Tops

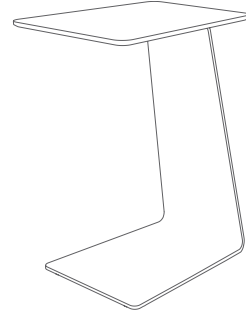

Laminate LMOV Ply	Veneer WMOV Wood	Corian Group A, B, C CMOV Corian	3form Chroma 3MOV Chroma
--------------------------------	-------------------------------	--	--

Complete Table List Pricing

	Top Size			Table Height	Model #	\$			
Trapezoid	18	13	15	25	MOV	688	760	780	906

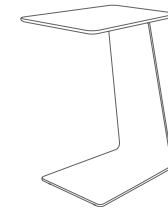

Options

Base Finishes		
Powder Coat	use finish code	n/c
Satin Chrome (per base)	use finish code	\$400
Premium Plated (per base)*	use finish code	Ⓛ
Custom Powder Coat (set-up charge)	CPC	\$363
Top Materials and Finishes		
Standard Laminates	use manufacturers finish code	n/c
Premium Laminates	PRL	Ⓛ
Custom Wood Veneer	CWV	Ⓛ
Stain to Match (set-up charge)	STM	\$412

*Premium plated polished not available on Move tables.

How to Order

Table Model Number			Top Finish Selection
MOV Table Series	WMOV Top Material	MBK Base Finish	WNM Top Finish

A MOVWMOVMBK is a Move table with a matte black powder coat base and a wood veneer top.

The code: WNM specifies a natural maple top.

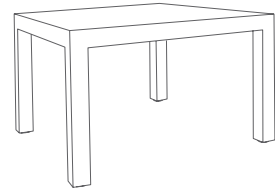

Laminate Wood Veneer

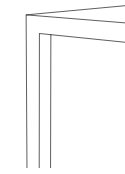
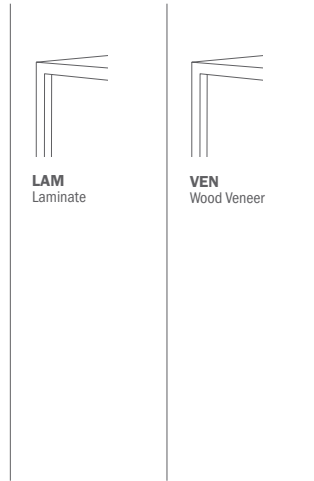



Options

Top Materials and Finishes

Standard Laminates	use manufacturers finish code	n/c
Standard Wood Veneer	use wood surface code	n/c
Premium Laminates	PRL	🕒
Custom Wood Veneer	CWV	🕒
Special Pattern Veneer	SPV	🕒
Stain to Match (set-up charge)	STM	\$412

Complete Table List Pricing

	Top Size	Table Height	Model #	\$	
Square 	18 18	18	PA1818SQ18	1,027	1,482
	18 18	20	PA1818SQ20	1,049	1,504
	18 18	24	PA1818SQ24	1,092	1,548
	20 20	18	PA2020SQ18	1,048	1,510
	20 20	20	PA2020SQ20	1,070	1,532
	20 20	24	PA2020SQ24	1,113	1,576
	24 24	18	PA2424SQ18	1,230	1,729
	24 24	20	PA2424SQ20	1,252	1,751
	24 24	24	PA2424SQ24	1,295	1,795
	30 30	16	PA3030SQ16	1,323	1,891
	30 30	18	PA3030SQ18	1,361	1,947
	30 30	20	PA3030SQ20	1,382	1,969
30 30	24	PA3030SQ24	1,426	2,013	
Rectangle 	36 36	16	PA3636SQ16	1,455	2,072
	36 36	18	PA3636SQ18	1,493	2,128
	36 36	20	PA3636SQ20	1,514	2,150
	36 36	24	PA3636SQ24	1,558	2,194
	18 36	16	PA1836RE16	1,149	1,705
	18 36	18	PA1836RE18	1,187	1,761
	18 36	20	PA1836RE20	1,209	1,783
	18 48	16	PA1848RE16	1,276	1,879
	18 48	18	PA1848RE18	1,313	1,935
	18 48	20	PA1848RE20	1,335	1,957

Continued on next page

How to Order

Table Model Number

PA **1818** **SQ** **18** **VEN**
 Base Series Top Size Top Shape Table Height Material

A PA1818SQ18VEN is a Parsons series 18" x 18" square x 18" high occasional table, with four with wood veneer legs.

Top Finish Selection

WNM
 Wood Natural Maple Veneer

The code: WNM specifies wood natural maple veneer.

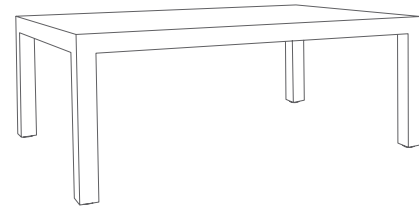

Laminate Wood Veneer

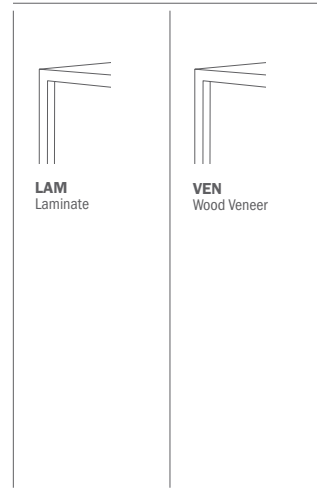

Complete Table List Pricing

	Top Size	Table Height	Model #	\$		
Rectangle 	18	60	16	PA1860RE16	1,394	2,048
	18	60	18	PA1860RE18	1,432	2,104
	18	60	20	PA1860RE20	1,454	2,126
	20	30	16	PA2030RE16	1,133	1,684
	20	30	18	PA2030RE18	1,171	1,740
	20	30	20	PA2030RE20	1,192	1,925
	24	36	16	PA2436RE16	1,262	1,865
	24	36	18	PA2436RE18	1,300	1,938
	24	48	16	PA2448RE16	1,377	2,036
	24	48	18	PA2448RE18	1,415	2,092

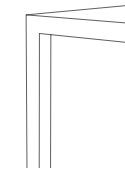

Options

Top Materials and Finishes

Standard Laminates	use manufacturers finish code	n/c
Standard Wood Veneer	use wood surface code	n/c
Premium Laminates	PRL	🕒
Custom Wood Veneer	CWV	🕒
Special Pattern Veneer	SPV	🕒
Stain to Match (set-up charge)	STM	\$412

How to Order

Table Model Number

PA **1860** **RE** **18** **VEN**
 Base Series Top Size Top Shape Table Height Material

A PA1860RE18VEN is a Parsons series 18" x 60" rectangle x 18" high occasional table, with four wood veneer legs.

Top Finish Selection

WNM
 Wood Natural Maple Veneer

The code: WNM specifies wood natural maple veneer.

Laminate Tops		Wood Veneer Tops			
Self Edge Vinyl Edges	Wood Edges Group A	Wood Edges Group B	Wood Edges Group A	Wood Edges Group B	
LLSE Self Edge	LWFL Flat	LWBN Bullnose	WWFL Flat	WWBN Bullnose	
	LWTP Tapered Ply	LWPR Prism	WWTP Tapered Ply	WWPR Prism	
	LWFP Flat Ply	LWPI Pivot	WWFP Flat Ply	WWPI Pivot	
		LWSQ Square		WWSQ Square	

Specialty Tops			
Acrylic	Corian Group A,B	Corian Group C,D	3form Chroma
AAOP Opaque	C1FL Flat	C2FL Flat	3FFL Flat
AATL Translucent	C1BN Bullnose	C2BN Bullnose	3FBN Bullnose
	C1PR Prism	C2PR Prism	3FPR Prism

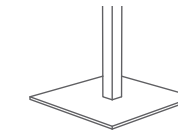

Options

Base Finishes		
Standard Powder Coat	use finish code	n/c
Polished or Satin Chrome (per base)	use finish code	\$213
Premium Plated (per base)	use finish code	Ⓛ
Custom Powder Coat (set-up charge)	CPC	\$363

Top Materials and Finishes		
Standard Laminates	use manufacturers finish code	n/c
Premium Laminates	PRL	Ⓛ
Custom Wood Veneer	CWV	Ⓛ
Special Pattern Veneer	SPV	Ⓛ
Stain to Match (set-up charge)	STM	\$412

Complete Table List Pricing

	Top Size	Table Height	Base Qty.	Model #	\$					
Square	20	20	16	1	PL2020SQ16	664	847	998	836	1,042
	20	20	18	1	PL2020SQ18	664	847	998	836	1,042
	20	20	20	1	PL2020SQ20	664	847	998	836	1,042
	24	24	16	1	PL2424SQ16	690	898	1,067	908	1,139
	24	24	18	1	PL2424SQ18	690	898	1,067	908	1,139
	24	24	20	1	PL2424SQ20	690	898	1,067	908	1,139
	30	30	16	1	PL3030SQ16	750	1,011	1,192	1,011	1,279
	30	30	18	1	PL3030SQ18	750	1,011	1,192	1,011	1,279
	36	36	16	1	PL3636SQ16	990	1,287	1,507	1,323	1,612
36	36	18	1	PL3636SQ18	990	1,287	1,507	1,323	1,612	
42	42	16	1	PL4242SQ16	1,079	1,413	1,671	1,507	1,797	
42	42	18	1	PL4242SQ18	1,079	1,413	1,671	1,507	1,797	
Rectangle	20	30	16	1	PL2030RE16	693	903	1,077	916	1,153
	20	30	18	1	PL2030RE18	693	903	1,077	916	1,153
	20	36	16	1	PL2036RE16	711	939	1,136	969	1,227
	20	36	18	1	PL2036RE18	711	939	1,136	969	1,227
	30	36	16	1	PL3036RE16	953	1,235	1,433	1,307	1,529
	30	36	18	1	PL3036RE18	953	1,235	1,433	1,307	1,529
	30	42	16	1	PL3042RE16	988	1,330	1,552	1,412	1,663
	30	42	18	1	PL3042RE18	988	1,330	1,552	1,412	1,663
	30	48	16	1	PL3048RE16	1,150	1,500	1,741	1,591	1,860
	30	48	18	1	PL3048RE18	1,150	1,500	1,741	1,591	1,860

\$			
-	1,052	1,167	1,465
	1,052	1,167	1,465
	1,052	1,167	1,465
1,302	1,130	1,283	1,771
1,302	1,130	1,283	1,771
1,302	1,130	1,283	1,771
1,763	1,382	1,610	2,759
1,763	1,382	1,610	2,759
2,386	1,877	2,196	3,822
2,386	1,877	2,196	3,822
3,038	2,246	2,670	4,946
3,038	2,246	2,670	4,946
-	1,142	1,300	2,003
-	1,142	1,300	2,003
-	1,208	1,392	2,254
-	1,208	1,392	2,254
2,178	1,682	1,949	3,347
2,178	1,682	1,949	3,347
2,421	1,820	2,130	3,785
2,421	1,820	2,130	3,785
2,795	2,097	2,449	4,338
2,795	2,097	2,449	4,338

How to Order

Table Model Number				
PL Base Series	2020 Top Size	SQ Top Shape	16 Table Height	WWFL Material
				MBK Base Finish

A PL2020SQ16WWFLMBK is a Platform series 20" x 20" square x 16" high occasional table with a black powder coat square base and a wood veneer 1.25" thick top with a .125" flat wood edge profile.

Top Finish Selection	
WMW Top Finish	WMW Edge Finish

The codes: WMW WMW specify a medium walnut top, with a medium walnut edge.

Laminate Tops		Wood Veneer Tops			
Self Edge Vinyl Edges	Wood Edges Group A	Wood Edges Group B	Wood Edges Group A	Wood Edges Group B	
LLSE Self Edge	LWFL Flat	LWBN Bullnose	WWFL Flat	WWBN Bullnose	
	LWTP Tapered Ply	LWPR Prism	WWTP Tapered Ply	WWPR Prism	
	LWFP Flat Ply	LWPI Pivot	WWFP Flat Ply	WWPI Pivot	
		LWSQ Square		WWSQ Square	

Specialty Tops			
Acrylic	Corian Group A,B	Corian Group C,D	3form Chroma
AAOP Opaque	C1FL Flat	C2FL Flat	3FFL Flat
AATL Translucent	C1BN Bullnose	C2BN Bullnose	3FBN Bullnose
	C1PR Prism	C2PR Prism	3FPR Prism

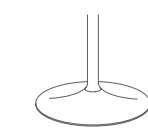

Options

Base Finishes	use finish code	n/c
Standard Powder Coat		
Polished or Satin Chrome (per base)	use finish code	\$194
Premium Plated (per base)	use finish code	\$363
Custom Powder Coat (set-up charge)	CPC	

Complete Table List Pricing

	Top Size	Table Height	Base Style	Base Qty.	Model #	\$					
Round	20	16	18L	1	TL18L20RD16	831	1,014	1,144	998	1,198	
	20	18	18L	1	TL18L20RD18	831	1,014	1,144	998	1,198	
	20	20	18L	1	TL18L20RD20	831	1,014	1,144	998	1,198	
	24	16	18L	1	TL18L24RD16	855	1,063	1,232	1,073	1,304	
	24	18	18L	1	TL18L24RD18	855	1,063	1,232	1,073	1,304	
	24	20	18L	1	TL18L24RD20	855	1,063	1,232	1,073	1,304	
	30	16	18M	1	TL18M30RD16	970	1,231	1,412	1,231	1,231	
	30	18	18M	1	TL18M30RD18	970	1,231	1,412	1,231	1,231	
	36	16	18H	1	TL18H36RD16	1,120	1,427	1,637	1,453	1,742	
	36	18	18H	1	TL18H36RD18	1,120	1,427	1,637	1,453	1,742	
	42	16	24M	1	TL24M42RD16	1,261	1,583	1,841	1,677	1,967	
	42	18	24M	1	TL24M42RD18	1,261	1,583	1,841	1,677	1,967	
Square	20	20	16	18L	1	TL18L2020SQ16	829	1,012	1,163	1,001	1,207
	20	20	18	18L	1	TL18L2020SQ18	829	1,012	1,163	1,001	1,207
	20	20	20	18L	1	TL18L2020SQ20	829	1,012	1,163	1,001	1,207
	24	24	16	18L	1	TL18L2424SQ16	855	1,063	1,232	1,073	1,304
	24	24	18	18L	1	TL18L2424SQ18	855	1,063	1,232	1,073	1,304
	24	24	20	18L	1	TL18L2424SQ20	855	1,063	1,232	1,073	1,304
	30	30	16	18M	1	TL18M3030SQ16	970	1,231	1,412	1,231	1,499
	30	30	18	18M	1	TL18M3030SQ18	970	1,231	1,412	1,231	1,499
	36	36	16	18H	1	TL18H3636SQ16	1,120	1,417	1,637	1,453	1,742
	36	36	18	18H	1	TL18H3636SQ18	1,120	1,417	1,637	1,453	1,742

Continued on next page

\$			
-	1,287	1,422	1,772
	1,287	1,422	1,772
	1,287	1,422	1,772
1,465	1,380	1,557	1,969
1,465	1,380	1,557	1,969
1,465	1,380	1,557	1,969
1,978	1,707	1,971	3,024
1,978	1,707	1,971	3,024
2,509	2,125	2,483	4,004
2,509	2,125	2,483	4,004
3,200	2,556	3,033	5,180
3,200	2,556	3,033	5,180
-	1,217	1,332	1,630
	1,217	1,332	1,630
	1,217	1,332	1,630
1,467	1,295	1,448	1,936
1,467	1,295	1,448	1,936
1,467	1,295	1,448	1,936
1,983	1,602	1,830	2,979
1,983	1,602	1,830	2,979
2,516	2,007	2,326	3,952
2,516	2,007	2,326	3,952

How to Order

Table Model Number						Top Finish Selection	
TL Base Series	20 Top Size	RD Top Shape	16 Table Height	WWFL Material	MBK Base Finish	WMW Top Finish	WMW Edge Finish

A TL18L20RD16WWFLMBK is a Tulip series 20" round x 16" high occasional table, with a black powder coat base and a wood round veneer 1.25" thick top with a .125" flat wood edge profile.

The codes: WMW WMW specify a medium walnut top, with a medium walnut edge.

Laminate Tops		Wood Veneer Tops			
Self Edge Vinyl Edges	Wood Edges Group A	Wood Edges Group B	Wood Edges Group A	Wood Edges Group B	
LLSE Self Edge	LWFL Flat	LWBN Bullnose	WWFL Flat	WWBN Bullnose	
	LWTP Tapered Ply	LWPR Prism	WWTP Tapered Ply	WWPR Prism	
	LWFP Flat Ply	LWPI Pivot	WWFP Flat Ply	WWPI Pivot	
		LWSQ Square		WWSQ Square	

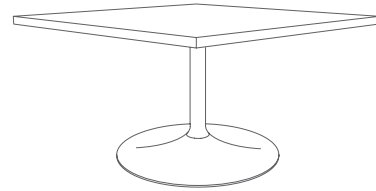

Complete Table List Pricing

	Top Size	Table Height	Base Style	Base Qty.	Model #	\$					
Square	42	42	16	24M	1	TL24M4242SQ16	1,249	1,583	1,841	1,677	1,967
	42	42	18	24M	1	TL24M4242SQ18	1,249	1,583	1,841	1,677	1,967
Rectangle	20	30	16	18M	1	TL18M2030RE16	913	1,123	1,297	1,136	1,373
	20	30	18	18M	1	TL18M2030RE18	913	1,123	1,297	1,136	1,373
	20	36	16	18H	1	TL18H2036RE16	1,001	1,229	1,426	1,259	1,517
	20	36	18	18H	1	TL18H2036RE18	1,001	1,229	1,426	1,259	1,517
	30	36	16	18H	1	TL18H3036RE16	1,083	1,365	1,563	1,437	1,659
	30	36	18	18H	1	TL18H3036RE18	1,083	1,365	1,563	1,437	1,659
	30	42	16	24M	1	TL24M3042RE16	1,158	1,500	1,722	1,582	1,833
	30	42	18	24M	1	TL24M3042RE18	1,158	1,500	1,722	1,582	1,833
	30	48	16	24H	1	TL24H3048RE16	1,310	1,660	1,901	1,751	2,020
	30	48	18	24H	1	TL24H3048RE18	1,310	1,660	1,901	1,751	2,020
Oval	20	36	16	18H	1	TL18H2036OV16	1,075	1,294	1,418	1,320	1,467
	20	36	18	18H	1	TL18H2036OV18	1,075	1,294	1,418	1,320	1,467
	24	42	16	24M	1	TL24M2442OV16	1,162	1,416	1,572	1,485	1,645
	24	42	18	24M	1	TL24M2442OV18	1,162	1,416	1,572	1,485	1,645

How to Order

Table Model Number						Top Finish Selection	
TL24M Base Series	4242 Top Size	SQ Top Shape	16 Table Height	WWFL Material	MBK Base Finish	WMW Top Finish	WMW Edge Finish

A TL24M4242SQ16WWFLMBK is a Tulip series 42" x 42" square x 16" high occasional table, with a black powder coat round base and a wood veneer 1.25" thick top with a .125" flat wood edge profile.

The codes: WMW WMW specify a medium walnut top, with a medium walnut edge.

Acrylic	Corian Group A,B	Corian Group C,D	3form Chroma
AAOP Opaque	C1FL Flat	C2FL Flat	3FFL Flat
AATL Translucent	C1BN Bullnose	C2BN Bullnose	3FBN Bullnose
	C1PR Prism	C2PR Prism	3FPR Prism

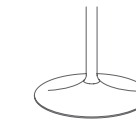

Options

Base Finishes	use finish code	n/c
Standard Powder Coat	use finish code	n/c
Polished or Satin Chrome (per base)	use finish code	\$194
Premium Plated (per base)	use finish code	\$
Custom Powder Coat (set-up charge)	CPC	\$363

Top Materials and Finishes	use manufacturers finish code	n/c
Standard Laminates	PRL	\$
Premium Laminates	CWW	\$
Custom Wood Veneer	SPV	\$
Special Pattern Veneer	STM	\$412
Stain to Match (set-up charge)		

\$			
3,208	2,416	2,840	5,116
3,208	2,416	2,840	5,116
-	1,362	1,520	2,223
	1,362	1,520	2,223
-	1,498	1,682	2,544
	1,498	1,682	2,544
2,308	1,812	2,079	3,477
2,308	1,812	2,079	3,477
2,591	1,990	2,300	3,955
2,591	1,990	2,300	3,955
2,955	2,257	2,609	4,498
2,955	2,257	2,609	4,498
-	1,703	1,908	-
	1,703	1,908	
-	1,985	2,261	-
	1,985	2,261	

Outdoor Tables

194	Arc
196	Basic Round
198	Bistro
200	Disc
202	Flat Round
204	Mark IV
206	Park
208	Platform
210	Sam Table
212	Tulip

Metal Tops



Metal Solid	Metal Mesh	Stainless Steel
MES Solid	MEM Mesh	MSS Scalloped Pattern Inset Top

Complete Table List Pricing

	Top Size	Base Height	Base Qty.	Model #	\$		
Round	32	29.25	1	ARC32RDOD	730	-	-



Specialty Tops

Acrylic	Corian Group A,B	Corian Group C,D	3form Chroma
AAOP Opaque	C1FL Flat	C2FL Flat	3FRB Reverse Bevel
AATL Translucent	C1BN Bullnose	C2BN Bullnose	
	C1PR Prism	C2PR Prism	

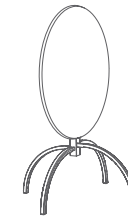

Options

Base/Top Finish		
Standard Powder Coat	MSL (silver)	n/c
Base Options		
Tilt-top Table	standard	n/c

\$	-	-	-	-
----	---	---	---	---

How to Order

Table Model Number

ARC	28	RD	OD	MES	MSL
Base Series	Top Size	Top Shape	Outdoor	Top Material	Base Finish

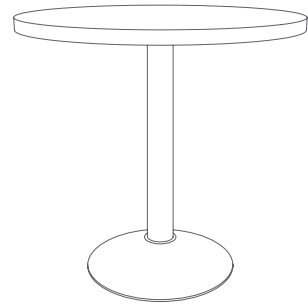

An ARC32RDODMESMSL is an outdoor Arc series 28" round metal table with a silver powder coat base.

Metal Tops



Metal Solid MES Solid	Metal Mesh MEM Mesh	Stainless Steel MSS Scalloped Pattern Inset Top
---------------------------------	-------------------------------	---

Complete Table List Pricing

	Top Size	Base Qty.	Base Style	Model #	\$		
Round 	24	1	17L	BA17L24RDOD	-	-	-
	30	1	17M	BA17M30RDOD	791	-	-
	36	1	20M	BA20M36RDOD	887	-	-
	42	1	22L	BA22L42RDOD	1020	-	-
	48	1	22M	BA22M48RDOD	1138	-	-
	54	1	22H	BA22H54RDOD	-	-	-
60	1	28H	BA28H60RDOD	-	-	-	
Square 	24	24	1	17L	BA17L2424SQOD	-	-
	30	30	1	17M	BA17M3030SQOD	789	-
	36	36	1	20M	BA20M3636SQOD	869	-
	42	42	1	22M	BA22M4242SQOD	1043	-
	48	48	1	22H	BA22H4848SQOD	-	-
Rectangle 	24	30	1	17M	BA17M2430REOD	725	-
	24	36	1	20M	BA20M2436REOD	-	-
	24	60	2	17L	BA17L2460REOD	-	-
	30	36	1	20M	BA20M3036REOD	-	-
	30	42	1	22L	BA22L3042REOD	-	-
	30	48	1	22M	BA22M3048REOD	985	-
	30	60	2	17M	BA17M3060REOD	-	-

Specialty Tops

Acrylic AAOP Opaque AATL Translucent	Corian Group A,B C1FL Flat C1BN Bullnose C1PR Prism	Corian Group C,D C2FL Flat C2BN Bullnose C2PR Prism	3form Chroma 3FRB Reverse Bevel
---	---	---	---

\$	1,019	934	1,111	1,643
	1,507	1,236	1,500	2,813
	1,978	1,594	1,952	3,831
	2,664	2,020	2,497	5,129
	3,545	2,489	3,092	6,588
	4,713	3,038	3,786	-
	5,977	3,639	4,551	-
	1,021	849	1,002	1,814
	1,512	1,131	1,359	2,759
	1,985	1,476	1,795	3,768
	2,697	1,905	2,329	5,079
	3,620	2,400	2,945	6,578
	1,263	995	1,178	2,312
	1,557	1,118	1,334	2,683
	-	1,768	2,121	4,378
	1,777	1,281	1,548	3,246
	2,055	1,454	1,764	3,763
	2,329	1,631	1,983	4,250
	3,038	2,097	2,535	5,359

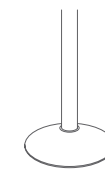

Options

Base Finishes		
Standard Black Wrinkle	MWR	n/c
Powder Coat	use finish code	\$110
Custom Powder Coat (set-up charge)	CPC	\$363
Base Options		
Alternate Height Base (per column)	AH	\$66
Super Level Glides (per base)	GSL	n/c
Custom Top Plate Size	CTPS	🔒
6" Column (powder coat)	COL6	🔒
Top Options		
Custom Size	CS	🔒
Custom Shape	CSH	🔒
Custom Radius Corner	CRC	🔒
3" Radius Corner (per corner)	CRL3	\$34
(Corian®)		
Standard Powder Coat	use finish code	n/c
2" Umbrella Hole	UMB	\$248

How to Order

Table Model Number						Top Finish Selection		Options	
BA20M Base Series	36 Top Size	RD Top Shape	OD Outdoor	MES Top Material	MBK Base Finish	MSL Top Finish		AH Alternate Height Base	
A BA20M36RDODMESMBK is an outdoor Basic Round series 36" round table with a black powder coat round base and a solid metal .75" thick top with a metal eased edge profile.						The code: MSL specifies a silver powder coat top.		The code: AH specifies alternate height base	

Metal Tops



Metal Solid MES Solid	Metal Mesh MEM Mesh	Stainless Steel MSS Scalloped Pattern Inset Top
------------------------------------	----------------------------------	--

Complete Table List Pricing

	Top Size	Base Qty.	Model #	\$		
Round	24	1	DIRDOD	-	-	-
	30	1	DI30RDOD	1,052	-	-
	36	1	DI36RDOD	1,297	-	-
	42	1	DI42RDOD	1,395	-	-
	48	1	DI48RDOD	1,613	-	-
	54	1	DI54RDOD	-	-	-
60	1	DI60RDOD	-	-	-	
Square	24 24	1	DI2424SQOD	-	-	-
	30 30	1	DI3030SQOD	1,050	-	-
	36 36	1	DI3636SQOD	1,279	-	-
	42 42	1	DI4242SQOD	1,393	-	-
	48 48	1	DI4848SQOD	-	-	-
Rectangle	24 30	1	DI2430REOD	986	-	-
	24 36	1	DI2436REOD	-	-	-
	24 60	2	DI2460REOD	-	-	-
	30 36	1	DI3036REOD	-	-	-
	30 42	1	DI3042REOD	-	-	-
	30 48	1	DI3048REOD	1,460	-	-
	30 60	2	DI3060REOD	-	-	-

Specialty Tops

Acrylic AAOP Opaque AATL Translucent	Corian Group A,B C1FL Flat C1BN Bullnose C1PR Prism	Corian Group C,D C2FL Flat C2BN Bullnose C2PR Prism	3form Chroma 3FRB Reverse Bevel
---	--	--	--

\$				
887	1,055	1,350	1,934	
1,310	1,225	1,698	3,074	
2,388	2,004	2,362	4,241	
3,039	2,395	2,872	5,504	
4,020	2,964	3,567	7,063	
-	3,448	4,196	-	
6,337	3,999	4,911	-	
1,312	1,140	1,293	2,105	
1,773	1,392	1,620	3,020	
2,395	1,886	2,205	4,178	
3,047	2,255	2,679	5,429	
4,030	2,810	3,355	6,988	
1,524	1,256	1,439	2,573	
1,967	1,528	1,744	3,093	
-	1,305	2,546	4,960	
2,187	1,691	1,958	3,656	
2,430	1,829	2,139	4,138	
2,804	2,106	2,458	4,725	
3,208	2,267	2,890	6,199	

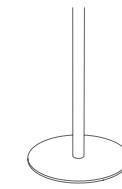

Options

Base Finishes		
Standard Powder Coat	use finish code	n/c
Custom Powder Coat (set-up charge)	CPC	\$363
Base Options		
Alternate Height Base (per column)	AH	\$66
Custom Top Plate Size	CTPS	🕒
6" Column (powder coat)	COL6	🕒
Top Options		
Custom Size	CS	🕒
Custom Shape	CSH	🕒
Custom Radius Corner	CRC	🕒
3" Radius Corner (per corner)	CRL3	\$34
Standard Powder Coat	use finish code	n/c
2" Umbrella Hole	UMB	\$248

How to Order

Table Model Number						Top Finish Selection	Options
DI Base Series	36 Top Size	RD Top Shape	OD Outdoor	MES Top Material	MSL Base Finish	MBK Top Finish	AH Alternate Height Base
A DI36RDODMESMSL is an outdoor Disc series 36" round table with a silver powder coat round base and a metal .75" thick top with a metal eased edge profile.						The code: MBK specifies a black matte powder coat top.	The code: AH specifies alternate height base



Complete Table List Pricing

	Top Size	Base Qty.	Model #	\$		
Round	24	1	FR24RDOD	-	-	-
	30	1	FR30RDOD	1,021	-	-
	36	1	FR36RDOD	1,207	-	-
	42	1	FR42RDOD	1,305	-	-
	48	1	FR48RDOD	1,398	-	-
	54	1	FR54RDOD	-	-	-
	60	1	FR60RDOD	-	-	-
Square	24 24	1	FR2424SQOD	-	-	-
	30 30	1	FR3030SQOD	1,019	-	-
	36 36	1	FR3636SQOD	1,189	-	-
	42 42	1	FR4242SQOD	1,303	-	-
	48 48	1	FR4848SQOD	-	-	-
Rectangle	24 30	1	FR2430REOD	955	-	-
	24 36	1	FR2436REOD	-	-	-
	24 60	2	FR2460REOD	-	-	-
	30 36	1	FR3036REOD	-	-	-
	30 42	1	FR3042REOD	-	-	-
	30 48	1	FR3048REOD	1,245	-	-
	30 60	2	FR3060REOD	-	-	-

Specialty Tops

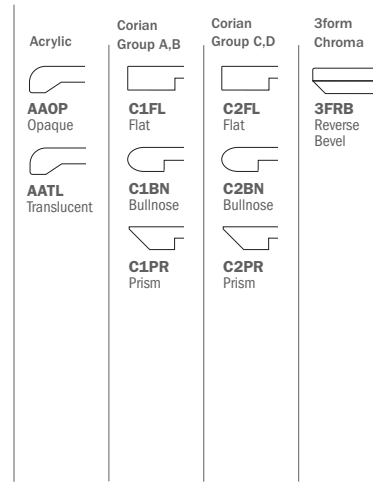

\$	1,279	1,194	1,371	1,903
	1,737	1,466	1,730	3,043
	2,298	1,914	2,272	4,151
	2,949	2,305	2,782	5,414
	3,805	2,749	3,352	6,848
	-	3,333	4,081	-
	6,222	3,884	4,796	-
	1,281	1,109	1,262	2,074
	1,742	1,361	1,589	2,989
	2,305	1,796	2,115	4,088
	2,957	2,165	2,589	5,339
	3,915	2,695	3,240	6,873
	1,493	1,225	1,408	2,542
	1,777	1,338	1,554	2,903
	-	2,288	2,641	4,898
	1,997	1,501	1,768	3,466
	2,340	1,739	2,049	4,048
	2,589	1,891	2,243	4,510
	3,498	2,557	2,995	5,819

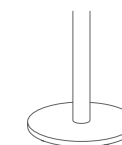

Options

Base Finishes		
Standard Powder Coat	use finish code	n/c
Anodized Aluminum	MAA	\$44
Custom Powder Coat (set-up charge)	CPC	\$363
Base Options		
Alternate Height Base (per column)	AH	\$66
Custom Top Plate Size	CTPS	Ⓛ
6" Column (powder coat)	COL6	Ⓛ
Top Options		
Custom Size	CS	Ⓛ
Custom Shape	CSH	Ⓛ
Custom Radius Corner	CRC	Ⓛ
3" Radius Corner (per corner) (Corian®)	CRL3	\$34
Standard Powder Coat	use finish code	n/c
2" Umbrella Hole	UMB	\$248

How to Order

Table Model Number						Top Finish Selection	Options
FR Base Series	36 Top Size	RD Top Shape	OD Outdoor	AAOP Top Material	MAA Base Finish	AGL Top Finish	AH Alternate Height Base
A FR36RDODAAOP is an outdoor Flat Round series 36" round table with an anodized aluminum round base and anopaque acrylic top.						The code: AAOP specifies an acrylic top in Glacier	The code: AH specifies alternate height base

Metal Tops



Metal Solid MES Solid	Metal Mesh MEM Mesh	Stainless Steel MSS Scalloped Pattern Inset Top
------------------------------------	----------------------------------	--

Complete Table List Pricing

	Top Size	Base Style	Base Qty.	Model #	\$		
Round	24	24X	1	MAX24RDOD	-	-	-
	30	24X	1	MAX30RDOD	951	-	-
	36	30X	1	MAX36RDOD	1,167	-	-
	42	30X	1	MAX42RDOD	1,265	-	-
	48	36X	1	MAX48RDOD	1,458	-	-
	54	36X	1	MAX54RDOD	-	-	-
	60	36X	1	MAX60RDOD	-	-	-
Square	24	24	24X	1	MAX2424SQOD	-	-
	30	30	24X	1	MAX3030SQOD	949	-
	36	36	30X	1	MAX3636SQOD	1,149	-
	42	42	30X	1	MAX4242SQOD	1,263	-
	48	48	36X	1	MAX4848SQOD	-	-
Rectangle	24	30	24X	1	MAX2430REOD	885	-
	30	36	24X	1	MAX3036REOD	-	-
	30	42	30X	1	MAX3042REOD	-	-
	30	48	30X	1	MAX3048REOD	1205	-
	30	60	27V	2	MAV3060REOD	-	-

Specialty Tops

Acrylic AAOP Opaque AATL Translucent	Corian Group A,B C1FL Flat C1BN Bullnose C1PR Prism	Corian Group C,D C2FL Flat C2BN Bullnose C2PR Prism	3form Chroma 3FRB Reverse Bevel
---	--	--	--

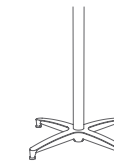

X Base

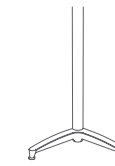

V Base

Options

Base Finishes		
Standard Powder Coat	use finish code	n/c
Anodized Aluminum	MAA	\$44
Custom Powder Coat (set-up charge)	CPC	\$363
Base Options		
Alternate Height Base (per column)	AH	\$66
Top Options		
Custom Size	CS	Ⓛ
Custom Shape	CSH	Ⓛ
Custom Radius Corner	CRC	Ⓛ
3" Radius Corner (per corner) (Corian®)	CRL3	\$34
Standard Powder Coat	use finish code	n/c



\$				
1,208	1,124	1,300	1,832	
1,667	1,395	1,659	2,973	
2,258	1,874	2,232	4,111	
2,909	2,265	2,742	5,374	
3,865	2,809	3,412	6,908	
-	3,293	4,041	-	
6,182	3,844	4,756	-	
1,210	1,039	1,192	2,004	
1,671	1,290	1,519	2,918	
2,265	1,756	2,075	4,048	
2,917	2,125	2,549	5,299	
3,875	2,655	3,200	6,833	
1,422	1,154	1,338	2,472	
1,926	1,430	1,698	3,396	
2,300	1,699	2,009	4,008	
2,549	1,851	2,203	4,470	
3,378	2,437	2,875	5,699	

How to Order



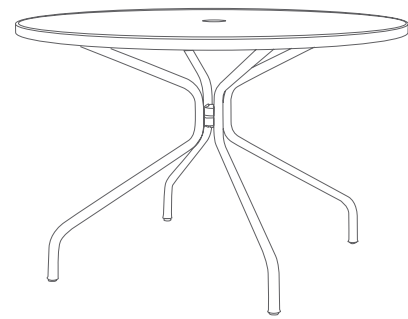





Table Model Number						Top Finish Selection	Options
MAX Base Series	36 Top Size	RD Top Shape	OD Outdoor	3FRB Top Material	MAA Base Finish	FPW Top Finish	AH Alternate Height Base
A MAX36RDOD3FRBMAA is an outdoor Mark IV series 36" round table with an anodized aluminum X-base and a 3Form outdoor top with a reverse bevel edge profile.						The code: specifies a 3form chroma top in Pewter.	The code: AH specifies alternate height base

Metal Tops



<p>Metal Solid</p>  <p>MES Solid</p>	<p>Metal Mesh</p>  <p>MEM Mesh</p>	<p>Stainless Steel</p>  <p>MSS Scalloped Pattern Inset Top</p>
---	---	---

Specialty Tops

<p>Acrylic</p>  <p>AAOP Opaque</p>  <p>AATL Translucent</p>	<p>Corian Group A,B</p>  <p>C1FL Flat</p>  <p>C1BN Bullnose</p>  <p>C1PR Prism</p>	<p>Corian Group C,D</p>  <p>C2FL Flat</p>  <p>C2BN Bullnose</p>  <p>C2PR Prism</p>	<p>3form Chroma</p>  <p>3FRB Reverse Bevel</p>
--	---	---	---



Options

Base/Top Finish	Standard Powder Coat	MSL (Silver)	n/c
------------------------	----------------------	--------------	-----

Complete Table List Pricing

	Top Size	Base Height	Base Qty.	Model #	\$		
Round	36	29	1	PK36RDOD	-	812	-
	48	29	1	PK48RDOD	-	1026	-



Includes 1.625" umbrella hole

How to Order

Table Model Number

PK	36	RD	OD	MEM	MSL
Base Series	Top Size	Top Shape	Outdoor	Top Material	Base & Top Finish

A PK36RDODMEMMSL is an outdoor Park series 36" round silver powder coat table with a metal mesh top.

Metal Tops

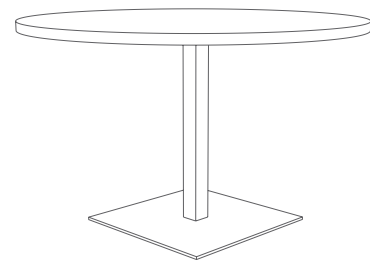

Metal Solid MES Solid	Metal Mesh MEM Mesh	Stainless Steel MSS Scalloped Pattern Inset Top
------------------------------------	----------------------------------	--

Complete Table List Pricing

	Top Size	Base Qty.	Model #	\$		
Round	24	1	PL24RDOD	-	-	-
	30	1	PL30RDOD	1,052	-	-
	36	1	PL36RDOD	1,297	-	-
	42	1	PL42RDOD	1,395	-	-
	48	1	PL48RDOD	1,613	-	-
	54	1	PL54RDOD	-	-	-
	60	1	PL60RDOD	-	-	-
Square	24 24	1	PL2424SQOD	-	-	-
	30 30	1	PL3030SQOD	1,050	-	-
	36 36	1	PL3636SQOD	1,279	-	-
	42 42	1	PL4242SQOD	1,393	-	-
	48 48	1	PL4848SQOD	-	-	-
Rectangle	24 30	1	PL2430REOD	986	-	-
	24 36	1	PL2436REOD	-	-	-
	24 60	2	PL2460REOD	-	-	-
	30 36	1	PL3036REOD	-	-	-
	30 42	1	PL3042REOD	-	-	-
	30 42	1	PLD3042REOD	-	-	-
	30 48	1	PL3048REOD	1,460	-	-
	30 48	1	PLD3048REOD	1,528	-	-
	30 60	2	PL3060REOD	-	-	-

Specialty Tops

Acrylic AAOP Opaque AATL Translucent	Corian Group A,B C1FL Flat C1BN Bullnose C1PR Prism	Corian Group C,D C2FL Flat C2BN Bullnose C2PR Prism	3form Chroma 3FRB Reverse Bevel
---	--	--	--

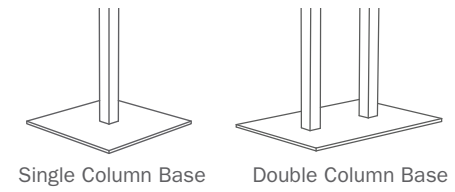

\$				
1,310	1,225	1,402	1,934	
1,768	1,497	1,761	3,074	
2,388	2,004	2,362	4,241	
3,039	2,395	2,872	5,504	
4,020	2,964	3,567	7,063	
5,123	3,448	4,196	-	
6,337	3,999	4,911	-	
1,312	1,140	1,293	2,105	
1,773	1,392	1,620	3,020	
2,395	1,886	2,205	4,178	
3,047	2,255	2,679	5,429	
4,030	2,810	3,355	6,988	
1,524	1,256	1,439	2,573	
1,967	1,528	1,744	3,093	
-	2,350	2,703	4,960	
2,187	1,691	1,958	3,656	
2,430	1,829	2,139	4,138	
2,623	2,022	2,332	4,331	
2,804	2,106	2,458	4,725	
2,872	2,174	2,526	4,793	
3,560	2,619	3,057	5,881	

Options

Base Finishes		
Standard Powder Coat	use finish code	n/c
Custom Powder Coat (set-up charge)	CPC	\$363
Base Options		
Alternate Height Base (per column)	AH	\$66
Custom Top Plate Size	CTPS	🕒
Top Options		
Custom Size	CS	🕒
Custom Shape	CSH	🕒
Custom Radius Corner	CRC	🕒
3" Radius Corner (per corner) (Corian®)	CRL3	\$34
2" Umbrella Hole	UMB	\$248

How to Order

Table Model Number						Top Finish Selection	Options
PL Base Series	36 Top Size	RD Top Shape	OD Outdoor	MES Top Material	MSL Base Finish	MBK Top Finish	AH Alternate Height Base
A PL36RDODMESMSL is an outdoor Platform series 36" round table with a silver powder coat square base and a solid metal .75" thick top with a metal eased edge profile.						The code: MBK specifies a black matte powder coat top.	The code: AH specifies alternate height base

Metal Tops



<p>Metal Solid</p> <p>MES Solid</p>	<p>Metal Mesh</p> <p>MEM Mesh</p>	<p>Stainless Steel</p> <p>MSS Scalloped Pattern Inset Top</p>
---	---	---

Specialty Tops

<p>Acrylic</p> <p>AAOP Opaque</p> <p>AATL Translucent</p>	<p>Corian Group A,B</p> <p>C1FL Flat</p> <p>C1BN Bullnose</p> <p>C1PR Prism</p>	<p>Corian Group C,D</p> <p>C2FL Flat</p> <p>C2BN Bullnose</p> <p>C2PR Prism</p>	<p>3form Chroma</p> <p>3FRB Reverse Bevel</p>
--	---	---	---



Options

Base Finish	Clear Coated Polished Aluminum	n/c
Top Finish	Stainless Steel Scalloped Pattern	MSS n/c

Complete Table List Pricing

	Top Size	Base Height	Base Qty.	Model #	\$		
Round	24	29	1	SM24RDOD	-	-	294
	30	29	1	SM30RDOD	-	-	376
	36	29	1	SM36RDOD	-	-	422
Round Standing Height	24	42	1	SM24RDOD42	-	-	422
	30	42	1	SM30RDOD42	-	-	498
Square	24 24	29	1	SM2424SQOD	-	-	294
	30 30	29	1	SM3030SQOD	-	-	376

\$			
-	-	-	-
-	-	-	-
-	-	-	-
-	-	-	-
-	-	-	-
-	-	-	-
-	-	-	-

How to Order

Table Model Number					Top Finish Selection	
SM Base Series	24 Top Size	RD Top Shape	OD Outdoor	42 Table Height	MSS Top Finish	
<p>A SM24RDOD42MSS is an outdoor Sam series bar-height table with a 24" stainless steel top with scalloped pattern and a clear coated polished aluminum base.</p>					<p>The code: MSS specify a stainless steel inset top with scalloped pattern.</p>	

Metal Tops



Metal Solid	Metal Mesh	Stainless Steel
MES Solid	MEM Mesh	MSS Scalloped Pattern Inset Top

Complete Table List Pricing

	Top Size	Base Qty.	Model #	\$		
Round	24	1	TL18L24RDOD	-	-	-
	30	1	TL18M30RDOD	1,296	-	-
	36	1	TL18H36RDOD	1,452	-	-
	42	1	TL24M42RDOD	1,590	-	-
	48	1	TL24H48RDOD	1,798	-	-
	54	1	TL24XH54RDOD	-	-	-
Square	24 24	1	TL18L2424SQOD	-	-	-
	30 30	1	TL18M3030SQOD	1,294	-	-
	36 36	1	TL18H3636SQOD	1,434	-	-
	42 42	1	TL24H4242SQOD	1,703	-	-
	48 48	1	TL24XH4848SQOD	-	-	-
Rectangle	24 30	1	TL18M2430REOD	1,230	-	-
	24 36	1	TL18H2436REOD	-	-	-
	24 60	2	TL18L2460REOD	-	-	-
	30 36	1	TL18H3036REOD	-	-	-
	30 42	1	TL24M3042REOD	-	-	-
	30 48	1	TL24H3048REOD	1,645	-	-
	30 60	2	TL18M3060REOD	-	-	-

Specialty Tops

Acrylic	Corian Group A,B	Corian Group C,D	3form Chroma
AAOP Opaque	C1FL Flat	C2FL Flat	3FRB Reverse Bevel
AATL Translucent	C1BN Bullnose	C2BN Bullnose	
	C1PR Prism	C2PR Prism	



Options

Base Finishes		
Standard Powder Coat	use finish code	n/c
Custom Powder Coat (set-up charge)	CPC	\$363
Base Options		
Alternate Height Base (per column)	AH	\$66
Custom Top Plate Size	CTPS	🕒
Top Options		
Custom Size	CS	🕒
Custom Shape	CSH	🕒
Custom Radius Corner	CRC	🕒
3" Radius Corner (per corner) (Corian®)	CRL3	\$34
Standard Powder Coat	use finish code	n/c

\$				
1,499	1,414	1,591	2,123	
2,012	1,741	2,005	3,318	
2,543	2,159	2,517	4,396	
3,234	2,590	3,067	5,699	
4,205	3,149	3,752	7,248	
5,343	3,668	4,416	-	
1,501	1,329	1,482	2,294	
2,017	1,636	1,864	3,264	
2,550	2,041	2,360	4,333	
3,357	2,565	2,989	5,739	
4,250	3,030	3,575	7,208	
1,768	1,500	1,683	2,817	
2,122	1,683	1,899	3,248	
-	2,728	3,081	5,338	
2,342	1,846	2,113	3,811	
2,625	2,024	2,334	4,333	
2,989	2,291	2,643	4,910	
4,048	3,107	3,545	6,369	





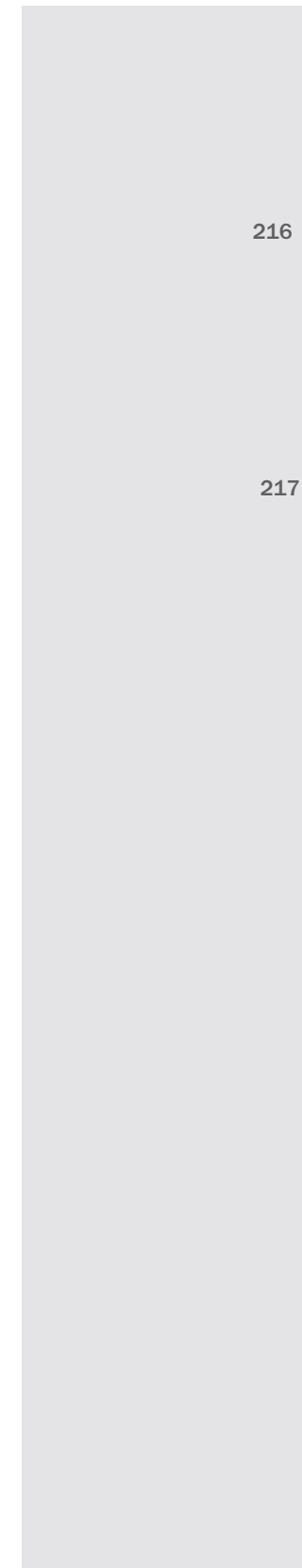

How to Order



Table Model Number						Top Finish Selection	Options
TL18H Base Series	36 Top Size	RD Top Shape	OD Outdoor	MES Top Material	MSL Base Finish	MBK Top Finish	AH Alternate Height Base
A TL18H36RDODMESMSL is an outdoor Tulip series 36" round table with a silver powder coat round base and a solid metal .75" thick top with a metal eased edge profile.						The code: MBK specifies a black matte powder coat top	The code: AH specifies alternate height base

Chairs







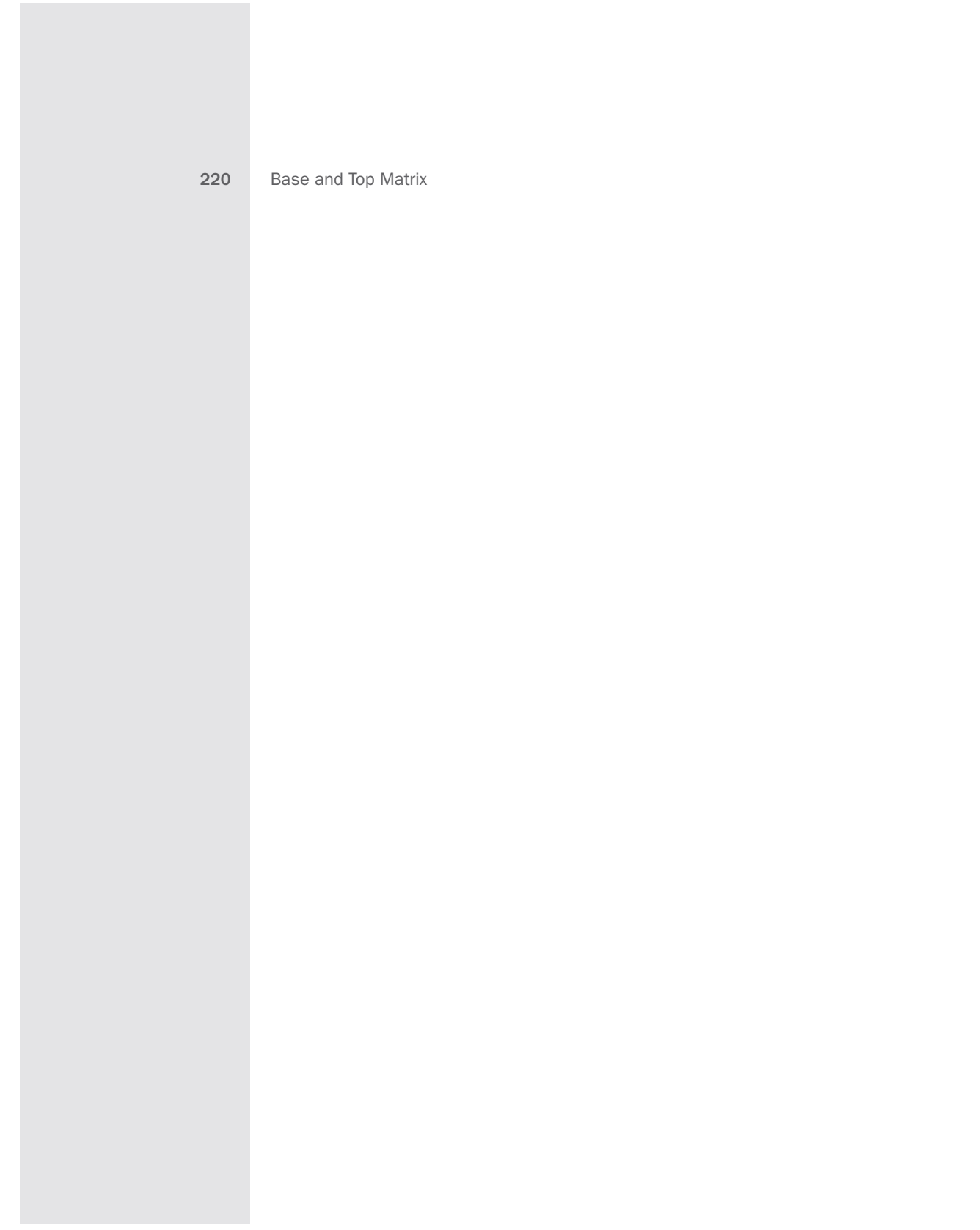

- 216 Breeze
- Courtyard
- Piazza
- Picnic
- Polly
- 217 Sam

	Description	Chair Height	Model #	\$
Breeze	Arm Chair	32.25"	BZCA	282
	Standard Finish: Powder coated silver (MSL)			
Courtyard	Arm Chair	33"	CYCA	422
	Standard Finish: Powder coated silver (MSL)			
Piazza	Arm Chair	29.5"	PZCA	214
	Standard Finish: Clear coated polished aluminum frame with Black (RBK) or Honey (RHN) synthetic rattan woven seat and back			
Piazza	Bar Arm Chair	39"	PZCB	330
	Standard Finish: Clear coated polished aluminum frame with Black (RBK) or Honey (RHN) synthetic rattan woven seat and back			
Picnic	Arm Chair	31"	PCCA	526
	Standard Finish: Powder coated silver (MSL)			
Polly	Side Chair	31"	PLCS	330
	Standard Finish: Polypropylene white (PWH) Supplemental colors (minimum order and extended leadtime applicable) Ivory (PIV), Orange (POR), Red (PRD), Green (PGR)			



	Description	Chair Height	Model #	\$
Sam	Side Chair	30.5"	SMCS	169
	Standard Finish: Clear coated polished aluminum (MPA)			
Sam	Arm Chair	32.5"	SMCA	178
	Standard Finish: Clear coated polished aluminum (MPA)			
Sam	Bar Armchair	39"	SMCB	310
	Standard Finish: Clear coated polished aluminum (MPA)			







Base and Top Matrix





		Alumiline				Basic Round*				Boltdown				Capri	Corsica		Cozy Bar					
		AL2626X	AL3232X	AL3939X	AL26T	BA17L	BA17M	BA20M	BA22L	BA22M	BA22H	BA28H	BB	TB	JB	FB	CA15	CR15	CR24	CE17	CE20	CE22
Round 	Dia																					
	24					1						1	1	1	1	1			1			
	30	1					1					1	1	1	1	1			1			
	36		1					1				1	1	1	1					1		
	42		1						1			1	1	1	1						1	
	48			1						1		1	1	1	1						1	
	54			1							1								1			
	60			1								1										
Oval 	W L																					
	36 72																					
	42 54																					
	42 78																					
	42 84																					
	48 78																					
	48 96																					
	48 96																					
Racetrack 	W L																					
	30 60																					
	30 72																					
	30 84																					
	30 96																					
	36 60																					
	36 72																					
	36 84																					
	36 96																					
	42 72																					
	42 84																					
	42 96																					
	48 96																					
	48 120																					
	48 144																					
	48 168																					
	60 120																					
	60 144																					
60 168																						
Extendo 	W L Dia																					
	30 30 42		1						1										1			
	34 34 48			1						1									1			
	36 36 51			1							1								1			
	42 42 60			1								1								1		
Square 	W L																					
	24 24		1				1					1	1	1	1	1		1				
	30 30		1					1				1	1	1	1	1		1				
	36 36			1					1			1	1	1	1				1			
	42 42			1						1		1	1	1	1				1			
48 48			1							1	1	1	1	1				1				
Rectangle 	W L																					
	18 48																					
	18 60																					
	18 72																					
	18 84																					
	18 96																					
	24 30		1				1					1	1	1	1	1		1				
24 36							1				1	1	1	1				1				
24 42								1			1	1	1	1				1				
24 48									1		1	1	1	1				1				
24 60							2				2	2	2	2								

*Basic Round bases come in three weights, top size and material will determine weight of base.

		Alumiline				Basic Round*				Boltdown				Capri	Corsica		Cozy Bar					
		AL2626X	AL3232X	AL3939X	AL26T	BA17L	BA17M	BA20M	BA22L	BA22M	BA22H	BA28H	BB	TB	JB	FB	CA15	CR15	CR24	CE17	CE20	CE22
Rectangle 	W L																					
	24 72						2					2	2	2	2							
	24 84																					
	24 96																					
	30 36		1					1				1	1	1	1				1			
	30 42		1						1			1	1	1	1				1			
	30 48		1							1		1	1	1	1				1			
	30 60				2		2					2	2	2	2							
	30 72				2		2					2	2	2	2							
	30 84																					
	30 96																					
	36 42									1		1	1	1	1				1			
	36 48									1		1	1	1	1				1			
	36 60				2			2				2	2	2	2							
	36 72				2			2				2	2	2	2							
	36 84																					
	36 96																					
	42 72																					
	42 84																					
	42 96																					
48 96																						
48 120																						
48 144																						
48 168																						
60 120																						
60 144																						
60 168																						
Half Round 	R L																					
	24 48																					
	30 60																					
	36 72																					
	36 72																					
Arc Rectangle 	W L																					
	30 60																					
	30 72																					
	30 84																					
	30 96																					
	36 60																					
	36 72																					
	36 84																					
	36 96																					
	42 72																					
	42 84																					
	42 96																					

		Mark IV					Medici	Platform				Post Leg		Presidio									
		MA2424X	MA3030X	MA3636X	MA27V	MA18T	MA30T	ME18	PL18	PL22	PL26	PLD1826	P02.5"	P03"	PR1818X	PR2424X	PR3030X	PR3636X	PR18T	PR24T	PR30T	PR30TT	PR36TT
	Round																						
	Dia																						
	24							1	1						1								
	30	1						1	1						1								
	36		1						1				4			1							
	42		1						1					4			1						
	48			1						1				4				1					
	54			1							1			4				1					
60			1							1			4				1						
	Oval																						
	W L																						
	36 72			2									4							2			
	42 54												4							2			
	42 78												4							2			
	42 84												4							2			
	48 78												4							2			
	48 96												4							2			
	Racetrack																						
	W L																						
	30 60			2					2				4							2			
	30 72			2					2				4							2			
	30 84			2					2				4							2			
	30 96			2					2				4							2			
	36 60			2					2				4							2			
	36 72			2					2				4							2			
	36 84			2					2				4							2			
	36 96			2					2				4							2			
	42 72								2				4							2			
	42 84								2				4							2			
	42 96								2				4							2			
	48 96							2					4							2			
	48 120								2				6							2			
	48 144								3				6							2			
	48 168								3				6							2			
	60 120								2				6							2			
60 144								3				6							2				
60 168								3				6							2				
	Extendo																						
	W L Dia																						
	30 30 42		1						1							1							
	34 34 48			1						1						1							
	36 36 51			1							1					1							
42 42 60			1							1					1								
	Square																						
	W L																						
	24 24		1						1						1								
	30 30		1						1						1								
	36 36			1						1			4			1							
42 42			1						1				4			1							
48 48			1						1				4			1							
	Rectangle																						
	W L																						
	18 48					2														2			
	18 60					2														2			
	18 72					2														2			
	18 84					2														2			
	18 96					2														2			
	24 30		1						1							1							
	24 36			1						1							1						
	24 42			1			2			1		1					1	2					
24 48				2					1		1					1	2						
24 60				2					2								2						

		Mark IV					Platform				Post Leg		Presidio											
		MA2424X	MA3030X	MA3636X	MA27V	MA18T	MA30T	PL18	PL22	PL26	PLD1826	P02.5"	P03"	PR1818X	PR2424X	PR3030X	PR3636X	PR18T	PR24T	PR30T	PR30TT	PR36TT		
	Rectangle																							
	W L																							
	24 72																			2				
	24 84																			2				
	24 96																			2				
	30 36			1								1						1						
	30 42											1		1						2				
	30 48											1	1							2				
	30 60																			2				
	30 72																			2				
	30 84																			2				
	30 96																			2				
	36 42																			2				
	36 48																			2				
	36 60																			2				
	36 72																			2				
	36 84																			2				
	36 96																			2				
	42 72																			2				
	42 84																			2				
	42 96																			2				
	48 96																			2				
	48 120																			2				
	48 144																			2				
	48 168																			2				
	60 120																			2				
	60 144																			2				
	60 168																			2				
		Half Round																						
		R L																						
		24 48																			2			
		30 60																			2			
		36 72																			2			
		Arc Rectangle																						
		W L																						
		30 60																			2			
30 72																				2				
30 84																				2				
30 96																				2				
36 60																				2				
36 72																				2				
36 84																				2				
36 96																				2				
42 72																				2				
42 84																				2				
42 96																				2				
48 96																				2				
48 120																				2				
48 144																			2					
48 168																			2					
60 120																			2					
60 144																			2					
60 168																			2					

		Regency					Scala	Siena	Slimline						Spacesaver									
		RG2424X	RG3030X	RG3636X	RG2142S	RG2448S	SC19.5	SI25	SL1818X	SL2424X	SL3030X	SL3636X	SL18T	SL24T	SL30T	SL30TT	SL36TT	SV2222X	SV3030X	SV3636X	SV2430EX	SV18T	SV22T	
Round	Dia																							
	24						1		1								1							
	30	1					1	1	1								1							
	36		1				1	1	1	1							1							
	42			1			1	1		1							1							
	48				1			1			1								1					
	54					1						1							1					
60					1						1							1						
Oval	W L																							
	36 72			1										2										
	42 54				1									2										
	42 78				1									2										
	42 84					1								2										
	48 78						1								2									
	48 96					1									2									
Racetrack	W L																							
	30 60												2											
	30 72				1								2											
	30 84					1							2											
	30 96					1							2											
	36 60					1								2										
	36 72					1								2										
	36 84					1								2										
	36 96						1								2									
	42 72					1									2									
	42 84						1								2									
	42 96							1							2									
	48 96								1							2								
	Extendo	W L Dia																						
30 30 42			1				1	1				1						1						
34 34 48				1			1	1				1						1						
36 36 51					1		1	1				1							1					
42 42 60						1	1	1				1							1					
Square		W L																						
		24 24						1		1							1							
	30 30	1					1	1	1						1			1						
	36 36		1				1	1	1	1					1				1					
	42 42			1			1	1	1	1	1				1				1					
Rectangle	W L																							
	18 48												2											
	18 60												2											
	18 72												2											
	18 84												2											
	18 96												2											
	24 30						1			1						1								
	24 36							1										1						
	24 42							1		1	2								1					
	24 48						1			1	2								1					
24 60																				2				

		Regency					Scala	Siena	Slimline						Spacesaver								
		RG2424X	RG3030X	RG3636X	RG2142S	RG2448S	SC19.5	SI25	SL1818X	SL2424X	SL3030X	SL3636X	SL18T	SL24T	SL30T	SL30TT	SL36TT	SV2222X	SV3030X	SV3636X	SV2430EX	SV18T	SV22T
Rectangle	W L																						
	24 72											2										2	
	24 84											2											
	24 96											2											
	30 36						1	1	1												1		
	30 42						1	1	1			2									1		
	30 48						1	1	1	1	2										1		
	30 60										1	2											2
	30 72											2											2
	30 84											2											
	30 96											2											
	36 42						1	1				2		2							1		
	36 48						1	1				2		2							1		
	36 60											2		2									2
	36 72											2		2									2
	36 84											2		2									
	36 96											2		2									
	42 72													2									
	42 84													2									
	42 96													2									
	48 96														2								
48 120														2									
48 144														3									
48 168														3									
60 120														2									
60 144														3									
60 168														3									
Half Round	R L																						
	24 48											2											
	30 60											2											
36 72												2											
Arc Rectangle	W L																						
	30 60											2											
	30 72											2											
	30 84											2											
	30 96											2											
	36 60												2										
	36 72												2										
	36 84												2										
	36 96													2									
	42 72														2								
	42 84														2								
	42 96														2								
	48 96																			2			
	48 120																			2			
48 144																			3				
48 168																			3				
60 120																			2				
60 144																			3				
60 168																			3				
Boat Shape	W C L																						
	36 42 72																						

Base Only Pricing

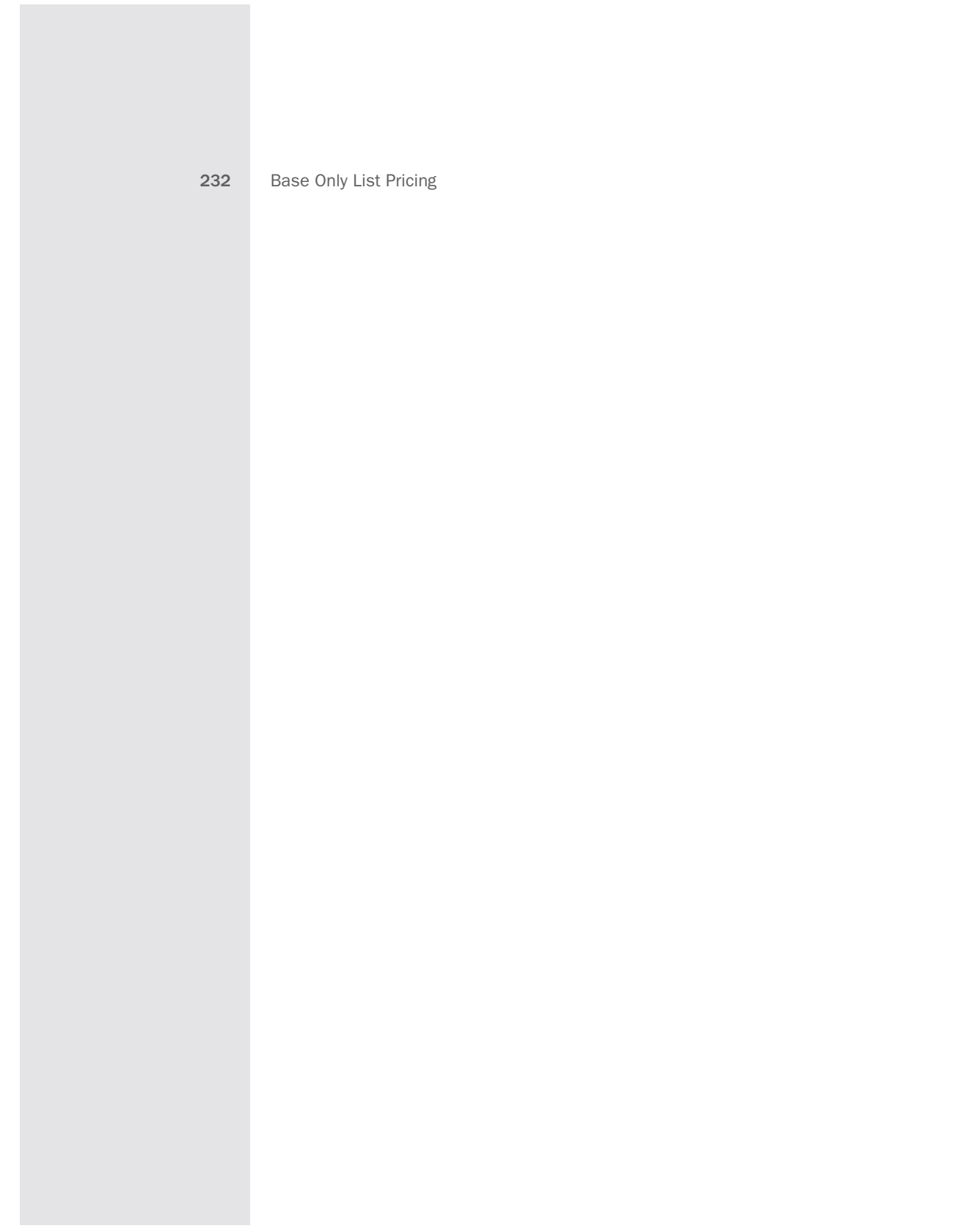

Base Only List Pricing

Base	Code	Base Model #	\$	Base Size	Base Style	Col. Dia.	Base Weight lbs.		
Alumilene	AL	AL2626X	360	26" x 26"	X	2.5"	20		
		AL3232X	450	32" x 32"	X	2.5"	22		
		AL3939X	655	39" x 39"	X	3"	30		
		AL26T	285	26"	T	2.5"	22		
Basic Round	BA	BA17L	145	17" dia.	Round	3"	35		
		BA17M	175	17" dia.	Round	3"	45		
		BA17H	205	17" dia.	Round	3"	55		
		BA20L	190	20" dia.	Round	3"	45		
		BA20M	205	20" dia.	Round	3"	55		
		BA20H	225	20" dia.	Round	3"	65		
		BA22L	200	22" dia.	Round	3"	55		
		BA22M	235	22" dia.	Round	3"	65		
		BA22H	270	22" dia.	Round	3"	75		
		BA28H	400	28" dia.	Round	3.5"	95		
		Boltdown	Beehive Base BB	BB	220	3" dia.	Boltdown	3"	10
				Trumpet Base TB	TB	220	3" dia.	Boltdown	3"
J Base JB	JB			220	3" dia.	Boltdown	3"	10	
Grout-in Base GB	GB			220	3" dia.	Grout-In	3"	10	
Florentine Base FB	FB			350	3" dia.	Boltdown	3"	15	
Capri	CA			CA15	317	15" dia	Florentine	N/A	35
Corsica	CR	CR15	483	15" dia	Florentine	N/A	46		
		CR24	628	24" dia	Florentine	N/A	80		
Cozy Bar	CB	CB17	490	17" dia	Round	3"	45		
		CB20	550	20" dia	Round	3"	55		
		CB22	645	22" dia	Round	3"	65		
Disc	DI	DI18	435	18" dia	Round	2"	38		
		DI22	595	22" dia	Round	2"	62		
		DI26	720	26" dia	Round	3"	77		
Dunhill	DU	DU1818X	470	18" x 18"	X	2.25"	18		
		DU2424X	538	24" x 24"	X	2.25"	25		
		DU3030X	604	30" x 30"	X	2.5	34		
		DU3636X	670	36" x 36"	X	3"	42		
		DU3636XH	734	36" x 36"	XH	3"	50		
		DU18T	276	18"	T	2"	30		
		DU24T	308	24"	T	2.25"	34		
		DU30T	340	30"	T	2.25"	40		
		DU30TT	396	30"	TT	2.25"	44		
		DU36TT	428	36"	TT	2.25"	62		
Flat Round	FR	FR18	370	18" dia.	Round	3"	46		

Continued on next page

*Polished/Satin Aluminum only available on Alumilene and Mark IV series

**Custom Powder Coat upcharge applied per order

Base Only Finish Upcharges

\$	Black Wrinkle	Powder Coat	Satin/Polished Chrome/Alu.*	Premium Plated	Custom Powder Coat**
-	standard	152	N/A	363	
-	standard	152	N/A	363	
-	standard	152	N/A	363	
-	standard	75	N/A	182	
standard	110	194	☉	363	
standard	110	194	☉	363	
standard	110	194	☉	363	
standard	110	194	☉	363	
standard	110	194	☉	363	
standard	110	194	☉	363	
standard	110	194	☉	363	
-	standard	59	☉	363	
-	standard	59	☉	363	
-	standard	59	☉	363	
-	standard	59	☉	363	
-	standard	N/A	N/A	363	
-	standard	N/A	N/A	363	
-	standard	N/A	N/A	363	
-	standard	N/A	N/A	363	
standard	152	273	☉	363	
standard	152	273	☉	363	
standard	152	273	☉	363	
-	standard	213	☉	363	
-	standard	213	☉	363	
-	standard	213	☉	363	
-	standard	213	☉	363	
-	standard	213	☉	363	
-	standard	213	☉	363	
-	standard	213	☉	363	
-	standard	213	☉	363	
-	standard	106	☉	182	
-	standard	106	☉	182	
-	standard	106	☉	182	
-	standard	106	☉	182	
-	standard	106	☉	182	
-	standard	194	☉	363	

Base Options

Alternate Height		
Alternate Height Base (per column)	AH	\$66
Alternate Height Florentine Base (per column)	AH	\$166
Slides		
Super Level	GSL	\$34
Powder Coated Puck (per table)	GPUPC	\$138
(Dunhill only - standard on Presidio)		
Polished or Satin Chrome Puck (per table)	GPUPL	\$166
(Dunhill only - standard on Presidio)		
Casters		
Locking Casters 2" Twin Wheel (qty. 4)	TWC2	\$56
(Dunhill, Mark IV, Slimline, Tuscan)		
Top Plate		
Custom Top Plate Size	CTPS	☉
6" Column (Basic Round, Disc or Flat Round)		
6" Column (black wrinkle and powder coat)	COL6	\$194
6" Column (polished or satin chrome)	COLP6	\$248
6" Column (premium plated)	COLPP6	☉
6" Column (venerer)	COLV6	\$386
Footring (Basic Round, Flat Round, Boltdown Series and Disc Only)		
Footring 14" (per base)	F014	\$220
Footring 19" (per base)	F019	\$248
Footring Finish: Polished or Satin Chrome only		
Outdoor Use		
Outdoor Undercoat (includes GSL)	PCO	\$56
(not available for Presidio)		
Tilt/Fold		
Tilt-top - (standard cable release)	TMX/TMT	\$270 X-base / \$418 T-base
For use on table bases with up to a 2.5" column diameter.		
The cable release mechanism activates both mechanisms on a table with two single column T-bases. It is not available on TT bases.		
Folding		
Folding table mechanism must be activated individually. The folding mechanism is available on Dunhill, Mark IV, Slimline and Tuscan T-bases only. It is not available on TT bases.	FM	\$270 T-base

Base Only List Pricing

Base	Code	Base Model #	\$	Base Size	Base Style	Col. Dia.	Base Weight lbs.
		FR22	490	22" dia.	Round	3.5"	70
		FR26	590	26" dia.	Round	3.5"	84
Knobhill	KN	KN18L	440	18" dia.	Round	2"	35
		KN18M	470	18" dia.	Round	2"	45
		KN18H	500	18" dia.	Round	2"	55
		KN24M	530	24" dia.	Round	2.25"	55
		KN24H	560	24" dia.	Round	2.25"	65
		KN24XH	600	24" dia.	Round	2.25"	75
Manhattan	MH	MH20	250	20" dia.	Round	3"	35
		MH24	300	24" dia.	Round	3.5"	45
		MH30	400	30" dia.	Round	4"	60
Mark IV	MA	MA2424X	340	24" x 24"	X	2"	10
		MA3030X	440	30" x 30"	X	2"	18
		MA3636X	540	36" x 36"	X	3"	24
		MA27V	320	27"	V	2"	26
		MA18T	265	18"	T	2"	20
		MA30T	365	30"	T	2"	28
Medici	ME	ME18	300	18" dia.	Florentine	N/A	30
Platform	PL	PL18	435	18" square	Sq.	2" Square	46
		PL22	595	22" square	Sq.	2" Square	65
		PL26	720	26" square	Sq.	3" Square	97
		PL1826	788	18" x 26"	Rectangle	2" Square	75
Post Leg	PO	P01.5	145	1.5" dia.	Post	1.5"	4
		P02.5	155	2.5" dia.	Post	2.5"	6
		P03	165	3" dia.	Post	3"	7
Presidio	PR	PR1818X	925	18" x 18"	X	2.25"	25
		PR2424X	985	24" x 24"	X	2.25"	35
		PR3030X	1035	30" x 30"	X	2.25"	45
		PR3636X	1200	36" x 36"	X	3"	55
		PR18T	500	18"	T	2.25"	13
		PR24T	550	24"	T	2.25"	17
		PR30T	600	30"	T	2.25"	20
		PR30TT	650	30"	TT	2.25"	22
		PR36TT	735	36"	TT	2.25"	31
		Regency	RG	RG2424X	860	24" x 24"	X -bar size 1/2"
RG3030X	930			30" x 30"	X -bar size 1/2"	2.5"	22
RG3636X	1980			36" x 36"	X -bar size 1"	3.5"	60
RG4848X	2500			48" x 48"	X -bar size 1"	3.5"	86
RG2142S	2600			21" x 42"	Scissor -bar size 1"	3.5"	84
RG2448S	2700			24" x 48"	Scissor -bar size 1"	3.5"	85
Scala	SC	SC19.5	600.6	19.5" dia	Florentine	N/A	74

Continued on next page

*Polished/Satin Aluminum only available on Alumiline and Mark IV series

**Custom Powder Coat upcharge applied per order

Base Only Finish Upcharges

\$	Black Wrinkle	Powder Coat	Satin/Polished Chrome/Alu.*	Premium Plated	Custom Powder Coat**
-	standard	194	☑	363	
-	standard	194	☑	363	
-	standard	194	☑	363	
-	standard	194	☑	363	
-	standard	194	☑	363	
-	standard	194	☑	363	
-	standard	194	☑	363	
-	standard	N/A	N/A	363	
-	standard	N/A	N/A	363	
-	standard	N/A	N/A	363	
-	standard	152	N/A	363	
-	standard	152	N/A	363	
-	standard	152	N/A	363	
-	standard	75	N/A	182	
-	standard	75	N/A	182	
-	standard	75	N/A	182	
-	standard	N/A	N/A	363	
-	standard	213	☑	363	
-	standard	213	☑	363	
-	standard	213	☑	363	
-	standard	213	☑	363	
-	standard	62	☑	363	
-	standard	62	☑	363	
-	standard	62	☑	363	
-	standard	213	☑	363	
-	standard	213	☑	363	
-	standard	213	☑	363	
-	standard	213	☑	363	
-	standard	106	☑	182	
-	standard	106	☑	182	
-	standard	106	☑	182	
-	standard	106	☑	182	
-	standard	106	☑	182	
-	standard	106	☑	182	
-	standard	363	☑	363	
-	standard	363	☑	363	
-	standard	363	☑	363	
-	standard	363	☑	363	
-	standard	363	☑	363	
-	standard	363	☑	363	
-	standard	N/A	N/A	363	

Base Options

Alternate Height		
Alternate Height Base (per column)	AH	\$66
Alternate Height Florentine Base (per column)	AH	\$166
Glides		
Super Level	GSL	\$34
Powder Coated Puck (per table)	GPUPC	\$138
(Dunhill only - standard on Presidio)		
Polished or Satin Chrome Puck (per table)	GPUPL	\$166
(Dunhill only - standard on Presidio)		
Castors		
Locking Casters 2" Twin Wheel (qty. 4)	TWC2	\$56
(Dunhill, Mark IV, Slimline, Tuscan)		
Top Plate		
Custom Top Plate Size	CTPS	☑
6" Column (Basic Round, Disc or Flat Round)		
6" Column (black wrinkle and powder coat)	COL6	\$194
6" Column (polished or satin chrome)	COLP6	\$248
6" Column (premium plated)	COLPP6	☑
6" Column (venerer)	COLV6	\$386
Footring (Basic Round, Flat Round, Bolt-down Series and Disc Only)		
Footring 14" (per base)	F014	\$220
Footring 19" (per base)	F019	\$248
Footring Finish: Polished or Satin Chrome only		
Outdoor Use		
Outdoor Undercoat (includes GSL)	PCO	\$56
(not available for Presidio)		
Tilt/Fold		
Tilt-top - (standard cable release)	TMX/TMT	\$270 X-base / \$418 T-base
For use on table bases with up to a 2.5" column diameter.		
The cable release mechanism activates both mechanisms on a table with two single column T-bases. It is not available on TT bases.		
Folding		
Folding table mechanism must be activated individually. The folding mechanism is available on Dunhill, Mark IV, Slimline and Tuscan T-bases only. It is not available on TT bases.	FM	\$270 T-base

Base Only List Pricing

Base	Code	Base Model #	\$	Base Size	Base Style	Col. Dia.	Base Weight lbs.
Siena	SI	SI25	466.2	25" dia.	Florentine	N/A	63
Slimline	SL	SL1818X	330	18" x 18"	X	1.75"	14
		SL2424X	385	24" x 24"	X	1.75"	15
		SL3030X	440	30" x 30"	X	1.75"	16
		SL3636X	525	36" x 36"	X	3.5"	21
		SL18T	225	18"	T	1.75"	23
		SL24T	240	24"	T	1.75"	25
		SL30T	275	30"	T	1.75"	26
		SL30TT	335	30"	TT	1.75"	32
		SL36TT	370	36"	TT	1.75"	33
Spacesaver	SV	SV2222X	130	22" x 22"	X	3"	20
		SV3030X	150	30" x 30"	X	3"	24
		SV3636X	265	36" x 36"	X	3.5"	35
		SV2430EX	160	24" x 30"	EX	3"	25
		SV18T	90	18"	T	3"	22
		SV22T	105	22"	T	3"	24
Toscana	TO	TO24	420	24" dia.	Florentine	N/A	45
Tulip	TL	TL18L	600	18" dia.	Round	2"	35
		TL18M	655	18" dia.	Round	2"	45
		TL18H	725	18" dia.	Round	2"	55
		TL24M	765	24" dia.	Round	2.25"	55
		TL24H	880	24" dia.	Round	2.25"	65
		TL24XH	915	24" dia.	Round	2.25"	75
Tuscan	TU	TU1818X	325	18" x 18"	X	2"	17
		TU2424X	380	24" x 24"	X	2"	20
		TU3030X	450	30" x 30"	X	2"	23
		TU3636X	520	36" x 36"	X	3"	24
		TU18T	200	18"	T	2"	16
		TU24T	235	24"	T	2"	18
		TU30T	265	30"	T	2"	20
		TU30TT	325	30"	TT	2"	29
TU36TT	360	36"	TT	2"	32		

Continued on next page

*Polished/Satin Aluminum only available on Aluimline and Mark IV series

**Custom Powder Coat upcharge applied per order

Base Only Finish Upcharges

\$	Black Wrinkle	Powder Coat	Satin/Polished Chrome/Alu.*	Premium Plated	Custom Powder Coat**
-	-	standard	N/A	N/A	363
-	-	standard	114	☐	363
-	-	standard	114	☐	363
-	-	standard	114	☐	363
-	-	standard	114	☐	363
-	-	standard	57	☐	182
-	-	standard	57	☐	182
-	-	standard	57	☐	182
-	-	standard	57	☐	182
standard	-	110	N/A	N/A	363
standard	-	110	N/A	N/A	363
standard	-	110	N/A	N/A	363
standard	-	110	N/A	N/A	363
standard	-	55	N/A	N/A	182
standard	-	55	N/A	N/A	182
-	-	standard	N/A	N/A	363
-	-	standard	194	☐	363
-	-	standard	194	☐	363
-	-	standard	194	☐	363
-	-	standard	194	☐	363
-	-	standard	194	☐	363
-	-	standard	114	☐	363
-	-	standard	114	☐	363
-	-	standard	114	☐	363
-	-	standard	114	☐	363
-	-	standard	57	☐	182
-	-	standard	57	☐	182
-	-	standard	57	☐	182
-	-	standard	57	☐	182
-	-	standard	57	☐	182

Base Options

Alternate Height		
Alternate Height Base (per column)	AH	\$66
Alternate Height Florentine Base (per column)	AH	\$166
Glides		
Super Level	GSL	\$34
Powder Coated Puck (per table)	GPUPC	\$138
(Dunhill only - standard on Presidio)		
Polished or Satin Chrome Puck (per table)	GPUPL	\$166
(Dunhill only - standard on Presidio)		
Castors		
Locking Casters 2" Twin Wheel (qty. 4)	TWC2	\$56
(Dunhill, Mark IV, Slimline, Tuscan)		
Top Plate		
Custom Top Plate Size	CTPS	☐
6" Column (Basic Round, Disc or Flat Round)		
6" Column (black wrinkle and powder coat)	COL6	\$194
6" Column (polished or satin chrome)	COLP6	\$248
6" Column (premium plated)	COLPP6	☐
6" Column (veneer)	COLV6	\$386
Footring (Basic Round, Flat Round, Bolt-down Series and Disc Only)		
Footring 14" (per base)	F014	\$220
Footring 19" (per base)	F019	\$248
Footring Finish: Polished or Satin Chrome only		
Outdoor Use		
Outdoor Undercoat (includes GSL) (not available for Presidio)	PCO	\$56
Tilt/Fold		
Tilt-top - (standard cable release)	TMX/TMT	\$270 X-base / \$418 T-base
For use on table bases with up to a 2.5" column diameter.		
The cable release mechanism activates both mechanisms on a table with two single column T-bases. It is not available on TT bases.		
Folding		
Folding table mechanism must be activated individually. The folding mechanism is available on Dunhill, Mark IV, Slimline and Tuscan T-bases only. It is not available on TT bases.	FM	\$270 T-base

Top Only Pricing

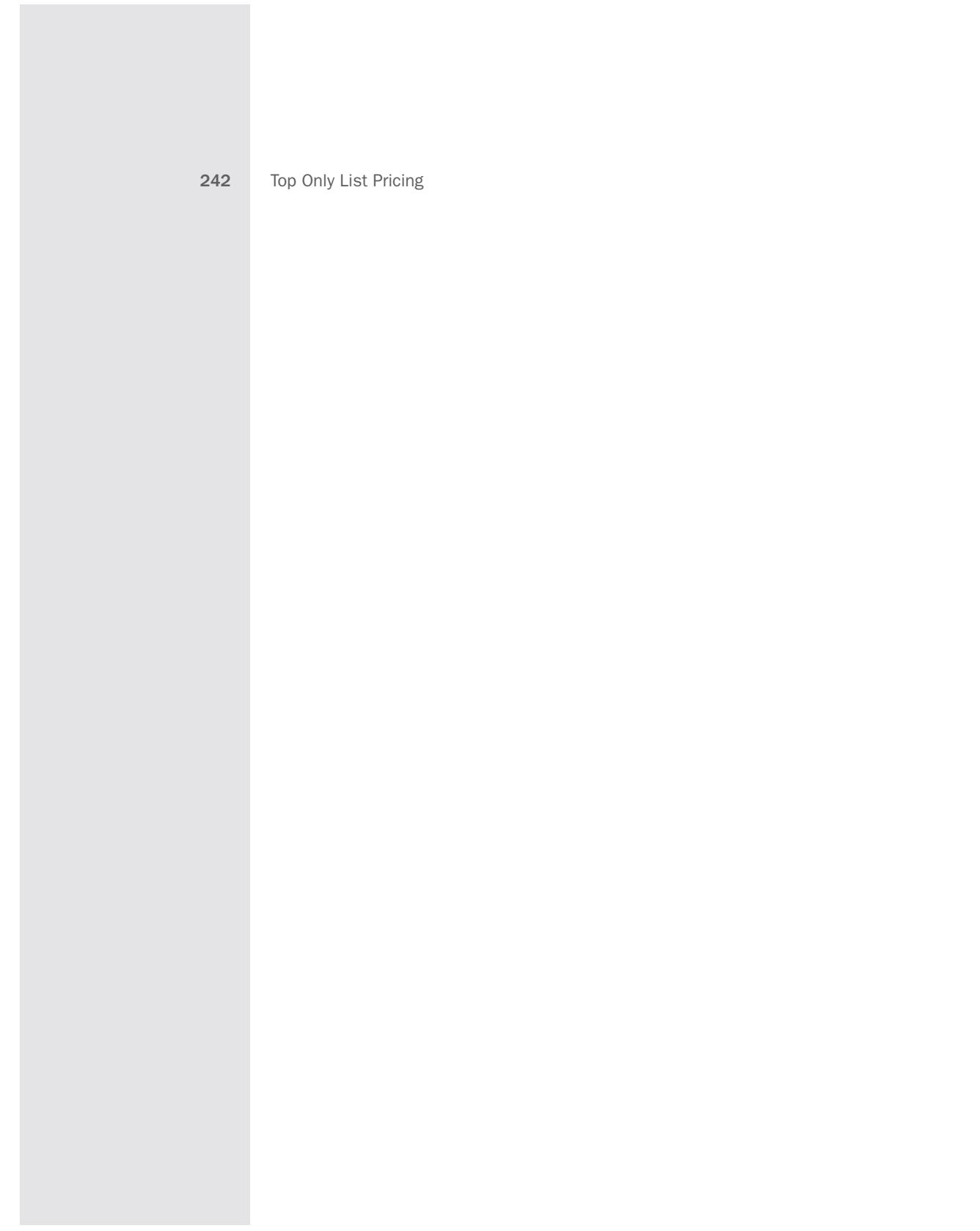

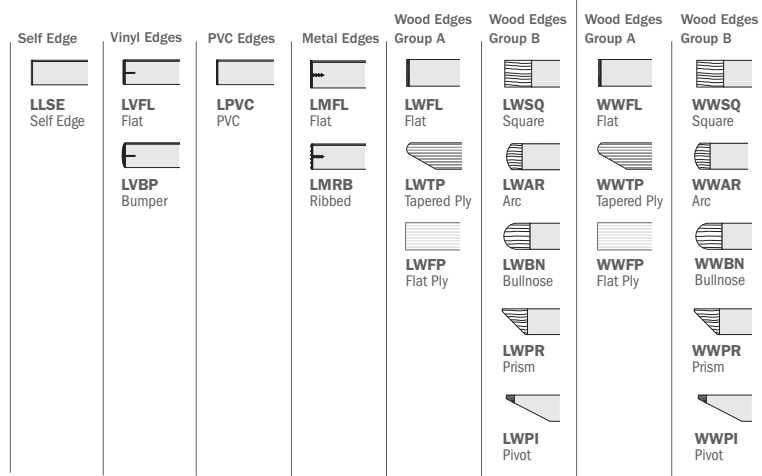

Laminate Tops Wood Veneer Tops

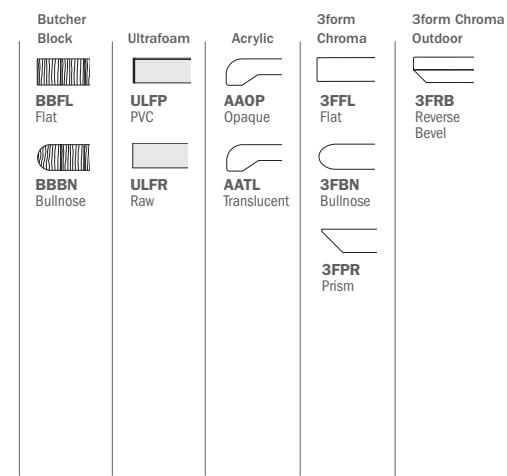

Specialty Tops



Top Only List Pricing

	Top Size	Dia.		Model #	\$							
 Extendo available in LLSE, LWFL, LWSQ, WWFL, WWSQ, ULFP, ULFR Only	30	30	42	3042EX	951	-	-	-	2,237	2,717	2,350	3,085
	34	34	48	3448EX	1,079	-	-	-	2,377	3,056	2,490	3,425
	36	36	51	4251EX	1,159	-	-	-	2,548	3,227	2,661	3,595
	42	42	60	4260EX	1,401	-	-	-	2,920	3,509	3,001	3,877
 Square	24	24		2424SQ	189	189	245	299	397	566	407	638
	30	30		3030SQ	249	249	317	364	510	691	510	778
	36	36		3636SQ	329	329	397	466	626	846	662	951
	42	42		4242SQ	418	418	494	543	752	1,010	846	1,136
	48	48		4848SQ	535	535	624	683	891	1,187	1,002	1,336
 Rectangle	18	48		1848RE	261	261	312	327	430	679	496	707
	18	60		1860RE	311	311	371	389	510	792	574	850
	18	72		1872RE	358	358	424	445	594	906	662	992
	18	84		1884RE	510	510	562	594	739	1,047	833	1,177
	18	96		1896RE	594	594	641	679	796	1,160	895	1,282
	24	30		2430RE	218	218	265	277	458	644	539	724
	24	36		2436RE	247	247	299	313	521	702	587	790
	24	42		2442RE	280	280	325	340	562	761	632	856
	24	48		2448RE	315	315	371	389	634	856	714	961
	24	60		2460RE	377	377	437	458	718	971	807	1,091
	24	72		2472RE	435	435	505	529	815	1,105	918	1,243
	24	84		2484RE	652	652	717	757	897	1,385	1,010	1,560
	24	96		2496RE	710	710	781	825	979	1,506	1,101	1,696
	30	36		3036RE	292	292	337	352	574	772	646	868
	30	42		3042RE	327	327	379	397	669	891	751	1,002
	30	48		3048RE	364	364	420	440	714	955	805	1,074
	30	60		3060RE	445	445	509	533	825	1,101	928	1,237
	30	72		3072RE	513	513	590	617	901	1,214	1,015	1,364
	30	84		3084RE	745	745	811	856	996	1,484	1,119	1,667
	30	96		3096RE	815	815	888	936	1,091	1,657	1,227	1,862
36	42		3642RE	375	375	434	453	724	969	817	1,089	
36	48		3648RE	415	415	477	498	778	1,039	875	1,167	
36	60		3660RE	510	510	583	607	883	1,179	994	1,327	

Continued on next page

Options

Top Materials and Finishes		
Standard Laminates	use manufacturers finish code	n/c
Premium Laminates	PRL	Ⓛ
Custom Wood Veneer	CWV	Ⓛ
Special Pattern Veneer	SPV	Ⓛ
Stain to Match (set-up charge)	STM	\$412
Top Options		
Custom Size	CS	Ⓛ
Custom Shape	CSH	Ⓛ
Custom Radius Corner	CRC	Ⓛ
3" Radius Corner (per corner)	CRL3	\$34
(laminates self edge, ultrafoam, Corian®)		
3" Wood Radius Corner (per corner)	CRW3	\$82
(not available in LWFL, WWFL, LWPI and WWPI)		
Edge Options		
1.75" Thick Edge (per table)	175E	15%
(see edge details for specific profiles)		

-	712	-	-	-
-	817	-	-	-
-	879	-	-	-
-	1,089	-	-	-
-	-	-	-	-
624	222	801	1,270	1,594
893	282	1,262	2,258	2,509
1,225	372	1,725	3,161	3,508
1,817	473	2,377	4,285	4,759
2,123	601	3,235	5,592	6,193
-	-	-	-	-
792	290	-	-	-
860	350	-	-	-
973	403	-	-	-
1,132	581	-	-	-
1,245	636	-	-	-
-	-	-	-	-
741	241	1,013	1,852	2,062
875	276	1,297	2,179	2,423
1,069	312	1,422	2,515	2,794
1,124	352	1,607	2,848	3,162
1,373	424	-	3,560	3,938
1,624	492	-	4,225	4,675
1,807	684	-	-	-
1,990	752	-	-	-
-	-	-	-	-
1,045	325	1,517	2,686	2,986
1,290	367	1,760	3,124	3,468
1,350	410	2,009	3,552	3,930
1,648	502	2,538	4,388	4,859
1,953	581	3,280	5,260	5,825
2,136	786	-	-	-
2,319	868	-	-	-
-	-	-	-	-
1,504	422	-	3,721	4,119
1,570	471	2,412	4,227	4,682
1,916	576	3,280	5,268	5,836

Laminate Tops				Wood Veneer Tops			
Self Edge	Vinyl Edges	PVC Edges	Metal Edges	Wood Edges Group A	Wood Edges Group B	Wood Edges Group A	Wood Edges Group B
LLSE Self Edge	LVFL Flat	LPVC PVC	LMFL Flat	LWFL Flat	LWSQ Square	WWFL Flat	WWSQ Square
	LVBP Bumper		LMRB Ribbed	LWTP Tapered Ply	LWAR Arc	WWTP Tapered Ply	WWAR Arc
				LWFP Flat Ply	LWBN Bullnose	WWFP Flat Ply	WWBN Bullnose
					LWPR Prism		WWPR Prism
				LWPI Pivot			WWPI Pivot

Butcher Block	Ultrafoam	Acrylic	3form Chroma	3form Chroma Outdoor
BBFL Flat	ULFP PVC	AAOP Opaque	3FFL Flat	3FRB Reverse Bevel
BBBN Bullnose	ULFR Raw	AATL Translucent	3FBN Bullnose	
			3FPR Prism	

Top Only List Pricing

	Top Size		Model #	\$							
Arc Rectangle 	48	96	4896AR	1,160	1,160	1,214	1,264	1,496	2,208	1,869	2,435
	48	120	48120AR	1,334	1,334	1,453	1,515	1,739	2,548	2,173	2,830
	48	144*	48144AR	1,574	1,574	1,696	1,770	2,056	2,916	2,568	3,342
	48	168*	48168AR	1,796	1,796	1,923	2,007	2,301	3,396	2,877	3,745
Boat Shape 	60	120	60120AR	1,597	1,597	1,742	1,819	1,982	2,858	2,402	3,204
	60	144*	60144AR	1,883	1,883	2,027	2,118	2,437	3,283	2,741	3,954
	60	168*	60168AR	2,159	2,159	2,305	2,410	2,725	3,680	3,064	4,344
	36	42	3672BS	1,011	1,011	976	1,023	1,257	1,681	1,416	1,893
	36	48	3684BS	1,126	1,126	1,191	1,247	1,552	1,947	1,747	2,194
	36	48	3696BS	1,245	1,245	1,309	1,366	1,718	2,065	1,934	2,323
	36	48	36120BS	1,482	1,482	1,559	1,630	2,101	2,334	2,365	2,626
	36	48	36144BS	1,741	1,741	1,830	1,916	2,577	2,817	2,898	3,169
36	48	36168BS	1,967	1,967	2,079	2,177	2,912	3,038	3,276	3,418	

*Three 30TT Bases required

Options

Top Materials and Finishes		
Standard Laminates	use manufacturers finish code	n/c
Premium Laminates	PRL	Ⓛ
Custom Wood Veneer	CWV	Ⓛ
Special Pattern Veneer	SPV	Ⓛ
Stain to Match (set-up charge)	STM	\$412
Top Options		
Custom Size	CS	Ⓛ
Custom Shape	CSH	Ⓛ
Custom Radius Corner	CRC	Ⓛ
3" Radius Corner (per corner)	CRL3	\$34
(laminates self edge, ultrafoam, Corian®)		
3" Wood Radius Corner (per corner)	CRW3	\$82
(not available in LWFL, WWFL, LWPI and WWPI)		
Edge Options		
1.75" Thick Edge (per table)	175E	15%
(see edge details for specific profiles)		

Base Options

AH Alternate Height Base **\$66**

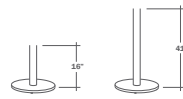

WCI table bases are available in a custom height within the range of 16" - 41" (per column). Alternate height Florentine bases are \$166.

GSL Super Level Glides **\$34**



Overall height of .75" is recommended for use on uneven or hard surface floors. Eliminates table wobble by automatically self-leveling. Adjusts up to .25" of wobble. Super level glides will not affect the overall height of the table. Super Level Glides are not available on Disc or Platform series. Sold in set of 5 (per base).

GPUPC & GPUPL Puck Style Glides **PC \$80**
PL \$80



Puck style glides are included on the Presidio base and can be specified on the Dunhill base. The Puck style glide is .375" thick with a 2.5" diameter and can be powder coated (GPUPC) or polished/satin chrome (GPUPL) (per each).

FFG Floor Fastener **\$34**



Cast iron, mounted inside post leg column with set screw; fastener to attach leg to floor is not included. Available for 2.5" and 3" diameter Post Leg columns only (per leg).

TWC2 Casters 2" Twin Wheel **\$56**



Twin wheel casters are 2" diameter black nylon with a black nylon hood and locking tab. Casters will not affect the overall height of the table. Casters are available on Dunhill, Mark IV, Post Leg, Slimline and Tuscan series. Sold in set of 4.

TMX/TMT Tilt-top with Standard Cable Release **X-base \$270**
T-base \$418

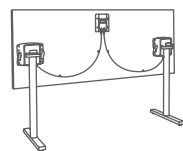

For use on table bases with up to a 2.5" column diameter. The cable release mechanism activates both mechanisms on a table with two single column T-bases. It is not available on TT bases or Post Leg.

FM Folding Mechanism **T-base \$270**

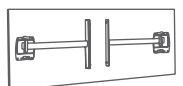

Folding table mechanism must be activated individually. The folding mechanism is available on Dunhill, Mark IV, Slimline and Tuscan T-bases only. It is not available on TT bases or Post Leg. For use on tables bases with up to a 2.5" column diameter.

Top Options

CS Custom Size/Shape **\$14**

WCI can manufacture many different size and shape tops; please call customer service 800-243-3150 for more information

CRC Custom Radius Corner **\$14**

WCI can manufacture specific custom radius corners; please call customer service 800-243-3150 for more information

CRL3 3" Radius Corner **\$34**

3" Radius corners are available on laminate tops with a self-edge, also available on Ultrafoam and Corian® tops. (per corner)

CRW3 3" Wood Radius Corner **\$82**

3" Radius corners are available on laminate tops with wood edges. Not available in LWFL, WWFL, LWPI, WWPI (per corner)

UMB 2" Umbrella Hole **\$248**

Available on Outdoor Basic Round, Bistro, Flat Round, Disc, Park and Platform tables only (per table).

Edge Options

175E 1.75" Thick Edge **15%**

The 1.75" thick edge is built-up on a 1.25" thick top. Available on a self edge laminate, square wood edge, flat wood edge, or a bullnose wood edge profile (per table).

Grommets

GMBK, GMSC & GMPC 2" Round Metal Grommet **\$138**



Matte black (GMBK), Satin chrome (GMSC)
Polished chrome (GMPC)

GPMBK 2" Round Plastic Grommet **\$44**



Matte black (GPMBK)

Modesty Panel

MODLFX & MODVFX Fixed Modesty Panel **LFX \$248**
VFX \$386



.75" thick x 9" high. Specify to match the width of the table. Laminate fixed modesty panel (MODLFX) has a black flat T-mold edge with 1" radius corners. Veneer fixed modesty panel (MODVFX) has a matching .125" thick flat wood edge with square corners.

MODLFL & MODVFL Folding Modesty Panel **LFL \$330**
VFL \$468



.75" thick x 9" high. Specify to match the width of the table. Laminate folding modesty panel (MODLFL) has a black flat T-mold edge with 1" radius corners. Veneer folding modesty panel (MODVFL) has a matching .125" thick flat wood edge with square corners. The folding bracket is 10 gauge steel with a matte black finish.

Ganging Clips

GC Ganging Clips **\$148**

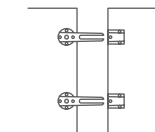

Connects two table tops for use as one large table. Friction and bolt release allows for quick separation. Set includes two clips and two brackets. One set is recommended per table side.

Wire Management

WMJ Black Plastic J-Trough 48" long **\$116**



Under table mounted J-trough provides concealed cable management. Matte black plastic, attachment hardware not included.

WML Legway Wire Manager 26" **\$56**



Vertical trough provides concealed cable management. Matte black plastic, attachment adhesive included.

Data and Power

DPBS2 Recessed Power and Data Module Two **\$396**



Recessed table top unit with 2 receptacles, 15amp circuit breaker, 3rd receptacle on the bottom, 1 cut-out for telecom plate (telecom plate not included); includes a 6' cord (DPBS). Available in matte black (MBK) or satin aluminum (MSA)

DPBS4 Recessed Power and Data Module Four **\$688**

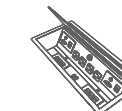

Recessed table top unit with 4 receptacles, 15amp circuit breaker, 4 cut-outs for telecom plates (telecom plates not included); includes a 6' cord (DPBS) Available in matte black (MBK) or satin aluminum (MSA)

DPAS2 Retractable Power and Data Module Two **\$606**



Retractable table top unit with a fluid, one touch door that remains open during use. Includes 2 receptacles and 2 data openings (data jack and couplers not included) (DPAS2). Available in satin aluminum (MSA)

DPAS3 Retractable Power and Data Module Three **\$688**



Retractable table top unit with a fluid, one touch door that remains open during use. Includes 3 receptacles and 3 data openings (data jack and couplers not included). (DPAS2) Available in satin aluminum (MSA)

DPUS2 Undermount Power and Data Module Two **\$358**

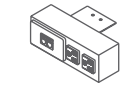

Under table mounted unit with 2 receptacles and 1 cut-out for telecom plate (telecom plate not included). includes 9' cord (DPUS2) Available in matte black (MBK)

Other

TTRK Table Truck for Folding Tables **\$1512**

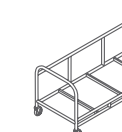
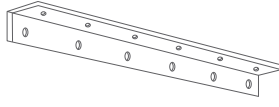
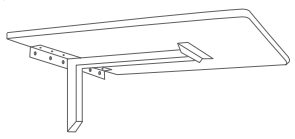
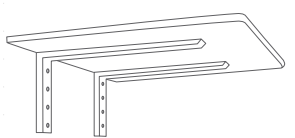

Table Truck for folding tables, 34" wide x 72" long holds 6 folding tables; shipped knocked down. Available powder coated in matte black (MBK) (TTRK)

Options

Hardware List Pricing

	Size	Maximum Top Size	Model #	\$
 <p>Wall Cleat</p>	20	36" wide	WC20	46
<p>Specifications: For use with table leg. Used to attach one end of table to wall. Cleat: .125" thick x 2" x 2" angle solid steel with mounting holes. Length: 20" Finish: Matte black Wall attachment hardware not included</p>				
 <p>Cantilever Table Bracket Single</p>	16	21 30" x 36"	CTBS21	172
	16	33 30" x 48"	CTBS33	214
<p>Specifications: Construction: 1.5" square steel tubing Cleat: .125" thick x 2" x 2" angle solid steel with mounting holes. Finish: Matte black Wall attachment hardware not included</p>				
 <p>Cantilever Table Bracket Double</p>	12	12 24" x 24"	CTBD12	162
	16	18 30" x 24"	CTBD18	190
	16	24 30" x 30"	CTBD24	218
	16	30 36" x 36"	CTBD30	246
	16	36 36" x 42"	CTBD36	276
	16	42 36" x 48"	CTBD42	304
<p>Specifications: Construction: 1.5" square steel tubing Cleat: .1875" thick x 1.5" x 3" structural steel channel with mounting holes. Finish: Matte black Wall attachment hardware not included</p>				