



Price List

Version 6: July 1, 2014



Company Statement

“Can you make ...?”

That’s how a lot of client phone calls to WCI begin. Designers and dealers know that we’re more than our catalog. We’re also the go-to collaborator for the custom designs other manufacturers are unable to handle.

For more than 75 years, we’ve been a creative and innovative partner to thousands of clients across the country and around the world. Whether it’s a café, bistro, conference room, corporate cafeteria, or that in-between space, our tables, banquettes, and seating are there for you. With all fabrication done at our Los Angeles factory our turnaround is perhaps the fastest in the industry.

WCI looks to the future inspired by its customer’s commitment to design, and is prepared to meet the ever-changing and rapidly expanding needs of the industries it serves.

Customers continually tell us, “You guys can do anything.” We think the customer is always right.

Take a look around our site at westcoastindustries.com, what you find might surprise you!

WCI

San Francisco, CA

800-243-3150

Table of Contents

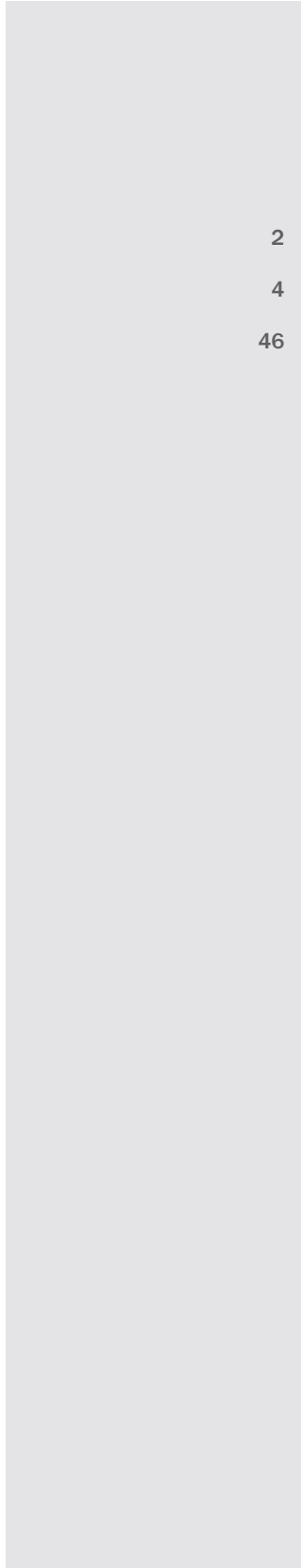

2	Statement of Line
4	General Information
46	Pricing

Statement of Line

Dining | Multipurpose



Alumiline
48



Basic Round
50



Bolt Down
52



Capri
54



Corsica
56



Cozy Bar
58



Disc
60



Dunhill
68



Flat Round
78



Knobhill
86



Manhattan
88



Mark IV
90



Medici
98



Move
100



Parsons
102



Platform
104



Post Leg
112



Presidio
120



Regency
130



Scala
134



Siena
136



Slimline
138



Spacesaver
148



Toscana
150



Tulip
152



Tuscan
160

Statement of Line

Occasional



Cube
172



Cylinder
174



Disc
176



Move
180



Parsons
182



Platform
186



Tulip
188

Outdoor Tables



Arc
194



Basic Round
196



Bistro
198



Disc
200



Flat Round
202



Mark IV
204



Park
206



Platform
208



Sam Table
210



Tulip
212

Outdoor Chairs



Breeze
216



Courtyard
216



Piazza
216



Picnic
216



Polly
216



Sam Chair
217

General Information

5	Terms and Conditions
7	Warranties
8	Guaranteed Freight Program
10	GSA
12	Care and Maintenance

General Information | Terms and Conditions

Prices

Possession of this price list does not in itself constitute authority to sell and/or purchase product herein. All prices are LIST prices. Prices are effective with current date printed on the cover and supersede all other price lists. All accepted orders are subject to prevailing prices at time of order. WCI reserves the right to change prices or specifications without prior notice. Prices do not include tax or installation. Additional charges may apply on special requests for inside delivery, "call before," etc.

Minimum Order

WCI's minimum order is \$1,500 LIST, and orders under this amount will be subject to a \$150 service charge.

New Accounts

Customers who have purchased more than \$5,000 LIST in the last 12 months are eligible to seek terms with WCI. To establish an open account, submit a bank reference and at least three current open account references. Send full credit information along with complete address and telephone numbers to: West Coast Industries, Inc., 750 Battery St, Suite 100, San Francisco, CA 94111. Allow approximately two weeks for processing.

Credit and Payment Terms

Initial orders under \$2500 LIST require full amount in advance. Otherwise, unless credit has been established with WCI, terms will be a 50% deposit with order and balance paid in full prior to shipment. Payment terms for all customers with approved credit limits are net 30 days. Banquette orders require a 50% deposit with the order and the balance must be paid in full from date of shipment or within previously established and agreed to terms. Invoices must be paid within these terms in order to maintain open account status. Payments should be made to our main office in San Francisco. Past due accounts (over 30 days) are subject to an interest rate of 1.5% per month (18% per year), or the maximum amount permitted under local law. The customer will be liable for any costs incurred in collection of past due amounts, including attorneys' fees, whether or not a suit is filed. Charging purchases to an open account constitutes acceptance of our stated terms. WCI reserves the right to change terms without prior notice.

Acknowledgement

All orders are manufactured and shipped according to the acknowledgement and its terms and conditions. It is the customer's responsibility to note any discrepancies on the acknowledgement and to notify WCI immediately. The printed acknowledgement constitutes the final agreement between the customer and WCI, thus superseding all previous communications regarding the order.

Changes or Cancellations

Any changes to or cancellation of an order must be submitted to WCI in writing. Acknowledged orders for special, non-standard, and custom products cannot be cancelled. Approved change request orders may be subject to a revised production schedule and additional material and labor charges. Approved cancellation requests will be subject to restocking, material, and labor charges.

General Information | Terms and Conditions

Orders

All orders must include WCI product model number, final material, and finish specifications for order entry.

Send your orders directly to:

Postal Service or Courier Service:

WCI
Attn: Order Entry
750 Battery St, Ste 100
San Francisco, CA 94111

Fax: 415-552-5368

Email: order@westcoastindustries.com

Duplicate orders that are received by mail (after being faxed or emailed) and not marked “confirmation” are the responsibility of the customer.

Designs and Specifications

All designs and specifications are subject to change without prior notice. Any item or material may be discontinued without prior notice. All weights and dimensions are approximate.

General Information | Warranties

Tables

All tables manufactured by WCI are warranted to the original purchaser covering normal usage for a period of twelve years from the date of the original invoice. WCI will replace or repair (at our discretion) without cost to our customers any item found to be defective as a result of defective materials or workmanship. We will not, however, repair any item which has been abused or subjected to any use other than that which was originally intended for our product. Any repairs by the customer must receive specific written authorization from WCI before being executed on location to receive proper reimbursement for associated costs. In no event shall liability under this warranty exceed the original purchase price.

Electrical items not manufactured by WCI are covered for a period of one year.

Wood Furniture is made of natural variable raw material. Differences in grain characteristics and color among wood species are naturally occurring variations and are not within the control of WCI nor considered defects included in this warranty.

Plastic laminates, Corian[®], 3Form, and acrylic are not warranted by WCI, but are warranted by the respective manufacturers under their specific warranty only.

Banquettes

WCI banquette frames are warranted to be free of defects in materials and workmanship covering normal usage to the original purchaser for a period of seven years from the date of the original invoice. WCI will replace or repair (at our discretion), without cost to our customers, any item found to be defective as a result of defective material or workmanship. This warranty does not apply to damage resulting from accident, misuse, abuse, alteration or negligence. Any repairs by the customer must receive specific written authorization from WCI before being executed on location to receive proper reimbursement for associated costs. WCI will not be liable for any additional charges sustained by the customer because of improper installation by others, usage or after market additions.

Plastic laminates and upholstery are not warranted by WCI, but are covered by laminate and textile manufacturers under their specific warranty only. Wood Furniture is made of natural variable raw material. Differences in grain characteristics and color among wood species are naturally occurring variations and are neither within the control of WCI, nor considered defects included in this warranty.

COM textiles and COL leathers are not warranted.

Outdoor

All outdoor products manufactured by WCI are warranted to the original purchaser covering normal usage for a period of one year from the date of the original invoice. WCI will replace or repair (at our discretion) without cost to our customers any item found to be defective as a result of defective material or workmanship. We will not, however, repair any item which has been abused or subjected to any use other than that which was originally intended for our product. Any repairs by the customer must receive specific written authorization from WCI before being executed on location to receive proper reimbursement for associated costs. In no event shall liability under this warranty exceed the original purchase price.

General Information | Guaranteed Freight Program

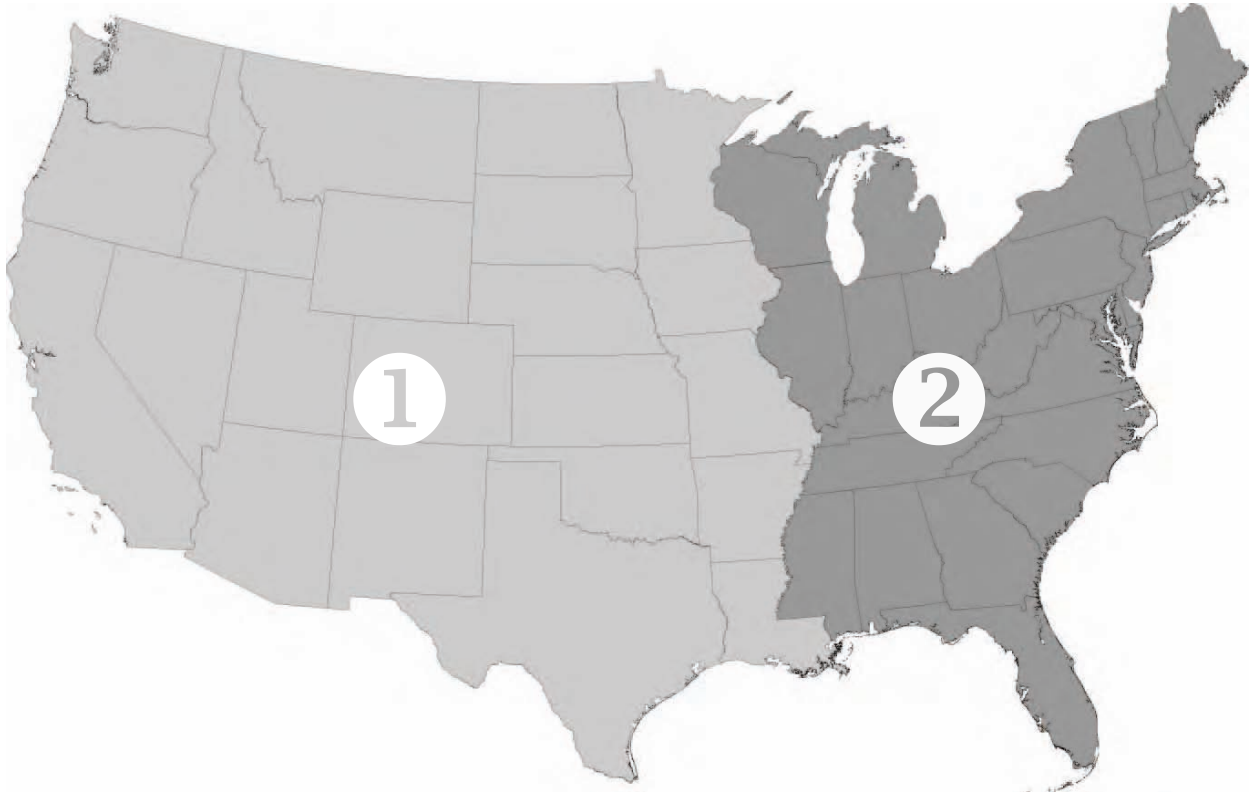

Zone 1: Add 5%

Arizona, Arkansas, California, Colorado, Hawaii, Idaho, Iowa, Kansas, Louisiana, Minnesota, Missouri, Montana, Nebraska, Nevada, New Mexico, North Dakota, Oklahoma, Oregon, South Dakota, Texas, Utah, Washington, and Wyoming.

Zone 2: Add 10%

Alabama, Connecticut, Delaware, Florida, Georgia, Illinois, Indiana, Kentucky, Maine, Maryland, Massachusetts, Michigan, Mississippi, New Hampshire, New Jersey, New York, North Carolina, Ohio, Pennsylvania, Rhode Island, South Carolina, Tennessee, Vermont, Virginia, West Virginia, and Wisconsin.

Tables and Outdoor

Tables and outdoor orders will be shipped F.O.B. factory. To calculate your guaranteed freight cost, refer to the map and zone matrix above. Zone percentage is calculated based on the total NET value of the order, and freight cost is included on invoices. WCI reserves the absolute right to determine the method of shipping unless special delivery instructions have been previously approved. Products shipped to Alaska, Hawaii, and Canada are F.O.B. factory, freight prepaid to port of embarkation, based on percentages as outlined above. Customer is responsible for freight charges from port of embarkation to final destination.

Banquettes

WCI Banquettes do not include freight. Banquettes are shipped F.O.B. factory, uncartoned for blanket wrap shipment. WCI will negotiate discounted freight rates on the customer's behalf, and will include those rates on the invoice.

General Information | Guaranteed Freight Program

Freight Claims

WCI will file freight claims for WCI tables and outdoor products only. In the event of damage and/or shortages, immediately call WCI at **800-243-3150** to initiate a freight claim and replacement or repair. Concealed damage must be reported in writing to the freight carrier and WCI within two business days. Failure to make a claim against WCI within five days will constitute acceptance of merchandise and waiver of any defects, shortages, or errors found upon inspection. The customer must file all freight claims for banquettes.

Normal Delivery

Normal delivery is on a dock to dock basis. Special requests, such as inside delivery, “call before,” etc, should appear on the customer’s purchase order and are subject to additional charges. Every attempt will be made by WCI to accommodate customers’ requests. Delivery date is subject to strikes, accidents, availability of supplies, and any other causes beyond our control. WCI may stop and/or hold shipment if payment terms, account status, or credit are not satisfactory.

Will Call

Customers may choose to pick up orders at our factory. Customers will be notified when their order is ready for orders marked “will call.” Pick up must be made within five business days or order will incur storage charges. Customer pick up is available between 8 AM and 2 PM PST. Please call WCI customer service at 800-243-3150 to schedule a customer pick-up.

Storage

Commencing on the ship date, there is a five business day grace period for all table and outdoor orders, during which there will be no storage fees. Following the grace period, there is a minimum storage charge of \$350 per month. Orders over \$10,000 will incur an additional 1.5% fee per month based on NET value of the order. In addition, a Storage Fee Agreement must be signed by customer and returned to customer service. Customers that are CBD (cash before delivery) must pay for all storage fees before the order is shipped.



General Services Administration

Federal Supply Service Authorized Federal Supply Schedule Price List

On-line access to contract ordering information, terms and conditions, up-to-date pricing, and the option to create an electronic delivery order are available through GSA Advantage!, a menu-driven database system. The internet address for GSA Advantage! is: www.gsadvantage.com

FSC Group 71 Office Furniture	DUNS #: 05-034-8689
CONTRACT #: GS-28F-0023R	Cage Code #: 35FR2
CONTRACT PERIOD: May 3, 2010 through May 2, 2015	Tax ID: 94-1383497
SIN 711-11 Tables and accessories	Business Size: SMALL
SIN 711-12 System type tables and accessories*	

CONTRACTOR:

West Coast Industries, Inc.
 750 Battery Street Suite 100
 San Francisco, CA 94111
 Phone: (415) 621-6656
 Fax: (415) 552-5368
www.westcoastindustries.com

CONTRACT ADMINISTRATION:

West Coast Industries, Inc.
 750 Battery Street Suite 100
 San Francisco, CA 94111
 Phone: (415) 621-6656
 Fax: (415) 552-5368
 Email: gsa@westcoastindustries.com

Information for Ordering Activities

1a. Awarded SIN(s):

- 711-11 Tables and Accessories
- 711-12 System type tables and accessories*

1b. Identification of the lowest priced model number and lowest unit price for that model for each special item number awarded in contract.

- 2.** Maximum Order: \$200,000
- 3.** Minimum Order: \$100
- 4.** Geographic Coverage: 48 Contiguous United States
- 5.** Point(s) of Production: Los Angeles, CA 90021
- 6.** For single delivery orders, the GSA discount from list price as shown in this commercial price list will apply.
- 7.** Quantity Discounts: None Offered
- 8.** Prompt Payment Terms: Net 30 Days
- 9a&b.** Government credit cards NOT accepted
- 10.** Foreign Items: NOT APPLICABLE
- 11a.** Time of Delivery: 45 Days ARO

*Products under SIN 711-12 consist of items set aside exclusively for small businesses.



- 11b.** Expedited Delivery: Products are available for expedited delivery. Expedited delivery time is negotiated between Contractor and Ordering Agency.
- 11c.** Overnight and 2-day Delivery: Products are available for expedited delivery. Expedited delivery time is negotiated between Contractor and Ordering Agency.
- 11d.** Urgent Requirements: Products are available for expedited delivery. Expedited delivery time is negotiated between Contractor and Ordering Agency.
- 12.** F.O.B. Point(s): F.O.B. Factory, freight prepaid and added to invoice for deliveries within the 48 contiguous United States.
- 13a.** Ordering Address: West Coast Industries, Inc., 750 Battery Street, Suite 100, San Francisco, CA 94111
- 13b.** Ordering Procedures: For supplies and services, the ordering procedures, information on Blanket Purchase Agreements (BPA's), and sample BPA's can be found at the GSA/FSS Schedule homepage (fss.gsa.gov/schedules).
- 14.** Payment Address: West Coast Industries, Inc., 750 Battery Street, Suite 100, San Francisco, CA 94111
- 15.** Warranty Provision: All WCI products are warranted to the original purchaser covering normal usage for a period of one year from the date of original invoice.
- 16.** Export Packing Charges: To be negotiated between Contractor and Ordering Agency.
- 17.** Terms and Conditions of Government Purchase Card Acceptance (any thresholds above the micro-purchase level): SAME
- 18.** Terms and Conditions of Rental, Maintenance, and Repair: No merchandise will be accepted for return, repair or credit without the written approval from West Coast Industries' main office. Approved returns must be shipped with all freight charges prepaid. West Coast Industries does not accept collect freight shipments or shipments of returned merchandise where freight damage has occurred. Approved returns will be subject to a 20% restocking charge.
- 19.** Terms and Conditions of Installation: NOT APPLICABLE
- 20a.** Terms and Conditions of repair parts indicating date of parts price lists and any discounts from list prices: NOT APPLICABLE
- 20b.** Terms and Conditions for Any Other Services: NOT APPLICABLE
- 21.** List of Service and Distribution Points: NOT APPLICABLE
- 22.** List of Participating Dealers: Contact West Coast Industries
- 23.** Preventative Maintenance: NOT APPLICABLE
- 24.** Special Attributes Such as Environmental Attributes (e.g., recycled content, energy efficiency, and/or reduced pollutants): NOT APPLICABLE
- 25.** DUNS #: 05-034-8689
Cage Code: 35FR2
Fed ID: 94-1383497
- 26.** Active registration on the System for Award Management (SAM) database

General Information | Care and Maintenance

Table Tops

Plastic Laminate and Ultrafoam Table Tops

Laminate topped tables should be cleaned with a mild, non-abrasive cleaner and cloth.

Wood Veneer and Butcher Block Table Tops

Wood must be treated as a breathing, living material. Like all organisms, it is subject to changes depending upon the environment in which it exists. The principal concern is the humidity in the surrounding atmosphere and its effect on the wood. Like many other materials, wood shrinks when it loses moisture and it swells when it absorbs it.

Keeping WCI wood finishes looking beautiful is easy. Simply wipe the table top clean with a soft damp cloth moistened with water, and then dry with a soft cloth.

Note: Do not use commercial cleaners, abrasives, solvents, Windex, 409, Ajax, etc. on the table top as this will wear away the acrylic waterborne enamel.

Spills should be wiped up promptly and wiped dry as described above. Spills should never be left on the finish overnight.

WCI wood finishes should be protected from excessive heat. A heat pad, coaster or trivet should be used to protect the table top from pots, pans, hot serving dishes, drinks, plates, etc.

3form® Chroma® Table Tops

Please follow this link: http://www.3-form.com/downloads/3form_matspec_chroma_rev030.pdf

Acrylic Table Tops

Acrylic table tops consist of specially formulated acrylic, providing a tough nonporous surface material with superior stain and UV light resistance. Color and material is consistent throughout the top, providing a renewable surface. Most dirt and residue can be removed by washing with warm soapy water, followed by rinsing with clean water and wiping down with a dry towel to eliminate water spots. Disinfecting acrylic table tops can be accomplished using (1) part household bleach mixed with (1) part water. Wash and rinse thoroughly, and wipe dry.

Minor scratches and burns on matte finish can be buffed out with a medium ScotchBrite pad, followed by wiping the area down with soapy water and towel dry. Minor scratches and burns on gloss finish can be buffed out with a white ScotchBrite pad, or wet sanded with 2000 grit sandpaper, followed by wiping area with soapy water and towel dry. Deep scratches and burns should be repaired by a professional fabricator.

Acrylic table tops have excellent heat resistant qualities; however, it is important, as with all table top materials, to minimize direct exposure to heat. WCI recommends using hot pads or trivets when placing hot objects on any acrylic table top.

Caution: Nail polish, nail polish remover, and any acetone based liquid will permanently stain and/or damage the acrylic table top. Chemicals such as paint remover, metal cleaner, oven cleaner, abrasive cleaner, and acid drain cleaner will also damage acrylic table tops and should not be used.

Corian® Table Tops

Please see: http://www2.dupont.com/Surfaces_Commercial/en_US/tech_info/care_and_maintenance/Corian.html

Table Bases

Powder Coat and Plated Bases

All powder coat and plated bases should be cleaned with a mild, non-abrasive cleaner and cloth. Users are urged to make periodic inspections to look for damage, loose screws and bolts, or other signs of structural fatigue incurred in daily handling, use, and abuse. Examination must include structural joints, corner blocks, welds, and any other stress points. Any product found to be damaged, defective or loose should be taken out of service immediately.

Metal Tables

All metal tables are suitable for indoor and outdoor applications. They have been pretreated and powder coat finished to resist the elements all year long without fading, rusting, or cracking.

For regular cleaning of the metal frames, use a solution of mild, non-abrasive soap and warm water. For more difficult stains, use a mild household cleaner. Avoid using abrasives and chemical cleaners. Always test a small area prior to cleaning. Do not pressure wash.

Chairs

Metal

All metal chairs are suitable for indoor and outdoor applications. They have been pretreated and powder coat finished to resist the elements all year long without fading, rusting or cracking.

For regular cleaning of the metal frames, use a solution of mild, non-abrasive soap and warm water. For more difficult stains, use a mild household cleaner. Avoid using abrasives and chemical cleaners. Always test a small area prior to cleaning. Do not pressure wash.

Polypropylene

Injection molded polypropylene chairs are suitable for indoor and outdoor applications. UV inhibitors in the polypropylene protect against sun rays.

To maintain the finish of polypropylene chairs, clean regularly with warm sudsy water – never use abrasive cleaners or boiling water.

For regular cleaning of the chair's metal frames, use a solution of mild, non-abrasive soap and warm water. For more difficult stains, use a mild household cleaner. Do not use abrasives and chemical cleaners. Always test a small area prior to cleaning. Do not pressure wash.

Synthetic Rattan

The Piazza chairs have woven synthetic rattan backs and seats. To maintain the rattan, clean regularly with warm sudsy water – never use abrasive cleaner or boiling water. Do not pressure-wash or use petroleum based solvents or cleaners as this will damage the synthetic rattan.

General Maintenance

Our customers are urged to make periodic inspections to look for damage, loose screws and bolts or other signs of structural fatigue incurred in daily use. Examination must include structural joints, corner blocks, welds and any other stress points. Any product found to be damaged, defective or loose should be taken out of service immediately.

Product Specifications



- 15 How to Order a Table
- 16 Material and Finish Codes
- 19 Bases
- 22 Occasional Bases and Tables
- 23 Outdoor Bases and Tables
- 24 Outdoor Chairs
- 25 Tops
- 27 Edge Profiles
- 30 Laminate Reference Guide
- 32 Corian® Reference Guide
- 33 Wood Grain and Patterns
- 34 Grommet Locations
- 35 ADA Tables
- 36 Banquettes

Product Specifications | How to Order a Table

DI36RDWWFLMBK

This model number represents a table with a Disc series matte black powder coat base, a 36" round 1.25" thick wood veneer top with a .125" flat wood edge profile.

WNM WNM

The top material and finish options specify a wood veneer natural maple top with a wood veneer natural maple edge.

42AH

The table options specify an alternate height base with a 42" overall table height.

Table Model Number

Select your table model number which includes the base series and style, top size, top shape, top material and edge profile style and base finish.

Base Series and Style Code (DI)

Disc base

Top Size Code (36)

36" diameter top

Table Shape Code (RD)

Round top

Top Material & Edge Profile Code (WWFL)

Wood veneer top with flat wood edge

Base Finish Code (MBK)

Matte black powder coat

DI36RDWWFLMBK

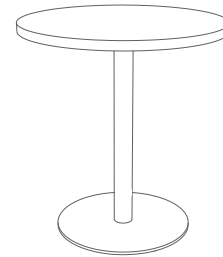

Top Finish Selection

Specify your materials and finishes for the table top, and table top edge.

Top Finish Code (WNM)

Wood natural maple

Edge Finish Code (WNN)

Wood natural maple

WNN WNM

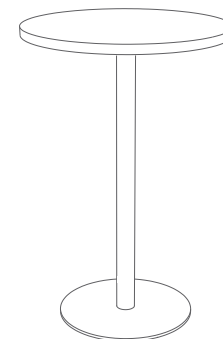

Options

Specify your options

Alternate Height (42AH)

Alternate height base (with a 42" overall table height)

42AH

Product Specifications | Material and Finish Codes

Base Finishes

Powder Coat

Solid Colors

MWH	White
MLG	Light Gray
MMG	Medium Gray
MDG	Dark Gray
MBK	Matte Black

Metallics

MSL	Silver
MGR	Graphite
MCH	Champagne
MDT	Dark Tone

Textures

MST	Stucco
MIG	Iron Glimmer
MWR	Black Wrinkle
MRB	Rubbed Bronze
MAN	Anthracite

Aluminum

MAA	Anodized Aluminum
MPA	Polished Aluminum
MSA	Satin Aluminum

Plated

Standard Plated

MPC	Polished Chrome
MSC	Satin Chrome

Premium Plated

MPB	Polished Brass
MSB	Satin Brass
MAB	Antique Brass
MPO	Polished Copper
MSO	Satin Copper
MSZ	Statuary Bronze

Hot Rolled Steel

MHS	Hot Rolled Steel with Clear Coat (move table only)
------------	---

Custom

CPC	Custom Powder Coat
------------	--------------------

Surface Materials

Laminate See WCI Laminate Reference Guide, Page 30

Wood

Maple

WNM	Natural Maple
WHM	Honey Maple
WEM	Ebony Maple

Oak

WNO	Natural Oak
WMO	Medium Oak
WEO	Ebony Oak

Cherry

WNC	Natural Cherry
WMC	Medium Cherry
WEC	Ebony Cherry
WMA	Mahogany over Cherry

Walnut

WNW	Natural Walnut
WMW	Medium Walnut
WDW	Dark Walnut

Maple Butcher Block

BNM	Natural Maple
BEM	Ebony Maple
BNC	Natural Cherry Over Maple
BMA	Mahogany Over Maple

Ultrafoam

ULFP	Flat White PVC Edge
ULFR	Unfinished Edge

Acrylic

Opaque

AWQ	White Quartz
ABQ	Black Quarry
AMD	Moon Dust
AKH	Khaki
AGD	Gold Dust
AGV	Gravel

Translucent

AGL	Glacier
ATR	Terrain
AGY	Golden Ray

Product Specifications | Material and Finish Codes

Surface Materials

Corian® See WCI Corian® Reference Guide, Page 32

3form® Chroma® See 3form® website for additional colors

FAE	Aloe
FAC	Atlantic
FCA	Camel
FEG	Eggplant
FGH	Ghost
FMA	Marmalade
FMS	Moss
FPW	Pewter
FSB	Sable
FSY	Sassy

Metal Solid & Mesh

MES	Solid*
MEM	Mesh (Park & Bistro tables only)
MSS	Scalloped Pattern (Sam table only)

Powder Coat

Solid Colors

MWH	White
MLG	Light Gray
MMG	Medium Gray
MDG	Dark Gray
MBK	Matte Black

Metallics

MSL	Silver
MGR	Graphite
MCH	Champagne
MDT	Dark Tone

Textures

MST	Stucco
MIG	Iron Glimmer
MWR	Black Wrinkle
MRB	Rubbed Bronze
MAN	Anthracite

*Available on select tables only.

Product Specifications | Material and Finish Codes

Edge Materials

Laminate See WCI Laminate Reference Guide, Page 30

Vinyl & PVC

VWH	White
VLG	Light Gray
VMG	Medium Gray
VDG	Dark Gray
VBK	Black
VDT	Dark Tone

Metal

MPR	Polished Aluminum Ribbed
MSR	Satin Aluminum Ribbed
MPA	Polished Aluminum
MSA	Satin Aluminum

Wood

Maple

WNM	Natural Maple
WHM	Honey Maple
WEM	Ebony Maple

Oak

WNO	Natural Oak
WMO	Medium Oak
WEO	Ebony Oak

Cherry

WNC	Natural Cherry
WMC	Medium Cherry
WEC	Ebony Cherry
WMA	Mahogany Over Cherry

Walnut

WNW	Natural Walnut
WMW	Medium Walnut
WDW	Dark Walnut

Maple Butcher Block

BNM	Natural Maple
BEM	Ebony Maple
BNC	Natural Cherry Over Maple
BMA	Mahogany Over Maple

Ultrafoam

ULFP	Flat White PVC Edge
ULFR	Raw Edge

Chair Materials (Seat and Back)

Molded Polypropylene

Standard Colors

PWH	White
------------	-------

Supplemental Colors

PGR	Green
PIV	Ivory
POR	Orange
PRD	Red
PYE	Yellow

Synthetic Rattan

RBK	Black
RHN	Honey

Metal

Aluminum

MPA	Polished Aluminum
------------	-------------------

Chair Finishes (Frame)

Metal

Aluminum

MPA	Polished Aluminum
------------	-------------------

Powder Coat

Metallics

MSL	Silver
------------	--------

Product Specifications | Bases

Dining and Multipurpose

AL	Alumilite
	<p>Standard Base Height: 28"</p> <p>Base: 26", 32" & 39" X-base and 26" T-base configurations, cast aluminum</p> <p>Column: 2.5" or 3" diameter, aluminum tubing</p> <p>Top Plate: 7.625" or 15" square steel</p> <p>Standard Glide: Black nylon (GNY) on powder coated bases, nickel plated glide (GNP) standard on satin (MSA) and polished (MPA) aluminum bases</p> <p>Standard Finish: Powder coated</p> <p>Optional Finishes: Polished or satin aluminum.</p>

CR	Corsica
	<p>Standard Base Height: 28"</p> <p>Base: 15.25" & 24" diameter cast iron</p> <p>Column: Cast iron</p> <p>Top Plate: 7.625" or 15" square steel</p> <p>Standard Glide: White nylon carpet glide (GNC)</p> <p>Standard Finish: Powder coated</p>

BA	Basic Round
	<p>Standard Base Height: 28"</p> <p>Base: 14", 17", 20", 22" & 28" diameter cast iron, also available with decorative steel cover plate for powder coating and plating. (L=light, M=medium, H=heavy weight)</p> <p>Column: 3", 3.5" or 6" diameter, steel tubing</p> <p>Top Plate: 7.625" or 15" square steel</p> <p>Standard Glide: White nylon carpet glide (GNC)</p> <p>Standard Finish: Cast iron in black wrinkle (MWR)</p> <p>Optional Finishes: Powder coated and plating</p>

CB	Cozy Bar
	<p>Standard Base Height: 41"</p> <p>Base: 17", 20" x 22" diameter cast iron, also available with decorative steel cover plate for powder coating and plating.</p> <p>Footring: Made from 1" diameter steel tubing mounted to base</p> <p>Footring Finish: Polished (MPC) and satin (MSC) chrome</p> <p>Column: 3" diameter, steel tubing</p> <p>Top Plate: 7.625" square steel</p> <p>Standard Glide: White nylon carpet glide (GNC)</p> <p>Standard Finish: Cast iron in black wrinkle (MWR)</p> <p>Optional Finishes: Powder coated and plated</p>

Bolt Down	Bolt Down
	<p>(JB) J Bolt Down Base (TB) Trumpet Bolt Down Base (BB) Beehive Bolt Down Base (FB) Florentine Bolt Down Base</p> <p>Standard Base Height: 28"</p> <p>Floor Plate: 6.75" diameter steel with four .375" diameter holes; fasteners to attach base to floor are not included.</p> <p>Cover Plate: 8" diameter steel, finish to match column</p> <p>Column: 3" diameter, steel tubing</p> <p>Top Plate: 7.625" square steel</p> <p>Standard Finish: Powder coated</p> <p>Optional Finish: Plated</p>

DI	Disc
	<p>Standard Base Height: 28"</p> <p>Base: 18", 22" & 26" diameter .375" thick steel plate</p> <p>Column: 2" or 3" diameter, steel tubing</p> <p>Top Plate: 7.625" or 15" square steel</p> <p>Standard Glide: White nylon carpet glide (GNC)</p> <p>Standard Finish: Powder coated</p> <p>Optional Finish: Plated</p>

CA	Capri
	<p>Standard Base Height: 28"</p> <p>Base: 15.25" diameter cast iron</p> <p>Column: Cast iron</p> <p>Top Plate: 7.625" square steel</p> <p>Standard Glide: White nylon carpet glide (GNC)</p> <p>Standard Finish: Powder coated</p>

DU	Dunhill
	<p>Standard Base Height: 28"</p> <p>Base: 18", 24", 30" & 36" X-base configurations, 18", 24" & 30" T-base configurations with a single column. Double column T-bases are available 30" or 36" wide, .5" x 2.5" solid steel bar</p> <p>Column: 2", 2.25", 3" or 3.25" diameter, steel tubing</p> <p>Top Plate: 7.625", 10.75" or 15" square steel</p> <p>Standard Glide: Black octagon (GNO)</p> <p>Standard Finish: Powder coated</p> <p>Optional Finish: Plated</p>

Product Specifications | Bases

Dining and Multipurpose

FR Flat Round

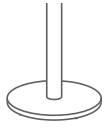

Standard Base Height: 28"
Base: 18", 22" & 26" diameter cast iron with decorative steel cover plate
Column: 3", 3.5" or 6" diameter, steel tubing
Top Plate: 7.625", 10.75" or 15" square steel
Standard Glide: Black octagon (GNO)
Standard Finish: Powder coated
Optional Finish: Plated

KN Knobhill

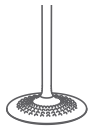

Standard Base Height: 28"
Base: 18" or 24" diameter (L=light, M=medium, H=heavy, XH= extra heavy weight) cast iron with steel decorative cover plate
Column: 2" or 2.25" diameter, steel tubing
Top Plate: 7.625", 10.75" or 15" square steel
Standard Glide: White nylon carpet glide (GNC)
Standard Finish: Powder coated
Optional Finish: Plated

MH Manhattan



Standard Base Height: 28"
Base: 20", 24" or 30" diameter cast iron
Column: 3", 3.5" or 4" diameter, steel tubing
Top Plate: 7.625", 10.75" or 15" square steel
Standard Glide: Black octagon (GNO)
Standard Finish: Powder coated

MA Mark IV

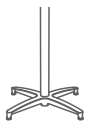

Standard Base Height: 28"
Base: 24", 30" & 36" X-base, 27" V-base and 18" & 30" T-base configurations, cast aluminum
Column: 2", 2.5" or 3" diameter, aluminum tubing
Top Plate: 7.625" or 15" square steel
Standard Glide: Black nylon (GNY) on powder coated bases, nickel plated glide (GNP) standard on satin (MSA) and polished (MPA) aluminum bases
Standard Finish: Powder coated
Optional Finishes: Polished or satin aluminum

ME Medici

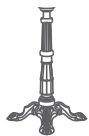

Standard Base Height: 28"
Base: 18" cast iron X-base
Column: Cast iron
Top Plate: 7.625" square steel
Standard Glide: White nylon carpet glide (GNC)
Standard Finish: Powder coated

MOV Move



Overall Table Height: 25"
Dimensions: 18" Depth, 13" Width, 15" Width
Top: Laminate, wood veneer, 3form Chroma, Corian®
Standard Glide: 2.25" Round Teflon Glide
Standard Finish: Powder coated or clear coated hot rolled steel
Optional Finish: Plated (polished not available)

PA Parsons



Overall Table Height: 29"
Legs: 2.5" x 2.5" solid lumber
Apron: 2.5" high
Legs & Apron: Laminate or wood
Top: Laminate or wood veneer
Standard Glide: Nickel plated glide (GNP)

PL Platform

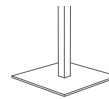

Standard Base Height: 28"
Base: 18", 22" & 26" square .375" thick steel plate
Column: 2" or 3" square steel tubing
Top Plate: 7.625" or 15" square steel
Standard Glide: White nylon carpet glide (GNC)
Standard Finish: Powder coated
Optional Finish: Plated

PO Post Leg



Standard Base Height: 28"
Leg: 1.5", 2.5" or 3" diameter steel tubing
Top Plate: 4.25" or 6" square steel
Standard Glide: Nickel plated with white nylon bottom (GNN)
Standard Finish: Powder coated
Optional Finish: Plated

PR Presidio



Standard Base Height: 28"
Base: 18", 24", 30" & 36" X-bases. 18", 24" & 30" T-base configurations with a single column. Double column T-bases are available 30" or 36" wide, .5" x 2.5" solid steel bar
Column: 2.25" or 3" diameter, steel tubing
Top Plate: 7.625", 10.75" or 15" square steel
Standard Glide: Puck (PUC) glide finish to match base finish. Powder coat (PUCPC) and plated (PUCPL)
Standard Finish: Powder coated
Optional Finish: Plated

Product Specifications | Bases

Dining and Multipurpose

RG Regency

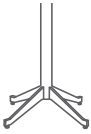

Standard Base Height: 28"
Base: 18", 24", 30" X-base configurations, .5" solid steel, tapering from 2.5" high to 1.25" high.
36" & 48" X-base configurations, 1" solid steel, tapering from 3" high to 1.25" high.
21" x 42" & 24" x 48" scissor-base configurations, 1" solid steel, tapering from 3" high to 1.25" high.
Column: 2.5" or 3.5" diameter steel tubing
Top Plate: 7.625" or 15" square steel, 15" x 24" & 18" x 36" flat iron
Standard Glide: Nickel plated glide (GNP)
Standard Finish: Powder coated
Optional Finish: Plated

SC Scala



Standard Base Height: 28"
Base: 19.5" diameter cast iron
Column: Cast iron
Top Plate: 10.75" square steel
Standard Glide: White nylon carpet glide (GNC)
Standard Finish: Powder coated

SI Siena

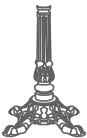

Standard Base Height: 28"
Base: 23.75" cast iron X-base
Column: Cast iron
Top Plate: 10.75" square steel
Standard Glide: White nylon carpet glide (GNC)
Standard Finish: Powder coated

SL Slimline

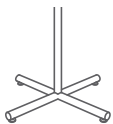

Standard Base Height: 28"
Base: 18", 24", 30" & 36" X-bases. 18", 24" & 30" T-base configurations with a single column. Double column T-bases are available 30" or 36" wide. 1.75" diameter steel tubing
Column: 1.75" & 3.5" diameter, steel tubing
Top Plate: 7.625", 10.75" or 15" square steel
Standard Glide: Nickel plated with white nylon bottom (GNN)
Standard Finish: Powder coated
Optional Finish: Plated

SV Spacesaver

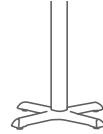

Standard Base Height: 28"
Base: 22", 30" & 36" X-base, 24" x 30" spider base and 18" & 22" T-base configurations, cast iron
Column: 3" diameter, steel tubing
Top Plate: 7.625" or 15" square steel
Glide: Nylon glide (GSV)
Standard Finish: Cast iron in black wrinkle (MWR)
Optional Finish: Powder coated

TO Toscana

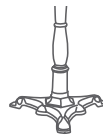

Standard Base Height: 28"
Base: 23.75" cast iron 3-prong
Column: Cast iron
Top Plate: 7.625" square steel
Standard Glide: White nylon carpet glide (GNC)
Standard Finish: Powder coated

TL Tulip



Standard Base Height: 28"
Base: 18" or 24" diameter (L=light, M=medium, H=heavy, XH= extra heavy weight) cast iron with decorative steel cover plate.
Column: 2" or 2.25" diameter, steel tubing
Top Plate: 7.625", 10.75" or 15" square steel
Standard Glide: White nylon carpet glide (GNC)
Standard Finish: Powder coated
Optional Finish: Plated

TU Tuscan



Standard Base Height: 28"
Base: 18", 24", 30" & 36" X-bases. 18", 24" & 30" T-base configurations with a single column. Double column T-bases are available 30" or 36" wide. 1" x 2" steel rectangle tubing
Column: 2" or 3" diameter, steel tubing
Top Plate: 7.625", 10.75" or 15" square steel
Standard Glide: Black octagon (GNO)
Standard Finish: Powder coated
Optional Finish: Plated

Product Specifications | Occasional Bases and Tables

Occasional Tables

CU

Cube

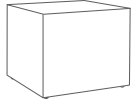

Overall Table Heights: 16", 18", 20" & 24"
Material: Laminate or wood construction
Standard Glide: Nickel plated glide (GNP)

CY

Cylinder



Overall Table Heights: 16", 18", 20" & 24"
Material: Laminate or wood construction
Standard Glide: Nickel plated glide (GNP)

DI

Disc

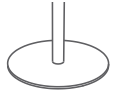

Occasional Base Heights: 16", 18" or 20"
Base: 18" & 22" diameter .375" thick steel plate
Column: 2" diameter, steel tubing
Top Plate: 7.625" square steel
Standard Glide: White nylon carpet glide (GNC)
Standard Finish: Powder coated
Optional Finish: Plated

MOV

Move



Overall Table Height: 25"
Dimensions: 18" Depth, 13" Width, 15" Width
Top: Laminate, wood veneer, 3form Chroma, Corian®
Standard Glide: 2.25" Round Teflon Glide
Standard Finish: Powder coated or clear coated
hot rolled steel
Optional Finish: Plated (polished not available)

PA

Parsons



Overall Occasional Table Heights: 16", 18", 20", 24"
Legs: 2.5" x 2.5" solid lumber
Apron: 2.5" high
Material: Laminate or wood construction
Standard Glide: Nickel plated glide (GNP)

PL

Platform

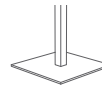

Occasional Base Heights: 16", 18" or 20"
Base: 18" & 22" square .375" thick steel plate
Column: 2" square steel tubing
Top Plate: 7.625" square steel
Standard Glide: White nylon carpet glide (GNC)
Standard Finish: Powder coated
Optional Finish: Plated

TL

Tulip

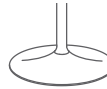

Occasional Base Heights: 16", 18" or 20"
Base: 18" or 24" diameter (L=light, M=medium, H=heavy weight) cast iron with decorative steel cover plate.
Column: 2" or 2.25" diameter, steel tubing
Top Plate: 7.625" or 10.75" square steel
Standard Glide: White nylon carpet glide (GNC)
Standard Finish: Powder coated
Optional Finish: Plated

Product Specifications | Outdoor Bases and Tables

Outdoor Tables

ARC	Arc
	<p>Overall Table Height: 29.25"</p> <p>Base: 4 leg steel base</p> <p>Column: 1.5" square steel tubing</p> <p>Top Plate: Tilt-top mechanism</p> <p>Top: Solid metal (MES)</p> <p>Standard Glide: Adjustable nylon glide</p> <p>Standard Finish: Powder coated silver (MSL)</p> <p>Some assembly required</p>

MA	Mark IV
	<p>Standard Base Height: 28"</p> <p>Base: 24", 30" & 36" X-base, 27" V-base and 18" & 30" T-base configurations, cast aluminum</p> <p>Column: 2" or 3" diameter, aluminum tubing</p> <p>Top Plate: 7.625" or 15" square steel</p> <p>Standard Glide: Superlevel glide (GSL)</p> <p>Standard Finish: Powder coated</p> <p>Optional Finish: Anodized Aluminum</p>

BA	Basic Round
	<p>Standard Base Height: 28"</p> <p>Base: 14", 17", 20", 22" & 28" diameter cast iron, also available with decorative steel cover plate for powder coating (L=light, M=medium, H=heavy weight)</p> <p>Column: 3", 3.5" or 6" diameter, steel tubing</p> <p>Top Plate: 7.625" or 15" square steel</p> <p>Standard Glide: Superlevel glide (GSL)</p> <p>Standard Finish: Cast iron in black wrinkle (MWR)</p> <p>Optional Finish: Powder coated</p>

PK	Park
	<p>Overall Table Height: 29"</p> <p>Base: 4 leg steel base</p> <p>Top: Mesh (MEM) metal top</p> <p>Standard Glide: Fixed nylon glide</p> <p>Standard Finish: Powder coated silver (MSL)</p> <p>Includes 1.5625" umbrella hole</p>

BI	Bistro
	<p>Overall Table Height: 28.75"</p> <p>Base: 4 leg steel base</p> <p>Top: Solid (MES) or mesh (MEM) metal top</p> <p>Standard Glide: Fixed nylon glide</p> <p>Standard Finish: Powder coated</p>

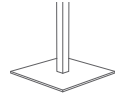
PL	Platform
	<p>Standard Base Height: 28"</p> <p>Base: 18", 22" & 26" square .375" thick steel plate</p> <p>Column: 2" or 3" square steel tubing</p> <p>Top Plate: 7.625" or 15" square steel</p> <p>Standard Glide: Black octagon (GNO)</p> <p>Standard Finish: Powder coated</p>

DI	Disc
	<p>Standard Base Height: 28"</p> <p>Base: 18", 22" & 26" diameter .375" thick steel plate</p> <p>Column: 2" or 3" diameter, steel tubing</p> <p>Top Plate: 7.625" or 15" square steel</p> <p>Standard Glide: Black octagon (GNO)</p> <p>Standard Finish: Powder coated</p>

SM	Sam Table
	<p>Overall Table Height: 29.125" & 42"</p> <p>Base: Clear coated polished aluminum X- base</p> <p>Column: 2.5" diameter aluminum tubing</p> <p>Top: Stainless steel with scalloped pattern (MSS)</p> <p>Standard Glide: Adjustable nylon glide</p> <p>Standard Finish: Stainless steel with scalloped pattern top with a clear coated polished aluminum base</p> <p>Some assembly required</p>

FR	Flat Round
	<p>Standard Base Height: 28"</p> <p>Base: 18", 22" & 26" diameter cast iron with decorative aluminum cover plate</p> <p>Column: 3" or 6" diameter, aluminum tubing</p> <p>Top Plate: 7.625", 10.75" or 15" square steel</p> <p>Standard Glide: Superlevel glide (GSL)</p> <p>Standard Finish: Powder coated</p> <p>Optional Finish: Anodized Aluminum</p>

TL	Tulip
	<p>Standard Base Height: 28"</p> <p>Base: 18" or 24" diameter (L=light, M=medium, H=heavy, XH= extra heavy weight) cast iron with decorative steel cover plate</p> <p>Column: 2" or 2.25" diameter, steel tubing</p> <p>Top Plate: 7.625", 10.75" or 15" square steel</p> <p>Standard Glide: Superlevel glide (GSL)</p> <p>Standard Finish: Powder coated</p>

Product Specifications | Outdoor Chairs

Outdoor Chairs

BZCA	Breeze
	<p>Arm Chair</p> <p>Stacks: 6 high</p> <p>Width: 20.5"</p> <p>Depth: 24"</p> <p>Height: 32.25"</p> <p>Weight: 12.5 lb.</p> <p>Standard Finish: Powder coated silver (MSL)</p>

PLCS	Polly
	<p>Side Chair</p> <p>Stacks: 6 high</p> <p>Width: 21.5"</p> <p>Depth: 25.5"</p> <p>Height: 32.5"</p> <p>Weight: 8 lb.</p> <p>Standard Finish: Polypropylene white (PWH)</p>

CYCA	Courtyard
	<p>Arm Chair</p> <p>Stacks: 6 high</p> <p>Width: 20.5"</p> <p>Depth: 20.5"</p> <p>Height: 33"</p> <p>Weight: 15 lb.</p> <p>Standard Finish: Powder coated silver (MSL)</p>

SMCS	Sam
	<p>Side Chair</p> <p>Stacks: 8 high</p> <p>Width: 17.5"</p> <p>Depth: 21.5"</p> <p>Height: 30.5"</p> <p>Weight: 9 lb.</p> <p>Standard Finish: Clear coated polished aluminum (MPA) only</p>

PZCA	Piazza
	<p>Arm Chair</p> <p>Stacks: 8 high</p> <p>Width: 22"</p> <p>Depth: 25"</p> <p>Height: 29.5"</p> <p>Weight: 9 lb.</p> <p>Standard Finish: Clear coated polished aluminum frame with black (RBK) or honey (RHN) synthetic rattan woven seats and backs</p>

SMCA	Sam
	<p>Arm Chair</p> <p>Stacks: 8 high</p> <p>Width: 21.5"</p> <p>Depth: 25.5"</p> <p>Height: 32.5"</p> <p>Weight: 9 lb.</p> <p>Standard Finish: Clear coated polished aluminum (MPA) only</p>

PZCB	Piazza
	<p>Bar Arm Chair</p> <p>Width: 21"</p> <p>Depth: 22"</p> <p>Seat Height: 30"</p> <p>Overall Chair Height: 39"</p> <p>Weight: 10 lb.</p> <p>Standard Finish: Clear coated polished aluminum frame with black (RBK) or honey (RHN) synthetic rattan woven seats and backs</p>

SMCB	Sam
	<p>Bar Arm Chair</p> <p>Width: 21"</p> <p>Depth: 22"</p> <p>Seat Height: 30"</p> <p>Overall Chair Height: 39"</p> <p>Weight: 10 lb.</p> <p>Standard Finish: Clear coated polished aluminum (MPA) only</p>

PCCA	Picnic
	<p>Arm Chair</p> <p>Stacks: 6 high</p> <p>Width: 22"</p> <p>Depth: 21"</p> <p>Height: 31"</p> <p>Weight: 11.5 lb.</p> <p>Standard Finish: Powder coated silver (MSL)</p>

Product Specifications | Tops

Laminate Top Construction

Standard 1.25" thick core material, consisting of a NAUF Particle Board (45.5 lb/ft³), MDF (46 lb/ft³), or 1" thick Birch Plywood (40 lb/ft³) core, surfaced with a laminate face. The core material is determined by the specified edge profile. A moisture-resistant backing sheet is laminated to the underside of the top. All complete tables (consisting of a top and base) have steel threaded inserts for metal-to-metal mounting of the top to the base, allowing ease of installation. Tops sold separately do not have steel threaded inserts. Table tops over 96" in length have steel support to prevent bowing. All top dimensions are nominal and may vary up to 0.75," depending on the edge treatment. If a critical size is required (± 0.0625 "), dimensions should be specified in writing.

Wood Veneer Top Construction

Standard 1.25" thick core material, consisting of a NAUF Particle Board (45.5 lb/ft³), MDF (46 lb/ft³), or Birch Plywood (40 lb/ft³) core, surfaced with a book matched veneer face. A moisture-resistant backing sheet is laminated to the underside of the top. All complete tables (consisting of a top and base) have steel threaded inserts for metal-to-metal mounting of the top to the base, allowing ease of installation. Tops sold separately do not have steel threaded inserts. Table tops over 96" in length have steel support to prevent bowing. All top dimensions are nominal and may vary up to 0.75," depending on the edge treatment. If a critical size is required (± 0.0625 "), dimensions should be specified in writing.

Butcher Block Top Construction

Butcher Block Tops have an eased edge with 1.3125" wide finger jointed strips. Tops are 1.375" thick and 1.875" thick on 60" and 72" tops. Tops are constructed from solid maple and have 0.75" tolerance.

Laminate Surfaces

See Laminate Reference Guide, Page 30.

Wood Surface Finish

All wood products are finished in semi-gloss, acrylic waterborne enamel providing a 40% sheen finish using a multi-step process of hand sanding, staining, and sealing that provides superior water and alcohol resistance. Custom sheens are available upon request; please contact WCI Customer Service for a quote.

Ultrafoam Surfaces

Standard 1" thick balanced construction consisting of NAUF – Particle Board (45.5 lb/ft³) core surfaced with a permanently bonded fire-retardant, expanded polyvinyl chloride pad. Ultrafoam tops are available with white vinyl T-mold or raw edges, and are recommended for use with tablecloth only. Ultrafoam tops create a slightly cushioned surface that is impervious to grease, foods, acids, and alcohol. Ultrafoam tops absorb sound and eliminate the need for silencer cloth, double linen or other padding. All complete tables (tables consisting of a top and base) have steel threaded inserts for metal-to-metal mounting of the top to the base, allowing ease of installation. Tops sold separately do not have steel threaded inserts. Table tops over 96" in length have steel support to prevent bowing. All top dimensions are nominal and may vary up to 0.75" depending on the edge treatment. If a critical size is required (± 0.0625 "), dimensions should be specified in writing.

3Form® Chroma® Surfaces

Standard 1" ($\pm 10\%$) thick with 0.75" moisture resistant marine grade plywood sub-top for indoor and outdoor use. 3form® Chroma® (74.3 lb/ft³) is produced from optical grade engineered resin with high UV resistance consisting of 30% recycled, 12% pre-consumer, and 18% post-consumer content, and is certified according to the GREENGAURD® Indoor Air Quality Certification Program for Low Emitting Products. The surface of Chroma® features renewable matte texture that can be easily refinished throughout its lifetime. All top dimensions are nominal and may vary up to 0.75" depending on the edge treatment. If a critical size is required (± 0.0625 "), dimensions should be specified in writing.

Product Specifications | Tops

Acrylic Surfaces

Standard 1.25" thick with moisture resistant marine grade plywood sub-top. Specially formulated acrylic provides a tough, nonporous surface material with superior stain and UV resistance. Color and material is consistent throughout the top, providing a renewable surface. Acrylic surfaces are not predrilled to accept table bases. All top dimensions are nominal and may vary up to 0.75" depending on the edge treatment. If a critical size is required (± 0.0625 "), dimensions must be specified in writing.

Corian® Surfaces

Standard 1"x1" thick built-up edge on 0.5" thick Corian® (106.1 lb/ft³) with a steel sub-frame and a 0.75" X 1.5" steel tube finished with standard matte black powder coat. Corian® is a solid surface material from DuPont composed of 33% of Poly Methyl Methacrylate and 67% of Natural Minerals like Alumina Trihydrate. Corian®, along with its adhesives and sealants, are certified by GREENGUARD®, providing a complete surfacing system with low amounts of VOC (volatile organic compounds). All complete tables (tables consisting of a top and base) will have steel threaded inserts for metal-to-metal mounting of the top to the base, allowing ease of installation. Steel sub-frames are designed to fit only WCI's standard bases, and, consequently, all top only requests must be processed as a custom product. All top dimensions are nominal and may vary up to 0.75" depending on the edge treatment. If a critical size is required (± 0.0625 "), dimensions must be specified in writing.

Vinyl T-Mold Edges

Vinyl edges provide an impact-resistant edge. All vinyl T-molding corners have a 2" radius.

PVC Edges

PVC edges provide an impact-resistant edge. All PVC corners are square.

Metal Edges

Metal edges are extruded 6063 Aluminum, allowing for strength and durability. Standard finishes are polished and satin aluminum. All metal edges have a 2" radius.

Wood Edges

Wood edges are offered in solid maple, oak, cherry, and walnut. Other wood species are available upon request; please contact WCI Customer Service for a quote.

Overall Table Heights

Overall table heights vary according to top specification. WCI standard base height is 28". Add top thickness to determine overall table height. For alternate height (AH) tables, the height specification refers to the overall height of the table when ordering a complete table, or the overall height of the base when ordering base only.

Product Specifications | Edge Profiles

Self Edge

LLSE Self Laminate Edge



1.25" thick edge is banded with matching standard grade top plastic laminate.

Square and rectangle tops standard with square corners
Available on 1.25" thick top

LLSE3 Self Laminate Edge



1.75" thick edge is banded with matching standard grade top plastic laminate

Square and rectangle tops standard with square corners
Available on 1.25" thick top

Vinyl Edges

LVFL Flat Vinyl T-Mold Edge



.125" x 1.25" flat vinyl edge
Square and rectangle tops standard with 2" radius corners
Available on 1.25" thick top
Available in 6 colors

LVBP Bumper Vinyl T-Mold Edge



.1875" x 1.25" rounded vinyl bumper edge
Square and rectangle tops standard with 2" radius corners
Available on 1.25" thick top
Available in 6 colors

PVC Edge

LPVC Flat PVC Edge

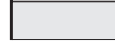

.125" x 1.25" flat pvc edge
Square and rectangle tops standard with square corners
Available on 1.25" thick top
Available in 6 colors

Metal Edges

LMFL Flat Metal T-Mold Edge



.125" x 1.25" flat aluminum edge
Square and rectangle tops standard with 2" radius corners
Available on 1.25" thick top
Available in polished (MPA) or satin (MSA) finishes

LMRB Ribbed Metal T-Mold Edge

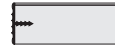

.125" x 1.25" ribbed aluminum edge
Square and rectangle tops standard with 2" radius corners
Available on 1.25" thick top
Available in polished (MPR) or satin (MSR) finishes

Product Specifications | Edge Profiles

Wood Edges Group A

LW = Laminate top with a wood edge
 WW = Wood top with a wood edge

LWFL & WWFL	Flat Wood Edge
	.125" thick flat wood edge, eased corners Square and rectangle tops standard with square corners Available on 1.25" thick top Available in 4 wood species and 13 stains

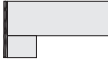
LWFL3 & WWFL3	Flat 3 Edge
	.125" x 1.75" thick flat wood edge Square and rectangle tops standard with square corners Available on 1.25" thick top Available in 4 wood species and 13 stains

LWPI & WWPI	Pivot Wood Edge
	.25" x 1.25" pivot wood edge Square and rectangle tops standard with square corners Available on 1.25" thick top Available in 4 wood species and 13 stains

LWTP & WWTP	Tapered Ply Edge
	1" thick exposed Baltic Birch plywood edge with a reverse beveled tapered profile Square and rectangle tops standard with square corners Available on 1" thick top Top surface available in 4 wood species and 13 stains

LWFP & WWFP	Flat Ply Edge
	1" thick exposed Baltic Birch plywood edge with a flat profile Square and rectangle tops standard with square corners Available on 1" thick top Top surface available in 4 wood species and 13 stains

Wood Edges Group B

LW = Laminate top with a wood edge
 WW = Wood top with a wood edge

LWSQ & WWSQ	Square Wood Edge
	1.25" x 1.25" flat square wood edge Square and rectangle tops standard with square corners Available on 1.25" thick top Available in 4 wood species and 13 stains

LWSQ3 & WWSQ3	Square 3 Wood Edge
	1.75" x 1.75" thick square wood edge Square and rectangle tops standard with square corners Available on 1.25" thick top Available in 4 wood species and 13 stains

LWAR & WWAR	Arc Wood Edge
	.75" x 1.25" arc wood edge Square and rectangle tops standard with square corners Available on 1.25" thick top Available in 4 wood species and 13 stains

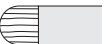
LWBN & WWBN	Bullnose Wood Edge
	1.25" x 1.25" bullnose wood edge Square and rectangle tops standard with square corners Available on 1.25" thick top Available in 4 wood species and 13 stains

LWBN3 & WWBN3	Bullnose 3 Wood Edge
	1.75" x 1.75" thick bullnose wood edge Square and rectangle tops standard with square corners Available on 1.25" thick top Available in 4 wood species and 13 stains

LWPR & WWPR	Prism Wood Edge
	1.25" x 1.25" prism wood edge Square and rectangle tops standard with square corners Available on 1.25" thick top Available in 4 wood species and 13 stains

Product Specifications | Edge Profiles

Butcher Block Edges

BBFL Butcher Block Flat Edge



1.3125" finger jointed strips x 1.375" thick, 1.875" thick on 60" diameter tops only
Square and rectangle tops standard with square corners
Available on 1.375" thick top
Available in maple and 4 stains

BBBN Butcher Block Bullnose Edge

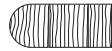

1.3125" finger jointed strips x 1.375" thick, 1.875" thick on 60" diameter tops only
Square and rectangle tops standard with .5" radius corners
Available on 1.375" thick top
Available in maple and 4 stains

Ultrafoam Edges

ULFP Ultrafoam PVC Edge



.039" x 1" flat PVC edge
Square and rectangle tops standard with square corners
Available on 1" thick top

ULFR Ultrafoam Raw Edge



1" ultrafoam top with raw edge
Square and rectangle tops standard with square corners
Available on 1" thick top

Acrylic Edge

AAOP & AATL Acrylic Opaque / Acrylic Translucent Tops With Waterfall Edges

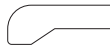

1.25" acrylic top with waterfall edge
Square and rectangle tops standard with 3" radius corners

Corian® Edges

C1FL & C2FL Corian® Flat Edge

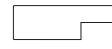

.5" thick Corian® material with 1" thick edge
Square and rectangle tops standard with .125" radius corners

C1BN & C2BN Corian® Bullnose Edge



.5" thick Corian® material with 1" thick edge
Square and rectangle tops standard with .5" radius corners

C1PR & C2PR Corian® Prism Edge



.5" thick Corian® material with 1" thick edge
Square and rectangle tops standard with square corners

3form Chroma Edges

3FFL 3form® Chroma® Flat Edge



1" thick Chroma material
Square and rectangle tops standard with .125" radius corners
Available in 10 Chroma colors

3FBN 3form® Chroma® Bullnose Edge



1" thick Chroma material
Square and rectangle tops standard with .5" radius corners
Available in 10 Chroma colors

3FPR 3form® Chroma® Prism Edge

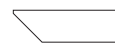

1" thick Chroma material
Square and rectangle tops standard with square corners
Available in 10 Chroma colors

3FRB 3form® Chroma® Reverse Bevel Edge (Outdoor Only)

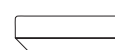

1" thick Chroma material
Square and rectangle tops standard with square corners
Available in 10 Chroma colors

Move Edge (Move Table Only)

LMOV Ply Move Edge



.5" thick exposed Baltic Birch plywood edge
Standard with .63" radius corners

WMOV Veneer Move Edge



.5" thick wood edge
Standard with .63" radius corners
Available in 4 wood species and 13 stains

CMOV Corian® Move Edge

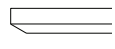

.5" thick Corian® material
Standard with .63" radius corners

3MOV 3form® Chroma® Move Edge

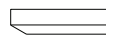

.5" thick 3form Chroma material
Standard with .63" radius corners
Available in 10 Chroma colors

Product Specifications | Laminate Reference Guide

WCI offers over 800 standard laminates from Nevamar, Formica, Wilsonart, and Pionite. Laminates from other manufacturers and non-standard laminates are available, and require special pricing from WCI's Customer Service Department. Please contact WCI Customer Service at **800-243-3150** for all special laminate requests.

Please note: Laminate manufacturers change their product offerings frequently and sometimes without advanced notification. For this reason, a standard laminate may not be available. Please contact the laminate manufacturers for current offerings.

Note: Other laminate manufacturers are available, such as Arborite®, Laminart®, and Abet Laminati®.

Wilsonart®	Identifying Code
Standard Finishes	
Matte	60
Fine Velvet Texture	38
Standard Selections	
Solids	
Woodgrains	
Non-standard Selections (require quote)	
Solids-Gloss/Filmed	
Decorative Metals	
Non-standard Finishes (require quote)	
Gloss	01
Textured Gloss	07
Linearity	18
High Wear	HW
Quarry	52
Fine Grain	78
Soft Grain	12
Premium High Definition	35/45/55
Chalk Board	137
Chemsurf® Chemical-Resistant	390
Fire Rated	604, 605, 607
Marker Board	136/336

Pionite

Standard Finishes	Identifying Code
Suede	N

Pionite	Identifying Code
Standard Selections	
Solids	
Patterns	
Stones	
Woodgrains	
Non-standard Finishes (require quote)	
Ashwood	Z
Hi_Brite	H
Soft Leather	C
Embossed Leather	L
Slate	W
Granite	R
Stone X	V
Super Matte	F

Nevamar	Identifying Code
Standard Finishes	
Textured	T
Standard Selections	
Solids	
Patterns	
Stones	
Woodgrains	
Patterns	
Non-standard Finishes (require quote)	
Crystal	CR
Chemarmor	CA
Polished Velvet	PV
Super Matte	SM

Formica®	Identifying Code
Standard Finishes	
Matte	58
Microdot	MC
Non-standard Selections (require quote)	
Color Core 2	C
Non-standard Finishes (require quote)	
Artisan	43
Crystal	42
Etchings	46
Honed	77
Naturelle (vertical use only)	NT
Radiance	RD
Sculpted (vertical use only)	SP

Product Specifications | Laminate Reference Guide

WCI materials have been carefully matched to the closest industry standards available in laminates. Color match accuracy varies with material and available colors. Please request WCI sample(s) for true colors.

WCI Color Match Recommendations

Material	Color	WCI Code	Manufacturer	Reference Number & Color
Vinyl Edges (including PVC)	White	VWH	Wilsonart	D354-60 Designer White
	Light Gray	VLG	Nevamar	S6003T Dove Gray
	Medium Gray	VMG	Wilsonart	D92-60 Dove Gray
	Dark Gray	VDG	Nevamar	S6054T Wrought Iron
	Black	VBK	Formica	909-58 Black Matte
	Dark Tone	VDT	Wilsonart	D91-60 Slate Gray
Wood Veneer Tops and Solid Wood Edges	Maple			
	Natural Maple	WNM	Wilsonart	7911-60 Manitoba Maple
	Honey Maple	WGM	Wilsonart	7925-38 Monticello Maple
	Ebony Maple	WHM	Wilsonart	7944K-01 Madagascar
	Oak			
	Natural Oak	WNO	Formica	8844WR Aged Ash
	Medium Oak	WMO	Nevamar	WM8110T Golden Ash
	Ebony Oak	WEO	Wilsonart	7944K-01 Madagascar
	Cherry			
	Natural Cherry	WNC	Wilsonart	7925-38 Monticello Maple
	Medium Cherry	WMC	Wilsonart	7919-78 Amber Cherry
	Ebony Cherry	WEC	Wilsonart	1595-60 Black
	Mahogany Over Cherry	WMA	Wilsonart	7122K-07 Empire Mahogany
	Walnut			
	Natural Walnut	WNW	Wilsonart	7110K-78 Montana Walnut
Medium Walnut	WMW	Wilsonart	W313A-60 Gunstock Walnut	
Dark Walnut	WDW	Pionite	HP359-H Thunderstorm	

Product Specifications | Corian® Reference Guide

Corian® is a solid surface material created by DuPont, composed of acrylic polymer and alumina trihydrate. Corian®, along with its adhesives and sealants, are certified by the GREENGUARD® Environmental Institute, providing a complete surfacing system with low-VOC.

Corian® tops are not sold separately as a standard product. All top only requests must be processed as a custom product. The under structure of indoor and outdoor Corian® tops consists of a steel sub-frame with a .75" x 1.5" steel tube finished with standard black matte powder coating. Sizes vary, depending on top size. Steel sub-frames are equipped with steel-threaded inserts to allow for metal to metal mounting of the top to the base. Steel sub-frames are designed to fit only WCI's standard bases.

All top dimensions are nominal and may vary up to .75" depending on the edge treatment. If a critical size is required (+/- .0625), dimensions must be specified in writing.

Due to random veining, material transparency, directional metallic flakes, and unique colors, seams and glue lines may be visible on tops larger than 30"W x 72"L in certain series of Corian® solid surface materials. Please refer to the lists below for colors that may present fabrication issues.

Private Collection Series

Seams may be visible at joints due to random veining patterns

Allspice	Hazelnut	Sagebrush
Arrowroot	Hickory Smoke	Sandalwood
Basil	Jasmine	Sonora
Burled Beach	Juniper	Sorrel
Cinnabar	Lava Rock	Thyme
Clam Shell	Natural Gray	Tumbleweed
Earth	Raincloud	Vanero White
Ecru	Rosemary	Verde
Elderberry	Saffron	Witch Hazel

Illumination Series

Seams will be visible when backlit, may be slightly visible when not backlit

Arctic Ice	Blueberry Ice	Lime Ice
Arctic Mint	Glacier Ice	Mint Ice

Metallic Series

Due to directional metallic flakes in each sheet seams will be visible

Anthracite	Copperite	Olivite
Aqualite	Graylite	Silverite
Azurite		

Difficult Colors to Seam

Glue line at joint may be visible

Graphic Blue	Night Sky	Sand
Nocturne	Sun	

Product Specifications | Wood Grain and Patterns

WCI wood veneer is bookmatched as standard.

For custom veneer patterns contact customer service at **415-261-6656** for quotation.

WCI Standard

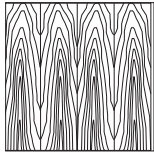

Bookmatched

Custom Patterns

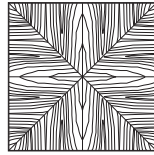

Reverse diamond

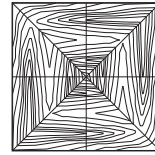

Box diamond

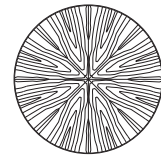

Sunburst

Long grain is standard on all WCI tables.

All tables larger than 10' will be made in two or more sections depending on total length.

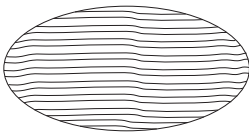

Long grain is standard on all WCI oval table tops

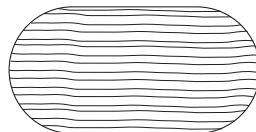

Long grain is standard on all WCI racetrack tables.

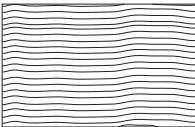

Long grain is standard on all WCI rectangle tables.

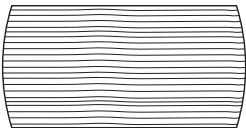

Long grain is standard on all WCI arc rectangle tables.

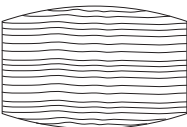

Long grain is standard on all WCI boat-shaped tables.

Product Specifications | Grommet Locations

Specify the desired grommet location using the chart below.

For custom locations please submit a sketch for location feasibility and verification.

Grommet Locations For Radius Tops.

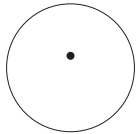

Location "A"



Location "B"

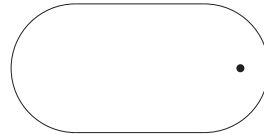

Location "C"

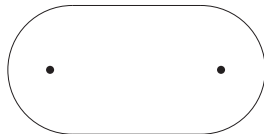

Location "D"

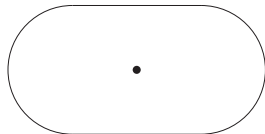

Location "E"

Grommet Locations For Square Corner Tops.

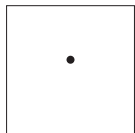

Location "A"



Location "B"



Location "C"

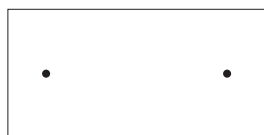

Location "D"

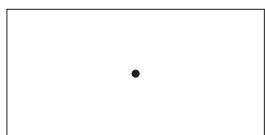

Location "E"

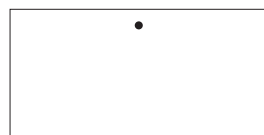

Location "F"

*For custom grommet locations, please submit a drawing with dimensions for placement.

Product Specifications | ADA Tables

Wheelchair Access

To comply with ADA regulations for wheelchair access to tables WCI recommends a minimum clearance of 27" from the floor to the bottom of the table; a minimum 30" barrier free width and a minimum barrier free depth of 19". In addition there must be a minimum of 30" unobstructed space from the table edge. Overall table height cannot exceed 34".

For more information on ADA requirements, the following websites may be useful:

National Network of ADA Centers: www.adata.org

U.S. Justice Department - ADA Home Page: www.ada.gov

ABA and ABA Guidelines Home Page: www.access-board.gov/ada-aba

Minimum Clearance Recommendations

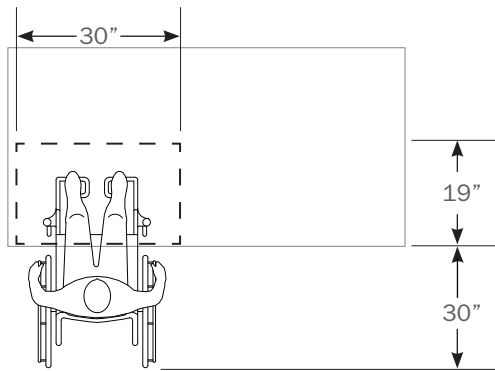

WCI ADA Table Recommendations

42" x 42" Post leg square table (P04242SQ)

23" x 39" Bistro ADA rectangle table (BI2339REOD)

30" x 48" T-base rectangle table (DUT3048RE, ALT3048RE, MAT3048RE, PRT3048RE, SLT3048RE, SVT3048RE, TUT3048RE)

ADA Logo

The ADA logo is standard on the Bistro Outdoor rectangle table. The blue ADA symbol is 1.75" high x 5" wide and is inset from the front table edge on the right-hand side (from seated position).

Drawing is not to scale.

Please offer this table
to our customers
with disabilities

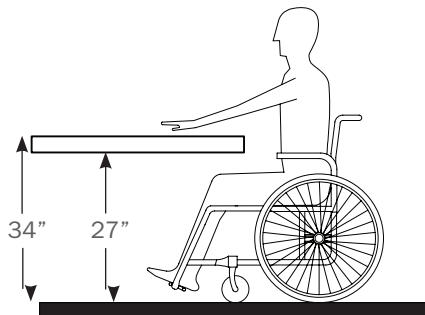

Product Specifications | Banquettes

- Coil-spring construction provides no hard edges and uniform support for comfort and durability.
 - Removable seat allows ease of re-upholstery.
 - Back pitch and seat depth can be specified to meet specific applications and price points.
 - Multi-functional banquettes can be designed for both Hospitality and Contract environments.
 - Foams used in fabrication are flame retardant and pass: CAL 117 and TB-133.
 - LEED compliant materials available upon request.
 - Shop drawings are submitted by WCI design/engineering staff for final approval before fabrication commences.
- **Back Support:** 2.5" polyfoam over .125" plywood backing
 - **Seat:** Removable with 2" polyfoam with bonded Dacron
 - Insulpad and coil springs
 - **Seat Platform:** .75" CDX exterior grade plywood
 - **Booth Platform:** .75" CDX exterior grade plywood
 - **Other services are available at a minimal charge including:** field dimensioning (including templates when necessary), delivery and installation.

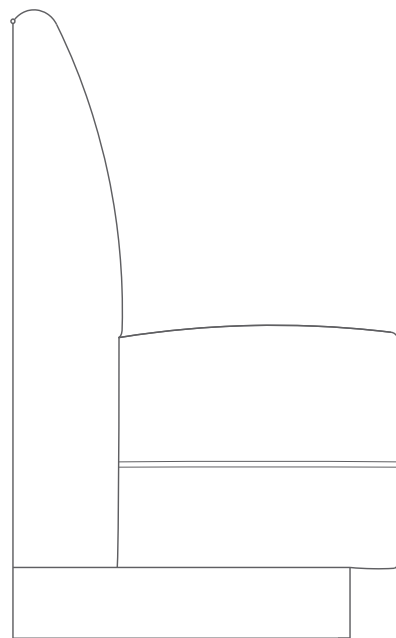
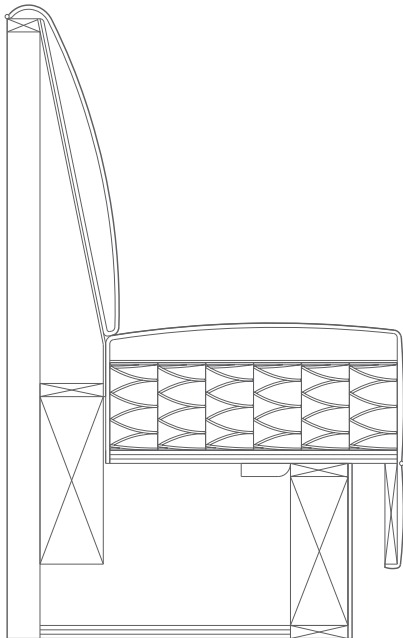

Product Specifications | Banquettes

Standard Configurations



Single



Double

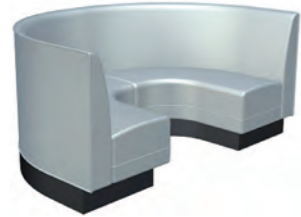

U - Shaped

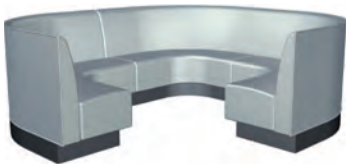

3/4 Circle

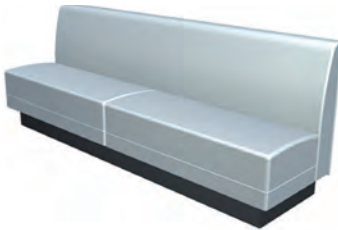

Straight



L - Shaped

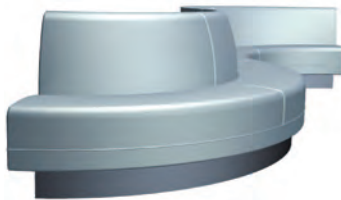

Custom Curved

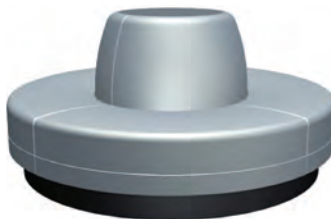

Rotunda

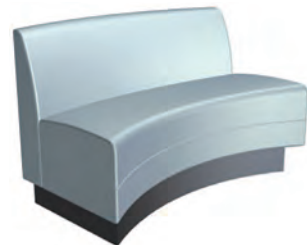

Ellipse

Custom shapes are available upon request.

Images shown are representations of standard WCI banquette configurations

Product Specifications | Banquettes



Inside Back Styles

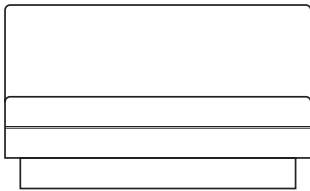

Plain upholstered
(standard)

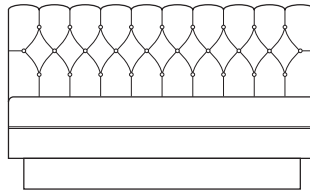

Diamond tufted

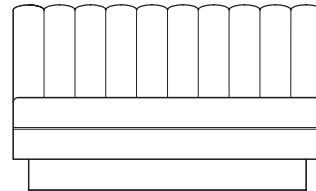

3" – 6" wide vertical channels

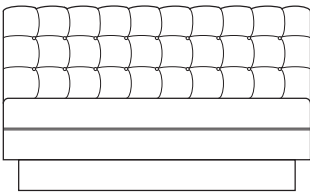

Biscuit tufted



6" wide horizontal channels

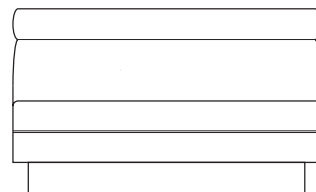

Plain back with 4" – 6" wide headroll

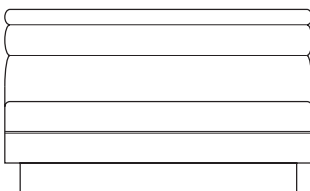

Graduating width horizontal
channels

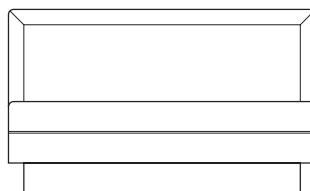

Plain back with 3" wide picture
frame headroll

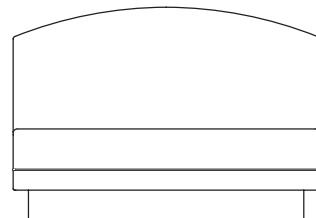

High rise curved back

Product Specifications | Banquettes



End Panel Styles

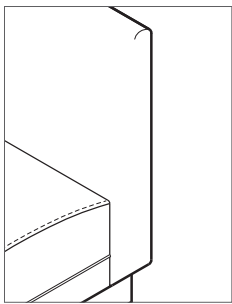

Wrap-around upholstered (standard)

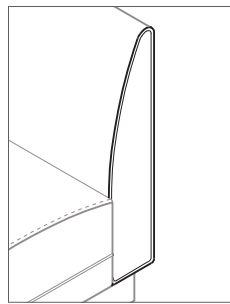

Self upholstered with welt all around

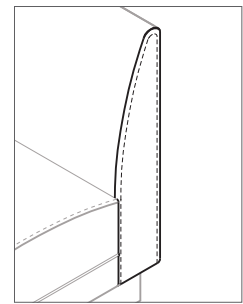

Self upholstered with french stitch

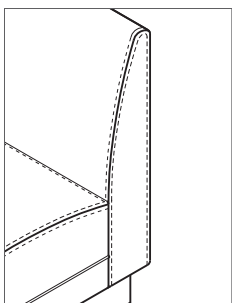

Self upholstered with baseball stitch

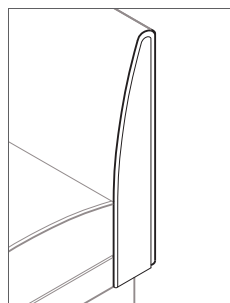

Applied upholstered end panel with welt all around

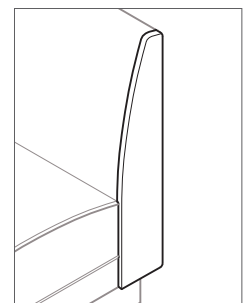

Applied .75" self edge plastic laminate or wood veneer end panel

Product Specifications | Banquettes



Seat Styles

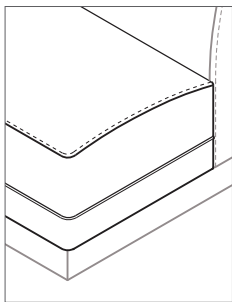

Plain upholstered with french stitch on all seat top edges (standard)

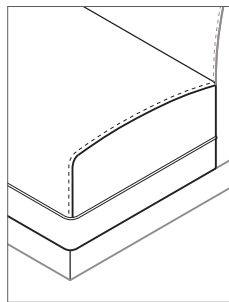

Waterfall upholstered front and back edges with french stitch on ends

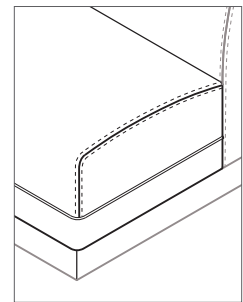

Waterfall upholstered front and back edges with baseball stitch on ends

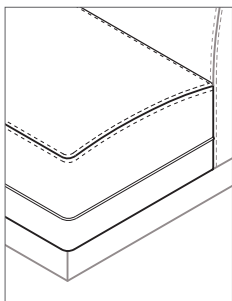

Plain upholstered with baseball stitch on all seat top edges

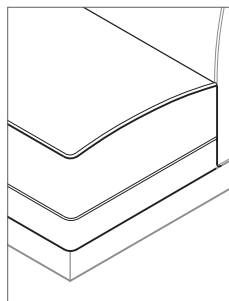

Plain upholstered with welt on all seat top edges

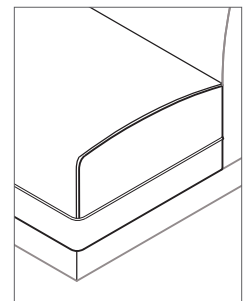

Waterfall upholstered front and back edges with welt on ends

Product Specifications | Banquettes



Seat Apron Styles

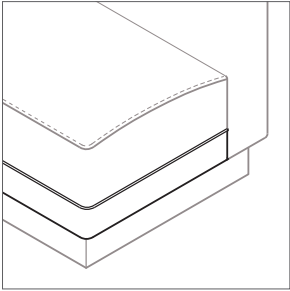

Flush seat apron (standard)

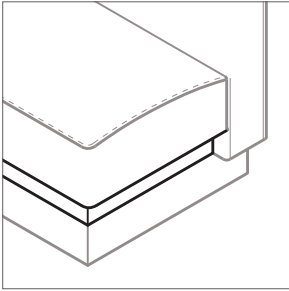

Recessed seat apron



Kickbase and Leg Styles

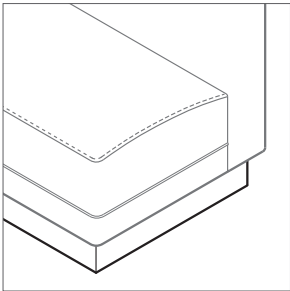

Enclosed kickbase square corners, square or slanted profile (standard)

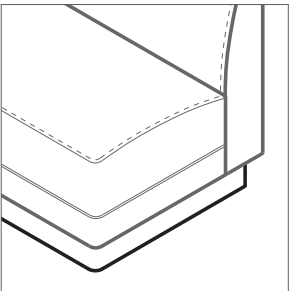

Enclosed kickbase radius corners

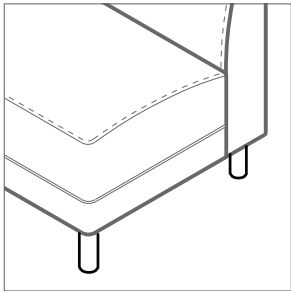

Metal or wooden post legs

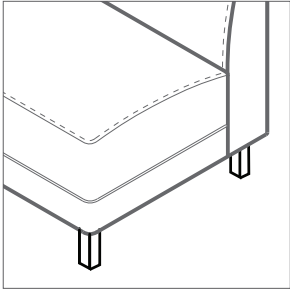

Metal or wooden square post legs

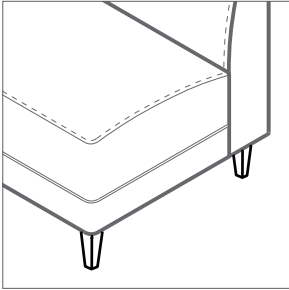

Tapered wooden legs

A recessed kickbase can be used in conjunction with leg supports for additional stability.

Product Specifications | Banquettes

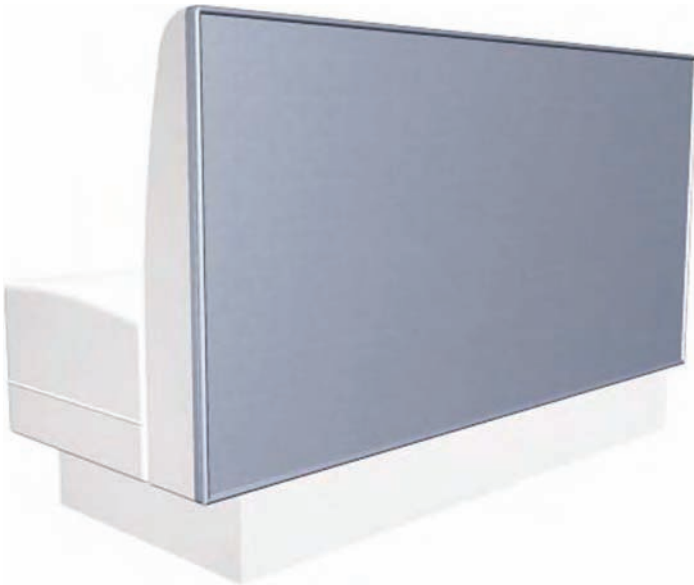

Outside Back Styles

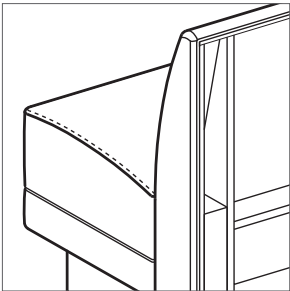

Unfinished (standard)

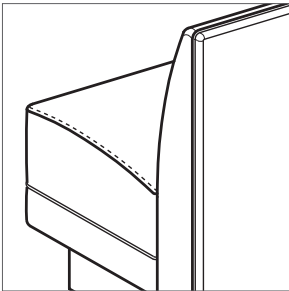

Plain upholstered with welt

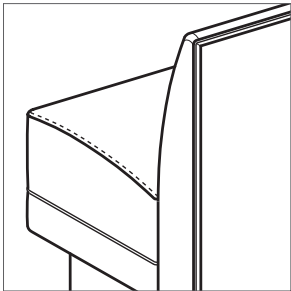

Applied .75" thick self edge plastic laminate or wood veneer back with welt

Product Specifications | Banquette Specification Form

When requesting quotations for banquettes please provide the following information:

Project Name _____

Project Location _____

Requested Delivery Date _____

Contact Information _____

Choose Standard Banquette Configuration (Please See Page 37)

Specify Banquette Design Details & Finishes (Please See Pages 38-43)

Overall Height _____

Inside Back Style _____ Finish _____

End Panel Style _____ Finish _____

Seat Style _____ Finish _____

Apron Style _____ Finish _____

Base Style _____ Finish _____

Outside Back Style _____ Finish _____

Notes _____

*Please submit a floor plan for quantity and dimensions.
For questions, please call customer service at 800-243-3150

To submit your quote request, please e-mail this completed form to: banquette_quotes@westcoastindustries.com

Notes

Pricing

Dining and Multipurpose

48	Alumiline
50	Basic Round
52	Bolt Down
54	Capri
56	Corsica
58	Cozy Bar
60	Disc
68	Dunhill
78	Flat Round
86	Knobhill
88	Manhattan
90	Mark IV
98	Medici
100	Move
102	Parsons
104	Platform
112	Post Leg
120	Presidio
130	Regency
134	Scala
136	Siena
138	Slimline
148	Spacesaver
150	Toscana
152	Tulip
160	Tuscan

Pricing

	Occasional
172	Cube
174	Cylinder
176	Disc
180	Move
182	Parsons
186	Platform
188	Tulip
	Outdoor Tables and Chairs
194	Arc
196	Basic Round
198	Bistro
200	Disc
202	Flat Round
204	Mark IV
206	Park
208	Platform
210	Sam
212	Tulip
215	Chairs
219	Base and Top Matrix
231	Base Only Pricing
241	Top Only Pricing
250	Options



Laminate Tops

Wood Veneer Tops

Self Edge	Vinyl Edges	PVC Edges	Metal Edges	Wood Edges Group A	Wood Edges Group B	Wood Edges Group A	Wood Edges Group B
LLSE Self Edge	LVFL Flat	LPVC PVC	LMFL Flat	LWFL Flat	LWSQ Square	WWFL Flat	WWSQ Square
	LVBP Bumper		LMRB Ribbed	LWTP Tapered Ply	LWAR Arc	WWTP Tapered Ply	WWAR Arc
				LWFP Flat Ply	LWBN Bullnose	WWFP Flat Ply	WWBN Bullnose
					LWPR Prism		WWPR Prism
					LWPI Pivot		WWPI Pivot

Complete Table List Pricing

	Top Size	Base Qty.	Base Style	Model #	\$							
Round 	30	1	X	ALX30RD	609	609	671	704	870	1,051	870	1,138
	36	1	X	ALX36RD	779	779	851	897	1,086	1,296	1,112	1,401
	42	1	X	ALX42RD	880	880	960	960	1,202	1,460	1,296	1,586
	48	1	X	ALX48RD	1,188	1,188	1,279	1,306	1,546	1,842	1,657	1,991
	54	1	X	ALX54RD	1,299	1,299	1,404	1,433	1,762	2,373	1,900	2,587
	60	1	X	ALX60RD	1,476	1,476	1,589	1,643	1,882	2,456	2,241	2,682
Square 	24 24	1	X	ALX2424SQ	549	549	605	659	757	926	767	998
	30 30	1	X	ALX3030SQ	609	609	677	724	870	1,051	870	1,138
	36 36	1	X	ALX3636SQ	779	779	847	916	1,076	1,296	1,112	1,401
	42 42	1	X	ALX4242SQ	868	868	944	993	1,202	1,460	1,296	1,586
	48 48	1	X	ALX4848SQ	1,190	1,190	1,279	1,338	1,546	1,842	1,657	1,991
Rectangle 	24 30	1	X	ALX2430RE	578	578	625	637	818	1,004	899	1,084
	30 36	1	X	ALX3036RE	742	742	787	802	1,024	1,222	1,096	1,318
	30 42	1	X	ALX3042RE	777	777	829	847	1,119	1,341	1,201	1,452
	30 48	1	X	ALX3048RE	814	814	870	890	1,164	1,405	1,255	1,524
	30 60	2	T	ALT3060RE	1,015	1,015	1,079	1,103	1,395	1,671	1,498	1,807
	30 72	2	T	ALT3072RE	1,083	1,083	1,160	1,187	1,471	1,784	1,585	1,934
	36 60	2	T	ALT3660RE	1,080	1,080	1,153	1,177	1,453	1,749	1,564	1,897
	36 72	2	T	ALT3672RE	1,163	1,163	1,240	1,268	1,581	1,916	1,706	2,085

How to Order

Table Model Number					Top Finish Selection		Options
ALX Base Series	36 Top Size	RD Top Shape	WWSQ Top Material Edge Profile	MBK Base Finish	WMW Top Finish	WMW Edge Finish	GSL Super Level Glides

An ALX36RDWWSQMBK is an Alumiline series 36" round table with a black powder coat X-base and a wood veneer 1.25" thick top with a 1.25" square wood edge profile.

The codes: WMW WMW specify a medium walnut top, with a medium walnut edge.

The code: GSL specifies super level glides.

Specialty Tops

Butcher Block	Ultrafoam	Acrylic	Corian Group A,B	Corian Group C,D	3form Chroma
BBFL Flat	ULFP PVC	AAOP Opaque	C1FL Flat	C2FL Flat	3FFL Flat
BBBN Bullnose	ULFR Raw	AATL Translucent	C1BN Bullnose	C2BN Bullnose	3FBN Bullnose
			C1PR Prism	C2PR Prism	3FPR Prism



X Base



T Base

Options

Base Finishes

Standard Powder Coat	use finish code	n/c
Polished or Satin Aluminum (per base)	use finish code	\$152
Custom Powder Coat (set-up charge)	CPC	\$363

Base Options

Alternate Height Base (per column)	AH	\$66
Super Level Glides (per base)	GSL	\$34
Custom Top Plate Size	CTPS	

Top Materials and Finishes

Standard Laminates	use manufacturers finish code	n/c
Premium Laminates	PRL	
Custom Wood Veneer	CWV	
Special Pattern Veneer	SPV	
Stain to Match (set-up charge)	STM	\$412

Top Options

Custom Size	CS	
Custom Shape	CSH	
Custom Radius Corner	CRC	
3" Radius Corner (per corner) (laminates self edge, ultrafoam, Corian®, 3form chroma)	CRL3	\$34
3" Wood Radius Corner (per corner) (not available in LWFL, WWFL, LWPI and WWPI)	CRW3	\$82

Edge Options

1.75" Thick Edge (per table) (see edge details for specific profiles)	175E	15%
--	------	-----

\$

1,160	642	1,617	1,346	1,610	2,663
1,557	822	2,168	1,784	2,142	3,663
2,082	934	2,819	2,175	2,652	4,799
2,562	1,254	3,880	2,824	3,427	6,308
-	1,384	4,983	3,308	4,056	-
-	1,530	6,197	3,859	4,771	-
984	582	1,161	989	1,142	1,630
1,253	642	1,622	1,241	1,469	2,618
1,675	822	2,175	1,666	1,985	3,611
2,267	923	2,827	2,035	2,459	4,735
2,778	1,256	3,890	2,670	3,215	6,247
1,101	601	1,373	1,105	1,288	2,212
1,495	775	1,967	1,471	1,738	3,136
1,740	817	2,210	1,609	1,919	3,574
1,800	860	2,459	1,761	2,113	4,002
2,218	1,072	3,108	2,167	2,605	4,958
2,523	1,151	3,850	2,453	2,974	5,830
2,486	1,146	3,850	2,459	2,978	5,838
2,838	1,241	4,433	2,786	3,404	6,824

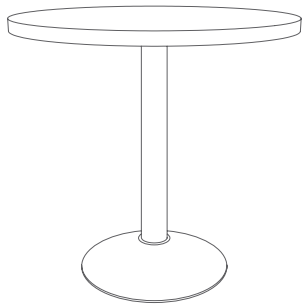

Laminate Tops

Wood Veneer Tops

Self Edge	Vinyl Edges	PVC Edges	Metal Edges	Wood Edges Group A	Wood Edges Group B	Wood Edges Group A	Wood Edges Group B
LLSE Self Edge	LVFL Flat	LPVC PVC	LMFL Flat	LWFL Flat	LWSQ Square	WWFL Flat	WWSQ Square
	LVBP Bumper		LMRB Ribbed	LWTP Tapered Ply	LWAR Arc	WWTP Tapered Ply	WWAR Arc
				LWFP Flat Ply	LWBN Bullnose	WWFP Flat Ply	WWBN Bullnose
					LWPR Prism		WWPR Prism
					LWPI Pivot		WWPI Pivot

Complete Table List Pricing

	Top Size	Base Qty.	Base Style	Model #	\$							
Round 	24	1	17L	BA17L24RD	334	334	384	432	542	711	552	783
	30	1	17M	BA17M30RD	424	424	486	519	685	866	685	953
	36	1	20M	BA20M36RD	534	534	606	652	841	1,051	867	1,156
	42	1	22L	BA22L42RD	630	630	710	710	952	1,210	1,046	1,336
	48	1	22M	BA22M48RD	768	768	859	886	1,126	1,422	1,237	1,571
	54	1	22H	BA22H54RD	914	914	1,019	1,048	1,377	1,988	1,515	2,202
	60	1	28H	BA28H60RD	1,221	1,221	1,334	1,388	1,627	2,201	1,986	2,427
Square 	24 24	1	17L	BA17L2424SQ	334	334	390	444	542	711	552	783
	30 30	1	17M	BA17M3030SQ	424	424	492	539	685	866	685	953
	36 36	1	20M	BA20M3636SQ	534	534	602	671	831	1,051	867	1,156
	42 42	1	22M	BA22M4242SQ	653	653	729	778	987	1,245	1,081	1,371
	48 48	1	22H	BA22H4848SQ	805	805	894	953	1,161	1,457	1,272	1,606
Rectangle 	24 30	1	17M	BA17M2430RE	393	393	452	452	633	819	714	899
	24 36	1	20M	BA20M2436RE	452	452	518	518	726	907	792	995
	24 42	1	22L	BA22L2442RE	480	480	540	540	762	961	832	1,056
	24 48	1	22M	BA22M2448RE	550	550	624	624	869	1,091	949	1,196
	24 60	2	17L	BA17L2460RE	667	667	748	748	1,008	1,261	1,097	1,381
	24 72	2	17L	BA17L2472RE	725	725	819	819	1,105	1,395	1,208	1,533
	30 36	1	20M	BA20M3036RE	497	497	557	557	779	977	851	1,073
	30 42	1	22L	BA22L3042RE	527	527	597	597	869	1,091	951	1,202
	30 48	1	22M	BA22M3048RE	599	599	675	675	949	1,190	1,040	1,309
	30 60	2	17M	BA17M3060RE	795	795	883	883	1,175	1,451	1,278	1,587
	30 72	2	17M	BA17M3072RE	863	863	967	967	1,251	1,564	1,365	1,714
	36 42	1	22M	BA22M3642RE	610	610	688	688	959	1,204	1,052	1,324
	36 48	1	22M	BA22M3648RE	650	650	733	733	1,013	1,274	1,110	1,402
	36 60	2	20M	BA20M3660RE	920	920	1,017	1,017	1,293	1,589	1,404	1,737
	36 72	2	20M	BA20M3672RE	1,003	1,003	1,108	1,108	1,421	1,756	1,546	1,925

How to Order

Table Model Number					Top Finish Selection		Options
BA20M Base Series	36 Top Size	RD Top Shape	WWSQ Top Material	MBK Base Finish	WMW Top Finish	WMW Edge Finish	GSL Super Level Glides

A BA20M36RDWWSQMBK is a Basic Round series 36" round table with a black powder coated, medium weight round base, medium weight base and a wood veneer 1.25" thick top with a 1.25" square wood edge profile.

The codes: WMW WMW specify a medium walnut top, with a medium walnut edge.

The code: GSL specifies super level glides.

Specialty Tops

Butcher Block	Ultrafoam	Acrylic	Corian Group A,B	Corian Group C,D	3form Chroma
BBFL Flat	ULFP PVC	AAOP Opaque	C1FL Flat	C2FL Flat	3FFL Flat
BBBN Bullnose	ULFR Raw	AATL Translucent	C1BN Bullnose	C2BN Bullnose	3FBN Bullnose
			C1PR Prism	C2PR Prism	3FPR Prism

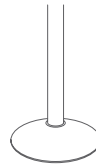

Options

Base Finishes

Standard Black Wrinkle	MWR	n/c
Powder Coat	use finish code	\$110
Polished or Satin Chrome (per base)	use finish code	\$194
Premium Plated (per base)	use finish code	🕒
Custom Powder Coat (set-up charge)	CPC	\$363

Base Options

Alternate Height Base (per column)	AH	\$66
Super Level Glides (per base)	GSL	\$34
Custom Top Plate Size	CTPS	🕒
6" Column (black wrinkle and powder coat)	COL6	\$194
6" Column (polished or satin chrome)	COLP6	\$248
6" Column (premium plated)	COLPP6	🕒
6" Column (veneer)	COLV6	\$386

Top Materials and Finishes

Standard Laminates	use manufacturers finish code	n/c
Premium Laminates	PRL	🕒
Custom Wood Veneer	CWV	🕒
Special Pattern Veneer	SPV	🕒
Stain to Match (set-up charge)	STM	\$412

Top Options

Custom Size	CS	🕒
Custom Shape	CSH	🕒
Custom Radius Corner	CRC	🕒
3" Radius Corner (per corner)	CRL3	\$34
(laminates self edge, ultrafoam, Corian®, 3form chroma)		
3" Wood Radius Corner (per corner)	CRW3	\$82
(not available in LWFL, WWFL, LWPI and WWPI)		

Edge Options

1.75" Thick Edge (per table)	175E	15%
(see edge details for specific profiles)		

\$					
699	353	944	859	1,036	1,448
975	457	1,432	1,161	1,425	2,478
1,312	577	1,923	1,539	1,897	3,418
1,832	684	2,569	1,925	2,402	4,549
2,142	834	3,460	2,404	3,007	5,888
-	999	4,598	2,923	3,671	-
-	1,275	5,942	3,604	4,516	-
769	367	946	774	927	1,415
1,068	457	1,437	1,056	1,284	2,433
1,430	577	1,930	1,421	1,740	3,366
2,052	708	2,612	1,820	2,244	4,520
2,393	871	3,505	2,285	2,830	5,862
916	416	1,188	920	1,103	2,027
1,080	481	1,502	1,063	1,279	2,384
1,269	512	1,622	1,169	1,422	2,715
1,359	587	1,842	1,318	1,606	3,083
1,663	714	-	1,618	1,971	3,850
1,914	782	-	1,857	2,280	4,515
1,250	530	1,722	1,226	1,493	2,891
1,490	567	1,960	1,359	1,669	3,324
1,585	645	2,244	1,546	1,898	3,787
1,998	852	2,888	1,947	2,385	4,738
2,303	931	3,630	2,233	2,754	5,610
1,739	657	-	1,774	1,951	3,956
1,805	706	2,647	2,102	2,186	4,462
2,326	986	3,690	2,299	2,818	5,678
2,678	1,081	4,273	2,626	3,244	6,664

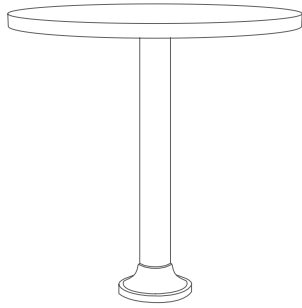

Laminate Tops

Wood Veneer Tops

Self Edge	Vinyl Edges	PVC Edges	Metal Edges	Wood Edges Group A	Wood Edges Group B	Wood Edges Group A	Wood Edges Group B
LLSE Self Edge	LVFL Flat LVBP Bumper	LPVC PVC	LMFL Flat LMRB Ribbed	LWFL Flat LWTP Tapered Ply LWFP Flat Ply	LWSQ Square LWAR Arc LWBN Bullnose LWPR Prism LWPI Pivot	WWFL Flat WWTP Tapered Ply WWFP Flat Ply	WWSQ Square WWAR Arc WWBN Bullnose WWPR Prism WWPI Pivot

Complete Table List Pricing

	Top Size	Base Qty.	Model #	\$							
Round 	24	1	XX24RD	409	409	459	507	617	786	627	858
	30	1	XX30RD	469	469	531	564	730	911	730	998
	36	1	XX36RD	549	549	621	667	856	1,066	882	1,171
	42	1	XX42RD	650	650	730	730	972	1,230	1,066	1,356
	48	1	XX48RD	753	753	844	871	1,111	1,407	1,222	1,556
Square 	24 24	1	XX2424SQ	409	409	465	519	617	786	627	858
	30 30	1	XX3030SQ	469	469	537	584	730	911	730	998
	36 36	1	XX3636SQ	549	549	617	686	846	1,066	882	1,171
	42 42	1	XX4242SQ	638	638	714	763	972	1,230	1,066	1,356
	48 48	1	XX4848SQ	755	755	844	903	1,111	1,407	1,222	1,556
Rectangle 	24 30	1	XX2430RE	438	438	485	497	678	864	759	944
	24 36	1	XX2436RE	467	467	519	533	741	922	807	1,010
	24 42	1	XX2442RE	500	500	545	560	782	981	852	1,076
	24 48	1	XX2448RE	535	535	591	609	854	1,076	934	1,181
	24 60	2	XX2460RE	817	817	877	898	1,158	1,411	1,247	1,531
	24 72	2	XX2472RE	875	875	945	969	1,255	1,545	1,358	1,683
	30 36	1	XX3036RE	512	512	557	572	794	992	866	1,088
	30 42	1	XX3042RE	547	547	599	617	889	1,111	971	1,222
	30 48	1	XX3048RE	584	584	640	660	934	1,175	1,025	1,294
	30 60	2	XX3060RE	885	885	949	973	1,265	1,541	1,368	1,677
	30 72	2	XX3072RE	953	953	1,030	1,057	1,341	1,654	1,455	1,804
	36 42	1	XX3642RE	595	595	654	673	944	1,189	1,037	1,309
	36 48	1	XX3648RE	635	635	697	718	998	1,259	1,095	1,387
	36 60	2	XX3660RE	950	950	1,023	1,047	1,323	1,619	1,434	1,767
	36 72	2	XX3672RE	1,033	1,033	1,110	1,138	1,451	1,786	1,576	1,955

Replace ___ with specific Bolt Down Base Code. Refer to page 53.

How to Order

Table Model Number					Top Finish Selection		Options
BB Base Series	36 Top Size	RD Top Shape	WWSQ Top Material Edge Profile	MBK Base Finish	WMW Top Finish	WMW Edge Finish	AH Alternate Height Base

A BB36RDWWSQMBK is a (Beehive) Bolt Down series 36" round table with a black powder coat bolt down base and a wood veneer 1.25" thick top with a 1.25" square wood edge profile.

The codes: WMW WMW specify a medium walnut top, with a medium walnut edge.

The code: AH specifies alternate height base.

Specialty Tops

Butcher Block	Ultrafoam	Acrylic	Corian Group A,B	Corian Group C,D	3form Chroma
BBFL Flat	ULFP PVC	AAOP Opaque	C1FL Flat	C2FL Flat	3FFL Flat
BBBN Bullnose	ULFR Raw	AATL Translucent	C1BN Bullnose	C2BN Bullnose	3FBN Bullnose
			C1PR Prism	C2PR Prism	3FPR Prism

\$					
774	428	1,019	934	1,111	1,523
1,020	502	1,477	1,206	1,470	2,523
1,327	592	1,938	1,554	1,912	3,433
1,852	704	2,589	1,945	2,422	4,569
2,127	819	3,445	2,389	2,992	5,873
844	442	1,021	849	1,002	1,490
1,113	502	1,482	1,101	1,329	2,478
1,445	592	1,945	1,436	1,755	3,381
2,037	693	2,597	1,805	2,229	4,505
2,343	821	3,455	2,235	2,780	5,812
961	461	1,233	965	1,148	2,072
1,095	496	1,517	1,078	1,294	2,399
1,289	532	1,642	1,189	1,442	2,735
1,344	572	1,827	1,303	1,591	3,068
1,813	864	-	1,768	2,121	4,000
2,064	932	-	2,007	2,430	4,665
1,265	545	1,737	1,241	1,508	2,906
1,510	587	1,980	1,379	1,689	3,344
1,570	630	2,229	1,531	1,883	3,772
2,088	942	2,978	2,037	2,475	4,828
2,393	1,021	3,720	2,323	2,844	5,700
1,724	642	-	1,759	1,936	3,941
1,790	691	2,632	2,087	2,171	4,447
2,356	1,016	3,720	2,329	2,848	5,708
2,708	1,111	4,303	2,656	3,274	6,694

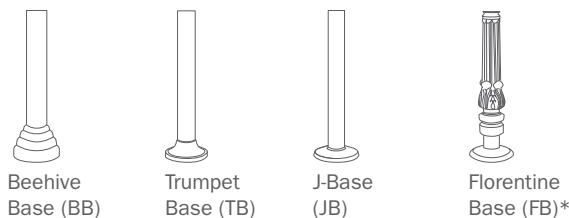

Options

Base Finishes		
Standard Powder Coat	use finish code	n/c
Polished or Satin Chrome (per base)	use finish code	\$59
Premium Plated (per base)	use finish code	Ⓛ
Custom Powder Coat (set-up charge)	CPC	\$363

Base Options		
Alternate Height Base (per column) (BB, TB, JB)	AH	\$66
Alternate Height Base (per column) (FB)	AH	\$166

Custom Top Plate Size	CTPS	Ⓛ
-----------------------	------	---

Top Materials and Finishes		
Standard Laminates	use manufacturers finish code	n/c
Premium Laminates	PRL	Ⓛ
Custom Wood Veneer	CWV	Ⓛ
Special Pattern Veneer	SPV	Ⓛ
Stain to Match (set-up charge)	STM	\$412

Top Options		
Custom Size	CS	Ⓛ
Custom Shape	CSH	Ⓛ
Custom Radius Corner	CRC	Ⓛ
3" Radius Corner (per corner)	CRL3	\$34
(laminate self edge, ultrafoam, Corian®, 3form chroma)		
3" Wood Radius Corner (per corner)	CRW3	\$82
(not available in LWFL, WWFL, LWPI and WWPI)		

Edge Options		
1.75" Thick Edge (per table)	175E	15%
<i>(see edge details for specific profiles)</i>		

*Florentine Bolt Down base design (Code FB) add \$166 to current published prices.

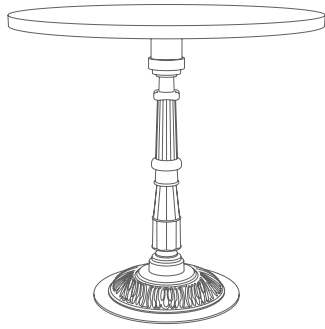

Laminate Tops

Wood Veneer Tops

Self Edge	Vinyl Edges	PVC Edges	Metal Edges	Wood Edges Group A	Wood Edges Group B	Wood Edges Group A	Wood Edges Group B
LLSE Self Edge	LVFL Flat	LPVC PVC	LMFL Flat	LWFL Flat	LWSQ Square	WWFL Flat	WWSQ Square
	LVBP Bumper		LMRB Ribbed	LWTP Tapered Ply	LWAR Arc	WWTP Tapered Ply	WWAR Arc
				LWFP Flat Ply	LWBN Bullnose	WWFP Flat Ply	WWBN Bullnose
					LWPR Prism		WWPR Prism
					LWPI Pivot		WWPI Pivot















Complete Table List Pricing

	Top Size	Base Qty.	Model #	\$							
Round	24	1	CA24RD	506	506	556	604	714	883	724	955
	30	1	CA30RD	566	566	628	661	827	1,008	827	1,095
Square	24 24	1	CA2424SQ	506	506	562	616	714	883	724	955
	30 30	1	CA3030SQ	566	566	634	681	827	1,008	827	1,095
Rectangle	24 30	1	CA2430RE	535	535	582	594	776	961	856	1,042

How to Order

Table Model Number					Top Finish Selection		Options
CA Base Series	36 Top Size	RD Top Shape	WWSQ Top Material Edge Profile	MBK Base Finish	WMW Top Finish	WMW Edge Finish	GSL Super Level Glides
A CA36RDWWSQMBK is a Capri series 36" round table with a black powder coat round base and a wood veneer 1.25" thick top with a 1.25" square wood edge profile.					The codes: WMW WMW specify a medium walnut top, with a medium walnut edge.		The code: GSL specifies super level glides.

Specialty Tops

Butcher Block	Ultrafoam	Acrylic	Corian Group A,B	Corian Group C,D	3form Chroma
 BBFL Flat	 ULFP PVC	 AAOP Opaque	 C1FL Flat	 C2FL Flat	 3FFL Flat
 BBBN Bullnose	 ULFR Raw	 AATL Translucent	 C1BN Bullnose	 C2BN Bullnose	 3FBN Bullnose
			 C1PR Prism	 C2PR Prism	 3FPR Prism

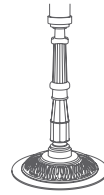

Options

Base Finishes

Standard Powder Coat	use finish code	n/c
Custom Powder Coat (set-up charge)	CPC	\$363

Base Options

Alternate Height Base (per column)	AH	\$166
Super Level Glides (per base)	GSL	\$34
Custom Top Plate Size	CTPS	🕒

Top Materials and Finishes

Standard Laminates	use manufacturers finish code	n/c
Premium Laminates	PRL	🕒
Custom Wood Veneer	CWV	🕒
Special Pattern Veneer	SPV	🕒
Stain to Match (set-up charge)	STM	\$412

Top Options

Custom Size	CS	🕒
Custom Shape	CSH	🕒
Custom Radius Corner	CRC	🕒
3" Radius Corner (per corner)	CRL3	\$34
(laminates self edge, ultrafoam, Corian®, 3form chroma)		
3" Wood Radius Corner (per corner)	CRW3	\$82
(not available in LWFL, WWFL, LWPI and WWPI)		

Edge Options

1.75" Thick Edge (per table)	175E	15%
<i>(see edge details for specific profiles)</i>		

\$						
	871	525	1,116	1,031	1,208	1,620
	1,117	599	1,575	1,303	1,567	2,620

	941	539	1,118	946	1,099	1,587
	1,210	599	1,579	1,198	1,426	2,575

	1,058	558	1,330	1,062	1,245	2,169
--	-------	-----	-------	-------	-------	-------

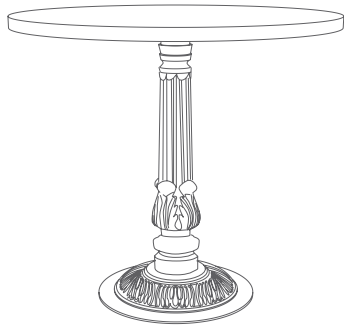

Laminate Tops

Wood Veneer Tops

Self Edge	Vinyl Edges	PVC Edges	Metal Edges	Wood Edges Group A	Wood Edges Group B	Wood Edges Group A	Wood Edges Group B
LLSE Self Edge	LVFL Flat	LPVC PVC	LMFL Flat	LWFL Flat	LWSQ Square	WWFL Flat	WWSQ Square
	LVBP Bumper		LMRB Ribbed	LWTP Tapered Ply	LWAR Arc	WWTP Tapered Ply	WWAR Arc
				LWFP Flat Ply	LWBN Bullnose	WWFP Flat Ply	WWBN Bullnose
					LWPR Prism		WWPR Prism
					LWPI Pivot		WWPI Pivot

Complete Table List Pricing

	Top Size	Base Qty.	Model #	\$							
Round	24	1	CR24RD	672	672	722	770	880	1,049	890	1,121
	30	1	CR30RD	732	732	794	827	993	1,174	993	1,261
	36	1	CR36RD	957	957	1,029	1,075	1,264	1,474	1,290	1,579
	42	1	CR42RD	1,058	1,058	1,138	1,138	1,380	1,638	1,474	1,764
	48	1	CR48RD	1,161	1,161	1,251	1,279	1,519	1,815	1,630	1,964
	54	1	CR54RD	1,272	1,272	1,377	1,406	1,735	2,346	1,873	2,560
	60	1	CR60RD	1,449	1,449	1,562	1,616	1,854	2,429	2,214	2,655
Square	24 24	1	CR2424SQ	672	672	728	782	880	1,049	890	1,121
	30 30	1	CR3030SQ	732	732	800	847	993	1,174	993	1,261
	36 36	1	CR3636SQ	957	957	1,025	1,094	1,254	1,474	1,290	1,579
	42 42	1	CR4242SQ	1,046	1,046	1,122	1,171	1,380	1,638	1,474	1,764
	48 48	1	CR4848SQ	1,163	1,163	1,251	1,310	1,519	1,815	1,630	1,964
Rectangle	24 30	1	CR2430RE	701	701	748	760	941	1,127	1,022	1,207
	24 36	1	CR2436RE	875	875	927	941	1,149	1,330	1,214	1,418
	24 42	1	CR2442RE	908	908	953	967	1,190	1,389	1,260	1,484
	24 48	1	CR2448RE	943	943	999	1,017	1,262	1,484	1,342	1,589
	30 36	1	CR3036RE	920	920	964	980	1,202	1,400	1,274	1,496
	30 42	1	CR3042RE	955	955	1,007	1,025	1,297	1,519	1,379	1,630
	30 48	1	CR3048RE	992	992	1,048	1,068	1,342	1,583	1,433	1,702
	36 42	1	CR3642RE	1,002	1,002	1,062	1,081	1,352	1,597	1,445	1,717
	36 48	1	CR3648RE	1,043	1,043	1,105	1,126	1,406	1,667	1,503	1,795

How to Order

Table Model Number				Top Finish Selection		Options	
CR Base Series	36 Top Size	RD Top Shape	WWSQ Top Material Edge Profile	MBK Base Finish	WMW Top Finish	WMW Edge Finish	GSL Super Level Glides

A CR36RDWWSQMBK is a Corsica series 36" round table with a black powder coat round base and a wood veneer 1.25" thick top with a 1.25" square wood edge profile.

The codes: WMW WMW specify a medium walnut top, with a medium walnut edge.

The code: GSL specifies super level glides.

Specialty Tops

Butcher Block	Ultrafoam	Acrylic	Corian Group A,B	Corian Group C,D	3form Chroma
BBFL Flat	ULFP PVC	AAOP Opaque	C1FL Flat	C2FL Flat	3FFL Flat
BBBN Bullnose	ULFR Raw	AATL Translucent	C1BN Bullnose	C2BN Bullnose	3FBN Bullnose
			C1PR Prism	C2PR Prism	3FPR Prism

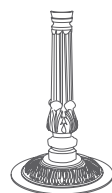

Options

Base Finishes		
Standard Powder Coat	use finish code	n/c
Custom Powder Coat (set-up charge)	CPC	\$363

Base Options		
Alternate Height Base (per column)	AH	\$166
Super Level Glides (per base)	GSL	\$34
Custom Top Plate Size	CTPS	🕒

Top Materials and Finishes		
Standard Laminates	use manufacturers finish code	n/c
Premium Laminates	PRL	🕒
Custom Wood Veneer	CWV	🕒
Special Pattern Veneer	SPV	🕒
Stain to Match (set-up charge)	STM	\$412

Top Options		
Custom Size	CS	🕒
Custom Shape	CSH	🕒
Custom Radius Corner	CRC	🕒
3" Radius Corner (per corner)	CRL3	\$34
(laminate self edge, ultrafoam, Corian®, 3form chroma)		
3" Wood Radius Corner (per corner)	CRW3	\$82
(not available in LWFL, WWFL, LWPI and WWPI)		

Edge Options		
1.75" Thick Edge (per table)	175E	15%
(see edge details for specific profiles)		

\$					
1,037	691	1,282	1,197	1,374	1,786
1,283	765	1,740	1,469	1,733	2,786
1,735	1,000	2,346	1,961	2,320	3,840
2,260	1,112	2,997	2,353	2,829	4,976
2,535	1,227	3,853	2,797	3,400	6,281
-	1,357	4,956	3,281	4,029	-
-	1,503	6,170	3,832	4,744	-
1,107	705	1,284	1,112	1,265	1,753
1,376	765	1,745	1,364	1,592	2,741
1,853	1,000	2,353	1,844	2,163	3,789
2,445	1,101	3,005	2,213	2,637	4,913
2,751	1,229	3,863	2,643	3,188	6,219
1,224	724	1,496	1,228	1,411	2,335
1,503	904	1,924	1,486	1,702	2,807
1,696	940	2,050	1,597	1,850	3,143
1,752	980	2,235	1,710	1,999	3,476
1,673	953	2,145	1,649	1,916	3,314
1,918	995	2,387	1,787	2,097	3,752
1,978	1,037	2,637	1,939	2,291	4,180
2,132	1,050	-	2,167	2,344	4,349
2,198	1,099	3,040	2,494	2,579	4,855

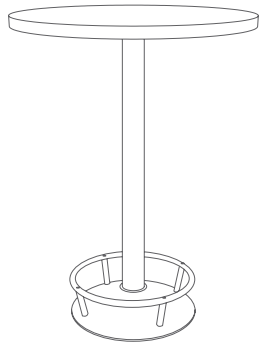

Laminate Tops

Wood Veneer Tops

Self Edge	Vinyl Edges	PVC Edges	Metal Edges	Wood Edges Group A	Wood Edges Group B	Wood Edges Group A	Wood Edges Group B
LLSE Self Edge	LVFL Flat	LPVC PVC	LMFL Flat	LWFL Flat	LWSQ Square	WWFL Flat	WWSQ Square
	LVBP Bumper		LMRB Ribbed	LWTP Tapered Ply	LWAR Arc	WWTP Tapered Ply	WWAR Arc
				LWFP Flat Ply	LWBN Bullnose	WWFP Flat Ply	WWBN Bullnose
					LWPR Prism		WWPR Prism
					LWPI Pivot		WWPI Pivot















Complete Table List Pricing

	Top Size	Base Qty.	Overall Table Height	Model #	\$							
Round	24	1	42	CB24RD	679	679	729	777	887	1,056	897	1,128
	30	1	42	CB30RD	739	739	801	834	1,000	1,181	1,000	1,268
	36	1	42	CB36RD	879	879	951	997	1,186	1,396	1,212	1,501
	42	1	42	CB42RD	1,075	1,075	1,155	1,155	1,397	1,655	1,491	1,781
	48	1	42	CB48RD	1,178	1,178	1,269	1,296	1,536	1,832	1,647	1,981

How to Order

Table Model Number					Top Finish Selection		Options
CB Base Series	36 Top Size	RD Top Shape	WWSQ Top Material	MBK Base Finish	WMW Top Finish	WMW Edge Finish	GSL Super Level Glides
A CB36RDWWSQMBK is a Cozy Bar series 36" round table with a black powder coat round base and a wood veneer 1.25" thick top with a 1.25" square wood edge profile.					The codes: WMW WMW specify a medium walnut top, with a medium walnut edge.		The code: GSL specifies super level glides.

Specialty Tops

Butcher Block	Ultrafoam	Acrylic	Corian Group A,B	Corian Group C,D	3form Chroma
 BBFL Flat	 ULFP PVC	 AAOP Opaque	 C1FL Flat	 C2FL Flat	 3FFL Flat
 BBBN Bullnose	 ULFR Raw	 AATL Translucent	 C1BN Bullnose	 C2BN Bullnose	 3FBN Bullnose
			 C1PR Prism	 C2PR Prism	 3FPR Prism

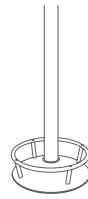

\$					
1,044	698	1,289	1,204	1,381	1,793
1,290	772	1,747	1,476	1,740	2,793
1,657	922	2,268	1,884	2,242	3,763
2,277	1,129	3,014	2,370	2,847	4,994
2,552	1,244	3,870	2,814	3,417	6,298

Options

Base Finishes

Standard Black Wrinkle	MWR	n/c
Powder Coat	use finish code	\$152
Polished or Satin Chrome (per base)	use finish code	\$273
Premium Plated (per base)	use finish code	Ⓛ
Custom Powder Coat (set-up charge)	CPC	\$363
Footring Finish: Polished or Satin Chrome	use finish code	n/c

Base Options

Alternate Height Base (per column)	AH	\$66
Super Level Glides (per base)	GSL	\$34
Custom Top Plate Size	CTPS	Ⓛ

Top Materials and Finishes

Standard Laminates	use manufacturers finish code	n/c
Premium Laminates	PRL	Ⓛ
Custom Wood Veneer	CWV	Ⓛ
Special Pattern Veneer	SPV	Ⓛ
Stain to Match (set-up charge)	STM	\$412

Top Options

Custom Size	CS	Ⓛ
Custom Shape	CSH	Ⓛ
Custom Radius Corner	CRC	Ⓛ
3" Radius Corner (per corner)	CRL3	\$34
(laminate self edge, ultrafoam, Corian®, 3form chroma)		
3" Wood Radius Corner (per corner)	CRW3	\$82
(not available in LWFL, WWFL, LWPI and WWPI)		

Edge Options

1.75" Thick Edge (per table)	175E	15%
<i>(see edge details for specific profiles)</i>		

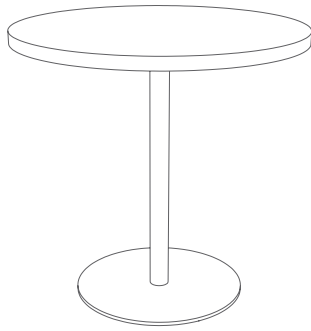

Laminate Tops

Wood Veneer Tops

Self Edge	Vinyl Edges	PVC Edges	Metal Edges	Wood Edges Group A	Wood Edges Group B	Wood Edges Group A	Wood Edges Group B
LLSE Self Edge	LVFL Flat	LPVC PVC	LMFL Flat	LWFL Flat	LWSQ Square	WWFL Flat	WWSQ Square
	LVBP Bumper		LMRB Ribbed	LWTP Tapered Ply	LWAR Arc	WWTP Tapered Ply	WWAR Arc
				LWFP Flat Ply	LWBN Bullnose	WWFP Flat Ply	WWBN Bullnose
					LWPR Prism		WWPR Prism
					LWPI Pivot		WWPI Pivot

Complete Table List Pricing

	Top Size	Base Qty.	Model #	\$								
Round	24	1	DI24RD	624	624	674	722	832	1,001	842	1,073	
	30	1	DI30RD	684	684	746	779	945	1,126	945	1,213	
	36	1	DI36RD	924	924	996	1,042	1,231	1,441	1,257	1,546	
	42	1	DI42RD	1,025	1,025	1,105	1,105	1,347	1,605	1,441	1,731	
	48	1	DI48RD	1,253	1,253	1,344	1,371	1,611	1,907	1,722	2,056	
	54	1	DI54RD	1,364	1,364	1,469	1,498	1,827	2,438	1,965	2,652	
	60	1	DI60RD	1,541	1,541	1,654	1,708	1,947	2,521	2,306	2,747	
Oval	36	72	2	DI3672OV	1,494	1,494	1,545	1,570	1,753	1,975	1,926	2,142
	42	54	2	DI4254OV	1,471	1,471	1,498	1,562	1,703	2,030	1,854	2,090
	42	78	2	DI4278OV	2,083	2,083	2,124	2,169	2,317	2,538	2,460	2,707
	42	84	2	DI4284OV	2,139	2,139	2,193	2,237	2,367	2,618	2,513	2,797
	48	78	2	DI4878OV	2,424	2,424	2,481	2,527	2,650	2,899	2,802	3,082
	48	96	2	DI4896OV	2,600	2,600	2,656	2,706	2,798	3,070	3,160	3,477
Racetrack	30	60	2	DI3060RA	1,327	1,327	1,385	1,407	1,697	1,975	1,798	2,143
	30	72	2	DI3072RA	1,395	1,395	1,467	1,492	1,771	2,115	1,884	2,247
	30	84	2	DI3084RA	1,625	1,625	1,689	1,730	1,868	2,354	1,994	2,551
	30	96	2	DI3096RA	1,695	1,695	1,767	1,811	1,962	2,568	2,092	2,755
	36	60	2	DI3660RA	1,713	1,713	1,781	1,803	2,073	2,380	2,184	2,540
	36	72	2	DI3672RA	1,793	1,793	1,872	1,897	2,205	2,548	2,332	2,719
	36	84	2	DI3684RA	2,030	2,030	2,109	2,151	2,305	2,775	2,449	2,999
	36	96	2	DI3696RA	2,110	2,110	2,203	2,244	2,412	3,001	2,567	3,178
	42	72	2	DI4272RA	1,877	1,877	1,951	1,982	2,266	2,661	2,337	2,945
	42	84	2	DI4284RA	2,131	2,131	2,198	2,242	2,365	2,916	2,511	3,236
	42	96	2	DI4296RA	2,227	2,227	2,296	2,345	2,488	3,114	2,651	3,511

Continued on next page

How to Order

Table Model Number					Top Finish Selection		Options
DI Base Series	36 Top Size	RD Top Shape	WWSQ Top Material Edge Profile	MBK Base Finish	WMW Top Finish	WMW Edge Finish	AH Alternate Height Base

A DI36RDWWSQMBK is a Disc series 36" round table with a black powder coat round base and a wood veneer 1.25" thick top with a 1.25" square wood edge profile.

The codes: WMW WMW specify a medium walnut top, with a medium walnut edge.

The code: AH specifies alternate height base.

Specialty Tops

Butcher Block	Ultrafoam	Acrylic	Corian Group A,B	Corian Group C,D	3form Chroma
BBFL Flat	ULFP PVC	AAOP Opaque	C1FL Flat	C2FL Flat	3FFL Flat
BBBN Bullnose	ULFR Raw	AATL Translucent	C1BN Bullnose	C2BN Bullnose	3FBN Bullnose
			C1PR Prism	C2PR Prism	3FPR Prism

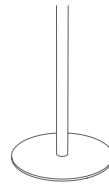

\$						
989	643	1,234	1,149	1,326	1,738	
1,235	717	1,692	1,421	1,685	2,738	
1,702	967	2,313	1,929	2,287	3,808	
2,227	1,079	2,964	2,320	2,797	4,944	
2,627	1,319	3,945	2,889	3,492	6,373	
-	1,449	5,048	3,373	4,121	-	
-	1,595	6,262	3,924	4,836	-	
-	-	-	-	-	-	
-	-	4,307	-	-	-	
-	-	6,014	-	-	-	
-	-	-	-	-	-	
-	-	7,042	-	-	-	
-	-	-	-	-	-	
-	-	-	-	-	-	
-	-	-	-	-	-	
-	-	-	-	-	-	
-	-	-	-	-	-	
-	-	-	-	-	-	
-	-	-	-	-	-	
-	-	-	-	-	-	
-	-	-	-	-	-	
-	-	-	-	-	-	
-	-	-	-	-	-	
-	-	-	-	-	-	
-	-	-	-	-	-	
-	-	-	-	-	-	
-	-	-	-	-	-	
-	-	-	-	-	-	
-	-	-	-	-	-	
-	-	-	-	-	-	
-	-	-	-	-	-	
-	-	-	-	-	-	
-	-	-	-	-	-	

Options

Base Finishes		
Standard Powder Coat	use finish code	n/c
Polished or Satin Chrome (per base)	use finish code	\$213
Premium Plated (per base)	use finish code	Ⓛ
Custom Powder Coat (set-up charge)	CPC	\$363

Base Options		
Alternate Height Base (per column)	AH	\$66
Nylon Octagon Glides (per base)	GNO	\$34
Custom Top Plate Size	CTPS	Ⓛ
6" Column (black wrinkle and powder coat)	COL6	\$194
6" Column (polished or satin chrome)	COLP6	\$248
6" Column (premium plated)	COLPP6	Ⓛ
6" Column (veneer)	COLV6	\$386

Top Materials and Finishes		
Standard Laminates	use manufacturers finish code	n/c
Premium Laminates	PL	Ⓛ
Custom Wood Veneer	CWV	Ⓛ
Special Pattern Veneer	SPV	Ⓛ
Stain to Match (set-up charge)	STM	\$412

Top Options		
Custom Size	CS	Ⓛ
Custom Shape	CSH	Ⓛ
Custom Radius Corner	CRC	Ⓛ
3" Radius Corner (per corner)	CRL3	\$34
(laminated self edge, ultrafoam, Corian®, 3form chroma)		
3" Wood Radius Corner (per corner)	CRW3	\$82
(not available in LWFL, WWFL, LWPI and WWPI)		

Grommets		
2" Round Metal Grommet - Matte Black	GMBK	\$138
2" Round Metal Grommet - Satin Chrome	GMSC	\$138
2" Round Metal Grommet - Polished Chrome	GMPC	\$138
2" Round Plastic Grommet - Matte Black	GPMBK	\$44
Grommet location	use location code	n/c

Edge Options		
1.75" Thick Edge (per table)	175E	15%
<i>(see edge details for specific profiles)</i>		

Laminate Tops

Wood Veneer Tops

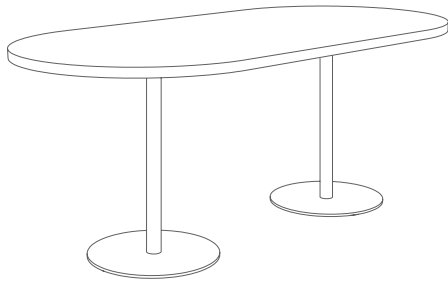

Self Edge	Vinyl Edges	PVC Edges	Metal Edges	Wood Edges Group A	Wood Edges Group B	Wood Edges Group A	Wood Edges Group B
LLSE Self Edge	LVFL Flat LVBP Bumper	LPVC PVC	LMFL Flat LMRB Ribbed	LWFL Flat LWTP Tapered Ply LWFP Flat Ply	LWSQ Square LWAR Arc LWBN Bullnose LWPR Prism LWPI Pivot	WWFL Flat WWTP Tapered Ply WWFP Flat Ply	WWSQ Square WWAR Arc WWBN Bullnose WWPR Prism WWPI Pivot

Complete Table List Pricing

	Top Size	Base Qty.	Model #	\$							
	48 96	2	DI4896RA	2,580	2,580	2,660	2,710	2,940	3,591	3,309	3,817
	48 120	2	DI48120RA	2,792	2,792	2,893	2,955	3,183	3,930	3,613	4,270
	48 144	3	DI48144RA	3,775	3,775	3,890	3,967	4,208	5,018	4,720	5,443
	48 168	3	DI48168RA	3,990	3,990	4,113	4,200	4,459	5,387	5,035	5,869
	60 120	2	DI60120RA	3,064	3,064	3,173	3,249	3,364	4,270	3,813	4,667
	60 144	3	DI60144RA	4,099	4,099	4,200	4,292	4,547	5,387	4,879	5,856
	60 168	3	DI60168RA	4,364	4,364	4,475	4,580	4,841	5,782	5,513	6,632
		24 24	1	DI2424SQ	624	624	680	734	832	1,001	842
30 30		1	DI3030SQ	684	684	752	799	945	1,126	945	1,213
36 36		1	DI3636SQ	924	924	992	1,061	1,221	1,441	1,257	1,546
42 42		1	DI4242SQ	1,013	1,013	1,089	1,138	1,347	1,605	1,441	1,731
48 48		1	DI4848SQ	1,255	1,255	1,344	1,403	1,611	1,907	1,722	2,056
	24 30	1	DI2430RE	653	653	700	712	893	1,079	974	1,159
	24 36	1	DI2436RE	842	842	894	908	1,116	1,297	1,182	1,385
	24 42	1	DI2442RE	875	875	920	935	1,157	1,356	1,227	1,451
	24 48	1	DI2448RE	910	910	966	984	1,229	1,451	1,309	1,556
	24 60	2	DI2460RE	1,247	1,247	1,307	1,328	1,588	1,841	1,677	1,961
	24 72	2	DI2472RE	1,305	1,305	1,375	1,399	1,685	1,975	1,788	2,113
	24 84	2	DI2484RE	1,522	1,522	1,587	1,627	1,767	2,255	1,880	2,430
	24 96	2	DI2496RE	1,580	1,580	1,651	1,695	1,849	2,376	1,971	2,566
	30 36	1	DI3036RE	887	887	932	947	1,169	1,367	1,241	1,463
	30 42	1	DI3042RE	922	922	974	992	1,264	1,486	1,346	1,597
	30 48	1	DI3048RE	1,084	1,084	1,140	1,160	1,434	1,675	1,525	1,794
	30 60	2	DI3060RE	1,315	1,315	1,379	1,403	1,695	1,971	1,798	2,107
	30 72	2	DI3072RE	1,383	1,383	1,460	1,487	1,771	2,084	1,885	2,234
	30 84	2	DI3084RE	1,615	1,615	1,681	1,726	1,866	2,354	1,989	2,537
	30 96	2	DI3096RE	1,685	1,685	1,758	1,806	1,961	2,527	2,097	2,732

Continued on next page

How to Order

Table Model Number					Top Finish Selection		Options	
DI Base Series	4896 Top Size	RA Top Shape	WWSQ Top Material Edge Profile	MBK Base Finish	WMW Top Finish	WMW Edge Finish	GMBK Matte Black Grommet	E Location "E"

A DI4896RAWWSQMBK is a Disc series 48" x 96" racetrack table with two black powder coat round bases and a wood veneer 1.25" thick top with a 1.25" square wood edge profile.

The codes: WMW WMW specify a medium walnut top, with a medium walnut edge.

The code: GMBK specifies a matte black 2" diameter metal grommet.

The code: E specifies the location of the grommet.

Specialty Tops

Butcher Block	Ultrafoam	Acrylic	Corian Group A,B	Corian Group C,D	3form Chroma
BBFL Flat	ULFP PVC	AAOP Opaque	C1FL Flat	C2FL Flat	3FFL Flat
BBBN Bullnose	ULFR Raw	AATL Translucent	C1BN Bullnose	C2BN Bullnose	3FBN Bullnose
			C1PR Prism	C2PR Prism	3FPR Prism

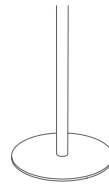

\$					
-	-	-	-	-	-
-	-	-	-	-	-
-	-	-	-	-	-
-	-	-	-	-	-
-	-	-	-	-	-
-	-	-	-	-	-
-	-	-	-	-	-
-	-	-	-	-	-
-	-	-	-	-	-
-	-	-	-	-	-
1,059	657	1,236	1,064	1,217	1,705
1,328	717	1,697	1,316	1,544	2,693
1,820	967	2,320	1,811	2,130	3,756
2,412	1,068	2,972	2,180	2,604	4,880
2,843	1,321	3,955	2,735	3,280	6,312
-	-	-	-	-	-
1,176	676	1,448	1,180	1,363	2,287
1,470	871	1,892	1,453	1,669	2,774
1,664	907	2,017	1,564	1,817	3,110
1,719	947	2,202	1,678	1,966	3,443
2,243	1,294	-	2,198	2,551	4,430
2,494	1,362	-	2,437	2,860	5,095
2,677	1,554	-	-	-	-
2,860	1,622	-	-	-	-
-	-	-	-	-	-
1,640	920	2,112	1,616	1,883	3,281
1,885	962	2,355	1,754	2,064	3,719
2,070	1,130	2,729	2,031	2,383	4,272
2,518	1,372	3,408	2,467	2,905	5,258
2,823	1,451	4,150	2,753	3,274	6,130
3,006	1,656	-	-	-	-
3,189	1,738	-	-	-	-

Options

Base Finishes

Standard Powder Coat	use finish code	n/c
Polished or Satin Chrome (per base)	use finish code	\$213
Premium Plated (per base)	use finish code	<input type="radio"/>
Custom Powder Coat (set-up charge)	CPC	\$363

Base Options

Alternate Height Base (per column)	AH	\$66
Nylon Octagon Glides (per base)	GNO	\$34
Custom Top Plate Size	CTPS	<input type="radio"/>
6" Column (black wrinkle and powder coat)	COL6	\$194
6" Column (polished or satin chrome)	COLP6	\$248
6" Column (premium plated)	COLPP6	<input type="radio"/>
6" Column (veneer)	COLV6	\$386

Top Materials and Finishes

Standard Laminates	use manufacturers finish code	n/c
Premium Laminates	PL	<input type="radio"/>
Custom Wood Veneer	CWV	<input type="radio"/>
Special Pattern Veneer	SPV	<input type="radio"/>
Stain to Match (set-up charge)	STM	\$412

Top Options

Custom Size	CS	<input type="radio"/>
Custom Shape	CSH	<input type="radio"/>
Custom Radius Corner	CRC	<input type="radio"/>
3" Radius Corner (per corner)	CRL3	\$34
(laminated self edge, ultrafoam, Corian®, 3form chroma)		
3" Wood Radius Corner (per corner)	CRW3	\$82
(not available in LWFL, WWFL, LWPI and WWPI)		

Grommets

2" Round Metal Grommet - Matte Black	GMBK	\$138
2" Round Metal Grommet - Satin Chrome	GMSC	\$138
2" Round Metal Grommet - Polished Chrome	GMPC	\$138
2" Round Plastic Grommet - Matte Black	GPMBK	\$44
Grommet location	use location code	n/c

Edge Options

1.75" Thick Edge (per table)	175E	15%
<i>(see edge details for specific profiles)</i>		



Laminate Tops

Wood Veneer Tops

Self Edge	Vinyl Edges	PVC Edges	Metal Edges	Wood Edges Group A	Wood Edges Group B	Wood Edges Group A	Wood Edges Group B
LLSE Self Edge	LVFL Flat	LPVC PVC	LMFL Flat	LWFL Flat	LWSQ Square	WWFL Flat	WWSQ Square
	LVBP Bumper		LMRB Ribbed	LWTP Tapered Ply	LWAR Arc	WWTP Tapered Ply	WWAR Arc
				LWFP Flat Ply	LWBN Bullnose	WWFP Flat Ply	WWBN Bullnose
					LWPR Prism		WWPR Prism
					LWPI Pivot		WWPI Pivot

Complete Table List Pricing

	Top Size	Base Qty.	Model #	\$							
Rectangle	36 42	1	DI3642RE	970	970	1,029	1,048	1,319	1,564	1,412	1,684
	36 48	1	DI3648RE	1,135	1,135	1,197	1,218	1,498	1,759	1,595	1,887
	36 60	2	DI3660RE	1,700	1,700	1,773	1,797	2,073	2,369	2,184	2,517
	36 72	2	DI3672RE	1,783	1,783	1,860	1,888	2,201	2,536	2,326	2,705
	36 84	2	DI3684RE	2,028	2,028	2,097	2,143	2,305	2,771	2,445	2,968
	36 96	2	DI3696RE	2,110	2,110	2,193	2,237	2,410	2,945	2,563	3,164
	42 72	2	DI4272RE	2,117	2,117	2,182	2,215	2,516	2,911	2,587	3,004
	42 84	2	DI4284RE	2,373	2,373	2,443	2,492	2,630	3,138	2,866	3,451
	42 96	2	DI4296RE	2,467	2,467	2,544	2,597	2,751	3,364	3,008	3,494
	48 96	2	DI4896RE	2,578	2,578	2,653	2,708	2,936	3,591	3,309	3,796
48 120	2	DI48120RE	2,790	2,790	2,888	2,955	3,179	3,817	3,613	4,101	
48 144	3	DI48144RE	3,755	3,755	3,850	3,930	4,175	4,821	4,677	5,212	
48 168	3	DI48168RE	3,983	3,983	4,083	4,175	4,406	5,103	4,967	5,538	
60 120	2	DI60120RE	3,051	3,051	3,143	3,224	3,399	4,043	3,817	4,441	
60 144	3	DI60144RE	4,051	4,051	4,154	4,251	4,518	5,103	5,107	5,629	
60 168	3	DI60168RE	4,360	4,360	4,433	4,545	4,801	5,727	5,461	6,406	
Arc Rectangle	30 60	2	DI3060AR	1,328	1,328	1,383	1,405	1,662	1,975	1,798	2,119
	30 72	2	DI3072AR	1,419	1,419	1,469	1,494	1,776	2,173	1,884	2,247
	30 84	2	DI3084AR	1,597	1,597	1,678	1,718	1,866	2,315	1,992	2,551
	30 96	2	DI3096AR	1,670	1,670	1,757	1,800	1,975	2,512	2,092	2,755
	36 60	2	DI3660AR	1,733	1,733	1,775	1,797	2,073	2,435	2,184	2,540
	36 72	2	DI3672AR	1,836	1,836	1,884	1,910	2,198	2,606	2,326	2,719
	36 84	2	DI3684AR	2,015	2,015	2,100	2,141	2,305	2,775	2,445	2,974
	36 96	2	DI3696AR	2,100	2,100	2,193	2,233	2,412	3,029	2,567	3,178

Continued on next page

How to Order

Table Model Number					Top Finish Selection		Options	
DI Base Series	3642 Top Size	RE Top Shape	WWSQ Top Material Edge Profile	MBK Base Finish	WMW Top Finish	WMW Edge Finish	GMBK Matte Black Grommet	E Location "E"
A DI3642REWWSQMBK is a Disc series 36" x 42" rectangle table with a black powder coat round base and a wood veneer 1.25" thick top with a 1.25" square wood edge profile.					The codes: WMW WMW specify a medium walnut top, with a medium walnut edge.		The code: GMBK specifies a matte black 2" diameter metal grommet.	
							The code: E specifies the location of the grommet.	

Specialty Tops

Butcher Block	Ultrafoam	Acrylic	Corian Group A,B	Corian Group C,D	3form Chroma
 BBFL Flat	 ULFP PVC	 AAOP Opaque	 C1FL Flat	 C2FL Flat	 3FFL Flat
 BBBN Bullnose	 ULFR Raw	 AATL Translucent	 C1BN Bullnose	 C2BN Bullnose	 3FBN Bullnose
			 C1PR Prism	 C2PR Prism	 3FPR Prism

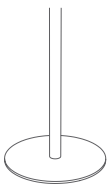

Options

Base Finishes		
Standard Powder Coat	use finish code	n/c
Polished or Satin Chrome (per base)	use finish code	\$213
Premium Plated (per base)	use finish code	Ⓢ
Custom Powder Coat (set-up charge)	CPC	\$363

Base Options		
Alternate Height Base (per column)	AH	\$66
Nylon Octogon Glides (per base)	GNO	\$34
Custom Top Plate Size	CTPS	Ⓢ
6" Column (black wrinkle and powder coat)	COL6	\$194
6" Column (polished or satin chrome)	COLP6	\$248
6" Column (premium plated)	COLPP6	Ⓢ
6" Column (veneer)	COLV6	\$386

Top Materials and Finishes		
Standard Laminates	use manufacturers finish code	n/c
Premium Laminates	PL	Ⓢ
Custom Wood Veneer	CWV	Ⓢ
Special Pattern Veneer	SPV	Ⓢ
Stain to Match (set-up charge)	STM	\$412

Top Options		
Custom Size	CS	Ⓢ
Custom Shape	CSH	Ⓢ
Custom Radius Corner	CRC	Ⓢ
3" Radius Corner (per corner)	CRL3	\$34
(laminates self edge, ultrafoam, Corian®, 3form chroma)		
3" Wood Radius Corner (per corner)	CRW3	\$82
(not available in LWFL, WWFL, LWPI and WWPI)		

Grommets		
2" Round Metal Grommet - Matte Black	GMBK	\$138
2" Round Metal Grommet - Satin Chrome	GMSC	\$138
2" Round Metal Grommet - Polished Chrome	GMPC	\$138
2" Round Plastic Grommet - Matte Black	GPMBK	\$44
Grommet location	use location code	n/c

Edge Options		
1.75" Thick Edge (per table)	175E	15%
<i>(see edge details for specific profiles)</i>		

\$					
2,099	1,017	-	2,134	2,311	4,316
2,290	1,191	3,132	2,587	2,671	4,947
3,106	1,766	4,470	3,079	3,598	6,458
3,458	1,861	5,053	3,406	4,024	7,444
3,808	2,081	6,269	-	-	-
4,153	2,178	6,605	-	-	-
-	2,204	-	-	-	-
-	2,436	-	-	-	-
-	2,547	7,602	-	-	-
-	2,668	-	-	-	-
-	-	-	-	-	-
-	-	-	-	-	-
-	-	-	-	-	-
-	-	-	-	-	-
-	-	-	-	-	-
-	-	-	-	-	-
-	-	-	-	-	-
-	-	-	-	-	-
-	-	-	-	-	-
-	-	-	-	-	-
-	-	-	-	-	-
-	-	-	-	-	-
-	-	-	-	-	-
-	-	-	-	-	-
-	-	-	-	-	-
-	-	-	-	-	-
-	-	-	-	-	-
-	-	-	-	-	-
-	-	-	-	-	-
-	-	-	-	-	-
-	-	-	-	-	-
-	-	-	-	-	-
-	-	-	-	-	-

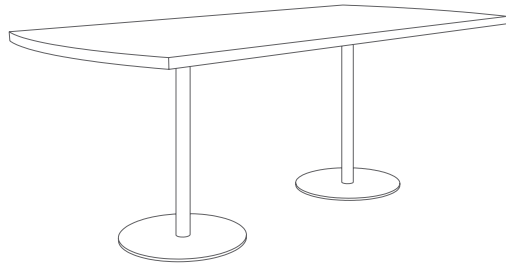

Laminate Tops

Wood Veneer Tops

Self Edge	Vinyl Edges	PVC Edges	Metal Edges	Wood Edges Group A	Wood Edges Group B	Wood Edges Group A	Wood Edges Group B
LLSE Self Edge	LVFL Flat	LPVC PVC	LMFL Flat	LWFL Flat	LWSQ Square	WWFL Flat	WWSQ Square
	LVBP Bumper		LMRB Ribbed	LWTP Tapered Ply	LWAR Arc	WWTP Tapered Ply	WWAR Arc
				LWFP Flat Ply	LWBN Bullnose	WWFP Flat Ply	WWBN Bullnose
					LWPR Prism		WWPR Prism
					LWPI Pivot		WWPI Pivot















Complete Table List Pricing

	Top Size	Base Qty.	Model #	\$								
Arc Rectangle 	42	72	2	DI4272AR	1,982	1,982	2,004	2,040	2,266	2,712	2,337	3,001
	42	84	2	DI4284AR	2,110	2,110	2,193	2,237	2,353	2,974	2,616	3,262
	42	96	2	DI4296AR	2,207	2,207	2,294	2,342	2,493	3,172	2,758	3,511
	48	96	2	DI4896AR	2,600	2,600	2,654	2,704	2,936	3,648	3,309	3,875
	48	120	2	DI48120AR	2,774	2,774	2,893	2,955	3,179	3,988	3,613	4,270
	48	144	3	DI48144AR	3,734	3,734	3,856	3,930	4,216	5,076	4,728	5,502
	48	168	3	DI48168AR	3,956	3,956	4,083	4,167	4,461	5,556	5,037	5,905
	60	120	2	DI60120AR	3,037	3,037	3,182	3,259	3,422	4,298	3,842	4,644
	60	144	3	DI60144AR	4,043	4,043	4,187	4,278	4,597	5,443	4,901	6,114
	60	168	3	DI60168AR	4,319	4,319	4,465	4,570	4,885	5,840	5,224	6,504

How to Order

Table Model Number					Top Finish Selection		Options	
DI Base Series	4272 Top Size	AR Top Shape	WWSQ Top Material	MBK Base Finish	WMW Top Finish	WMW Edge Finish	GMBK Matte Black Grommet	E Location "E"
A DI4272ARWWSQMBK is a Disc series 42" x 72" arc rectangle table with two black powder coat round bases and a wood veneer 1.25" thick top with a 1.25" square wood edge profile.					The codes: WMW WMW specify a medium walnut top, with a medium walnut edge.		The code: GMBK specifies a matte black 2" diameter metal grommet.	
							The code: E specifies the location of the grommet.	

Specialty Tops

Butcher Block	Ultrafoam	Acrylic	Corian Group A,B	Corian Group C,D	3form Chroma
 BBFL Flat	 ULFP PVC	 AAOP Opaque	 C1FL Flat	 C2FL Flat	 3FFL Flat
 BBBN Bullnose	 ULFR Raw	 AATL Translucent	 C1BN Bullnose	 C2BN Bullnose	 3FBN Bullnose
			 C1PR Prism	 C2PR Prism	 3FPR Prism

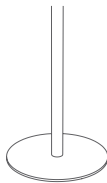

\$

-	-	-	-	-	-
-	-	-	-	-	-
-	-	-	-	-	-
-	-	-	-	-	-
-	-	-	-	-	-
-	-	-	-	-	-
-	-	-	-	-	-
-	-	-	-	-	-
-	-	-	-	-	-
-	-	-	-	-	-
-	-	-	-	-	-
-	-	-	-	-	-
-	-	-	-	-	-

Options

Base Finishes		
Standard Powder Coat	use finish code	n/c
Polished or Satin Chrome (per base)	use finish code	\$213
Premium Plated (per base)	use finish code	Ⓚ
Custom Powder Coat (set-up charge)	CPC	\$363

Base Options		
Alternate Height Base (per column)	AH	\$66
Nylon Octagon Glides (per base)	GNO	\$34
Custom Top Plate Size	CTPS	Ⓚ
6" Column (black wrinkle and powder coat)	COL6	\$194
6" Column (polished or satin chrome)	COLP6	\$248
6" Column (premium plated)	COLPP6	Ⓚ
6" Column (veneer)	COLV6	\$386

Top Materials and Finishes		
Standard Laminates	use manufacturers finish code	n/c
Premium Laminates	PL	Ⓚ
Custom Wood Veneer	CWW	Ⓚ
Special Pattern Veneer	SPV	Ⓚ
Stain to Match (set-up charge)	STM	\$412

Top Options		
Custom Size	CS	Ⓚ
Custom Shape	CSH	Ⓚ
Custom Radius Corner	CRC	Ⓚ
3" Radius Corner (per corner)	CRL3	\$34
(laminates self edge, ultrafoam, Corian®, 3form chroma)		
3" Wood Radius Corner (per corner)	CRW3	\$82
(not available in LWFL, WWFL, LWPI and WWPI)		

Grommets		
2" Round Metal Grommet - Matte Black	GMBK	\$138
2" Round Metal Grommet - Satin Chrome	GMSC	\$138
2" Round Metal Grommet - Polished Chrome	GMPC	\$138
2" Round Plastic Grommet - Matte Black	GPMBK	\$44
Grommet location	use location code	n/c

Edge Options		
1.75" Thick Edge (per table)	175E	15%
<i>(see edge details for specific profiles)</i>		



Laminate Tops

Wood Veneer Tops

Self Edge	Vinyl Edges	PVC Edges	Metal Edges	Wood Edges Group A	Wood Edges Group B	Wood Edges Group A	Wood Edges Group B
LLSE Self Edge	LVFL Flat	LPVC PVC Edge	LMFL Flat	LWFL Flat	LWSQ Square	WWFL Flat	WWSQ Square
	LVBP Bumper		LMRB Ribbed	LWTP Tapered Ply	LWAR Arc	WWTP Tapered Ply	WWAR Arc
				LWFP Flat Ply	LWBN Bullnose	WWFP Flat Ply	WWBN Bullnose
					LWPR Prism		WWPR Prism
					LWPI Pivot		WWPI Pivot

Complete Table List Pricing

	Top Size	Base Qty.	Base Style	Model #	\$								
Round	24	1	X	DUX24RD	659	659	709	757	867	1,036	877	1,108	
	30	1	X	DUX30RD	787	787	849	882	1,048	1,229	1,048	1,316	
	36	1	X	DUX36RD	933	933	1,005	1,051	1,240	1,450	1,266	1,555	
	42	1	X	DUX42RD	1,034	1,034	1,114	1,114	1,356	1,614	1,450	1,740	
	48	1	X	DUX48RD	1,203	1,203	1,294	1,321	1,561	1,857	1,672	2,006	
	54	1	XH	DUX54RD	1,378	1,378	1,483	1,512	1,841	2,452	1,979	2,666	
	60	1	XH	DUXH60RD	1,555	1,555	1,668	1,722	1,961	2,535	2,320	2,761	
Oval	36 72	2	T	DUT36720V	1,304	1,304	1,355	1,380	1,563	1,785	1,736	1,952	
	42 54	2	T	DUT42540V	1,281	1,281	1,308	1,372	1,513	1,840	1,664	1,900	
	42 78	2	T	DUT42780V	1,573	1,573	1,614	1,659	1,807	2,028	1,950	2,197	
	42 84	2	T	DUT42840V	1,629	1,629	1,683	1,727	1,857	2,108	2,003	2,287	
	48 78	2	TT	DUTT48780V	1,776	1,776	1,833	1,879	2,002	2,251	2,154	2,434	
	48 96	2	TT	DUTT48960V	1,952	1,952	2,008	2,058	2,150	2,422	2,512	2,829	
Racetrack	30 60	2	T	DUT3060RA	1,073	1,073	1,131	1,153	1,443	1,721	1,544	1,889	
	30 72	2	T	DUT3072RA	1,141	1,141	1,213	1,238	1,517	1,861	1,630	1,993	
	30 84	2	T	DUT3084RA	1,371	1,371	1,435	1,476	1,614	2,100	1,740	2,297	
	30 96	2	T	DUT3096RA	1,441	1,441	1,513	1,557	1,708	2,314	1,838	2,501	
	36 60	2	T	DUT3660RA	1,203	1,203	1,271	1,293	1,563	1,870	1,674	2,030	
	36 72	2	T	DUT3672RA	1,283	1,283	1,362	1,387	1,695	2,038	1,822	2,209	
	36 84	2	T	DUT3684RA	1,520	1,520	1,599	1,641	1,795	2,265	1,939	2,489	
	36 96	2	TT	DUTT3696RA	1,712	1,712	1,805	1,846	2,014	2,603	2,169	2,780	
	42 72	2	TT	DUTT4272RA	1,479	1,479	1,553	1,584	1,868	2,263	1,939	2,547	
	42 84	2	TT	DUTT4284RA	1,733	1,733	1,800	1,844	1,967	2,518	2,113	2,838	
	42 96	2	TT	DUTT4296RA	1,829	1,829	1,898	1,947	2,090	2,716	2,253	3,113	

Continued on next page

How to Order

Table Model Number					Top Finish Selection		Options
DUX Base Series	36 Top Size	RD Top Shape	WWSQ Top Material Edge Profile	MBK Base Finish	WMW Top Finish	WMW Edge Finish	AH Alternate Height Base

A DUX36RDWWSQMBK is a Dunhill series 36" round table with a black powder coat X-base and a wood veneer 1.25" thick top with a 1.25" square wood edge profile.

The codes: WMW WMW specify a medium walnut top, with a medium walnut edge.

The code: AH specifies alternate height base.

Specialty Tops

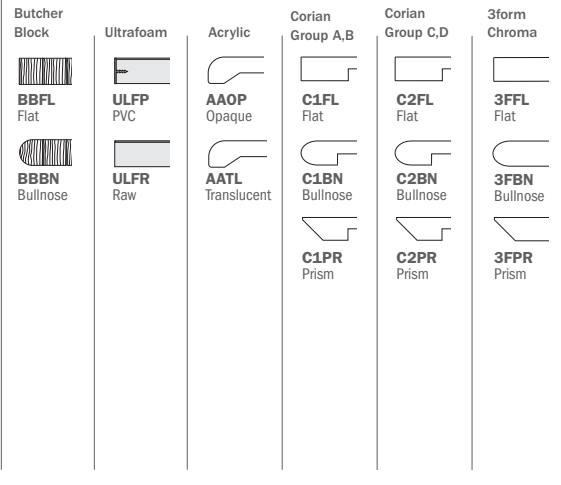

\$						
	1,024	678	1,269	1,184	1,361	1,773
	1,338	820	1,795	1,524	1,788	2,841
	1,711	976	2,322	1,938	2,296	3,817
	2,236	1,088	2,973	2,329	2,806	4,953
	2,577	1,269	3,895	2,839	3,442	6,323
	-	1,463	5,062	3,387	4,135	-
	-	1,609	6,276	3,938	4,850	-
	-	-	-	-	-	-
	-	-	4,117	-	-	-
	-	-	5,504	-	-	-
	-	-	-	-	-	-
	-	-	6,394	-	-	-
	-	-	-	-	-	-
	-	-	-	-	-	-
	-	-	-	-	-	-
	-	-	-	-	-	-
	-	-	-	-	-	-
	-	-	-	-	-	-
	-	-	-	-	-	-
	-	-	-	-	-	-
	-	-	-	-	-	-
	-	-	-	-	-	-

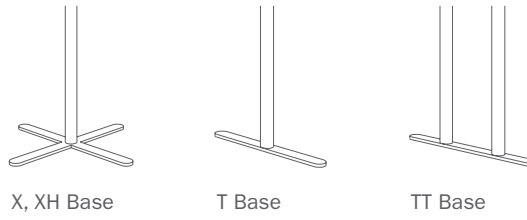

Options

Base Finishes		
Standard Powder Coat	use finish code	n/c
Polished or Satin Chrome (per base)	use finish code	\$213
Premium Plated (per base)	use finish code	🕒
Custom Powder Coat (set-up charge)	CPC	\$363

Base Options		
Alternate Height Base (per column)	AH	\$66
Super Level Glides (per base)	GSL	\$34
Powder Coated Puck Style Glides (per base)	GPUPC	\$138
Polished or Satin Chrome Puck Style Glides (per base)	GPUPL	\$166
Locking Casters 2" Twin Wheel (qty. 4)	TWC2	\$56
Tilt-top - (standard cable release)	TMX/TMT	\$270 X-base/ \$418 T-base
Folding	FM	\$270 T-base

Top Materials and Finishes		
Standard Laminates	use manufacturers finish code	n/c
Premium Laminates	PRL	🕒
Custom Wood Veneer	CWW	🕒
Special Pattern Veneer	SPV	🕒
Stain to Match (set-up charge)	STM	\$412

Top Options		
Custom Size	CS	🕒
Custom Shape	CSH	🕒
Custom Radius Corner	CRC	🕒
3" Radius Corner (per corner) (laminite self edge, ultrafoam, Corian®, 3form chroma)	CRL3	\$34
3" Wood Radius Corner (per corner) (not available in LWFL, WWFL, LWPI and WWPI)	CRW3	\$82
Ganging Clips (1 set includes 2 male and 2 female clips)	GC	\$148

Grommets		
2" Round Metal Grommet - Matte Black	GMBK	\$138
2" Round Metal Grommet - Satin Chrome	GMSC	\$138
2" Round Metal Grommet - Polished Chrome	GMPC	\$138
2" Round Plastic Grommet - Matte Black	GPMBK	\$44
Grommet location	use location code	n/c

Edge Options		
1.75" Thick Edge (per table)	175E	15%

Modesty Panels		
Fixed Modesty Panel Laminate (48,60,72)	MODLFX	\$248
Fixed Modesty Panel Veneer (48,60,72)	MODVFX	\$386
Folding Modesty Panel Laminate (48,60,72)	MODLFL	\$330
Folding Modesty Veneer (48,60,72)	MODVFL	\$468

Wire Management		
J-Trough (horizontal mount) - Matte Black	WMJ	\$116
Legway Wire Manager (vertical mount) - Matte Black	WML	\$56

Data and Power		
Recessed Power and Data Module Two	DPBS2	\$396
Recessed Power and Data Module Four	DPBS4	\$688
Retractable Power and Data Module Two	DPAS2	\$606
Retractable Power and Data Module Three	DPAS3	\$688
Under Top Mounted Power and Data Module Two	DPUS2	\$358

Other		
Table Truck for Folding Tables	TTRK	\$1512

Laminate Tops

Wood Veneer Tops

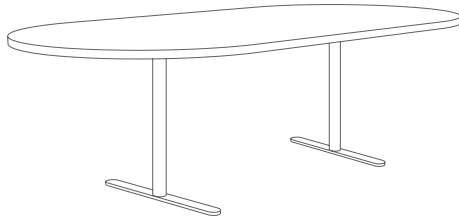

Self Edge	Vinyl Edges	PVC Edges	Metal Edges	Wood Edges Group A	Wood Edges Group B	Wood Edges Group A	Wood Edges Group B
LLSE Self Edge	LVFL Flat	LPVC PVC Edge	LMFL Flat	LWFL Flat	LWSQ Square	WWFL Flat	WWSQ Square
	LVBP Bumper		LMRB Ribbed	LWTP Tapered Ply	LWAR Arc	WWTP Tapered Ply	WWAR Arc
				LWFP Flat Ply	LWBN Bullnose	WWFP Flat Ply	WWBN Bullnose
					LWPR Prism		WWPR Prism
					LWPI Pivot		WWPI Pivot

Complete Table List Pricing

	Top Size		Base Qty.	Base Style	Model #	\$							
	48 96		2	TT	DUTT4896RA	1,996	1,996	2,076	2,126	2,356	3,007	2,725	3,233
	48 120		2	TT	DUTT48120RA	2,208	2,208	2,309	2,371	2,599	3,346	3,029	3,686
	48 144		3	TT	DUTT48144RA	2,899	2,899	3,014	3,091	3,332	4,142	3,844	4,567
	48 168		3	TT	DUTT48168RA	3,114	3,114	3,237	3,324	3,583	4,511	4,159	4,993
	60 120		2	TT	DUTT60120RA	2,480	2,480	2,589	2,665	2,780	3,686	3,229	4,083
	60 144		3	TT	DUTT60144RA	3,223	3,223	3,324	3,416	3,671	4,511	4,003	4,980
	60 168		3	TT	DUTT60168RA	3,488	3,488	3,599	3,704	3,965	4,906	4,637	5,756
	24 24		1	X	DUX2424SQ	659	659	715	769	867	1,036	877	1,108
	30 30		1	X	DUX3030SQ	787	787	855	902	1,048	1,229	1,048	1,316
	36 36		1	X	DUX3636SQ	933	933	1,001	1,070	1,230	1,450	1,266	1,555
	42 42		1	X	DUX4242SQ	1,088	1,088	1,164	1,213	1,422	1,680	1,516	1,806
	48 48		1	X	DUX4848SQ	1,205	1,205	1,294	1,353	1,561	1,857	1,672	2,006
	18 48		2	T	DUT1848RE	813	813	864	879	982	1,231	1,048	1,259
	18 60		2	T	DUT1860RE	863	863	923	941	1,062	1,344	1,126	1,402
	18 72		2	T	DUT1872RE	910	910	976	997	1,146	1,458	1,214	1,544
	18 84		2	T	DUT1884RE	1,062	1,062	1,114	1,146	1,291	1,599	1,385	1,729
	18 96		2	T	DUT1896RE	1,146	1,146	1,193	1,231	1,348	1,712	1,447	1,834
	24 30		1	X	DUX2430RE	756	756	803	815	996	1,182	1,077	1,262
	24 36		1	X	DUX2436RE	851	851	903	917	1,125	1,306	1,191	1,394
	24 42		1	X	DUX2442RE	884	884	929	944	1,166	1,365	1,236	1,460
	24 48		1	X	DUX2448RE	919	919	975	993	1,238	1,460	1,318	1,565
	24 60		2	T	DUT2460RE	929	929	989	1,010	1,270	1,523	1,359	1,643
	24 72		2	T	DUT2472RE	987	987	1,057	1,081	1,367	1,657	1,470	1,795
	24 84		2	T	DUT2484RE	1,204	1,204	1,269	1,309	1,449	1,937	1,562	2,112
	24 96		2	T	DUT2496RE	1,262	1,262	1,333	1,377	1,531	2,058	1,653	2,248

Continued on next page

How to Order

Table Model Number					Top Finish Selection		Options
DUT Base Series	3672 Top Size	RA Top Shape	WWSQ Top Material Edge Profile	MBK Base Finish	WMW Top Finish	WMW Edge Finish	TWC2 Casters

A DUT3672RAWWSQMBK is a Dunhill series 36"x 72" racetrack table with two black powder coated T-bases and a wood veneer 1.25" thick top with a 1.25" square wood edge profile.

The codes: WMW WMW specify a medium walnut top, with a medium walnut edge.

The code: TWC2 specifies 2" twin wheel locking casters.

Specialty Tops

Butcher Block	Ultrafoam	Acrylic	Corian Group A,B	Corian Group C,D	3form Chroma
BBFL Flat	ULFP PVC	AAOP Opaque	C1FL Flat	C2FL Flat	3FFL Flat
BBBN Bullnose	ULFR Raw	AATL Translucent	C1BN Bullnose	C2BN Bullnose	3FBN Bullnose
			C1PR Prism	C2PR Prism	3FPR Prism

\$						
-	-	-	-	-	-	-
-	-	-	-	-	-	-
-	-	-	-	-	-	-
-	-	-	-	-	-	-
-	-	-	-	-	-	-
-	-	-	-	-	-	-
-	-	-	-	-	-	-
1,094	692	1,271	1,099	1,252	1,740	
1,431	820	1,800	1,419	1,647	2,796	
1,829	976	2,329	1,820	2,139	3,765	
2,487	1,143	3,047	2,255	2,679	4,955	
2,793	1,271	3,905	2,685	3,230	6,262	
1,344	842	-	-	-	-	
1,412	902	-	-	-	-	
1,525	955	-	-	-	-	
1,684	1,133	-	-	-	-	
1,797	1,188	-	-	-	-	
1,279	779	1,551	1,283	1,466	2,390	
1,479	880	1,901	1,462	1,678	2,783	
1,673	916	2,026	1,573	1,826	3,119	
1,728	956	2,211	1,687	1,975	3,452	
1,925	976	-	1,880	2,233	4,112	
2,176	1,044	-	2,119	2,542	4,777	
2,359	1,236	-	-	-	-	
2,542	1,304	-	-	-	-	

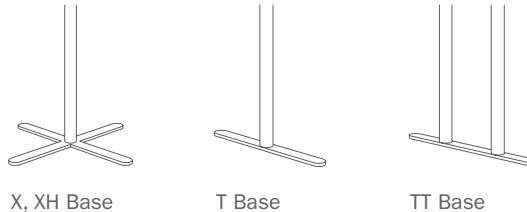

Options

Base Finishes			
Standard Powder Coat	use finish code		n/c
Polished or Satin Chrome (per base)	use finish code		\$213
Premium Plated (per base)	use finish code		🕒
Custom Powder Coat (set-up charge)	CPC		\$363

Base Options			
Alternate Height Base (per column)	AH		\$66
Super Level Glides (per base)	GSL		\$34
Powder Coated Puck Style Glides (per base)	GPUPC		\$138
Polished or Satin Chrome Puck Style Glides (per base)	GPUPL		\$166
Locking Casters 2" Twin Wheel (qty. 4)	TWC2		\$56
Tilt-top - (standard cable release)	TMX/TMT	\$270 X-base/ \$418 T-base	
Folding	FM		\$270 T-base

Top Materials and Finishes			
Standard Laminates	use manufacturers finish code		n/c
Premium Laminates	PRL		🕒
Custom Wood Veneer	CWV		🕒
Special Pattern Veneer	SPV		🕒
Stain to Match (set-up charge)	STM		\$412

Top Options			
Custom Size	CS		🕒
Custom Shape	CSH		🕒
Custom Radius Corner	CRC		🕒
3" Radius Corner (per corner)	CRL3		\$34
(laminate self edge, ultrafoam, Corian®, 3form chroma)			
3" Wood Radius Corner (per corner)	CRW3		\$82
(not available in LWFL, WWFL, LWPI and WWPI)			
Ganging Clips (1 set includes 2 male and 2 female clips)	GC		\$148

Grommets			
2" Round Metal Grommet - Matte Black	GMBK		\$138
2" Round Metal Grommet - Satin Chrome	GMSC		\$138
2" Round Metal Grommet - Polished Chrome	GMPC		\$138
2" Round Plastic Grommet - Matte Black	GPMBK		\$44
Grommet location	use location code		n/c

Edge Options			
1.75" Thick Edge (per table)	175E		15%

Modesty Panels			
Fixed Modesty Panel Laminate (48,60,72)	MODLFX		\$248
Fixed Modesty Panel Veneer (48,60,72)	MODVFX		\$386
Folding Modesty Panel Laminate (48,60,72)	MODLFL		\$330
Folding Modesty Veneer (48,60,72)	MODVFL		\$468

Wire Management			
J-Trough (horizontal mount) - Matte Black	WMJ		\$116
Legway Wire Manager (vertical mount) - Matte Black	WML		\$56

Data and Power			
Recessed Power and Data Module Two	DPBS2		\$396
Recessed Power and Data Module Four	DPBS4		\$688
Retractable Power and Data Module Two	DPAS2		\$606
Retractable Power and Data Module Three	DPAS3		\$688
Under Top Mounted Power and Data Module Two	DPUS2		\$358

Other			
Table Truck for Folding Tables	TTRK		\$1512

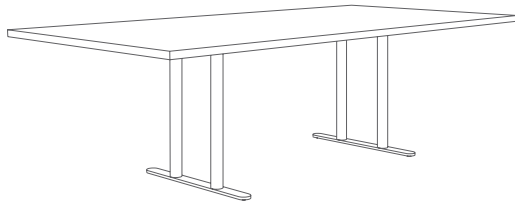

Laminate Tops

Wood Veneer Tops

Self Edge	Vinyl Edges	PVC Edges	Metal Edges	Wood Edges Group A	Wood Edges Group B	Wood Edges Group A	Wood Edges Group B
LLSE Self Edge	LVFL Flat	LPVC PVC Edge	LMFL Flat	LWFL Flat	LWSQ Square	WWFL Flat	WWSQ Square
	LVBP Bumper		LMRB Ribbed	LWTP Tapered Ply	LWAR Arc	WWTP Tapered Ply	WWAR Arc
				LWFP Flat Ply	LWBN Bullnose	WWFP Flat Ply	WWBN Bullnose
					LWPR Prism		WWPR Prism
					LWPI Pivot		WWPI Pivot

Complete Table List Pricing

Top Size	Base Qty.	Base Style	Model #	\$									
Rectangle	30	36	1	X	DUX3036RE	896	896	941	956	1,178	1,376	1,250	1,472
	30	42	1	X	DUX3042RE	931	931	983	1,001	1,273	1,495	1,355	1,606
	30	48	1	X	DUX3048RE	1,034	1,034	1,090	1,110	1,384	1,625	1,475	1,744
	30	60	2	T	DUT3060RE	1,061	1,061	1,125	1,149	1,441	1,717	1,544	1,853
	30	72	2	T	DUT3072RE	1,129	1,129	1,206	1,233	1,517	1,830	1,631	1,980
	30	84	2	T	DUT3084RE	1,361	1,361	1,427	1,472	1,612	2,100	1,735	2,283
	30	96	2	T	DUT3096RE	1,431	1,431	1,504	1,552	1,707	2,273	1,843	2,478
	36	42	2	T	DUT3642RE	1,055	1,055	1,114	1,133	1,404	1,649	1,497	1,769
	36	48	2	T	DUT3648RE	1,095	1,095	1,157	1,178	1,458	1,719	1,555	1,847
	36	60	2	T	DUT3660RE	1,190	1,190	1,263	1,287	1,563	1,859	1,674	2,007
	36	72	2	T	DUT3672RE	1,273	1,273	1,350	1,378	1,691	2,026	1,816	2,195
	36	84	2	T	DUT3684RE	1,518	1,518	1,587	1,633	1,795	2,261	1,935	2,458
	36	96	2	TT	DUTT3696RE	1,712	1,712	1,795	1,839	2,012	2,547	2,165	2,766
	42	72	2	TT	DUTT4272RE	1,469	1,469	1,534	1,567	1,868	2,263	1,939	2,356
	42	84	2	TT	DUTT4284RE	1,725	1,725	1,795	1,844	1,982	2,490	2,218	2,803
	42	96	2	TT	DUTT4296RE	1,819	1,819	1,896	1,949	2,103	2,716	2,360	2,846
	48	96	2	TT	DUTT4896RE	1,994	1,994	2,069	2,124	2,352	3,007	2,725	3,212
	48	120	2	TT	DUTT48120RE	2,206	2,206	2,304	2,371	2,595	3,233	3,029	3,517
	48	144	3	TT	DUTT48144RE	2,879	2,879	2,974	3,054	3,299	3,945	3,801	4,336
	48	168	3	TT	DUTT48168RE	3,107	3,107	3,207	3,299	3,530	4,227	4,091	4,662
	60	120	2	TT	DUTT60120RE	2,467	2,467	2,559	2,640	2,815	3,459	3,233	3,857
	60	144	3	TT	DUTT60144RE	3,175	3,175	3,278	3,375	3,642	4,227	4,231	4,753
	60	168	3	TT	DUTT60168RE	3,484	3,484	3,557	3,669	3,925	4,851	4,585	5,530

Continued on next page

*T-bases can be specified on 30" x 42" and 30" x 48" rectangle tables, please refer to Base Only Pricing (pg. 231) and Top Only Pricing (pg. 231).

Top Only Pricing

X-bases are recommended for dining applications.

How to Order

Table Model Number					Top Finish Selection		Options	
DUT Base Series	3672 Top Size	RE Top Shape	WWSQ Top Material Edge Profile	MBK Base Finish	WMW Top Finish	WMW Edge Finish	GMBK Matte Black Grommet	E Location "E"
A DUT3672REWWSQMBK is a Dunhill series 36" x 72" rectangle table with two black powder coated T-bases and a wood veneer 1.25" thick top with a 1.25" square wood edge profile.					The codes: WMW WMW specify a medium walnut top, with a medium walnut edge.		The code: GMBK specifies a matte black 2" diameter metal grommet.	
							The code: E specifies the location of the grommet.	

Specialty Tops

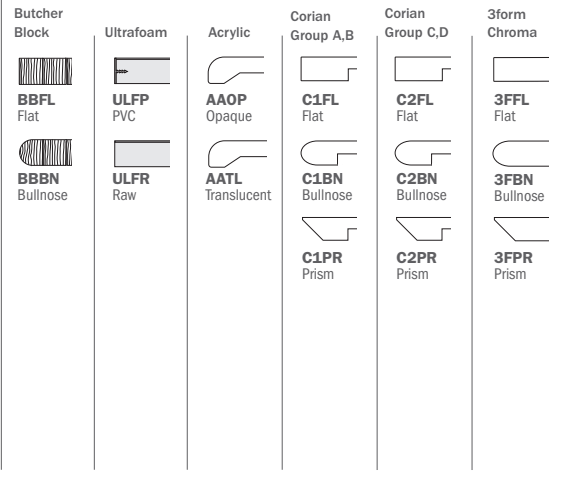

\$						
1,649	929	2,121	1,625	1,892	3,290	
1,894	971	2,364	1,763	2,073	3,728	
2,020	1,080	2,679	1,981	2,333	4,222	
2,264	1,118	3,154	2,213	2,651	5,004	
2,569	1,197	3,896	2,499	3,020	5,876	
2,752	1,402	-	-	-	-	
2,935	1,484	-	-	-	-	
2,184	1,102	-	2,219	2,396	4,401	
2,250	1,151	3,092	2,547	2,631	4,907	
2,596	1,256	3,960	2,569	3,088	5,948	
2,948	1,351	4,543	2,896	3,514	6,934	
3,298	1,571	5,759	-	-	-	
3,755	1,780	6,207	-	-	-	
-	1,556	-	-	-	-	
-	1,788	-	-	-	-	
-	1,899	6,954	-	-	-	
-	2,084	-	-	-	-	
-	-	-	-	-	-	
-	-	-	-	-	-	
-	-	-	-	-	-	
-	-	-	-	-	-	
-	-	-	-	-	-	
-	-	-	-	-	-	
-	-	-	-	-	-	

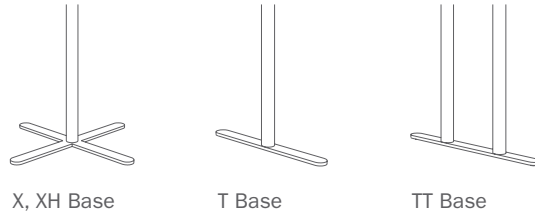

Options

Base Finishes			
Standard Powder Coat	use finish code		n/c
Polished or Satin Chrome (per base)	use finish code		\$213
Premium Plated (per base)	use finish code		\$213
Custom Powder Coat (set-up charge)	CPC		\$363

Base Options			
Alternate Height Base (per column)	AH		\$66
Super Level Glides (per base)	GSL		\$34
Powder Coated Puck Style Glides (per base)	GPUPC		\$138
Polished or Satin Chrome Puck Style Glides (per base)	GPUPL		\$166
Locking Casters 2" Twin Wheel (qty. 4)	TWC2		\$56
Tilt-top - (standard cable release)	TMX/TMT	\$270 X-base/	\$418 T-base
Folding	FM		\$270 T-base

Top Materials and Finishes			
Standard Laminates	use manufacturers finish code		n/c
Premium Laminates	PRL		\$213
Custom Wood Veneer	CWV		\$213
Special Pattern Veneer	SPV		\$213
Stain to Match (set-up charge)	STM		\$412

Top Options			
Custom Size	CS		\$213
Custom Shape	CSH		\$213
Custom Radius Corner	CRC		\$213
3" Radius Corner (per corner)	CRL3		\$34
(laminates self edge, ultrafoam, Corian®, 3form chroma)			
3" Wood Radius Corner (per corner)	CRW3		\$82
(not available in LWFL, WWFL, LWPI and WWPI)			
Ganging Clips (1 set includes 2 male and 2 female clips)	GC		\$148

Grommets			
2" Round Metal Grommet - Matte Black	GMBK		\$138
2" Round Metal Grommet - Satin Chrome	GMSC		\$138
2" Round Metal Grommet - Polished Chrome	GMPC		\$138
2" Round Plastic Grommet - Matte Black	GPMBK		\$44
Grommet location	use location code		n/c

Edge Options			
1.75" Thick Edge (per table)	175E		15%

Modesty Panels			
Fixed Modesty Panel Laminate (48,60,72)	MODLFX		\$248
Fixed Modesty Panel Veneer (48,60,72)	MODVFX		\$386
Folding Modesty Panel Laminate (48,60,72)	MODLFL		\$330
Folding Modesty Veneer (48,60,72)	MODVFL		\$468

Wire Management			
J-Trough (horizontal mount) - Matte Black	WMJ		\$116
Legway Wire Manager (vertical mount) - Matte Black	WML		\$56

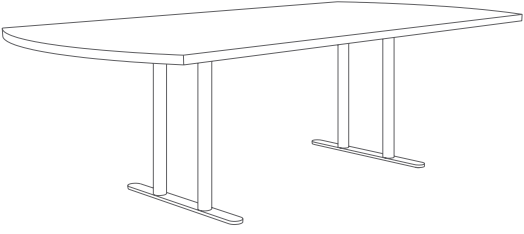

Data and Power			
Recessed Power and Data Module Two	DPBS2		\$396
Recessed Power and Data Module Four	DPBS4		\$688
Retractable Power and Data Module Two	DPAS2		\$606
Retractable Power and Data Module Three	DPAS3		\$688
Under Top Mounted Power and Data Module Two	DPUS2		\$358

Other			
Table Truck for Folding Tables	TRK		\$1512



Laminate Tops					Wood Veneer Tops			
Self Edge	Vinyl Edges	PVC Edges	Metal Edges	Wood Edges Group A	Wood Edges Group B	Wood Edges Group A	Wood Edges Group B	
LLSE Self Edge	LVFL Flat	LPVC PVC Edge	LMFL Flat	LWFL Flat	LWSQ Square	WWFL Flat	WWSQ Square	
	LVBP Bumper		LMRB Ribbed	LWTP Tapered Ply	LWAR Arc	WWTP Tapered Ply	WWAR Arc	
				LWFP Flat Ply	LWBN Bullnose	WWFP Flat Ply	WWBN Bullnose	
					LWPR Prism		WWPR Prism	
					LWPI Pivot		WWPI Pivot	

Complete Table List Pricing















	Top Size	Base Qty.	Base Style	Model #	\$							
	24 48	2	T	DUT2448HR	875	875	925	941	1,065	1,318	1,128	1,365
	30 60	2	T	DUT3060HR	1,074	1,074	1,142	1,165	1,283	1,579	1,367	1,713
	36 72	2	T	DUT3672HR	1,289	1,289	1,370	1,396	1,513	1,870	1,721	1,983
	30 60	2	T	DUT3060AR	1,074	1,074	1,129	1,151	1,408	1,721	1,544	1,865
	30 72	2	T	DUT3072AR	1,165	1,165	1,215	1,240	1,522	1,919	1,630	1,993
	30 84	2	T	DUT3084AR	1,343	1,343	1,424	1,464	1,612	2,061	1,738	2,297
	30 96	2	T	DUT3096AR	1,416	1,416	1,503	1,546	1,721	2,258	1,838	2,501
	36 60	2	T	DUT3660AR	1,223	1,223	1,265	1,287	1,563	1,925	1,674	2,030
	36 72	2	T	DUT3672AR	1,326	1,326	1,374	1,400	1,688	2,096	1,816	2,209
	36 84	2	T	DUT3684AR	1,505	1,505	1,590	1,631	1,795	2,265	1,935	2,464
	36 96	2	TT	DUTT3696AR	1,702	1,702	1,795	1,835	2,014	2,631	2,169	2,780
	42 72	2	TT	DUTT4272AR	1,584	1,584	1,606	1,642	1,868	2,314	1,939	2,603
	42 84	2	TT	DUTT4284AR	1,712	1,712	1,795	1,839	1,955	2,576	2,218	2,864
	42 96	2	TT	DUTT4296AR	1,809	1,809	1,896	1,944	2,095	2,774	2,360	3,113
	48 96	2	TT	DUTT4896AR	2,016	2,016	2,070	2,120	2,352	3,064	2,725	3,291
	48 120	2	TT	DUTT48120AR	2,190	2,190	2,309	2,371	2,595	3,404	3,029	3,686
	48 144	3	TT	DUTT48144AR	2,858	2,858	2,980	3,054	3,340	4,200	3,852	4,626
	48 168	3	TT	DUTT48168AR	3,080	3,080	3,207	3,291	3,585	4,680	4,161	5,029

Continued on next page

How to Order

Table Model Number					Top Finish Selection		Options	
DUTT Base Series	4272 Top Size	AR Top Shape	WWSQ Top Material Edge Profile	MBK Base Finish	WMW Top Finish	WMW Edge Finish	GMBK Matte Black Grommet	C Location "C"
<p>A DUTT4272ARWWSQMBK is a Dunhill series 42" x 72" arc rectangle table with two black powder coated TT-bases and a wood veneer 1.25" thick top with a 1.25" square wood edge profile.</p>					<p>The codes: WMW WMW specify a medium walnut top, with a medium walnut edge.</p>		<p>The code: GMBK specifies a matte black 2" diameter metal grommet.</p>	
							<p>The code: C specifies the location of the grommet.</p>	

Specialty Tops

Butcher Block	Ultrafoam	Acrylic	Corian Group A,B	Corian Group C,D	3form Chroma
 BBFL Flat	 ULFP PVC	 AAOP Opaque	 C1FL Flat	 C2FL Flat	 3FFL Flat
 BBBN Bullnose	 ULFR Raw	 AATL Translucent	 C1BN Bullnose	 C2BN Bullnose	 3FBN Bullnose
			 C1PR Prism	 C2PR Prism	 3FPR Prism

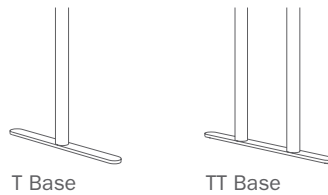

\$					
-	-	-	-	-	-
-	-	-	-	-	-
-	-	-	-	-	-
-	-	-	-	-	-
-	-	-	-	-	-
-	-	-	-	-	-
-	-	-	-	-	-
-	-	-	-	-	-
-	-	-	-	-	-
-	-	-	-	-	-
-	-	-	-	-	-
-	-	-	-	-	-
-	-	-	-	-	-
-	-	-	-	-	-
-	-	-	-	-	-
-	-	-	-	-	-
-	-	-	-	-	-
-	-	-	-	-	-
-	-	-	-	-	-
-	-	-	-	-	-
-	-	-	-	-	-
-	-	-	-	-	-
-	-	-	-	-	-
-	-	-	-	-	-
-	-	-	-	-	-

Options

Base Finishes			
Standard Powder Coat	use finish code	n/c	
Polished or Satin Chrome (per base)	use finish code	\$213	
Premium Plated (per base)	use finish code		
Custom Powder Coat (set-up charge)	CPC	\$363	
Base Options			
Alternate Height Base (per column)	AH	\$66	
Super Level Glides (per base)	GSL	\$34	
Powder Coated Puck Style Glides (per base)	GPUPC	\$138	
Polished or Satin Chrome Puck Style Glides (per base)	GPUPL	\$166	
Locking Casters 2" Twin Wheel (qty. 4)	TWC2	\$56	
Tilt-top - (standard cable release)	TMX/TMT	\$270 X-base/ \$418 T-base	
Folding	FM	\$270 T-base	
Top Materials and Finishes			
Standard Laminates	use manufacturers finish code	n/c	
Premium Laminates	PRL		
Custom Wood Veneer	CWV		
Special Pattern Veneer	SPV		
Stain to Match (set-up charge)	STM	\$412	
Top Options			
Custom Size	CS		
Custom Shape	CSH		
Custom Radius Corner	CRC		
3" Radius Corner (per corner)	CRL3	\$34	
(laminated self edge, ultrafoam, Corian®, 3form chroma)			
3" Wood Radius Corner (per corner)	CRW3	\$82	
(not available in LWFL, WWFL, LWPI and WWPI)			
Ganging Clips (1 set includes 2 male and 2 female clips)	GC	\$148	
Grommets			
2" Round Metal Grommet - Matte Black	GMBK	\$138	
2" Round Metal Grommet - Satin Chrome	GMSC	\$138	
2" Round Metal Grommet - Polished Chrome	GMPC	\$138	
2" Round Plastic Grommet - Matte Black	GPMBK	\$44	
Grommet location	use location code	n/c	
Edge Options			
1.75" Thick Edge (per table)	175E	15%	
Modesty Panels			
Fixed Modesty Panel Laminate (48,60,72)	MODLFX	\$248	
Fixed Modesty Panel Veneer (48,60,72)	MODVFX	\$386	
Folding Modesty Panel Laminate (48,60,72)	MODLFL	\$330	
Folding Modesty Veneer (48,60,72)	MODVFL	\$468	
Wire Management			
J-Trough (horizontal mount) - Matte Black	WMJ	\$116	
Legway Wire Manager (vertical mount) - Matte Black	WML	\$56	
Data and Power			
Recessed Power and Data Module Two	DPBS2	\$396	
Recessed Power and Data Module Four	DPBS4	\$688	
Retractable Power and Data Module Two	DPAS2	\$606	
Retractable Power and Data Module Three	DPAS3	\$688	
Under Top Mounted Power and Data Module Two	DPUS2	\$358	
Other			
Table Truck for Folding Tables	TTRK	\$1512	

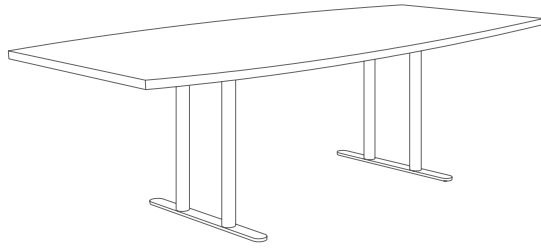

Laminate Tops

Wood Veneer Tops

Self Edge	Vinyl Edges	PVC Edges	Metal Edges	Wood Edges Group A	Wood Edges Group B	Wood Edges Group A	Wood Edges Group B
LLSE Self Edge	LVFL Flat	LPVC PVC Edge	LMFL Flat	LWFL Flat	LWSQ Square	WWFL Flat	WWSQ Square
	LVBP Bumper		LMRB Ribbed	LWTP Tapered Ply	LWAR Arc	WWTP Tapered Ply	WWAR Arc
				LWFP Flat Ply	LWBN Bullnose	WWFP Flat Ply	WWBN Bullnose
					LWPR Prism		WWPR Prism
					LWPI Pivot		WWPI Pivot

Complete Table List Pricing

	Top Size	Base Qty.	Base Style	Model #	\$								
	60 120	2	TT	DUTT60120AR	2,453	2,453	2,598	2,675	2,838	3,714	3,258	4,060	
	60 144	3	TT	DUTT60144AR	3,167	3,167	3,311	3,402	3,721	4,567	4,025	5,238	
	60 168	3	TT	DUTT60168AR	3,443	3,443	3,589	3,694	4,009	4,964	4,348	5,628	
	36 42 72	2	T	DUT3672BS	1,691	1,691	1,656	1,703	1,937	2,361	2,096	2,573	
	36 48 84	2	TT	DUTT3684BS	1,918	1,918	1,983	2,039	2,344	2,739	2,539	2,986	
	36 48 96	2	TT	DUTT3696BS	2,037	2,037	2,101	2,158	2,510	2,857	2,726	3,115	
	36 48 120	2	TT	DUTT36120BS	2,274	2,274	2,351	2,422	2,893	3,126	3,157	3,418	
	36 48 144	3	TT	DUTT36144BS	2,929	2,929	3,018	3,104	3,765	4,005	4,086	4,357	
	36 48 168	3	TT	DUTT36168BS	3,155	3,155	3,267	3,365	4,100	4,226	4,464	4,606	

How to Order

Table Model Number					Top Finish Selection		Options	
DUTT Base Series	364884 Top Size	BS Top Shape	WWSQ Top Material Edge Profile	MBK Base Finish	WMW Top Finish	WMW Edge Finish	GMBK Matte Black Grommet	G Location "G"
A DUTT364884BSWWSQMBK is a Dunhill series 36" x 48" X 84" boat shape table with two black powder coat TT-bases and a wood veneer 1.25" thick top with a 1.25" square wood edge profile.					The codes: WMW WMW specify a medium walnut top, with a medium walnut edge.		The code: GMBK specifies a matte black 2" diameter metal grommet.	
							The code: G specifies the location of the grommet.	

Specialty Tops

Butcher Block	Ultrafoam	Acrylic	Corian Group A,B	Corian Group C,D	3form Chroma
BBFL Flat	ULFP PVC	AAOP Opaque	C1FL Flat	C2FL Flat	3FFL Flat
BBBN Bullnose	ULFR Raw	AATL Translucent	C1BN Bullnose	C2BN Bullnose	3FBN Bullnose
			C1PR Prism	C2PR Prism	3FPR Prism

\$					
-	-	-	-	-	-
-	-	-	-	-	-
-	-	-	-	-	-
-	-	-	-	-	-
-	-	-	-	-	-
-	-	-	-	-	-
-	-	-	-	-	-

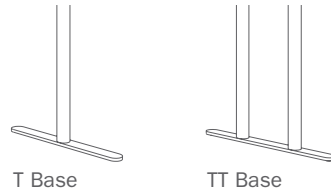

Options

Base Finishes		
Standard Powder Coat	use finish code	n/c
Polished or Satin Chrome (per base)	use finish code	\$213
Premium Plated (per base)	use finish code	🕒
Custom Powder Coat (set-up charge)	CPC	\$363

Base Options		
Alternate Height Base (per column)	AH	\$66
Super Level Glides (per base)	GSL	\$34
Powder Coated Puck Style Glides (per base)	GPUPC	\$138
Polished or Satin Chrome Puck Style Glides (per base)	GPUPL	\$166
Locking Casters 2" Twin Wheel (qty. 4)	TWC2	\$56
Tilt-top - (standard cable release)	TMX/TMT	\$270 X-base/ \$418 T-base
Folding	FM	\$270 T-base

Top Materials and Finishes		
Standard Laminates	use manufacturers finish code	n/c
Premium Laminates	PRL	🕒
Custom Wood Veneer	CWV	🕒
Special Pattern Veneer	SPV	🕒
Stain to Match (set-up charge)	STM	\$412

Top Options		
Custom Size	CS	🕒
Custom Shape	CSH	🕒
Custom Radius Corner	CRC	🕒
3" Radius Corner (per corner)	CRL3	\$34
(laminates self edge, ultrafoam, Corian®, 3form chroma)		
3" Wood Radius Corner (per corner)	CRW3	\$82
(not available in LWFL, WWFL, LWPI and WWPI)		
Ganging Clips (1 set includes 2 male and 2 female clips)	GC	\$148

Grommets		
2" Round Metal Grommet - Matte Black	GMBK	\$138
2" Round Metal Grommet - Satin Chrome	GMSC	\$138
2" Round Metal Grommet - Polished Chrome	GMPC	\$138
2" Round Plastic Grommet - Matte Black	GPMBK	\$44
Grommet location	use location code	n/c

Edge Options		
1.75" Thick Edge (per table)	175E	15%

Modesty Panels		
Fixed Modesty Panel Laminate (48,60,72)	MODLFX	\$248
Fixed Modesty Panel Veneer (48,60,72)	MODVFX	\$386
Folding Modesty Panel Laminate (48,60,72)	MODLFL	\$330
Folding Modesty Veneer (48,60,72)	MODVFL	\$468

Wire Management		
J-Trough (horizontal mount) - Matte Black	WMJ	\$116
Legway Wire Manager (vertical mount) - Matte Black	WML	\$56

Data and Power		
Recessed Power and Data Module Two	DPBS2	\$396
Recessed Power and Data Module Four	DPBS4	\$688
Retractable Power and Data Module Two	DPAS2	\$606
Retractable Power and Data Module Three	DPAS3	\$688
Under Top Mounted Power and Data Module Two	DPUS2	\$358

Other		
Table Truck for Folding Tables	TTRK	\$1512

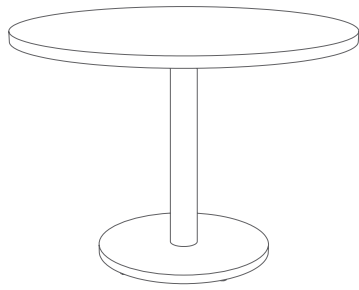

Laminate Tops

Wood Veneer Tops

Self Edge	Vinyl Edges	PVC Edges	Metal Edges	Wood Edges Group A	Wood Edges Group B	Wood Edges Group A	Wood Edges Group B
LLSE Self Edge	LVFL Flat LVBP Bumper	LPVC PVC	LMFL Flat LMRB Ribbed	LWFL Flat LWTP Tapered Ply LWFP Flat Ply	LWSQ Square LWAR Arc LWBN Bullnose LWPR Prism LWPI Pivot	WWFL Flat WWTP Tapered Ply WWFP Flat Ply	WWSQ Square WWAR Arc WWBN Bullnose WWPR Prism WWPI Pivot

Complete Table List Pricing

	Top Size		Base Qty.	Model #	\$							
Round	24		1	FR24RD	559	559	609	657	767	936	777	1,008
	30		1	FR30RD	619	619	681	714	880	1,061	880	1,148
	36		1	FR36RD	699	699	771	817	1,006	1,216	1,032	1,321
	42		1	FR42RD	920	920	1,000	1,000	1,242	1,500	1,336	1,626
	48		1	FR48RD	1,023	1,023	1,114	1,141	1,381	1,677	1,492	1,826
	54		1	FR54RD	1,134	1,134	1,239	1,268	1,597	2,208	1,735	2,422
	60		1	FR60RD	1,411	1,411	1,524	1,578	1,817	2,391	2,176	2,617
Oval	36	72	2	FR3672OV	1,364	1,364	1,415	1,440	1,623	1,845	1,796	2,012
	42	54	2	FR4254OV	1,341	1,341	1,368	1,432	1,573	1,900	1,724	1,960
	42	78	2	FR4278OV	1,873	1,873	1,914	1,959	2,107	2,328	2,250	2,497
	42	84	2	FR4284OV	1,929	1,929	1,983	2,027	2,157	2,408	2,303	2,587
	48	78	2	FR4878OV	2,164	2,164	2,221	2,267	2,390	2,639	2,542	2,822
	48	96	2	FR4896OV	2,340	2,340	2,396	2,446	2,538	2,810	2,900	3,217
Racetrack	30	60	2	FR3060RA	1,197	1,197	1,255	1,277	1,567	1,845	1,668	2,013
	30	72	2	FR3072RA	1,265	1,265	1,337	1,362	1,641	1,985	1,754	2,117
	30	84	2	FR3084RA	1,495	1,495	1,559	1,600	1,738	2,224	1,864	2,421
	30	96	2	FR3096RA	1,565	1,565	1,637	1,681	1,832	2,438	1,962	2,625
	36	60	2	FR3660RA	1,263	1,263	1,331	1,353	1,623	1,930	1,734	2,090
	36	72	2	FR3672RA	1,343	1,343	1,422	1,447	1,755	2,098	1,882	2,269
	36	84	2	FR3684RA	1,580	1,580	1,659	1,701	1,855	2,325	1,999	2,549
	36	96	2	FR3696RA	1,660	1,660	1,753	1,794	1,962	2,551	2,117	2,728
	42	72	2	FR4272RA	1,667	1,667	1,741	1,772	2,056	2,451	2,127	2,735
	42	84	2	FR4284RA	1,921	1,921	1,988	2,032	2,155	2,706	2,301	3,026
	42	96	2	FR4296RA	2,017	2,017	2,086	2,135	2,278	2,904	2,441	3,301

Continued on next page

How to Order

Table Model Number					Top Finish Selection		Options
FR Base Series	36 Top Size	RD Top Shape	WWSQ Top Material Edge Profile	MBK Base Finish	WMW Top Finish	WMW Edge Finish	GSL Super Level Glides

A FR36RDWWSQMBK is a Flat Round series 36" round table with a black powder coat round base and a wood veneer 1.25" thick top with a 1.25" square wood edge profile.

The codes: WMW WMW specify a medium walnut top, with a medium walnut edge.

The code: GSL specifies super level glides.

Specialty Tops

Butcher Block	Ultrafoam	Acrylic	Corian Group A,B	Corian Group C,D	3form Chroma
BBFL Flat	ULFP PVC	AAOP Opaque	C1FL Flat	C2FL Flat	3FFL Flat
BBBN Bullnose	ULFR Raw	AATL Translucent	C1BN Bullnose	C2BN Bullnose	3FBN Bullnose
			C1PR Prism	C2PR Prism	3FPR Prism

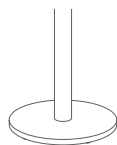

\$					
924	578	1,169	1,084	1,261	1,673
1,170	652	1,627	1,356	1,620	2,673
1,477	742	2,088	1,704	2,062	3,583
2,122	974	2,859	2,215	2,692	4,839
2,397	1,089	3,715	2,659	3,262	6,143
-	1,219	4,818	3,143	3,891	-
-	1,465	6,132	3,794	4,706	-
-	-	-	-	-	-
-	-	4,177	-	-	-
-	-	5,804	-	-	-
-	-	-	-	-	-
-	-	6,782	-	-	-
-	-	-	-	-	-
-	-	-	-	-	-
-	-	-	-	-	-
-	-	-	-	-	-
-	-	-	-	-	-
-	-	-	-	-	-
-	-	-	-	-	-
-	-	-	-	-	-
-	-	-	-	-	-
-	-	-	-	-	-
-	-	-	-	-	-
-	-	-	-	-	-
-	-	-	-	-	-
-	-	-	-	-	-
-	-	-	-	-	-

Options

Base Finishes		
Standard Powder Coat	use finish code	n/c
Polished or Satin Chrome (per base)	use finish code	\$194
Premium Plated (per base)	use finish code	Ⓛ
Custom Powder Coat (set-up charge)	CPC	\$363

Base Options		
Alternate Height Base (per column)	AH	\$66
Super Level Glides (per base)	GSL	\$34
Custom Top Plate Size	CTPS	Ⓛ
6" Column (black wrinkle and powder coat)	COL6	\$194
6" Column (polished or satin chrome)	COLP6	\$248
6" Column (premium plated)	COLPP6	Ⓛ
6" Column (veneer)	COLV6	\$386

Top Materials and Finishes		
Standard Laminates	use manufacturers finish code	n/c
Premium Laminates	PRL	Ⓛ
Custom Wood Veneer	CWV	Ⓛ
Special Pattern Veneer	SPV	Ⓛ
Stain to Match (set-up charge)	STM	\$412

Top Options		
Custom Size	CS	Ⓛ
Custom Shape	CSH	Ⓛ
Custom Radius Corner	CRC	Ⓛ
3" Radius Corner (per corner)	CRL3	\$34
(laminite self edge, ultrafoam, Corian®, 3form chroma)		
3" Wood Radius Corner (per corner)	CRW3	\$82
(not available in LWFL, WWFL, LWPI and WWPI)		

Grommets		
2" Round Metal Grommet – Matte Black	GMBK	\$138
2" Round Metal Grommet – Satin Chrome	GMSC	\$138
2" Round Metal Grommet – Polished Chrome	GMPC	\$138
2" Round Plastic Grommet - Matte Black	GPMBK	\$44
Grommet location	use location code	n/c

Edge Options		
1.75" Thick Edge (per table)	175E	15%
(see edge details for specific profiles)		

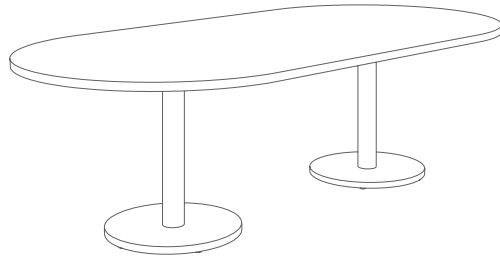

Laminate Tops

Wood Veneer Tops

Self Edge	Vinyl Edges	PVC Edges	Metal Edges	Wood Edges Group A	Wood Edges Group B	Wood Edges Group A	Wood Edges Group B
LLSE Self Edge	LVFL Flat	LPVC PVC	LMFL Flat	LWFL Flat	LWSQ Square	WWFL Flat	WWSQ Square
	LVBP Bumper		LMRB Ribbed	LWTP Tapered Ply	LWAR Arc	WWTP Tapered Ply	WWAR Arc
				LWFP Flat Ply	LWBN Bullnose	WWFP Flat Ply	WWBN Bullnose
					LWPR Prism		WWPR Prism
					LWPI Pivot		WWPI Pivot

Complete Table List Pricing

	Top Size		Base Qty.	Model #	\$							
	48	96	2	FR4896RA	2,120	2,120	2,200	2,250	2,480	3,131	2,849	3,357
	48	120	2	FR48120RA	2,332	2,332	2,433	2,495	2,723	3,470	3,153	3,810
	48	144	3	FR48144RA	3,085	3,085	3,200	3,277	3,518	4,328	4,030	4,753
	48	168	3	FR48168RA	3,300	3,300	3,423	3,510	3,769	4,697	4,345	5,179
	60	120	2	FR60120RA	2,804	2,804	2,913	2,989	3,104	4,010	3,553	4,407
	60	144	3	FR60144RA	3,709	3,709	3,810	3,902	4,157	4,997	4,489	5,466
	60	168	3	FR60168RA	3,974	3,974	4,085	4,190	4,451	5,392	5,123	6,242
		24	24	1	FR2424SQ	559	559	615	669	767	936	777
30		30	1	FR3030SQ	619	619	687	734	880	1,061	880	1,148
36		36	1	FR3636SQ	699	699	767	836	996	1,216	1,032	1,321
42		42	1	FR4242SQ	908	908	984	1,033	1,242	1,500	1,336	1,626
48		48	1	FR4848SQ	1,125	1,125	1,214	1,273	1,481	1,777	1,592	1,926
	24	30	1	FR2430RE	588	588	635	647	828	1,014	909	1,094
	24	36	1	FR2436RE	617	617	669	683	891	1,072	957	1,160
	24	42	1	FR2442RE	770	770	815	830	1,052	1,251	1,122	1,346
	24	48	1	FR2448RE	805	805	861	879	1,124	1,346	1,204	1,451
	24	60	2	FR2460RE	1,117	1,117	1,177	1,198	1,458	1,711	1,547	1,831
	24	72	2	FR2472RE	1,175	1,175	1,245	1,269	1,555	1,845	1,658	1,983
	24	84	2	FR2484RE	1,392	1,392	1,457	1,497	1,637	2,125	1,750	2,300
	24	96	2	FR2496RE	1,450	1,450	1,521	1,565	1,719	2,246	1,841	2,436
	30	36	1	FR3036RE	662	662	707	722	944	1,142	1,016	1,238
	30	42	1	FR3042RE	817	817	869	887	1,159	1,381	1,241	1,492
	30	48	1	FR3048RE	854	854	910	930	1,204	1,445	1,295	1,564
	30	60	2	FR3060RE	1,185	1,185	1,249	1,273	1,565	1,841	1,668	1,977
	30	72	2	FR3072RE	1,253	1,253	1,330	1,357	1,641	1,954	1,755	2,104
	30	84	2	FR3084RE	1,485	1,485	1,551	1,596	1,736	2,224	1,859	2,407
	30	96	2	FR3096RE	1,555	1,555	1,628	1,676	1,831	2,397	1,967	2,602

Continued on next page

How to Order

Table Model Number					Top Finish Selection		Options	
FR Base Series	4896 Top Size	RA Top Shape	WWSQ Top Material Edge Profile	MBK Base Finish	WMW Top Finish	WMW Edge Finish	GMBK Matte Black Grommet	C Location "C"

A FR4896RAWWSQMBK is a Flat Round series 48" x 96" racetrack table with two black powder coat rounds bases and a wood veneer 1.25" thick top with a 1.25" square wood edge profile.

The codes: WMW WMW specify a medium walnut top, with a medium walnut edge.

The code: GMBK specifies a matte black 2" diameter metal grommet.

The code: C specifies the location of the grommet.

Specialty Tops

Butcher Block	Ultrafoam	Acrylic	Corian Group A,B	Corian Group C,D	3form Chroma
BBFL Flat	ULFP PVC	AAOP Opaque	C1FL Flat	C2FL Flat	3FFL Flat
BBBN Bullnose	ULFR Raw	AATL Translucent	C1BN Bullnose	C2BN Bullnose	3FBN Bullnose
			C1PR Prism	C2PR Prism	3FPR Prism

\$					
-	-	-	-	-	-
-	-	-	-	-	-
-	-	-	-	-	-
-	-	-	-	-	-
-	-	-	-	-	-
-	-	-	-	-	-
-	-	-	-	-	-
-	-	-	-	-	-
-	-	-	-	-	-
994	592	1,171	999	1,152	1,640
1,263	652	1,632	1,251	1,479	2,628
1,595	742	2,095	1,586	1,905	3,531
2,307	963	2,867	2,075	2,499	4,775
2,713	1,191	3,825	2,605	3,150	6,182
1,111	611	1,383	1,115	1,298	2,222
1,245	646	1,667	1,228	1,444	2,549
1,559	802	1,912	1,459	1,712	3,005
1,614	842	2,097	1,573	1,861	3,338
2,113	1,164	-	2,068	2,421	4,300
2,364	1,232	-	2,307	2,730	4,965
2,547	1,424	-	-	-	-
2,730	1,492	-	-	-	-
1,415	695	1,887	1,391	1,658	3,056
1,780	857	2,250	1,649	1,959	3,614
1,840	900	2,499	1,801	2,153	4,042
2,388	1,242	3,278	2,337	2,775	5,128
2,693	1,321	4,020	2,623	3,144	6,000
2,876	1,526	-	-	-	-
3,059	1,608	-	-	-	-

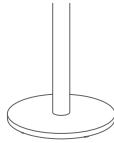

Options

Base Finishes		
Standard Powder Coat	use finish code	n/c
Polished or Satin Chrome (per base)	use finish code	\$194
Premium Plated (per base)	use finish code	Ⓡ
Custom Powder Coat (set-up charge)	CPC	\$363
Base Options		
Alternate Height Base (per column)	AH	\$66
Super Level Glides (per base)	GSL	\$34
Custom Top Plate Size	CTPS	Ⓡ
6" Column (black wrinkle and powder coat)	COL6	\$194
6" Column (polished or satin chrome)	COLP6	\$248
6" Column (premium plated)	COLPP6	Ⓡ
6" Column (veneer)	COLV6	\$386
Top Materials and Finishes		
Standard Laminates	use manufacturers finish code	n/c
Premium Laminates	PRL	Ⓡ
Custom Wood Veneer	CWW	Ⓡ
Special Pattern Veneer	SPV	Ⓡ
Stain to Match (set-up charge)	STM	\$412
Top Options		
Custom Size	CS	Ⓡ
Custom Shape	CSH	Ⓡ
Custom Radius Corner	CRC	Ⓡ
3" Radius Corner (per corner)	CRL3	\$34
(laminates self edge, ultrafoam, Corian®, 3form chroma)		
3" Wood Radius Corner (per corner)	CRW3	\$82
(not available in LWFL, WWFL, LWPI and WWPI)		
Grommets		
2" Round Metal Grommet - Matte Black	GMBK	\$138
2" Round Metal Grommet - Satin Chrome	GMSC	\$138
2" Round Metal Grommet - Polished Chrome	GMPC	\$138
2" Round Plastic Grommet - Matte Black	GPMBK	\$44
Grommet location	use location code	n/c
Edge Options		
1.75" Thick Edge (per table)	175E	15%
<i>(see edge details for specific profiles)</i>		

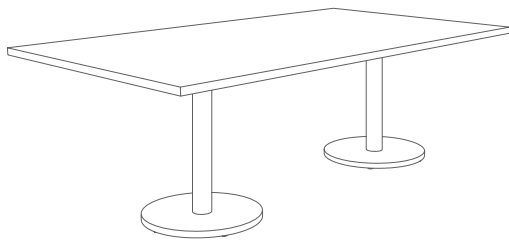

Laminate Tops

Wood Veneer Tops

Self Edge	Vinyl Edges	PVC Edges	Metal Edges	Wood Edges Group A	Wood Edges Group B	Wood Edges Group A	Wood Edges Group B
LLSE Self Edge	LVFL Flat	LPVC PVC	LMFL Flat	LWFL Flat	LWSQ Square	WWFL Flat	WWSQ Square
	LVBP Bumper		LMRB Ribbed	LWTP Tapered Ply	LWAR Arc	WWTP Tapered Ply	WWAR Arc
				LWFP Flat Ply	LWBN Bullnose	WWFP Flat Ply	WWBN Bullnose
					LWPR Prism		WWPR Prism
					LWPI Pivot		WWPI Pivot

Complete Table List Pricing

	Top Size		Base Qty.	Model #	\$								
Rectangle 	36	42	1	FR3642RE	865	865	924	943	1,214	1,459	1,307	1,579	
	36	48	1	FR3648RE	905	905	967	988	1,268	1,529	1,365	1,657	
	36	60	2	FR3660RE	1,250	1,250	1,323	1,347	1,623	1,919	1,734	2,067	
	36	72	2	FR3672RE	1,333	1,333	1,410	1,438	1,751	2,086	1,876	2,255	
	36	84	2	FR3684RE	1,578	1,578	1,647	1,693	1,855	2,321	1,995	2,518	
	36	96	2	FR3696RE	1,660	1,660	1,743	1,787	1,960	2,495	2,113	2,714	
	42	72	2	FR4272RE	1,657	1,657	1,722	1,755	2,056	2,451	2,127	2,544	
	42	84	2	FR4284RE	1,913	1,913	1,983	2,032	2,170	2,678	2,406	2,991	
	42	96	2	FR4296RE	2,007	2,007	2,084	2,137	2,291	2,904	2,548	3,034	
	48	96	2	FR4896RE	2,118	2,118	2,193	2,248	2,476	3,131	2,849	3,336	
	48	120	2	FR48120RE	2,330	2,330	2,428	2,495	2,719	3,357	3,153	3,641	
	48	144	3	FR48144RE	3,065	3,065	3,160	3,240	3,485	4,131	3,987	4,522	
	48	168	3	FR48168RE	3,293	3,293	3,393	3,485	3,716	4,413	4,277	4,848	
	60	120	2	FR60120RE	2,791	2,791	2,883	2,964	3,139	3,783	3,557	4,181	
	60	144	3	FR60144RE	3,661	3,661	3,764	3,861	4,128	4,713	4,717	5,239	
	60	168	3	FR60168RE	3,970	3,970	4,043	4,155	4,411	5,337	5,071	6,016	
	Arc Rectangle 	30	60	2	FR3060AR	1,198	1,198	1,253	1,275	1,532	1,845	1,668	1,989
		30	72	2	FR3072AR	1,289	1,289	1,339	1,364	1,646	2,043	1,754	2,117
30		84	2	FR3084AR	1,467	1,467	1,548	1,588	1,736	2,185	1,862	2,421	
30		96	2	FR3096AR	1,540	1,540	1,627	1,670	1,845	2,382	1,962	2,625	
36		60	2	FR3660AR	1,283	1,283	1,325	1,347	1,623	1,985	1,734	2,090	
36		72	2	FR3672AR	1,386	1,386	1,434	1,460	1,748	2,156	1,876	2,269	
36		84	2	FR3684AR	1,565	1,565	1,650	1,691	1,855	2,325	1,995	2,524	
36		96	2	FR3696AR	1,650	1,650	1,743	1,783	1,962	2,579	2,117	2,728	

Continued on next page

How to Order

Table Model Number				Top Finish Selection		Options		
FR Base Series	3642 Top Size	RE Top Shape	WWSQ Top Material Edge Profile	MBK Base Finish	WMW Top Finish	WMW Edge Finish	GMBK Matte Black Grommet	G Location "G" Grommet
A FR3642REWWSQMBK is a Flat Round series 36" x 42" rectangle table with a black powder coat round base and a wood veneer 1.25" thick top with a 1.25" square wood edge profile.					The codes: WMW WMW specify a medium walnut top, with a medium walnut edge.		The code: GMBK specifies a matte black 2" diameter metal grommet.	The code: G specifies the location of the grommet.

Specialty Tops

Butcher Block	Ultrafoam	Acrylic	Corian Group A,B	Corian Group C,D	3form Chroma
BBFL Flat	ULFP PVC	AAOP Opaque	C1FL Flat	C2FL Flat	3FFL Flat
BBBN Bullnose	ULFR Raw	AATL Translucent	C1BN Bullnose	C2BN Bullnose	3FBN Bullnose
			C1PR Prism	C2PR Prism	3FPR Prism

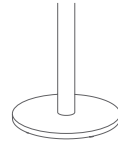

\$					
1,994	912	-	2,029	2,206	4,211
2,060	961	2,902	2,357	2,441	4,717
2,656	1,316	4,020	2,629	3,148	6,008
3,008	1,411	4,603	2,956	3,574	6,994
3,358	1,631	5,819	-	-	-
3,703	1,728	6,155	-	-	-
-	1,744	-	-	-	-
-	1,976	-	-	-	-
-	2,087	7,142	-	-	-
-	2,208	-	-	-	-
-	-	-	-	-	-
-	-	-	-	-	-
-	-	-	-	-	-
-	-	-	-	-	-
-	-	-	-	-	-
-	-	-	-	-	-
-	-	-	-	-	-
-	-	-	-	-	-
-	-	-	-	-	-
-	-	-	-	-	-
-	-	-	-	-	-
-	-	-	-	-	-
-	-	-	-	-	-
-	-	-	-	-	-

Options

Base Finishes		
Standard Powder Coat	use finish code	n/c
Polished or Satin Chrome (per base)	use finish code	\$194
Premium Plated (per base)	use finish code	Ⓢ
Custom Powder Coat (set-up charge)	CPC	\$363

Base Options		
Alternate Height Base (per column)	AH	\$66
Super Level Glides (per base)	GSL	\$34
Custom Top Plate Size	CTPS	Ⓢ
6" Column (black wrinkle and powder coat)	COL6	\$194
6" Column (polished or satin chrome)	COLP6	\$248
6" Column (premium plated)	COLPP6	Ⓢ
6" Column (veneer)	COLV6	\$386

Top Materials and Finishes		
Standard Laminates	use manufacturers finish code	n/c
Premium Laminates	PRL	Ⓢ
Custom Wood Veneer	CWV	Ⓢ
Special Pattern Veneer	SPV	Ⓢ
Stain to Match (set-up charge)	STM	\$412

Top Options		
Custom Size	CS	Ⓢ
Custom Shape	CSH	Ⓢ
Custom Radius Corner	CRC	Ⓢ
3" Radius Corner (per corner)	CRL3	\$34
(laminates self edge, ultrafoam, Corian®, 3form chroma)		
3" Wood Radius Corner (per corner)	CRW3	\$82
(not available in LWFL, WWFL, LWPI and WWPI)		

Grommets		
2" Round Metal Grommet - Matte Black	GMBK	\$138
2" Round Metal Grommet - Satin Chrome	GMSC	\$138
2" Round Metal Grommet - Polished Chrome	GMPC	\$138
2" Round Plastic Grommet - Matte Black	GPMBK	\$44
Grommet location	use location code	n/c

Edge Options		
1.75" Thick Edge (per table)	175E	15%
(see edge details for specific profiles)		

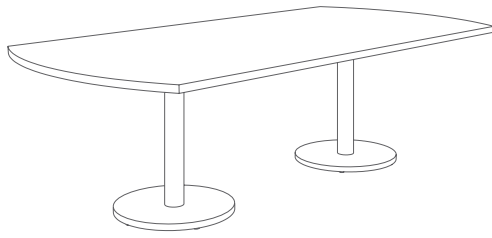

Laminate Tops

Wood Veneer Tops

Self Edge	Vinyl Edges	PVC Edges	Metal Edges	Wood Edges Group A	Wood Edges Group B	Wood Edges Group A	Wood Edges Group B
LLSE Self Edge	LVFL Flat	LPVC PVC	LMFL Flat	LWFL Flat	LWSQ Square	WWFL Flat	WWSQ Square
	LVBP Bumper		LMRB Ribbed	LWTP Tapered Ply	LWAR Arc	WWTP Tapered Ply	WWAR Arc
				LWFP Flat Ply	LWBN Bullnose	WWFP Flat Ply	WWBN Bullnose
					LWPR Prism		WWPR Prism
					LWPI Pivot		WWPI Pivot

Complete Table List Pricing

	Top Size		Base Qty.	Model #	\$							
Arc Rectangle 	42	72	2	FR4272AR	1,772	1,772	1,794	1,830	2,056	2,502	2,127	2,791
	42	84	2	FR4284AR	1,900	1,900	1,983	2,027	2,143	2,764	2,406	3,052
	42	96	2	FR4296AR	1,997	1,997	2,084	2,132	2,283	2,962	2,548	3,301
	48	96	2	FR4896AR	2,140	2,140	2,194	2,244	2,476	3,188	2,849	3,415
	48	120	2	FR48120AR	2,314	2,314	2,433	2,495	2,719	3,528	3,153	3,810
	48	144	3	FR48144AR	3,044	3,044	3,166	3,240	3,526	4,386	4,038	4,812
	48	168	3	FR48168AR	3,266	3,266	3,393	3,477	3,771	4,866	4,347	5,215
	60	120	2	FR60120AR	2,777	2,777	2,922	2,999	3,162	4,038	3,582	4,384
	60	144	3	FR60144AR	3,653	3,653	3,797	3,888	4,207	5,053	4,511	5,724
	60	168	3	FR60168AR	3,929	3,929	4,075	4,180	4,495	5,450	4,834	6,114

How to Order

Table Model Number					Top Finish Selection		Options	
FR Base Series	4272 Top Size	AR Top Shape	WWSQ Top Material Edge Profile	MBK Base Finish	WMW Top Finish	WMW Edge Finish	GMBK Matte Black Grommet	G Location "G"
A FR4272ARWWSQMBK is a Flat Round series 42" x 72" arc rectangle table with two black powder coat round bases and a wood veneer 1.25" thick top with a 1.25" square wood edge profile.					The codes: WMW WMW specify a medium walnut top, with a medium walnut edge.		The code: GMBK specifies a matte black 2" diameter metal grommet.	
							The code: G specifies the location of the grommet.	

Specialty Tops

Butcher Block	Ultrafoam	Acrylic	Corian Group A,B	Corian Group C,D	3form Chroma
BBFL Flat	ULFP PVC	AAOP Opaque	C1FL Flat	C2FL Flat	3FFL Flat
BBBN Bullnose	ULFR Raw	AATL Translucent	C1BN Bullnose	C2BN Bullnose	3FBN Bullnose
			C1PR Prism	C2PR Prism	3FPR Prism

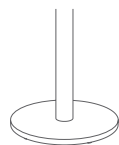

\$					
-	-	-	-	-	-
-	-	-	-	-	-
-	-	-	-	-	-
-	-	-	-	-	-
-	-	-	-	-	-
-	-	-	-	-	-
-	-	-	-	-	-
-	-	-	-	-	-

Options

Base Finishes		
Standard Powder Coat	use finish code	n/c
Polished or Satin Chrome (per base)	use finish code	\$194
Premium Plated (per base)	use finish code	🔒
Custom Powder Coat (set-up charge)	CPC	\$363

Base Options		
Alternate Height Base (per column)	AH	\$66
Super Level Glides (per base)	GSL	\$34
Custom Top Plate Size	CTPS	🔒
6" Column (black wrinkle and powder coat)	COL6	\$194
6" Column (polished or satin chrome)	COLP6	\$248
6" Column (premium plated)	COLPP6	🔒
6" Column (veneer)	COLV6	\$386

Top Materials and Finishes		
Standard Laminates	use manufacturers finish code	n/c
Premium Laminates	PRL	🔒
Custom Wood Veneer	CWV	🔒
Special Pattern Veneer	SPV	🔒
Stain to Match (set-up charge)	STM	\$412

Top Options		
Custom Size	CS	🔒
Custom Shape	CSH	🔒
Custom Radius Corner	CRC	🔒
3" Radius Corner (per corner)	CRL3	\$34
(laminate self edge, ultrafoam, Corian®, 3form chroma)		
3" Wood Radius Corner (per corner)	CRW3	\$82
(not available in LWFL, WWFL, LWPI and WWPI)		

Grommets		
2" Round Metal Grommet - Matte Black	GMBK	\$138
2" Round Metal Grommet - Satin Chrome	GMSC	\$138
2" Round Metal Grommet - Polished Chrome	GMPC	\$138
2" Round Plastic Grommet - Matte Black	GPMBK	\$44
Grommet location	use location code	n/c

Edge Options		
1.75" Thick Edge (per table)	175E	15%
(see edge details for specific profiles)		

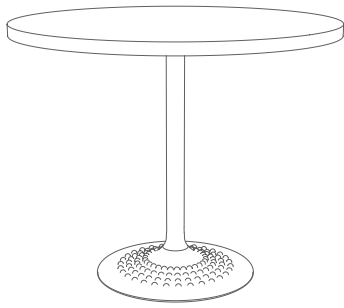

Laminate Tops

Wood Veneer Tops

Self Edge	Vinyl Edges	PVC Edges	Metal Edges	Wood Edges Group A	Wood Edges Group B	Wood Edges Group A	Wood Edges Group B
LLSE Self Edge	LVFL Flat	LPVC PVC	LMFL Flat	LWFL Flat	LWSQ Square	WWFL Flat	WWSQ Square
	LVBP Bumper		LMRB Ribbed	LWTP Tapered Ply	LWAR Arc	WWTP Tapered Ply	WWAR Arc
				LWFP Flat Ply	LWBN Bullnose	WWFP Flat Ply	WWBN Bullnose
					LWPR Prism		WWPR Prism
					LWPI Pivot		WWPI Pivot

Complete Table List Pricing

	Top Size	Base Qty.	Model #	\$								
Round 	24	1	KN24RD	629	629	679	727	837	1,006	847	1,078	
	30	1	KN30RD	719	719	781	814	980	1,161	980	1,248	
	36	1	KN36RD	829	829	901	947	1,136	1,346	1,162	1,451	
	42	1	KN42RD	960	960	1,040	1,040	1,282	1,540	1,376	1,666	
	48	1	KN48RD	1,093	1,093	1,184	1,211	1,451	1,747	1,562	1,896	
	54	1	KN54RD	1,244	1,244	1,349	1,378	1,707	2,318	1,845	2,532	
	60	1	KN60RD	1,421	1,421	1,534	1,588	1,827	2,401	2,186	2,627	
Square 	24 24	1	KN2424SQ	629	629	685	739	837	1,006	847	1,078	
	30 30	1	KN3030SQ	719	719	787	834	980	1,161	980	1,248	
	36 36	1	KN3636SQ	829	829	897	966	1,126	1,346	1,162	1,451	
	42 42	1	KN4242SQ	978	978	1,054	1,103	1,312	1,570	1,406	1,696	
	48 48	1	KN4848SQ	1,135	1,135	1,224	1,283	1,491	1,787	1,602	1,936	
Rectangle 	24 30	1	KN2430RE	688	688	735	747	928	1,114	1,009	1,194	
	24 36	1	KN2436RE	747	747	799	813	1,021	1,202	1,087	1,290	
	24 42	1	KN2442RE	810	810	855	870	1,092	1,291	1,162	1,386	
	24 48	1	KN2448RE	875	875	931	949	1,194	1,416	1,274	1,521	
	30 36	1	KN3036RE	792	792	837	852	1,074	1,272	1,146	1,368	
	30 42	1	KN3042RE	857	857	909	927	1,199	1,421	1,281	1,532	
	30 48	1	KN3048RE	924	924	980	1,000	1,274	1,515	1,365	1,634	
	36 42	1	KN3642RE	905	905	964	983	1,254	1,499	1,347	1,619	
	36 48	1	KN3648RE	975	975	1,037	1,058	1,338	1,599	1,435	1,727	

How to Order















Table Model Number				Top Finish Selection		Options	
KN Base Series	36 Top Size	RD Top Shape	WWSQ Top Material Edge Profile	MBK Base Finish	WMW Top Finish	WMW Edge Finish	GSL Super Level Glides

A KN36RDWWSQMBK is a Knobhill series 36" round table with a black powder coat round base and a wood veneer 1.25" thick top with a 1.25" square wood edge profile.

The codes: WMW WMW specify a medium walnut top, with a medium walnut edge.

The code: GSL specifies super level glides.

Specialty Tops

Butcher Block	Ultrafoam	Acrylic	Corian Group A,B	Corian Group C,D	3form Chroma
 BBFL Flat	 ULFP PVC	 AAOP Opaque	 C1FL Flat	 C2FL Flat	 3FFL Flat
 BBBN Bullnose	 ULFR Raw	 AATL Translucent	 C1BN Bullnose	 C2BN Bullnose	 3FBN Bullnose
			 C1PR Prism	 C2PR Prism	 3FPR Prism

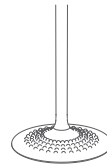

Options

Base Finishes

Powder Coat	use finish code	n/c
Polished or Satin Chrome (per base)	use finish code	\$194
Premium Plated (per base)	use finish code	Ⓛ
Custom Powder Coat (set-up charge)	CPC	\$363

Base Options

Alternate Height Base (per column)	AH	\$66
Super Level Glides (per base)	GSL	\$34
Custom Top Plate Size	CTPS	Ⓛ

Top Materials and Finishes

Standard Laminates	use manufacturers finish code	n/c
Premium Laminates	PRL	Ⓛ
Custom Wood Veneer	CWV	Ⓛ
Special Pattern Veneer	SPV	Ⓛ
Stain to Match (set-up charge)	STM	\$412

Top Options

Custom Size	CS	Ⓛ
Custom Shape	CSH	Ⓛ
Custom Radius Corner	CRC	Ⓛ
3" Radius Corner (per corner)	CRL3	\$34
(laminates self edge, ultrafoam, Corian®, 3form chroma)		
3" Wood Radius Corner (per corner)	CRW3	\$82
(not available in LWFL, WWFL, LWPI and WWPI)		

Edge Options

1.75" Thick Edge (per table)	175E	15%
<i>(see edge details for specific profiles)</i>		

\$					
994	648	1,239	1,154	1,331	1,743
1,270	752	1,727	1,456	1,720	2,773
1,607	872	2,218	1,834	2,192	3,713
2,162	1,014	2,899	2,255	2,732	4,879
2,467	1,159	3,785	2,729	3,332	6,213
-	1,329	4,928	3,253	4,001	-
-	1,475	6,142	3,804	4,716	-
1,064	662	1,241	1,069	1,222	1,710
1,363	752	1,732	1,351	1,579	2,728
1,725	872	2,225	1,716	2,035	3,661
2,377	1,033	2,937	2,145	2,569	4,845
2,723	1,201	3,835	2,615	3,160	6,192
1,211	711	1,483	1,215	1,398	2,322
1,375	776	1,797	1,358	1,574	2,679
1,599	842	1,952	1,499	1,752	3,045
1,684	912	2,167	1,643	1,931	3,408
1,545	825	2,017	1,521	1,788	3,186
1,820	897	2,290	1,689	1,999	3,654
1,910	970	2,569	1,871	2,223	4,112
2,034	952	-	2,069	2,246	4,251
2,130	1,031	2,972	2,427	2,511	4,787



Laminate Tops

Wood Veneer Tops

Self Edge	Vinyl Edges	PVC Edges	Metal Edges	Wood Edges Group A	Wood Edges Group B	Wood Edges Group A	Wood Edges Group B
LLSE Self Edge	LVFL Flat	LPVC PVC	LMFL Flat	LWFL Flat	LWSQ Square	WWFL Flat	WWSQ Square
	LVBP Bumper		LMRB Ribbed	LWTP Tapered Ply	LWAR Arc	WWTP Tapered Ply	WWAR Arc
				LWFP Flat Ply	LWBN Bullnose	WWFP Flat Ply	WWBN Bullnose
					LWPR Prism		WWPR Prism
					LWPI Pivot		WWPI Pivot

Complete Table List Pricing

	Top Size	Base Qty.	Model #	\$								
Round 	24	1	MH24RD	439	439	489	537	647	816	657	888	
	30	1	MH30RD	499	499	561	594	760	941	760	1,028	
	36	1	MH36RD	629	629	701	747	936	1,146	962	1,251	
	42	1	MH42RD	730	730	810	810	1,052	1,310	1,146	1,436	
	48	1	MH48RD	933	933	1,024	1,051	1,291	1,587	1,402	1,736	
	54	1	MH54RD	1,044	1,044	1,149	1,178	1,507	2,118	1,645	2,332	
	60	1	MH60RD	1,221	1,221	1,334	1,388	1,627	2,201	1,986	2,427	
Square 	24 24	1	MH2424SQ	439	439	495	549	647	816	657	888	
	30 30	1	MH3030SQ	499	499	567	614	760	941	760	1,028	
	36 36	1	MH3636SQ	629	629	697	766	926	1,146	962	1,251	
	42 42	1	MH4242SQ	718	718	794	843	1,052	1,310	1,146	1,436	
	48 48	1	MH4848SQ	935	935	1,024	1,083	1,291	1,587	1,402	1,736	
Rectangle 	24 30	1	MH2430RE	468	468	515	527	708	894	789	974	
	24 36	1	MH2436RE	547	547	599	613	821	1,002	887	1,090	
	24 42	1	MH2442RE	580	580	625	640	862	1,061	932	1,156	
	24 48	1	MH2448RE	615	615	671	689	934	1,156	1,014	1,261	
	30 36	1	MH3036RE	592	592	637	652	874	1,072	946	1,168	
	30 42	1	MH3042RE	627	627	679	697	969	1,191	1,051	1,302	
	30 48	1	MH3048RE	664	664	720	740	1,014	1,255	1,105	1,374	
	36 42	1	MH3642RE	675	675	734	753	1,024	1,269	1,117	1,389	
	36 48	1	MH3648RE	815	815	877	898	1,178	1,439	1,275	1,567	

How to Order

Table Model Number

Top Finish Selection

Options

MH Base Series **36** Top Size **RD** Top Shape **WWSQ** Top Material Edge Profile **MBK** Base Finish

WMW Top Finish **WMW** Edge Finish

GSL Super Level Glides

A MH36RDWWSQMBK is a Manhattan series 36" round table with a black powder coat round base and a wood veneer 1.25" thick top with a 1.25" square wood edge profile.

The codes: WMW WMW specify a medium walnut top, with a medium walnut edge.

The code: GSL specifies super level glides.

Specialty Tops

Butcher Block	Ultrafoam	Acrylic	Corian Group A,B	Corian Group C,D	3form Chroma
BBFL Flat	ULFP PVC	AAOP Opaque	C1FL Flat	C2FL Flat	3FFL Flat
BBBN Bullnose	ULFR Raw	AATL Translucent	C1BN Bullnose	C2BN Bullnose	3FBN Bullnose
			C1PR Prism	C2PR Prism	3FPR Prism

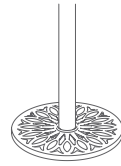

Options

Base Finishes

Powder Coat	use finish code	n/c
Custom Powder Coat (set-up charge)	CPC	\$363

Base Options

Alternate Height Base (per column)	AH	\$66
Super Level Glides (per base)	GSL	\$34
Custom Top Plate Size	CTPS	Ⓛ

Top Materials and Finishes

Standard Laminates	use manufacturers finish code	n/c
Premium Laminates	PRL	Ⓛ
Custom Wood Veneer	CWV	Ⓛ
Special Pattern Veneer	SPV	Ⓛ
Stain to Match (set-up charge)	STM	\$412

Top Options

Custom Size	CS	Ⓛ
Custom Shape	CSH	Ⓛ
Custom Radius Corner	CRC	Ⓛ
3" Radius Corner (per corner)	CRL3	\$34
(laminates self edge, ultrafoam, Corian®, 3form chroma)		
3" Wood Radius Corner (per corner)	CRW3	\$82
(not available in LWFL, WWFL, LWPI and WWPI)		

Edge Options

1.75" Thick Edge (per table)	175E	15%
(see edge details for specific profiles)		

\$					
804	458	1,049	964	1,141	1,553
1,050	532	1,507	1,236	1,500	2,553
1,407	672	2,018	1,634	1,992	3,513
1,932	784	2,669	2,025	2,502	4,649
2,307	999	3,625	2,569	3,172	6,053
-	1,129	4,728	3,053	3,801	-
-	1,275	5,942	3,604	4,516	-
874	472	1,051	879	1,032	1,520
1,143	532	1,512	1,131	1,359	2,508
1,525	672	2,025	1,516	1,835	3,461
2,117	773	2,677	1,885	2,309	4,585
2,523	1,001	3,635	2,415	2,960	5,992
991	491	1,263	995	1,178	2,102
1,175	576	1,597	1,158	1,374	2,479
1,369	612	1,722	1,269	1,522	2,815
1,424	652	1,907	1,383	1,671	3,148
1,345	625	1,817	1,321	1,588	2,986
1,590	667	2,060	1,459	1,769	3,424
1,650	710	2,309	1,611	1,963	3,852
1,804	722	-	1,839	2,016	4,021
1,970	871	2,812	2,267	2,351	4,627

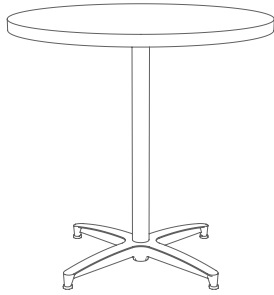

Laminate Tops

Wood Veneer Tops

Self Edge	Vinyl Edges	PVC Edges	Metal Edges	Wood Edges Group A	Wood Edges Group B	Wood Edges Group A	Wood Edges Group B
LLSE Self Edge	LVFL Flat LVBP Bumper	LPVC PVC	LMFL Flat LMRB Ribbed	LWFL Flat LWTP Tapered Ply LWFP Flat Ply	LWSQ Square LWAR Arc LWBN Bullnose LWPR Prism LWPI Pivot	WWFL Flat WWTP Tapered Ply WWFP Flat Ply	WWSQ Square WWAR Arc WWBN Bullnose WWPR Prism WWPI Pivot

Complete Table List Pricing

	Top Size	Base Qty.	Base Style	Model #	\$							
Round 	30	1	X	MAX30RD	589	589	651	684	850	1,031	850	1,118
	36	1	X	MAX36RD	769	769	841	887	1,076	1,286	1,102	1,391
	42	1	X	MAX42RD	870	870	950	950	1,192	1,450	1,286	1,576
	48	1	X	MAX48RD	1,073	1,073	1,164	1,191	1,431	1,727	1,542	1,876
	54	1	X	MAX54RD	1,184	1,184	1,289	1,318	1,647	2,258	1,785	2,472
	60	1	X	MAX60RD	1,361	1,361	1,474	1,528	1,767	2,341	2,126	2,567
Oval 	36 72	2	V	MAV3672OV	1,264	1,264	1,315	1,340	1,523	1,745	1,696	1,912
	42 54	2	T	MAT4254OV	1,331	1,331	1,358	1,422	1,563	1,890	1,714	1,950
	42 78	2	T	MAT4278OV	1,623	1,623	1,664	1,709	1,857	2,078	2,000	2,247
	42 84	2	T	MAT4284OV	1,679	1,679	1,733	1,777	1,907	2,158	2,053	2,337
	48 78	2	T	MAT4878OV	1,714	1,714	1,771	1,817	1,940	2,189	2,092	2,372
	48 96	2	T	MAT4896OV	1,890	1,890	1,946	1,996	2,088	2,360	2,450	2,767
Racetrack 	30 60	2	V	MAV3060RA	1,097	1,097	1,155	1,177	1,467	1,745	1,568	1,913
	30 72	2	V	MAV3072RA	1,165	1,165	1,237	1,262	1,541	1,885	1,654	2,017
	30 84	2	V	MAV3084RA	1,395	1,395	1,459	1,500	1,638	2,124	1,764	2,321
	30 96	2	V	MAV3096RA	1,465	1,465	1,537	1,581	1,732	2,338	1,862	2,525
	36 60	2	V	MAV3660RA	1,163	1,163	1,231	1,253	1,523	1,830	1,634	1,990
	36 72	2	V	MAV3672RA	1,243	1,243	1,322	1,347	1,655	1,998	1,782	2,169
	36 84	2	V	MAV3684RA	1,480	1,480	1,559	1,601	1,755	2,225	1,899	2,449
	36 96	2	V	MAV3696RA	1,560	1,560	1,653	1,694	1,862	2,451	2,017	2,628
	42 72	2	T	MAT4272RA	1,417	1,417	1,491	1,522	1,806	2,201	1,877	2,485
	42 84	2	T	MAT4284RA	1,671	1,671	1,738	1,782	1,905	2,456	2,051	2,776
	42 96	2	T	MAT4296RA	1,767	1,767	1,836	1,885	2,028	2,654	2,191	3,051
	48 96	2	T	MAT4896RA	1,870	1,870	1,950	2,000	2,230	2,881	2,599	3,107

Continued on next page

How to Order















Table Model Number				Top Finish Selection		Options	
MAX Base Series	36 Top Size	RD Top Shape	WWSQ Top Material Edge Profile	MBK Base Finish	WMW Top Finish	WMW Edge Finish	AH Alternate Height Base

A MAX36RDWWSQMBK is a Mark IV series 36" round table with a black powder coat X-base and a wood veneer 1.25" thick top with a 1.25" square wood edge profile.

The codes: WMW WMW specify a medium walnut top, with a medium walnut edge.

The code: AH specifies alternate height base.

Specialty Tops

Butcher Block	Ultrafoam	Acrylic	Corian Group A,B	Corian Group C,D	3form Chroma
 BBFL Flat	 ULFP PVC	 AAOP Opaque	 C1FL Flat	 C2FL Flat	 3FFL Flat
 BBBN Bullnose	 ULFR Raw	 AATL Translucent	 C1BN Bullnose	 C2BN Bullnose	 3FBN Bullnose
			 C1PR Prism	 C2PR Prism	 3FPR Prism

\$					
1,140	622	1,597	1,326	1,590	2,643
1,547	812	2,158	1,774	2,132	3,653
2,072	924	2,809	2,165	2,642	4,789
2,447	1,139	3,765	2,709	3,312	6,193
-	1,269	4,868	3,193	3,941	-
-	1,415	6,082	3,744	4,656	-
-	-	-	-	-	-
-	-	4,167	-	-	-
-	-	5,554	-	-	-
-	-	-	-	-	-
-	-	6,332	-	-	-
-	-	-	-	-	-
-	-	-	-	-	-
-	-	-	-	-	-
-	-	-	-	-	-
-	-	-	-	-	-
-	-	-	-	-	-
-	-	-	-	-	-
-	-	-	-	-	-
-	-	-	-	-	-
-	-	-	-	-	-
-	-	-	-	-	-
-	-	-	-	-	-

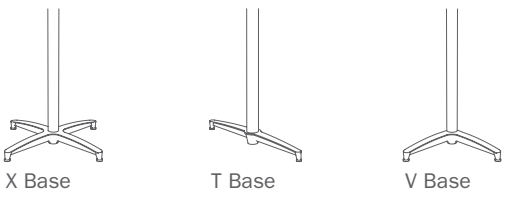

Options

Base Finishes		
Standard Powder Coat	use finish code	n/c
Polished or Satin Aluminum (per base)	use finish code	\$152
Custom Powder Coat (set-up charge)	CPC	\$363

Base Options		
Alternate Height Base (per column)	AH	\$66
Super Level Glides (per base)	GSL	\$34
Locking Casters 2" Twin Wheel (qty. 4)	TWC2	\$56
Tilt-top - (standard cable release)	TMX/TMT	\$270 X-base/ \$418 T-base
Folding	FM	\$270 T-base

Top Materials and Finishes		
Standard Laminates	use manufacturers finish code	n/c
Premium Laminates	PRL	☑
Custom Wood Veneer	CWW	☑
Special Pattern Veneer	SPV	☑
Stain to Match (set-up charge)	STM	\$412

Top Options		
Custom Size	CS	☑
Custom Shape	CSH	☑
Custom Radius Corner	CRC	☑
3" Radius Corner (per corner)	CRL3	\$34
(laminate self edge, ultrafoam, Corian®, 3form chroma)		
3" Wood Radius Corner (per corner)	CRW3	\$82
(not available in LWFL, WWFL, LWPI and WWPI)		
Ganging Clips (1 set includes 2 male and 2 female clips)	GC	\$148

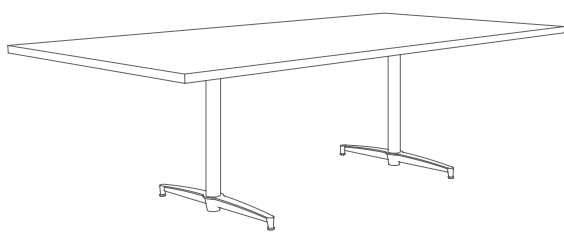

Grommets		
2" Round Metal Grommet - Matte Black	GMBK	\$138
2" Round Metal Grommet - Satin Chrome	GMSC	\$138
2" Round Metal Grommet - Polished Chrome	GMPC	\$138
2" Round Plastic Grommet - Matte Black	GPMBK	\$44
Grommet location	use location code	n/c

Edge Options		
1.75" Thick Edge (per table)	175E	15%
(see edge details for specific profiles)		



Laminate Tops					Wood Veneer Tops			
Self Edge	Vinyl Edges	PVC Edges	Metal Edges	Wood Edges Group A	Wood Edges Group B	Wood Edges Group A	Wood Edges Group B	
LLSE Self Edge	LVFL Flat	LPVC PVC	LMFL Flat	LWFL Flat	LWSQ Square	WWFL Flat	WWSQ Square	
	LVBP Bumper		LMRB Ribbed	LWTP Tapered Ply	LWAR Arc	WWTP Tapered Ply	WWAR Arc	
				LWFP Flat Ply	LWBN Bullnose	WWFP Flat Ply	WWBN Bullnose	
					LWPR Prism		WWPR Prism	
					LWPI Pivot		WWPI Pivot	

Complete Table List Pricing

	Top Size	Base Qty.	Base Style	Model #	\$							
Square 	24 24	1	X	MAX2424SQ	529	529	585	639	737	906	747	978
	30 30	1	X	MAX3030SQ	589	589	657	704	850	1,031	850	1,118
	36 36	1	X	MAX3636SQ	769	769	837	906	1,066	1,286	1,102	1,391
	42 42	1	X	MAX4242SQ	958	958	1,034	1,083	1,292	1,550	1,386	1,676
	48 48	1	X	MAX4848SQ	1,075	1,075	1,164	1,223	1,431	1,727	1,542	1,876
Rectangle 	18 48	2	T	MAT1848RE	791	791	842	857	960	1,209	1,026	1,237
	18 60	2	T	MAT1860RE	841	841	901	919	1,040	1,322	1,104	1,380
	18 72	2	T	MAT1872RE	888	888	954	975	1,124	1,436	1,192	1,522
	18 84	2	T	MAT1884RE	1,040	1,040	1,092	1,124	1,269	1,577	1,363	1,707
	18 96	2	T	MAT1896RE	1,124	1,124	1,171	1,209	1,326	1,690	1,425	1,812
	24 30	1	X	MAX2430RE	558	558	605	617	798	984	879	1,064
	24 36	1	X	MAX2436RE	687	687	739	753	961	1,142	1,027	1,230
	24 42	1	X	MAX2442RE	720	720	765	780	1,002	1,201	1,072	1,296
	24 48	2	T	MAT2448RE	845	845	901	919	1,164	1,386	1,244	1,491
	24 60	2	T	MAT2460RE	907	907	967	988	1,248	1,501	1,337	1,621
	24 72	2	T	MAT2472RE	965	965	1,035	1,059	1,345	1,635	1,448	1,773
	24 84	2	T	MAT2484RE	1,182	1,182	1,247	1,287	1,427	1,915	1,540	2,090
	24 96	2	T	MAT2496RE	1,240	1,240	1,311	1,355	1,509	2,036	1,631	2,226
	30 36	1	X	MAX3036RE	732	732	777	792	1,014	1,212	1,086	1,308
	30 42	1	X	MAX3042RE	767	767	819	837	1,109	1,331	1,191	1,442
	30 48	1	X	MAX3048RE	804	804	860	880	1,154	1,395	1,245	1,514
	30 60	2	V	MAV3060RE	1,085	1,085	1,149	1,173	1,465	1,741	1,568	1,877
	30 72	2	V	MAV3072RE	1,153	1,153	1,230	1,257	1,541	1,854	1,655	2,004
	30 84	2	V	MAV3084RE	1,385	1,385	1,451	1,496	1,636	2,124	1,759	2,307
	30 96	2	V	MAV3096RE	1,455	1,455	1,528	1,576	1,731	2,297	1,867	2,502

Continued on next page

How to Order

Table Model Number					Top Finish Selection		Options
MAT Base Series	2448 Top Size	RE Top Shape	WWSQ Top Material Edge Profile	MBK Base Finish	WMW Top Finish	WMW Edge Finish	TWC2 Casters
A MAT2448REWWSQMBK is a Mark IV series 24" x 48" rectangle table with two black powder coat T-bases and a wood veneer 1.25" thick top with a 1.25" square wood edge profile.					The codes: WMW WMW specify a medium walnut top, with a medium walnut edge.		The code: TWC2 specifies 2" twin wheel locking casters.

Specialty Tops

Butcher Block	Ultrafoam	Acrylic	Corian Group A,B	Corian Group C,D	3form Chroma
BBFL Flat	ULFP PVC	AAOP Opaque	C1FL Flat	C2FL Flat	3FFL Flat
BBBN Bullnose	ULFR Raw	AATL Translucent	C1BN Bullnose	C2BN Bullnose	3FBN Bullnose
			C1PR Prism	C2PR Prism	3FPR Prism

\$					
964	562	1,141	969	1,122	1,610
1,233	622	1,602	1,221	1,449	2,598
1,665	812	2,165	1,656	1,975	3,601
2,357	1,013	2,917	2,125	2,549	4,825
2,663	1,141	3,775	2,555	3,100	6,132
1,322	820	-	-	-	-
1,390	880	-	-	-	-
1,503	933	-	-	-	-
1,662	1,111	-	-	-	-
1,775	1,166	-	-	-	-
1,081	581	1,353	1,085	1,268	2,192
1,315	716	1,737	1,298	1,514	2,619
1,509	752	1,862	1,409	1,662	2,955
1,654	882	2,137	1,613	1,901	3,378
1,903	954	-	1,858	2,211	4,090
2,154	1,022	-	2,097	2,520	4,755
2,337	1,214	-	-	-	-
2,520	1,282	-	-	-	-
1,485	765	1,957	1,461	1,728	3,126
1,730	807	2,200	1,599	1,909	3,564
1,790	850	2,449	1,751	2,103	3,992
2,288	1,142	3,178	2,237	2,675	5,028
2,593	1,221	3,920	2,523	3,044	5,900
2,776	1,426	-	-	-	-
2,959	1,508	-	-	-	-



Options

Base Finishes		
Standard Powder Coat	use finish code	n/c
Polished or Satin Aluminum (per base)	use finish code	\$152
Custom Powder Coat (set-up charge)	CPC	\$363

Base Options		
Alternate Height Base (per column)	AH	\$66
Super Level Glides (per base)	GSL	\$34
Locking Casters 2" Twin Wheel (qty. 4)	TWC2	\$56
Tilt-top - (standard cable release)	TMX/TMT	\$270 X-base/ \$418 T-base
Folding	FM	\$270 T-base

Top Materials and Finishes		
Standard Laminates	use manufacturers finish code	n/c
Premium Laminates	PRL	Ⓛ
Custom Wood Veneer	CWV	Ⓛ
Special Pattern Veneer	SPV	Ⓛ
Stain to Match (set-up charge)	STM	\$412

Top Options		
Custom Size	CS	Ⓛ
Custom Shape	CSH	Ⓛ
Custom Radius Corner	CRC	Ⓛ
3" Radius Corner (per corner)	CRL3	\$34
(laminated self edge, ultrafoam, Corian®, 3form chroma)		
3" Wood Radius Corner (per corner)	CRW3	\$82
(not available in LWFL, WWFL, LWPI and WWPI)		
Ganging Clips (1 set includes 2 male and 2 female clips)	GC	\$148

Grommets		
2" Round Metal Grommet - Matte Black	GMBK	\$138
2" Round Metal Grommet - Satin Chrome	GMSC	\$138
2" Round Metal Grommet - Polished Chrome	GMPC	\$138
2" Round Plastic Grommet - Matte Black	GPMBK	\$44
Grommet location	use location code	n/c

Edge Options		
1.75" Thick Edge (per table)	175E	15%
(see edge details for specific profiles)		

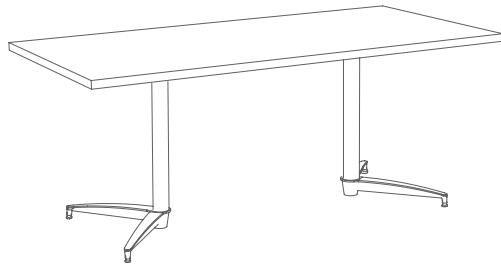

Laminate Tops

Wood Veneer Tops

Self Edge	Vinyl Edges	PVC Edges	Metal Edges	Wood Edges Group A	Wood Edges Group B	Wood Edges Group A	Wood Edges Group B
LLSE Self Edge	LVFL Flat	LPVC PVC	LMFL Flat	LWFL Flat	LWSQ Square	WWFL Flat	WWSQ Square
	LVBP Bumper		LMRB Ribbed	LWTP Tapered Ply	LWAR Arc	WWTP Tapered Ply	WWAR Arc
				LWFP Flat Ply	LWBN Bullnose	WWFP Flat Ply	WWBN Bullnose
					LWPR Prism		WWPR Prism
					LWPI Pivot		WWPI Pivot

Complete Table List Pricing

	Top Size	Base Qty.	Base Style	Model #	\$							
Rectangle 	36 42	1	X	MAX3642RE	915	915	974	993	1,264	1,509	1,357	1,629
	36 48	1	X	MAX3648RE	955	955	1,017	1,038	1,318	1,579	1,415	1,707
	36 60	2	V	MAV3660RE	1,150	1,150	1,223	1,247	1,523	1,819	1,634	1,967
	36 72	2	V	MAV3672RE	1,233	1,233	1,310	1,338	1,651	1,986	1,776	2,155
	36 84	2	V	MAV3684RE	1,478	1,478	1,547	1,593	1,755	2,221	1,895	2,418
	36 96	2	V	MAV3696RE	1,560	1,560	1,643	1,687	1,860	2,395	2,013	2,614
	42 72	2	T	MAT4272RE	1,407	1,407	1,472	1,505	1,806	2,201	1,877	2,294
	42 84	2	T	MAT4284RE	1,663	1,663	1,733	1,782	1,920	2,428	2,156	2,741
	42 96	2	T	MAT4296RE	1,757	1,757	1,834	1,887	2,041	2,654	2,298	2,784
	48 96	2	T	MAT4896RE	1,868	1,868	1,943	1,998	2,226	2,881	2,599	3,086
Half Round 	24 48	2	T	MAT2448HR	853	853	903	919	1,043	1,296	1,106	1,343
	30 60	2	T	MAT3060HR	988	988	1,056	1,079	1,197	1,493	1,281	1,627
	36 72	2	T	MAT3672HR	1,339	1,339	1,420	1,446	1,563	1,920	1,771	2,033
Arc Rectangle 	30 60	2	V	MAV3060AR	1,098	1,098	1,153	1,175	1,432	1,745	1,568	1,889
	30 72	2	V	MAV3072AR	1,189	1,189	1,239	1,264	1,546	1,943	1,654	2,017
	30 84	2	V	MAV3084AR	1,367	1,367	1,448	1,488	1,636	2,085	1,762	2,321
	30 96	2	V	MAV3096AR	1,440	1,440	1,527	1,570	1,745	2,282	1,862	2,525
	36 60	2	V	MAV3660AR	1,183	1,183	1,225	1,247	1,523	1,885	1,634	1,990
	36 72	2	V	MAV3672AR	1,286	1,286	1,334	1,360	1,648	2,056	1,776	2,169
	36 84	2	V	MAV3684AR	1,465	1,465	1,550	1,591	1,755	2,225	1,895	2,424
	36 96	2	V	MAV3696AR	1,550	1,550	1,643	1,683	1,862	2,479	2,017	2,628

Continued on next page

How to Order

Table Model Number					Top Finish Selection		Options	
MAV Base Series	3672 Top Size	RE Top Shape	WWSQ Top Material Edge Profile	MBK Base Finish	WMW Top Finish	WMW Edge Finish	GMBK Matte Black Grommet	E Location "E" Grommet

A MAV3672REWWSQMBK is a Mark IV series 36" x 72" rectangle table with two black powder coat V-bases and a wood veneer 1.25" thick top with a 1.25" square wood edge profile.

The codes: WMW WMW specify a medium walnut top, with a medium walnut edge.

The code: GMBK specifies a matte black 2" diameter metal grommet.

The code: E specifies the location of the grommet.

Specialty Tops

Butcher Block	Ultrafoam	Acrylic	Corian Group A,B	Corian Group C,D	3form Chroma
BBFL Flat	ULFP PVC	AAOP Opaque	C1FL Flat	C2FL Flat	3FFL Flat
BBBN Bullnose	ULFR Raw	AATL Translucent	C1BN Bullnose	C2BN Bullnose	3FBN Bullnose
			C1PR Prism	C2PR Prism	3FPR Prism

\$					
2,044	962	-	2,079	2,256	4,261
2,110	1,011	2,952	2,407	2,491	4,767
2,556	1,216	3,920	2,529	3,048	5,908
2,908	1,311	4,503	2,856	3,474	6,894
3,258	1,531	5,719	-	-	-
3,603	1,628	6,055	-	-	-
-	1,494	-	-	-	-
-	1,726	-	-	-	-
-	1,837	6,892	-	-	-
-	1,958	-	-	-	-
-	-	-	-	-	-
-	-	-	-	-	-
-	-	-	-	-	-
-	-	-	-	-	-
-	-	-	-	-	-
-	-	-	-	-	-
-	-	-	-	-	-
-	-	-	-	-	-
-	-	-	-	-	-
-	-	-	-	-	-
-	-	-	-	-	-
-	-	-	-	-	-
-	-	-	-	-	-
-	-	-	-	-	-
-	-	-	-	-	-

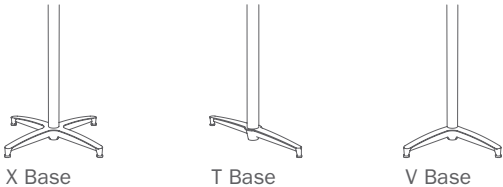

Options

Base Finishes		
Standard Powder Coat	use finish code	n/c
Polished or Satin Aluminum (per base)	use finish code	\$152
Custom Powder Coat (set-up charge)	CPC	\$363

Base Options		
Alternate Height Base (per column)	AH	\$66
Super Level Glides (per base)	GSL	\$34
Locking Casters 2" Twin Wheel (qty. 4)	TWC2	\$56
Tilt-top - (standard cable release)	TMX/TMT	\$270 X-base/ \$418 T-base
Folding	FM	\$270 T-base

Top Materials and Finishes		
Standard Laminates	use manufacturers finish code	n/c
Premium Laminates	PRL	Ⓛ
Custom Wood Veneer	CWV	Ⓛ
Special Pattern Veneer	SPV	Ⓛ
Stain to Match (set-up charge)	STM	\$412

Top Options		
Custom Size	CS	Ⓛ
Custom Shape	CSH	Ⓛ
Custom Radius Corner	CRC	Ⓛ
3" Radius Corner (per corner)	CRL3	\$34
(lamine self edge, ultrafoam, Corian®, 3form chroma)		
3" Wood Radius Corner (per corner)	CRW3	\$82
(not available in LWFL, WWFL, LWPI and WWPI)		
Ganging Clips (1 set includes 2 male and 2 female clips)	GC	\$148

Grommets		
2" Round Metal Grommet - Matte Black	GMBK	\$138
2" Round Metal Grommet - Satin Chrome	GMSC	\$138
2" Round Metal Grommet - Polished Chrome	GMPC	\$138
2" Round Plastic Grommet - Matte Black	GPMBK	\$44
Grommet location	use location code	n/c

Edge Options		
1.75" Thick Edge (per table)	175E	15%
(see edge details for specific profiles)		



Laminate Tops

Wood Veneer Tops

Self Edge	Vinyl Edges	PVC Edges	Metal Edges	Wood Edges Group A	Wood Edges Group B	Wood Edges Group A	Wood Edges Group B
LLSE Self Edge	LVFL Flat	LPVC PVC	LMFL Flat	LWFL Flat	LWSQ Square	WWFL Flat	WWSQ Square
	LVBP Bumper		LMRB Ribbed	LWTP Tapered Ply	LWAR Arc	WWTP Tapered Ply	WWAR Arc
				LWFP Flat Ply	LWBN Bullnose	WWFP Flat Ply	WWBN Bullnose
					LWPR Prism		WWPR Prism
					LWPI Pivot		WWPI Pivot















Complete Table List Pricing

	Top Size		Base Qty.	Base Style	Model #	\$								
Arc Rectangle 	42	72	2	T	MAT4272AR	1,522	1,522	1,544	1,580	1,806	2,252	1,877	2,541	
	42	84	2	T	MAT4284AR	1,650	1,650	1,733	1,777	1,893	2,514	2,156	2,802	
	42	96	2	T	MAT4296AR	1,747	1,747	1,834	1,882	2,033	2,712	2,298	3,051	
	48	96	2	T	MAT4896AR	1,890	1,890	1,944	1,994	2,226	2,938	2,599	3,165	
Boat Shape 	36	42	72	2	V	MAV3672BS	1,651	1,651	1,616	1,663	1,897	2,321	2,056	2,533
	36	48	84	2	T	MAT3684BS	1,856	1,856	1,921	1,977	2,282	2,677	2,477	2,924
	36	48	96	2	T	MAT3696BS	1,975	1,975	2,039	2,096	2,448	2,795	2,664	3,053

How to Order

Table Model Number					Top Finish Selection		Options	
MAT Base Series	4296 Top Size	AR Top Shape	WWSQ Top Material Edge Profile	MBK Base Finish	WMW Top Finish	WMW Edge Finish	GMBK Matte Black Grommet	G Location "G" Grommet
A MAT4296ARWWSQMBK is a Mark IV series 42" x 96" arc rectangle table with two black powder coat T-bases and a wood veneer 1.25" thick top with a 1.25" square wood edge profile.					The codes: WMW WMW specify a medium walnut top, with a medium walnut edge.		The code: GMBK specifies a matte black 2" diameter metal grommet.	
							The code: G specifies the location of the grommet.	

Specialty Tops

Butcher Block	Ultrafoam	Acrylic	Corian Group A,B	Corian Group C,D	3form Chroma
 BBFL Flat	 ULFP PVC	 AAOP Opaque	 C1FL Flat	 C2FL Flat	 3FFL Flat
 BBBN Bullnose	 ULFR Raw	 AATL Translucent	 C1BN Bullnose	 C2BN Bullnose	 3FBN Bullnose
			 C1PR Prism	 C2PR Prism	 3FPR Prism

\$					
-	-	-	-	-	-
-	-	-	-	-	-
-	-	-	-	-	-
-	-	-	-	-	-
-	-	-	-	-	-
-	-	-	-	-	-
-	-	-	-	-	-

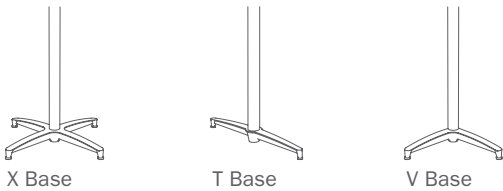

Options

Base Finishes		
Standard Powder Coat	use finish code	n/c
Polished or Satin Aluminum (per base)	use finish code	\$152
Custom Powder Coat (set-up charge)	CPC	\$363

Base Options		
Alternate Height Base (per column)	AH	\$66
Super Level Glides (per base)	GSL	\$34
Locking Casters 2" Twin Wheel (qty. 4)	TWC2	\$56
Tilt-top - (standard cable release)	TMX/TMT	\$270 X-base/ \$418 T-base
Folding	FM	\$270 T-base

Top Materials and Finishes		
Standard Laminates	use manufacturers finish code	n/c
Premium Laminates	PRL	🕒
Custom Wood Veneer	CWV	🕒
Special Pattern Veneer	SPV	🕒
Stain to Match (set-up charge)	STM	\$412

Top Options		
Custom Size	CS	🕒
Custom Shape	CSH	🕒
Custom Radius Corner	CRC	🕒
3" Radius Corner (per corner)	CRL3	\$34
(laminate self edge, ultrafoam, Corian®, 3form chroma)		
3" Wood Radius Corner (per corner)	CRW3	\$82
(not available in LWFL, WWFL, LWPI and WWPI)		
Ganging Clips (1 set includes 2 male and 2 female clips)	GC	\$148

Grommets		
2" Round Metal Grommet - Matte Black	GMBK	\$138
2" Round Metal Grommet - Satin Chrome	GMSC	\$138
2" Round Metal Grommet - Polished Chrome	GMPC	\$138
2" Round Plastic Grommet - Matte Black	GPMBK	\$44
Grommet location	use location code	n/c

Edge Options		
1.75" Thick Edge (per table)	175E	15%
(see edge details for specific profiles)		

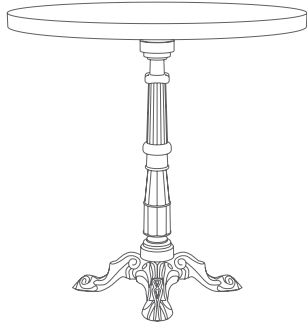

Laminate Tops

Wood Veneer Tops

Self Edge	Vinyl Edges	PVC Edges	Metal Edges	Wood Edges Group A	Wood Edges Group B	Wood Edges Group A	Wood Edges Group B
LLSE Self Edge	LVFL Flat	LPVC PVC	LMFL Flat	LWFL Flat	LWSQ Square	WWFL Flat	WWSQ Square
	LVBP Bumper		LMRB Ribbed	LWTP Tapered Ply	LWAR Arc	WWTP Tapered Ply	WWAR Arc
				LWFP Flat Ply	LWBN Bullnose	WWFP Flat Ply	WWBN Bullnose
					LWPR Prism		WWPR Prism
					LWPI Pivot		WWPI Pivot















Complete Table List Pricing

	Top Size		Base Qty.	Model #	\$							
Round	24		1	ME24RD	489	489	539	588	697	866	707	938
	30		1	ME30RD	549	549	611	644	810	991	810	1,078
Square	24	24	1	ME2424SQ	490	490	545	600	697	866	707	938
	30	30	1	ME3030SQ	549	549	617	664	810	991	810	1,078
Rectangle	24	30	1	ME2430RE	518	518	566	578	759	944	839	1,025

How to Order

Table Model Number					Top Finish Selection		Options
ME Base Series	36 Top Size	RD Top Shape	WWSQ Top Material Edge Profile	MBK Base Finish	WMW Top Finish	WMW Edge Finish	GSL Super Level Glides
A ME36RDWWSQMBK is a Medici series 36" round table with black powder coat decorative base and a wood veneer 1.25" thick top with a 1.25" square wood edge profile.					The codes: WMW WMW specify a medium walnut top, with a medium walnut edge.		The code: GSL specifies super level glides.

Specialty Tops

Butcher Block	Ultrafoam	Acrylic	Corian Group A,B	Corian Group C,D	3form Chroma
 BBFL Flat	 ULFP PVC	 AAOP Opaque	 C1FL Flat	 C2FL Flat	 3FFL Flat
 BBBN Bullnose	 ULFR Raw	 AATL Translucent	 C1BN Bullnose	 C2BN Bullnose	 3FBN Bullnose
			 C1PR Prism	 C2PR Prism	 3FPR Prism

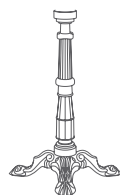

Options

Base Finishes		
Standard Powder Coat	use finish code	n/c
Custom Powder Coat (set-up charge)	CPC	\$363

Base Options		
Alternate Height Base (per column)	AH	\$166
Super Level Glides (per base)	GSL	\$34
Custom Top Plate Size	CTPS	🕒

Top Materials and Finishes		
Standard Laminates	use manufacturers finish code	n/c
Premium Laminates	PRL	🕒
Custom Wood Veneer	CWV	🕒
Special Pattern Veneer	SPV	🕒
Stain to Match (set-up charge)	STM	\$412

Top Options		
Custom Size	CS	🕒
Custom Shape	CSH	🕒
Custom Radius Corner	CRC	🕒
3" Radius Corner (per corner)	CRL3	\$34
(laminate self edge, ultrafoam, Corian®, 3form chroma)		
3" Wood Radius Corner (per corner)	CRW3	\$82
(not available in LWFL, WWFL, LWPI and WWPI)		

Edge Options		
1.75" Thick Edge (per table)	175E	15%
<i>(see edge details for specific profiles)</i>		





\$					
854	508	1,099	1,014	1,191	1,603
1,101	582	1,558	1,286	1,550	2,603

924	522	1,101	930	1,082	1,570
1,193	582	1,562	1,181	1,410	2,558

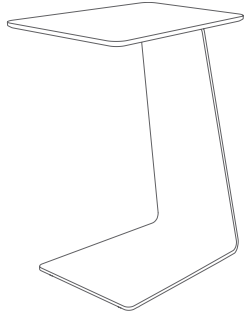
1,041	541	1,313	1,045	1,228	2,153
-------	-----	-------	-------	-------	-------

Move Tops



Laminate	Veneer	Corian Group A, B, C	3form Chroma
			
LMOV Ply	WMOV Wood	CMOV Corian	3MOV Chroma

Complete Table List Pricing

	Top Size			Table Height	Model #	\$			
Trapezoid	18	13	15	25	MOV	688	760	780	906



How to Order

Table Model Number

MOV Table Series	WMOV Top Material	MBK Base Finish
----------------------------	-----------------------------	---------------------------

A MOVWMOVMBK is a Move table with a matte black powder coat base and a wood veneer top.

Top Finish Selection

WNM Top Finish

The code: WNM specifies a natural maple top.

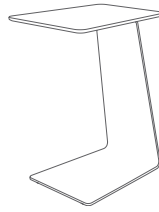

Options

Base Finishes

Powder Coat	use finish code	n/c
Satin Chrome (per base)	use finish code	\$400
Premium Plated (per base)*	use finish code	🕒
Custom Powder Coat (set-up charge)	CPC	\$363

Top Materials and Finishes

Standard Laminates	use manufacturers finish code	n/c
Premium Laminates	PRL	🕒
Custom Wood Veneer	CWV	🕒
Stain to Match (set-up charge)	STM	\$412

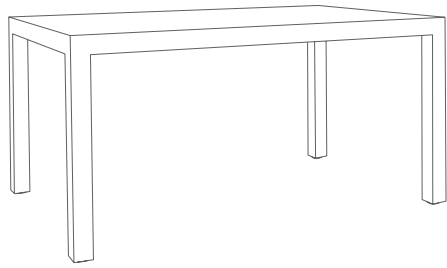

*Premium plated polished not available on Move tables.



Laminate Wood Veneer



Complete Table List Pricing

	Top Size	Overall Table Height	Model #	\$		
Square 	24 24	29"	PA2424SQ	1,441	1,988	
	30 30	29"	PA3030SQ	1,575	2,171	
	36 36	29"	PA3636SQ	1,785	2,429	
	42 42	29"	PA4242SQ	1,977	2,712	
	48 48	29"	PA4848SQ	2,180	3,104	
				-	-	
Rectangle 	24 30	29"	PA2430RE	1,477	2,053	
	24 36	29"	PA2436RE	1,548	2,139	
	24 42	29"	PA2442RE	1,620	2,226	
	24 48	29"	PA2448RE	1,673	2,275	
	24 60	29"	PA2460RE	1,867	2,566	
	24 72	29"	PA2472RE	2,022	2,753	
					-	-
	30 36	29"	PA3036RE	1,633	2,242	
	30 42	29"	PA3042RE	1,708	2,375	
	30 48	29"	PA3048RE	1,838	2,530	
	30 60	29"	PA3060RE	2,002	2,740	
	30 72	29"	PA3072RE	2,183	3,035	
					-	-
	36 42	29"	PA3642RE	1,828	2,528	
	36 48	29"	PA3648RE	1,950	2,716	
	36 60	29"	PA3660RE	2,150	3,000	
	36 72	29"	PA3672RE	2,348	3,260	

How to Order

Table Model Number				Finish Selection	Options
PA Base Series	3636 Top Size	SQ Top Shape	VEN Material	WNW Top, edge and leg finish	PAH1 Alternate Height Base - Below 29"

A PA3636SQLAM is a Parsons series 36" x 36" square table with wood veneer top, edge and legs.

The code: WNW specifies a natural walnut top.

The code: PAH1 specifies alternate height base below 29".

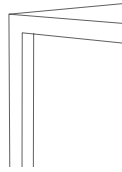

Options

Base Options

Alternate Table Height - Below 29" (per table)	PAH1	\$300
Alternate Table Height - Above 29" (per table)	PAH2	\$900

Top Materials and Finishes

Standard Laminates	use manufacturers finish code	n/c
Premium Laminates	PRL	Ⓛ
Custom Wood Veneer	CWV	Ⓛ
Special Pattern Veneer	SPV	Ⓛ
Stain to Match (set-up charge)	STM	\$412

Top Options

Custom Size	CS	Ⓛ
Custom Shape	CSH	Ⓛ

Laminate Tops

Wood Veneer Tops

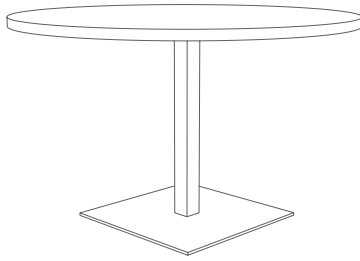

Self Edge	Vinyl Edges	PVC Edges	Metal Edges	Wood Edges Group A	Wood Edges Group B	Wood Edges Group A	Wood Edges Group B
LLSE Self Edge	LVFL Flat	LPVC PVC	LMFL Flat	LWFL Flat	LWSQ Square	WWFL Flat	WWSQ Square
	LVBP Bumper		LMRB Ribbed	LWTP Tapered Ply	LWAR Arc	WWTP Tapered Ply	WWAR Arc
				LWFP Flat Ply	LWBN Bullnose	WWFP Flat Ply	WWBN Bullnose
					LWPR Prism		WWPR Prism
					LWPI Pivot		WWPI Pivot

Complete Table List Pricing

	Top Size	Base Qty.	Model #	\$								
Round	24	1	PL24RD	624	624	674	722	832	1,001	842	1,073	
	30	1	PL30RD	684	684	746	779	945	1,126	945	1,213	
	36	1	PL36RD	924	924	996	1,042	1,231	1,441	1,257	1,546	
	42	1	PL42RD	1,025	1,025	1,105	1,105	1,347	1,605	1,441	1,731	
	48	1	PL48RD	1,253	1,253	1,344	1,371	1,611	1,907	1,722	2,056	
	54	1	PL54RD	1,364	1,364	1,469	1,498	1,827	2,438	1,965	2,652	
	60	1	PL60RD	1,541	1,541	1,654	1,708	1,947	2,521	2,306	2,747	
Racetrack	30	60	2	PL3060RA	1,327	1,327	1,385	1,407	1,697	1,975	1,798	2,143
	30	72	2	PL3072RA	1,395	1,395	1,467	1,492	1,771	2,115	1,884	2,247
	30	84	2	PL3084RA	1,625	1,625	1,689	1,730	1,868	2,354	1,994	2,551
	30	96	2	PL3096RA	1,695	1,695	1,767	1,811	1,962	2,568	2,092	2,755
	36	60	2	PL3660RA	1,713	1,713	1,781	1,803	2,073	2,380	2,184	2,540
	36	72	2	PL3672RA	1,793	1,793	1,872	1,897	2,205	2,548	2,332	2,719
	36	84	2	PL3684RA	2,030	2,030	2,109	2,151	2,305	2,775	2,449	2,999
	36	96	2	PL3696RA	2,110	2,110	2,203	2,244	2,412	3,001	2,567	3,178
	42	72	2	PL4272RA	1,877	1,877	1,951	1,982	2,266	2,661	2,337	2,945
	42	84	2	PL4284RA	2,131	2,131	2,198	2,242	2,365	2,916	2,511	3,236
	42	96	2	PL4296RA	2,227	2,227	2,296	2,345	2,488	3,114	2,651	3,511
	48	96	2	PL4896RA	2,580	2,580	2,660	2,710	2,940	3,591	3,309	3,817
	48	120	2	PL48120RA	2,792	2,792	2,893	2,955	3,183	3,930	3,613	4,270
	48	144	3	PL48144RA	3,775	3,775	3,890	3,967	4,208	5,018	4,720	5,443
	48	168	3	PL48168RA	3,990	3,990	4,113	4,200	4,459	5,387	5,035	5,869
	60	120	2	PL60120RA	3,064	3,064	3,173	3,249	3,364	4,270	3,813	4,667
	60	144	3	PL60144RA	4,099	4,099	4,200	4,292	4,547	5,387	4,879	5,856
	60	168	3	PL60168RA	4,364	4,364	4,475	4,580	4,841	5,782	5,513	6,632

Continued on next page

How to Order















Table Model Number					Top Finish Selection		Options
PL Base Series	36 Top Size	RD Top Shape	WWSQ Top Material Edge Profile	MBK Base Finish	WMW Top Finish	WMW Edge Finish	AH Alternate Height Base

A PL36RDWWSQMBK is a Platform series 36" round table with a black powder coat square base and a wood veneer 1.25" thick top with a 1.25" square wood edge profile.

The codes: WMW WMW specify a medium walnut top, with a medium walnut edge.

The code: AH specifies alternate height base.

Specialty Tops

Butcher Block	Ultrafoam	Acrylic	Corian Group A,B	Corian Group C,D	3form Chroma
 <p>BBFL Flat</p>  <p>BBBN Bullnose</p>	 <p>ULFP PVC</p>  <p>ULFR Raw</p>	 <p>AAOP Opaque</p>  <p>AATL Translucent</p>	 <p>C1FL Flat</p>  <p>C1BN Bullnose</p>  <p>C1PR Prism</p>	 <p>C2FL Flat</p>  <p>C2BN Bullnose</p>  <p>C2PR Prism</p>	 <p>3FFL Flat</p>  <p>3FBN Bullnose</p>  <p>3FPR Prism</p>

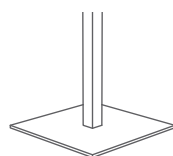

Single Column Base

Options

Base Finishes

Standard Powder Coat	use finish code	n/c
Polished or Satin Chrome (per base)	use finish code	\$194
Premium Plated (per base)	use finish code	Ⓟ
Custom Powder Coat (set-up charge)	CPC	\$363

Base Options

Alternate Height Base (per column)	AH	\$66
Nylon Octagon Glides (per base)	GNO	\$34
Custom Top Plate Size	CTPS	Ⓟ

Top Materials and Finishes

Standard Laminates	use manufacturers finish code	n/c
Premium Laminates	PL	Ⓟ
Custom Wood Veneer	CWV	Ⓟ
Special Pattern Veneer	SPV	Ⓟ
Stain to Match (set-up charge)	STM	\$412

Top Options

Custom Size	CS	Ⓟ
Custom Shape	CSH	Ⓟ
Custom Radius Corner	CRC	Ⓟ
3" Radius Corner (per corner)	CRL3	\$34
(laminite self edge, ultrafoam, Corian®, 3form chroma)		
3" Wood Radius Corner (per corner)	CRW3	\$82
(not available in LWFL, WWFL, LWPI and WWPI)		

Grommets

2" Round Metal Grommet – Matte Black	GMBK	\$138
2" Round Metal Grommet – Satin Chrome	GMSC	\$138
2" Round Metal Grommet – Polished Chrome	GMPC	\$138
2" Round Plastic Grommet - Matte Black	GPMBK	\$44
Grommet location	use location code	n/c

Edge Options

1.75" Thick Edge (per table)	175E	15%
(see edge details for specific profiles)		

\$					
989	643	1,234	1,149	1,326	1,738
1,235	717	1,692	1,421	1,685	2,738
1,702	967	2,313	1,929	2,287	3,808
2,227	1,079	2,964	2,320	2,797	4,944
2,627	1,319	3,945	2,889	3,492	6,373
-	1,449	5,048	3,373	4,121	-
-	1,595	6,262	3,924	4,836	-
-	-	-	-	-	-
-	-	-	-	-	-
-	-	-	-	-	-
-	-	-	-	-	-
-	-	-	-	-	-
-	-	-	-	-	-
-	-	-	-	-	-
-	-	-	-	-	-
-	-	-	-	-	-
-	-	-	-	-	-
-	-	-	-	-	-
-	-	-	-	-	-
-	-	-	-	-	-
-	-	-	-	-	-
-	-	-	-	-	-
-	-	-	-	-	-

Laminate Tops

Wood Veneer Tops

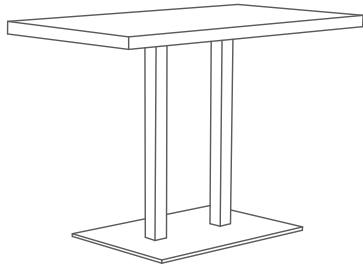

Self Edge	Vinyl Edges	PVC Edges	Metal Edges	Wood Edges Group A	Wood Edges Group B	Wood Edges Group A	Wood Edges Group B
LLSE Self Edge	LVFL Flat LVBP Bumper	LPVC PVC	LMFL Flat LMRB Ribbed	LWFL Flat LWTP Tapered Ply LWFP Flat Ply	LWSQ Square LWAR Arc LWBN Bullnose LWPR Prism LWPI Pivot	WWFL Flat WWTP Tapered Ply WWFP Flat Ply	WWSQ Square WWAR Arc WWBN Bullnose WWPR Prism WWPI Pivot

Complete Table List Pricing

	Top Size	Base Qty.	Model #	\$								
Square	24 24	1	PL2424SQ	624	624	680	734	832	1,001	842	1,073	
	30 30	1	PL3030SQ	684	684	752	799	945	1,126	945	1,213	
	36 36	1	PL3636SQ	924	924	992	1,061	1,221	1,441	1,257	1,546	
	42 42	1	PL4242SQ	1,013	1,013	1,089	1,138	1,347	1,605	1,441	1,731	
	48 48	1	PL4848SQ	1,255	1,255	1,344	1,403	1,611	1,907	1,722	2,056	
Rectangle	24 30	1	PL2430RE	653	653	700	712	893	1,079	974	1,159	
	24 36	1	PL2436RE	842	842	894	908	1,116	1,297	1,182	1,385	
	24 42	1	PL2442RE	875	875	920	935	1,157	1,356	1,227	1,451	
	24 42	1	PLD2442RE	1,067	1,067	1,112	1,127	1,349	1,549	1,419	1,644	
	24 48	1	PL2448RE	910	910	966	984	1,229	1,451	1,309	1,556	
	24 48	1	PLD2448RE	1,102	1,102	1,159	1,176	1,421	1,644	1,502	1,748	
	24 60	2	PL2460RE	870	1,247	1,307	1,328	1,588	1,841	1,677	1,961	
	24 72	2	PL2472RE	1,305	1,305	1,375	1,399	1,685	1,975	1,788	2,113	
	24 84	2	PL2484RE	1,522	1,522	1,587	1,627	1,767	2,255	1,880	2,430	
	24 96	2	PL2496RE	1,580	1,580	1,651	1,695	1,849	2,376	1,971	2,566	
	30 36	1	PL3036RE	887	887	932	947	1,169	1,367	1,241	1,463	
	30 42	1	PL3042RE	922	922	974	992	1,264	1,486	1,346	1,597	
	30 42	1	PLD3042RE	1,115	1,115	1,167	1,185	1,456	1,679	1,539	1,789	
	30 48	1	PL3048RE	1,084	1,084	1,140	1,160	1,434	1,675	1,525	1,794	
	30 48	1	PLD3048RE	1,152	1,152	1,208	1,228	1,502	1,743	1,592	1,862	
	30 60	2	PL3060RE	1,315	1,315	1,379	1,403	1,695	1,971	1,798	2,107	
	30 72	2	PL3072RE	1,383	1,383	1,460	1,487	1,771	2,084	1,885	2,234	
	30 84	2	PL3084RE	1,615	1,615	1,681	1,726	1,866	2,354	1,989	2,537	
	30 96	2	PL3096RE	1,685	1,685	1,758	1,806	1,961	2,527	2,097	2,732	
	36 42	1	PL3642RE	970	970	1,029	1,048	1,319	1,564	1,412	1,684	
	36 42	1	PLD3642RE	1,162	1,162	1,221	1,240	1,512	1,757	1,605	1,876	
36 48	1	PL3648RE	1,135	1,135	1,197	1,218	1,498	1,759	1,595	1,887		

Continued on next page

How to Order

Table Model Number					Top Finish Selection		Options	
PL Base Series	3636 Top Size	SQ Top Shape	WWSQ Top Material Edge Profile	MBK Base Finish	WMW Top Finish	WMW Edge Finish	GMBK Matte Black Grommet	E Location "E"

A PL3636SQWWSQMBK is a Platform series 36" x 36" square table with a black powder coat square base and a wood veneer 1.25" thick top with a 1.25" square wood edge profile.

The codes: WMW WMW specify a medium walnut top, with a medium walnut edge.

The code: GMBK specifies a matte black 2" diameter metal grommet.

The code: E specifies the location of the grommet.

Specialty Tops

Butcher Block	Ultrafoam	Acrylic	Corian Group A,B	Corian Group C,D	3form Chroma
BBFL Flat	ULFP PVC	AAOP Opaque	C1FL Flat	C2FL Flat	3FFL Flat
BBBN Bullnose	ULFR Raw	AATL Translucent	C1BN Bullnose	C2BN Bullnose	3FBN Bullnose
			C1PR Prism	C2PR Prism	3FPR Prism

\$					
1,059	657	1,236	1,064	1,217	1,705
1,328	717	1,697	1,316	1,544	2,693
1,820	967	2,320	1,811	2,130	3,756
2,412	1,068	2,972	2,180	2,604	4,880
2,843	1,321	3,955	2,735	3,280	6,312
1,176	676	1,448	1,180	1,363	2,287
1,470	871	1,892	1,453	1,669	2,774
1,664	907	2,017	1,564	1,817	3,110
1,856	1,100	2,210	1,756	2,010	3,302
1,719	947	2,202	1,678	1,966	3,443
1,911	1,140	2,395	1,870	2,158	3,636
2,243	1,294	-	2,198	2,551	4,430
2,494	1,362	-	2,437	2,860	5,095
2,677	1,554	-	-	-	-
2,860	1,622	-	-	-	-
1,640	920	2,112	1,616	1,883	3,281
1,885	962	2,355	1,754	2,064	3,719
2,078	1,154	2,547	1,947	2,257	3,912
2,070	1,130	2,729	2,031	2,383	4,272
2,138	1,197	2,796	2,098	2,450	4,340
2,518	1,372	3,408	2,467	2,905	5,258
2,823	1,451	4,150	2,753	3,274	6,130
3,006	1,656	-	-	-	-
3,189	1,738	-	-	-	-
2,099	1,017	-	2,134	2,311	4,316
2,292	1,210	-	2,327	2,503	4,508
2,290	1,191	3,132	2,587	2,671	4,947

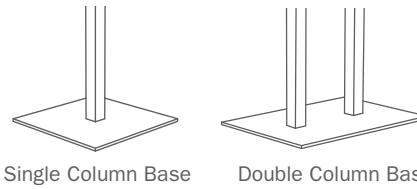

Options

Base Finishes		
Standard Powder Coat	use finish code	n/c
Polished or Satin Chrome (per base)	use finish code	\$194
Premium Plated (per base)	use finish code	🕒
Custom Powder Coat (set-up charge)	CPC	\$363

Base Options		
Alternate Height Base (per column)	AH	\$66
Nylon Octagon Glides (per base)	GNO	\$34
Custom Top Plate Size	CTPS	🕒

Top Materials and Finishes		
Standard Laminates	use manufacturers finish code	n/c
Premium Laminates	PL	🕒
Custom Wood Veneer	CWV	🕒
Special Pattern Veneer	SPV	🕒
Stain to Match (set-up charge)	STM	\$412

Top Options		
Custom Size	CS	🕒
Custom Shape	CSH	🕒
Custom Radius Corner	CRC	🕒
3" Radius Corner (per corner)	CRL3	\$34
(laminates self edge, ultrafoam, Corian®, 3form chroma)		
3" Wood Radius Corner (per corner)	CRW3	\$82
(not available in LWFL, WWFL, LWPI and WWPI)		

Grommets		
2" Round Metal Grommet - Matte Black	GMBK	\$138
2" Round Metal Grommet - Satin Chrome	GMSC	\$138
2" Round Metal Grommet - Polished Chrome	GMPC	\$138
2" Round Plastic Grommet - Matte Black	GPMBK	\$44
Grommet location	use location code	n/c

Edge Options		
1.75" Thick Edge (per table)	175E	15%
<i>(see edge details for specific profiles)</i>		

Laminate Tops

Wood Veneer Tops

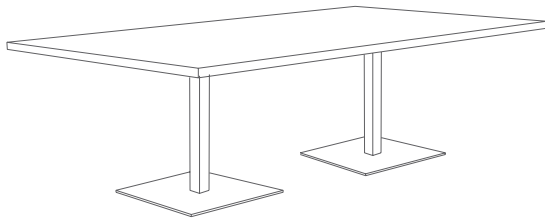

Self Edge	Vinyl Edges	PVC Edges	Metal Edges	Wood Edges Group A	Wood Edges Group B	Wood Edges Group A	Wood Edges Group B
LLSE Self Edge	LVFL Flat	LPVC PVC	LMFL Flat	LWFL Flat	LWSQ Square	WWFL Flat	WWSQ Square
	LVBP Bumper		LMRB Ribbed	LWTP Tapered Ply	LWAR Arc	WWTP Tapered Ply	WWAR Arc
				LWFP Flat Ply	LWBN Bullnose	WWFP Flat Ply	WWBN Bullnose
					LWPR Prism		WWPR Prism
					LWPI Pivot		WWPI Pivot

Complete Table List Pricing

	Top Size	Base Qty.	Model #	\$							
Rectangle 	36 48	1	PLD3648RE	1,203	1,203	1,265	1,286	1,565	1,827	1,662	1,954
	36 60	2	PL3660RE	1,700	1,700	1,773	1,797	2,073	2,369	2,184	2,517
	36 72	2	PL3672RE	1,783	1,783	1,860	1,888	2,201	2,536	2,326	2,705
	36 84	2	PL3684RE	2,028	2,028	2,097	2,143	2,305	2,771	2,445	2,968
	36 96	2	PL3696RE	2,110	2,110	2,193	2,237	2,410	2,945	2,563	3,164
	42 72	2	PL4272RE	2,117	2,117	2,182	2,215	2,516	2,911	2,587	3,004
	42 84	2	PL4284RE	2,373	2,373	2,443	2,492	2,630	3,138	2,866	3,451
	42 96	2	PL4296RE	2,467	2,467	2,544	2,597	2,751	3,364	3,008	3,494
	48 96	2	PL4896RE	2,578	2,578	2,653	2,708	2,936	3,591	3,309	3,796
	48 120	2	PL48120RE	2,790	2,790	2,888	2,955	3,179	3,817	3,613	4,101
	48 144	3	PL48144RE	3,755	3,755	3,850	3,930	4,175	4,821	4,677	5,212
	48 168	3	PL48168RE	3,983	3,983	4,083	4,175	4,406	5,103	4,967	5,538
	60 120	2	PL60120RE	3,051	3,051	3,143	3,224	3,399	4,043	3,817	4,441
60 144	3	PL60144RE	4,051	4,051	4,154	4,251	4,518	5,103	5,107	5,629	
60 168	3	PL60168RE	4,360	4,360	4,433	4,545	4,801	5,727	5,461	6,406	
Arc Rectangle 	30 60	2	PL3060AR	1,328	1,328	1,383	1,405	1,662	1,975	1,798	2,119
	30 72	2	PL3072AR	1,419	1,419	1,469	1,494	1,776	2,173	1,884	2,247
	30 84	2	PL3084AR	1,597	1,597	1,678	1,718	1,866	2,315	1,992	2,551
	30 96	2	PL3096AR	1,670	1,670	1,757	1,800	1,975	2,512	2,092	2,755
	36 60	2	PL3660AR	1,733	1,733	1,775	1,797	2,073	2,435	2,184	2,540
	36 72	2	PL3672AR	1,836	1,836	1,884	1,910	2,198	2,606	2,326	2,719
	36 84	2	PL3684AR	2,015	2,015	2,100	2,141	2,305	2,775	2,445	2,974

Continued on next page

How to Order

Table Model Number

Top Finish Selection

Options

PL Base Series **4272** Top Size **RE** Top Shape **WWSQ** Top Material Edge Profile **MBK** Base Finish

WMW Top Finish **WMW** Edge Finish

GMBK Matte Black Grommet

E Location "E"

A PL4272REWWSQMBK is a Platform series 42" x 72" rectangle table with two black powder coat square bases and a wood veneer 1.25" thick top with a 1.25" square wood edge profile.

The codes: WMW WMW specify a medium walnut top, with a medium walnut edge.

The code: GMBK specifies a matte black 2" diameter metal grommet.

The code: E specifies the location of the grommet.

Specialty Tops

Butcher Block	Ultrafoam	Acrylic	Corian Group A,B	Corian Group C,D	3form Chroma
BBFL Flat	ULFP PVC	AAOP Opaque	C1FL Flat	C2FL Flat	3FFL Flat
BBBN Bullnose	ULFR Raw	AATL Translucent	C1BN Bullnose	C2BN Bullnose	3FBN Bullnose
			C1PR Prism	C2PR Prism	3FPR Prism

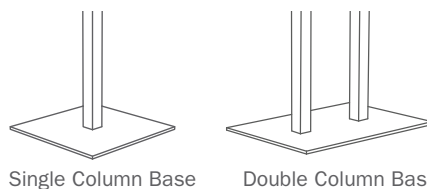

Options

Base Finishes

Standard Powder Coat	use finish code	n/c
Polished or Satin Chrome (per base)	use finish code	\$194
Premium Plated (per base)	use finish code	🕒
Custom Powder Coat (set-up charge)	CPC	\$363

Base Options

Alternate Height Base (per column)	AH	\$66
Nylon Octagon Glides (per base)	GNO	\$34
Custom Top Plate Size	CTPS	🕒

Top Materials and Finishes

Standard Laminates	use manufacturers finish code	n/c
Premium Laminates	PL	🕒
Custom Wood Veneer	CWV	🕒
Special Pattern Veneer	SPV	🕒
Stain to Match (set-up charge)	STM	\$412

Top Options

Custom Size	CS	🕒
Custom Shape	CSH	🕒
Custom Radius Corner	CRC	🕒
3" Radius Corner (per corner)	CRL3	\$34
(laminates self edge, ultrafoam, Corian®, 3form chroma)		
3" Wood Radius Corner (per corner)	CRW3	\$82
(not available in LWFL, WWFL, LWPI and WWPI)		

Grommets

2" Round Metal Grommet - Matte Black	GMBK	\$138
2" Round Metal Grommet - Satin Chrome	GMSC	\$138
2" Round Metal Grommet - Polished Chrome	GMPC	\$138
2" Round Plastic Grommet - Matte Black	GPMBK	\$44
Grommet location	use location code	n/c









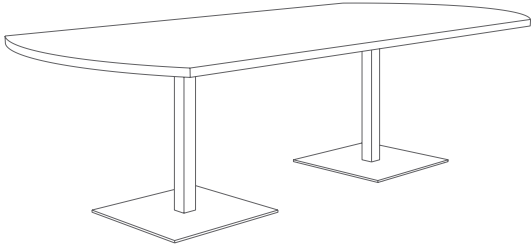













Edge Options

1.75" Thick Edge (per table)	175E	15%
------------------------------	------	-----

(see edge details for specific profiles)

\$					
2,358	1,258	3,199	2,654	2,738	5,015
3,106	1,766	4,470	3,079	3,598	6,458
3,458	1,861	5,053	3,406	4,024	7,444
3,808	2,081	6,269	-	-	-
4,153	2,178	6,605	-	-	-
-	2,204	-	-	-	-
-	2,436	-	-	-	-
-	2,547	7,602	-	-	-
-	2,668	-	-	-	-
-	-	-	-	-	-
-	-	-	-	-	-
-	-	-	-	-	-
-	-	-	-	-	-
-	-	-	-	-	-
-	-	-	-	-	-
-	-	-	-	-	-
-	-	-	-	-	-
-	-	-	-	-	-
-	-	-	-	-	-
-	-	-	-	-	-
-	-	-	-	-	-
-	-	-	-	-	-



Laminate Tops				Wood Veneer Tops			
Self Edge	Vinyl Edges	PVC Edges	Metal Edges	Wood Edges Group A	Wood Edges Group B	Wood Edges Group A	Wood Edges Group B
 LLSE Self Edge	 LVFL Flat	 LPVC PVC	 LMFL Flat	 LWFL Flat	 LWSQ Square	 WWFL Flat	 WWSQ Square
	 LVBP Bumper		 LMRB Ribbed	 LWTP Tapered Ply	 LWAR Arc	 WWTP Tapered Ply	 WWAR Arc
				 LWFP Flat Ply	 LWBN Bullnose	 WWFP Flat Ply	 WWBN Bullnose
					 LWPR Prism		 WWPR Prism
					 LWPI Pivot		 WWPI Pivot















Complete Table List Pricing

	Top Size	Base Qty.	Model #	\$							
Arc Rectangle 	36 96	2	PL3696AR	2,100	2,100	2,193	2,233	2,412	3,029	2,567	3,178
	42 72	2	PL4272AR	1,982	1,982	2,004	2,040	2,266	2,712	2,337	3,001
	42 84	2	PL4284AR	2,110	2,110	2,193	2,237	2,353	2,974	2,616	3,262
	42 96	2	PL4296AR	2,207	2,207	2,294	2,342	2,493	3,172	2,758	3,511
	48 96	2	PL4896AR	2,600	2,600	2,654	2,704	2,936	3,648	3,309	3,875
	48 120	2	PL48120AR	2,774	2,774	2,893	2,955	3,179	3,988	3,613	4,270
	48 144	3	PL48144AR	3,734	3,734	3,856	3,930	4,216	5,076	4,728	5,502
	48 168	3	PL48168AR	3,956	3,956	4,083	4,167	4,461	5,556	5,037	5,905
	60 120	2	PL60120AR	3,037	3,037	3,182	3,259	3,422	4,298	3,842	4,644
	60 144	3	PL60144AR	4,043	4,043	4,187	4,278	4,597	5,443	4,901	6,114
	60 168	3	PL60168AR	4,319	4,319	4,465	4,570	4,885	5,840	5,224	6,504

How to Order

Table Model Number					Top Finish Selection		Options	
PL Base Series	4296 Top Size	AR Top Shape	WWSQ Top Material Edge Profile	MBK Base Finish	WMW Top Finish	WMW Edge Finish	GMBK Matte Black Grommet	E Location "E" Grommet
A PL4296ARWWSQMBK is a Platform series 42" x 96" arc rectangle table with two black powder coat square bases and a wood veneer 1.25" thick top with a 1.25" square wood edge profile.					The codes: WMW WMW specify a medium walnut top, with a medium walnut edge.		The code: GMBK specifies a matte black 2" diameter metal grommet.	
							The code: E specifies the location of the grommet.	

Specialty Tops

Butcher Block	Ultrafoam	Acrylic	Corian Group A,B	Corian Group C,D	3form Chroma
 BBFL Flat	 ULFP PVC	 AAOP Opaque	 C1FL Flat	 C2FL Flat	 3FFL Flat
 BBBN Bullnose	 ULFR Raw	 AATL Translucent	 C1BN Bullnose	 C2BN Bullnose	 3FBN Bullnose
			 C1PR Prism	 C2PR Prism	 3FPR Prism

\$					
-	-	-	-	-	-
-	-	-	-	-	-
-	-	-	-	-	-
-	-	-	-	-	-
-	-	-	-	-	-
-	-	-	-	-	-
-	-	-	-	-	-
-	-	-	-	-	-
-	-	-	-	-	-

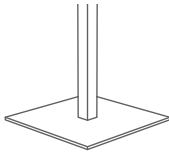

Single Column Base

Options

Base Finishes		
Standard Powder Coat	use finish code	n/c
Polished or Satin Chrome (per base)	use finish code	\$194
Premium Plated (per base)	use finish code	🕒
Custom Powder Coat (set-up charge)	CPC	\$363

Base Options		
Alternate Height Base (per column)	AH	\$66
Nylon Octagon Glides (per base)	GNO	\$34
Custom Top Plate Size	CTPS	🕒

Top Materials and Finishes		
Standard Laminates	use manufacturers finish code	n/c
Premium Laminates	PL	🕒
Custom Wood Veneer	CWV	🕒
Special Pattern Veneer	SPV	🕒
Stain to Match (set-up charge)	STM	\$412

Top Options		
Custom Size	CS	🕒
Custom Shape	CSH	🕒
Custom Radius Corner	CRC	🕒
3" Radius Corner (per corner)	CRL3	\$34
(laminated self edge, ultrafoam, Corian®, 3form chroma)		
3" Wood Radius Corner (per corner)	CRW3	\$82
(not available in LWFL, WWFL, LWPI and WWPI)		

Grommets		
2" Round Metal Grommet - Matte Black	GMBK	\$138
2" Round Metal Grommet - Satin Chrome	GMSC	\$138
2" Round Metal Grommet - Polished Chrome	GMPC	\$138
2" Round Plastic Grommet - Matte Black	GPMBK	\$44
Grommet location	use location code	n/c

Edge Options		
1.75" Thick Edge (per table)	175E	15%
<i>(see edge details for specific profiles)</i>		

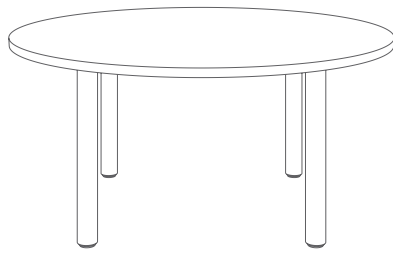

Laminate Tops

Wood Veneer Tops

Self Edge	Vinyl Edges	PVC Edges	Metal Edges	Wood Edges Group A	Wood Edges Group B	Wood Edges Group A	Wood Edges Group B
LLSE Self Edge	LVFL Flat	LPVC PVC	LMFL Flat	LWFL Flat	LWSQ Square	WWFL Flat	WWSQ Square
	LVBP Bumper		LMRB Ribbed	LWTP Tapered Ply	LWAR Arc	WWTP Tapered Ply	WWAR Arc
				LWFP Flat Ply	LWBN Bullnose	WWFP Flat Ply	WWBN Bullnose
					LWPR Prism		WWPR Prism
					LWPI Pivot		WWPI Pivot

Complete Table List Pricing

	Top Size		Base Qty.	Model #	\$							
	36		4	P036RD	949	949	1,021	1,067	1,256	1,466	1,282	1,571
	42		4	P042RD	1,090	1,090	1,170	1,170	1,412	1,670	1,506	1,796
	48		4	P048RD	1,193	1,193	1,284	1,311	1,551	1,847	1,662	1,996
	54		4	P054RD	1,304	1,304	1,409	1,438	1,767	2,378	1,905	2,592
	60		4	P060RD	1,481	1,481	1,594	1,648	1,887	2,461	2,246	2,687
	36	72	4	P03672OV	1,244	1,244	1,295	1,320	1,503	1,725	1,676	1,892
	42	54	4	P04254OV	1,261	1,261	1,288	1,352	1,493	1,820	1,644	1,880
	42	78	4	P04278OV	1,553	1,553	1,594	1,639	1,787	2,008	1,930	2,177
	42	84	4	P04284OV	1,609	1,609	1,663	1,707	1,837	2,088	1,983	2,267
	48	78	4	P04878OV	1,644	1,644	1,701	1,747	1,870	2,119	2,022	2,302
	48	96	4	P04896OV	1,820	1,820	1,876	1,926	2,018	2,290	2,380	2,697
	30	60	4	P03060RA	1,077	1,077	1,135	1,157	1,447	1,725	1,548	1,893
	30	72	4	P03072RA	1,145	1,145	1,217	1,242	1,521	1,865	1,634	1,997
	30	84	4	P03084RA	1,375	1,375	1,439	1,480	1,618	2,104	1,744	2,301
	30	96	4	P03096RA	1,445	1,445	1,517	1,561	1,712	2,318	1,842	2,505
	36	60	4	P03660RA	1,143	1,143	1,211	1,233	1,503	1,810	1,614	1,970
	36	72	4	P03672RA	1,223	1,223	1,302	1,327	1,635	1,978	1,762	2,149
	36	84	4	P03684RA	1,460	1,460	1,539	1,581	1,735	2,205	1,879	2,429
	36	96	4	P03696RA	1,540	1,540	1,633	1,674	1,842	2,431	1,997	2,608
	42	72	4	P04272RA	1,347	1,347	1,421	1,452	1,736	2,131	1,807	2,415
	42	84	4	P04284RA	1,601	1,601	1,668	1,712	1,835	2,386	1,981	2,706
	42	96	4	P04296RA	1,697	1,697	1,766	1,815	1,958	2,584	2,121	2,981

Continued on next page

How to Order

Table Model Number					Top Finish Selection		Options
PO Base Series	36 Top Size	RD Top Shape	WWSQ Top Material Edge Profile	MBK Base Finish	WMW Top Finish	WMW Edge Finish	AH Alternate Height Base

A P036RDWWSQMBK is a Post Leg series 36" round table with four black powder coat post legs and a wood veneer 1.25" thick top with a 1.25" square wood edge profile.

The codes: WMW WMW specify a medium walnut top, with a medium walnut edge.

The code: AH specifies alternate height base.

Specialty Tops

Butcher Block	Ultrafoam	Acrylic	Corian Group A,B	Corian Group C,D	3form Chroma
BBFL Flat	ULFP PVC	AAOP Opaque	C1FL Flat	C2FL Flat	3FFL Flat
BBBN Bullnose	ULFR Raw	AATL Translucent	C1BN Bullnose	C2BN Bullnose	3FBN Bullnose
			C1PR Prism	C2PR Prism	3FPR Prism

\$					
1,727	992	2,338	1,954	2,312	3,833
2,292	1,144	3,029	2,385	2,862	5,009
2,567	1,259	3,885	2,829	3,432	6,313
-	1,389	4,988	3,313	4,061	-
-	1,535	6,202	3,864	4,776	-
-	-	-	-	-	-
-	-	4,097	-	-	-
-	-	5,484	-	-	-
-	-	-	-	-	-
-	-	6,262	-	-	-
-	-	-	-	-	-
-	-	-	-	-	-
-	-	-	-	-	-
-	-	-	-	-	-
-	-	-	-	-	-
-	-	-	-	-	-
-	-	-	-	-	-
-	-	-	-	-	-
-	-	-	-	-	-
-	-	-	-	-	-
-	-	-	-	-	-



Options

Base Finishes		
Powder Coat	use finish code	n/c
Polished or Satin Chrome (per leg)	use finish code	\$62
Premium Plated (per leg)	use finish code	🔒
Custom Powder Coat (set-up charge)	CPC	\$363

Base Options		
Alternate Height Base (per leg)	AH	\$66
Floor Fastener Glide (per leg)	FFG	\$34
Locking Casters 2" Twin Wheel (qty. 4)	TWC2	\$56

Top Materials and Finishes		
Standard Laminates	use manufacturers finish code	n/c
Premium Laminates	PRL	🔒
Custom Wood Veneer	CWV	🔒
Special Pattern Veneer	SPV	🔒
Stain to Match (set-up charge)	STM	\$412

Top Options		
Custom Size	CS	🔒
Custom Shape	CSH	🔒
Custom Radius Corner	CRC	🔒
3" Radius Corner (per corner)	CRL3	\$34
(laminates self edge, ultrafoam, Corian®, 3form chroma)		
3" Wood Radius Corner (per corner)	CRW3	\$82
(not available in LWFL, WWFL, LWPI and WWPI)		

Grommets		
2" Round Metal Grommet - Matte Black	GMBK	\$138
2" Round Metal Grommet - Satin Chrome	GMSC	\$138
2" Round Metal Grommet - Polished Chrome	GMPC	\$138
2" Round Plastic Grommet - Matte Black	GPMBK	\$44
Grommet location	use location code	n/c

Edge Options		
1.75" Thick Edge (per table)	175E	15%
(see edge details for specific profiles)		

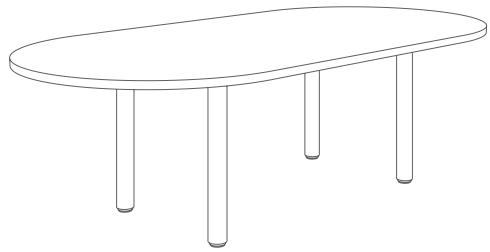

Laminate Tops

Wood Veneer Tops

Self Edge	Vinyl Edges	PVC Edges	Metal Edges	Wood Edges Group A	Wood Edges Group B	Wood Edges Group A	Wood Edges Group B
LLSE Self Edge	LVFL Flat	LPVC PVC	LMFL Flat	LWFL Flat	LWSQ Square	WWFL Flat	WWSQ Square
	LVBP Bumper		LMRB Ribbed	LWTP Tapered Ply	LWAR Arc	WWTP Tapered Ply	WWAR Arc
				LWFP Flat Ply	LWBN Bullnose	WWFP Flat Ply	WWBN Bullnose
					LWPR Prism		WWPR Prism
					LWPI Pivot		WWPI Pivot

Complete Table List Pricing

	Top Size	Base Qty.	Model #	\$							
Racetrack 	48 96	4	P04896RA	1,800	1,800	1,880	1,930	2,160	2,811	2,529	3,037
	48 120	6	P048120RA	2,342	2,342	2,443	2,505	2,733	3,480	3,163	3,820
	48 144	6	P048144RA	2,605	2,605	2,720	2,797	3,038	3,848	3,550	4,273
	48 168	6	P048168RA	2,820	2,820	2,943	3,030	3,289	4,217	3,865	4,699
	60 120	6	P060120RA	2,614	2,614	2,723	2,799	2,914	3,820	3,363	4,217
	60 144	6	P060144RA	2,929	2,929	3,030	3,122	3,377	4,217	3,709	4,686
	60 168	6	P060168RA	3,194	3,194	3,305	3,410	3,671	4,612	4,343	5,462
Square 	36 36	4	P03636SQ	949	949	1,017	1,086	1,246	1,466	1,282	1,571
	42 42	4	P04242SQ	1,078	1,078	1,154	1,203	1,412	1,670	1,506	1,796
	48 48	4	P04848SQ	1,195	1,195	1,284	1,343	1,551	1,847	1,662	1,996
Rectangle 	30 60	4	P03060RE	1,065	1,065	1,129	1,153	1,445	1,721	1,548	1,857
	30 72	4	P03072RE	1,133	1,133	1,210	1,237	1,521	1,834	1,635	1,984
	30 84	4	P03084RE	1,365	1,365	1,431	1,476	1,616	2,104	1,739	2,287
	30 96	4	P03096RE	1,435	1,435	1,508	1,556	1,711	2,277	1,847	2,482
	36 42	4	P03642RE	995	995	1,054	1,073	1,344	1,589	1,437	1,709
	36 48	4	P03648RE	1,035	1,035	1,097	1,118	1,398	1,659	1,495	1,787
	36 60	4	P03660RE	1,130	1,130	1,203	1,227	1,503	1,799	1,614	1,947
	36 72	4	P03672RE	1,213	1,213	1,290	1,318	1,631	1,966	1,756	2,135
	36 84	4	P03684RE	1,458	1,458	1,527	1,573	1,735	2,201	1,875	2,398
	36 96	4	P03696RE	1,540	1,540	1,623	1,667	1,840	2,375	1,993	2,594
	42 72	4	P04272RE	1,337	1,337	1,402	1,435	1,736	2,131	1,807	2,224
	42 84	4	P04284RE	1,593	1,593	1,663	1,712	1,850	2,358	2,086	2,671
	42 96	4	P04296RE	1,687	1,687	1,764	1,817	1,971	2,584	2,228	2,714

Continued on next page

How to Order

Table Model Number				Top Finish Selection		Options		
PO Base Series	4896 Top Size	RA Top Shape	WWSQ Top Material Edge Profile	MBK Base Finish	WMW Top Finish	WMW Edge Finish	GMBK Matte Black Grommet	E Location "E" Grommet
A P04896RAWWSQMBK is a Post Leg series 48" x 96" racetrack table with four black powder coat post legs and a wood veneer 1.25" thick top with a 1.25" square wood edge profile.					The codes: WMW WMW specify a medium walnut top, with a medium walnut edge.		The code: GMBK specifies a matte black 2" diameter metal grommet.	The code: E specifies the location of the grommet.

Specialty Tops

Butcher Block	Ultrafoam	Acrylic	Corian Group A,B	Corian Group C,D	3form Chroma
BBFL Flat	ULFP PVC	AAOP Opaque	C1FL Flat	C2FL Flat	3FFL Flat
BBBN Bullnose	ULFR Raw	AATL Translucent	C1BN Bullnose	C2BN Bullnose	3FBN Bullnose
			C1PR Prism	C2PR Prism	3FPR Prism

\$					
-	-	-	-	-	-
-	-	-	-	-	-
-	-	-	-	-	-
-	-	-	-	-	-
-	-	-	-	-	-
-	-	-	-	-	-
-	-	-	-	-	-
-	-	-	-	-	-
-	-	-	-	-	-
-	-	-	-	-	-
1,845	992	2,345	1,836	2,155	3,781
2,477	1,133	3,037	2,245	2,669	4,945
2,783	1,261	3,895	2,675	3,220	6,252
2,268	1,122	3,158	2,217	2,655	5,008
2,573	1,201	3,900	2,503	3,024	5,880
2,756	1,406	-	-	-	-
2,939	1,488	-	-	-	-
2,124	1,042	-	2,159	2,336	4,341
2,190	1,091	3,032	2,487	2,571	4,847
2,536	1,196	3,900	2,509	3,028	5,888
2,888	1,291	4,483	2,836	3,454	6,874
3,238	1,511	5,699	-	-	-
3,583	1,608	6,035	-	-	-
-	1,424	-	-	-	-
-	1,656	-	-	-	-
-	1,767	6,822	-	-	-



Options

Base Finishes		
Powder Coat	use finish code	n/c
Polished or Satin Chrome (per leg)	use finish code	\$62
Premium Plated (per leg)	use finish code	Ⓛ
Custom Powder Coat (set-up charge)	CPC	\$363

Base Options		
Alternate Height Base (per leg)	AH	\$66
Floor Fastener Glide (per leg)	FFG	\$34
Locking Casters 2" Twin Wheel (qty. 4)	TWC2	\$56

Top Materials and Finishes		
Standard Laminates	use manufacturers finish code	n/c
Premium Laminates	PRL	Ⓛ
Custom Wood Veneer	CWV	Ⓛ
Special Pattern Veneer	SPV	Ⓛ
Stain to Match (set-up charge)	STM	\$412

Top Options		
Custom Size	CS	Ⓛ
Custom Shape	CSH	Ⓛ
Custom Radius Corner	CRC	Ⓛ
3" Radius Corner (per corner)	CRL3	\$34
(laminite self edge, ultrafoam, Corian®, 3form chroma)		
3" Wood Radius Corner (per corner)	CRW3	\$82
(not available in LWFL, WWFL, LWPI and WWPI)		

Grommets		
2" Round Metal Grommet - Matte Black	GMBK	\$138
2" Round Metal Grommet - Satin Chrome	GMSC	\$138
2" Round Metal Grommet - Polished Chrome	GMPC	\$138
2" Round Plastic Grommet - Matte Black	GPMBK	\$44
Grommet location	use location code	n/c

Edge Options		
1.75" Thick Edge (per table)	175E	15%
(see edge details for specific profiles)		

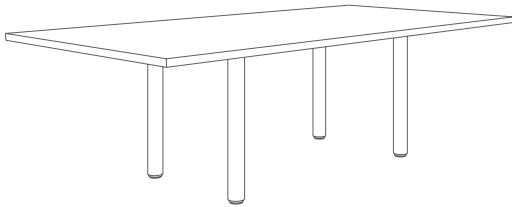

Laminate Tops

Wood Veneer Tops

Self Edge	Vinyl Edges	PVC Edges	Metal Edges	Wood Edges Group A	Wood Edges Group B	Wood Edges Group A	Wood Edges Group B
LLSE Self Edge	LVFL Flat	LPVC PVC	LMFL Flat	LWFL Flat	LWSQ Square	WWFL Flat	WWSQ Square
	LVBP Bumper		LMRB Ribbed	LWTP Tapered Ply	LWAR Arc	WWTP Tapered Ply	WWAR Arc
				LWFP Flat Ply	LWBN Bullnose	WWFP Flat Ply	WWBN Bullnose
					LWPR Prism		WWPR Prism
					LWPI Pivot		WWPI Pivot

Complete Table List Pricing















	Top Size	Base Qty.	Model #	\$							
Rectangle	48 96	4	P04896RE	1,798	1,798	1,873	1,928	2,156	2,811	2,529	3,016
	48 120	6	P048120RE	2,340	2,340	2,438	2,505	2,729	3,367	3,163	3,651
	48 144	6	P048144RE	2,585	2,585	2,680	2,760	3,005	3,651	3,507	4,042
	48 168	6	P048168RE	2,813	2,813	2,913	3,005	3,236	3,933	3,797	4,368
	60 120	6	P060120RE	2,601	2,601	2,693	2,774	2,949	3,593	3,367	3,991
	60 144	6	P060144RE	2,881	2,881	2,984	3,081	3,348	3,933	3,937	4,459
	60 168	6	P060168RE	3,190	3,190	3,263	3,375	3,631	4,557	4,291	5,236
Arc Rectangle	30 60	4	P03060AR	1,078	1,078	1,133	1,155	1,412	1,725	1,548	1,869
	30 72	4	P03072AR	1,169	1,169	1,219	1,244	1,526	1,923	1,634	1,997
	30 84	4	P03084AR	1,347	1,347	1,428	1,468	1,616	2,065	1,742	2,301
	30 96	4	P03096AR	1,420	1,420	1,507	1,550	1,725	2,262	1,842	2,505
	36 60	4	P03660AR	1,163	1,163	1,205	1,227	1,503	1,865	1,614	1,970
	36 72	4	P03672AR	1,266	1,266	1,314	1,340	1,628	2,036	1,756	2,149
	36 84	4	P03684AR	1,445	1,445	1,530	1,571	1,735	2,205	1,875	2,404
	36 96	4	P03696AR	1,530	1,530	1,623	1,663	1,842	2,459	1,997	2,608
	42 72	4	P04272AR	1,452	1,452	1,474	1,510	1,736	2,182	1,807	2,471
	42 84	4	P04284AR	1,580	1,580	1,663	1,707	1,823	2,444	2,086	2,732
	42 96	4	P04296AR	1,677	1,677	1,764	1,812	1,963	2,642	2,228	2,981
	48 96	4	P04896AR	1,820	1,820	1,874	1,924	2,156	2,868	2,529	3,095
	48 120	6	P048120AR	2,324	2,324	2,443	2,505	2,729	3,538	3,163	3,820
	48 144	6	P048144AR	2,564	2,564	2,686	2,760	3,046	3,906	3,558	4,332
	48 168	6	P048168AR	2,786	2,786	2,913	2,997	3,291	4,386	3,867	4,735

Continued on next page

How to Order

Table Model Number					Top Finish Selection		Options	
PO Base Series	4896 Top Size	RE Top Shape	WWSQ Top Material Edge Profile	MBK Base Finish	WMW Top Finish	WMW Edge Finish	GMBK Matte Black Grommet	E Location "E" Grommet
A P04896REWWSQMBK is a Post Leg series 48" x 96" rectangle table with four black powder coat post legs and a wood veneer 1.25" thick top with a 1.25" square wood edge profile.					The codes: WMW WMW specify a medium walnut top, with a medium walnut edge.		The code: GMBK specifies a matte black 2" diameter metal grommet.	
							The code: E specifies the location of the grommet.	

Specialty Tops

Butcher Block	Ultrafoam	Acrylic	Corian Group A,B	Corian Group C,D	3form Chroma
 BBFL Flat	 ULFP PVC	 AAOP Opaque	 C1FL Flat	 C2FL Flat	 3FFL Flat
 BBBN Bullnose	 ULFR Raw	 AATL Translucent	 C1BN Bullnose	 C2BN Bullnose	 3FBN Bullnose
			 C1PR Prism	 C2PR Prism	 3FPR Prism

\$					
	1,888				



Options

Base Finishes		
Powder Coat	use finish code	n/c
Polished or Satin Chrome (per leg)	use finish code	\$62
Premium Plated (per leg)	use finish code	Ⓛ
Custom Powder Coat (set-up charge)	CPC	\$363
Base Options		
Alternate Height Base (per leg)	AH	\$66
Floor Fastener Glide (per leg)	FFG	\$34
Locking Casters 2" Twin Wheel (qty. 4)	TWC2	\$56
Top Materials and Finishes		
Standard Laminates	use manufacturers finish code	n/c
Premium Laminates	PRL	Ⓛ
Custom Wood Veneer	CWV	Ⓛ
Special Pattern Veneer	SPV	Ⓛ
Stain to Match (set-up charge)	STM	\$412
Top Options		
Custom Size	CS	Ⓛ
Custom Shape	CSH	Ⓛ
Custom Radius Corner	CRC	Ⓛ
3" Radius Corner (per corner)	CRL3	\$34
(laminate self edge, ultrafoam, Corian®, 3form chroma)		
3" Wood Radius Corner (per corner)	CRW3	\$82
(not available in LWFL, WWFL, LWPI and WWPI)		
Grommets		
2" Round Metal Grommet – Matte Black	GMBK	\$138
2" Round Metal Grommet – Satin Chrome	GMSC	\$138
2" Round Metal Grommet – Polished Chrome	GMPC	\$138
2" Round Plastic Grommet – Matte Black	GPMBK	\$44
Grommet location	use location code	n/c
Edge Options		
1.75" Thick Edge (per table)	175E	15%
(see edge details for specific profiles)		

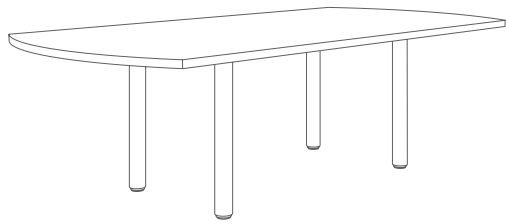

Laminate Tops

Wood Veneer Tops

Self Edge	Vinyl Edges	PVC Edges	Metal Edges	Wood Edges Group A	Wood Edges Group B	Wood Edges Group A	Wood Edges Group B
LLSE Self Edge	LVFL Flat	LPVC PVC	LMFL Flat	LWFL Flat	LWSQ Square	WWFL Flat	WWSQ Square
	LVBP Bumper		LMRB Ribbed	LWTP Tapered Ply	LWAR Arc	WWTP Tapered Ply	WWAR Arc
				LWFP Flat Ply	LWBN Bullnose	WWFP Flat Ply	WWBN Bullnose
					LWPR Prism		WWPR Prism
					LWPI Pivot		WWPI Pivot

Complete Table List Pricing

	Top Size		Base Qty.	Model #	\$								
Arc Rectangle 	60	120	6	PO60120AR	2,587	2,587	2,732	2,809	2,972	3,848	3,392	4,194	
	60	144	6	PO60144AR	2,873	2,873	3,017	3,108	3,427	4,273	3,731	4,944	
	60	168	6	PO60168AR	3,149	3,149	3,295	3,400	3,715	4,670	4,054	5,334	
Boat Shape 	36	42	72	4	PO3672BS	1,671	1,671	1,636	1,683	1,917	2,341	2,076	2,553
	36	48	84	4	PO3684BS	1,786	1,786	1,851	1,907	2,212	2,607	2,407	2,854
	36	48	96	4	PO3696BS	1,905	1,905	1,969	2,026	2,378	2,725	2,594	2,983
	36	48	120	6	PO36120BS	2,472	2,472	2,549	2,620	3,091	3,324	3,355	3,616
	36	48	144	6	PO36144BS	2,731	2,731	2,820	2,906	3,567	3,807	3,888	4,159
	36	48	168	6	PO36168BS	2,957	2,957	3,069	3,167	3,902	4,028	4,266	4,408

How to Order

Table Model Number					Top Finish Selection		Options	
PO Base Series	60120 Top Size	AR Top Shape	WWSQ Top Material Edge Profile	MBK Base Finish	WMW Top Finish	WMW Edge Finish	GMBK Matte Black Grommet	G Location "G"
A PO60120ARWWSQMBK is a Post Leg series 60" x 120" arc rectangle table with six black powder coat post legs and a wood veneer 1.25" thick top with a 1.25" square wood edge profile.					The codes: WMW WMW specify a medium walnut top, with a medium walnut edge.		The code: GMBK specifies a matte black 2" diameter metal grommet.	
							The code: G specifies the location of the grommet.	

Specialty Tops

Butcher Block	Ultrafoam	Acrylic	Corian Group A,B	Corian Group C,D	3form Chroma
BBFL Flat	ULFP PVC	AAOP Opaque	C1FL Flat	C2FL Flat	3FFL Flat
BBBN Bullnose	ULFR Raw	AATL Translucent	C1BN Bullnose	C2BN Bullnose	3FBN Bullnose
			C1PR Prism	C2PR Prism	3FPR Prism

\$					
-	-	-	-	-	-
-	-	-	-	-	-
-	-	-	-	-	-
-	-	-	-	-	-
-	-	-	-	-	-
-	-	-	-	-	-
-	-	-	-	-	-



Options

Base Finishes		
Powder Coat	use finish code	n/c
Polished or Satin Chrome (per leg)	use finish code	\$62
Premium Plated (per leg)	use finish code	Ⓛ
Custom Powder Coat (set-up charge)	CPC	\$363

Base Options		
Alternate Height Base (per leg)	AH	\$66
Floor Fastener Glide (per leg)	FFG	\$34
Locking Casters 2" Twin Wheel (qty. 4)	TWC2	\$56

Top Materials and Finishes		
Standard Laminates	use manufacturers finish code	n/c
Premium Laminates	PRL	Ⓛ
Custom Wood Veneer	CWV	Ⓛ
Special Pattern Veneer	SPV	Ⓛ
Stain to Match (set-up charge)	STM	\$412

Top Options		
Custom Size	CS	Ⓛ
Custom Shape	CSH	Ⓛ
Custom Radius Corner	CRC	Ⓛ
3" Radius Corner (per corner)	CRL3	\$34
(laminates self edge, ultrafoam, Corian®, 3form chroma)		
3" Wood Radius Corner (per corner)	CRW3	\$82
(not available in LWFL, WWFL, LWPI and WWPI)		

Grommets		
2" Round Metal Grommet - Matte Black	GMBK	\$138
2" Round Metal Grommet - Satin Chrome	GMSC	\$138
2" Round Metal Grommet - Polished Chrome	GMPC	\$138
2" Round Plastic Grommet - Matte Black	GPMBK	\$44
Grommet location	use location code	n/c

Edge Options		
1.75" Thick Edge (per table)	175E	15%
(see edge details for specific profiles)		



Laminate Tops

Wood Veneer Tops

Self Edge	Vinyl Edges	PVC Edges	Metal Edges	Wood Edges Group A	Wood Edges Group B	Wood Edges Group A	Wood Edges Group B
LLSE Self Edge	LVFL Flat	LPVC PVC	LMFL Flat	LWFL Flat	LWSQ Square	WWFL Flat	WWSQ Square
	LVBP Bumper		LMRB Ribbed	LWTP Tapered Ply	LWAR Arc	WWTP Tapered Ply	WWAR Arc
				LWFP Flat Ply	LWBN Bullnose	WWFP Flat Ply	WWBN Bullnose
					LWPR Prism		WWPR Prism
					LWPI Pivot		WWPI Pivot

Complete Table List Pricing

	Top Size	Base Qty.	Base Style	Model #	\$								
Round	24	1	X	PRX24RD	1,114	1,114	1,164	1,212	1,322	1,491	1,332	1,563	
	30	1	X	PRX30RD	1,234	1,234	1,296	1,329	1,495	1,676	1,495	1,763	
	36	1	X	PRX36RD	1,364	1,364	1,436	1,482	1,671	1,881	1,697	1,986	
	42	1	X	PRX42RD	1,465	1,465	1,545	1,545	1,787	2,045	1,881	2,171	
	48	1	X	PRX48RD	1,733	1,733	1,824	1,851	2,091	2,387	2,202	2,536	
	54	1	X	PRX54RD	1,844	1,844	1,949	1,978	2,307	2,918	2,445	3,132	
	60	1	X	PRX60RD	2,021	2,021	2,134	2,188	2,427	3,001	2,786	3,227	
Oval	36	72	2	T	PRT3672OV	1,824	1,824	1,875	1,900	2,083	2,305	2,256	2,472
	42	54	2	T	PRT4254OV	1,801	1,801	1,828	1,892	2,033	2,360	2,184	2,420
	42	78	2	T	PRT4278OV	2,093	2,093	2,134	2,179	2,327	2,548	2,470	2,717
	42	84	2	T	PRT4284OV	2,149	2,149	2,203	2,247	2,377	2,628	2,523	2,807
	48	78	2	TT	PRTT4878OV	2,284	2,284	2,341	2,387	2,510	2,759	2,662	2,942
	48	96	2	TT	PRTT4896OV	2,460	2,460	2,516	2,566	2,658	2,930	3,020	3,337
Racetrack	30	60	2	T	PRT3060RA	1,557	1,557	1,615	1,637	1,927	2,205	2,028	2,373
	30	72	2	T	PRT3072RA	1,625	1,625	1,697	1,722	2,001	2,345	2,114	2,477
	30	84	2	T	PRT3084RA	1,855	1,855	1,919	1,960	2,098	2,584	2,224	2,781
	30	96	2	T	PRT3096RA	1,925	1,925	1,997	2,041	2,192	2,798	2,322	2,985
	36	60	2	T	PRT3660RA	1,723	1,723	1,791	1,813	2,083	2,390	2,194	2,550
	36	72	2	T	PRT3672RA	1,803	1,803	1,882	1,907	2,215	2,558	2,342	2,729
	36	84	2	T	PRT3684RA	2,040	2,040	2,119	2,161	2,315	2,785	2,459	3,009
	36	96	2	TT	PRT3696RA	2,220	2,220	2,313	2,354	2,522	3,111	2,677	3,288
	42	72	2	TT	PRTT4272RA	1,987	1,987	2,061	2,092	2,376	2,771	2,447	3,055
	42	84	2	TT	PRTT4284RA	2,241	2,241	2,308	2,352	2,475	3,026	2,621	3,346
	42	96	2	TT	PRTT4296RA	2,337	2,337	2,406	2,455	2,598	3,224	2,761	3,621

Continued on next page

How to Order















Table Model Number					Top Finish Selection		Options
PRX Base Series	36 Top Size	RD Top Shape	WWSQ Top Material Edge Profile	MBK Base Finish	WMW Top Finish	WMW Edge Finish	AH Alternate Height Base

A PRX36RDWWSQMBK is a Presidio series 36" round table with a black powder coat X-base and a wood veneer 1.25" thick top with a 1.25" square wood edge profile.

The codes: WMW WMW specify a medium walnut top, with a medium walnut edge.

The code: AH specifies alternate height base.

Specialty Tops

Butcher Block	Ultrafoam	Acrylic	Corian Group A,B	Corian Group C,D	3form Chroma
 BBFL Flat	 ULFP PVC	 AAOP Opaque	 C1FL Flat	 C2FL Flat	 3FFL Flat
 BBBN Bullnose	 ULFR Raw	 AATL Translucent	 C1BN Bullnose	 C2BN Bullnose	 3FBN Bullnose
			 C1PR Prism	 C2PR Prism	 3FPR Prism

\$						
	1,479	1,133	1,724	1,639	1,816	2,228
	1,785	1,267	2,242	1,971	2,235	3,288
	2,142	1,407	2,753	2,369	2,727	4,248
	2,667	1,519	3,404	2,760	3,237	5,384
	3,107	1,799	4,425	3,369	3,972	6,853
	-	1,929	5,528	3,853	4,601	-
	-	2,075	6,742	4,404	5,316	-
	-	-	-	-	-	-
	-	-	4,637	-	-	-
	-	-	6,024	-	-	-
	-	-	-	-	-	-
	-	-	6,902	-	-	-
	-	-	-	-	-	-
	-	-	-	-	-	-
	-	-	-	-	-	-
	-	-	-	-	-	-
	-	-	-	-	-	-
	-	-	-	-	-	-
	-	-	-	-	-	-
	-	-	-	-	-	-
	-	-	-	-	-	-
	-	-	-	-	-	-
	-	-	-	-	-	-
	-	-	-	-	-	-

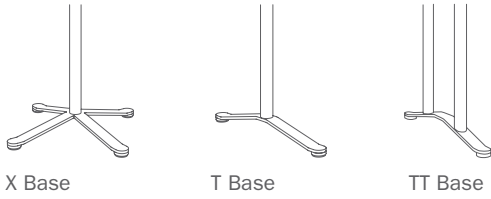

Options

Base Finishes		
Standard Powder Coat	use finish code	n/c
Polished or Satin Chrome (per base)	use finish code	\$213
Premium Plated (per base)	use finish code	①
Custom Powder Coat (set-up charge)	CPC	\$363

Base Options		
Alternate Height Base (per column)	AH	\$66

Top Materials and Finishes		
Standard Laminates	use manufacturers finish code	n/c
Premium Laminates	PRL	①
Custom Wood Veneer	CWW	①
Special Pattern Veneer	SPV	①
Stain to Match (set-up charge)	STM	\$412

Top Options		
Custom Size	CS	①
Custom Shape	CSH	①
Custom Radius Corner	CRC	①
3" Radius Corner (per corner)	CRL3	\$34
(laminate self edge, ultrafoam, Corian®, 3form chroma)		
3" Wood Radius Corner (per corner)	CRW3	\$82
(not available in LWFL, WWFL, LWPI and WWPI)		

Grommets		
2" Round Metal Grommet - Matte Black	GMBK	\$138
2" Round Metal Grommet - Satin Chrome	GMSC	\$138
2" Round Metal Grommet - Polished Chrome	GMPC	\$138
2" Round Plastic Grommet - Matte Black	GPMBK	\$44
Grommet location	use location code	n/c

Edge Options		
1.75" Thick Edge (per table)	175E	15%
(see edge details for specific profiles)		

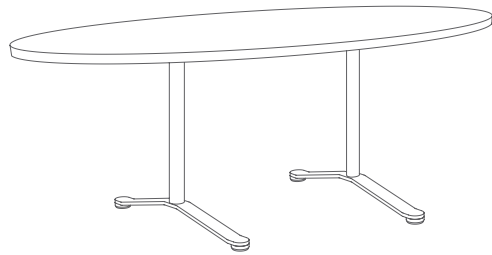

Laminate Tops

Wood Veneer Tops

Self Edge	Vinyl Edges	PVC Edges	Metal Edges	Wood Edges Group A	Wood Edges Group B	Wood Edges Group A	Wood Edges Group B
LLSE Self Edge	LVFL Flat	LPVC PVC	LMFL Flat	LWFL Flat	LWSQ Square	WWFL Flat	WWSQ Square
	LVBP Bumper		LMRB Ribbed	LWTP Tapered Ply	LWAR Arc	WWTP Tapered Ply	WWAR Arc
				LWFP Flat Ply	LWBN Bullnose	WWFP Flat Ply	WWBN Bullnose
					LWPR Prism		WWPR Prism
					LWPI Pivot		WWPI Pivot

Complete Table List Pricing















	Top Size	Base Qty.	Base Style	Model #	\$								
	48 96	2	TT	PRTT4896RA	2,610	2,610	2,690	2,740	2,970	3,621	3,339	3,847	
	48 120	2	TT	PRTT48120RA	2,822	2,822	2,923	2,985	3,213	3,960	3,643	4,300	
	48 144	3	TT	PRTT48144RA	3,820	3,820	3,935	4,012	4,253	5,063	4,765	5,488	
	48 168	3	TT	PRTT48168RA	4,035	4,035	4,158	4,245	4,504	5,432	5,080	5,914	
	60 120	2	TT	PRTT60120RA	3,094	3,094	3,203	3,279	3,394	4,300	3,843	4,697	
	60 144	3	TT	PRTT60144RA	4,144	4,144	4,245	4,337	4,592	5,432	4,924	5,901	
	60 168	3	TT	PRTT60168RA	4,409	4,409	4,520	4,625	4,886	5,827	5,558	6,677	
	24 24	1	X	PRX2424SQ	1,114	1,114	1,170	1,224	1,322	1,491	1,332	1,563	
	30 30	1	X	PRX3030SQ	1,234	1,234	1,302	1,349	1,495	1,676	1,495	1,763	
	36 36	1	X	PRX3636SQ	1,364	1,364	1,432	1,501	1,661	1,881	1,697	1,986	
	42 42	1	X	PRX4242SQ	1,618	1,618	1,694	1,743	1,952	2,210	2,046	2,336	
	48 48	1	X	PRX4848SQ	1,735	1,735	1,824	1,883	2,091	2,387	2,202	2,536	
	18 48	2	T	PRT1848RE	1,261	1,261	1,312	1,327	1,430	1,679	1,496	1,707	
	18 60	2	T	PRT1860RE	1,311	1,311	1,371	1,389	1,510	1,792	1,574	1,850	
	18 72	2	T	PRT1872RE	1,358	1,358	1,424	1,445	1,594	1,906	1,662	1,992	
	18 84	2	T	PRT1884RE	1,510	1,510	1,562	1,594	1,739	2,047	1,833	2,177	
	18 96	2	T	PRT1896RE	1,594	1,594	1,641	1,679	1,796	2,160	1,895	2,282	
	24 30	1	X	PRX2430RE	1,203	1,203	1,250	1,262	1,443	1,629	1,524	1,709	
	24 36	1	X	PRX2436RE	1,282	1,282	1,334	1,348	1,556	1,737	1,622	1,825	
	24 42	1	X	PRX2442RE	1,315	1,315	1,360	1,375	1,597	1,796	1,667	1,891	
	24 48	1	X	PRX2448RE	1,350	1,350	1,406	1,424	1,669	1,891	1,749	1,996	
	24 60	2	T	PRT2460RE	1,377	1,377	1,437	1,458	1,718	1,971	1,807	2,091	
	24 72	2	T	PRT2472RE	1,435	1,435	1,505	1,529	1,815	2,105	1,918	2,243	
	24 84	2	T	PRT2484RE	1,652	1,652	1,717	1,757	1,897	2,385	2,010	2,560	
	24 96	2	T	PRT2496RE	1,710	1,710	1,781	1,825	1,979	2,506	2,101	2,696	

Continued on next page

How to Order

Table Model Number					Top Finish Selection		Options	
PRT Base Series	2460 Top Size	RE Top Shape	WWSQ Top Material Edge Profile	MBK Base Finish	WMW Top Finish	WMW Edge Finish	GMBK Matte Black Grommet	E Location "E"
A PRT2460REWWSQMBK is a Presidio series 24" x 60" rectangle table with two black powder coat T-bases and a wood veneer 1.25" thick top with a 1.25" square wood edge profile.					The codes: WMW WMW specify a medium walnut top, with a medium walnut edge.		The code: GMBK specifies a matte black 2" diameter metal grommet.	
							The code: E specifies the location of the grommet.	

Specialty Tops

Butcher Block	Ultrafoam	Acrylic	Corian Group A,B	Corian Group C,D	3form Chroma
 BBFL Flat	 ULFP PVC	 AAOP Opaque	 C1FL Flat	 C2FL Flat	 3FFL Flat
 BBBN Bullnose	 ULFR Raw	 AATL Translucent	 C1BN Bullnose	 C2BN Bullnose	 3FBN Bullnose
			 C1PR Prism	 C2PR Prism	 3FPR Prism



X Base

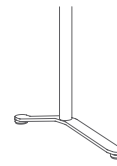

T Base

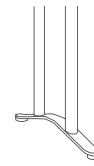

TT Base

\$					
-	-	-	-	-	-
-	-	-	-	-	-
-	-	-	-	-	-
-	-	-	-	-	-
-	-	-	-	-	-
-	-	-	-	-	-
-	-	-	-	-	-
-	-	-	-	-	-
-	-	-	-	-	-
-	-	-	-	-	-
-	-	-	-	-	-
1,549	1,147	1,726	1,554	1,707	2,195
1,878	1,267	2,247	1,866	2,094	3,243
2,260	1,407	2,760	2,251	2,570	4,196
3,017	1,673	3,577	2,785	3,209	5,485
3,323	1,801	4,435	3,215	3,760	6,792
-	-	-	-	-	-
-	-	-	-	-	-
-	-	-	-	-	-
-	-	-	-	-	-
-	-	-	-	-	-
-	-	-	-	-	-
1,792	1,290	-	-	-	-
1,860	1,350	-	-	-	-
1,973	1,403	-	-	-	-
2,132	1,581	-	-	-	-
2,245	1,636	-	-	-	-
-	-	-	-	-	-
-	-	-	-	-	-
-	-	-	-	-	-
-	-	-	-	-	-
-	-	-	-	-	-
-	-	-	-	-	-
-	-	-	-	-	-
1,726	1,226	1,998	1,730	1,913	2,837
1,910	1,311	2,332	1,893	2,109	3,214
2,104	1,347	2,457	2,004	2,257	3,550
2,159	1,387	2,642	2,118	2,406	3,883
2,373	1,424	-	2,328	2,681	4,560
2,624	1,492	-	2,567	2,990	5,225
2,807	1,684	-	-	-	-
2,990	1,752	-	-	-	-

Options

Base Finishes		
Standard Powder Coat	use finish code	n/c
Polished or Satin Chrome (per base)	use finish code	\$213
Premium Plated (per base)	use finish code	Ⓛ
Custom Powder Coat (set-up charge)	CPC	\$363
Base Options		
Alternate Height Base (per column)	AH	\$66
Top Materials and Finishes		
Standard Laminates	use manufacturers finish code	n/c
Premium Laminates	PRL	Ⓛ
Custom Wood Veneer	CWW	Ⓛ
Special Pattern Veneer	SPV	Ⓛ
Stain to Match (set-up charge)	STM	\$412
Top Options		
Custom Size	CS	Ⓛ
Custom Shape	CSH	Ⓛ
Custom Radius Corner	CRC	Ⓛ
3" Radius Corner (per corner)	CRL3	\$34
(laminate self edge, ultrafoam, Corian®, 3form chroma)		
3" Wood Radius Corner (per corner)	CRW3	\$82
(not available in LWFL, WWFL, LWPI and WWPI)		
Grommets		
2" Round Metal Grommet - Matte Black	GMBK	\$138
2" Round Metal Grommet - Satin Chrome	GMSC	\$138
2" Round Metal Grommet - Polished Chrome	GMPC	\$138
2" Round Plastic Grommet - Matte Black	GPMBK	\$44
Grommet location	use location code	n/c
Edge Options		
1.75" Thick Edge (per table)	175E	15%
(see edge details for specific profiles)		

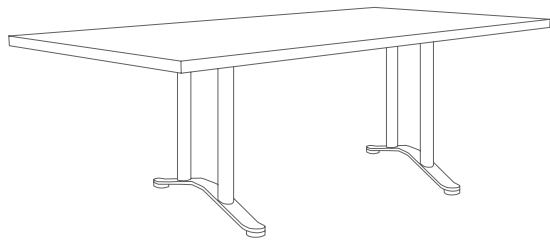

Laminate Tops

Wood Veneer Tops

Self Edge	Vinyl Edges	PVC Edges	Metal Edges	Wood Edges Group A	Wood Edges Group B	Wood Edges Group A	Wood Edges Group B
LLSE Self Edge	LVFL Flat	LPVC PVC	LMFL Flat	LWFL Flat	LWSQ Square	WWFL Flat	WWSQ Square
	LVBP Bumper		LMRB Ribbed	LWTP Tapered Ply	LWAR Arc	WWTP Tapered Ply	WWAR Arc
				LWFP Flat Ply	LWBN Bullnose	WWFP Flat Ply	WWBN Bullnose
					LWPR Prism		WWPR Prism
					LWPI Pivot		WWPI Pivot

Complete Table List Pricing

	Top Size	Base Qty.	Base Style	Model #	\$							
Rectangle	30 36	1	X	PRX3036RE	1,327	1,327	1,372	1,387	1,609	1,807	1,681	1,903
	30 42	1	X	PRX3042RE	1,362	1,362	1,414	1,432	1,704	1,926	1,786	2,037
	30 48	1	X	PRX3048RE	1,564	1,564	1,620	1,640	1,914	2,155	2,005	2,274
	30 60	2	T	PRT3060RE	1,545	1,545	1,609	1,633	1,925	2,201	2,028	2,337
	30 72	2	T	PRT3072RE	1,613	1,613	1,690	1,717	2,001	2,314	2,115	2,464
	30 84	2	T	PRT3084RE	1,845	1,845	1,911	1,956	2,096	2,584	2,219	2,767
	30 96	2	T	PRT3096RE	1,915	1,915	1,988	2,036	2,191	2,757	2,327	2,962
	36 42	2	T	PRT3642RE	1,575	1,575	1,634	1,653	1,924	2,169	2,017	2,289
	36 48	2	T	PRT3648RE	1,615	1,615	1,677	1,698	1,978	2,239	2,075	2,367
	36 60	2	T	PRT3660RE	1,710	1,710	1,783	1,807	2,083	2,379	2,194	2,527
	36 72	2	T	PRT3672RE	1,793	1,793	1,870	1,898	2,211	2,546	2,336	2,715
	36 84	2	T	PRT3684RE	2,038	2,038	2,107	2,153	2,315	2,781	2,455	2,978
	36 96	2	TT	PRT3696RE	2,220	2,220	2,303	2,347	2,520	3,055	2,673	3,274
	42 72	2	TT	PRTT4272RE	1,977	1,977	2,042	2,075	2,376	2,771	2,447	2,864
	42 84	2	TT	PRTT4284RE	2,233	2,233	2,303	2,352	2,490	2,998	2,726	3,311
	42 96	2	TT	PRTT4296RE	2,327	2,327	2,404	2,457	2,611	3,224	2,868	3,354
	48 96	2	TT	PRTT4896RE	2,608	2,608	2,683	2,738	2,966	3,621	3,339	3,826
	48 120	2	TT	PRTT48120RE	2,820	2,820	2,918	2,985	3,209	3,847	3,643	4,131
	48 144	3	TT	PRTT48144RE	3,800	3,800	3,895	3,975	4,220	4,866	4,722	5,257
	48 168	3	TT	PRTT48168RE	4,028	4,028	4,128	4,220	4,451	5,148	5,012	5,583
60 120	2	TT	PRTT60120RE	3,081	3,081	3,173	3,254	3,429	4,073	3,847	4,471	
60 144	3	TT	PRTT60144RE	4,096	4,096	4,199	4,296	4,563	5,148	5,152	5,674	
60 168	3	TT	PRTT60168RE	4,405	4,405	4,478	4,590	4,846	5,772	5,506	6,451	

Continued on next page

*T-bases can be specified on 30" x 42" and 30" x 48" rectangle tables, please refer to Base Only Pricing (p.220) and Top Only Pricing (p.230).
X-bases are recommended for dining applications.

How to Order

Table Model Number					Top Finish Selection		Options	
PRTT Base Series	4272 Top Size	RE Top Shape	WWSQ Top Material Edge Profile	MBK Base Finish	WMW Top Finish	WMW Edge Finish	GMBK Matte Black Grommet	E Location "E"
A PRTT4272REWWSQMBK is a Presidio series 42" x 72" rectangle table with two black powder coat TT-bases and a wood veneer 1.25" thick top with a 1.25" square wood edge profile.					The codes: WMW WMW specify a medium walnut top, with a medium walnut edge.		The code: GMBK specifies a matte black 2" diameter metal grommet.	
							The code: E specifies the location of the grommet.	

Specialty Tops

Butcher Block	Ultrafoam	Acrylic	Corian Group A,B	Corian Group C,D	3form Chroma
BBFL Flat	ULFP PVC	AAOP Opaque	C1FL Flat	C2FL Flat	3FFL Flat
BBBN Bullnose	ULFR Raw	AATL Translucent	C1BN Bullnose	C2BN Bullnose	3FBN Bullnose
			C1PR Prism	C2PR Prism	3FPR Prism



X Base

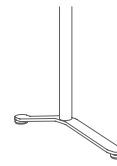

T Base

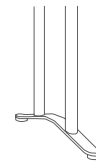

TT Base

\$						
2,080	1,360	2,552	2,056	2,323	3,721	
2,325	1,402	2,795	2,194	2,504	4,159	
2,550	1,610	3,209	2,511	2,863	4,752	
2,748	1,602	3,638	2,697	3,135	5,488	
3,053	1,681	4,380	2,983	3,504	6,360	
3,236	1,886	-	-	-	-	
3,419	1,968	-	-	-	-	
2,704	1,622	-	2,739	2,916	4,921	
2,770	1,671	3,612	3,067	3,151	5,427	
3,116	1,776	4,480	3,089	3,608	6,468	
3,468	1,871	5,063	3,416	4,034	7,454	
3,818	2,091	6,279	-	-	-	
4,263	2,288	6,715	-	-	-	
-	2,064	-	-	-	-	
-	2,296	-	-	-	-	
-	2,407	7,462	-	-	-	
-	2,698	-	-	-	-	
-	-	-	-	-	-	
-	-	-	-	-	-	
-	-	-	-	-	-	
-	-	-	-	-	-	
-	-	-	-	-	-	
-	-	-	-	-	-	
-	-	-	-	-	-	
-	-	-	-	-	-	

Options

Base Finishes		
Standard Powder Coat	use finish code	n/c
Polished or Satin Chrome (per base)	use finish code	\$213
Premium Plated (per base)	use finish code	Ⓛ
Custom Powder Coat (set-up charge)	CPC	\$363

Base Options		
Alternate Height Base (per column)	AH	\$66

Top Materials and Finishes		
Standard Laminates	use manufacturers finish code	n/c
Premium Laminates	PRL	Ⓛ
Custom Wood Veneer	CWW	Ⓛ
Special Pattern Veneer	SPV	Ⓛ
Stain to Match (set-up charge)	STM	\$412

Top Options		
Custom Size	CS	Ⓛ
Custom Shape	CSH	Ⓛ
Custom Radius Corner	CRC	Ⓛ
3" Radius Corner (per corner)	CRL3	\$34
(laminate self edge, ultrafoam, Corian®, 3form chroma)		
3" Wood Radius Corner (per corner)	CRW3	\$82
(not available in LWFL, WWFL, LWPI and WWPI)		

Grommets		
2" Round Metal Grommet - Matte Black	GMBK	\$138
2" Round Metal Grommet - Satin Chrome	GMSC	\$138
2" Round Metal Grommet - Polished Chrome	GMPC	\$138
2" Round Plastic Grommet - Matte Black	GPMBK	\$44
Grommet location	use location code	n/c

Edge Options		
1.75" Thick Edge (per table)	175E	15%
(see edge details for specific profiles)		

Laminate Tops

Wood Veneer Tops

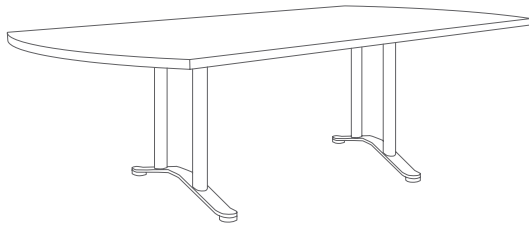

Self Edge	Vinyl Edges	PVC Edges	Metal Edges	Wood Edges Group A	Wood Edges Group B	Wood Edges Group A	Wood Edges Group B
LLSE Self Edge	LVFL Flat	LPVC PVC	LMFL Flat	LWFL Flat	LWSQ Square	WWFL Flat	WWSQ Square
	LVBP Bumper		LMRB Ribbed	LWTP Tapered Ply	LWAR Arc	WWTP Tapered Ply	WWAR Arc
				LWFP Flat Ply	LWBN Bullnose	WWFP Flat Ply	WWBN Bullnose
					LWPR Prism		WWPR Prism
					LWPI Pivot		WWPI Pivot

Complete Table List Pricing















	Top Size	Base Qty.	Base Style	Model #	\$							
Half Round 	24 48	2	T	PRT2448HR	1,323	1,323	1,373	1,389	1,513	1,766	1,576	1,813
	30 60	2	T	PRT3060HR	1,558	1,558	1,626	1,649	1,767	2,063	1,851	2,197
	36 72	2	T	PRT3672HR	1,809	1,809	1,890	1,916	2,033	2,390	2,241	2,503
Arc Rectangle 	30 60	2	T	PRT3060AR	1,558	1,558	1,613	1,635	1,892	2,205	2,028	2,349
	30 72	2	T	PRT3072AR	1,649	1,649	1,699	1,724	2,006	2,403	2,114	2,477
	30 84	2	T	PRT3084AR	1,827	1,827	1,908	1,948	2,096	2,545	2,222	2,781
	30 96	2	T	PRT3096AR	1,900	1,900	1,987	2,030	2,205	2,742	2,322	2,985
	36 60	2	T	PRT3660AR	1,743	1,743	1,785	1,807	2,083	2,445	2,194	2,550
	36 72	2	T	PRT3672AR	1,846	1,846	1,894	1,920	2,208	2,616	2,336	2,729
	36 84	2	T	PRT3684AR	2,025	2,025	2,110	2,151	2,315	2,785	2,455	2,984
	36 96	2	TT	PRT3696AR	2,210	2,210	2,303	2,343	2,522	3,139	2,677	3,288
	42 72	2	TT	PRTT4272AR	2,092	2,092	2,114	2,150	2,376	2,822	2,447	3,111
	42 84	2	TT	PRTT4284AR	2,220	2,220	2,303	2,347	2,463	3,084	2,726	3,372
	42 96	2	TT	PRTT4296AR	2,317	2,317	2,404	2,452	2,603	3,282	2,868	3,621
	48 96	2	TT	PRTT4896AR	2,630	2,630	2,684	2,734	2,966	3,678	3,339	3,905
	48 120	2	TT	PRTT48120AR	2,804	2,804	2,923	2,985	3,209	4,018	3,643	4,300
	48 144	3	TT	PRTT48144AR	3,779	3,779	3,901	3,975	4,261	5,121	4,773	5,547
	48 168	3	TT	PRTT48168AR	4,001	4,001	4,128	4,212	4,506	5,601	5,082	5,950
	60 120	2	TT	PRTT60120AR	3,067	3,067	3,212	3,289	3,452	4,328	3,872	4,674
	60 144	3	TT	PRTT60144AR	4,088	4,088	4,232	4,323	4,642	5,488	4,946	6,159
	60 168	3	TT	PRTT60168AR	4,364	4,364	4,510	4,615	4,930	5,885	5,269	6,549

Continued on next page

How to Order

Table Model Number					Top Finish Selection		Options	
PRTT Base Series	4272 Top Size	AR Top Shape	WWSQ Top Material Edge Profile	MBK Base Finish	WMW Top Finish	WMW Edge Finish	GMBK Matte Black Grommet	C Location "C"
A PRTT4272ARWWSQMBK is a Presidio series 42" x 72" arc rectangle table with two black powder coat TT-bases and a wood veneer 1.25" thick top with a 1.25" square wood edge profile.					The codes: WMW WMW specify a medium walnut top, with a medium walnut edge.		The code: GMBK specifies a matte black 2" diameter metal grommet.	
							The code: C specifies the location of the grommet.	

Specialty Tops

Butcher Block	Ultrafoam	Acrylic	Corian Group A,B	Corian Group C,D	3form Chroma
 BBFL Flat	 ULFP PVC	 AAOP Opaque	 C1FL Flat	 C2FL Flat	 3FFL Flat
 BBBN Bullnose	 ULFR Raw	 AATL Translucent	 C1BN Bullnose	 C2BN Bullnose	 3FBN Bullnose
			 C1PR Prism	 C2PR Prism	 3FPR Prism

\$					
-	-	-	-	-	-
-	-	-	-	-	-
-	-	-	-	-	-
-	-	-	-	-	-
-	-	-	-	-	-
-	-	-	-	-	-
-	-	-	-	-	-
-	-	-	-	-	-
-	-	-	-	-	-
-	-	-	-	-	-
-	-	-	-	-	-
-	-	-	-	-	-
-	-	-	-	-	-
-	-	-	-	-	-
-	-	-	-	-	-
-	-	-	-	-	-
-	-	-	-	-	-
-	-	-	-	-	-
-	-	-	-	-	-
-	-	-	-	-	-
-	-	-	-	-	-
-	-	-	-	-	-
-	-	-	-	-	-
-	-	-	-	-	-
-	-	-	-	-	-
-	-	-	-	-	-
-	-	-	-	-	-
-	-	-	-	-	-

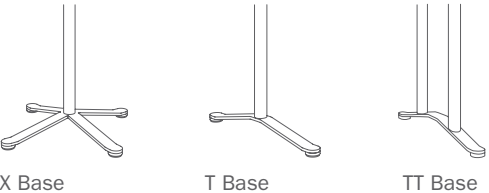

Options

Base Finishes		
Standard Powder Coat	use finish code	n/c
Polished or Satin Chrome (per base)	use finish code	\$213
Premium Plated (per base)	use finish code	\$199
Custom Powder Coat (set-up charge)	CPC	\$363

Base Options		
Alternate Height Base (per column)	AH	\$66

Top Materials and Finishes		
Standard Laminates	use manufacturers finish code	n/c
Premium Laminates	PRL	\$199
Custom Wood Veneer	CWW	\$199
Special Pattern Veneer	SPV	\$199
Stain to Match (set-up charge)	STM	\$412

Top Options		
Custom Size	CS	\$199
Custom Shape	CSH	\$199
Custom Radius Corner	CRC	\$199
3" Radius Corner (per corner)	CRL3	\$34
(laminated self edge, ultrafoam, Corian®, 3form chroma)		
3" Wood Radius Corner (per corner)	CRW3	\$82
(not available in LWFL, WWFL, LWPI and WWPI)		

Grommets		
2" Round Metal Grommet - Matte Black	GMBK	\$138
2" Round Metal Grommet - Satin Chrome	GMSC	\$138
2" Round Metal Grommet - Polished Chrome	GMPC	\$138
2" Round Plastic Grommet - Matte Black	GPMBK	\$44
Grommet location	use location code	n/c

Edge Options		
1.75" Thick Edge (per table)	175E	15%
(see edge details for specific profiles)		

Laminate Tops

Wood Veneer Tops

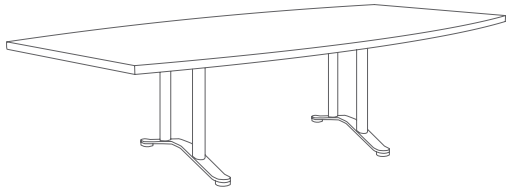

Self Edge	Vinyl Edges	PVC Edges	Metal Edges	Wood Edges Group A	Wood Edges Group B	Wood Edges Group A	Wood Edges Group B
LLSE Self Edge	LVFL Flat	LPVC PVC	LMFL Flat	LWFL Flat	LWSQ Square	WWFL Flat	WWSQ Square
	LVBP Bumper		LMRB Ribbed	LWTP Tapered Ply	LWAR Arc	WWTP Tapered Ply	WWAR Arc
				LWFP Flat Ply	LWBN Bullnose	WWFP Flat Ply	WWBN Bullnose
					LWPR Prism		WWPR Prism
					LWPI Pivot		WWPI Pivot

Complete Table List Pricing

Boat Shape	Top Size	Base Qty.	Base Style	Model #	\$								
	36 42 72	2	T	PRT3672BS	2,211	2,211	2,176	2,223	2,457	2,881	2,616	3,093	
	36 48 84	2	TT	PRTT3684BS	2,426	2,426	2,491	2,547	2,852	3,247	3,047	3,494	
	36 48 96	2	TT	PRTT3696BS	2,545	2,545	2,609	2,666	3,018	3,365	3,234	3,623	
	36 48 120	2	TT	PRTT36120BS	2,782	2,782	2,859	2,930	3,401	3,634	3,665	3,926	
	36 48 144	3	TT	PRTT36144BS	3,691	3,691	3,780	3,866	4,527	4,767	4,848	5,119	
	36 48 168	3	TT	PRTT36168BS	3,917	3,917	4,029	4,127	4,862	4,988	5,226	5,368	

How to Order

Table Model Number					Top Finish Selection		Options	
PRT Base Series	364272 Top Size	BS Top Shape	WWSQ Top Material Edge Profile	MBK Base Finish	WMW Top Finish	WMW Edge Finish	GMBK Matte Black Grommet	G Location "G" Grommet
A PRTT364272BSWWSQMBK is a Presidio series 36" x 42" x 72" boat shape table with two black powder coat T-bases and a wood veneer 1.25" thick top with a 1.25" square wood edge profile.					The codes: WMW WMW specify a medium walnut top, with a medium walnut edge.		The code: GMBK specifies a matte black 2" diameter metal grommet.	
							The code: G specifies the location of the grommet.	

Specialty Tops

Butcher Block	Ultrafoam	Acrylic	Corian Group A,B	Corian Group C,D	3form Chroma
BBFL Flat	ULFP PVC	AAOP Opaque	C1FL Flat	C2FL Flat	3FFL Flat
BBBN Bullnose	ULFR Raw	AATL Translucent	C1BN Bullnose	C2BN Bullnose	3FBN Bullnose
			C1PR Prism	C2PR Prism	3FPR Prism

\$	-	-	-	-	-
	-	-	-	-	-
	-	-	-	-	-
	-	-	-	-	-
	-	-	-	-	-
	-	-	-	-	-

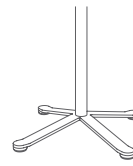

X Base

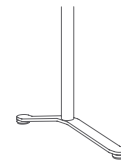

T Base

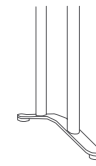

TT Base

Options

Base Finishes

Standard Powder Coat	use finish code	n/c
Polished or Satin Chrome (per base)	use finish code	\$213
Premium Plated (per base)	use finish code	Ⓛ
Custom Powder Coat (set-up charge)	CPC	\$363

Base Options

Alternate Height Base (per column)	AH	\$66
------------------------------------	----	------

Top Materials and Finishes

Standard Laminates	use manufacturers finish code	n/c
Premium Laminates	PRL	Ⓛ
Custom Wood Veneer	CWW	Ⓛ
Special Pattern Veneer	SPV	Ⓛ
Stain to Match (set-up charge)	STM	\$412

Top Options

Custom Size	CS	Ⓛ
Custom Shape	CSH	Ⓛ
Custom Radius Corner	CRC	Ⓛ
3" Radius Corner (per corner)	CRL3	\$34
(laminate self edge, ultrafoam, Corian®, 3form chroma)		
3" Wood Radius Corner (per corner)	CRW3	\$82
(not available in LWFL, WWFL, LWPI and WWPI)		

Grommets

2" Round Metal Grommet - Matte Black	GMBK	\$138
2" Round Metal Grommet - Satin Chrome	GMSC	\$138
2" Round Metal Grommet - Polished Chrome	GMPC	\$138
2" Round Plastic Grommet - Matte Black	GPMBK	\$44
Grommet location	use location code	n/c

Edge Options

1.75" Thick Edge (per table)	175E	15%
(see edge details for specific profiles)		



Laminate Tops

Wood Veneer Tops

Self Edge	Vinyl Edges	PVC Edges	Metal Edges	Wood Edges Group A	Wood Edges Group B	Wood Edges Group A	Wood Edges Group B
LLSE Self Edge	LVFL Flat	LPVC PVC	LMFL Flat	LWFL Flat	LWSQ Square	WWFL Flat	WWSQ Square
	LVBP Bumper		LMRB Ribbed	LWTP Tapered Ply	LWAR Arc	WWTP Tapered Ply	WWAR Arc
				LWFP Flat Ply	LWBN Bullnose	WWFP Flat Ply	WWBN Bullnose
					LWPR Prism		WWPR Prism
					LWPI Pivot		WWPI Pivot

Complete Table List Pricing

	Top Size	Base Qty.	Base Style	Model #	\$							
Round	30	1	X	RGX30RD	1,109	1,109	1,171	1,204	1,370	1,551	1,370	1,638
	36	1	X	RGX36RD	1,259	1,259	1,331	1,377	1,566	1,776	1,592	1,881
	42	1	X	RGX42RD	1,360	1,360	1,440	1,440	1,682	1,940	1,776	2,066
	48	1	X	RGX48RD	2,513	2,513	2,604	2,631	2,871	3,167	2,982	3,316
	54	1	X	RGX54RD	2,624	2,624	2,729	2,758	3,087	3,698	3,225	3,912
	60	1	X	RGX60RD	2,801	2,801	2,914	2,968	3,207	3,781	3,566	4,007
Oval	36 72	1	S	RGS3672OV	3,224	3,224	3,275	3,300	3,483	3,705	3,656	3,872
	42 54	1	S	RGS4254OV	3,201	3,201	3,228	3,292	3,433	3,760	3,584	3,820
	42 78	1	S	RGS4278OV	3,493	3,493	3,534	3,579	3,727	3,948	3,870	4,117
	42 84	1	S	RGS4284OV	3,649	3,649	3,703	3,747	3,877	4,128	4,023	4,307
	48 78	1	S	RGS4878OV	3,684	3,684	3,741	3,787	3,910	4,159	4,062	4,342
	48 96	1	S	RGS4896OV	3,860	3,860	3,916	3,966	4,058	4,330	4,420	4,737
Racetrack	30 72	1	S	RGS3072RA	3,125	3,125	3,197	3,222	3,501	3,845	3,614	3,977
	30 84	1	S	RGS3084RA	3,355	3,355	3,419	3,460	3,598	4,084	3,724	4,281
	30 96	1	S	RGS3096RA	3,425	3,425	3,497	3,541	3,692	4,298	3,822	4,485
	36 60	1	S	RGS3660RA	3,123	3,123	3,191	3,213	3,483	3,790	3,594	3,950
	36 72	1	S	RGS3672RA	3,203	3,203	3,282	3,307	3,615	3,958	3,742	4,129
	36 84	1	S	RGS3684RA	3,540	3,540	3,619	3,661	3,815	4,285	3,959	4,509
	36 96	1	S	RGS3696RA	3,620	3,620	3,713	3,754	3,922	4,511	4,077	4,688
	42 72	1	S	RGS4272RA	3,287	3,287	3,361	3,392	3,676	4,071	3,747	4,355
	42 84	1	S	RGS4284RA	3,641	3,641	3,708	3,752	3,875	4,426	4,021	4,746
	42 96	1	S	RGS4296RA	3,737	3,737	3,806	3,855	3,998	4,624	4,161	5,021
	48 96	1	S	RGS4896RA	3,840	3,840	3,920	3,970	4,200	4,851	4,569	5,077

Continued on next page

How to Order















Table Model Number					Top Finish Selection		Options
RGS Base Series	3672 Top Size	OV Top Shape	WWSQ Top Material Edge Profile	MBK Base Finish	WMW Top Finish	WMW Edge Finish	AH Alternate Height Base

A RGS3672OVWWSQMBK is a Regency series 36" X 72" oval table with a black powder coat scissor base and a wood veneer 1.25" thick top with a 1.25" square wood edge profile.

The codes: WMW WMW specify a medium walnut top, with a medium walnut edge.

The code: AH specifies alternate height base.

Specialty Tops

Butcher Block	Ultrafoam	Acrylic	Corian Group A,B	Corian Group C,D	3form Chroma
 BBFL Flat	 ULFP PVC	 AAOP Opaque	 C1FL Flat	 C2FL Flat	 3FFL Flat
 BBBN Bullnose	 ULFR Raw	 AATL Translucent	 C1BN Bullnose	 C2BN Bullnose	 3FBN Bullnose
			 C1PR Prism	 C2PR Prism	 3FPR Prism

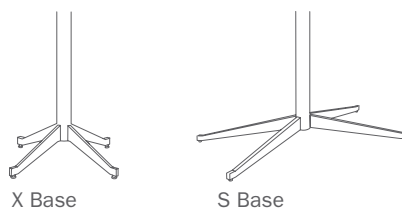

\$					
1,660	1,142	2,117	1,846	2,110	3,163
2,037	1,302	2,648	2,264	2,622	4,143
2,562	1,414	3,299	2,655	3,132	5,279
3,887	2,579	5,205	4,149	4,752	7,633
-	2,709	6,308	4,633	5,381	-
-	2,855	7,522	5,184	6,096	-
-	-	-	-	-	-
-	-	6,037	-	-	-
-	-	7,424	-	-	-
-	-	-	-	-	-
-	-	8,302	-	-	-
-	-	-	-	-	-
-	-	-	-	-	-
-	-	-	-	-	-
-	-	-	-	-	-
-	-	-	-	-	-
-	-	-	-	-	-
-	-	-	-	-	-
-	-	-	-	-	-
-	-	-	-	-	-
-	-	-	-	-	-
-	-	-	-	-	-
-	-	-	-	-	-
-	-	-	-	-	-
-	-	-	-	-	-
-	-	-	-	-	-
-	-	-	-	-	-

Options

Base Finishes		
Standard Powder Coat	use finish code	n/c
Polished or Satin Chrome (per base)	use finish code	\$363
Premium Plated (per base)	use finish code	⓪
Custom Powder Coat (set-up charge)	CPC	\$363

Base Options		
Alternate Height Base (per column)	AH	\$66
Super Level Glides (per base)	GSL	\$34

Top Materials and Finishes		
Standard Laminates	use manufacturers finish code	n/c
Premium Laminates	PRL	⓪
Custom Wood Veneer	CWV	⓪
Special Pattern Veneer	SPV	⓪
Stain to Match (set-up charge)	STM	\$412

Top Options		
Custom Size	CS	⓪
Custom Shape	CSH	⓪
Custom Radius Corner	CRC	⓪
3" Radius Corner (per corner)	CRL3	\$34
(laminate self edge, ultrafoam, Corian®, 3form chroma)		
3" Wood Radius Corner (per corner)	CRW3	\$82
(not available in LWFL, WWFL, LWPI and WWPI)		

Grommets		
2" Round Metal Grommet - Matte Black	GMBK	\$138
2" Round Metal Grommet - Satin Chrome	GMSC	\$138
2" Round Metal Grommet - Polished Chrome	GMPC	\$138
2" Round Plastic Grommet - Matte Black	GPMBK	\$44
Grommet location	use location code	n/c

Edge Options		
1.75" Thick Edge (per table)	175E	15%
(see edge details for specific profiles)		

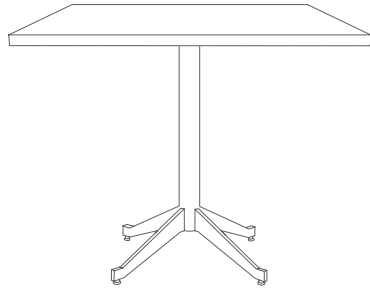

Laminate Tops

Wood Veneer Tops

Self Edge	Vinyl Edges	PVC Edges	Metal Edges	Wood Edges Group A	Wood Edges Group B	Wood Edges Group A	Wood Edges Group B
LLSE Self Edge	LVFL Flat LVBP Bumper	LPVC PVC	LMFL Flat LMRB Ribbed	LWFL Flat LWTP Tapered Ply LWFP Flat Ply	LWSQ Square LWAR Arc LWBN Bullnose LWPR Prism LWPI Pivot	WWFL Flat WWTP Tapered Ply WWFP Flat Ply	WWSQ Square WWAR Arc WWBN Bullnose WWPR Prism WWPI Pivot

Complete Table List Pricing

	Top Size	Base Qty.	Base Style	Model #	\$							
Square 	30 30	1	X	RGX3030SQ	1,109	1,109	1,177	1,224	1,370	1,551	1,370	1,638
	36 36	1	X	RGX3636SQ	1,259	1,259	1,327	1,396	1,556	1,776	1,592	1,881
	42 42	1	X	RGX4242SQ	2,398	2,398	2,474	2,523	2,732	2,990	2,826	3,116
	48 48	1	X	RGX4848SQ	2,515	2,515	2,604	2,663	2,871	3,167	2,982	3,316
Rectangle 	30 48	1	X	RGX3048RE	1,294	1,294	1,350	1,370	1,644	1,885	1,735	2,004

How to Order

Table Model Number					Top Finish Selection		Options
RGX Base Series	3030 Top Size	SQ Top Shape	WWSQ Top Material Edge Profile	MBK Base Finish	WMW Top Finish	WMW Edge Finish	AH Alternate Height Base
A RGX3030SQWWSQMBK is a Regency series 30" x 30" square table with a black powder coat X-base and a wood veneer 1.25" thick top with a 1.25" square wood edge profile.					The codes: WMW WMW specify a medium walnut top, with a medium walnut edge.		The code: AH specifies alternate height base.

Specialty Tops

Butcher Block	Ultrafoam	Acrylic	Corian Group A,B	Corian Group C,D	3form Chroma
BBFL Flat	ULFP PVC	AAOP Opaque	C1FL Flat	C2FL Flat	3FFL Flat
BBBN Bullnose	ULFR Raw	AATL Translucent	C1BN Bullnose	C2BN Bullnose	3FBN Bullnose
			C1PR Prism	C2PR Prism	3FPR Prism

\$						
	1,753	1,142	2,122	1,741	1,969	3,118
	2,155	1,302	2,655	2,146	2,465	4,091
	3,797	2,453	4,357	3,565	3,989	6,265
	4,103	2,581	5,215	3,995	4,540	7,572

2,280	1,340	2,939	2,241	2,593	4,482
-------	-------	-------	-------	-------	-------

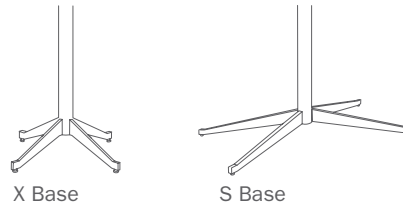

Options

Base Finishes

Standard Powder Coat	use finish code	n/c
Polished or Satin Chrome (per base)	use finish code	\$363
Premium Plated (per base)	use finish code	🕒
Custom Powder Coat (set-up charge)	CPC	\$363

Base Options

Alternate Height Base (per column)	AH	\$66
Super Level Glides (per base)	GSL	\$34

Top Materials and Finishes

Standard Laminates	use manufacturers finish code	n/c
Premium Laminates	PRL	🕒
Custom Wood Veneer	CWV	🕒
Special Pattern Veneer	SPV	🕒
Stain to Match (set-up charge)	STM	\$412

Top Options

Custom Size	CS	🕒
Custom Shape	CSH	🕒
Custom Radius Corner	CRC	🕒
3" Radius Corner (per corner) (laminates self edge, ultrafoam, Corian®, 3form chroma)	CRL3	\$34
3" Wood Radius Corner (per corner) (not available in LWFL, WWFL, LWPI and WWPI)	CRW3	\$82

Grommets

2" Round Metal Grommet - Matte Black	GMBK	\$138
2" Round Metal Grommet - Satin Chrome	GMSC	\$138
2" Round Metal Grommet - Polished Chrome	GMPC	\$138
2" Round Plastic Grommet - Matte Black	GPMBK	\$44
Grommet location	use location code	n/c

Edge Options

1.75" Thick Edge (per table) (see edge details for specific profiles)	175E	15%
--	------	-----

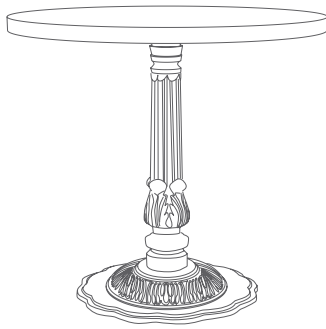

Laminate Tops

Wood Veneer Tops

Self Edge	Vinyl Edges	PVC Edges	Metal Edges	Wood Edges Group A	Wood Edges Group B	Wood Edges Group A	Wood Edges Group B
LLSE Self Edge	LVFL Flat	LPVC PVC	LMFL Flat	LWFL Flat	LWSQ Square	WWFL Flat	WWSQ Square
	LVBP Bumper		LMRB Ribbed	LWTP Tapered Ply	LWAR Arc	WWTP Tapered Ply	WWAR Arc
				LWFP Flat Ply	LWBN Bullnose	WWFP Flat Ply	WWBN Bullnose
					LWPR Prism		WWPR Prism
					LWPI Pivot		WWPI Pivot

Complete Table List Pricing

	Top Size	Base Qty.	Model #	\$							
Round 	24	1	SC24RD	790	790	839	888	998	1,167	1,008	1,239
	30	1	SC30RD	850	850	911	945	1,111	1,292	1,111	1,379
	36	1	SC36RD	930	930	1,002	1,048	1,237	1,447	1,263	1,552
	42	1	SC42RD	1,031	1,031	1,111	1,111	1,353	1,611	1,447	1,737
	48	1	SC48RD	1,134	1,134	1,224	1,251	1,492	1,788	1,603	1,937
Square 	24 24	1	SC2424SQ	790	790	846	900	998	1,167	1,008	1,239
	30 30	1	SC3030SQ	850	850	918	965	1,111	1,292	1,111	1,379
	36 36	1	SC3636SQ	930	930	998	1,067	1,227	1,447	1,263	1,552
Rectangle 	24 30	1	SC2430RE	819	819	866	878	1,059	1,245	1,139	1,325
	24 36	1	SC2436RE	847	847	900	913	1,121	1,302	1,187	1,391
	24 42	1	SC2442RE	880	880	925	940	1,162	1,362	1,232	1,457
	24 48	1	SC2448RE	915	915	972	990	1,234	1,457	1,315	1,562
	30 36	1	SC3036RE	893	893	937	953	1,174	1,373	1,247	1,469
	30 42	1	SC3042RE	928	928	980	998	1,269	1,492	1,352	1,602
	30 48	1	SC3048RE	965	965	1,021	1,041	1,315	1,556	1,405	1,675
	36 42	1	SC3642RE	975	975	1,034	1,053	1,325	1,570	1,418	1,689
	36 48	1	SC3648RE	1,016	1,016	1,078	1,099	1,378	1,640	1,476	1,768

How to Order















Table Model Number				Top Finish Selection		Options	
SC Base Series	36 Top Size	RD Top Shape	WWSQ Top Material Edge Profile	MBK Base Finish	WMW Top Finish	WMW Edge Finish	GSL Super Level Glides

A SC36RDWWSQMBK is a Scala series 36" round table with a decorative black powder coat base and a wood veneer 1.25" thick top with a 1.25" square wood edge profile.

The codes: WMW WMW specify a medium walnut top, with a medium walnut edge.

The code: GSL specifies super level glides.

Specialty Tops

Butcher Block	Ultrafoam	Acrylic	Corian Group A,B	Corian Group C,D	3form Chroma
 BBFL Flat	 ULFP PVC	 AAOP Opaque	 C1FL Flat	 C2FL Flat	 3FFL Flat
 BBBN Bullnose	 ULFR Raw	 AATL Translucent	 C1BN Bullnose	 C2BN Bullnose	 3FBN Bullnose
			 C1PR Prism	 C2PR Prism	 3FPR Prism

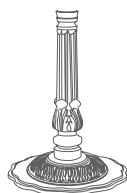

Options

Base Finishes		
Standard Powder Coat	use finish code	n/c
Custom Powder Coat (set-up charge)	CPC	\$363

Base Options		
Alternate Height Base (per column)	AH	\$166
Super Level Glides (per base)	GSL	\$34
Custom Top Plate Size	CTPS	🕒

Top Materials and Finishes		
Standard Laminates	use manufacturers finish code	n/c
Premium Laminates	PRL	🕒
Custom Wood Veneer	CWV	🕒
Special Pattern Veneer	SPV	🕒
Stain to Match (set-up charge)	STM	\$412

Top Options		
Custom Size	CS	🕒
Custom Shape	CSH	🕒
Custom Radius Corner	CRC	🕒
3" Radius Corner (per corner)	CRL3	\$34
(laminates self edge, ultrafoam, Corian®, 3form chroma)		
3" Wood Radius Corner (per corner)	CRW3	\$82
(not available in LWFL, WWFL, LWPI and WWPI)		

Edge Options		
1.75" Thick Edge (per table)	175E	15%
<i>(see edge details for specific profiles)</i>		

\$					
1,154	808	1,399	1,315	1,491	1,903
1,401	883	1,858	1,586	1,850	2,904
1,708	973	2,319	1,934	2,292	3,813
2,233	1,084	2,969	2,326	2,802	4,949
2,508	1,199	3,825	2,770	3,373	6,254
1,224	822	1,401	1,230	1,383	1,870
1,494	883	1,862	1,481	1,710	2,858
1,825	973	2,325	1,817	2,135	3,762
1,341	842	1,613	1,345	1,529	2,453
1,475	876	1,897	1,459	1,675	2,780
1,669	913	2,023	1,570	1,823	3,115
1,724	953	2,208	1,683	1,971	3,449
1,646	926	2,117	1,621	1,889	3,286
1,891	967	2,360	1,760	2,070	3,725
1,951	1,010	2,609	1,911	2,263	4,153
2,105	1,023	-	2,140	2,317	4,321
2,171	1,071	3,013	2,467	2,552	4,828

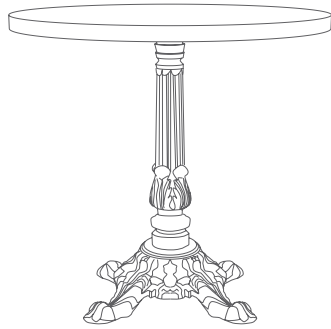

Laminate Tops

Wood Veneer Tops

Self Edge	Vinyl Edges	PVC Edges	Metal Edges	Wood Edges Group A	Wood Edges Group B	Wood Edges Group A	Wood Edges Group B
LLSE Self Edge	LVFL Flat LVBP Bumper	LPVC PVC	LMFL Flat LMRB Ribbed	LWFL Flat LWTP Tapered Ply LWFP Flat Ply	LWSQ Square LWAR Arc LWBN Bullnose LWPR Prism LWPI Pivot	WWFL Flat WWTP Tapered Ply WWFP Flat Ply	WWSQ Square WWAR Arc WWBN Bullnose WWPR Prism WWPI Pivot

Complete Table List Pricing

	Top Size	Base Qty.	Model #	\$							
Round 	30	1	SI30RD	715	715	777	810	976	1,157	976	1,244
	36	1	SI36RD	796	796	868	913	1,102	1,312	1,128	1,417
	42	1	SI42RD	896	896	977	977	1,218	1,476	1,312	1,602
	48	1	SI48RD	999	999	1,090	1,117	1,357	1,653	1,468	1,802
	54	1	SI54RD	1,110	1,110	1,216	1,245	1,573	2,185	1,711	2,398
Square 	30 30	1	SI3030SQ	715	715	783	830	976	1,157	976	1,244
	36 36	1	SI3636SQ	796	796	863	932	1,092	1,312	1,128	1,417
	42 42	1	SI4242SQ	884	884	960	1,009	1,218	1,476	1,312	1,602
	48 48	1	SI4848SQ	1,001	1,001	1,090	1,149	1,357	1,653	1,468	1,802
Rectangle 	30 36	1	SI3036RE	758	758	803	818	1,040	1,238	1,112	1,334
	30 42	1	SI3042RE	793	793	846	863	1,135	1,357	1,217	1,468
	30 48	1	SI3048RE	830	830	887	907	1,180	1,422	1,271	1,540
	36 42	1	SI3642RE	841	841	900	919	1,191	1,436	1,283	1,555
	36 48	1	SI3648RE	882	882	944	964	1,244	1,505	1,341	1,633

How to Order

Table Model Number

Top Finish Selection

Options

SI Base Series **36** Top Size **RD** Top Shape **WWSQ** Top Material Edge Profile **MBK** Base Finish

WMW Top Finish **WMW** Edge Finish















GSL Super Level Glides

A SI36RDWWSQMBK is a Siena series 36" round table with a decorative black powder coat base and a wood veneer 1.25" thick top with a 1.25" square wood edge profile.

The codes: WMW WMW specify a medium walnut top, with a medium walnut edge.

The code: GSL specifies super level glides.

Specialty Tops

Butcher Block	Ultrafoam	Acrylic	Corian Group A,B	Corian Group C,D	3form Chroma
 BBFL Flat	 ULFP PVC	 AAOP Opaque	 C1FL Flat	 C2FL Flat	 3FFL Flat
 BBBN Bullnose	 ULFR Raw	 AATL Translucent	 C1BN Bullnose	 C2BN Bullnose	 3FBN Bullnose
			 C1PR Prism	 C2PR Prism	 3FPR Prism

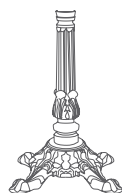

Options

Base Finishes		
Standard Powder Coat	use finish code	n/c
Custom Powder Coat (set-up charge)	CPC	\$363

Base Options		
Alternate Height Base (per column)	AH	\$166
Super Level Glides (per base)	GSL	\$34
Custom Top Plate Size	CTPS	🕒

Top Materials and Finishes		
Standard Laminates	use manufacturers finish code	n/c
Premium Laminates	PRL	🕒
Custom Wood Veneer	CWV	🕒
Special Pattern Veneer	SPV	🕒
Stain to Match (set-up charge)	STM	\$412

Top Options		
Custom Size	CS	🕒
Custom Shape	CSH	🕒
Custom Radius Corner	CRC	🕒
3" Radius Corner (per corner)	CRL3	\$34
(laminate self edge, ultrafoam, Corian®, 3form chroma)		
3" Wood Radius Corner (per corner)	CRW3	\$82
(not available in LWFL, WWFL, LWPI and WWPI)		

Edge Options		
1.75" Thick Edge (per table)	175E	15%
(see edge details for specific profiles)		

\$					
1,266	748	1,724	1,452	1,716	2,769
1,573	839	2,185	1,800	2,158	3,679
2,098	950	2,835	2,191	2,668	4,815
2,373	1,065	3,691	2,635	3,238	6,120
-	1,195	4,794	3,119	3,868	-
1,359	748	1,728	1,347	1,575	2,724
1,691	839	2,191	1,682	2,001	3,627
2,283	939	2,843	2,051	2,475	4,751
2,590	1,067	3,701	2,481	3,027	6,058
1,512	791	1,983	1,487	1,754	3,152
1,757	833	2,226	1,625	1,935	3,590
1,816	876	2,475	1,777	2,129	4,018
1,970	888	-	2,006	2,182	4,187
2,036	937	2,878	2,333	2,417	4,693



Laminate Tops

Wood Veneer Tops

Self Edge	Vinyl Edges	PVC Edges	Metal Edges	Wood Edges Group A	Wood Edges Group B	Wood Edges Group A	Wood Edges Group B
LLSE Self Edge	LVFL Flat	LPVC PVC	LMFL Flat	LWFL Flat	LWSQ Square	WWFL Flat	WWSQ Square
	LVBP Bumper		LMRB Ribbed	LWTP Tapered Ply	LWAR Arc	WWTP Tapered Ply	WWAR Arc
				LWFP Flat Ply	LWBN Bullnose	WWFP Flat Ply	WWBN Bullnose
					LWPR Prism		WWPR Prism
					LWPI Pivot		WWPI Pivot

Complete Table List Pricing

	Top Size		Base Qty.	Base Style	Model #	\$							
Round	24		1	X	SLX24RD	519	519	569	617	727	896	737	968
	30		1	X	SLX30RD	634	634	696	729	895	1,076	895	1,163
	36		1	X	SLX36RD	769	769	841	887	1,076	1,286	1,102	1,391
	42		1	X	SLX42RD	870	870	950	950	1,192	1,450	1,286	1,576
	48		1	X	SLX48RD	1,058	1,058	1,149	1,176	1,416	1,712	1,527	1,861
	54		1	X	SLX54RD	1,169	1,169	1,274	1,303	1,632	2,243	1,770	2,457
	60		1	X	SLX60RD	1,346	1,346	1,459	1,513	1,752	2,326	2,111	2,552
Oval	36	72	2	T	SLT36720V	1,174	1,174	1,225	1,250	1,433	1,655	1,606	1,822
	42	54	2	T	SLT42540V	1,151	1,151	1,178	1,242	1,383	1,710	1,534	1,770
	42	78	2	T	SLT42780V	1,443	1,443	1,484	1,529	1,677	1,898	1,820	2,067
	42	84	2	T	SLT42840V	1,499	1,499	1,553	1,597	1,727	1,978	1,873	2,157
	48	78	2	TT	SLTT48780V	1,654	1,654	1,711	1,757	1,880	2,129	2,032	2,312
	48	96	2	TT	SLTT48960V	1,830	1,830	1,886	1,936	2,028	2,300	2,390	2,707
Racetrack	30	60	2	T	SLT3060RA	937	937	995	1,017	1,307	1,585	1,408	1,753
	30	72	2	T	SLT3072RA	1,005	1,005	1,077	1,102	1,381	1,725	1,494	1,857
	30	84	2	T	SLT3084RA	1,235	1,235	1,299	1,340	1,478	1,964	1,604	2,161
	30	96	2	T	SLT3096RA	1,305	1,305	1,377	1,421	1,572	2,178	1,702	2,365
	36	60	2	T	SLT3660RA	1,073	1,073	1,141	1,163	1,433	1,740	1,544	1,900
	36	72	2	T	SLT3672RA	1,153	1,153	1,232	1,257	1,565	1,908	1,692	2,079
	36	84	2	T	SLT3684RA	1,390	1,390	1,469	1,511	1,665	2,135	1,809	2,359
	36	96	2	TT	SLTT3696RA	1,590	1,590	1,683	1,724	1,892	2,481	2,047	2,658
	42	72	2	TT	SLTT4272RA	1,357	1,357	1,431	1,462	1,746	2,141	1,817	2,425
	42	84	2	TT	SLTT4284RA	1,611	1,611	1,678	1,722	1,845	2,396	1,991	2,716
	42	96	2	TT	SLTT4296RA	1,707	1,707	1,776	1,825	1,968	2,594	2,131	2,991

Continued on next page

How to Order

Table Model Number					Top Finish Selection		Options
SLX Base Series	36 Top Size	RD Top Shape	WWSQ Top Material Edge Profile	MBK Base Finish	WMW Top Finish	WMW Edge Finish	AH Alternate Height Base
A SLX36RDWWSQMBK is a Slimline series 36" round table with a black powder coat X-base and a wood veneer 1.25" thick top with a 1.25" square wood edge profile.					The codes: WMW WMW specify a medium walnut top, with a medium walnut edge.		The code: AH specifies alternate height base.

Specialty Tops

Butcher Block	Ultrafoam	Acrylic	Corian Group A,B	Corian Group C,D	3form Chroma
BBFL Flat	ULFP PVC	AAOP Opaque	C1FL Flat	C2FL Flat	3FFL Flat
BBBN Bullnose	ULFR Raw	AATL Translucent	C1BN Bullnose	C2BN Bullnose	3FBN Bullnose
			C1PR Prism	C2PR Prism	3FPR Prism

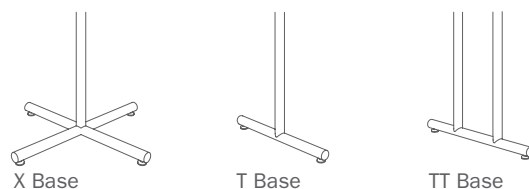

\$					
884	538	1,129	1,044	1,221	1,633
1,185	667	1,642	1,371	1,635	2,688
1,547	812	2,158	1,774	2,132	3,653
2,072	924	2,809	2,165	2,642	4,789
2,432	1,124	3,750	2,694	3,297	6,178
-	1,254	4,853	3,178	3,926	-
-	1,400	6,067	3,729	4,641	-
-	-	-	-	-	-
-	-	3,987	-	-	-
-	-	5,374	-	-	-
-	-	-	-	-	-
-	-	6,272	-	-	-
-	-	-	-	-	-
-	-	-	-	-	-
-	-	-	-	-	-
-	-	-	-	-	-
-	-	-	-	-	-
-	-	-	-	-	-
-	-	-	-	-	-
-	-	-	-	-	-
-	-	-	-	-	-
-	-	-	-	-	-
-	-	-	-	-	-
-	-	-	-	-	-

Options

Base Finishes		
Standard Powder Coat	use finish code	n/c
Polished or Satin Chrome (per base)	use finish code	\$114
Premium Plated (per base)	use finish code	🔒
Custom Powder Coat (set-up charge)	CPC	\$363

Base Options		
Alternate Height Base (per column)	AH	\$66
Super Level Glides (per base)	GSL	\$34
Locking Casters 2" Twin Wheel (qty. 4)	TWC2	\$56
Tilt-top - (standard cable release)	TMX/TMT	\$270 X-base/ \$418 T-base
Folding	FM	\$270 T-base

Top Materials and Finishes		
Standard Laminates	use manufacturers finish code	n/c
Premium Laminates	PRL	🔒
Custom Wood Veneer	CWW	🔒
Special Pattern Veneer	SPV	🔒
Stain to Match (set-up charge)	STM	\$412

Top Options		
Custom Size	CS	🔒
Custom Shape	CSH	🔒
Custom Radius Corner	CRC	🔒
3" Radius Corner (per corner)	CRL3	\$34
(laminate self edge, ultrafoam, Corian®, 3form chroma)		
3" Wood Radius Corner (per corner)	CRW3	\$82
(not available in LWFL, WWFL, LWPI and WWPI)		
Ganging Clips (1 set includes 2 male and 2 female clips)	GC	\$148

Grommets		
2" Round Metal Grommet - Matte Black	GMBK	\$138
2" Round Metal Grommet - Satin Chrome	GMSC	\$138
2" Round Metal Grommet - Polished Chrome	GMPC	\$138
2" Round Plastic Grommet - Matte Black	GPMBK	\$44
Grommet location	use location code	n/c

Edge Options		
1.75" Thick Edge (per table)	175E	15%
(see edge details for specific profiles)		

Modesty Panels		
Fixed Modesty Panel Laminate (48,60,72)	MODLFX	\$248
Fixed Modesty Panel Veneer (48,60,72)	MODVFX	\$386
Folding Modesty Panel Laminate (48,60,72)	MODLFL	\$330
Folding Modesty Veneer (48,60,72)	MODVFL	\$468

Wire Management		
J-Trough (horizontal mount) - Matte Black	WMJ	\$116
Legway Wire Manager (vertical mount) - Matte Black	WML	\$56

Data and Power		
Recessed Power and Data Module Two	DPBS2	\$396
Recessed Power and Data Module Four	DPBS4	\$688
Retractable Power and Data Module Two	DPAS2	\$606
Retractable Power and Data Module Three	DPAS3	\$688
Under Top Mounted Power and Data Module Two	DPUS2	\$358

Other		
Table Truck for Folding Tables	TTRK	\$1512

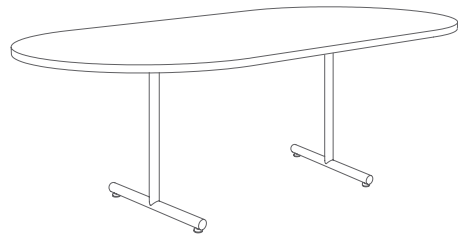

Laminate Tops

Wood Veneer Tops

Self Edge	Vinyl Edges	PVC Edges	Metal Edges	Wood Edges Group A	Wood Edges Group B	Wood Edges Group A	Wood Edges Group B
LLSE Self Edge	LVFL Flat	LPVC PVC	LMFL Flat	LWFL Flat	LWSQ Square	WWFL Flat	WWSQ Square
	LVBP Bumper		LMRB Ribbed	LWTP Tapered Ply	LWAR Arc	WWTP Tapered Ply	WWAR Arc
				LWFP Flat Ply	LWBN Bullnose	WWFP Flat Ply	WWBN Bullnose
					LWPR Prism		WWPR Prism
					LWPI Pivot		WWPI Pivot

Complete Table List Pricing

	Top Size	Base Qty.	Base Style	Model #	\$							
	48 96	2	TT	SLTT4896RA	1,880	1,880	1,960	2,010	2,240	2,891	2,609	3,117
	48 120	2	TT	SLTT48120RA	2,092	2,092	2,193	2,255	2,483	3,230	2,913	3,570
	48 144	3	TT	SLTT48144RA	2,725	2,725	2,840	2,917	3,158	3,968	3,670	4,393
	48 168	3	TT	SLTT48168RA	2,940	2,940	3,063	3,150	3,409	4,337	3,985	4,819
	60 120	2	TT	SLTT60120RA	2,364	2,364	2,473	2,549	2,664	3,570	3,113	3,967
	60 144	3	TT	SLTT60144RA	3,049	3,049	3,150	3,242	3,497	4,337	3,829	4,806
	60 168	3	TT	SLTT60168RA	3,314	3,314	3,425	3,530	3,791	4,732	4,463	5,582
	24 24	1	X	SLX2424SQ	519	519	575	629	727	896	737	968
	30 30	1	X	SLX3030SQ	634	634	702	749	895	1,076	895	1,163
	36 36	1	X	SLX3636SQ	769	769	837	906	1,066	1,286	1,102	1,391
	42 42	1	X	SLX4242SQ	943	943	1,019	1,068	1,277	1,535	1,371	1,661
	48 48	1	X	SLX4848SQ	1,060	1,060	1,149	1,208	1,416	1,712	1,527	1,861
	18 48	2	T	SLT1848RE	711	711	762	777	880	1,129	946	1,157
	18 60	2	T	SLT1860RE	761	761	821	839	960	1,242	1,024	1,300
	18 72	2	T	SLT1872RE	808	808	874	895	1,044	1,356	1,112	1,442
	18 84	2	T	SLT1884RE	960	960	1,012	1,044	1,189	1,497	1,283	1,627
	18 96	2	T	SLT1896RE	1,044	1,044	1,091	1,129	1,246	1,610	1,345	1,732
	24 30	1	X	SLX2430RE	603	603	650	662	843	1,029	924	1,109
	24 36	1	X	SLX2436RE	687	687	739	753	961	1,142	1,027	1,230
	24 42	1	X	SLX2442RE	720	720	765	780	1,002	1,201	1,072	1,296
	24 48	1	X	SLX2448RE	755	755	811	829	1,074	1,296	1,154	1,401
	24 60	2	T	SLT2460RE	827	827	887	908	1,168	1,421	1,257	1,541
	24 72	2	T	SLT2472RE	885	885	955	979	1,265	1,555	1,368	1,693
	24 84	2	T	SLT2484RE	1,102	1,102	1,167	1,207	1,347	1,835	1,460	2,010
	24 96	2	T	SLT2496RE	1,160	1,160	1,231	1,275	1,429	1,956	1,551	2,146

Continued on next page

How to Order

Table Model Number					Top Finish Selection		Options
SLTT Base Series	4896 Top Size	RA Top Shape	WWSQ Top Material Edge Profile	MBK Base Finish	WMW Top Finish	WMW Edge Finish	TWC2 Casters
A SLTT4896RAWWSQMBK is a Slimline series 48"x 96" racetrack table with two black powder coat TT-bases and a wood veneer 1.25" thick top with a 1.25" square wood edge profile.					The codes: WMW WMW specify a medium walnut top, with a medium walnut edge.		The code: TWC2 specifies 2" twin wheel locking casters.

Specialty Tops

Butcher Block	Ultrafoam	Acrylic	Corian Group A,B	Corian Group C,D	3form Chroma
BBFL Flat	ULFP PVC	AAOP Opaque	C1FL Flat	C2FL Flat	3FFL Flat
BBBN Bullnose	ULFR Raw	AATL Translucent	C1BN Bullnose	C2BN Bullnose	3FBN Bullnose
			C1PR Prism	C2PR Prism	3FPR Prism

\$					
-	-	-	-	-	-
-	-	-	-	-	-
-	-	-	-	-	-
-	-	-	-	-	-
-	-	-	-	-	-
-	-	-	-	-	-
954	552	1,131	959	1,112	1,600
1,278	667	1,647	1,266	1,494	2,643
1,665	812	2,165	1,656	1,975	3,601
2,342	998	2,902	2,110	2,534	4,810
2,648	1,126	3,760	2,540	3,085	6,117
1,242	740	-	-	-	-
1,310	800	-	-	-	-
1,423	853	-	-	-	-
1,582	1,031	-	-	-	-
1,695	1,086	-	-	-	-
1,126	626	1,398	1,130	1,313	2,237
1,315	716	1,737	1,298	1,514	2,619
1,509	752	1,862	1,409	1,662	2,955
1,564	792	2,047	1,523	1,811	3,288
1,823	874	-	1,778	2,131	4,010
2,074	942	-	2,017	2,440	4,675
2,257	1,134	-	-	-	-
2,440	1,202	-	-	-	-

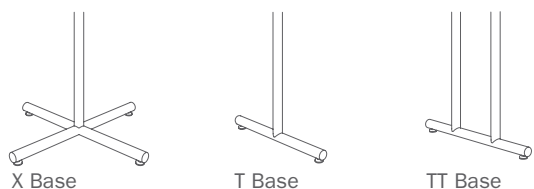

Options

Base Finishes	
Standard Powder Coat	use finish code n/c
Polished or Satin Chrome (per base)	use finish code \$114
Premium Plated (per base)	use finish code Ⓛ
Custom Powder Coat (set-up charge)	CPC \$363

Base Options	
Alternate Height Base (per column)	AH \$66
Super Level Glides (per base)	GSL \$34
Locking Casters 2" Twin Wheel (qty. 4)	TWC2 \$56
Tilt-top - (standard cable release)	TMX/TMT \$270 X-base/ \$418 T-base
Folding	FM \$270 T-base

Top Materials and Finishes	
Standard Laminates	use manufacturers finish code n/c
Premium Laminates	PRL Ⓛ
Custom Wood Veneer	CWW Ⓛ
Special Pattern Veneer	SPV Ⓛ
Stain to Match (set-up charge)	STM \$412

Top Options	
Custom Size	CS Ⓛ
Custom Shape	CSH Ⓛ
Custom Radius Corner	CRC Ⓛ
3" Radius Corner (per corner)	CRL3 \$34
(laminate self edge, ultrafoam, Corian®, 3form chroma)	
3" Wood Radius Corner (per corner)	CRW3 \$82
(not available in LWFL, WWFL, LWPI and WWPI)	
Ganging Clips (1 set includes 2 male and 2 female clips)	GC \$148

Grommets	
2" Round Metal Grommet - Matte Black	GMBK \$138
2" Round Metal Grommet - Satin Chrome	GMSC \$138
2" Round Metal Grommet - Polished Chrome	GMPC \$138
2" Round Plastic Grommet - Matte Black	GPMBK \$44
Grommet location	use location code n/c

Edge Options	
1.75" Thick Edge (per table)	175E 15%
(see edge details for specific profiles)	

Modesty Panels	
Fixed Modesty Panel Laminate (48,60,72)	MODLFX \$248
Fixed Modesty Panel Veneer (48,60,72)	MODVFX \$386
Folding Modesty Panel Laminate (48,60,72)	MODLFL \$330
Folding Modesty Veneer (48,60,72)	MODVFL \$468

Wire Management	
J-Trough (horizontal mount) - Matte Black	WMJ \$116
Legway Wire Manager (vertical mount) - Matte Black	WML \$56

Data and Power	
Recessed Power and Data Module Two	DPBS2 \$396
Recessed Power and Data Module Four	DPBS4 \$688
Retractable Power and Data Module Two	DPAS2 \$606
Retractable Power and Data Module Three	DPAS3 \$688
Under Top Mounted Power and Data Module Two	DPUS2 \$358

Other	
Table Truck for Folding Tables	TTRK \$1512

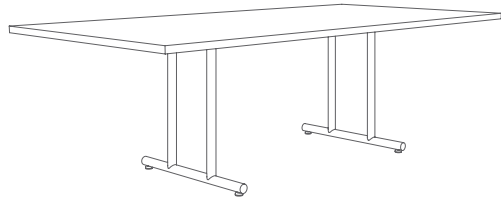

Laminate Tops

Wood Veneer Tops

Self Edge	Vinyl Edges	PVC Edges	Metal Edges	Wood Edges Group A	Wood Edges Group B	Wood Edges Group A	Wood Edges Group B
LLSE Self Edge	LVFL Flat	LPVC PVC	LMFL Flat	LWFL Flat	LWSQ Square	WWFL Flat	WWSQ Square
	LVBP Bumper		LMRB Ribbed	LWTP Tapered Ply	LWAR Arc	WWTP Tapered Ply	WWAR Arc
				LWFP Flat Ply	LWBN Bullnose	WWFP Flat Ply	WWBN Bullnose
					LWPR Prism		WWPR Prism
					LWPI Pivot		WWPI Pivot

Complete Table List Pricing

Top Size	Base Qty.	Base Style	Model #	\$									
Rectangle	30	36	1	X	SLX3036RE	732	732	777	792	1,014	1,212	1,086	1,308
	30	42	1	X	SLX3042RE	767	767	819	837	1,109	1,331	1,191	1,442
	30	48	1	X	SLX3048RE	889	889	945	965	1,239	1,480	1,330	1,599
	30	60	2	T	SLT3060RE	925	925	989	1,013	1,305	1,581	1,408	1,717
	30	72	2	T	SLT3072RE	993	993	1,070	1,097	1,381	1,694	1,495	1,844
	30	84	2	T	SLT3084RE	1,225	1,225	1,291	1,336	1,476	1,964	1,599	2,147
	30	96	2	T	SLT3096RE	1,295	1,295	1,368	1,416	1,571	2,137	1,707	2,342
	36	42	2	T	SLT3642RE	925	925	984	1,003	1,274	1,519	1,367	1,639
	36	48	2	T	SLT3648RE	965	965	1,027	1,048	1,328	1,589	1,425	1,717
	36	60	2	T	SLT3660RE	1,060	1,060	1,133	1,157	1,433	1,729	1,544	1,877
	36	72	2	T	SLT3672RE	1,143	1,143	1,220	1,248	1,561	1,896	1,686	2,065
	36	84	2	T	SLT3684RE	1,388	1,388	1,457	1,503	1,665	2,131	1,805	2,328
	36	96	2	TT	SLTT3696RE	1,590	1,590	1,673	1,717	1,890	2,425	2,043	2,644
	42	72	2	TT	SLTT4272RE	1,347	1,347	1,412	1,445	1,746	2,141	1,817	2,234
	42	84	2	TT	SLTT4284RE	1,603	1,603	1,673	1,722	1,860	2,368	2,096	2,681
	42	96	2	TT	SLTT4296RE	1,697	1,697	1,774	1,827	1,981	2,594	2,238	2,724
	48	96	2	TT	SLTT4896RE	1,878	1,878	1,953	2,008	2,236	2,891	2,609	3,096
	48	120	2	TT	SLTT48120RE	2,090	2,090	2,188	2,255	2,479	3,117	2,913	3,401
	48	144	3	TT	SLTT48144RE	2,705	2,705	2,800	2,880	3,125	3,771	3,627	4,162
	48	168	3	TT	SLTT48168RE	2,933	2,933	3,033	3,125	3,356	4,053	3,917	4,488
	60	120	2	TT	SLTT60120RE	2,351	2,351	2,443	2,524	2,699	3,343	3,117	3,741
60	144	3	TT	SLTT60144RE	3,001	3,001	3,104	3,201	3,468	4,053	4,057	4,579	
60	168	3	TT	SLTT60168RE	3,310	3,310	3,383	3,495	3,751	4,677	4,411	5,356	

Continued on next page

*T-bases can be specified on 30" x 42" and 30" x 48" rectangle tables, please refer to Base Only Pricing (p.231) and Top Only Pricing (p.241).
X-bases are recommended for dining applications.

How to Order

Table Model Number					Top Finish Selection		Options	
SLTT Base Series	4896 Top Size	RE Top Shape	WWSQ Top Material Edge Profile	MBK Base Finish	WMW Top Finish	WMW Edge Finish	GMBK Matte Black Grommet	E Location "E"
A SLTT4896REWWSQMBK is a Slimline series 48" x 96" rectangle table with two black powder coat TT-bases and a wood veneer 1.25" thick top with a 1.25" square wood edge profile.					The codes: WMW WMW specify a medium walnut top, with a medium walnut edge.		The code: GMBK specifies a matte black 2" diameter metal grommet.	
							The code: E specifies the location of the grommet.	

Specialty Tops

Butcher Block	Ultrafoam	Acrylic	Corian Group A,B	Corian Group C,D	3form Chroma
BBFL Flat	ULFP PVC	AAOP Opaque	C1FL Flat	C2FL Flat	3FFL Flat
BBBN Bullnose	ULFR Raw	AATL Translucent	C1BN Bullnose	C2BN Bullnose	3FBN Bullnose
			C1PR Prism	C2PR Prism	3FPR Prism

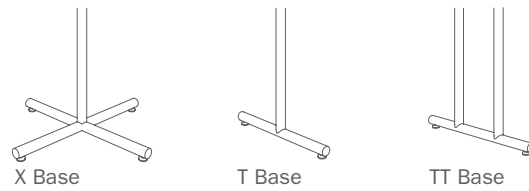

\$					
1,485	765	1,957	1,461	1,728	3,126
1,730	807	2,200	1,599	1,909	3,564
1,875	935	2,534	1,836	2,188	4,077
2,128	982	3,018	2,077	2,515	4,868
2,433	1,061	3,760	2,363	2,884	5,740
2,616	1,266	-	-	-	-
2,799	1,348	-	-	-	-
2,054	972	-	2,089	2,266	4,271
2,120	1,021	2,962	2,417	2,501	4,777
2,466	1,126	3,830	2,439	2,958	5,818
2,818	1,221	4,413	2,766	3,384	6,804
3,168	1,441	5,629	-	-	-
3,633	1,658	6,085	-	-	-
-	1,434	-	-	-	-
-	1,666	-	-	-	-
-	1,777	6,832	-	-	-
-	1,968	-	-	-	-
-	-	-	-	-	-
-	-	-	-	-	-
-	-	-	-	-	-
-	-	-	-	-	-
-	-	-	-	-	-
-	-	-	-	-	-
-	-	-	-	-	-

Options

Base Finishes		
Standard Powder Coat	use finish code	n/c
Polished or Satin Chrome (per base)	use finish code	\$114
Premium Plated (per base)	use finish code	Ⓛ
Custom Powder Coat (set-up charge)	CPC	\$363

Base Options		
Alternate Height Base (per column)	AH	\$66
Super Level Glides (per base)	GSL	\$34
Locking Casters 2" Twin Wheel (qty. 4)	TWC2	\$56
Tilt-top - (standard cable release)	TMX/TMT	\$270 X-base/ \$418 T-base
Folding	FM	\$270 T-base

Top Materials and Finishes		
Standard Laminates	use manufacturers finish code	n/c
Premium Laminates	PRL	Ⓛ
Custom Wood Veneer	CWW	Ⓛ
Special Pattern Veneer	SPV	Ⓛ
Stain to Match (set-up charge)	STM	\$412

Top Options		
Custom Size	CS	Ⓛ
Custom Shape	CSH	Ⓛ
Custom Radius Corner	CRC	Ⓛ
3" Radius Corner (per corner)	CRL3	\$34
(laminate self edge, ultrafoam, Corian®, 3form chroma)		
3" Wood Radius Corner (per corner)	CRW3	\$82
(not available in LWFL, WWFL, LWPI and WWPI)		
Ganging Clips (1 set includes 2 male and 2 female clips)	GC	\$148

Grommets		
2" Round Metal Grommet - Matte Black	GMBK	\$138
2" Round Metal Grommet - Satin Chrome	GMSC	\$138
2" Round Metal Grommet - Polished Chrome	GMPC	\$138
2" Round Plastic Grommet - Matte Black	GPMBK	\$44
Grommet location	use location code	n/c

Edge Options		
1.75" Thick Edge (per table)	175E	15%
(see edge details for specific profiles)		

Modesty Panels		
Fixed Modesty Panel Laminate (48,60,72)	MODLFX	\$248
Fixed Modesty Panel Veneer (48,60,72)	MODVFX	\$386
Folding Modesty Panel Laminate (48,60,72)	MODLFL	\$330
Folding Modesty Veneer (48,60,72)	MODVFL	\$468

Wire Management		
J-Trough (horizontal mount) - Matte Black	WMJ	\$116
Legway Wire Manager (vertical mount) - Matte Black	WML	\$56

Data and Power		
Recessed Power and Data Module Two	DPBS2	\$396
Recessed Power and Data Module Four	DPBS4	\$688
Retractable Power and Data Module Two	DPAS2	\$606
Retractable Power and Data Module Three	DPAS3	\$688
Under Top Mounted Power and Data Module Two	DPUS2	\$358

Other		
Table Truck for Folding Tables	TRTK	\$1512

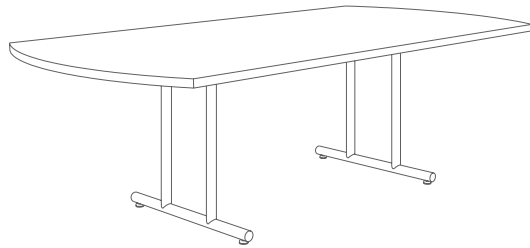

Laminate Tops

Wood Veneer Tops

Self Edge	Vinyl Edges	PVC Edges	Metal Edges	Wood Edges Group A	Wood Edges Group B	Wood Edges Group A	Wood Edges Group B
LLSE Self Edge	LVFL Flat	LPVC PVC	LMFL Flat	LWFL Flat	LWSQ Square	WWFL Flat	WWSQ Square
	LVBP Bumper		LMRB Ribbed	LWTP Tapered Ply	LWAR Arc	WWTP Tapered Ply	WWAR Arc
				LWFP Flat Ply	LWBN Bullnose	WWFP Flat Ply	WWBN Bullnose
					LWPR Prism		WWPR Prism
					LWPI Pivot		WWPI Pivot

Complete Table List Pricing

	Top Size	Base Qty.	Base Style	Model #	\$								
Half Round	24 48	2	T	SLT2448HR	773	773	823	839	963	1,216	1,026	1,263	
	30 60	2	T	SLT3060HR	938	938	1,006	1,029	1,147	1,443	1,231	1,577	
	36 72	2	T	SLT3672HR	1,159	1,159	1,240	1,266	1,383	1,740	1,591	1,853	
Arc Rectangle	30 60	2	T	SLT3060AR	938	938	993	1,015	1,272	1,585	1,408	1,729	
	30 72	2	T	SLT3072AR	1,029	1,029	1,079	1,104	1,386	1,783	1,494	1,857	
	30 84	2	T	SLT3084AR	1,207	1,207	1,288	1,328	1,476	1,925	1,602	2,161	
	30 96	2	T	SLT3096AR	1,280	1,280	1,367	1,410	1,585	2,122	1,702	2,365	
	36 60	2	T	SLT3660AR	1,093	1,093	1,135	1,157	1,433	1,795	1,544	1,900	
	36 72	2	T	SLT3672AR	1,196	1,196	1,244	1,270	1,558	1,966	1,686	2,079	
	36 84	2	T	SLT3684AR	1,375	1,375	1,460	1,501	1,665	2,135	1,805	2,334	
	36 96	2	TT	SLTT3696AR	1,580	1,580	1,673	1,713	1,892	2,509	2,047	2,658	
	42 72	2	TT	SLTT4272AR	1,462	1,462	1,484	1,520	1,746	2,192	1,817	2,481	
	42 84	2	TT	SLTT4284AR	1,590	1,590	1,673	1,717	1,833	2,454	2,096	2,742	
	42 96	2	TT	SLTT4296AR	1,687	1,687	1,774	1,822	1,973	2,652	2,238	2,991	
	48 96	2	TT	SLTT4896AR	1,900	1,900	1,954	2,004	2,236	2,948	2,609	3,175	
	48 120	2	TT	SLTT48120AR	2,074	2,074	2,193	2,255	2,479	3,288	2,913	3,570	
	48 144	3	TT	SLTT48144AR	2,684	2,684	2,806	2,880	3,166	4,026	3,678	4,452	
	48 168	3	TT	SLTT48168AR	2,906	2,906	3,033	3,117	3,411	4,506	3,987	4,855	

Continued on next page

How to Order

Table Model Number					Top Finish Selection		Options	
SLTT Base Series	4272 Top Size	AR Top Shape	WWSQ Top Material Edge Profile	MBK Base Finish	WMW Top Finish	WMW Edge Finish	GMBK Matte Black Grommet	C Location "C"
A SLTT4272ARWWSQMBK is a Slimline series 42" x 72" arc rectangle table with two black powder coat TT-bases and a wood veneer 1.25" thick top with a 1.25" square wood edge profile.					The codes: WMW WMW specify a medium walnut top, with a medium walnut edge.		The code: GMBK specifies a matte black 2" diameter metal grommet.	
							The code: C specifies the location of the grommet.	

Specialty Tops

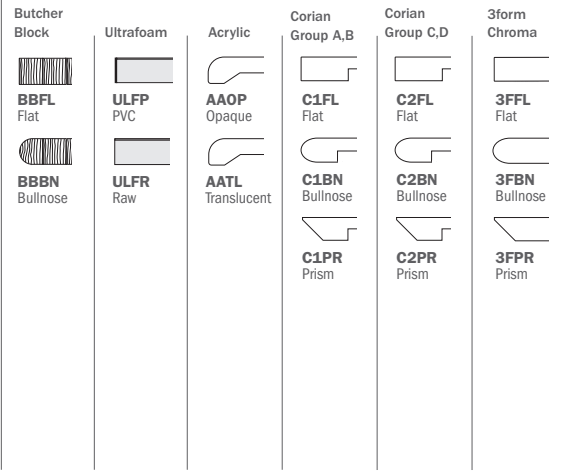

\$					
-	-	-	-	-	-
-	-	-	-	-	-
-	-	-	-	-	-
-	-	-	-	-	-
-	-	-	-	-	-
-	-	-	-	-	-
-	-	-	-	-	-
-	-	-	-	-	-
-	-	-	-	-	-
-	-	-	-	-	-
-	-	-	-	-	-
-	-	-	-	-	-
-	-	-	-	-	-
-	-	-	-	-	-
-	-	-	-	-	-
-	-	-	-	-	-
-	-	-	-	-	-

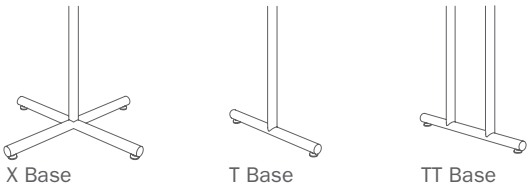

Options

Base Finishes			
Standard Powder Coat	use finish code		n/c
Polished or Satin Chrome (per base)	use finish code		\$114
Premium Plated (per base)	use finish code		ⓐ
Custom Powder Coat (set-up charge)	CPC		\$363

Base Options			
Alternate Height Base (per column)	AH		\$66
Super Level Glides (per base)	GSL		\$34
Locking Casters 2" Twin Wheel (qty. 4)	TWC2		\$56
Tilt-top - (standard cable release)	TMX/TMT	\$270 X-base/	\$418 T-base
Folding	FM		\$270 T-base

Top Materials and Finishes			
Standard Laminates	use manufacturers finish code		n/c
Premium Laminates	PRL		ⓐ
Custom Wood Veneer	CWV		ⓐ
Special Pattern Veneer	SPV		ⓐ
Stain to Match (set-up charge)	STM		\$412

Top Options			
Custom Size	CS		ⓐ
Custom Shape	CSH		ⓐ
Custom Radius Corner	CRC		ⓐ
3" Radius Corner (per corner)	CRL3		\$34
(laminate self edge, ultrafoam, Corian®, 3form chroma)			
3" Wood Radius Corner (per corner)	CRW3		\$82
(not available in LWFL, WWFL, LWPI and WWPI)			
Ganging Clips (1 set includes 2 male and 2 female clips)	GC		\$148

Grommets			
2" Round Metal Grommet - Matte Black	GMBK		\$138
2" Round Metal Grommet - Satin Chrome	GMSC		\$138
2" Round Metal Grommet - Polished Chrome	GMPC		\$138
2" Round Plastic Grommet - Matte Black	GPMBK		\$44
Grommet location	use location code		n/c

Edge Options			
1.75" Thick Edge (per table)	175E		15%
(see edge details for specific profiles)			

Modesty Panels			
Fixed Modesty Panel Laminate (48,60,72)	MODLFX		\$248
Fixed Modesty Panel Veneer (48,60,72)	MODVFX		\$386
Folding Modesty Panel Laminate (48,60,72)	MODLFL		\$330
Folding Modesty Veneer (48,60,72)	MODVFL		\$468

Wire Management			
J-Trough (horizontal mount) - Matte Black	WMJ		\$116
Legway Wire Manager (vertical mount) - Matte Black	WML		\$56

Data and Power			
Recessed Power and Data Module Two	DPBS2		\$396
Recessed Power and Data Module Four	DPBS4		\$688
Retractable Power and Data Module Two	DPAS2		\$606
Retractable Power and Data Module Three	DPAS3		\$688
Under Top Mounted Power and Data Module Two	DPUS2		\$358

Other			
Table Truck for Folding Tables	TRRK		\$1512

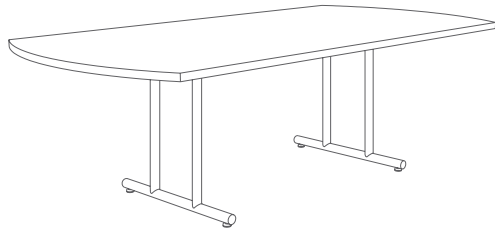

Laminate Tops

Wood Veneer Tops

Self Edge	Vinyl Edges	PVC Edges	Metal Edges	Wood Edges Group A	Wood Edges Group B	Wood Edges Group A	Wood Edges Group B
LLSE Self Edge	LVFL Flat	LPVC PVC	LMFL Flat	LWFL Flat	LWSQ Square	WWFL Flat	WWSQ Square
	LVBP Bumper		LMRB Ribbed	LWTP Tapered Ply	LWAR Arc	WWTP Tapered Ply	WWAR Arc
				LWFP Flat Ply	LWBN Bullnose	WWFP Flat Ply	WWBN Bullnose
					LWPR Prism		WWPR Prism
					LWPI Pivot		WWPI Pivot

Complete Table List Pricing

	Top Size	Base Qty.	Base Style	Model #	\$								
Arc Rectangle 	60 120	2	TT	SLTT60120AR	2,337	2,337	2,482	2,559	2,722	3,598	3,142	3,944	
	60 144	3	TT	SLTT60144AR	2,993	2,993	3,137	3,228	3,547	4,393	3,851	5,064	
	60 168	3	TT	SLTT60168AR	3,269	3,269	3,415	3,520	3,835	4,790	4,174	5,454	
Boat Shape 	36 42 72	2	T	SLT3672BS	1,561	1,561	1,526	1,573	1,807	2,231	1,966	2,443	
	36 48 84	2	TT	SLTT3684BS	1,796	1,796	1,861	1,917	2,222	2,617	2,417	2,864	
	36 48 96	2	TT	SLTT3696BS	1,915	1,915	1,979	2,036	2,388	2,735	2,604	2,993	
	36 48 120	2	TT	SLTT36120BS	2,152	2,152	2,229	2,300	2,771	3,004	3,035	3,296	
	36 48 144	3	TT	SLTT36144BS	2,746	2,746	2,835	2,921	3,582	3,822	3,903	4,174	
	36 48 168	3	TT	SLTT36168BS	2,972	2,972	3,084	3,182	3,917	4,043	4,281	4,423	

How to Order

Table Model Number					Top Finish Selection		Options	
SLTT Base Series	364884 Top Size	AR Top Shape	WWSQ Top Material Edge Profile	MBK Base Finish	WMW Top Finish	WMW Edge Finish	GMBK Matte Black Grommet	G Location "G"
A SLTT364884ARWWSQMBK is a Slimline series 36" x 48" x 84" arc rectangle table with two black powder coat TT-bases and a wood veneer 1.25" thick top with a 1.25" square wood edge profile.					The codes: WMW WMW specify a medium walnut top, with a medium walnut edge.		The code: GMBK specifies a matte black 2" diameter metal grommet.	
							The code: G specifies the location of the grommet.	

Specialty Tops

Butcher Block	Ultrafoam	Acrylic	Corian Group A,B	Corian Group C,D	3form Chroma
BBFL Flat	ULFP PVC	AAOP Opaque	C1FL Flat	C2FL Flat	3FFL Flat
BBBN Bullnose	ULFR Raw	AATL Translucent	C1BN Bullnose	C2BN Bullnose	3FBN Bullnose
			C1PR Prism	C2PR Prism	3FPR Prism

\$					
-	-	-	-	-	-
-	-	-	-	-	-
-	-	-	-	-	-
-	-	-	-	-	-
-	-	-	-	-	-

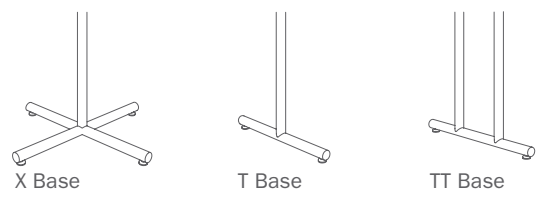

Options

Base Finishes		
Standard Powder Coat	use finish code	n/c
Polished or Satin Chrome (per base)	use finish code	\$114
Premium Plated (per base)	use finish code	Ⓛ
Custom Powder Coat (set-up charge)	CPC	\$363

Base Options		
Alternate Height Base (per column)	AH	\$66
Super Level Glides (per base)	GSL	\$34
Locking Casters 2" Twin Wheel (qty. 4)	TWC2	\$56
Tilt-top - (standard cable release)	TMX/TMT	\$270 X-base/ \$418 T-base
Folding	FM	\$270 T-base

Top Materials and Finishes		
Standard Laminates	use manufacturers finish code	n/c
Premium Laminates	PRL	Ⓛ
Custom Wood Veneer	CWV	Ⓛ
Special Pattern Veneer	SPV	Ⓛ
Stain to Match (set-up charge)	STM	\$412

Top Options		
Custom Size	CS	Ⓛ
Custom Shape	CSH	Ⓛ
Custom Radius Corner	CRC	Ⓛ
3" Radius Corner (per corner)	CRL3	\$34
(laminate self edge, ultrafoam, Corian®, 3form chroma)		
3" Wood Radius Corner (per corner)	CRW3	\$82
(not available in LWFL, WWFL, LWPI and WWPI)		
Ganging Clips (1 set includes 2 male and 2 female clips)	GC	\$148

Grommets		
2" Round Metal Grommet - Matte Black	GMBK	\$138
2" Round Metal Grommet - Satin Chrome	GMSC	\$138
2" Round Metal Grommet - Polished Chrome	GMPC	\$138
2" Round Plastic Grommet - Matte Black	GPMBK	\$44
Grommet location	use location code	n/c

Edge Options		
1.75" Thick Edge (per table)	175E	15%
(see edge details for specific profiles)		

Modesty Panels		
Fixed Modesty Panel Laminate (48,60,72)	MODLFX	\$248
Fixed Modesty Panel Veneer (48,60,72)	MODVFX	\$386
Folding Modesty Panel Laminate (48,60,72)	MODLFL	\$330
Folding Modesty Veneer (48,60,72)	MODVFL	\$468

Wire Management		
J-Trough (horizontal mount) - Matte Black	WMJ	\$116
Legway Wire Manager (vertical mount) - Matte Black	WML	\$56

Data and Power		
Recessed Power and Data Module Two	DPBS2	\$396
Recessed Power and Data Module Four	DPBS4	\$688
Retractable Power and Data Module Two	DPAS2	\$606
Retractable Power and Data Module Three	DPAS3	\$688
Under Top Mounted Power and Data Module Two	DPUS2	\$358

Other		
Table Truck for Folding Tables	TRRK	\$1512



Laminate Tops

Wood Veneer Tops

Self Edge	Vinyl Edges	PVC Edges	Metal Edges	Wood Edges Group A	Wood Edges Group B	Wood Edges Group A	Wood Edges Group B
LLSE Self Edge	LVFL Flat	LPVC PVC	LMFL Flat	LWFL Flat	LWSQ Square	WWFL Flat	WWSQ Square
	LVBP Bumper		LMRB Ribbed	LWTP Tapered Ply	LWAR Arc	WWTP Tapered Ply	WWAR Arc
				LWFP Flat Ply	LWBN Bullnose	WWFP Flat Ply	WWBN Bullnose
					LWPR Prism		WWPR Prism
					LWPI Pivot		WWPI Pivot

Complete Table List Pricing

	Top Size	Base Qty.	Base Style	Model #	\$							
Round 	24	1	X	SVX24RD	319	319	369	417	527	696	537	768
	30	1	X	SVX30RD	379	379	441	474	640	821	640	908
	36	1	X	SVX36RD	479	479	551	597	786	996	812	1,101
	42	1	X	SVX42RD	580	580	660	660	902	1,160	996	1,286
	48	1	X	SVX48RD	798	798	889	916	1,156	1,452	1,267	1,601
	54	1	X	SVX54RD	909	909	1,014	1,043	1,372	1,983	1,510	2,197
	60	1	X	SVX60RD	1,086	1,086	1,199	1,253	1,492	2,066	1,851	2,292
Square 	24 24	1	X	SVX2424SQ	319	319	375	429	527	696	537	768
	30 30	1	X	SVX3030SQ	379	379	447	494	640	821	640	908
	36 36	1	X	SVX3636SQ	479	479	547	616	776	996	812	1,101
	42 42	1	X	SVX4242SQ	683	683	759	808	1,017	1,275	1,111	1,401
	48 48	1	X	SVX4848SQ	800	800	889	948	1,156	1,452	1,267	1,601
Rectangle 	24 30	1	X	SVX2430RE	348	348	395	407	588	774	669	854
	24 36	1	EX	SVEX2436RE	407	407	459	473	681	862	747	950
	24 42	1	EX	SVEX2442RE	440	440	485	500	722	921	792	1,016
	24 48	1	EX	SVEX2448RE	475	475	531	549	794	1,016	874	1,121
	24 60	2	T	SVT2460RE	557	557	618	639	899	1,152	987	1,272
	24 72	2	T	SVT2472RE	615	615	685	710	996	1,285	1,098	1,424
	30 36	1	EX	SVEX3036RE	452	452	497	512	734	932	806	1,028
	30 42	1	EX	SVEX3042RE	487	487	539	557	829	1,051	911	1,162
	30 48	1	EX	SVEX3048RE	524	524	580	600	874	1,115	965	1,234
	30 60	2	T	SVT3060RE	655	655	719	743	1,035	1,311	1,138	1,447
	30 72	2	T	SVT3072RE	723	723	800	827	1,111	1,424	1,225	1,574
	36 42	1	EX	SVEX3642RE	535	535	594	613	884	1,129	977	1,249
	36 48	1	EX	SVEX3648RE	575	575	637	658	938	1,199	1,035	1,327
	36 60	2	T	SVT3660RE	720	720	793	817	1,093	1,389	1,204	1,537
	36 72	2	T	SVT3672RE	803	803	880	908	1,221	1,556	1,346	1,725

How to Order

Table Model Number					Top Finish Selection		Options
SVX Base Series	36 Top Size	RD Top Shape	WWSQ Top Material Edge Profile	MBK Base Finish	WMW Top Finish	WMW Edge Finish	GSL Super Level Glides
A SVX36RDWWSQMBK is a Spacesaver series 36" round table with a black powder coat X-base and a wood veneer 1.25" thick top with a 1.25" square wood edge profile.					The codes: WMW WMW specify a medium walnut top, with a medium walnut edge.		The code: GSL specifies super level glides.

Specialty Tops

Butcher Block	Ultrafoam	Acrylic	Corian Group A,B	Corian Group C,D	3form Chroma
BBFL Flat	ULFP PVC	AAOP Opaque	C1FL Flat	C2FL Flat	3FFL Flat
BBBN Bullnose	ULFR Raw	AATL Translucent	C1BN Bullnose	C2BN Bullnose	3FBN Bullnose
			C1PR Prism	C2PR Prism	3FPR Prism

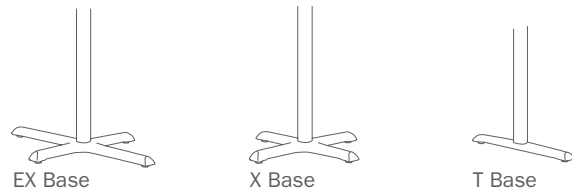

Options

Base Finishes

Standard Black Wrinkle	MWR	n/c
Powder Coat	use finish code	\$110
Custom Powder Coat (set-up charge)	CPC	\$363

Base Options

Alternate Height Base (per column)	AH	\$66
Super Level Glides (per base)	GSL	\$34
Custom Top Plate Size	CTPS	🔗

Top Materials and Finishes

Standard Laminates	use manufacturers finish code	n/c
Premium Laminates	PRL	🔗
Custom Wood Veneer	CWV	🔗
Special Pattern Veneer	SPV	🔗
Stain to Match (set-up charge)	STM	\$412

Top Options

Custom Size	CS	🔗
Custom Shape	CSH	🔗
Custom Radius Corner	CRC	🔗
3" Radius Corner (per corner)	CRL3	\$34
(laminates self edge, ultrafoam, Corian®, 3form chroma)		
3" Wood Radius Corner (per corner)	CRW3	\$82
(not available in LWFL, WWFL, LWPI and WWPI)		

Edge Options

1.75" Thick Edge (per table)	175E	15%
(see edge details for specific profiles)		

\$					
684	338	929	844	1,021	1,433
930	412	1,387	1,116	1,380	2,433
1,257	522	1,868	1,484	1,842	3,363
1,782	634	2,519	1,875	2,352	4,499
2,172	864	3,490	2,434	3,037	5,918
-	994	4,593	2,918	3,666	-
-	1,140	5,807	3,469	4,381	-
754	352	931	759	912	1,400
1,023	412	1,392	1,011	1,239	2,388
1,375	522	1,875	1,366	1,685	3,311
2,082	738	2,642	1,850	2,274	4,550
2,388	866	3,500	2,280	2,825	5,857
871	371	1,143	875	1,058	1,982
1,035	436	1,457	1,018	1,234	2,339
1,229	472	1,582	1,129	1,382	2,675
1,284	512	1,767	1,243	1,531	3,008
1,554	605	-	1,508	1,861	3,741
1,804	672	-	1,747	2,171	4,406
1,205	485	1,677	1,181	1,448	2,846
1,450	527	1,920	1,319	1,629	3,284
1,510	570	2,169	1,471	1,823	3,712
1,858	712	2,748	1,807	2,245	4,598
2,163	791	3,490	2,093	2,614	5,470
1,664	582	-	1,699	1,876	3,881
1,730	631	2,572	2,027	2,111	4,387
2,126	786	3,490	2,099	2,618	5,478
2,478	881	4,073	2,426	3,044	6,464

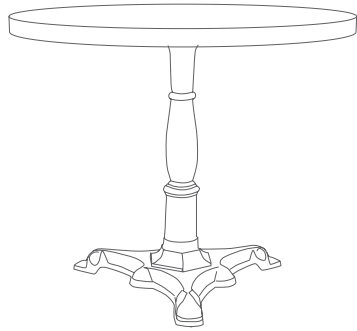

Laminate Tops

Wood Veneer Tops

Self Edge	Vinyl Edges	PVC Edges	Metal Edges	Wood Edges Group A	Wood Edges Group B	Wood Edges Group A	Wood Edges Group B
LLSE Self Edge	LVFL Flat	LPVC PVC	LMFL Flat	LWFL Flat	LWSQ Square	WWFL Flat	WWSQ Square
	LVBP Bumper		LMRB Ribbed	LWTP Tapered Ply	LWAR Arc	WWTP Tapered Ply	WWAR Arc
				LWFP Flat Ply	LWBN Bullnose	WWFP Flat Ply	WWBN Bullnose
					LWPR Prism		WWPR Prism
					LWPI Pivot		WWPI Pivot

Complete Table List Pricing

	Top Size	Base Qty.	Model #	\$							
Round	30	1	T030RD	669	669	731	764	930	1,111	930	1,198
	36	1	T036RD	749	749	821	867	1,056	1,266	1,082	1,371
	42	1	T042RD	850	850	930	930	1,172	1,430	1,266	1,556
Square	30 30	1	T03030SQ	669	669	737	784	930	1,111	930	1,198
	36 36	1	T03636SQ	749	749	817	886	1,046	1,266	1,082	1,371
	42 42	1	T04242SQ	838	838	914	963	1,172	1,430	1,266	1,556
Rectangle	30 36	1	T03036RE	712	712	757	772	994	1,192	1,066	1,288
	30 42	1	T03042RE	747	747	799	817	1,089	1,311	1,171	1,422

How to Order















Table Model Number					Top Finish Selection		Options
TO Base Series	36 Top Size	RD Top Shape	WWSQ Top Material	MBK Base Finish	WMW Top Finish	WMW Edge Finish	GSL Super Level Glides

A T036RDWWSQMBK is a Toscana series 36" round table with a decorative black powder coat base and a wood veneer 1.25" thick top with a 1.25" square wood edge profile.

The codes: WMW WMW specify a medium walnut top, with a medium walnut edge.

The code: GSL specifies super level glides.

Specialty Tops

Butcher Block	Ultrafoam	Acrylic	Corian Group A,B	Corian Group C,D	3form Chroma
 BBFL Flat	 ULFP PVC	 AAOP Opaque	 C1FL Flat	 C2FL Flat	 3FFL Flat
 BBBN Bullnose	 ULFR Raw	 AATL Translucent	 C1BN Bullnose	 C2BN Bullnose	 3FBN Bullnose
			 C1PR Prism	 C2PR Prism	 3FPR Prism

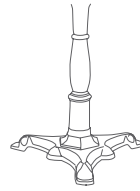

Options

Base Finishes

Standard Powder Coat	use finish code	n/c
Custom Powder Coat (set-up charge)	CPC	\$363

Base Options

Alternate Height Base (per column)	AH	\$166
Super Level Glides (per base)	GSL	\$34
Custom Top Plate Size	CTPS	🕒

Top Materials and Finishes

Standard Laminates	use manufacturers finish code	n/c
Premium Laminates	PRL	🕒
Custom Wood Veneer	CWV	🕒
Special Pattern Veneer	SPV	🕒
Stain to Match (set-up charge)	STM	\$412

Top Options

Custom Size	CS	🕒
Custom Shape	CSH	🕒
Custom Radius Corner	CRC	🕒
3" Radius Corner (per corner)	CRL3	\$34
(laminates self edge, ultrafoam, Corian®, 3form chroma)		
3" Wood Radius Corner (per corner)	CRW3	\$82
(not available in LWFL, WWFL, LWPI and WWPI)		

Edge Options

1.75" Thick Edge (per table)	175E	15%
(see edge details for specific profiles)		

\$					
1,220	702	1,677	1,406	1,670	2,723
1,527	792	2,138	1,754	2,112	3,633
2,052	904	2,789	2,145	2,622	4,769

1,313	702	1,682	1,301	1,529	2,678
1,645	792	2,145	1,636	1,955	3,581
2,237	893	2,797	2,005	2,429	4,705

1,465	745	1,937	1,441	1,708	3,106
1,710	787	2,180	1,579	1,889	3,544



Laminate Tops

Wood Veneer Tops

Self Edge	Vinyl Edges	PVC Edges	Metal Edges	Wood Edges Group A	Wood Edges Group B	Wood Edges Group A	Wood Edges Group B
LLSE Self Edge	LVFL Flat	LPVC PVC	LMFL Flat	LWFL Flat	LWSQ Square	WWFL Flat	WWSQ Square
	LVBP Bumper		LMRB Ribbed	LWTP Tapered Ply	LWAR Arc	WWTP Tapered Ply	WWAR Arc
				LWFP Flat Ply	LWBN Bullnose	WWFP Flat Ply	WWBN Bullnose
					LWPR Prism		WWPR Prism
					LWPI Pivot		WWPI Pivot

Complete Table List Pricing

	Top Size	Base Qty.	Base Style	Model #	\$								
Round	24	1	18L	TL18L24RD	789	789	839	887	997	1,166	1,007	1,238	
	30	1	18M	TL18M30RD	904	904	966	999	1,165	1,346	1,165	1,433	
	36	1	18H	TL18H36RD	1,054	1,054	1,126	1,172	1,361	1,571	1,387	1,676	
	42	1	24M	TL24M42RD	1,195	1,195	1,275	1,275	1,517	1,775	1,611	1,901	
	48	1	24H	TL24H48RD	1,413	1,413	1,504	1,531	1,771	2,067	1,882	2,216	
	54	1	24XH	TL24XH54RD	1,559	1,559	1,664	1,693	2,022	2,633	2,160	2,847	
	60	1	24XH	TL24XH60RD	1,736	1,736	1,849	1,903	2,142	2,716	2,501	2,942	
Oval	36	72	2	18H	TL18H3672OV	2,074	2,074	2,125	2,150	2,333	2,555	2,506	2,722
	42	54	2	24XH	TL24XH4254OV	2,131	2,131	2,158	2,222	2,363	2,690	2,514	2,750
	42	78	2	24M	TL24M4278OV	2,423	2,423	2,464	2,509	2,657	2,878	2,800	3,047
	42	84	2	24M	TL24M4284OV	2,479	2,479	2,533	2,577	2,707	2,958	2,853	3,137
	48	78	2	24H	TL24H4878OV	2,744	2,744	2,801	2,847	2,970	3,219	3,122	3,402
	48	96	2	24H	TL24H4896OV	2,920	2,920	2,976	3,026	3,118	3,390	3,480	3,797
Racetrack	30	60	2	18M	TL18M3060RA	1,767	1,767	1,825	1,847	2,137	2,415	2,238	2,583
	30	72	2	18M	TL18M3072RA	1,835	1,835	1,907	1,932	2,211	2,555	2,324	2,687
	30	84	2	18M	TL18M3084RA	2,065	2,065	2,129	2,170	2,308	2,794	2,434	2,991
	30	96	2	18M	TL18M3096RA	2,135	2,135	2,207	2,251	2,402	3,008	2,532	3,195
	36	60	2	18H	TL18H3660RA	1,973	1,973	2,041	2,063	2,333	2,640	2,444	2,800
	36	72	2	18H	TL18H3672RA	2,053	2,053	2,132	2,157	2,465	2,808	2,592	2,979
	36	84	2	18H	TL18H3684RA	2,290	2,290	2,369	2,411	2,565	3,035	2,709	3,259
	36	96	2	18H	TL18H3696RA	2,370	2,370	2,463	2,504	2,672	3,261	2,827	3,438
	42	72	2	24M	TL24M4272RA	2,217	2,217	2,291	2,322	2,606	3,001	2,677	3,285
	42	84	2	24M	TL24M4284RA	2,471	2,471	2,538	2,582	2,705	3,256	2,851	3,576
	42	96	2	24M	TL24M4296RA	2,567	2,567	2,636	2,685	2,828	3,454	2,991	3,851

Continued on next page

How to Order

Table Model Number					Top Finish Selection		Options
TL18H Base Series	36 Top Size	RD Top Shape	WWSQ Top Material Edge Profile	MBK Base Finish	WMW Top Finish	WMW Edge Finish	GSL Super Level Glides

A TL18H36RDWWSQMBK is a Tulip series 36" round table with a black powder coat, heavy-weighted round base and a wood veneer 1.25" thick top with a 1.25" square wood edge profile.

The codes: WMW WMW specify a medium walnut top, with a medium walnut edge.

The code: GSL specifies super level glides.

Specialty Tops

Butcher Block	Ultrafoam	Acrylic	Corian Group A,B	Corian Group C,D	3form Chroma
BBFL Flat	ULFP PVC	AAOP Opaque	C1FL Flat	C2FL Flat	3FFL Flat
BBBN Bullnose	ULFR Raw	AATL Translucent	C1BN Bullnose	C2BN Bullnose	3FBN Bullnose
			C1PR Prism	C2PR Prism	3FPR Prism

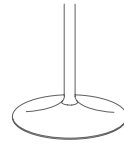

Options

Base Finishes		
Standard Powder Coat	use finish code	n/c
Polished or Satin Chrome (per base)	use finish code	\$194
Premium Plated (per base)	use finish code	Ⓛ
Custom Powder Coat (set-up charge)	CPC	\$363

Base Options		
Alternate Height Base (per column)	AH	\$66
Super Level Glides (per base)	GSL	\$34
Custom Top Plate Size	CTPS	Ⓛ

Top Materials and Finishes		
Standard Laminates	use manufacturers finish code	n/c
Premium Laminates	PRL	Ⓛ
Custom Wood Veneer	CWV	Ⓛ
Special Pattern Veneer	SPV	Ⓛ
Stain to Match (set-up charge)	STM	\$412

Top Options		
Custom Size	CS	Ⓛ
Custom Shape	CSH	Ⓛ
Custom Radius Corner	CRC	Ⓛ
3" Radius Corner (per corner)	CRL3	\$34
(laminates self edge, ultrafoam, Corian®, 3form chroma)		
3" Wood Radius Corner (per corner)	CRW3	\$82
(not available in LWFL, WWFL, LWPI and WWPI)		

Grommets		
2" Round Metal Grommet - Matte Black	GMBK	\$138
2" Round Metal Grommet - Satin Chrome	GMSC	\$138
2" Round Metal Grommet - Polished Chrome	GMPC	\$138
2" Round Plastic Grommet - Matte Black	GPMBK	\$44
Grommet location	use location code	n/c

Edge Options		
1.75" Thick Edge (per table)	175E	15%
<i>(see edge details for specific profiles)</i>		

\$					
1,154	808	1,399	1,314	1,491	1,903
1,455	937	1,912	1,641	1,905	2,958
1,832	1,097	2,443	2,059	2,417	3,938
2,397	1,249	3,134	2,490	2,967	5,114
2,787	1,479	4,105	3,049	3,652	6,533
-	1,644	5,243	3,568	4,316	-
-	1,790	6,457	4,119	5,031	-
-	-	-	-	-	-
-	-	4,967	-	-	-
-	-	6,354	-	-	-
-	-	-	-	-	-
-	-	7,362	-	-	-
-	-	-	-	-	-
-	-	-	-	-	-
-	-	-	-	-	-
-	-	-	-	-	-
-	-	-	-	-	-
-	-	-	-	-	-
-	-	-	-	-	-
-	-	-	-	-	-
-	-	-	-	-	-
-	-	-	-	-	-
-	-	-	-	-	-

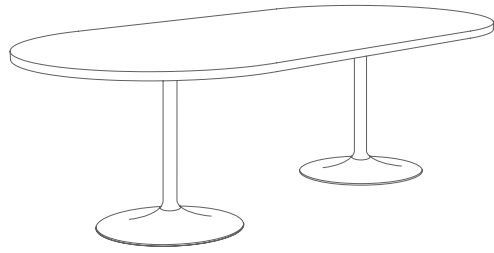

Laminate Tops

Wood Veneer Tops

Self Edge	Vinyl Edges	PVC Edges	Metal Edges	Wood Edges Group A	Wood Edges Group B	Wood Edges Group A	Wood Edges Group B
LLSE Self Edge	LVFL Flat	LPVC PVC	LMFL Flat	LWFL Flat	LWSQ Square	WWFL Flat	WWSQ Square
	LVBP Bumper		LMRB Ribbed	LWTP Tapered Ply	LWAR Arc	WWTP Tapered Ply	WWAR Arc
				LWFP Flat Ply	LWBN Bullnose	WWFP Flat Ply	WWBN Bullnose
					LWPR Prism		WWPR Prism
					LWPI Pivot		WWPI Pivot

Complete Table List Pricing

	Top Size	Base Qty.	Base Style	Model #	\$							
	48 96	2	24H	TL24H4896RA	2,900	2,900	2,980	3,030	3,260	3,911	3,629	4,137
	48 120	2	24H	TL24H48120RA	3,112	3,112	3,213	3,275	3,503	4,250	3,933	4,590
	48 144	3	24H	TL24H48144RA	4,255	4,255	4,370	4,447	4,688	5,498	5,200	5,923
	48 168	3	24H	TL24H48168RA	4,470	4,470	4,593	4,680	4,939	5,867	5,515	6,349
	60 120	2	24XH	TL24XH60120RA	3,454	3,454	3,563	3,639	3,754	4,660	4,203	5,057
	60 144	3	24XH	TL24XH60144RA	4,684	4,684	4,785	4,877	5,132	5,972	5,464	6,441
	60 168	3	24XH	TL24XH60168RA	4,949	4,949	5,060	5,165	5,426	6,367	6,098	7,217
	24 24	1	18L	TL18L2424SQ	789	789	845	899	997	1,166	1,007	1,238
	30 30	1	18M	TL18M3030SQ	904	904	972	1,019	1,165	1,346	1,165	1,433
	36 36	1	18H	TL18H3636SQ	1,054	1,054	1,122	1,191	1,351	1,571	1,387	1,676
	42 42	1	24H	TL24H4242SQ	1,298	1,298	1,374	1,423	1,632	1,890	1,726	2,016
	48 48	1	24XH	TL24XH4848SQ	1,450	1,450	1,539	1,598	1,806	2,102	1,917	2,251
	24 30	1	18M	TL18M2430RE	873	873	920	932	1,113	1,299	1,194	1,379
	24 36	1	18H	TL18H2436RE	972	972	1,024	1,038	1,246	1,427	1,312	1,515
	24 42	1	24M	TL24M2442RE	1,045	1,045	1,090	1,105	1,327	1,526	1,397	1,621
	24 48	1	24H	TL24H2448RE	1,195	1,195	1,251	1,269	1,514	1,736	1,594	1,841
	24 60	2	18L	TL18L2460RE	1,577	1,577	1,637	1,658	1,918	2,171	2,007	2,291
	24 72	2	18L	TL18L2472RE	1,635	1,635	1,705	1,729	2,015	2,305	2,118	2,443
	24 84	2	18L	TL18L2484RE	1,852	1,852	1,917	1,957	2,097	2,585	2,210	2,760
	24 96	2	18L	TL18L2496RE	1,910	1,910	1,981	2,025	2,179	2,706	2,301	2,896
	30 36	1	18H	TL18H3036RE	1,017	1,017	1,062	1,077	1,299	1,497	1,371	1,593
	30 42	1	24M	TL24M3042RE	1,092	1,092	1,144	1,162	1,434	1,656	1,516	1,767
	30 48	1	24H	TL24H3048RE	1,244	1,244	1,300	1,320	1,594	1,835	1,685	1,954
	30 60	2	18M	TL18M3060RE	1,755	1,755	1,819	1,843	2,135	2,411	2,238	2,547
	30 72	2	18M	TL18M3072RE	1,823	1,823	1,900	1,927	2,211	2,524	2,325	2,674
	30 84	2	18M	TL18M3084RE	2,055	2,055	2,121	2,166	2,306	2,794	2,429	2,977
	30 96	2	18M	TL18M3096RE	2,125	2,125	2,198	2,246	2,401	2,967	2,537	3,172

Continued on next page

How to Order

Table Model Number					Top Finish Selection		Options	
TL24H Base Series	4896 Top Size	RA Top Shape	WWSQ Top Material Edge Profile	MBK Base Finish	WMW Top Finish	WMW Edge Finish	GMBK Matte Black Grommet	C Location "C"

A TL24H4896RAWWSQMBK is a Tulip series 48" x 96" racetrack table with two black powder coat, heavy-weighted round bases and a wood veneer 1.25" thick top with a 1.25" square wood edge profile.

The codes: WMW WMW specify a medium walnut top, with a medium walnut edge.

The code: GMBK specifies a matte black 2" diameter metal grommet.

The code: C specifies the location of the grommet.

Specialty Tops

Butcher Block	Ultrafoam	Acrylic	Corian Group A,B	Corian Group C,D	3form Chroma
BBFL Flat	ULFP PVC	AAOP Opaque	C1FL Flat	C2FL Flat	3FFL Flat
BBBN Bullnose	ULFR Raw	AATL Translucent	C1BN Bullnose	C2BN Bullnose	3FBN Bullnose
			C1PR Prism	C2PR Prism	3FPR Prism

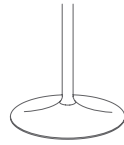

\$					
-	-	-	-	-	-
-	-	-	-	-	-
-	-	-	-	-	-
-	-	-	-	-	-
-	-	-	-	-	-
-	-	-	-	-	-
-	-	-	-	-	-
-	-	-	-	-	-
1,224	822	1,401	1,229	1,382	1,870
1,548	937	1,917	1,536	1,764	2,913
1,950	1,097	2,450	1,941	2,260	3,886
2,697	1,353	3,257	2,465	2,889	5,165
3,038	1,516	4,150	2,930	3,475	6,507
1,396	896	1,668	1,400	1,583	2,507
1,600	1,001	2,022	1,583	1,799	2,904
1,834	1,077	2,187	1,734	1,987	3,280
2,004	1,232	2,487	1,963	2,251	3,728
2,573	1,624	-	2,528	2,881	4,760
2,824	1,692	-	2,767	3,190	5,425
3,007	1,884	-	-	-	-
3,190	1,952	-	-	-	-
1,770	1,050	2,242	1,746	2,013	3,411
2,055	1,132	2,525	1,924	2,234	3,889
2,230	1,290	2,889	2,191	2,543	4,432
2,958	1,812	3,848	2,907	3,345	5,698
3,263	1,891	4,590	3,193	3,714	6,570
3,446	2,096	-	-	-	-
3,629	2,178	-	-	-	-

Options

Base Finishes

Standard Powder Coat	use finish code	n/c
Polished or Satin Chrome (per base)	use finish code	\$194
Premium Plated (per base)	use finish code	\$
Custom Powder Coat (set-up charge)	CPC	\$363

Base Options

Alternate Height Base (per column)	AH	\$66
Super Level Glides (per base)	GSL	\$34
Custom Top Plate Size	CTPS	\$

Top Materials and Finishes

Standard Laminates	use manufacturers finish code	n/c
Premium Laminates	PRL	\$
Custom Wood Veneer	CWV	\$
Special Pattern Veneer	SPV	\$
Stain to Match (set-up charge)	STM	\$412

Top Options

Custom Size	CS	\$
Custom Shape	CSH	\$
Custom Radius Corner	CRC	\$
3" Radius Corner (per corner)	CRL3	\$34
(laminates self edge, ultrafoam, Corian®, 3form chroma)		
3" Wood Radius Corner (per corner)	CRW3	\$82
(not available in LWFL, WWFL, LWPI and WWPI)		

Grommets

2" Round Metal Grommet - Matte Black	GMBK	\$138
2" Round Metal Grommet - Satin Chrome	GMSC	\$138
2" Round Metal Grommet - Polished Chrome	GMPC	\$138
2" Round Plastic Grommet - Matte Black	GPMBK	\$44
Grommet location	use location code	n/c

Edge Options

1.75" Thick Edge (per table)	175E	15%
------------------------------	------	-----

(see edge details for specific profiles)

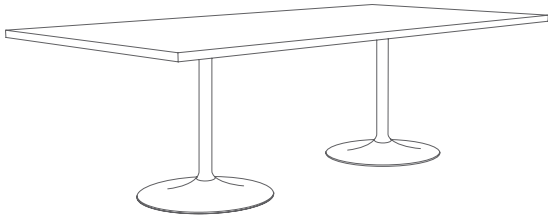

Laminate Tops

Wood Veneer Tops

Self Edge	Vinyl Edges	PVC Edges	Metal Edges	Wood Edges Group A	Wood Edges Group B	Wood Edges Group A	Wood Edges Group B
LLSE Self Edge	LVFL Flat	LPVC PVC	LMFL Flat	LWFL Flat	LWSQ Square	WWFL Flat	WWSQ Square
	LVBP Bumper		LMRB Ribbed	LWTP Tapered Ply	LWAR Arc	WWTP Tapered Ply	WWAR Arc
				LWFP Flat Ply	LWBN Bullnose	WWFP Flat Ply	WWBN Bullnose
					LWPR Prism		WWPR Prism
					LWPI Pivot		WWPI Pivot

Complete Table List Pricing

	Top Size	Base Qty.	Base Style	Model #	\$								
Rectangle	36 42	1	24M	TL24M3642RE	1,140	1,140	1,199	1,218	1,489	1,734	1,582	1,854	
	36 48	1	24H	TL24H3648RE	1,295	1,295	1,357	1,378	1,658	1,919	1,755	2,047	
	36 60	2	18H	TL18H3660RE	1,960	1,960	2,033	2,057	2,333	2,629	2,444	2,777	
	36 72	2	18H	TL18H3672RE	2,043	2,043	2,120	2,148	2,461	2,796	2,586	2,965	
	36 84	2	18H	TL18H3684RE	2,288	2,288	2,357	2,403	2,565	3,031	2,705	3,228	
	36 96	2	18H	TL18H3696RE	2,370	2,370	2,453	2,497	2,670	3,205	2,823	3,424	
	42 72	2	24M	TL24M4272RE	2,207	2,207	2,272	2,305	2,606	3,001	2,677	3,094	
	42 84	2	24M	TL24M4284RE	2,463	2,463	2,533	2,582	2,720	3,228	2,956	3,541	
	42 96	2	24M	TL24M4296RE	2,557	2,557	2,634	2,687	2,841	3,454	3,098	3,584	
	48 96	2	24H	TL24H4896RE	2,898	2,898	2,973	3,028	3,256	3,911	3,629	4,116	
	48 120	2	24H	TL24H48120RE	3,110	3,110	3,208	3,275	3,499	4,137	3,933	4,421	
	48 144	3	24H	TL24H48144RE	4,235	4,235	4,330	4,410	4,655	5,301	5,157	5,692	
48 168	3	24H	TL24H48168RE	4,463	4,463	4,563	4,655	4,886	5,583	5,447	6,018		
60 120	2	24XH	TL24XH60120RE	3,441	3,441	3,533	3,614	3,789	4,433	4,207	4,831		
60 144	3	24XH	TL24XH60144RE	4,636	4,636	4,739	4,836	5,103	5,688	5,692	6,214		
60 168	3	24XH	TL24XH60168RE	4,945	4,945	5,018	5,130	5,386	6,312	6,046	6,991		
Arc Rectangle	30 60	2	18M	TL18M3060AR	1,768	1,768	1,823	1,845	2,102	2,415	2,238	2,559	
	30 72	2	18M	TL18M3072AR	1,859	1,859	1,909	1,934	2,216	2,613	2,324	2,687	
	30 84	2	18M	TL18M3084AR	2,037	2,037	2,118	2,158	2,306	2,755	2,432	2,991	
	30 96	2	18M	TL18M3096AR	2,110	2,110	2,197	2,240	2,415	2,952	2,532	3,195	
	36 60	2	18H	TL18H3660AR	1,993	1,993	2,035	2,057	2,333	2,695	2,444	2,800	
	36 72	2	18H	TL18H3672AR	2,096	2,096	2,144	2,170	2,458	2,866	2,586	2,979	
	36 84	2	18H	TL18H3684AR	2,275	2,275	2,360	2,401	2,565	3,035	2,705	3,234	
	36 96	2	18H	TL18H3696AR	2,360	2,360	2,453	2,493	2,672	3,289	2,827	3,438	

Continued on next page

How to Order

Table Model Number					Top Finish Selection		Options	
TL24M Base Series	4272 Top Size	RE Top Shape	WWSQ Top Material Edge Profile	MBK Base Finish	WMW Top Finish	WMW Edge Finish	GMBK Matte Black Grommet	G Location "G" Grommet

A TL24M4272REWWSQMBK is a Tulip series 42" x 72" rectangle table with two black powder coat, medium-weighted round bases and a wood veneer 1.25" thick top with a 1.25" square wood edge profile.

The codes: WMW WMW specify a medium walnut top, with a medium walnut edge.

The code: GMBK specifies a matte black 2" diameter metal grommet.

The code: G specifies the location of the grommet.

Specialty Tops

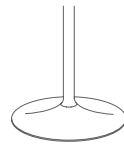
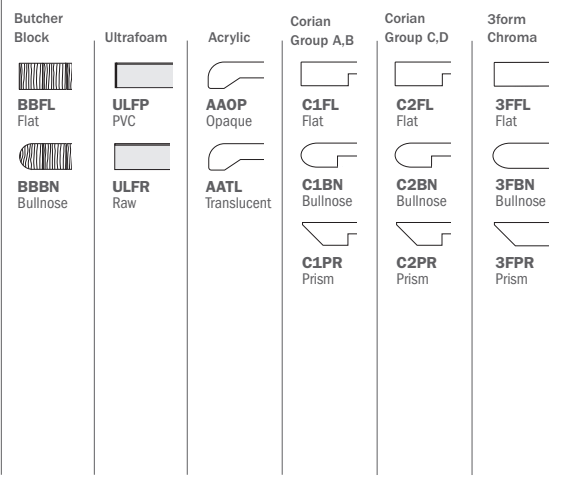

\$

2,269	1,187	-	2,304	2,481	4,486
2,450	1,351	3,292	2,747	2,831	5,107
3,366	2,026	4,730	3,339	3,858	6,718
3,718	2,121	5,313	3,666	4,284	7,704
4,068	2,341	6,529	-	-	-
4,413	2,438	6,865	-	-	-
-	2,294	-	-	-	-
-	2,526	-	-	-	-
-	2,637	7,692	-	-	-
-	2,988	-	-	-	-
-	-	-	-	-	-
-	-	-	-	-	-
-	-	-	-	-	-
-	-	-	-	-	-
-	-	-	-	-	-
-	-	-	-	-	-
-	-	-	-	-	-
-	-	-	-	-	-
-	-	-	-	-	-
-	-	-	-	-	-
-	-	-	-	-	-
-	-	-	-	-	-
-	-	-	-	-	-
-	-	-	-	-	-
-	-	-	-	-	-

Options

Base Finishes

Standard Powder Coat	use finish code	n/c
Polished or Satin Chrome (per base)	use finish code	\$194
Premium Plated (per base)	use finish code	🕒
Custom Powder Coat (set-up charge)	CPC	\$363

Base Options

Alternate Height Base (per column)	AH	\$66
Super Level Glides (per base)	GSL	\$34
Custom Top Plate Size	CTPS	🕒

Top Materials and Finishes

Standard Laminates	use manufacturers finish code	n/c
Premium Laminates	PRL	🕒
Custom Wood Veneer	CWV	🕒
Special Pattern Veneer	SPV	🕒
Stain to Match (set-up charge)	STM	\$412

Top Options

Custom Size	CS	🕒
Custom Shape	CSH	🕒
Custom Radius Corner	CRC	🕒
3" Radius Corner (per corner)	CRL3	\$34
(laminate self edge, ultrafoam, Corian®, 3form chroma)		
3" Wood Radius Corner (per corner)	CRW3	\$82
(not available in LWFL, WWFL, LWPI and WWPI)		

Grommets

2" Round Metal Grommet - Matte Black	GMBK	\$138
2" Round Metal Grommet - Satin Chrome	GMSC	\$138
2" Round Metal Grommet - Polished Chrome	GMPC	\$138
2" Round Plastic Grommet - Matte Black	GPMBK	\$44
Grommet location	use location code	n/c

Edge Options

1.75" Thick Edge (per table)	175E	15%
<i>(see edge details for specific profiles)</i>		

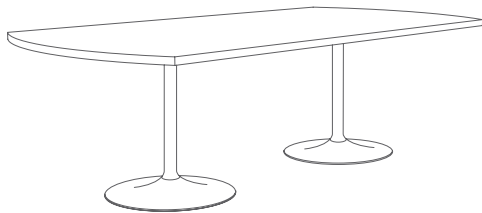

Laminate Tops

Wood Veneer Tops

Self Edge	Vinyl Edges	PVC Edges	Metal Edges	Wood Edges Group A	Wood Edges Group B	Wood Edges Group A	Wood Edges Group B
LLSE Self Edge	LVFL Flat	LPVC PVC	LMFL Flat	LWFL Flat	LWSQ Square	WWFL Flat	WWSQ Square
	LVBP Bumper		LMRB Ribbed	LWTP Tapered Ply	LWAR Arc	WWTP Tapered Ply	WWAR Arc
				LWFP Flat Ply	LWBN Bullnose	WWFP Flat Ply	WWBN Bullnose
					LWPR Prism		WWPR Prism
					LWPI Pivot		WWPI Pivot

Complete Table List Pricing

	Top Size	Base Qty.	Base Style	Model #	\$								
Arc Rectangle 	42	72	2	24M	TL24M4272AR	2,322	2,322	2,344	2,380	2,606	3,052	2,677	3,341
	42	84	2	24M	TL24M4284AR	2,450	2,450	2,533	2,577	2,693	3,314	2,956	3,602
	42	96	2	24M	TL24M4296AR	2,547	2,547	2,634	2,682	2,833	3,512	3,098	3,851
	48	96	2	24H	TL24H4896AR	2,920	2,920	2,974	3,024	3,256	3,968	3,629	4,195
	48	120	2	24H	TL24H48120AR	3,094	3,094	3,213	3,275	3,499	4,308	3,933	4,590
	48	144	3	24H	TL24H48144AR	4,214	4,214	4,336	4,410	4,696	5,556	5,208	5,982
	48	168	3	24H	TL24H48168AR	4,436	4,436	4,563	4,647	4,941	6,036	5,517	6,385
	60	120	2	24XH	TL24XH60120AR	3,427	3,427	3,572	3,649	3,812	4,688	4,232	5,034
	60	144	3	24XH	TL24XH60144AR	4,628	4,628	4,772	4,863	5,182	6,028	5,486	6,699
	60	168	3	24XH	TL24XH60168AR	4,904	4,904	5,050	5,155	5,470	6,425	5,809	7,089

How to Order

Table Model Number

Top Finish Selection

Options

TL24M Base Series **4272** Top Size **AR** Top Shape **WWSQ** Top Material Edge Profile **MBK** Base Finish

A TL24M4272ARWWSQMBK is a Tulip series 42" x 72" arc rectangle table with two black powder coat, medium-weighted round bases and a wood veneer 1.25" thick top with a 1.25" square wood edge profile.

WMW Top Finish **WMW** Edge Finish

The codes: WMW WMW specify a medium walnut top, with a medium walnut edge.

GMBK Matte Black Grommet

The code: GMBK specifies a matte black 2" diameter metal grommet.

G Location "G"

The code: G specifies the location of the grommet.

Specialty Tops

Butcher Block	Ultrafoam	Acrylic	Corian Group A,B	Corian Group C,D	3form Chroma
BBFL Flat	ULFP PVC	AAOP Opaque	C1FL Flat	C2FL Flat	3FFL Flat
BBBN Bullnose	ULFR Raw	AATL Translucent	C1BN Bullnose	C2BN Bullnose	3FBN Bullnose
			C1PR Prism	C2PR Prism	3FPR Prism

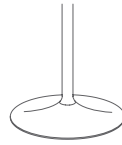

\$					
-	-	-	-	-	-
-	-	-	-	-	-
-	-	-	-	-	-
-	-	-	-	-	-
-	-	-	-	-	-
-	-	-	-	-	-
-	-	-	-	-	-
-	-	-	-	-	-

Options

Base Finishes		
Standard Powder Coat	use finish code	n/c
Polished or Satin Chrome (per base)	use finish code	\$194
Premium Plated (per base)	use finish code	🕒
Custom Powder Coat (set-up charge)	CPC	\$363

Base Options		
Alternate Height Base (per column)	AH	\$66
Super Level Glides (per base)	GSL	\$34
Custom Top Plate Size	CTPS	🕒

Top Materials and Finishes		
Standard Laminates	use manufacturers finish code	n/c
Premium Laminates	PRL	🕒
Custom Wood Veneer	CWV	🕒
Special Pattern Veneer	SPV	🕒
Stain to Match (set-up charge)	STM	\$412

Top Options		
Custom Size	CS	🕒
Custom Shape	CSH	🕒
Custom Radius Corner	CRC	🕒
3" Radius Corner (per corner)	CRL3	\$34
(laminates self edge, ultrafoam, Corian®, 3form chroma)		
3" Wood Radius Corner (per corner)	CRW3	\$82
(not available in LWFL, WWFL, LWPI and WWPI)		

Grommets		
2" Round Metal Grommet - Matte Black	GMBK	\$138
2" Round Metal Grommet - Satin Chrome	GMSC	\$138
2" Round Metal Grommet - Polished Chrome	GMPC	\$138
2" Round Plastic Grommet - Matte Black	GPMBK	\$44
Grommet location	use location code	n/c

Edge Options		
1.75" Thick Edge (per table)	175E	15%
<i>(see edge details for specific profiles)</i>		



Laminate Tops

Wood Veneer Tops

Self Edge	Vinyl Edges	PVC Edges	Metal Edges	Wood Edges Group A	Wood Edges Group B	Wood Edges Group A	Wood Edges Group B
LLSE Self Edge	LVFL Flat	LPVC PVC	LMFL Flat	LWFL Flat	LWSQ Square	WWFL Flat	WWSQ Square
	LVBP Bumper		LMRB Ribbed	LWTP Tapered Ply	LWAR Arc	WWTP Tapered Ply	WWAR Arc
				LWFP Flat Ply	LWBN Bullnose	WWFP Flat Ply	WWBN Bullnose
					LWPR Prism		WWPR Prism
					LWPI Pivot		WWPI Pivot

Complete Table List Pricing

	Top Size	Base Qty.	Base Style	Model #	\$								
Round	24	1	X	TUX24RD	514	514	564	612	722	891	732	963	
	30	1	X	TUX30RD	629	629	691	724	890	1,071	890	1,158	
	36	1	X	TUX36RD	779	779	851	897	1,086	1,296	1,112	1,401	
	42	1	X	TUX42RD	880	880	960	960	1,202	1,460	1,296	1,586	
	48	1	X	TUX48RD	1,053	1,053	1,144	1,171	1,411	1,707	1,522	1,856	
	54	1	X	TUX54RD	1,164	1,164	1,269	1,298	1,627	2,238	1,765	2,452	
	60	1	X	TUX60RD	1,341	1,341	1,454	1,508	1,747	2,321	2,106	2,547	
Oval	36	72	2	T	TUT3672OV	889	889	940	965	1,148	1,370	1,321	1,537
	42	54	2	T	TUT4254OV	866	866	893	957	1,098	1,425	1,249	1,485
	42	78	2	T	TUT4278OV	1,158	1,158	1,199	1,244	1,392	1,613	1,535	1,782
	42	84	2	T	TUT4284OV	1,214	1,214	1,268	1,312	1,442	1,693	1,588	1,872
	48	78	2	TT	TUTT4878OV	1,309	1,309	1,366	1,412	1,535	1,784	1,687	1,967
	48	96	2	TT	TUTT4896OV	1,485	1,485	1,541	1,591	1,683	1,955	2,045	2,362
Racetrack	30	60	2	T	TUT3060RA	692	692	750	772	1,062	1,340	1,163	1,508
	30	72	2	T	TUT3072RA	760	760	832	857	1,136	1,480	1,249	1,612
	30	84	2	T	TUT3084RA	990	990	1,054	1,095	1,233	1,719	1,359	1,916
	30	96	2	T	TUT3096RA	1,060	1,060	1,132	1,176	1,327	1,933	1,457	2,120
	36	60	2	T	TUT3660RA	788	788	856	878	1,148	1,455	1,259	1,615
	36	72	2	T	TUT3672RA	868	868	947	972	1,280	1,623	1,407	1,794
	36	84	2	T	TUT3684RA	1,105	1,105	1,184	1,226	1,380	1,850	1,524	2,074
	36	96	2	TT	TUTT3696RA	1,245	1,245	1,338	1,379	1,547	2,136	1,702	2,313
	42	72	2	TT	TUTT4272RA	1,012	1,012	1,086	1,117	1,401	1,796	1,472	2,080
	42	84	2	TT	TUTT4284RA	1,266	1,266	1,333	1,377	1,500	2,051	1,646	2,371
	42	96	2	TT	TUTT4296RA	1,362	1,362	1,431	1,480	1,623	2,249	1,786	2,646

Continued on next page

How to Order















Table Model Number					Top Finish Selection		Options
TUX Base Series	36 Top Size	RD Top Shape	WWSQ Top Material Edge Profile	MBK Base Finish	WMW Top Finish	WMW Edge Finish	AH Alternate Height Base

A TUX36RDWWSQMBK is a Tuscan series 36" round table with a black powder coat X-base and a wood veneer 1.25" thick top with a 1.25" square wood edge profile.

The codes: WMW WMW specify a medium walnut top, with a medium walnut edge.

AH
Alternate Height Base

Specialty Tops

Butcher Block	Ultrafoam	Acrylic	Corian Group A,B	Corian Group C,D	3form Chroma
 BBFL Flat	 ULFP PVC	 AAOP Opaque	 C1FL Flat	 C2FL Flat	 3FFL Flat
 BBBN Bullnose	 ULFR Raw	 AATL Translucent	 C1BN Bullnose	 C2BN Bullnose	 3FBN Bullnose
			 C1PR Prism	 C2PR Prism	 3FPR Prism

\$					
879	533	1,124	1,039	1,216	1,628
1,180	662	1,637	1,366	1,630	2,683
1,557	822	2,168	1,784	2,142	3,663
2,082	934	2,819	2,175	2,652	4,799
2,427	1,119	3,745	2,689	3,292	6,173
-	1,249	4,848	3,173	3,921	-
-	1,395	6,062	3,724	4,636	-
-	-	-	-	-	-
-	-	3,702	-	-	-
-	-	5,089	-	-	-
-	-	-	-	-	-
-	-	5,927	-	-	-
-	-	-	-	-	-
-	-	-	-	-	-
-	-	-	-	-	-
-	-	-	-	-	-
-	-	-	-	-	-
-	-	-	-	-	-
-	-	-	-	-	-
-	-	-	-	-	-
-	-	-	-	-	-
-	-	-	-	-	-
-	-	-	-	-	-
-	-	-	-	-	-

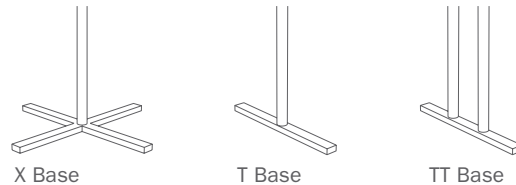

Options

Base Finishes			
Standard Powder Coat		use finish code	n/c
Polished or Satin Chrome (per base)		use finish code	\$114
Premium Plated (per base)		use finish code	Ⓛ
Custom Powder Coat (set-up charge)		CPC	\$363

Base Options			
Alternate Height Base (per column)		AH	\$66
Super Level Glides (per base)		GSL	\$34
Locking Casters 2" Twin Wheel (qty. 4)		TWC2	\$56
Tilt-top - (standard cable release)		TMX/TMT	\$270 X-base/ \$418 T-base
Folding		FM	\$270 T-base

Top Materials and Finishes			
Standard Laminates		use manufacturers finish code	n/c
Premium Laminates		PRL	Ⓛ
Custom Wood Veneer		CWW	Ⓛ
Special Pattern Veneer		SPV	Ⓛ
Stain to Match (set-up charge)		STM	\$412

Top Options			
Custom Size		CS	Ⓛ
Custom Shape		CSH	Ⓛ
Custom Radius Corner		CRC	Ⓛ
3" Radius Corner (per corner)		CRL3	\$34
(laminate self edge, ultrafoam, Corian®, 3form chroma)			
3" Wood Radius Corner (per corner)		CRW3	\$82
(not available in LWFL, WWFL, LWPI and WWPI)			
Ganging Clips (1 set includes 2 male and 2 female clips)		GC	\$148

Grommets			
2" Round Metal Grommet - Matte Black		GMBK	\$138
2" Round Metal Grommet - Satin Chrome		GMSC	\$138
2" Round Metal Grommet - Polished Chrome		GMPC	\$138
2" Round Plastic Grommet - Matte Black		GPMBK	\$44
Grommet location		use location code	n/c

Edge Options			
1.75" Thick Edge (per table)		175E	15%
(see edge details for specific profiles)			

Modesty Panels			
Fixed Modesty Panel Laminate (48,60,72)		MODLFX	\$248
Fixed Modesty Panel Veneer (48,60,72)		MODVFX	\$386
Folding Modesty Panel Laminate (48,60,72)		MODLFL	\$330
Folding Modesty Veneer (48,60,72)		MODVFL	\$468

Wire Management			
J-Trough (horizontal mount) - Matte Black		WMJ	\$116
Legway Wire Manager (vertical mount) - Matte Black		WML	\$56

Data and Power			
Recessed Power and Data Module Two		DPBS2	\$396
Recessed Power and Data Module Four		DPBS4	\$688
Retractable Power and Data Module Two		DPAS2	\$606
Retractable Power and Data Module Three		DPAS3	\$688
Under Top Mounted Power and Data Module Two		DPUS2	\$358

Other			
Table Truck for Folding Tables		TTRK	\$1512

Laminate Tops

Wood Veneer Tops

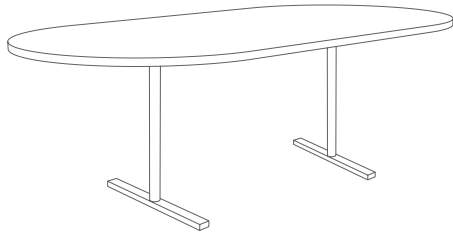

Self Edge	Vinyl Edges	PVC Edges	Metal Edges	Wood Edges Group A	Wood Edges Group B	Wood Edges Group A	Wood Edges Group B
LLSE Self Edge	LVFL Flat LVBP Bumper	LPVC PVC	LMFL Flat LMRB Ribbed	LWFL Flat LWTP Tapered Ply LWFP Flat Ply	LWSQ Square LWAR Arc LWBN Bullnose LWPR Prism LWPI Pivot	WWFL Flat WWTP Tapered Ply WWFP Flat Ply	WWSQ Square WWAR Arc WWBN Bullnose WWPR Prism WWPI Pivot

Complete Table List Pricing

	Top Size	Base Qty.	Base Style	Model #	\$								
	48 96	2	TT	TUTT4896RA	1,500	1,500	1,580	1,630	1,860	2,511	2,229	2,737	
	48 120	2	TT	TUTT48120RA	1,712	1,712	1,813	1,875	2,103	2,850	2,533	3,190	
	48 144	3	TT	TUTT48144RA	2,155	2,155	2,270	2,347	2,588	3,398	3,100	3,823	
	48 168	3	TT	TUTT48168RA	2,370	2,370	2,493	2,580	2,839	3,767	3,415	4,249	
	60 120	2	TT	TUTT60120RA	1,984	1,984	2,093	2,169	2,284	3,190	2,733	3,587	
	60 144	3	TT	TUTT60144RA	2,479	2,479	2,580	2,672	2,927	3,767	3,259	4,236	
	60 168	3	TT	TUTT60168RA	2,744	2,744	2,855	2,960	3,221	4,162	3,893	5,012	
	24 24	1	X	TUX2424SQ	514	514	570	624	722	891	732	963	
	30 30	1	X	TUX3030SQ	629	629	697	744	890	1,071	890	1,158	
	36 36	1	X	TUX3636SQ	779	779	847	916	1,076	1,296	1,112	1,401	
	42 42	1	X	TUX4242SQ	938	938	1,014	1,063	1,272	1,530	1,366	1,656	
	48 48	1	X	TUX4848SQ	1,055	1,055	1,144	1,203	1,411	1,707	1,522	1,856	
	18 48	2	T	TUT1848RE	461	461	512	527	630	879	696	907	
	18 60	2	T	TUT1860RE	511	511	571	589	710	992	774	1,050	
	18 72	2	T	TUT1872RE	558	558	624	645	794	1,106	862	1,192	
	18 84	2	T	TUT1884RE	710	710	762	794	939	1,247	1,033	1,377	
	18 96	2	T	TUT1896RE	794	794	841	879	996	1,360	1,095	1,482	
	24 30	1	X	TUX2430RE	598	598	645	657	838	1,024	919	1,104	
	24 36	1	X	TUX2436RE	697	697	749	763	971	1,152	1,037	1,240	
	24 42	1	X	TUX2442RE	730	730	775	790	1,012	1,211	1,082	1,306	
	24 48	1	X	TUX2448RE	765	765	821	839	1,084	1,306	1,164	1,411	
	24 60	2	T	TUT2460RE	577	577	637	658	918	1,171	1,007	1,291	
	24 72	2	T	TUT2472RE	635	635	705	729	1,015	1,305	1,118	1,443	
	24 84	2	T	TUT2484RE	852	852	917	957	1,097	1,585	1,210	1,760	
	24 96	2	T	TUT2496RE	910	910	981	1,025	1,179	1,706	1,301	1,896	

Continued on next page

How to Order

Table Model Number					Top Finish Selection		Options	
TUT Base Series	3660 Top Size	RA Top Shape	WWSQ Top Material Edge Profile	MBK Base Finish	WMW Top Finish	WMW Edge Finish	GMBK Matte Black Grommet	E Location "E"

A TUT3660RAWWSQMBK is a Tuscan series 36" x 60" racetrack table with two black powder coat T-bases and a wood veneer 1.25" thick top with a 1.25" square wood edge profile.

The codes: WMW WMW specify a medium walnut top, with a medium walnut edge.

The code: GMBK specifies a matte black 2" diameter metal grommet.

The code: E specifies the location of the grommet.

Specialty Tops

Butcher Block	Ultrafoam	Acrylic	Corian Group A,B	Corian Group C,D	3form Chroma
BBFL Flat	ULFP PVC	AAOP Opaque	C1FL Flat	C2FL Flat	3FFL Flat
BBBN Bullnose	ULFR Raw	AATL Translucent	C1BN Bullnose	C2BN Bullnose	3FBN Bullnose
			C1PR Prism	C2PR Prism	3FPR Prism

\$					
-	-	-	-	-	-
-	-	-	-	-	-
-	-	-	-	-	-
-	-	-	-	-	-
-	-	-	-	-	-
-	-	-	-	-	-
-	-	-	-	-	-
-	-	-	-	-	-
-	-	-	-	-	-
-	-	-	-	-	-
949	547	1,126	954	1,107	1,595
1,273	662	1,642	1,261	1,489	2,638
1,675	822	2,175	1,666	1,985	3,611
2,337	993	2,897	2,105	2,529	4,805
2,643	1,121	3,755	2,535	3,080	6,112
992	490	-	-	-	-
1,060	550	-	-	-	-
1,173	603	-	-	-	-
1,332	781	-	-	-	-
1,445	836	-	-	-	-
1,121	621	1,393	1,125	1,308	2,232
1,325	726	1,747	1,308	1,524	2,629
1,519	762	1,872	1,419	1,672	2,965
1,574	802	2,057	1,533	1,821	3,298
1,573	624	-	1,528	1,881	3,760
1,824	692	-	1,767	2,190	4,425
2,007	884	-	-	-	-
2,190	952	-	-	-	-

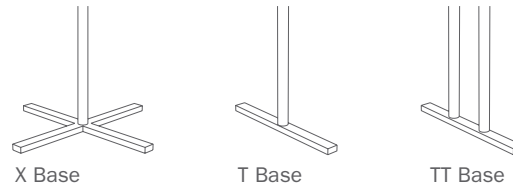

Options

Base Finishes		
Standard Powder Coat	use finish code	n/c
Polished or Satin Chrome (per base)	use finish code	\$114
Premium Plated (per base)	use finish code	Ⓒ
Custom Powder Coat (set-up charge)	CPC	\$363

Base Options		
Alternate Height Base (per column)	AH	\$66
Super Level Glides (per base)	GSL	\$34
Locking Casters 2" Twin Wheel (qty. 4)	TWC2	\$56
Tilt-top - (standard cable release)	TMX/TMT	\$270 X-base/ \$418 T-base
Folding	FM	\$270 T-base

Top Materials and Finishes		
Standard Laminates	use manufacturers finish code	n/c
Premium Laminates	PRL	Ⓒ
Custom Wood Veneer	CWV	Ⓒ
Special Pattern Veneer	SPV	Ⓒ
Stain to Match (set-up charge)	STM	\$412

Top Options		
Custom Size	CS	Ⓒ
Custom Shape	CSH	Ⓒ
Custom Radius Corner	CRC	Ⓒ
3" Radius Corner (per corner)	CRL3	\$34
(laminates self edge, ultrafoam, Corian®, 3form chroma)		
3" Wood Radius Corner (per corner)	CRW3	\$82
(not available in LWFL, WWFL, LWPI and WWPI)		
Ganging Clips (1 set includes 2 male and 2 female clips)	GC	\$148

Grommets		
2" Round Metal Grommet - Matte Black	GMBK	\$138
2" Round Metal Grommet - Satin Chrome	GMSC	\$138
2" Round Metal Grommet - Polished Chrome	GMPC	\$138
2" Round Plastic Grommet - Matte Black	GPMBK	\$44
Grommet location	use location code	n/c

Edge Options		
1.75" Thick Edge (per table)	175E	15%
(see edge details for specific profiles)		

Modesty Panels		
Fixed Modesty Panel Laminate (48,60,72)	MODLFX	\$248
Fixed Modesty Panel Veneer (48,60,72)	MODVFX	\$386
Folding Modesty Panel Laminate (48,60,72)	MODLFL	\$330
Folding Modesty Veneer (48,60,72)	MODVFL	\$468

Wire Management		
J-Trough (horizontal mount) - Matte Black	WMJ	\$116
Legway Wire Manager (vertical mount) - Matte Black	WML	\$56

Data and Power		
Recessed Power and Data Module Two	DPBS2	\$396
Recessed Power and Data Module Four	DPBS4	\$688
Retractable Power and Data Module Two	DPAS2	\$606
Retractable Power and Data Module Three	DPAS3	\$688
Under Top Mounted Power and Data Module Two	DPUS2	\$358

Other		
Table Truck for Folding Tables	TTRK	\$1512

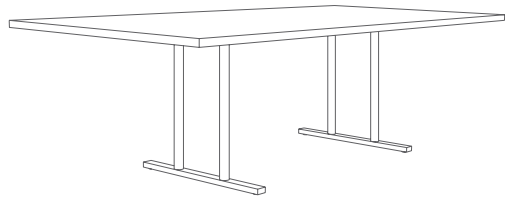

Laminate Tops

Wood Veneer Tops

Self Edge	Vinyl Edges	PVC Edges	Metal Edges	Wood Edges Group A	Wood Edges Group B	Wood Edges Group A	Wood Edges Group B
LLSE Self Edge	LVFL Flat	LPVC PVC	LMFL Flat	LWFL Flat	LWSQ Square	WWFL Flat	WWSQ Square
	LVBP Bumper		LMRB Ribbed	LWTP Tapered Ply	LWAR Arc	WWTP Tapered Ply	WWAR Arc
				LWFP Flat Ply	LWBN Bullnose	WWFP Flat Ply	WWBN Bullnose
					LWPR Prism		WWPR Prism
					LWPI Pivot		WWPI Pivot

Complete Table List Pricing

Top Size	Base Qty.	Base Style	Model #	\$									
Rectangle	30	36	1	X	TUX3036RE	742	742	787	802	1,024	1,222	1,096	1,318
	30	42	1	X	TUX3042RE	777	777	829	847	1,119	1,341	1,201	1,452
	30	48	1	X	TUX3048RE	884	884	940	960	1,234	1,475	1,325	1,594
	30	60	2	T	TUT3060RE	680	680	744	768	1,060	1,336	1,163	1,472
	30	72	2	T	TUT3072RE	748	748	825	852	1,136	1,449	1,250	1,599
	30	84	2	T	TUT3084RE	980	980	1,046	1,091	1,231	1,719	1,354	1,902
	30	96	2	T	TUT3096RE	1,050	1,050	1,123	1,171	1,326	1,892	1,462	2,097
	36	42	2	T	TUT3642RE	640	640	699	718	989	1,234	1,082	1,354
	36	48	2	T	TUT3648RE	680	680	742	763	1,043	1,304	1,140	1,432
	36	60	2	T	TUT3660RE	775	775	848	872	1,148	1,444	1,259	1,592
	36	72	2	T	TUT3672RE	858	858	935	963	1,276	1,611	1,401	1,780
	36	84	2	T	TUT3684RE	1,103	1,103	1,172	1,218	1,380	1,846	1,520	2,043
	36	96	2	TT	TUTT3696RE	1,245	1,245	1,328	1,372	1,545	2,080	1,698	2,299
	42	72	2	TT	TUTT4272RE	1,002	1,002	1,067	1,100	1,401	1,796	1,472	1,889
	42	84	2	TT	TUTT4284RE	1,258	1,258	1,328	1,377	1,515	2,023	1,751	2,336
	42	96	2	TT	TUTT4296RE	1,352	1,352	1,429	1,482	1,636	2,249	1,893	2,379
	48	96	2	TT	TUTT4896RE	1,498	1,498	1,573	1,628	1,856	2,511	2,229	2,716
	48	120	2	TT	TUTT48120RE	1,710	1,710	1,808	1,875	2,099	2,737	2,533	3,021
	48	144	3	TT	TUTT48144RE	2,135	2,135	2,230	2,310	2,555	3,201	3,057	3,592
	48	168	3	TT	TUTT48168RE	2,363	2,363	2,463	2,555	2,786	3,483	3,347	3,918
	60	120	2	TT	TUTT60120RE	1,971	1,971	2,063	2,144	2,319	2,963	2,737	3,361
	60	144	3	TT	TUTT60144RE	2,431	2,431	2,534	2,631	2,898	3,483	3,487	4,009
	60	168	3	TT	TUTT60168RE	2,740	2,740	2,813	2,925	3,181	4,107	3,841	4,786

Continued on next page

*T-bases can be specified on 30" x 42" and 30" x 48" rectangle tables, please refer to Base Only Pricing (p.231) and Top Only Pricing (p.241).
X-bases are recommended for dining applications.

How to Order

Table Model Number					Top Finish Selection		Options	
TUTT Base Series	4896 Top Size	RE Top Shape	WWSQ Top Material Edge Profile	MBK Base Finish	WMW Top Finish	WMW Edge Finish	GMBK Matte Black Grommet	E Location "E"
A TUTT4896REWWSQMBK is a Tuscan series 48" x 96" rectangle table with two black powder coat TT-bases and a wood veneer 1.25" thick top with a 1.25" square wood edge profile.					The codes: WMW WMW specify a medium walnut top, with a medium walnut edge.		The code: GMBK specifies a matte black 2" diameter metal grommet.	
							The code: E specifies the location of the grommet.	

Specialty Tops

Butcher Block	Ultrafoam	Acrylic	Corian Group A,B	Corian Group C,D	3form Chroma
BBFL Flat	ULFP PVC	AAOP Opaque	C1FL Flat	C2FL Flat	3FFL Flat
BBBN Bullnose	ULFR Raw	AATL Translucent	C1BN Bullnose	C2BN Bullnose	3FBN Bullnose
			C1PR Prism	C2PR Prism	3FPR Prism

\$					
1,495	775	1,967	1,471	1,738	3,136
1,740	817	2,210	1,609	1,919	3,574
1,870	930	2,529	1,831	2,183	4,072
1,883	737	2,773	1,832	2,270	4,623
2,188	816	3,515	2,118	2,639	5,495
2,371	1,021	-	-	-	-
2,554	1,103	-	-	-	-
1,769	687	-	1,804	1,981	3,986
1,835	736	2,677	2,132	2,216	4,492
2,181	841	3,545	2,154	2,673	5,533
2,533	936	4,128	2,481	3,099	6,519
2,883	1,156	5,344	-	-	-
3,288	1,313	5,740	-	-	-
-	1,089	-	-	-	-
-	1,321	-	-	-	-
-	1,432	6,487	-	-	-
-	1,588	-	-	-	-
-	-	-	-	-	-
-	-	-	-	-	-
-	-	-	-	-	-
-	-	-	-	-	-
-	-	-	-	-	-
-	-	-	-	-	-
-	-	-	-	-	-
-	-	-	-	-	-

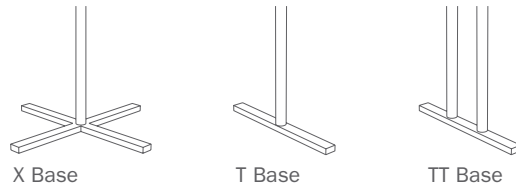

Options

Base Finishes		
Standard Powder Coat	use finish code	n/c
Polished or Satin Chrome (per base)	use finish code	\$114
Premium Plated (per base)	use finish code	Ⓛ
Custom Powder Coat (set-up charge)	CPC	\$363

Base Options		
Alternate Height Base (per column)	AH	\$66
Super Level Glides (per base)	GSL	\$34
Locking Casters 2" Twin Wheel (qty. 4)	TWC2	\$56
Tilt-top - (standard cable release)	TMX/TMT	\$270 X-base/ \$418 T-base
Folding	FM	\$270 T-base

Top Materials and Finishes		
Standard Laminates	use manufacturers finish code	n/c
Premium Laminates	PRL	Ⓛ
Custom Wood Veneer	CWV	Ⓛ
Special Pattern Veneer	SPV	Ⓛ
Stain to Match (set-up charge)	STM	\$412

Top Options		
Custom Size	CS	Ⓛ
Custom Shape	CSH	Ⓛ
Custom Radius Corner	CRC	Ⓛ
3" Radius Corner (per corner)	CRL3	\$34
(laminate self edge, ultrafoam, Corian®, 3form chroma)		
3" Wood Radius Corner (per corner)	CRW3	\$82
(not available in LWFL, WWFL, LWPI and WWPI)		
Ganging Clips (1 set includes 2 male and 2 female clips)	GC	\$148

Grommets		
2" Round Metal Grommet - Matte Black	GMBK	\$138
2" Round Metal Grommet - Satin Chrome	GMSC	\$138
2" Round Metal Grommet - Polished Chrome	GMPC	\$138
2" Round Plastic Grommet - Matte Black	GPMBK	\$44
Grommet location	use location code	n/c

Edge Options		
1.75" Thick Edge (per table)	175E	15%
(see edge details for specific profiles)		

Modesty Panels		
Fixed Modesty Panel Laminate (48,60,72)	MODLFX	\$248
Fixed Modesty Panel Veneer (48,60,72)	MODVFX	\$386
Folding Modesty Panel Laminate (48,60,72)	MODLFL	\$330
Folding Modesty Veneer (48,60,72)	MODVFL	\$468

Wire Management		
J-Trough (horizontal mount) - Matte Black	WMJ	\$116
Legway Wire Manager (vertical mount) - Matte Black	WML	\$56

Data and Power		
Recessed Power and Data Module Two	DPBS2	\$396
Recessed Power and Data Module Four	DPBS4	\$688
Retractable Power and Data Module Two	DPAS2	\$606
Retractable Power and Data Module Three	DPAS3	\$688
Under Top Mounted Power and Data Module Two	DPUS2	\$358

Other		
Table Truck for Folding Tables	TTRK	\$1512

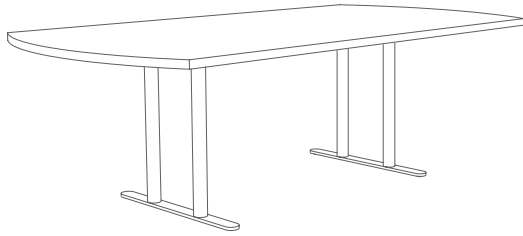

Laminate Tops

Wood Veneer Tops

Self Edge	Vinyl Edges	PVC Edges	Metal Edges	Wood Edges Group A	Wood Edges Group B	Wood Edges Group A	Wood Edges Group B
LLSE Self Edge	LVFL Flat	LPVC PVC	LMFL Flat	LWFL Flat	LWSQ Square	WWFL Flat	WWSQ Square
	LVBP Bumper		LMRB Ribbed	LWTP Tapered Ply	LWAR Arc	WWTP Tapered Ply	WWAR Arc
				LWFP Flat Ply	LWBN Bullnose	WWFP Flat Ply	WWBN Bullnose
					LWPR Prism		WWPR Prism
					LWPI Pivot		WWPI Pivot

Complete Table List Pricing

	Top Size	Base Qty.	Base Style	Model #	\$								
Half Round 	24 48	2	T	TUT2448HR	523	523	573	589	713	966	776	1,013	
	30 60	2	T	TUT3060HR	693	693	761	784	902	1,198	986	1,332	
	36 72	2	T	TUT3672HR	874	874	955	981	1,098	1,455	1,306	1,568	
Arc Rectangle 	30 60	2	T	TUT3060AR	693	693	748	770	1,027	1,340	1,163	1,484	
	30 72	2	T	TUT3072AR	784	784	834	859	1,141	1,538	1,249	1,612	
	30 84	2	T	TUT3084AR	962	962	1,043	1,083	1,231	1,680	1,357	1,916	
	30 96	2	T	TUT3096AR	1,035	1,035	1,122	1,165	1,340	1,877	1,457	2,120	
	36 60	2	T	TUT3660AR	808	808	850	872	1,148	1,510	1,259	1,615	
	36 72	2	T	TUT3672AR	911	911	959	985	1,273	1,681	1,401	1,794	
	36 84	2	T	TUT3684AR	1,090	1,090	1,175	1,216	1,380	1,850	1,520	2,049	
	36 96	2	TT	TUTT3696AR	1,235	1,235	1,328	1,368	1,547	2,164	1,702	2,313	
	42 72	2	TT	TUTT4272AR	1,117	1,117	1,139	1,175	1,401	1,847	1,472	2,136	
	42 84	2	TT	TUTT4284AR	1,245	1,245	1,328	1,372	1,488	2,109	1,751	2,397	
	42 96	2	TT	TUTT4296AR	1,342	1,342	1,429	1,477	1,628	2,307	1,893	2,646	
	48 96	2	TT	TUTT4896AR	1,520	1,520	1,574	1,624	1,856	2,568	2,229	2,795	
	48 120	2	TT	TUTT48120AR	1,694	1,694	1,813	1,875	2,099	2,908	2,533	3,190	
	48 144	3	TT	TUTT48144AR	2,114	2,114	2,236	2,310	2,596	3,456	3,108	3,882	
	48 168	3	TT	TUTT48168AR	2,336	2,336	2,463	2,547	2,841	3,936	3,417	4,285	

Continued on next page

How to Order

Table Model Number					Top Finish Selection		Options	
TUTT Base Series	4896 Top Size	AR Top Shape	WWSQ Top Material Edge Profile	MBK Base Finish	WMW Top Finish	WMW Edge Finish	GMBK Matte Black Grommet	C Location "C"
A TUTT4896ARWWSQMBK is a Tuscan series 48" x 96" arc rectangle table with two black powder coat TT-bases and a wood veneer 1.25" thick top with a 1.25" square wood edge profile.					The codes: WMW WMW specify a medium walnut top, with a medium walnut edge.		The code: GMBK specifies a matte black 2" diameter metal grommet.	
							The code: C specifies the location of the grommet.	

Specialty Tops

Butcher Block	Ultrafoam	Acrylic	Corian Group A,B	Corian Group C,D	3form Chroma
BBFL Flat	ULFP PVC	AAOP Opaque	C1FL Flat	C2FL Flat	3FFL Flat
BBBN Bullnose	ULFR Raw	AATL Translucent	C1BN Bullnose	C2BN Bullnose	3FBN Bullnose
			C1PR Prism	C2PR Prism	3FPR Prism

\$					
-	-	-	-	-	-
-	-	-	-	-	-
-	-	-	-	-	-

-	-	-	-	-	-
-	-	-	-	-	-
-	-	-	-	-	-
-	-	-	-	-	-
-	-	-	-	-	-
-	-	-	-	-	-
-	-	-	-	-	-
-	-	-	-	-	-
-	-	-	-	-	-
-	-	-	-	-	-
-	-	-	-	-	-
-	-	-	-	-	-
-	-	-	-	-	-
-	-	-	-	-	-
-	-	-	-	-	-
-	-	-	-	-	-
-	-	-	-	-	-
-	-	-	-	-	-
-	-	-	-	-	-
-	-	-	-	-	-
-	-	-	-	-	-
-	-	-	-	-	-
-	-	-	-	-	-
-	-	-	-	-	-
-	-	-	-	-	-

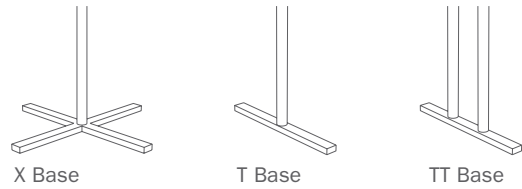

Options

Base Finishes		
Standard Powder Coat	use finish code	n/c
Polished or Satin Chrome (per base)	use finish code	\$114
Premium Plated (per base)	use finish code	Ⓛ
Custom Powder Coat (set-up charge)	CPC	\$363

Base Options		
Alternate Height Base (per column)	AH	\$66
Super Level Glides (per base)	GSL	\$34
Locking Casters 2" Twin Wheel (qty. 4)	TWC2	\$56
Tilt-top - (standard cable release)	TMX/TMT	\$270 X-base/ \$418 T-base
Folding	FM	\$270 T-base

Top Materials and Finishes		
Standard Laminates	use manufacturers finish code	n/c
Premium Laminates	PRL	Ⓛ
Custom Wood Veneer	CWV	Ⓛ
Special Pattern Veneer	SPV	Ⓛ
Stain to Match (set-up charge)	STM	\$412

Top Options		
Custom Size	CS	Ⓛ
Custom Shape	CSH	Ⓛ
Custom Radius Corner	CRC	Ⓛ
3" Radius Corner (per corner) (laminate self edge, ultrafoam, Corian®, 3form chroma)	CRL3	\$34
3" Wood Radius Corner (per corner) (not available in LWFL, WWFL, LWPI and WWPI)	CRW3	\$82
Ganging Clips (1 set includes 2 male and 2 female clips)	GC	\$148

Grommets		
2" Round Metal Grommet - Matte Black	GMBK	\$138
2" Round Metal Grommet - Satin Chrome	GMSC	\$138
2" Round Metal Grommet - Polished Chrome	GMPC	\$138
2" Round Plastic Grommet - Matte Black	GPMBK	\$44
Grommet location	use location code	n/c

Edge Options		
1.75" Thick Edge (per table) (see edge details for specific profiles)	175E	15%

Modesty Panels		
Fixed Modesty Panel Laminate (48,60,72)	MODLFX	\$248
Fixed Modesty Panel Veneer (48,60,72)	MODVFX	\$386
Folding Modesty Panel Laminate (48,60,72)	MODLFL	\$330
Folding Modesty Veneer (48,60,72)	MODVFL	\$468

Wire Management		
J-Trough (horizontal mount) - Matte Black	WMJ	\$116
Legway Wire Manager (vertical mount) - Matte Black	WML	\$56

Data and Power		
Recessed Power and Data Module Two	DPBS2	\$396
Recessed Power and Data Module Four	DPBS4	\$688
Retractable Power and Data Module Two	DPAS2	\$606
Retractable Power and Data Module Three	DPAS3	\$688
Under Top Mounted Power and Data Module Two	DPUS2	\$358

Other		
Table Truck for Folding Tables	TTRK	\$1512

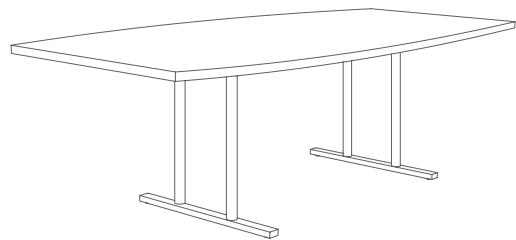

Laminate Tops

Wood Veneer Tops

Self Edge	Vinyl Edges	PVC Edges	Metal Edges	Wood Edges Group A	Wood Edges Group B	Wood Edges Group A	Wood Edges Group B
LLSE Self Edge	LVFL Flat	LPVC PVC	LMFL Flat	LWFL Flat	LWSQ Square	WWFL Flat	WWSQ Square
	LVBP Bumper		LMRB Ribbed	LWTP Tapered Ply	LWAR Arc	WWTP Tapered Ply	WWAR Arc
				LWFP Flat Ply	LWBN Bullnose	WWFP Flat Ply	WWBN Bullnose
					LWPR Prism		WWPR Prism
					LWPI Pivot		WWPI Pivot

Complete Table List Pricing

	Top Size	Base Qty.	Base Style	Model #	\$								
Arc Rectangle 	60 120	2	TT	TUTT60120AR	1,957	1,957	2,102	2,179	2,342	3,218	2,762	3,564	
	60 144	3	TT	TUTT60144AR	2,423	2,423	2,567	2,658	2,977	3,823	3,281	4,494	
	60 168	3	TT	TUTT60168AR	2,699	2,699	2,845	2,950	3,265	4,220	3,604	4,884	
Boat Shape 	36 42 72	2	T	TUT3672BS	1,276	1,276	1,241	1,288	1,522	1,946	1,681	2,158	
	36 48 84	2	TT	TUTT3684BS	1,451	1,451	1,516	1,572	1,877	2,272	2,072	2,519	
	36 48 96	2	TT	TUTT3696BS	1,570	1,570	1,634	1,691	2,043	2,390	2,259	2,648	
	36 48 120	2	TT	TUTT36120BS	1,807	1,807	1,884	1,955	2,426	2,659	2,690	2,951	
	36 48 144	3	TT	TUTT36144BS	2,229	2,229	2,318	2,403	3,064	3,305	3,385	3,657	
	36 48 168	3	TT	TUTT36168BS	2,455	2,455	2,566	2,665	3,400	3,526	3,764	3,906	

How to Order

Table Model Number					Top Finish Selection		Options	
TUTT Base Series	3648120 Top Size	BS Top Shape	WWSQ Top Material Edge Profile	MBK Base Finish	WMW Top Finish	WMW Edge Finish	GMBK Matte Black Grommet	G Location "G"
A TUTT3648120BSWWSQMBK is a Tuscan series 36" x 48" x 120" boat shape table with two black powder coat TT-bases and a wood veneer 1.25" thick top with a 1.25" square wood edge profile.					The codes: WMW WMW specify a medium walnut top, with a medium walnut edge.		The code: GMBK specifies a matte black 2" diameter metal grommet.	
							The code: G specifies the location of the grommet.	

Specialty Tops

Butcher Block	Ultrafoam	Acrylic	Corian Group A,B	Corian Group C,D	3form Chroma
BBFL Flat	ULFP PVC	AAOP Opaque	C1FL Flat	C2FL Flat	3FFL Flat
BBBN Bullnose	ULFR Raw	AATL Translucent	C1BN Bullnose	C2BN Bullnose	3FBN Bullnose
			C1PR Prism	C2PR Prism	3FPR Prism

\$					
-	-	-	-	-	-
-	-	-	-	-	-
-	-	-	-	-	-
-	-	-	-	-	-
-	-	-	-	-	-
-	-	-	-	-	-
-	-	-	-	-	-
-	-	-	-	-	-
-	-	-	-	-	-
-	-	-	-	-	-

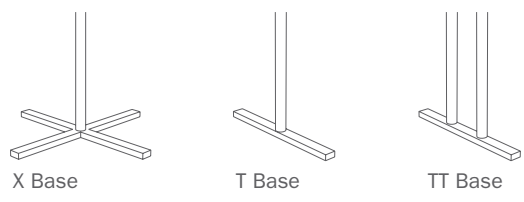

Options

Base Finishes		
Standard Powder Coat	use finish code	n/c
Polished or Satin Chrome (per base)	use finish code	\$114
Premium Plated (per base)	use finish code	Ⓛ
Custom Powder Coat (set-up charge)	CPC	\$363

Base Options		
Alternate Height Base (per column)	AH	\$66
Super Level Glides (per base)	GSL	\$34
Locking Casters 2" Twin Wheel (qty. 4)	TWC2	\$56
Tilt-top - (standard cable release)	TMX/TMT	\$270 X-base/ \$418 T-base
Folding	FM	\$270 T-base

Top Materials and Finishes		
Standard Laminates	use manufacturers finish code	n/c
Premium Laminates	PRL	Ⓛ
Custom Wood Veneer	CWV	Ⓛ
Special Pattern Veneer	SPV	Ⓛ
Stain to Match (set-up charge)	STM	\$412

Top Options		
Custom Size	CS	Ⓛ
Custom Shape	CSH	Ⓛ
Custom Radius Corner	CRC	Ⓛ
3" Radius Corner (per corner)	CRL3	\$34
(laminate self edge, ultrafoam, Corian®, 3form chroma)		
3" Wood Radius Corner (per corner)	CRW3	\$82
(not available in LWFL, WWFL, LWPI and WWPI)		
Ganging Clips (1 set includes 2 male and 2 female clips)	GC	\$148

Grommets		
2" Round Metal Grommet - Matte Black	GMBK	\$138
2" Round Metal Grommet - Satin Chrome	GMSC	\$138
2" Round Metal Grommet - Polished Chrome	GMPC	\$138
2" Round Plastic Grommet - Matte Black	GPMBK	\$44
Grommet location	use location code	n/c

Edge Options		
1.75" Thick Edge (per table)	175E	15%
(see edge details for specific profiles)		

Modesty Panels		
Fixed Modesty Panel Laminate (48,60,72)	MODLFX	\$248
Fixed Modesty Panel Veneer (48,60,72)	MODVFX	\$386
Folding Modesty Panel Laminate (48,60,72)	MODLFL	\$330
Folding Modesty Veneer (48,60,72)	MODVFL	\$468

Wire Management		
J-Trough (horizontal mount) - Matte Black	WMJ	\$116
Legway Wire Manager (vertical mount) - Matte Black	WML	\$56

Data and Power		
Recessed Power and Data Module Two	DPBS2	\$396
Recessed Power and Data Module Four	DPBS4	\$688
Retractable Power and Data Module Two	DPAS2	\$606
Retractable Power and Data Module Three	DPAS3	\$688
Under Top Mounted Power and Data Module Two	DPUS2	\$358

Other		
Table Truck for Folding Tables	TTRK	\$1512

Occasional Tables

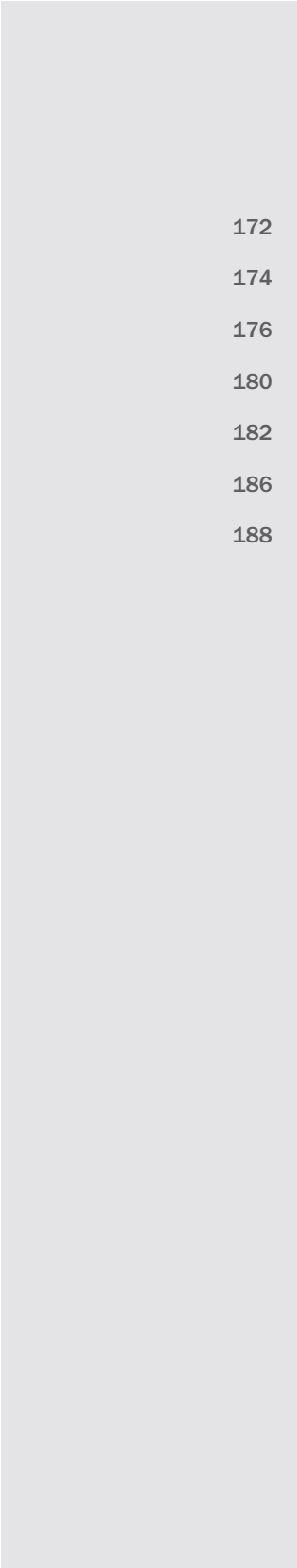

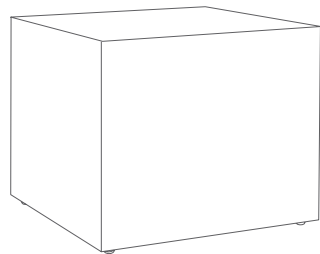

- 172 Cube
- 174 Cylinder
- 176 Disc
- 180 Move
- 182 Parsons
- 186 Platform
- 188 Tulip

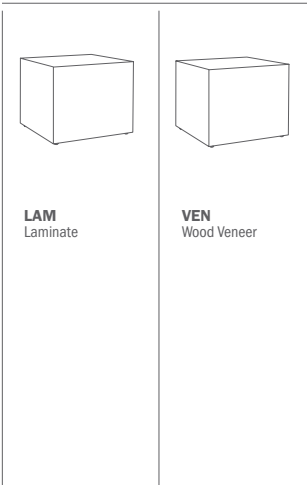

Laminate Wood Veneer



Complete Table List Pricing

	Top Size		Table Height	Model #	\$	
Square 	18	18	18	CU1818SQ18	610	868
	18	18	20	CU1818SQ20	656	930
	18	18	24	CU1818SQ24	722	1,011
	20	20	18	CU2020SQ18	670	944
	20	20	20	CU2020SQ20	719	1,008
	20	20	24	CU2020SQ24	789	1,094
	24	24	18	CU2424SQ18	769	1,073
	24	24	20	CU2424SQ20	822	1,141
	24	24	24	CU2424SQ24	900	1,235
	30	30	16	CU3030SQ16	879	1,182
	30	30	18	CU3030SQ18	939	1,256
	36	36	16	CU3636SQ16	1,032	1,364
	36	36	18	CU3636SQ18	1,097	1,445
	Rectangle 	20	30	18	CU2030RE18	786
20		30	20	CU2030RE20	840	1,156
24		36	16	CU2436RE16	873	1,175
24		36	18	CU2436RE18	932	1,249
24		48	16	CU2448RE16	1,005	1,337
24		48	18	CU2448RE18	1,071	1,418

How to Order

Table Model Number					Finish Selection	Options		
CU Base Series	2020 Top Size	SQ Top Shape	18 Table Height	VEN Material	WNM Wood Natural Maple Veneer	KBL Laminate Kick Base	Formica® 909-58 Black Laminate	
A CU2020SQ18VEN is a Cube occasional table, 20" x 20" square x 18" high with wood veneer.					The code: WNM specifies wood natural maple veneer.	The code: KBL specifies a 2" high x 1" deep laminate kick base.	The code: Formica 909-58 specifies the manufacturer and color of the laminate used on the kick base.	

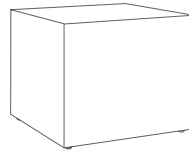

Options

Base Options

Kick Base (laminate)	KBL	\$276
Kick Base (veneer)	KBV	\$358

Top Materials and Finishes

Standard Laminates	use manufacturers finish code	n/c
Standard Wood Veneer	use wood surface code	n/c
Premium Laminates	PRL	Ⓛ
Custom Wood Veneer	CWV	Ⓛ
Special Pattern Veneer	SPV	Ⓛ
Stain to Match (set-up charge)	STM	\$412

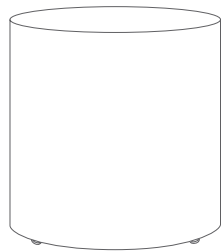

Laminate Wood Veneer

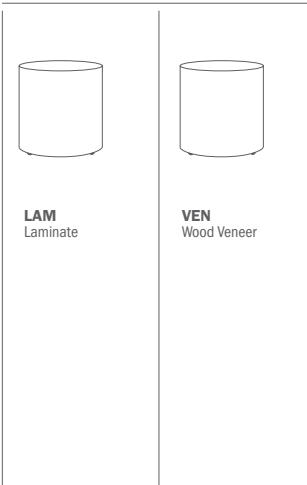

Complete Table List Pricing

	Top Size	Table Height	Model #	\$	
Round 	18	18	CY18RD18	776	976
	18	20	CY18RD20	822	1,037
	18	24	CY18RD24	900	1,132
	20	18	CY20RD18	817	1,032
	20	20	CY20RD20	866	1,096
	20	24	CY20RD24	950	1,197
	24	18	CY24RD18	871	1,129
	24	20	CY24RD20	924	1,199
	24	24	CY24RD24	1,018	1,308
	30	16	CY30RD16	1,074	1,355
	30	18	CY30RD18	1,145	1,443
	30	20	CY30RD20	1,217	1,530
	30	24	CY30RD24	1,346	1,677
	36	18	CY36RD18	1,253	1,567
	36	20	CY36RD20	1,335	1,666
	36	24	CY36RD24	1,485	1,834

How to Order

Table Model Number

CY Base Series **24** Top Size **RD** Top Shape **18** Table Height **VEN** Material

A CY24RD18VEN is a Cylinder occasional table, 24" round x 18" high with wood veneer.

Finish Selection

WNM Wood Natural Maple Veneer

The code: WNM specifies wood natural maple veneer.

Options

KBL Laminate Kick Base

The code: KB specifies a 2" high x 1" deep laminate kick base.

Formica® 909-58 Black Laminate

The code: Formica 909-58 specifies the manufacturer and color of the laminate used on the kick base.

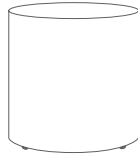

Options

Base Options

Kick Base (laminate)	KBL	\$276
Kick Base (veneer)	KBV	\$358

Top Materials and Finishes

Standard Laminates	use manufacturers finish code	n/c
Standard Wood Veneer	use wood surface code	n/c
Premium Laminates	PRL	Ⓛ
Custom Wood Veneer	CWV	Ⓛ
Special Pattern Veneer	SPV	Ⓛ
Stain to Match (set-up charge)	STM	\$412

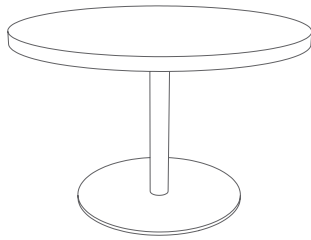

Laminate Tops

Wood Veneer Tops

Self Edge Vinyl Edges	Wood Edges Group A	Wood Edges Group B	Wood Edges Group A	Wood Edges Group B
LLSE Self Edge	LWFL Flat	LWBN Bullnose	WWFL Flat	WWBN Bullnose
	LWTP Tapered Ply	LWPR Prism	WWTP Tapered Ply	WWPR Prism
	LWFP Flat Ply	LWPI Pivot	WWFP Flat Ply	WWPI Pivot
		LWSQ Square		WWSQ Square

Complete Table List Pricing

	Top Size	Table Height	Base Qty.	Model #	\$					
Round 	20	16	1	DI20RD16	666	849	979	833	1,033	
	20	18	1	DI20RD18	666	849	979	833	1,033	
	20	20	1	DI20RD20	666	849	979	833	1,033	
	24	16	1	DI24RD16	690	898	1,067	833	1,139	
	24	18	1	DI24RD18	690	898	1,067	833	1,139	
	24	20	1	DI24RD20	690	898	1,067	833	1,139	
	30	16	1	DI30RD16	750	1,011	1,192	1,011	1,279	
	30	18	1	DI30RD18	750	1,011	1,192	1,011	1,279	
	36	16	1	DI36RD16	990	1,297	1,507	1,323	1,612	
	36	18	1	DI36RD18	990	1,297	1,507	1,323	1,612	
	42	16	1	DI42RD16	1,091	1,413	1,671	1,507	1,797	
	42	18	1	DI42RD18	1,091	1,413	1,671	1,507	1,797	
Square 	20	20	16	DI2020SQ16	664	847	998	836	1,042	
	20	20	18	DI2020SQ18	664	847	998	836	1,042	
	20	20	20	DI2020SQ20	664	847	998	836	1,042	
	24	24	16	DI2424SQ16	690	898	1,067	908	1,139	
	24	24	18	DI2424SQ18	690	898	1,067	908	1,139	
	24	24	20	DI2424SQ20	690	898	1,067	908	1,139	
	30	30	16	DI3030SQ16	750	1,011	1,192	1,011	1,279	
	30	30	18	DI3030SQ18	750	1,011	1,192	1,011	1,279	
	36	36	16	DI3636SQ16	990	1,287	1,507	1,323	1,612	
	36	36	18	DI3636SQ18	990	1,287	1,507	1,323	1,612	

Continued on next page

How to Order

Table Model Number

Top Finish Selection











DI Base Series	24 Top Size	RD Top Shape	18 Table Height	AAOP Material	MBK Base Finish
--------------------------	-----------------------	------------------------	---------------------------	-------------------------	---------------------------

AWQ Top Finish

A DI24RD18AAOPMBK is a Disc series 24" round x 18" high round occasional table with a black powder coat round base and an opaque acrylic 1.25" thick top with a waterfall edge profile.

The codes: AWQ specify a white quartz acrylic top.

Specialty Tops

Acrylic	Corian Group A,B	Corian Group C,D	3form Chroma
 AAOP Opaque	 C1FL Flat	 C2FL Flat	 3FFL Flat
 AATL Translucent	 C1BN Bullnose	 C2BN Bullnose	 3FBN Bullnose
	 C1PR Prism	 C2PR Prism	 3FPR Prism

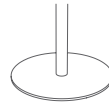

Options

Base Finishes

Standard Powder Coat	use finish code	n/c
Polished or Satin Chrome (per base)	use finish code	\$213
Premium Plated (per base)	use finish code	Ⓛ
Custom Powder Coat (set-up charge)	CPC	\$363

Top Materials and Finishes

Standard Laminates	use manufacturers finish code	n/c
Premium Laminates	PRL	Ⓛ
Custom Wood Veneer	CWV	Ⓛ
Special Pattern Veneer	SPV	Ⓛ
Stain to Match (set-up charge)	STM	\$412

Top Options

Custom Size	CS	Ⓛ
Custom Shape	CSH	Ⓛ
Custom Radius Corner	CRC	Ⓛ
3" Radius Corner (per corner)	CRL3	\$34
(laminates self edge, ultrafoam, Corian®, 3form chroma)		
3" Wood Radius Corner (per corner)	CRW3	\$82
(not available in LWFL, WWFL, LWPI and WWPI)		

\$			
-	1,122	1,257	1,607
-	1,122	1,257	1,607
-	1,122	1,257	1,607
1,300	1,215	1,392	1,804
1,300	1,215	1,392	1,804
1,300	1,215	1,392	1,804
1,758	1,487	1,751	2,804
1,758	1,487	1,751	2,804
2,379	1,995	2,353	3,874
2,379	1,995	2,353	3,874
3,030	2,386	2,863	5,010
3,030	2,386	2,863	5,010
-	1,052	1,167	1,465
-	1,052	1,167	1,465
-	1,052	1,167	1,465
1,302	1,130	1,283	1,771
1,302	1,130	1,283	1,771
1,302	1,130	1,283	1,771
1,763	1,382	1,610	2,759
1,763	1,382	1,610	2,759
2,386	1,877	2,196	3,822
2,386	1,877	2,196	3,822

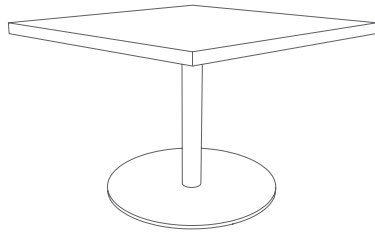

Laminate Tops

Wood Veneer Tops

Self Edge Vinyl Edges	Wood Edges Group A	Wood Edges Group B	Wood Edges Group A	Wood Edges Group B
LLSE Self Edge	LWFL Flat	LWBN Bullnose	WWFL Flat	WWBN Bullnose
	LWTP Tapered Ply	LWPR Prism	WWTP Tapered Ply	WWPR Prism
	LWFP Flat Ply	LWPI Pivot	WWFP Flat Ply	WWPI Pivot
		LWSQ Square		WWSQ Square

Complete Table List Pricing

	Top Size	Table Height	Base Qty.	Model #	\$					
Square 	42	42	16	1	DI4242SQ16	1,079	1,413	1,671	1,507	1,797
	42	42	18	1	DI4242SQ18	1,079	1,413	1,671	1,507	1,797
Rectangle 	20	30	16	1	DI2030RE16	693	903	1,077	916	1,153
	20	30	18	1	DI2030RE18	693	903	1,077	916	1,153
	20	36	16	1	DI2036RE16	711	939	1,136	969	1,227
	20	36	18	1	DI2036RE18	711	939	1,136	969	1,227
	30	36	16	1	DI3036RE16	953	1,235	1,433	1,307	1,529
	30	36	18	1	D3036RE18	953	1,235	1,433	1,307	1,529
	30	42	16	1	DI3042RE16	988	1,330	1,552	1,412	1,663
	30	42	18	1	DI3042RE18	988	1,330	1,552	1,412	1,663
	30	48	16	1	DI3048RE16	1,150	1,500	1,741	1,591	1,860
	30	48	18	1	D3048RE18	1,150	1,500	1,741	1,591	1,860
Oval 	20	36	16	1	DI2036OV16	785	1,004	1,128	1,030	1,177
	20	36	18	1	DI2036OV18	785	1,004	1,128	1,030	1,177
	24	42	16	1	DI2442OV16	992	1,246	1,402	1,315	1,475
	24	42	18	1	DI2442OV18	992	1,246	1,402	1,315	1,475
	30	48	16	1	DI3048OV16	1,217	1,561	1,742	1,630	1,815
	30	48	18	1	DI3048OV18	1,217	1,561	1,742	1,630	1,815

How to Order

Table Model Number

DI Base Series	4242 Top Size	SQ Top Shape	18 Table Height	WWFL Material	MBK Base Finish
--------------------------	-------------------------	------------------------	---------------------------	-------------------------	---------------------------











Top Finish Selection

WMW Top Finish	WMW Edge Finish
--------------------------	---------------------------

A DI4242SQ18WWFLMBK is a Disc series 42" x 42" square x 18" high occasional table with a black powder coat round base and a wood veneer 1.25" thick top with a .125" flat wood edge profile.

The codes: WMW WMW specify a medium walnut top, with a medium walnut edge.

Specialty Tops

Acrylic	Corian Group A,B	Corian Group C,D	3form Chroma
 AAOP Opaque	 C1FL Flat	 C2FL Flat	 3FFL Flat
 AATL Translucent	 C1BN Bullnose	 C2BN Bullnose	 3FBN Bullnose
	 C1PR Prism	 C2PR Prism	 3FPR Prism

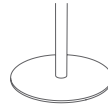

Options

Base Finishes

Standard Powder Coat	use finish code	n/c
Polished or Satin Chrome (per base)	use finish code	\$213
Premium Plated (per base)	use finish code	Ⓛ
Custom Powder Coat (set-up charge)	CPC	\$330

Top Materials and Finishes

Standard Laminates	use manufacturers finish code	n/c
Premium Laminates	PRL	Ⓛ
Custom Wood Veneer	CWV	Ⓛ
Special Pattern Veneer	SPV	Ⓛ
Stain to Match (set-up charge)	STM	\$412

\$			
3,038	2,246	2,670	4,946
3,038	2,246	2,670	4,946

-	1,142	1,300	2,003
-	1,142	1,300	2,003

-	1,208	1,392	2,254
-	1,208	1,392	2,254

2,178	1,682	1,949	3,347
2,178	1,682	1,949	3,347

2,421	1,820	2,130	3,785
2,421	1,820	2,130	3,785

2,795	2,097	2,449	4,338
2,795	2,097	2,449	4,338





-	1,413	1,618	-
-	1,413	1,618	-

-	1,815	2,091	-
-	1,815	2,091	-

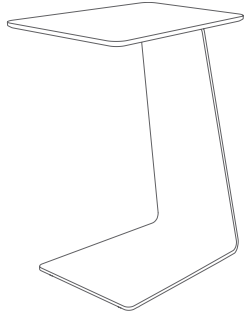
-	2,285	2,667	-
-	2,285	2,667	-

Move Tops



Laminate	Veneer	Corian Group A, B, C	3form Chroma
			
LMOV Ply	WMOV Wood	CMOV Corian	3MOV Chroma

Complete Table List Pricing

	Top Size			Table Height	Model #	\$			
Trapezoid	18	13	15	25	MOV	688	760	780	906



How to Order

Table Model Number

MOV Table Series	WMOV Top Material	MBK Base Finish	WNM Top Finish
----------------------------	-----------------------------	---------------------------	--------------------------

A MOVWMOVMBK is a Move table with a matte black powder coat base and a wood veneer top.

The code: WNM specifies a natural maple top.

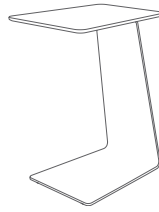

Options

Base Finishes

Powder Coat	use finish code	n/c
Satin Chrome (per base)	use finish code	\$400
Premium Plated (per base)*	use finish code	🕒
Custom Powder Coat (set-up charge)	CPC	\$363

Top Materials and Finishes

Standard Laminates	use manufacturers finish code	n/c
Premium Laminates	PRL	🕒
Custom Wood Veneer	CWV	🕒
Stain to Match (set-up charge)	STM	\$412

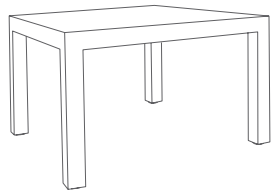

*Premium plated polished not available on Move tables.

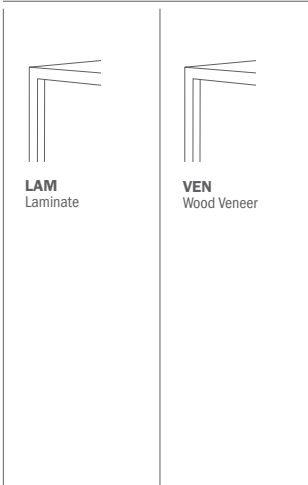

Laminate Wood Veneer



Complete Table List Pricing

	Top Size	Table Height	Model #	\$	
Square 	18 18	18	PA1818SQ18	1,027	1,482
	18 18	20	PA1818SQ20	1,049	1,504
	18 18	24	PA1818SQ24	1,092	1,548
	20 20	18	PA2020SQ18	1,048	1,510
	20 20	20	PA2020SQ20	1,070	1,532
	20 20	24	PA2020SQ24	1,113	1,576
	24 24	18	PA2424SQ18	1,230	1,729
	24 24	20	PA2424SQ20	1,252	1,751
	24 24	24	PA2424SQ24	1,295	1,795
	30 30	16	PA3030SQ16	1,323	1,891
	30 30	18	PA3030SQ18	1,361	1,947
	30 30	20	PA3030SQ20	1,382	1,969
	30 30	24	PA3030SQ24	1,426	2,013
	36 36	16	PA3636SQ16	1,455	2,072
36 36	18	PA3636SQ18	1,493	2,128	
36 36	20	PA3636SQ20	1,514	2,150	
36 36	24	PA3636SQ24	1,558	2,194	
Rectangle 	18 36	16	PA1836RE16	1,149	1,705
	18 36	18	PA1836RE18	1,187	1,761
	18 36	20	PA1836RE20	1,209	1,783
	18 48	16	PA1848RE16	1,276	1,879
	18 48	18	PA1848RE18	1,313	1,935
	18 48	20	PA1848RE20	1,335	1,957

Continued on next page

How to Order

Table Model Number

PA	1818	SQ	18	VEN
Base Series	Top Size	Top Shape	Table Height	Material

A PA1818SQ18VEN is a Parsons series 18" x 18" square x 18" high occasional table, with four with wood veneer legs.

Top Finish Selection

WNM
Wood Natural Maple Veneer

The code: WNM specifies wood natural maple veneer.

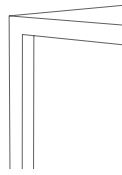

Options

Top Materials and Finishes

Standard Laminates	use manufacturers finish code	n/c
Standard Wood Veneer	use wood surface code	n/c
Premium Laminates	PRL	Ⓛ
Custom Wood Veneer	CWV	Ⓛ
Special Pattern Veneer	SPV	Ⓛ
Stain to Match (set-up charge)	STM	\$412

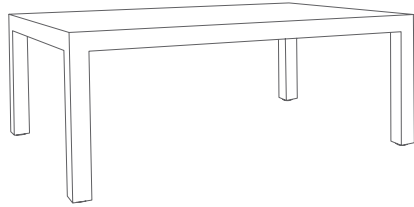

Laminate Wood Veneer

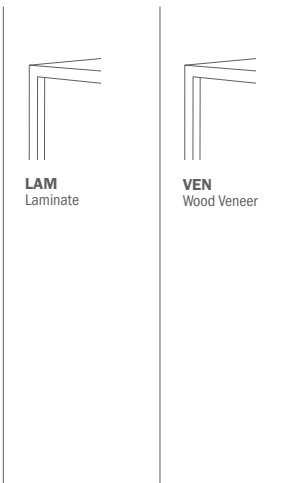

Complete Table List Pricing

	Top Size	Table Height	Model #	\$		
Rectangle 	18	60	16	PA1860RE16	1,394	2,048
	18	60	18	PA1860RE18	1,432	2,104
	18	60	20	PA1860RE20	1,454	2,126
	20	30	16	PA2030RE16	1,133	1,684
	20	30	18	PA2030RE18	1,171	1,740
	20	30	20	PA2030RE20	1,192	1,925
	24	36	16	PA2436RE16	1,262	1,865
	24	36	18	PA2436RE18	1,300	1,938
	24	48	16	PA2448RE16	1,377	2,036
	24	48	18	PA2448RE18	1,415	2,092

How to Order

Table Model Number

PA	1860	RE	18	VEN
Base Series	Top Size	Top Shape	Table Height	Material

A PA1860RE18VEN is a Parsons series 18" x 60" rectangle x 18" high occasional table, with four wood veneer legs.

Top Finish Selection

WNM
Wood Natural Maple Veneer

The code: WNM specifies wood natural maple veneer.

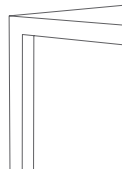

Options

Top Materials and Finishes

Standard Laminates	use manufacturers finish code	n/c
Standard Wood Veneer	use wood surface code	n/c
Premium Laminates	PRL	Ⓛ
Custom Wood Veneer	CWV	Ⓛ
Special Pattern Veneer	SPV	Ⓛ
Stain to Match (set-up charge)	STM	\$412

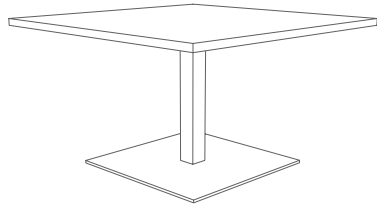

Laminate Tops

Wood Veneer Tops

Self Edge Vinyl Edges	Wood Edges Group A	Wood Edges Group B	Wood Edges Group A	Wood Edges Group B
LLSE Self Edge	LWFL Flat	LWBN Bullnose	WWFL Flat	WWBN Bullnose
	LWTP Tapered Ply	LWPR Prism	WWTP Tapered Ply	WWPR Prism
	LWFP Flat Ply	LWPI Pivot	WWFP Flat Ply	WWPI Pivot
		LWSQ Square		WWSQ Square

Complete Table List Pricing

	Top Size	Table Height	Base Qty.	Model #	\$					
Square 	20	20	16	1	PL2020SQ16	664	847	998	836	1,042
	20	20	18	1	PL2020SQ18	664	847	998	836	1,042
	20	20	20	1	PL2020SQ20	664	847	998	836	1,042
	24	24	16	1	PL2424SQ16	690	898	1,067	908	1,139
	24	24	18	1	PL2424SQ18	690	898	1,067	908	1,139
	24	24	20	1	PL2424SQ20	690	898	1,067	908	1,139
	30	30	16	1	PL3030SQ16	750	1,011	1,192	1,011	1,279
	30	30	18	1	PL3030SQ18	750	1,011	1,192	1,011	1,279
	36	36	16	1	PL3636SQ16	990	1,287	1,507	1,323	1,612
	36	36	18	1	PL3636SQ18	990	1,287	1,507	1,323	1,612
	42	42	16	1	PL4242SQ16	1,079	1,413	1,671	1,507	1,797
	42	42	18	1	PL4242SQ18	1,079	1,413	1,671	1,507	1,797
Rectangle 	20	30	16	1	PL2030RE16	693	903	1,077	916	1,153
	20	30	18	1	PL2030RE18	693	903	1,077	916	1,153
	20	36	16	1	PL2036RE16	711	939	1,136	969	1,227
	20	36	18	1	PL2036RE18	711	939	1,136	969	1,227
	30	36	16	1	PL3036RE16	953	1,235	1,433	1,307	1,529
	30	36	18	1	PL3036RE18	953	1,235	1,433	1,307	1,529
	30	42	16	1	PL3042RE16	988	1,330	1,552	1,412	1,663
	30	42	18	1	PL3042RE18	988	1,330	1,552	1,412	1,663
	30	48	16	1	PL3048RE16	1,150	1,500	1,741	1,591	1,860
	30	48	18	1	PL3048RE18	1,150	1,500	1,741	1,591	1,860

How to Order

Table Model Number

Top Finish Selection











PL Base Series	2020 Top Size	SQ Top Shape	16 Table Height	WWFL Material	MBK Base Finish
--------------------------	-------------------------	------------------------	---------------------------	-------------------------	---------------------------

WMW Top Finish	WMW Edge Finish
--------------------------	---------------------------

A PL2020SQ16WWFLMBK is a Platform series 20" x 20" square x 16" high occasional table with a black powder coat square base and a wood veneer 1.25" thick top with a .125" flat wood edge profile.

The codes: WMW WMW specify a medium walnut top, with a medium walnut edge.

Specialty Tops

Acrylic	Corian Group A,B	Corian Group C,D	3form Chroma
 AAOP Opaque	 C1FL Flat	 C2FL Flat	 3FFL Flat
 AATL Translucent	 C1BN Bullnose	 C2BN Bullnose	 3FBN Bullnose
	 C1PR Prism	 C2PR Prism	 3FPR Prism

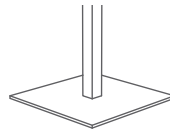

Options

Base Finishes

Standard Powder Coat	use finish code	n/c
Polished or Satin Chrome (per base)	use finish code	\$213
Premium Plated (per base)	use finish code	🕒
Custom Powder Coat (set-up charge)	CPC	\$363

Top Materials and Finishes

Standard Laminates	use manufacturers finish code	n/c
Premium Laminates	PRL	🕒
Custom Wood Veneer	CWV	🕒
Special Pattern Veneer	SPV	🕒
Stain to Match (set-up charge)	STM	\$412

\$				
-	1,052	1,167	1,465	
	1,052	1,167	1,465	
	1,052	1,167	1,465	
1,302	1,130	1,283	1,771	
1,302	1,130	1,283	1,771	
1,302	1,130	1,283	1,771	
1,763	1,382	1,610	2,759	
1,763	1,382	1,610	2,759	
2,386	1,877	2,196	3,822	
2,386	1,877	2,196	3,822	
3,038	2,246	2,670	4,946	
3,038	2,246	2,670	4,946	
-	1,142	1,300	2,003	
-	1,142	1,300	2,003	
-	1,208	1,392	2,254	
-	1,208	1,392	2,254	
2,178	1,682	1,949	3,347	
2,178	1,682	1,949	3,347	
2,421	1,820	2,130	3,785	
2,421	1,820	2,130	3,785	
2,795	2,097	2,449	4,338	
2,795	2,097	2,449	4,338	

Laminate Tops

Wood Veneer Tops

Self Edge Vinyl Edges	Wood Edges Group A	Wood Edges Group B	Wood Edges Group A	Wood Edges Group B
LLSE Self Edge	LWFL Flat	LWBN Bullnose	WWFL Flat	WWBN Bullnose
	LWTP Tapered Ply	LWPR Prism	WWTP Tapered Ply	WWPR Prism
	LWFP Flat Ply	LWPI Pivot	WWFP Flat Ply	WWPI Pivot
		LWSQ Square		WWSQ Square



Complete Table List Pricing

	Top Size	Table Height	Base Style	Base Qty.	Model #	\$					
Round	20	16	18L	1	TL18L20RD16	831	1,014	1,144	998	1,198	
	20	18	18L	1	TL18L20RD18	831	1,014	1,144	998	1,198	
	20	20	18L	1	TL18L20RD20	831	1,014	1,144	998	1,198	
	24	16	18L	1	TL18L24RD16	855	1,063	1,232	1,073	1,304	
	24	18	18L	1	TL18L24RD18	855	1,063	1,232	1,073	1,304	
	24	20	18L	1	TL18L24RD20	855	1,063	1,232	1,073	1,304	
	30	16	18M	1	TL18M30RD16	970	1,231	1,412	1,231	1,231	
	30	18	18M	1	TL18M30RD18	970	1,231	1,412	1,231	1,231	
	36	16	18H	1	TL18H36RD16	1,120	1,427	1,637	1,453	1,742	
	36	18	18H	1	TL18H36RD18	1,120	1,427	1,637	1,453	1,742	
	42	16	24M	1	TL24M42RD16	1,261	1,583	1,841	1,677	1,967	
	42	18	24M	1	TL24M42RD18	1,261	1,583	1,841	1,677	1,967	
Square	20	20	16	18L	1	TL18L2020SQ16	829	1,012	1,163	1,001	1,207
	20	20	18	18L	1	TL18L2020SQ18	829	1,012	1,163	1,001	1,207
	20	20	20	18L	1	TL18L2020SQ20	829	1,012	1,163	1,001	1,207
	24	24	16	18L	1	TL18L2424SQ16	855	1,063	1,232	1,073	1,304
	24	24	18	18L	1	TL18L2424SQ18	855	1,063	1,232	1,073	1,304
	24	24	20	18L	1	TL18L2424SQ20	855	1,063	1,232	1,073	1,304
	30	30	16	18M	1	TL18M3030SQ16	970	1,231	1,412	1,231	1,499
	30	30	18	18M	1	TL18M3030SQ18	970	1,231	1,412	1,231	1,499
	36	36	16	18H	1	TL18H3636SQ16	1,120	1,417	1,637	1,453	1,742
	36	36	18	18H	1	TL18H3636SQ18	1,120	1,417	1,637	1,453	1,742

Continued on next page

How to Order

Table Model Number

TL Base Series	20 Top Size	RD Top Shape	16 Table Height	WWFL Material	MBK Base Finish
--------------------------	-----------------------	------------------------	---------------------------	-------------------------	---------------------------











Top Finish Selection

WMW Top Finish	WMW Edge Finish
--------------------------	---------------------------

A TL18L20RD16WWFLMBK is a Tulip series 20" round x 16" high occasional table, with a black powder coat base and a wood round veneer 1.25" thick top with a .125" flat wood edge profile.

The codes: WMW WMW specify a medium walnut top, with a medium walnut edge.

Specialty Tops

Acrylic	Corian Group A,B	Corian Group C,D	3form Chroma
 AAOP Opaque	 C1FL Flat	 C2FL Flat	 3FFL Flat
 AATL Translucent	 C1BN Bullnose	 C2BN Bullnose	 3FBN Bullnose
	 C1PR Prism	 C2PR Prism	 3FPR Prism

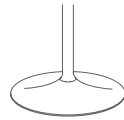

Options

Base Finishes

Standard Powder Coat	use finish code	n/c
Polished or Satin Chrome (per base)	use finish code	\$194
Premium Plated (per base)	use finish code	🕒
Custom Powder Coat (set-up charge)	CPC	\$363

\$			
-	1,287	1,422	1,772
	1,287	1,422	1,772
	1,287	1,422	1,772
1,465	1,380	1,557	1,969
1,465	1,380	1,557	1,969
1,465	1,380	1,557	1,969
1,978	1,707	1,971	3,024
1,978	1,707	1,971	3,024
2,509	2,125	2,483	4,004
2,509	2,125	2,483	4,004
3,200	2,556	3,033	5,180
3,200	2,556	3,033	5,180
-	1,217	1,332	1,630
	1,217	1,332	1,630
	1,217	1,332	1,630
1,467	1,295	1,448	1,936
1,467	1,295	1,448	1,936
1,467	1,295	1,448	1,936
1,983	1,602	1,830	2,979
1,983	1,602	1,830	2,979
2,516	2,007	2,326	3,952
2,516	2,007	2,326	3,952

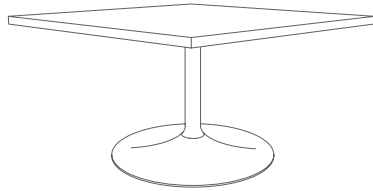

Laminate Tops

Wood Veneer Tops

Self Edge Vinyl Edges	Wood Edges Group A	Wood Edges Group B	Wood Edges Group A	Wood Edges Group B
LLSE Self Edge	LWFL Flat	LWBN Bullnose	WWFL Flat	WWBN Bullnose
	LWTP Tapered Ply	LWPR Prism	WWTP Tapered Ply	WWPR Prism
	LWFP Flat Ply	LWPI Pivot	WWFP Flat Ply	WWPI Pivot
		LWSQ Square		WWSQ Square

Complete Table List Pricing

	Top Size	Table Height	Base Style	Base Qty.	Model #	\$					
Square	42	42	16	24M	1	TL24M4242SQ16	1,249	1,583	1,841	1,677	1,967
	42	42	18	24M	1	TL24M4242SQ18	1,249	1,583	1,841	1,677	1,967
Rectangle	20	30	16	18M	1	TL18M2030RE16	913	1,123	1,297	1,136	1,373
	20	30	18	18M	1	TL18M2030RE18	913	1,123	1,297	1,136	1,373
	20	36	16	18H	1	TL18H2036RE16	1,001	1,229	1,426	1,259	1,517
	20	36	18	18H	1	TL18H2036RE18	1,001	1,229	1,426	1,259	1,517
	30	36	16	18H	1	TL18H3036RE16	1,083	1,365	1,563	1,437	1,659
	30	36	18	18H	1	TL18H3036RE18	1,083	1,365	1,563	1,437	1,659
	30	42	16	24M	1	TL24M3042RE16	1,158	1,500	1,722	1,582	1,833
	30	42	18	24M	1	TL24M3042RE18	1,158	1,500	1,722	1,582	1,833
	30	48	16	24H	1	TL24H3048RE16	1,310	1,660	1,901	1,751	2,020
	30	48	18	24H	1	TL24H3048RE18	1,310	1,660	1,901	1,751	2,020
Oval	20	36	16	18H	1	TL18H2036OV16	1,075	1,294	1,418	1,320	1,467
	20	36	18	18H	1	TL18H2036OV18	1,075	1,294	1,418	1,320	1,467
	24	42	16	24M	1	TL24M2442OV16	1,162	1,416	1,572	1,485	1,645
	24	42	18	24M	1	TL24M2442OV18	1,162	1,416	1,572	1,485	1,645

How to Order

Table Model Number

TL24M Base Series	4242 Top Size	SQ Top Shape	16 Table Height	WWFL Material	MBK Base Finish
-----------------------------	-------------------------	------------------------	---------------------------	-------------------------	---------------------------











Top Finish Selection

WMW Top Finish	WMW Edge Finish
--------------------------	---------------------------

A TL24M4242SQ16WWFLMBK is a Tulip series 42" x 42" square x 16" high occasional table, with a black powder coat round base and a wood veneer 1.25" thick top with a .125" flat wood edge profile.

The codes: WMW WMW specify a medium walnut top, with a medium walnut edge.

Specialty Tops

Acrylic	Corian Group A,B	Corian Group C,D	3form Chroma
 AAOP Opaque	 C1FL Flat	 C2FL Flat	 3FFL Flat
 AATL Translucent	 C1BN Bullnose	 C2BN Bullnose	 3FBN Bullnose
	 C1PR Prism	 C2PR Prism	 3FPR Prism

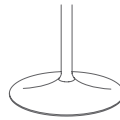

Options

Base Finishes

Standard Powder Coat	use finish code	n/c
Polished or Satin Chrome (per base)	use finish code	\$194
Premium Plated (per base)	use finish code	Ⓛ
Custom Powder Coat (set-up charge)	CPC	\$363

Top Materials and Finishes

Standard Laminates	use manufacturers finish code	n/c
Premium Laminates	PRL	Ⓛ
Custom Wood Veneer	CWV	Ⓛ
Special Pattern Veneer	SPV	Ⓛ
Stain to Match (set-up charge)	STM	\$412

\$			
3,208	2,416	2,840	5,116
3,208	2,416	2,840	5,116

-	1,362	1,520	2,223
	1,362	1,520	2,223

-	1,498	1,682	2,544
	1,498	1,682	2,544

2,308	1,812	2,079	3,477
2,308	1,812	2,079	3,477

2,591	1,990	2,300	3,955
2,591	1,990	2,300	3,955

2,955	2,257	2,609	4,498
2,955	2,257	2,609	4,498

-	1,703	1,908	-
	1,703	1,908	



-	1,985	2,261	-
	1,985	2,261	

Outdoor Tables

194	Arc
196	Basic Round
198	Bistro
200	Disc
202	Flat Round
204	Mark IV
206	Park
208	Platform
210	Sam Table
212	Tulip

Metal Tops



<p>Metal Solid</p>  <p>MES Solid</p>	<p>Metal Mesh</p>  <p>MEM Mesh</p>	<p>Stainless Steel</p>  <p>MSS Scalloped Pattern Inset Top</p>
---	---	---

Complete Table List Pricing

	Top Size	Base Height	Base Qty.	Model #	\$		
Round	32	29.25	1	ARC32RDOD	730	-	-











How to Order

Table Model Number

ARC	28	RD	OD	MES	MSL
Base Series	Top Size	Top Shape	Outdoor	Top Material	Base Finish

An ARC32RDODMESMSL is an outdoor Arc series 28" round metal table with a silver powder coat base.

Specialty Tops

Acrylic	Corian Group A,B	Corian Group C,D	3form Chroma
 AAOP Opaque	 C1FL Flat	 C2FL Flat	 3FRB Reverse Bevel
 AATL Translucent	 C1BN Bullnose	 C2BN Bullnose	
	 C1PR Prism	 C2PR Prism	

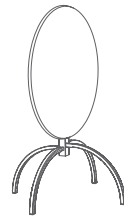

Options



Base/Top Finish		
Standard Powder Coat	MSL (silver)	n/c
Base Options		
Tilt-top Table	standard	n/c

\$

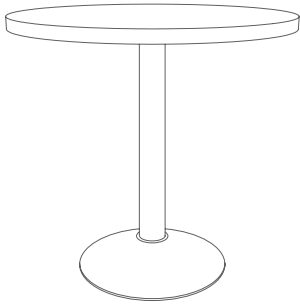

-	-	-	-
---	---	---	---

Metal Tops



<p>Metal Solid</p>  <p>MES Solid</p>	<p>Metal Mesh</p>  <p>MEM Mesh</p>	<p>Stainless Steel</p>  <p>MSS Scalloped Pattern Inset Top</p>
---	---	---









Complete Table List Pricing

	Top Size	Base Qty.	Base Style	Model #	\$			
<p>Round</p> 	24	1	17L	BA17L24RDOD	-	-	-	
	30	1	17M	BA17M30RDOD	791	-	-	
	36	1	20M	BA20M36RDOD	887	-	-	
	42	1	22L	BA22L42RDOD	1020	-	-	
	48	1	22M	BA22M48RDOD	1138	-	-	
	54	1	22H	BA22H54RDOD	-	-	-	
	60	1	28H	BA28H60RDOD	-	-	-	
<p>Square</p> 	24	24	1	17L	BA17L2424SQOD	-	-	
	30	30	1	17M	BA17M3030SQOD	789	-	-
	36	36	1	20M	BA20M3636SQOD	869	-	-
	42	42	1	22M	BA22M4242SQOD	1043	-	-
	48	48	1	22H	BA22H4848SQOD	-	-	-
<p>Rectangle</p> 	24	30	1	17M	BA17M2430REOD	725	-	-
	24	36	1	20M	BA20M2436REOD	-	-	-
	24	60	2	17L	BA17L2460REOD	-	-	-
	30	36	1	20M	BA20M3036REOD	-	-	-
	30	42	1	22L	BA22L3042REOD	-	-	-
	30	48	1	22M	BA22M3048REOD	985	-	-
	30	60	2	17M	BA17M3060REOD	-	-	-

How to Order

Table Model Number						Top Finish Selection	Options
BA20M Base Series	36 Top Size	RD Top Shape	OD Outdoor	MES Top Material	MBK Base Finish	MSL Top Finish	AH Alternate Height Base
<p>A BA20M36RDODMESMBK is an outdoor Basic Round series 36" round table with a black powder coat round base and a solid metal .75" thick top with a metal eased edge profile.</p>						<p>The code: MSL specifies a silver powder coat top.</p>	<p>The code: AH specifies alternate height base</p>

Specialty Tops

Acrylic	Corian Group A,B	Corian Group C,D	3form Chroma
 AAOP Opaque	 C1FL Flat	 C2FL Flat	 3FRB Reverse Bevel
 AATL Translucent	 C1BN Bullnose	 C2BN Bullnose	
	 C1PR Prism	 C2PR Prism	

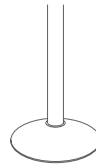

Options

Base Finishes

Standard Black Wrinkle	MWR	n/c
Powder Coat	use finish code	\$110
Custom Powder Coat (set-up charge)	CPC	\$363

Base Options

Alternate Height Base (per column)	AH	\$66
Super Level Glides (per base)	GSL	n/c
Custom Top Plate Size	CTPS	Ⓛ
6" Column (powder coat)	COL6	Ⓛ



Top Options

Custom Size	CS	Ⓛ
Custom Shape	CSH	Ⓛ
Custom Radius Corner	CRC	Ⓛ
3" Radius Corner (per corner) (Corian®)	CRL3	\$34
Standard Powder Coat	use finish code	n/c
2" Umbrella Hole	UMB	\$248





\$			
1,019	934	1,111	1,643
1,507	1,236	1,500	2,813
1,978	1,594	1,952	3,831
2,664	2,020	2,497	5,129
3,545	2,489	3,092	6,588
4,713	3,038	3,786	-
5,977	3,639	4,551	-
1,021	849	1,002	1,814
1,512	1,131	1,359	2,759
1,985	1,476	1,795	3,768
2,697	1,905	2,329	5,079
3,620	2,400	2,945	6,578
1,263	995	1,178	2,312
1,557	1,118	1,334	2,683
-	1,768	2,121	4,378
1,777	1,281	1,548	3,246
2,055	1,454	1,764	3,763
2,329	1,631	1,983	4,250
3,038	2,097	2,535	5,359

Metal Tops



<p>Metal Solid</p>  <p>MES Solid</p>	<p>Metal Mesh</p>  <p>MEM Mesh</p>	<p>Stainless Steel</p>  <p>MSS Scalloped Pattern Inset Top</p>
---	---	---

Complete Table List Pricing

	Top Size	Base Height	Base Qty.	Model #	\$		
<p>Round</p> 	28	29	1	BI28RDOD	506	729	-
	36	29	1	BI36RDOD	633	922	-
	42	29	1	BI42RDOD	908	1233	-
	48	29	1	BI48RDOD	1219	1581	-
<p>Square</p> 	30 30	29	1	BI3030SQOD	634	821	-
	36 36	29	1	BI3636SQOD	854	1019	-
<p>Rectangle</p> 	24 30	29	1	BI2430REOD	592	818	-
	30 48	29	1	BI3048REOD	799	1028	-
<p>ADA Rectangle</p> 	23 39	29	2	BI2339REOD	836	-	-











How to Order

Table Model Number

BI	28	RD	OD	MES	MSL
Base Series	Top Size	Top Shape	Outdoor	Top Material	Finish

A BI28RDODMESMSL is an outdoor Bistro series 28" round table with a solid metal .75" thick top with a metal eased edge profile.

Specialty Tops

Acrylic	Corian Group A,B	Corian Group C,D	3form Chroma
 AAOP Opaque	 C1FL Flat	 C2FL Flat	 3FRB Reverse Bevel
 AATL Translucent	 C1BN Bullnose	 C2BN Bullnose	
	 C1PR Prism	 C2PR Prism	



Options

Base/Top Finish

Powder Coat	use finish code	n/c
-------------	-----------------	-----



Top Options

Standard Powder Coat	use finish code	n/c
2" Umbrella Hole (umbrella hole not available on ADA rectangle table)	UMB	\$50

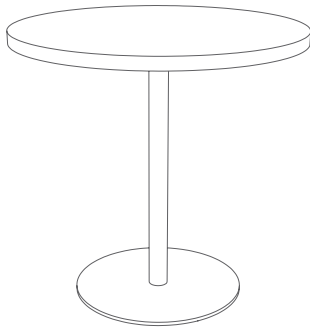

\$				
-	-	-	-	-
-	-	-	-	-
-	-	-	-	-
-	-	-	-	-
-	-	-	-	-
-	-	-	-	-
-	-	-	-	-
-	-	-	-	-
-	-	-	-	-
-	-	-	-	-
-	-	-	-	-
-	-	-	-	-
-	-	-	-	-

Metal Tops



<p>Metal Solid</p>  <p>MES Solid</p>	<p>Metal Mesh</p>  <p>MEM Mesh</p>	<p>Stainless Steel</p>  <p>MSS Scalloped Pattern Inset Top</p>
---	---	---









Complete Table List Pricing

	Top Size	Base Qty.	Model #	\$		
<p>Round</p> 	24	1	DIRDOD	-	-	-
	30	1	DI30RDOD	1,052	-	-
	36	1	DI36RDOD	1,297	-	-
	42	1	DI42RDOD	1,395	-	-
	48	1	DI48RDOD	1,613	-	-
	54	1	DI54RDOD	-	-	-
	60	1	DI60RDOD	-	-	-
<p>Square</p> 	24 24	1	DI2424SQOD	-	-	-
	30 30	1	DI3030SQOD	1,050	-	-
	36 36	1	DI3636SQOD	1,279	-	-
	42 42	1	DI4242SQOD	1,393	-	-
	48 48	1	DI4848SQOD	-	-	-
<p>Rectangle</p> 	24 30	1	DI2430REOD	986	-	-
	24 36	1	DI2436REOD	-	-	-
	24 60	2	DI2460REOD	-	-	-
	30 36	1	DI3036REOD	-	-	-
	30 42	1	DI3042REOD	-	-	-
	30 48	1	DI3048REOD	1,460	-	-
	30 60	2	DI3060REOD	-	-	-

How to Order

Table Model Number						Top Finish Selection	Options
DI Base Series	36 Top Size	RD Top Shape	OD Outdoor	MES Top Material	MSL Base Finish	MBK Top Finish	AH Alternate Height Base
<p>A DI36RDODMESMSL is an outdoor Disc series 36" round table with a silver powder coat round base and a metal .75" thick top with a metal eased edge profile.</p>						<p>The code: MBK specifies a black matte powder coat top.</p>	<p>The code: AH specifies alternate height base</p>

Specialty Tops

Acrylic	Corian Group A,B	Corian Group C,D	3form Chroma
 AAOP Opaque	 C1FL Flat	 C2FL Flat	 3FRB Reverse Bevel
 AATL Translucent	 C1BN Bullnose	 C2BN Bullnose	
	 C1PR Prism	 C2PR Prism	

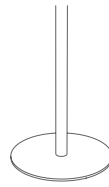

Options

Base Finishes

Standard Powder Coat	use finish code	n/c
Custom Powder Coat (set-up charge)	CPC	\$363

Base Options

Alternate Height Base (per column)	AH	\$66
Custom Top Plate Size	CTPS	🔗
6" Column (powder coat)	COL6	🔗



Top Options

Custom Size	CS	🔗
Custom Shape	CSH	🔗
Custom Radius Corner	CRC	🔗
3" Radius Corner (per corner) (Corian®)	CRL3	\$34
Standard Powder Coat	use finish code	n/c
2" Umbrella Hole	UMB	\$248

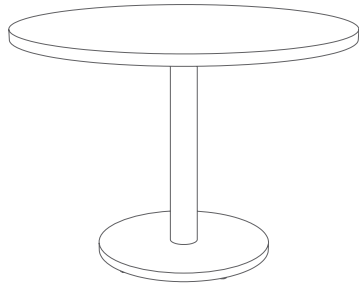

\$				
887	1,055	1,350	1,934	
1,310	1,225	1,698	3,074	
2,388	2,004	2,362	4,241	
3,039	2,395	2,872	5,504	
4,020	2,964	3,567	7,063	
-	3,448	4,196	-	
6,337	3,999	4,911	-	
1,312	1,140	1,293	2,105	
1,773	1,392	1,620	3,020	
2,395	1,886	2,205	4,178	
3,047	2,255	2,679	5,429	
4,030	2,810	3,355	6,988	
1,524	1,256	1,439	2,573	
1,967	1,528	1,744	3,093	
-	1,305	2,546	4,960	
2,187	1,691	1,958	3,656	
2,430	1,829	2,139	4,138	
2,804	2,106	2,458	4,725	
3,208	2,267	2,890	6,199	

Metal Tops



<p>Metal Solid</p>  <p>MES Solid</p>	<p>Metal Mesh</p>  <p>MEM Mesh</p>	<p>Stainless Steel</p>  <p>MSS Scalloped Pattern Inset Top</p>
---	---	--

Complete Table List Pricing

	Top Size	Base Qty.	Model #	\$		
<p>Round</p> 	24	1	FR24RDOD	-	-	-
	30	1	FR30RDOD	1,021	-	-
	36	1	FR36RDOD	1,207	-	-
	42	1	FR42RDOD	1,305	-	-
	48	1	FR48RDOD	1,398	-	-
	54	1	FR54RDOD	-	-	-
	60	1	FR60RDOD	-	-	-
<p>Square</p> 	24 24	1	FR2424SQOD	-	-	-
	30 30	1	FR3030SQOD	1,019	-	-
	36 36	1	FR3636SQOD	1,189	-	-
	42 42	1	FR4242SQOD	1,303	-	-
	48 48	1	FR4848SQOD	-	-	-
<p>Rectangle</p> 	24 30	1	FR2430REOD	955	-	-
	24 36	1	FR2436REOD	-	-	-
	24 60	2	FR2460REOD	-	-	-
	30 36	1	FR3036REOD	-	-	-
	30 42	1	FR3042REOD	-	-	-
	30 48	1	FR3048REOD	1,245	-	-
	30 60	2	FR3060REOD	-	-	-

How to Order









Table Model Number						Top Finish Selection	Options
FR Base Series	36 Top Size	RD Top Shape	OD Outdoor	AAOP Top Material	MAA Base Finish	AGL Top Finish	AH Alternate Height Base

A FR36RDODAAOP is an outdoor Flat Round series 36" round table with an anodized aluminum round base and an opaque acrylic top.

The code: AAOP specifies an acrylic top in Glacier

The code: AH specifies alternate height base

Specialty Tops

Acrylic	Corian Group A,B	Corian Group C,D	3form Chroma
 AAOP Opaque	 C1FL Flat	 C2FL Flat	 3FRB Reverse Bevel
 AATL Translucent	 C1BN Bullnose	 C2BN Bullnose	
	 C1PR Prism	 C2PR Prism	

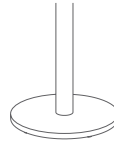

Options

Base Finishes

Standard Powder Coat	use finish code	n/c
Anodized Aluminum	MAA	\$44
Custom Powder Coat (set-up charge)	CPC	\$363

Base Options

Alternate Height Base (per column)	AH	\$66
Custom Top Plate Size	CTPS	Ⓛ
6" Column (powder coat)	COL6	Ⓛ

Top Options

Custom Size	CS	Ⓛ
Custom Shape	CSH	Ⓛ
Custom Radius Corner	CRC	Ⓛ
3" Radius Corner (per corner) (Corian®)	CRL3	\$34
Standard Powder Coat	use finish code	n/c
2" Umbrella Hole	UMB	\$248



\$			
1,279	1,194	1,371	1,903
1,737	1,466	1,730	3,043
2,298	1,914	2,272	4,151
2,949	2,305	2,782	5,414
3,805	2,749	3,352	6,848
-	3,333	4,081	-
6,222	3,884	4,796	-
1,281	1,109	1,262	2,074
1,742	1,361	1,589	2,989
2,305	1,796	2,115	4,088
2,957	2,165	2,589	5,339
3,915	2,695	3,240	6,873

1,493	1,225	1,408	2,542
1,777	1,338	1,554	2,903
-	2,288	2,641	4,898

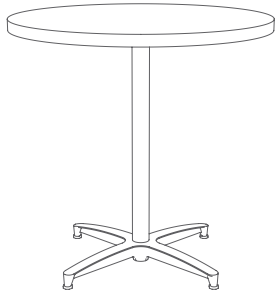

1,997	1,501	1,768	3,466
2,340	1,739	2,049	4,048
2,589	1,891	2,243	4,510
3,498	2,557	2,995	5,819

Metal Tops



<p>Metal Solid</p>  <p>MES Solid</p>	<p>Metal Mesh</p>  <p>MEM Mesh</p>	<p>Stainless Steel</p>  <p>MSS Scalloped Pattern Inset Top</p>
---	---	--









Complete Table List Pricing

	Top Size	Base Style	Base Qty.	Model #	\$		
<p>Round</p> 	24	24X	1	MAX24RDOD	-	-	-
	30	24X	1	MAX30RDOD	951	-	-
	36	30X	1	MAX36RDOD	1,167	-	-
	42	30X	1	MAX42RDOD	1,265	-	-
	48	36X	1	MAX48RDOD	1,458	-	-
	54	36X	1	MAX54RDOD	-	-	-
	60	36X	1	MAX60RDOD	-	-	-
<p>Square</p> 	24 24	24X	1	MAX2424SQOD	-	-	-
	30 30	24X	1	MAX3030SQOD	949	-	-
	36 36	30X	1	MAX3636SQOD	1,149	-	-
	42 42	30X	1	MAX4242SQOD	1,263	-	-
	48 48	36X	1	MAX4848SQOD	-	-	-
<p>Rectangle</p> 	24 30	24X	1	MAX2430REOD	885	-	-
	30 36	24X	1	MAX3036REOD	-	-	-
	30 42	30X	1	MAX3042REOD	-	-	-
	30 48	30X	1	MAX3048REOD	1205	-	-
	30 60	27V	2	MAV3060REOD	-	-	-

How to Order

Table Model Number						Top Finish Selection	Options
MAX Base Series	36 Top Size	RD Top Shape	OD Outdoor	3FRB Top Material	MAA Base Finish	FPW Top Finish	AH Alternate Height Base
<p>A MAX36RDOD3FRBMAA is an outdoor Mark IV series 36" round table with an anodized aluminum X-base and a 3Form outdoor top with a reverse bevel edge profile.</p>						<p>The code: specifies a 3form chroma top in Pewter.</p>	<p>The code: AH specifies alternate height base</p>

Specialty Tops

Acrylic	Corian Group A,B	Corian Group C,D	3form Chroma
 AAOP Opaque	 C1FL Flat	 C2FL Flat	 3FRB Reverse Bevel
 AATL Translucent	 C1BN Bullnose	 C2BN Bullnose	
	 C1PR Prism	 C2PR Prism	

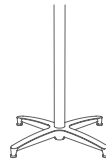

X Base

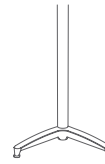

V Base

Options



Base Finishes

Standard Powder Coat	use finish code	n/c
Anodized Aluminum	MAA	\$44
Custom Powder Coat (set-up charge)	CPC	\$363

Base Options

Alternate Height Base (per column)	AH	\$66
------------------------------------	----	------



Top Options

Custom Size	CS	
Custom Shape	CSH	
Custom Radius Corner	CRC	
3" Radius Corner (per corner)	CRL3	\$34
(Corian®)		
Standard Powder Coat	use finish code	n/c

\$				
1,208	1,124	1,300	1,832	
1,667	1,395	1,659	2,973	
2,258	1,874	2,232	4,111	
2,909	2,265	2,742	5,374	
3,865	2,809	3,412	6,908	
-	3,293	4,041	-	
6,182	3,844	4,756	-	
1,210	1,039	1,192	2,004	
1,671	1,290	1,519	2,918	
2,265	1,756	2,075	4,048	
2,917	2,125	2,549	5,299	
3,875	2,655	3,200	6,833	
1,422	1,154	1,338	2,472	
1,926	1,430	1,698	3,396	
2,300	1,699	2,009	4,008	
2,549	1,851	2,203	4,470	
3,378	2,437	2,875	5,699	

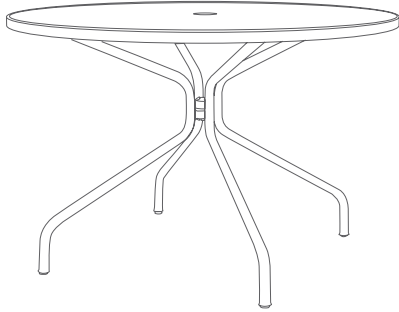
Metal Tops



<p>Metal Solid</p>  <p>MES Solid</p>	<p>Metal Mesh</p>  <p>MEM Mesh</p>	<p>Stainless Steel</p>  <p>MSS Scalloped Pattern Inset Top</p>
---	---	---

Complete Table List Pricing

	Top Size	Base Height	Base Qty.	Model #	\$		
Round	36	29	1	PK36RDOD	-	812	-
	48	29	1	PK48RDOD	-	1026	-



Includes 1.625" umbrella hole









How to Order

Table Model Number

PK	36	RD	OD	MEM	MSL
Base Series	Top Size	Top Shape	Outdoor	Top Material	Base & Top Finish

A PK36RDODMEMMSL is an outdoor Park series 36" round silver powder coat table with a metal mesh top.

Specialty Tops

Acrylic	Corian Group A,B	Corian Group C,D	3form Chroma
 AAOP Opaque	 C1FL Flat	 C2FL Flat	 3FRB Reverse Bevel
 AATL Translucent	 C1BN Bullnose	 C2BN Bullnose	
	 C1PR Prism	 C2PR Prism	



Options

Base/Top Finish

Standard Powder Coat

MSL (Silver)



n/c

\$

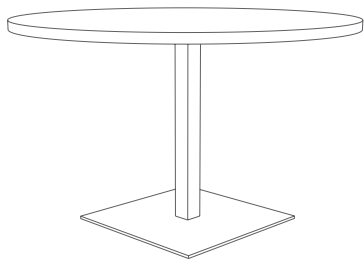

-	-	-	-
-	-	-	-

Metal Tops



<p>Metal Solid</p>  <p>MES Solid</p>	<p>Metal Mesh</p>  <p>MEM Mesh</p>	<p>Stainless Steel</p>  <p>MSS Scalloped Pattern Inset Top</p>
---	---	--









Complete Table List Pricing

	Top Size	Base Qty.	Model #	\$		
<p>Round</p> 	24	1	PL24RDOD	-	-	-
	30	1	PL30RDOD	1,052	-	-
	36	1	PL36RDOD	1,297	-	-
	42	1	PL42RDOD	1,395	-	-
	48	1	PL48RDOD	1,613	-	-
	54	1	PL54RDOD	-	-	-
	60	1	PL60RDOD	-	-	-
<p>Square</p> 	24 24	1	PL2424SQOD	-	-	-
	30 30	1	PL3030SQOD	1,050	-	-
	36 36	1	PL3636SQOD	1,279	-	-
	42 42	1	PL4242SQOD	1,393	-	-
	48 48	1	PL4848SQOD	-	-	-
<p>Rectangle</p> 	24 30	1	PL2430REOD	986	-	-
	24 36	1	PL2436REOD	-	-	-
	24 60	2	PL2460REOD	-	-	-
	30 36	1	PL3036REOD	-	-	-
	30 42	1	PL3042REOD	-	-	-
	30 42	1	PLD3042REOD	-	-	-
	30 48	1	PL3048REOD	1,460	-	-
	30 48	1	PLD3048REOD	1,528	-	-
	30 60	2	PL3060REOD	-	-	-

How to Order

Table Model Number						Top Finish Selection	Options
PL Base Series	36 Top Size	RD Top Shape	OD Outdoor	MES Top Material	MSL Base Finish	MBK Top Finish	AH Alternate Height Base
<p>A PL36RDODMESMSL is an outdoor Platform series 36" round table with a silver powder coat square base and a solid metal .75" thick top with a metal eased edge profile.</p>						<p>The code: MBK specifies a black matte powder coat top.</p>	<p>The code: AH specifies alternate height base</p>

Specialty Tops

Acrylic	Corian Group A,B	Corian Group C,D	3form Chroma
 AAOP Opaque	 C1FL Flat	 C2FL Flat	 3FRB Reverse Bevel
 AATL Translucent	 C1BN Bullnose	 C2BN Bullnose	
	 C1PR Prism	 C2PR Prism	

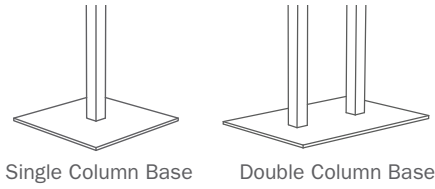

Options

Base Finishes

Standard Powder Coat	use finish code	n/c
Custom Powder Coat (set-up charge)	CPC	\$363

Base Options

Alternate Height Base (per column)	AH	\$66
Custom Top Plate Size	CTPS	Ⓛ



Top Options

Custom Size	CS	Ⓛ
Custom Shape	CSH	Ⓛ
Custom Radius Corner	CRC	Ⓛ
3" Radius Corner (per corner) (Corian®)	CRL3	\$34
2" Umbrella Hole	UMB	\$248



\$			
1,310	1,225	1,402	1,934
1,768	1,497	1,761	3,074
2,388	2,004	2,362	4,241
3,039	2,395	2,872	5,504
4,020	2,964	3,567	7,063
5,123	3,448	4,196	-
6,337	3,999	4,911	-
1,312	1,140	1,293	2,105
1,773	1,392	1,620	3,020
2,395	1,886	2,205	4,178
3,047	2,255	2,679	5,429
4,030	2,810	3,355	6,988
1,524	1,256	1,439	2,573
1,967	1,528	1,744	3,093
-	2,350	2,703	4,960
2,187	1,691	1,958	3,656
2,430	1,829	2,139	4,138
2,623	2,022	2,332	4,331
2,804	2,106	2,458	4,725
2,872	2,174	2,526	4,793
3,560	2,619	3,057	5,881

Metal Tops



<p>Metal Solid</p>  <p>MES Solid</p>	<p>Metal Mesh</p>  <p>MEM Mesh</p>	<p>Stainless Steel</p>  <p>MSS Scalloped Pattern Inset Top</p>
---	---	---

Complete Table List Pricing

	Top Size	Base Height	Base Qty.	Model #	\$		
<p>Round</p> 	24	29	1	SM24RDOD	-	-	294
	30	29	1	SM30RDOD	-	-	376
	36	29	1	SM36RDOD	-	-	422
<p>Round Standing Height</p> 	24	42	1	SM24RDOD42	-	-	422
	30	42	1	SM30RDOD42	-	-	498
<p>Square</p> 	24 24	29	1	SM2424SQOD	-	-	294
	30 30	29	1	SM3030SQOD	-	-	376

How to Order

Table Model Number

SM	24	RD	OD	42
Base Series	Top Size	Top Shape	Outdoor	Table Height









A SM24RDOD42MSS is an outdoor Sam series bar-height table with a 24" stainless steel top with scalloped pattern and a clear coated polished aluminum base.

Top Finish Selection

MSS
Top Finish

The code: MSS specify a stainless steel inset top with scalloped pattern.

Specialty Tops

Acrylic	Corian Group A,B	Corian Group C,D	3form Chroma
 AAOP Opaque	 C1FL Flat	 C2FL Flat	 3FRB Reverse Bevel
 AATL Translucent	 C1BN Bullnose	 C2BN Bullnose	
	 C1PR Prism	 C2PR Prism	



Options

Base Finish	
Clear Coated Polished Aluminum	n/c
Top Finish	
Stainless Steel Scalloped Pattern	MSS n/c



\$	-	-	-	-
	-	-	-	-
	-	-	-	-

	-	-	-	-
	-	-	-	-



	-	-	-	-
	-	-	-	-

Metal Tops



<p>Metal Solid</p>  <p>MES Solid</p>	<p>Metal Mesh</p>  <p>MEM Mesh</p>	<p>Stainless Steel</p>  <p>MSS Scalloped Pattern Inset Top</p>
---	---	---

Complete Table List Pricing

	Top Size	Base Qty.	Model #	\$		
<p>Round</p> 	24	1	TL18L24RDOD	-	-	-
	30	1	TL18M30RDOD	1,296	-	-
	36	1	TL18H36RDOD	1,452	-	-
	42	1	TL24M42RDOD	1,590	-	-
	48	1	TL24H48RDOD	1,798	-	-
	54	1	TL24XH54RDOD	-	-	-
<p>Square</p> 	24 24	1	TL18L2424SQOD	-	-	-
	30 30	1	TL18M3030SQOD	1,294	-	-
	36 36	1	TL18H3636SQOD	1,434	-	-
	42 42	1	TL24H4242SQOD	1,703	-	-
	48 48	1	TL24XH4848SQOD	-	-	-
<p>Rectangle</p> 	24 30	1	TL18M2430REOD	1,230	-	-
	24 36	1	TL18H2436REOD	-	-	-
	24 60	2	TL18L2460REOD	-	-	-
	30 36	1	TL18H3036REOD	-	-	-
	30 42	1	TL24M3042REOD	-	-	-
	30 48	1	TL24H3048REOD	1,645	-	-
	30 60	2	TL18M3060REOD	-	-	-

How to Order









Table Model Number						Top Finish Selection	Options
TL18H Base Series	36 Top Size	RD Top Shape	OD Outdoor	MES Top Material	MSL Base Finish	MBK Top Finish	AH Alternate Height Base

A TL18H36RDODMESMSL is an outdoor Tulip series 36" round table with a silver powder coat round base and a solid metal .75" thick top with a metal eased edge profile.

The code: MBK specifies a black matte powder coat top

The code: AH specifies alternate height base

Specialty Tops

Acrylic	Corian Group A,B	Corian Group C,D	3form Chroma
 AAOP Opaque	 C1FL Flat	 C2FL Flat	 3FRB Reverse Bevel
 AATL Translucent	 C1BN Bullnose	 C2BN Bullnose	
	 C1PR Prism	 C2PR Prism	

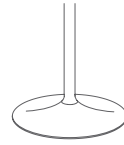

Options

Base Finishes

Standard Powder Coat	use finish code	n/c
Custom Powder Coat (set-up charge)	CPC	\$363

Base Options

Alternate Height Base (per column)	AH	\$66
Custom Top Plate Size	CTPS	Ⓛ

Top Options

Custom Size	CS	Ⓛ
Custom Shape	CSH	Ⓛ
Custom Radius Corner	CRC	Ⓛ
3" Radius Corner (per corner) (Corian®)	CRL3	\$34
Standard Powder Coat	use finish code	n/c

\$				
1,499	1,414	1,591	2,123	
2,012	1,741	2,005	3,318	
2,543	2,159	2,517	4,396	
3,234	2,590	3,067	5,699	
4,205	3,149	3,752	7,248	
5,343	3,668	4,416	-	
1,501	1,329	1,482	2,294	
2,017	1,636	1,864	3,264	
2,550	2,041	2,360	4,333	
3,357	2,565	2,989	5,739	
4,250	3,030	3,575	7,208	
1,768	1,500	1,683	2,817	
2,122	1,683	1,899	3,248	
-	2,728	3,081	5,338	
2,342	1,846	2,113	3,811	
2,625	2,024	2,334	4,333	
2,989	2,291	2,643	4,910	
4,048	3,107	3,545	6,369	

Chairs

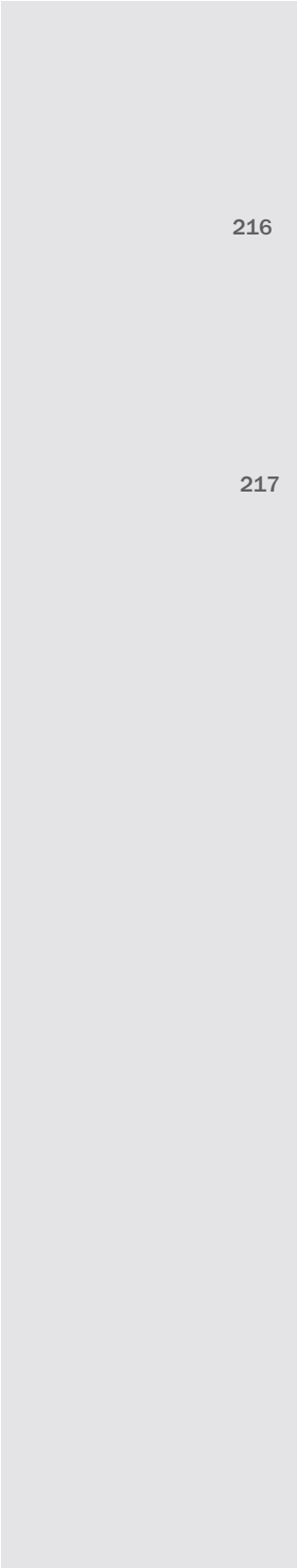

216 Breeze

Courtyard







Piazza



Picnic

Polly

217 Sam

Chairs | Outdoor

	Description	Chair Height	Model #	\$
Breeze	Arm Chair	32.25"	BZCA	282
	Standard Finish: Powder coated silver (MSL)			
Courtyard	Arm Chair	33"	CYCA	422
	Standard Finish: Powder coated silver (MSL)			
Piazza	Arm Chair	29.5"	PZCA	214
	Standard Finish: Clear coated polished aluminum frame with Black (RBK) or Honey (RHN) synthetic rattan woven seat and back			
Piazza	Bar Arm Chair	39"	PZCB	330
	Standard Finish: Clear coated polished aluminum frame with Black (RBK) or Honey (RHN) synthetic rattan woven seat and back			
Picnic	Arm Chair	31"	PCCA	526
	Standard Finish: Powder coated silver (MSL)			
Polly	Side Chair	31"	PLCS	330
	Standard Finish: Polypropylene white (PWH) Supplemental colors (minimum order and extended leadtime applicable) Ivory (PIV), Orange (POR), Red (PRD), Green (PGR)			

	Description	Chair Height	Model #	\$
Sam	Side Chair	30.5"	SMCS	169
	Standard Finish: Clear coated polished aluminum (MPA)			
Sam	Arm Chair	32.5"	SMCA	178
	Standard Finish: Clear coated polished aluminum (MPA)			
Sam	Bar Armchair	39"	SMCB	310
	Standard Finish: Clear coated polished aluminum (MPA)			



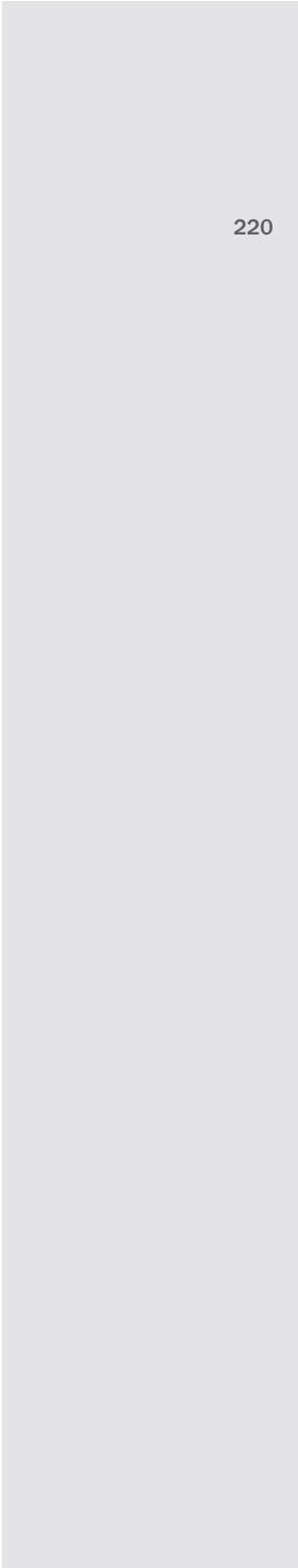



Base and Top Matrix







220

Base and Top Matrix







Base and Top Matrix



		Alumilite				Basic Round*							Boltdown				Capri		Corsica		Cozy Bar		
		AL2626X	AL3232X	AL3939X	AL26T	BA17L	BA17M	BA20M	BA22L	BA22M	BA22H	BA28H	BB	TB	JB	FB	CA15	CR15	CR24	CB17	CB20	CB22	
 Round	Dia																						
	24					1							1	1	1	1		1			1		
	30	1					1						1	1	1	1	1		1		1		
	36		1					1					1	1	1	1			1			1	
	42		1						1				1	1	1	1			1				1
	48			1						1			1	1	1	1			1				1
	54			1							1								1				
60			1								1								1				
 Oval	W L																						
	36 72																						
	42 54																						
	42 78																						
	42 84																						
	48 78																						
	48 96																						
 Racetrack	W L																						
	30 60																						
	30 72																						
	30 84																						
	30 96																						
	36 60																						
	36 72																						
	36 84																						
	36 96																						
	42 72																						
	42 84																						
	42 96																						
	48 96																						
	48 120																						
	48 144																						
	48 168																						
	60 120																						
60 144																							
60 168																							
 Extendo	W L Dia																						
	30 30 42		1						1												1		
	34 34 48			1						1											1		
	36 36 51			1							1										1		
	42 42 60			1								1									1		
 Square	W L																						
	24 24		1										1	1	1	1	1		1				
	30 30		1										1	1	1	1	1		1				
	36 36			1									1	1	1	1	1			1			
	42 42			1									1	1	1	1	1				1		
	48 48				1								1	1	1	1	1				1		
 Rectangle	W L																						
	18 48																						
	18 60																						
	18 72																						
	18 84																						
	18 96																						
	24 30		1										1	1	1	1	1		1				
	24 36												1	1	1	1	1			1			
	24 42												1	1	1	1	1				1		
	24 48												1	1	1	1	1				1		
24 60												2	2	2	2	2							

*Basic Round bases come in three weights, top size and material will determine weight of base.







			Alumilite				Basic Round*						Boltdown				Capri	Corsica		Cozy Bar			
			AL2626X	AL3232X	AL3939X	AL26T	BA17L	BA17M	BA20M	BA22L	BA22M	BA22H	BA28H	BB	TB	JB	FB	CA15	CR15	CR24	CB17	CB20	CB22
Rectangle 	W	L																					
	24	72					2							2	2	2	2						
	24	84																					
	24	96																					
	30	36		1					1					1	1	1	1				1		
	30	42		1						1				1	1	1	1				1		
	30	48		1							1			1	1	1	1				1		
	30	60				2		2						2	2	2	2						
	30	72				2		2						2	2	2	2						
	30	84																					
	30	96																					
	36	42									1			1	1	1	1				1		
	36	48										1		1	1	1	1				1		
	36	60				2			2					2	2	2	2						
	36	72				2			2					2	2	2	2						
	36	84																					
	36	96																					
	42	72																					
	42	84																					
	42	96																					
	48	96																					
	48	120																					
	48	144																					
	48	168																					
	60	120																					
	60	144																					
	60	168																					
Half Round 	R	L																					
	24	48																					
	30	60																					
	36	72																					
Arc Rectangle 	W	L																					
	30	60																					
	30	72																					
	30	84																					
	30	96																					
	36	60																					
	36	72																					
	36	84																					
	36	96																					
	42	72																					
	42	84																					
	42	96																					
	48	96																					
	48	120																					
	48	144																					
	48	168																					
60	120																						
60	144																						
60	168																						
Boat Shape 	W	C	L																				
	36	42	72																				
	36	48	84																				
	36	48	96																				
	36	48	120																				
	36	48	144																				





Base and Top Matrix

		Disc			Dunhill						Flat Round			Knobhill					Manhattan							
		DI18	DI22	DI26	DU1818X	DU2424X	DU3030X	DU3636X	DU3636XH	DU18T	DU24T	DU30T	DU30TT	DU36TT	FR18	FR22	FR26	KN18L	KN18M	KN18H	KN24M	KN24H	KN24XH	MH20	MH24	MH30
Round 	Dia																									
	24	1			1										1			1						1		
	30	1				1									1			1						1		
	36		1				1									1			1						1	
	42		1				1									1				1					1	
	48			1				1								1					1				1	
	54			1					1							1						1			1	
60			1					1								1						1			1	
Oval 	W L																									
	36 72	2								2					2											
	42 54	2								2					2											
	42 78		2							2						2										
	42 84		2							2						2										
	48 78			2								2					2									
	48 96			2								2					2									
Race- 	W L																									
	30 60	2								2					2											
	30 72	2								2					2											
	30 84	2								2					2											
	30 96	2								2					2											
	36 60		2								2				2											
	36 72		2								2				2											
	36 84		2								2				2											
	36 96		2								2				2											
	42 72		2									2				2										
	42 84		2									2				2										
	42 96		2									2				2										
	48 96			2									2			2										
	48 120			2										2		2										
	48 144			3										3		3										
	48 168			3										3		3										
	Extendo 	W L Dia																								
30 30 42			1			1									1				1					1		
34 34 48				1			1								1				1					1		
36 36 51				1			1								1					1				1		
42 42 60				1				1							1		1				1			1		
Square 		W L																								
		24 24	1				1									1				1					1	
	30 30	1				1									1				1					1		
	36 36		1				1								1				1					1		
	42 42		1					1							1				1					1		
	48 48			1				1							1		1			1				1		1
Rectangle 	W L																									
	18 48									2																
	18 60									2																
	18 72									2																
	18 84									2																
	18 96									2																
	24 30	1				1									1				1					1		
	24 36		1				1								1				1					1		
	24 42		1				1			2					1		1			1				1		
	24 48		1				1			2					1		1			1				1		
24 60	2								2					2		2										







		Disc			Dunhill						Flat Round			Knobhill						Manhattan							
		DI18	DI22	DI26	DU1818X	DU2424X	DU3030X	DU3636X	DU3636XH	DU18T	DU24T	DU30T	DU30TT	DU36TT	FR18	FR22	FR26	KN18L	KN18M	KN18H	KN24M	KN24H	KN24XH	MH20	MH24	MH30	
Rectangle 	W	L																									
	24	72	2							2					2												
	24	84	2							2					2												
	24	96	2							2					2												
	30	36		1			1								1				1						1		
	30	42		1							2					1				1					1		
	30	48			1			1			2					1					1				1		
	30	60	2								2					2											
	30	72	2								2					2											
	30	84	2								2					2											
	30	96	2								2					2											
	36	42		1								2				1					1				1		
	36	48			1							2				1						1				1	
	36	60		2								2				2											
	36	72		2								2				2											
	36	84		2								2				2											
	36	96		2									2			2											
	42	72			2								2				2										
	42	84			2								2				2										
	42	96			2								2				2										
	48	96			2									2			2										
	48	120			2									2			2										
	48	144			3									3			3										
	48	168			3									3			3										
	60	120			2									2			2										
	60	144			3									3			3										
60	168			3									3			3											
Half Round 	R	L																									
	24	48								2																	
	30	60									2																
	36	72										2															
Arc Rectangle 	W	L																									
	30	60	2								2					2											
	30	72	2									2				2											
	30	84	2									2				2											
	30	96	2									2				2											
	36	60		2									2			2											
	36	72		2									2			2											
	36	84		2									2			2											
	36	96		2										2		2											
	42	72		2										2		2											
	42	84		2										2		2											
	42	96		2										2		2											
	48	96			2										2		2										
	48	120			2										2		2										
	48	144			3										3		3										
	48	168			3										3		3										
60	120			2									2		2												
60	144			3									3		3												
60	168			3									3		3												
Boat Shape 	W	C	L																								
	36	42	72								2																
	36	48	84									2															
	36	48	96										2														
	36	48	120											2													
	36	48	144												3												
	36	48	168												3												





Base and Top Matrix

		Mark IV			Medici			Platform			Post Leg		Presidio										
		MA2424X	MA3030X	MA3636X	MA27V	MA18T	MA30T	ME18	PL18	PL22	PL26	PLD1826	P02.5"	P03"	PR1818X	PR2424X	PR3030X	PR3636X	PR18T	PR24T	PR30T	PR30TT	PR36TT
Round 	Dia																						
	24							1	1						1								
	30	1						1	1						1								
	36		1						1				4				1						
	42		1							1				4			1						
	48			1							1			4				1					
	54			1							1			4				1					
60			1							1			4				1						
Oval 	W L																						
	36 72				2								4									2	
	42 54						2							4								2	
	42 78						2							4								2	
	42 84						2							4								2	
	48 78						2							4									2
	48 96						2							4									2
Racetrack 	W L																						
	30 60				2				2				4								2		
	30 72				2				2				4								2		
	30 84				2				2				4								2		
	30 96				2				2				4								2		
	36 60				2					2			4									2	
	36 72				2					2			4									2	
	36 84				2					2			4									2	
	36 96				2					2			4										2
	42 72						2			2				4									2
	42 84						2			2				4									2
	42 96						2			2				4									2
	48 96						2				2			4									2
	48 120										2			6									2
	48 144										3			6									3
	48 168										3			6									3
	60 120										2			6									2
60 144										3			6									3	
60 168										3			6									3	
Extendo 	W L Dia																						
	30 30 42		1						1							1							
	34 34 48			1						1							1						
	36 36 51			1						1							1						
42 42 60			1						1							1							
Square 	W L																						
	24 24		1					1	1						1								
	30 30		1					1	1						1								
	36 36			1						1			4				1						
	42 42			1						1				4				1					
48 48			1							1			4				1						
Rectangle 	W L																						
	18 48					2													2				
	18 60					2													2				
	18 72					2													2				
	18 84					2													2				
	18 96					2													2				
	24 30		1					1	1							1							
	24 36			1						1							1						
	24 42			1		2				1	1						1	2					
	24 48					2				1	1						1	2					
24 60					2				2								2						







		Mark IV			Platform				Post Leg		Presidio												
		MA2424X	MA3030X	MA3636X	MA27V	MA18T	MA30T	PL18	PL22	PL26	PLD1826	P02.5"	P03"	PR1818X	PR2424X	PR3030X	PR3636X	PR18T	PR24T	PR30T	PR30TT	PR36TT	
Rectangle 	W																						
	L																						
	24	72							2										2				
	24	84							2										2				
	24	96							2										2				
	30	36	1								1					1							
	30	42									1		1							2			
	30	48									2							1		2			
	30	60									2			4						2			
	30	72									2			4						2			
	30	84									2			4						2			
	30	96									2			4						2			
	36	42			1							1		1	4							2	
	36	48			1							1	1	4								2	
	36	60									2			4							2		
	36	72									2			4							2		
	36	84									2			4							2		
	36	96									2			4							2		
	42	72										2		4									2
	42	84										2		4									2
	42	96										2		4									2
	48	96										2		4									2
	48	120											2	6									2
	48	144												3	6								3
	48	168												3	6								3
	60	120												2	6								2
60	144												3	6								3	
60	168												3	6								3	
Half Round 	R																						
	L																						
	24	48																	2				
30	60																		2				
36	72																			2			
Arc Rectangle 	W																						
	L																						
	30	60												4						2			
	30	72												4						2			
	30	84												4						2			
	30	96												4						2			
	36	60											2	4							2		
	36	72											2	4							2		
	36	84											2	4							2		
	36	96											2	4							2		
	42	72												2	4								2
	42	84												2	4								2
	42	96												2	4								2
	48	96												2	4								2
	48	120												2	6								2
	48	144												3	6								3
48	168												3	6								3	
60	120												2	6								2	
60	144												3	6								3	
60	168												3	6								3	
Boat Shape 	W																						
	C																						
	L																						
	36	42	72												4						2		
	36	48	84												4							2	
	36	48	96												4							2	
	36	48	120												6							2	
36	48	144												6							3		
36	48	168												6							3		





Base and Top Matrix

		Regency					Scala	Siena	Slimline						Spacesaver								
		RG2424X	RG3030X	RG3636X	RG2142S	RG2448S	SC19.5	SI25	SL1818X	SL2424X	SL3030X	SL3636X	SL18T	SL24T	SL30T	SL30TT	SL36TT	SV2222X	SV3030X	SV3636X	SV2430EX	SV18T	SV22T
Round 	Dia																						
	24						1		1									1					
	30	1					1	1		1								1					
	36		1				1	1			1								1				
	42		1				1	1			1								1				
	48			1				1				1								1			
	54			1								1								1			
60			1								1								1				
Oval 	W L																						
	36 72				1										2								
	42 54				1										2								
	42 78				1										2								
	42 84					1									2								
	48 78					1										2							
	48 96					1										2							
Racetrack 	W L																						
	30 60													2									
	30 72				1									2									
	30 84				1									2									
	30 96				1									2									
	36 60				1										2								
	36 72				1										2								
	36 84					1									2								
	36 96					1										2							
	42 72				1											2							
	42 84					1										2							
	42 96					1										2							
	48 96					1											2						
	48 120																2						
	48 144																3						
	48 168																3						
	60 120																	2					
60 144																	3						
60 168																	3						
Extendo 	W L Dia																						
	30 30 42		1				1	1		1								1					
	34 34 48			1			1	1			1								1				
	36 36 51			1				1			1								1				
	42 42 60			1							1								1				
Square 	W L																						
	24 24						1		1									1					
	30 30	1					1	1		1								1					
	36 36		1				1	1			1								1				
	42 42			1				1				1								1			
	48 48			1				1				1								1			
Rectangle 	W L																						
	18 48												2										
	18 60												2										
	18 72												2										
	18 84												2										
	18 96												2										
	24 30						1			1								1					
	24 36						1				1									1			
	24 42						1				1	2								1			
	24 48						1				1	2								1			
	24 60											2									2		

		Regency					Scala	Siena	Slimline						Spacesaver								
		RG2424X	RG3030X	RG3636X	RG2142S	RG2448S	SC19.5	SI25	SL1818X	SL2424X	SL3030X	SL3636X	SL18T	SL24T	SL30T	SL30TT	SL36TT	SV222X	SV3030X	SV3636X	SV2430EX	SV18T	SV22T
Rectangle	W L																						
	24 72										2												
	24 84										2											2	
	24 96										2												
	30 36						1	1	1												1		
	30 42						1	1				2									1		
	30 48		1				1	1		1		2									1		
	30 60											2											2
	30 72											2											2
	30 84											2											
	30 96											2											
	36 42						1	1					2								1		
	36 48						1	1					2								1		
	36 60												2										2
	36 72												2										2
	36 84												2										
	36 96													2									
	42 72														2								
	42 84														2								
	42 96														2								
	48 96															2							
	48 120																2						
	48 144																	3					
	48 168																		3				
	60 120																			2			
	60 144																				3		
	60 168																					3	
Half Round	R L																						
	24 48									2													
	30 60										2												
	36 72											2											
Arc Rectangle	W L																						
	30 60										2												
	30 72										2												
	30 84										2												
	30 96										2												
	36 60											2											
	36 72											2											
	36 84											2											
	36 96												2										
	42 72													2									
	42 84													2									
	42 96													2									
	48 96														2								
	48 120															2							
	48 144																3						
	48 168																	3					
	60 120																		2				
	60 144																			3			
60 168																				3			
Boat Shape	W C L																						
	36 42 72											2											
	36 48 84												2										
	36 48 96													2									
	36 48 120														2								
	36 48 144															3							
	36 48 168																3						

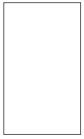
Base and Top Matrix

		Toscana		Tulip				Tuscan										
		TO24		TL18L	TL18M	TL18H	TL24M	TL24H	TL24XH	TU1818X	TU2424X	TU3030X	TU3636X	TU18T	TU24T	TU30T	TU30TT	TU36TT
Round 	Dia																	
	24									1								
	30	1			1						1							
	36	1				1						1						
	42	1					1					1						
	48							1					1					
	54								1					1				
60													1					
Oval 	W L																	
	36 72					2										2		
	42 54					2										2		
	42 78						2									2		
	42 84						2									2		
	48 78								2								2	
48 96								2								2		
Racetrack 	W L																	
	30 60					2									2			
	30 72					2									2			
	30 84					2									2			
	30 96					2									2			
	36 60						2									2		
	36 72						2									2		
	36 84						2									2		
	36 96						2										2	
	42 72							2									2	
	42 84							2									2	
	42 96							2									2	
	48 96								2									2
	48 120								2									2
	48 144								3									3
48 168								3									3	
60 120									2								2	
60 144									3								3	
60 168									3								3	
Extendo 	W L Dia																	
	30 30 42						1				1							
	34 34 48							1				1						
	36 36 51								1				1					
	42 42 60									1				1				
Square 	W L																	
	24 24					1				1								
	30 30	1				1					1							
	36 36	1					1					1						
	42 42	1						1					1					
48 48								1					1					
Rectangle 	W L																	
	18 48														2			
	18 60														2			
	18 72														2			
	18 84														2			
	18 96														2			
	24 30						1				1							
	24 36							1				1						
	24 42								1				1					
	24 48									1				1				
24 60										2					2			

		Toscana		Tulip						Tuscan									
		TO24		TL18L	TL18M	TL18H	TL24M	TL24H	TL24XH	TU1818X	TU2424X	TU3030X	TU3636X	TU18T	TU24T	TU30T	TU30TT	TU36TT	
Rectangle 	W																		
	L																		
	24	72																	
	24	84																	
	24	96																	
	30	36		1								1							
	30	42		1															
	30	48												1		2			
	30	60				2										2			
	30	72				2										2			
	30	84				2										2			
	30	96				2										2			
	36	42																2	
	36	48																2	
	36	60					2											2	
	36	72					2											2	
	36	84					2											2	
	36	96					2											2	
	42	72								1									2
	42	84								1									2
	42	96																	2
	48	96																	2
	48	120																	2
	48	144																	3
	48	168																	3
	60	120																	2
	60	144																	3
60	168																	3	
Half Round 	R																		
	L																		
	24	48																	2
	30	60																	2
36	72																	2	
Arc Rectangle 	W																		
	L																		
	30	60																	2
	30	72																	2
	30	84																	2
	30	96																	2
	36	60																	2
	36	72																	2
	36	84																	2
	36	96																	2
	42	72																	2
	42	84																	2
	42	96																	2
	48	96																	2
	48	120																	2
	48	144																	3
	48	168																	3
60	120																	2	
60	144																	3	
60	168																	3	
Boat Shape 	W																		
	C																		
	L																		
	36	42	72																2
	36	48	84																2
	36	48	96																2
	36	48	120																2
36	48	144																3	
36	48	168																3	

Base Only Pricing

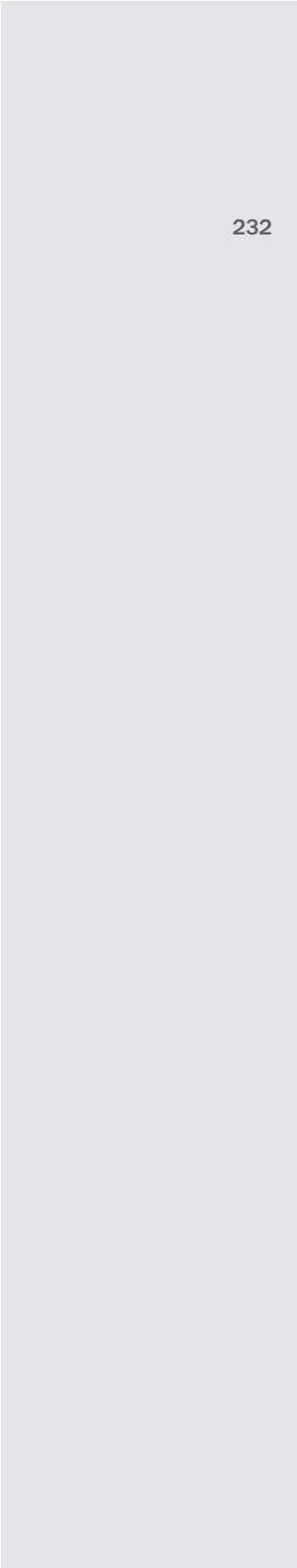

232

Base Only List Pricing

Base Only List Pricing

Base	Code	Base Model #	\$	Base Size	Base Style	Col. Dia.	Base Weight lbs.		
Alumiline	AL	AL2626X	360	26" x 26"	X	2.5"	20		
		AL3232X	450	32" x 32"	X	2.5"	22		
		AL3939X	655	39" x 39"	X	3"	30		
		AL26T	285	26"	T	2.5"	22		
Basic Round	BA	BA17L	145	17" dia.	Round	3"	35		
		BA17M	175	17" dia.	Round	3"	45		
		BA17H	205	17" dia.	Round	3"	55		
		BA20L	190	20" dia.	Round	3"	45		
		BA20M	205	20" dia.	Round	3"	55		
		BA20H	225	20" dia.	Round	3"	65		
		BA22L	200	22" dia.	Round	3"	55		
		BA22M	235	22" dia.	Round	3"	65		
		BA22H	270	22" dia.	Round	3"	75		
		BA28H	400	28" dia.	Round	3.5"	95		
		Boltdown	Beehive Base	BB	220	3" dia.	Boltdown	3"	10
				Trumpet Base	TB	220	3" dia.	Boltdown	3"
J Base	JB			220	3" dia.	Boltdown	3"	10	
Grout-in Base	GB			220	3" dia.	Grout-In	3"	10	
Florentine Base	FB			350	3" dia.	Boltdown	3"	15	
Capri	CA			CA15	317	15" dia	Florentine	N/A	35
		Corsica	CR	CR15	483	15" dia	Florentine	N/A	46
CR24	628			24" dia	Florentine	N/A	80		
Cozy Bar	CB	CB17	490	17" dia	Round	3"	45		
		CB20	550	20" dia	Round	3"	55		
		CB22	645	22" dia	Round	3"	65		
Disc	DI	DI18	435	18" dia	Round	2"	38		
		DI22	595	22" dia	Round	2"	62		
		DI26	720	26" dia	Round	3"	77		
Dunhill	DU	DU1818X	470	18" x 18"	X	2.25"	18		
		DU2424X	538	24" x 24"	X	2.25"	25		
		DU3030X	604	30" x 30"	X	2.5	34		
		DU3636X	670	36" x 36"	X	3"	42		
		DU3636XH	734	36" x 36"	XH	3"	50		
		DU18T	276	18"	T	2"	30		
		DU24T	308	24"	T	2.25"	34		
		DU30T	340	30"	T	2.25"	40		
		DU30TT	396	30"	TT	2.25"	44		
DU36TT	428	36"	TT	2.25"	62				
Flat Round	FR	FR18	370	18" dia.	Round	3"	46		

Continued on next page

*Polished/Satin Aluminum only available on Alumiline and Mark IV series

**Custom Powder Coat upcharge applied per order

Base Only Finish Upcharges

\$	Black Wrinkle	Powder Coat	Satin/Polished Chrome/Alu.*	Premium Plated	Custom Powder Coat**
-	-	standard	152	N/A	363
-	-	standard	152	N/A	363
-	-	standard	152	N/A	363
-	-	standard	75	N/A	182
standard	-	110	194	☉	363
standard	-	110	194	☉	363
standard	-	110	194	☉	363
standard	-	110	194	☉	363
standard	-	110	194	☉	363
standard	-	110	194	☉	363
standard	-	110	194	☉	363
standard	-	110	194	☉	363
standard	-	110	194	☉	363
-	-	standard	59	☉	363
-	-	standard	59	☉	363
-	-	standard	59	☉	363
-	-	standard	59	☉	363
-	-	standard	N/A	N/A	363
-	-	standard	N/A	N/A	363
-	-	standard	N/A	N/A	363
-	-	standard	N/A	N/A	363
standard	-	152	273	☉	363
standard	-	152	273	☉	363
standard	-	152	273	☉	363
-	-	standard	213	☉	363
-	-	standard	213	☉	363
-	-	standard	213	☉	363
-	-	standard	213	☉	363
-	-	standard	213	☉	363
-	-	standard	213	☉	363
-	-	standard	213	☉	363
-	-	standard	106	☉	182
-	-	standard	106	☉	182
-	-	standard	106	☉	182
-	-	standard	106	☉	182
-	-	standard	106	☉	182
-	-	standard	106	☉	182
-	-	standard	194	☉	363

Base Options

Alternate Height		
Alternate Height Base (per column)	AH	\$66
Alternate Height Florentine Base (per column)	AH	\$166
Glides		
Super Level	GSL	\$34
Powder Coated Puck (per table)	GPUPC	\$138
(Dunhill only - standard on Presidio)		
Polished or Satin Chrome Puck (per table)	GPUPL	\$166
(Dunhill only - standard on Presidio)		
Casters		
Locking Casters 2" Twin Wheel (qty. 4)	TWC2	\$56
(Dunhill, Mark IV, Slimline, Tuscan)		
Top Plate		
Custom Top Plate Size	CTPS	☉
6" Column (Basic Round, Disc or Flat Round)		
6" Column (black wrinkle and powder coat)	COL6	\$194
6" Column (polished or satin chrome)	COLP6	\$248
6" Column (premium plated)	COLPP6	☉
6" Column (vener)	COLV6	\$386
Footring (Basic Round, Flat Round, Bolt-down Series and Disc Only)		
Footring 14" (per base)	F014	\$220
Footring 19" (per base)	F019	\$248
Footring Finish: Polished or Satin Chrome only		
Outdoor Use		
Outdoor Undercoat (includes GSL)	PCO	\$56
(not available for Presidio)		
Tilt/Fold		
Tilt-top - (standard cable release)	TMX/TMT	\$270 X-base / \$418 T-base
For use on table bases with up to a 2.5" column diameter.		
The cable release mechanism activates both mechanisms on a table with two single column T-bases. It is not available on TT bases.		
Folding		
	FM	\$270 T-base
Folding table mechanism must be activated individually. The folding mechanism is available on Dunhill, Mark IV, Slimline and Tuscan T-bases only. It is not available on TT bases.		

Base Only List Pricing

Base	Code	Base Model #	\$	Base Size	Base Style	Col. Dia.	Base Weight lbs.
		FR22	490	22" dia.	Round	3.5"	70
		FR26	590	26" dia.	Round	3.5"	84
Knobhill	KN	KN18L	440	18" dia.	Round	2"	35
		KN18M	470	18" dia.	Round	2"	45
		KN18H	500	18" dia.	Round	2"	55
		KN24M	530	24" dia.	Round	2.25"	55
		KN24H	560	24" dia.	Round	2.25"	65
		KN24XH	600	24" dia.	Round	2.25"	75
Manhattan	MH	MH20	250	20" dia.	Round	3"	35
		MH24	300	24" dia.	Round	3.5"	45
		MH30	400	30" dia.	Round	4"	60
Mark IV	MA	MA2424X	340	24" x 24"	X	2"	10
		MA3030X	440	30" x 30"	X	2"	18
		MA3636X	540	36" x 36"	X	3"	24
		MA27V	320	27"	V	2"	26
		MA18T	265	18"	T	2"	20
		MA30T	365	30"	T	2"	28
Medici	ME	ME18	300	18" dia.	Florentine	N/A	30
Platform	PL	PL18	435	18" square	Sq.	2" Square	46
		PL22	595	22" square	Sq.	2" Square	65
		PL26	720	26" square	Sq.	3" Square	97
		PL1826	788	18" x 26"	Rectangle	2" Square	75
Post Leg	PO	PO1.5	145	1.5" dia.	Post	1.5"	4
		PO2.5	155	2.5" dia.	Post	2.5"	6
		PO3	165	3" dia.	Post	3"	7
Presidio	PR	PR1818X	925	18" x 18"	X	2.25"	25
		PR2424X	985	24" x 24"	X	2.25"	35
		PR3030X	1035	30" x 30"	X	2.25"	45
		PR3636X	1200	36" x 36"	X	3"	55
		PR18T	500	18"	T	2.25"	13
		PR24T	550	24"	T	2.25"	17
		PR30T	600	30"	T	2.25"	20
		PR30TT	650	30"	TT	2.25"	22
		PR36TT	735	36"	TT	2.25"	31
Regency	RG	RG2424X	860	24" x 24"	X -bar size 1/2"	2.5"	18
		RG3030X	930	30" x 30"	X -bar size 1/2"	2.5"	22
		RG3636X	1980	36" x 36"	X -bar size 1"	3.5"	60
		RG4848X	2500	48" x 48"	X -bar size 1"	3.5"	86
		RG2142S	2600	21" x 42"	Scissor -bar size 1"	3.5"	84
		RG2448S	2700	24" x 48"	Scissor -bar size 1"	3.5"	85
Scala	SC	SC19.5	600.6	19.5" dia	Florentine	N/A	74

Continued on next page

*Polished/Satin Aluminum only available on Alumiline and Mark IV series

**Custom Powder Coat upcharge applied per order

Base Only Finish Upcharges

\$	Black Wrinkle	Powder Coat	Satin/Polished Chrome/Alu.*	Premium Plated	Custom Powder Coat**
-	-	standard	194	🔒	363
-	-	standard	194	🔒	363
-	-	standard	194	🔒	363
-	-	standard	194	🔒	363
-	-	standard	194	🔒	363
-	-	standard	194	🔒	363
-	-	standard	194	🔒	363
-	-	standard	194	🔒	363
-	-	standard	N/A	N/A	363
-	-	standard	N/A	N/A	363
-	-	standard	N/A	N/A	363
-	-	standard	152	N/A	363
-	-	standard	152	N/A	363
-	-	standard	152	N/A	363
-	-	standard	75	N/A	182
-	-	standard	75	N/A	182
-	-	standard	75	N/A	182
-	-	standard	N/A	N/A	363
-	-	standard	213	🔒	363
-	-	standard	213	🔒	363
-	-	standard	213	🔒	363
-	-	standard	213	🔒	363
-	-	standard	62	🔒	363
-	-	standard	62	🔒	363
-	-	standard	62	🔒	363
-	-	standard	213	🔒	363
-	-	standard	213	🔒	363
-	-	standard	213	🔒	363
-	-	standard	213	🔒	363
-	-	standard	106	🔒	182
-	-	standard	106	🔒	182
-	-	standard	106	🔒	182
-	-	standard	106	🔒	182
-	-	standard	106	🔒	182
-	-	standard	106	🔒	182
-	-	standard	363	🔒	363
-	-	standard	363	🔒	363
-	-	standard	363	🔒	363
-	-	standard	363	🔒	363
-	-	standard	363	🔒	363
-	-	standard	363	🔒	363
-	-	standard	363	🔒	363
-	-	standard	N/A	N/A	363

Base Options

Alternate Height		
Alternate Height Base (per column)	AH	\$66
Alternate Height Florentine Base (per column)	AH	\$166
Glides		
Super Level	GSL	\$34
Powder Coated Puck (per table)	GPUPC	\$138
(Dunhill only - standard on Presidio)		
Polished or Satin Chrome Puck (per table)	GPUPL	\$166
(Dunhill only - standard on Presidio)		
Casters		
Locking Casters 2" Twin Wheel (qty. 4)	TWC2	\$56
(Dunhill, Mark IV, Slimline, Tuscan)		
Top Plate		
Custom Top Plate Size	CTPS	🔒
6" Column (Basic Round, Disc or Flat Round)		
6" Column (black wrinkle and powder coat)	COL6	\$194
6" Column (polished or satin chrome)	COLP6	\$248
6" Column (premium plated)	COLPP6	🔒
6" Column (vener)	COLV6	\$386
Footring (Basic Round, Flat Round, Bolt-down Series and Disc Only)		
Footring 14" (per base)	F014	\$220
Footring 19" (per base)	F019	\$248
Footring Finish: Polished or Satin Chrome only		
Outdoor Use		
Outdoor Undercoat (includes GSL)	PCO	\$56
(not available for Presidio)		
Tilt/Fold		
Tilt-top - (standard cable release)	TMX/TMT	\$270 X-base / \$418 T-base
For use on table bases with up to a 2.5" column diameter.		
The cable release mechanism activates both mechanisms on a table with two single column T-bases. It is not available on TT bases.		
Folding		
	FM	\$270 T-base
Folding table mechanism must be activated individually. The folding mechanism is available on Dunhill, Mark IV, Slimline and Tuscan T-bases only. It is not available on TT bases.		

Base Only List Pricing

Base	Code	Base Model #	\$	Base Size	Base Style	Col. Dia.	Base Weight lbs.
Siena	SI	SI25	466.2	25" dia.	Florentine	N/A	63
Slimline	SL	SL1818X	330	18" x 18"	X	1.75"	14
		SL2424X	385	24" x 24"	X	1.75"	15
		SL3030X	440	30" x 30"	X	1.75"	16
		SL3636X	525	36" x 36"	X	3.5"	21
		SL18T	225	18"	T	1.75"	23
		SL24T	240	24"	T	1.75"	25
		SL30T	275	30"	T	1.75"	26
		SL30TT	335	30"	TT	1.75"	32
		SL36TT	370	36"	TT	1.75"	33
Spacesaver	SV	SV2222X	130	22" x 22"	X	3"	20
		SV3030X	150	30" x 30"	X	3"	24
		SV3636X	265	36" x 36"	X	3.5"	35
		SV2430EX	160	24" x 30"	EX	3"	25
		SV18T	90	18"	T	3"	22
		SV22T	105	22"	T	3"	24
		Toscana	TO	T024	420	24" dia.	Florentine
Tulip	TL	TL18L	600	18" dia.	Round	2"	35
		TL18M	655	18" dia.	Round	2"	45
		TL18H	725	18" dia.	Round	2"	55
		TL24M	765	24" dia.	Round	2.25"	55
		TL24H	880	24" dia.	Round	2.25"	65
		TL24XH	915	24" dia.	Round	2.25"	75
Tuscan	TU	TU1818X	325	18" x 18"	X	2"	17
		TU2424X	380	24" x 24"	X	2"	20
		TU3030X	450	30" x 30"	X	2"	23
		TU3636X	520	36" x 36"	X	3"	24
		TU18T	200	18"	T	2"	16
		TU24T	235	24"	T	2"	18
		TU30T	265	30"	T	2"	20
		TU30TT	325	30"	TT	2"	29
TU36TT	360	36"	TT	2"	32		

Continued on next page

*Polished/Satin Aluminum only available on Alumiline and Mark IV series

**Custom Powder Coat upcharge applied per order

Base Only Finish Upcharges

\$	Black Wrinkle	Powder Coat	Satin/Polished Chrome/Alu.*	Premium Plated	Custom Powder Coat**
-		standard	N/A	N/A	363
-		standard	114	☉	363
-		standard	114	☉	363
-		standard	114	☉	363
-		standard	114	☉	363
-		standard	57	☉	182
-		standard	57	☉	182
-		standard	57	☉	182
-		standard	57	☉	182
-		standard	57	☉	182
standard		110	N/A	N/A	363
standard		110	N/A	N/A	363
standard		110	N/A	N/A	363
standard		110	N/A	N/A	363
standard		55	N/A	N/A	182
standard		55	N/A	N/A	182
-		standard	N/A	N/A	363
-		standard	194	☉	363
-		standard	194	☉	363
-		standard	194	☉	363
-		standard	194	☉	363
-		standard	194	☉	363
-		standard	194	☉	363
-		standard	114	☉	363
-		standard	114	☉	363
-		standard	114	☉	363
-		standard	114	☉	363
-		standard	57	☉	182
-		standard	57	☉	182
-		standard	57	☉	182
-		standard	57	☉	182

Base Options

Alternate Height		
Alternate Height Base (per column)	AH	\$66
Alternate Height Florentine Base (per column)	AH	\$166
Glides		
Super Level	GSL	\$34
Powder Coated Puck (per table)	GPUPC	\$138
(Dunhill only - standard on Presidio)		
Polished or Satin Chrome Puck (per table)	GPUPL	\$166
(Dunhill only - standard on Presidio)		
Casters		
Locking Casters 2" Twin Wheel (qty. 4)	TWC2	\$56
(Dunhill, Mark IV, Slimline, Tuscan)		
Top Plate		
Custom Top Plate Size	CTPS	☉
6" Column (Basic Round, Disc or Flat Round)		
6" Column (black wrinkle and powder coat)	COL6	\$194
6" Column (polished or satin chrome)	COLP6	\$248
6" Column (premium plated)	COLPP6	☉
6" Column (vener)	COLV6	\$386
Footring (Basic Round, Flat Round, Bolt-down Series and Disc Only)		
Footring 14" (per base)	F014	\$220
Footring 19" (per base)	F019	\$248
Footring Finish: Polished or Satin Chrome only		
Outdoor Use		
Outdoor Undercoat (includes GSL)	PCO	\$56
(not available for Presidio)		
Tilt/Fold		
Tilt-top - (standard cable release)	TMX/TMT	\$270 X-base / \$418 T-base
For use on table bases with up to a 2.5" column diameter.		
The cable release mechanism activates both mechanisms on a table with two single column T-bases. It is not available on TT bases.		
Folding		
	FM	\$270 T-base
Folding table mechanism must be activated individually. The folding mechanism is available on Dunhill, Mark IV, Slimline and Tuscan T-bases only. It is not available on TT bases.		

Base Only List Pricing

Base	Code	Base Model #	\$	Base Size	Base Style	Col. Dia.	Base Weight lbs.
Basic Round	BA	BA14LOD	215	14" dia.	Round	3"	35
		BA17LOD	220	17" dia.	Round	3"	45
		BA17MOD	250	17" dia.	Round	3"	55
		BA17HOD	275	17" dia.	Round	3"	45
		BA20LOD	235	20" dia.	Round	3"	55
		BA20MOD	260	20" dia.	Round	3"	65
		BA20HOD	290	20" dia.	Round	3"	55
		BA22LOD	295	22" dia.	Round	3"	65
		BA22MOD	320	22" dia.	Round	3"	75
		BA22HOD	385	22" dia.	Round	3"	95
		BA28HOD	435	28" dia.	Round	3"	95
Disc	DI	DI18OD	511	18" dia	Round	2"	38
		DI22OD	670	22" dia	Round	2"	62
		DI26OD	795	26" dia	Round	3"	77
Flat Round	FR	FR18OD	480	18" dia.	Round	3"	46
		FR22OD	580	22" dia.	Round	3.5"	70
		FR26OD	680	26" dia.	Round	3.5"	84
Mark IV	MA	MA2424XOD	410	24" x 24"	X	2"	10
		MA3030XOD	540	30" x 30"	X	2"	18
		MA3636XOD	640	36" x 36"	X	3"	24
		MA27VOD	420	27"	V	2"	26
		MA18TOD	365	18"	T	2"	20
		MA30TOD	465	30"	T	2"	28
Platform	PL	PL18OD	511	18" square	Square	2" Square	46
		PL22OD	670	22" square	Square	2" Square	65
		PL26OD	795	26" square	Square	3" Square	97
		PL1826	863	18" x 26"	Rectangle	2" Square	75
Tulip	TL	TL18LOD	700	18" dia.	Round	2"	35
		TL18MOD	755	18" dia.	Round	2"	45
		TL18HOD	825	18" dia.	Round	2"	55
		TL24MOD	865	24" dia.	Round	2.25"	55
		TL24HOD	980	24" dia.	Round	2.25"	65
		TL24XHOD	1015	24" dia.	Round	2.25"	75

*Polished/Satin Aluminum only available on Alumiline and Mark IV series

**Custom Powder Coat upcharge applied per order

Base Only Finish Upcharges

\$	Black Wrinkle	Powder Coat	Satin/Polished Chrome/Alu.*	Premium Plated	Custom Powder Coat**
	standard	110	N/A	N/A	363
	standard	110	N/A	N/A	363
	standard	110	N/A	N/A	363
	standard	110	N/A	N/A	363
	standard	110	N/A	N/A	363
	standard	110	N/A	N/A	363
	standard	110	N/A	N/A	363
	standard	110	N/A	N/A	363
	standard	110	N/A	N/A	363
	standard	110	N/A	N/A	363
	standard	110	N/A	N/A	363
	-	standard	N/A	N/A	363
	-	standard	N/A	N/A	363
	-	standard	N/A	N/A	363
	-	standard	N/A	N/A	363
	-	standard	N/A	N/A	363
	-	standard	N/A	N/A	363
	-	standard	N/A	N/A	363
	-	standard	N/A	N/A	363
	-	standard	N/A	N/A	182
	-	standard	N/A	N/A	182
	-	standard	N/A	N/A	182
	-	standard	N/A	N/A	363
	-	standard	N/A	N/A	363
	-	standard	N/A	N/A	363
	-	standard	N/A	N/A	363
	-	standard	N/A	N/A	363
	-	standard	N/A	N/A	363
	-	standard	N/A	N/A	363
	-	standard	N/A	N/A	363
	-	standard	N/A	N/A	363
	-	standard	N/A	N/A	363
	-	standard	N/A	N/A	363
	-	standard	N/A	N/A	363

Base Options

Alternate Height

Alternate Height Base (per column)	AH	\$66
Alternate Height Florentine Base (per column)	AH	\$166

Top Plate

Custom Top Plate Size	CTPS	
-----------------------	------	--

6" Column (Basic Round, Disc or Flat Round)

6" Column (powder coat)	COL6	
-------------------------	------	--

Top Only Pricing

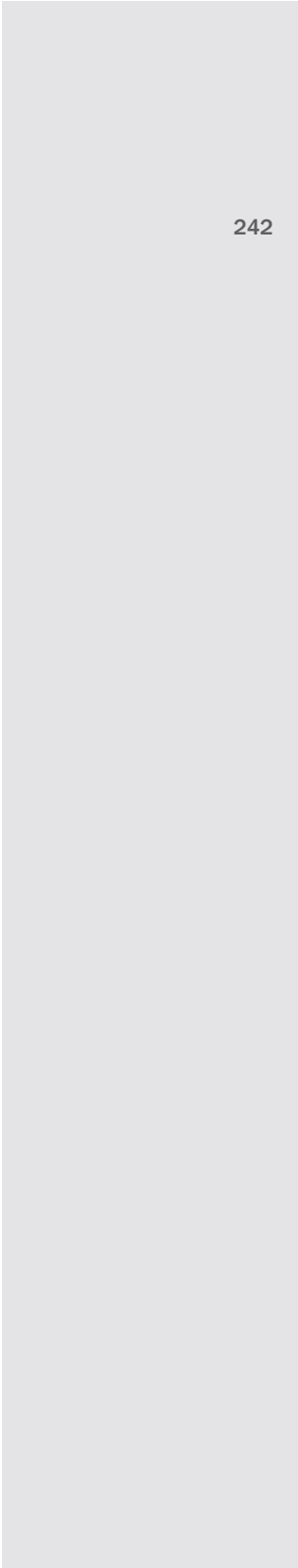

242

Top Only List Pricing

Laminate Tops

Wood Veneer Tops

Self Edge	Vinyl Edges	PVC Edges	Metal Edges	Wood Edges Group A	Wood Edges Group B	Wood Edges Group A	Wood Edges Group B
LLSE Self Edge	LVFL Flat	LPVC PVC	LMFL Flat	LWFL Flat	LWSQ Square	WWFL Flat	WWSQ Square
	LVBP Bumper		LMRB Ribbed	LWTP Tapered Ply	LWAR Arc	WWTP Tapered Ply	WWAR Arc
				LWFP Flat Ply	LWBN Bullnose	WWFP Flat Ply	WWBN Bullnose
					LWPR Prism		WWPR Prism
					LWPI Pivot		WWPI Pivot











Top Only List Pricing

	Top Size	Model #	\$							
	24	24RD	189	189	239	287	397	566	407	638
	30	30RD	249	249	311	344	510	691	510	778
	36	36RD	329	329	401	447	636	846	662	951
	42	42RD	430	430	510	510	752	1,010	846	1,136
	48	48RD	533	533	624	651	891	1,187	1,002	1,336
	54	54RD	644	644	749	778	1,107	1,718	1,245	1,932
	60	60RD	821	821	934	988	1,227	1,801	1,586	2,027
	36 72	3672OV	624	624	675	700	883	1,105	1,056	1,272
	42 54	4254OV	601	601	628	692	833	1,160	984	1,220
	42 78	4278OV	893	893	934	979	1,127	1,348	1,270	1,517
	42 84	4284OV	949	949	1,003	1,047	1,177	1,428	1,323	1,607
	48 78	4878OV	984	984	1,041	1,087	1,210	1,459	1,362	1,642
	48 96	4896OV	1,160	1,160	1,216	1,266	1,358	1,630	1,720	2,037
	30 60	3060RA	457	457	515	537	827	1,105	928	1,273
	30 72	3072RA	525	525	597	622	901	1,245	1,014	1,377
	30 84	3084RA	755	755	819	860	998	1,484	1,124	1,681
	30 96	3096RA	825	825	897	941	1,092	1,698	1,222	1,885
	36 60	3660RA	523	523	591	613	883	1,190	994	1,350
	36 72	3672RA	603	603	682	707	1,015	1,358	1,142	1,529
	36 84	3684RA	840	840	919	961	1,115	1,585	1,259	1,809
	36 96	3696RA	920	920	1,013	1,054	1,222	1,811	1,377	1,988
	42 72	4272RA	687	687	761	792	1,076	1,471	1,147	1,755
	42 84	4284RA	941	941	1,008	1,052	1,175	1,726	1,321	2,046
	42 96	4296RA	1,037	1,037	1,106	1,155	1,298	1,924	1,461	2,321
	48 96	4896RA	1,140	1,140	1,220	1,270	1,500	2,151	1,869	2,377
	48 120	48120RA	1,352	1,352	1,453	1,515	1,743	2,490	2,173	2,830
	48 144	48144RA	1,615	1,615	1,730	1,807	2,048	2,858	2,560	3,283
	48 168	48168RA	1,830	1,830	1,953	2,040	2,299	3,227	2,875	3,709
	60 120	60120RA	1,624	1,624	1,733	1,809	1,924	2,830	2,373	3,227
	60 144	60144RA	1,939	1,939	2,040	2,132	2,387	3,227	2,719	3,696
	60 168	60168RA	2,204	2,204	2,315	2,420	2,681	3,622	3,353	4,472

Continued on next page

*Three 36TT Bases required

Specialty Tops

Butcher Block	Ultrafoam	Acrylic	3form Chroma	3form Chroma Outdoor
 BBFL Flat	 ULFP PVC	 AAOP Opaque	 3FFL Flat	 3FRB Reverse Bevel
 BBBN Bullnose	 ULFR Raw	 AATL Translucent	 3FBN Bullnose	
			 3FPR Prism	

554	208	799	1,303	1,423
800	282	1,257	2,303	2,563
1,107	372	1,718	3,213	3,571
1,632	484	2,369	4,349	4,834
1,907	599	3,225	5,653	6,268
-	729	4,328	-	-
-	875	5,542	-	-
-	-	-	-	-
-	-	-	-	-
-	-	-	-	-
-	-	3,437	-	-
-	-	4,824	-	-
-	-	-	-	-
-	-	5,602	-	-
-	-	-	-	-
-	-	-	-	-
-	-	-	-	-
-	-	-	-	-
-	-	-	-	-
-	-	-	-	-
-	-	-	-	-
-	-	-	-	-
-	-	-	-	-
-	-	-	-	-
-	-	-	-	-
-	-	-	-	-
-	-	-	-	-
-	-	-	-	-
-	-	-	-	-
-	-	-	-	-
-	-	-	-	-
-	-	-	-	-
-	-	-	-	-
-	-	-	-	-
-	-	-	-	-

Options

Top Materials and Finishes

	use manufacturers finish code	n/c
Standard Laminates		
Premium Laminates	PRL	Ⓛ
Custom Wood Veneer	CWV	Ⓛ
Special Pattern Veneer	SPV	Ⓛ
Stain to Match (set-up charge)	STM	\$412

Top Options

Custom Size	CS	Ⓛ
Custom Shape	CSH	Ⓛ
Custom Radius Corner	CRC	Ⓛ
3" Radius Corner (per corner) (laminates self edge, ultrafoam, Corian®)	CRL3	\$34
3" Wood Radius Corner (per corner) (not available in LWFL, WWFL, LWPI and WWPI)	CRW3	\$82

Edge Options

1.75" Thick Edge (per table) (see edge details for specific profiles)	175E	15%
---	------	-----

Laminate Tops

Wood Veneer Tops











Self Edge	Vinyl Edges	PVC Edges	Metal Edges	Wood Edges Group A	Wood Edges Group B	Wood Edges Group A	Wood Edges Group B
LLSE Self Edge	LVFL Flat	LPVC PVC	LMFL Flat	LWFL Flat	LWSQ Square	WWFL Flat	WWSQ Square
	LVBP Bumper		LMRB Ribbed	LWTP Tapered Ply	LWAR Arc	WWTP Tapered Ply	WWAR Arc
				LWFP Flat Ply	LWBN Bullnose	WWFP Flat Ply	WWBN Bullnose
					LWPR Prism		WWPR Prism
					LWPI Pivot		WWPI Pivot

Top Only List Pricing

	Top Size		Dia.	Model #	\$							
	30	30	42	3042EX	951	-	-	-	2,237	2,717	2,350	3,085
	34	34	48	3448EX	1,079	-	-	-	2,377	3,056	2,490	3,425
	36	36	51	4251EX	1,159	-	-	-	2,548	3,227	2,661	3,595
	42	42	60	4260EX	1,401	-	-	-	2,920	3,509	3,001	3,877
Extendo available in LLSE, LWFL, LWSQ, WWFL, WWSQ, ULFP, ULFR Only												
	24	24		2424SQ	189	189	245	299	397	566	407	638
	30	30		3030SQ	249	249	317	364	510	691	510	778
	36	36		3636SQ	329	329	397	466	626	846	662	951
	42	42		4242SQ	418	418	494	543	752	1,010	846	1,136
	48	48		4848SQ	535	535	624	683	891	1,187	1,002	1,336
	18	48		1848RE	261	261	312	327	430	679	496	707
	18	60		1860RE	311	311	371	389	510	792	574	850
	18	72		1872RE	358	358	424	445	594	906	662	992
	18	84		1884RE	510	510	562	594	739	1,047	833	1,177
	18	96		1896RE	594	594	641	679	796	1,160	895	1,282
	24	30		2430RE	218	218	265	277	458	644	539	724
	24	36		2436RE	247	247	299	313	521	702	587	790
	24	42		2442RE	280	280	325	340	562	761	632	856
	24	48		2448RE	315	315	371	389	634	856	714	961
	24	60		2460RE	377	377	437	458	718	971	807	1,091
	24	72		2472RE	435	435	505	529	815	1,105	918	1,243
	24	84		2484RE	652	652	717	757	897	1,385	1,010	1,560
	24	96		2496RE	710	710	781	825	979	1,506	1,101	1,696
	30	36		3036RE	292	292	337	352	574	772	646	868
	30	42		3042RE	327	327	379	397	669	891	751	1,002
	30	48		3048RE	364	364	420	440	714	955	805	1,074
	30	60		3060RE	445	445	509	533	825	1,101	928	1,237
	30	72		3072RE	513	513	590	617	901	1,214	1,015	1,364
	30	84		3084RE	745	745	811	856	996	1,484	1,119	1,667
	30	96		3096RE	815	815	888	936	1,091	1,657	1,227	1,862
36	42		3642RE	375	375	434	453	724	969	817	1,089	
36	48		3648RE	415	415	477	498	778	1,039	875	1,167	
36	60		3660RE	510	510	583	607	883	1,179	994	1,327	

Continued on next page

Specialty Tops

Butcher Block	Ultrafoam	Acrylic	3form Chroma	3form Chroma Outdoor
 BBFL Flat	 ULFP PVC	 AAOP Opaque	 3FFL Flat	 3FRB Reverse Bevel
 BBBN Bullnose	 ULFR Raw	 AATL Translucent	 3FBN Bullnose	
			 3FPR Prism	

-	712	-	-	-
-	817	-	-	-
-	879	-	-	-
-	1,089	-	-	-
-				
624	222	801	1,270	1,594
893	282	1,262	2,258	2,509
1,225	372	1,725	3,161	3,508
1,817	473	2,377	4,285	4,759
2,123	601	3,235	5,592	6,193
-				
792	290	-	-	-
860	350	-	-	-
973	403	-	-	-
1,132	581	-	-	-
1,245	636	-	-	-
-				
741	241	1,013	1,852	2,062
875	276	1,297	2,179	2,423
1,069	312	1,422	2,515	2,794
1,124	352	1,607	2,848	3,162
1,373	424	-	3,560	3,938
1,624	492	-	4,225	4,675
1,807	684	-	-	-
1,990	752	-	-	-
-				
1,045	325	1,517	2,686	2,986
1,290	367	1,760	3,124	3,468
1,350	410	2,009	3,552	3,930
1,648	502	2,538	4,388	4,859
1,953	581	3,280	5,260	5,825
2,136	786	-	-	-
2,319	868	-	-	-
-				
1,504	422	-	3,721	4,119
1,570	471	2,412	4,227	4,682
1,916	576	3,280	5,268	5,836

Options

Top Materials and Finishes		
Standard Laminates	use manufacturers finish code	n/c
Premium Laminates	PRL	Ⓛ
Custom Wood Veneer	CWV	Ⓛ
Special Pattern Veneer	SPV	Ⓛ
Stain to Match (set-up charge)	STM	\$412
Top Options		
Custom Size	CS	Ⓛ
Custom Shape	CSH	Ⓛ
Custom Radius Corner	CRC	Ⓛ
3" Radius Corner (per corner)	CRL3	\$34
(laminated self edge, ultrafoam, Corian®)		
3" Wood Radius Corner (per corner)	CRW3	\$82
(not available in LWFL, WWFL, LWPI and WWPI)		
Edge Options		
1.75" Thick Edge (per table)	175E	15%
(see edge details for specific profiles)		

Laminate Tops

Wood Veneer Tops











Self Edge	Vinyl Edges	PVC Edges	Metal Edges	Wood Edges Group A	Wood Edges Group B	Wood Edges Group A	Wood Edges Group B
LLSE Self Edge	LVFL Flat	LPVC PVC	LMFL Flat	LWFL Flat	LWSQ Square	WWFL Flat	WWSQ Square
	LVBP Bumper		LMRB Ribbed	LWTP Tapered Ply	LWAR Arc	WWTP Tapered Ply	WWAR Arc
				LWFP Flat Ply	LWBN Bullnose	WWFP Flat Ply	WWBN Bullnose
					LWPR Prism	WWPR Prism	WWPR Prism
					LWPI Pivot	WWPI Pivot	WWPI Pivot

Top Only List Pricing

	Top Size	Model #	\$								
Rectangle 	36	72	3672RE	593	593	670	698	1,011	1,346	1,136	1,515
	36	84	3684RE	838	838	907	953	1,115	1,581	1,255	1,778
	36	96	3696RE	920	920	1,003	1,047	1,220	1,755	1,373	1,974
	42	72	4272RE	677	677	742	775	1,076	1,471	1,147	1,564
	42	84	4284RE	933	933	1,003	1,052	1,190	1,698	1,426	2,011
	42	96	4296RE	1,027	1,027	1,104	1,157	1,311	1,924	1,568	2,054
	48	96	4896RE	1,138	1,138	1,213	1,268	1,496	2,151	1,869	2,356
	48	120	48120RE	1,350	1,350	1,448	1,515	1,739	2,377	2,173	2,661
	48	144	48144RE	1,595	1,595	1,690	1,770	2,015	2,661	2,517	3,052
	48	168	48168RE	1,823	1,823	1,923	2,015	2,246	2,943	2,807	3,378
	60	120	60120RE	1,611	1,611	1,703	1,784	1,959	2,603	2,377	3,001
	60	144 *	60144RE	1,891	1,891	1,994	2,091	2,358	2,943	2,947	3,469
60	168 *	60168RE	2,200	2,200	2,273	2,385	2,641	3,567	3,301	4,246	
Half Round 	24	48	2448HR	323	323	373	389	513	766	576	813
	30	60 *	3060HR	458	458	526	549	667	963	751	1,097
	36	72 *	3672HR	609	609	690	716	833	1,190	1,041	1,303
Arc Rectangle 	30	60	3060AR	458	458	513	535	792	1,105	928	1,249
	30	72	3072AR	549	549	599	624	906	1,303	1,014	1,377
	30	84	3084AR	727	727	808	848	996	1,445	1,122	1,681
	30	96	3096AR	800	800	887	930	1,105	1,642	1,222	1,885
	36	60	3660AR	543	543	585	607	883	1,245	994	1,350
	36	72	3672AR	646	646	694	720	1,008	1,416	1,136	1,529
	36	84	3684AR	825	825	910	951	1,115	1,585	1,255	1,784
	36	96	3696AR	910	910	1,003	1,043	1,222	1,839	1,377	1,988
	42	72	4272AR	792	792	814	850	1,076	1,522	1,147	1,811
	42	84	4284AR	920	920	1,003	1,047	1,163	1,784	1,426	2,072
	42	96	4296AR	1,017	1,017	1,104	1,152	1,303	1,982	1,568	2,321

Continued on next page
 *Three 36TT Bases required

Specialty Tops

<p>Butcher Block</p>  <p>BBFL Flat</p>  <p>BBBN Bullnose</p>	<p>Ultrafoam</p>  <p>ULFP PVC</p>  <p>ULFR Raw</p>	<p>Acrylic</p>  <p>AAOP Opaque</p>  <p>AATL Translucent</p>	<p>3form Chroma</p>  <p>3FFL Flat</p>  <p>3FBN Bullnose</p>  <p>3FPR Prism</p>	<p>3form Chroma Outdoor</p>  <p>3FRB Reverse Bevel</p>
---	---	--	---	---























2,268	671	3,863	6,254	6,931
2,618	891	5,079	-	-
2,963	988	5,415	-	-
-	764	-	-	-
-	996	-	-	-
-	1,107	6,162	-	-
-	1,228	-	-	-
-	-	-	-	-
-	-	-	-	-
-	-	-	-	-
-	-	-	-	-
-	-	-	-	-
-	-	-	-	-
-	-	-	-	-
-	-	-	-	-
-	-	-	-	-
-	-	-	-	-
-	-	-	-	-
-	-	-	-	-
-	-	-	-	-
-	-	-	-	-
-	-	-	-	-
-	-	-	-	-
-	-	-	-	-
-	-	-	-	-
-	-	-	-	-
-	-	-	-	-
-	-	-	-	-
-	-	-	-	-
-	-	-	-	-
-	-	-	-	-
-	-	-	-	-
-	-	-	-	-
-	-	-	-	-
-	-	-	-	-

Options



Top Materials and Finishes		
Standard Laminates	use manufacturers finish code	n/c
Premium Laminates	PRL	Ⓛ
Custom Wood Veneer	CWV	Ⓛ
Special Pattern Veneer	SPV	Ⓛ
Stain to Match (set-up charge)	STM	\$412
Top Options		
Custom Size	CS	Ⓛ
Custom Shape	CSH	Ⓛ
Custom Radius Corner	CRC	Ⓛ
3" Radius Corner (per corner) (laminate self edge, ultrafoam, Corian®)	CRL3	\$34
3" Wood Radius Corner (per corner) (not available in LWFL, WWFL, LWPI and WWPI)	CRW3	\$82
Edge Options		
1.75" Thick Edge (per table) (see edge details for specific profiles)	175E	15%

Laminate Tops

Wood Veneer Tops

Self Edge	Vinyl Edges	PVC Edges	Metal Edges	Wood Edges Group A	Wood Edges Group B	Wood Edges Group A	Wood Edges Group B
 LLSE Self Edge	 LVFL Flat	 LPVC PVC	 LMFL Flat	 LWFL Flat	 LWSQ Square	 WWFL Flat	 WWSQ Square
	 LVBP Bumper		 LMRB Ribbed	 LWTP Tapered Ply	 LWAR Arc	 WWTP Tapered Ply	 WWAR Arc
				 LWFP Flat Ply	 LWBN Bullnose	 WWFP Flat Ply	 WWBN Bullnose
					 LWPR Prism		 WWPR Prism
					 LWPI Pivot		 WWPI Pivot

Top Only List Pricing

	Top Size		Model #	\$								
Arc Rectangle 	48	96	4896AR	1,160	1,160	1,214	1,264	1,496	2,208	1,869	2,435	
	48	120	48120AR	1,334	1,334	1,453	1,515	1,739	2,548	2,173	2,830	
	48	144 *	48144AR	1,574	1,574	1,696	1,770	2,056	2,916	2,568	3,342	
	48	168 *	48168AR	1,796	1,796	1,923	2,007	2,301	3,396	2,877	3,745	
Boat Shape 	60	120	60120AR	1,597	1,597	1,742	1,819	1,982	2,858	2,402	3,204	
	60	144 *	60144AR	1,883	1,883	2,027	2,118	2,437	3,283	2,741	3,954	
	60	168 *	60168AR	2,159	2,159	2,305	2,410	2,725	3,680	3,064	4,344	
	36	42	72	3672BS	1,011	1,011	976	1,023	1,257	1,681	1,416	1,893
	36	48	84	3684BS	1,126	1,126	1,191	1,247	1,552	1,947	1,747	2,194
	36	48	96	3696BS	1,245	1,245	1,309	1,366	1,718	2,065	1,934	2,323
	36	48	120	36120BS	1,482	1,482	1,559	1,630	2,101	2,334	2,365	2,626
36	48	144 *	36144BS	1,741	1,741	1,830	1,916	2,577	2,817	2,898	3,169	
36	48	168 *	36168BS	1,967	1,967	2,079	2,177	2,912	3,038	3,276	3,418	

*Three 30TT Bases required

Specialty Tops

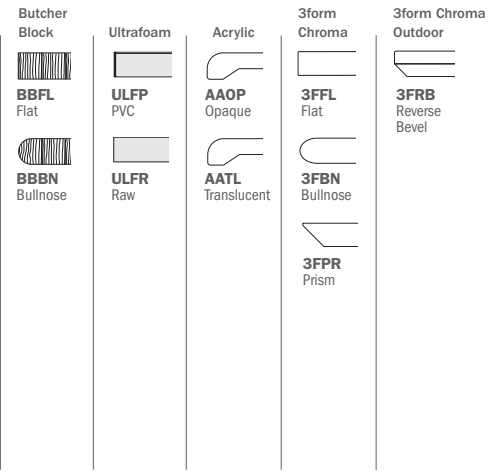

-	-	-	-	-
-	-	-	-	-
-	-	-	-	-
-	-	-	-	-
-	-	-	-	-
-	-	-	-	-
-	-	-	-	-
-	-	-	-	-
-	-	-	-	-
-	-	-	-	-
-	-	-	-	-
-	-	-	-	-
-	-	-	-	-
-	-	-	-	-
-	-	-	-	-
-	-	-	-	-

Options

Top Materials and Finishes		
Standard Laminates	use manufacturers finish code	n/c
Premium Laminates	PRL	Ⓛ
Custom Wood Veneer	CWV	Ⓛ
Special Pattern Veneer	SPV	Ⓛ
Stain to Match (set-up charge)	STM	\$412
Top Options		
Custom Size	CS	Ⓛ
Custom Shape	CSH	Ⓛ
Custom Radius Corner	CRC	Ⓛ
3" Radius Corner (per corner) (laminate self edge, ultrafoam, Corian®)	CRL3	\$34
3" Wood Radius Corner (per corner) (not available in LWFL, WWFL, LWPI and WWPI)	CRW3	\$82
Edge Options		
1.75" Thick Edge (per table)	175E	15%
(see edge details for specific profiles)		

Options

Base Options

AH **Alternate Height Base** **\$66**

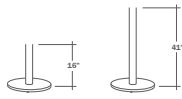

WCI table bases are available in a custom height within the range of 16" - 41" (per column). Alternate height Florentine bases are \$166.

GSL **Super Level Glides** **\$34**



Overall height of .75" is recommended for use on uneven or hard surface floors. Eliminates table wobble by automatically self-leveling. Adjusts up to .25" of wobble. Super level glides will not affect the overall height of the table. Super Level Glides are not available on Disc or Platform series. Sold in set of 5 (per base).

GPUPC & GPUPL **Puck Style Glides** **PC \$80**
PL \$80



Puck style glides are included on the Presidio base and can be specified on the Dunhill base. The Puck style glide is .375" thick with a 2.5" diameter and can be powder coated (**GPUPC**) or polished/satin chrome (**GPUPL**) (per each).

FFG **Floor Fastener** **\$34**



Cast iron, mounted inside post leg column with set screw; fastener to attach leg to floor is not included. Available for 2.5" and 3" diameter Post Leg columns only (per leg).

TWC2 **Casters 2" Twin Wheel** **\$56**



Twin wheel casters are 2" diameter black nylon with a black nylon hood and locking tab. Casters will not affect the overall height of the table. Casters are available on Dunhill, Mark IV, Post Leg, Slimline and Tuscan series. Sold in set of 4.

TMX/TMT **Tilt-top with Standard Cable Release** **X-base \$270**
T-base \$418

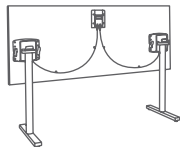

For use on table bases with up to a 2.5" column diameter. The cable release mechanism activates both mechanisms on a table with two single column T-bases. It is not available on TT bases or Post Leg.

FM **Folding Mechanism** **T-base \$270**

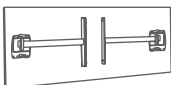

Folding table mechanism must be activated individually. The folding mechanism is available on Dunhill, Mark IV, Slimline and Tuscan T-bases only. It is not available on TT bases or Post Leg. For use on tables bases with up to a 2.5" column diameter.

Top Options

CS **Custom Size/Shape**

WCI can manufacture many different size and shape tops; please call customer service 800-243-3150 for more information

CRC **Custom Radius Corner**

WCI can manufacture specific custom radius corners; please call customer service 800-243-3150 for more information

CRL3 **3" Radius Corner** **\$34**

3" Radius corners are available on laminate tops with a self-edge, also available on Ultrafoam and Corian® tops. (per corner)

CRW3 **3" Wood Radius Corner** **\$82**

3" Radius corners are available on laminate tops with wood edges. Not available in LWFL, WWFL, LWPI, WWPI (per corner)

UMB **2" Umbrella Hole** **\$248**

Available on Outdoor Basic Round, Bistro, Flat Round, Disc, Park and Platform tables only (per table).

Edge Options

175E **1.75" Thick Edge** **15%**

The 1.75" thick edge is built-up on a 1.25" thick top. Available on a self edge laminate, square wood edge, flat wood edge, or a bullnose wood edge profile (per table).

Grommets

GMBK, GMSC
& GMPC

2" Round Metal Grommet \$138

Matte black (GMBK), Satin chrome (GMSC)
Polished chrome (GMPC)

GPMBK

2" Round Plastic Grommet \$44



Matte black (GPMBK)

Modesty Panel

MODLFX & MODVFX

Fixed Modesty Panel

LFX \$248

VFX \$386



.75" thick x 9" high. Specify to match the width of the table. Laminate fixed modesty panel (MODLFX) has a black flat T-mold edge with 1" radius corners. Veneer fixed modesty panel (MODVFX) has a matching .125" thick flat wood edge with square corners.

MODLFL & MODVFL

Folding Modesty Panel

LFL \$330

VFL \$468



.75" thick x 9" high. Specify to match the width of the table. Laminate folding modesty panel (MODLFL) has a black flat T-mold edge with 1" radius corners. Veneer folding modesty panel (MODVFL) has a matching .125" thick flat wood edge with square corners. The folding bracket is 10 gauge steel with a matte black finish.

Ganging Clips

GC

Ganging Clips

\$148

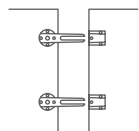

Connects two table tops for use as one large table. Friction and bolt release allows for quick separation. Set includes two clips and two brackets. One set is recommended per table side.

Wire Management

WMJ

Black Plastic J-Trough 48" long \$116



Under table mounted J-trough provides concealed cable management. Matte black plastic, attachment hardware not included.

WML

Legway Wire Manager 26" \$56



Vertical trough provides concealed cable management. Matte black plastic, attachment adhesive included.

Data and Power

DPBS2

Recessed Power and Data Module Two \$396



Recessed table top unit with 2 receptacles, 15amp circuit breaker, 3rd receptacle on the bottom, 1 cut-out for telecom plate (telecom plate not included); includes a 6' cord (DPBS). Available in matte black (MBK) or satin aluminum (MSA)

DPBS4

Recessed Power and Data Module Four \$688



Recessed table top unit with 4 receptacles, 15amp circuit breaker, 4 cut-outs for telecom plates (telecom plates not included); includes a 6' cord (DPBS) Available in matte black (MBK) or satin aluminum (MSA)

DPAS2

Retractable Power and Data Module Two \$606



Retractable table top unit with a fluid, one touch door that remains open during use. Includes 2 receptacles and 2 data openings (data jack and couplers not included) (DPAS2). Available in satin aluminum (MSA)

DPAS3

Retractable Power and Data Module Three \$688

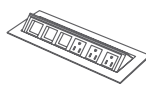

Retractable table top unit with a fluid, one touch door that remains open during use. Includes 3 receptacles and 3 data openings (data jack and couplers not included). (DPAS2) Available in satin aluminum (MSA)

DPUS2

Undermount Power and Data Module Two \$358



Under table mounted unit with 2 receptacles and 1 cut-out for telecom plate (telecom plate not included). includes 9' cord (DPUS2) Available in matte black (MBK)

Other

TTRK

Table Truck for Folding Tables \$1512



Table Truck for folding tables, 34" wide x 72" long holds 6 folding tables; shipped knocked down. Available powder coated in matte black (MBK) (TTRK)

Options

Hardware List Pricing

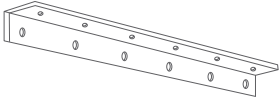
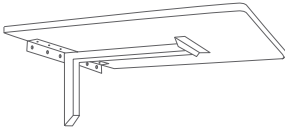
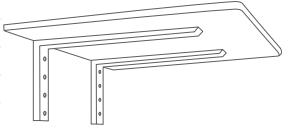
	Size	Maximum Top Size	Model #	\$
 <p>Wall Cleat</p>	20	36" wide	WC20	46
<p>Specifications: For use with table leg. Used to attach one end of table to wall. Cleat: .125" thick x 2" x 2" angle solid steel with mounting holes. Length: 20" Finish: Matte black Wall attachment hardware not included</p>				
 <p>Cantilever Table Bracket Single</p>	16 21	30" x 36"	CTBS21	172
	16 33	30" x 48"	CTBS33	214
<p>Specifications: Construction: 1.5" square steel tubing Cleat: .125" thick x 2" x 2" angle solid steel with mounting holes. Finish: Matte black Wall attachment hardware not included</p>				
 <p>Cantilever Table Bracket Double</p>	12 12	24" x 24"	CTBD12	162
	16 18	30" x 24"	CTBD18	190
	16 24	30" x 30"	CTBD24	218
	16 30	36" x 36"	CTBD30	246
	16 36	36" x 42"	CTBD36	276
	16 42	36" x 48"	CTBD42	304
<p>Specifications: Construction: 1.5" square steel tubing Cleat: .1875" thick x 1.5" x 3" structural steel channel with mounting holes. Finish: Matte black Wall attachment hardware not included</p>				

