

# HP-2

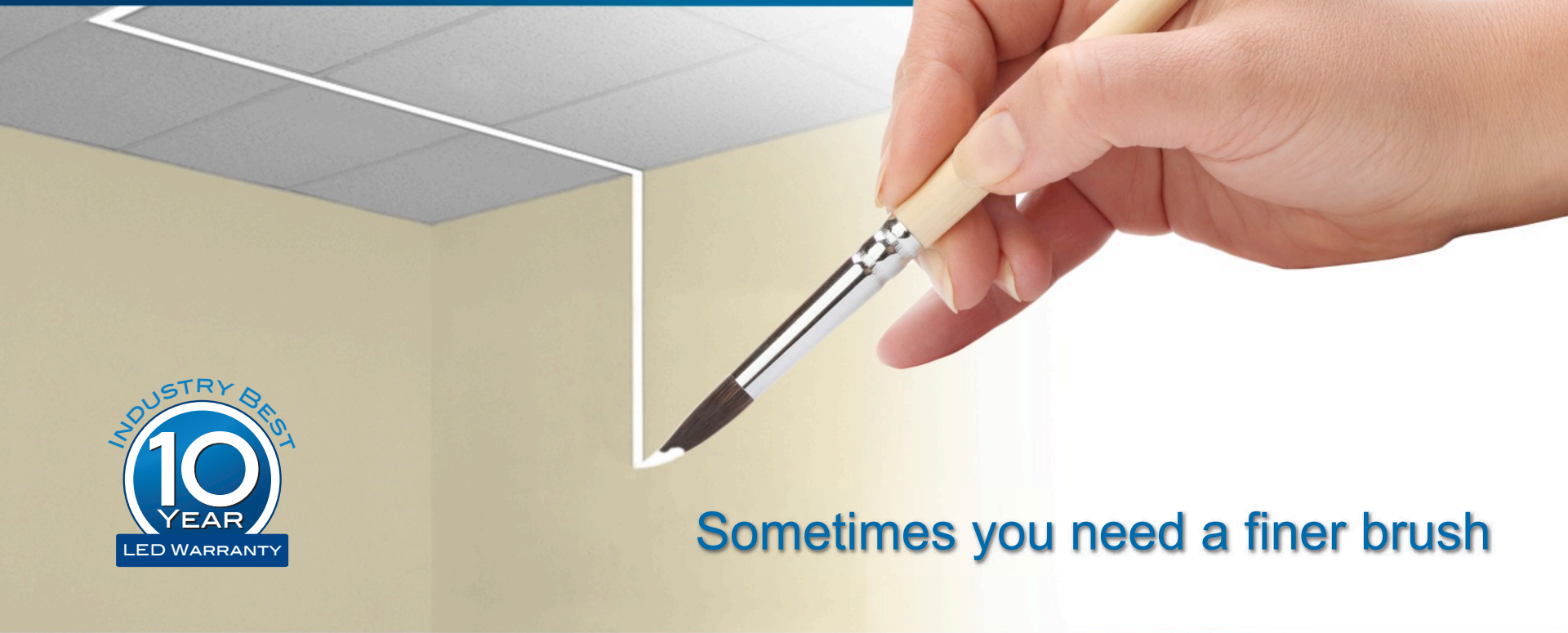

**FINELITE**  
Better Lighting

## High Performance 2" Aperture LED Collection



Sometimes you need a finer brush

# HP-2 Family Collection

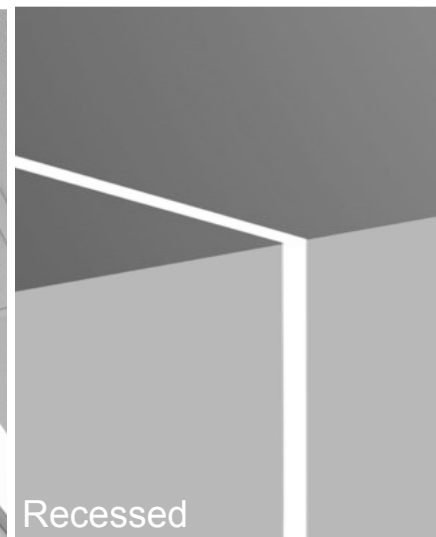
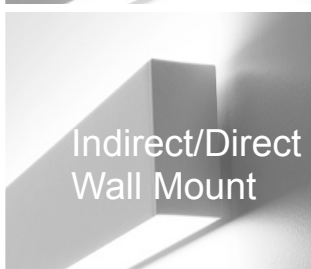
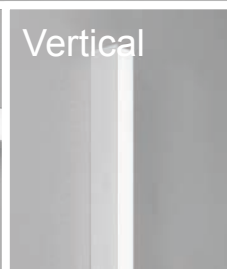
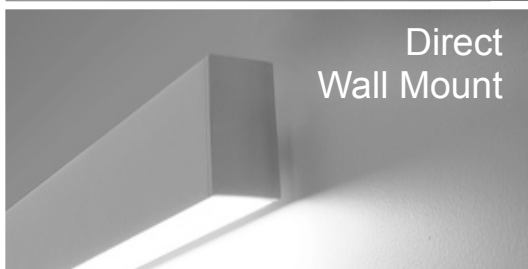
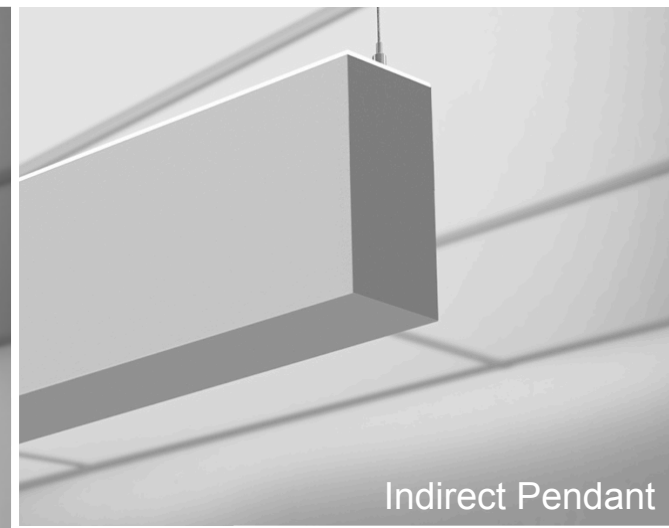
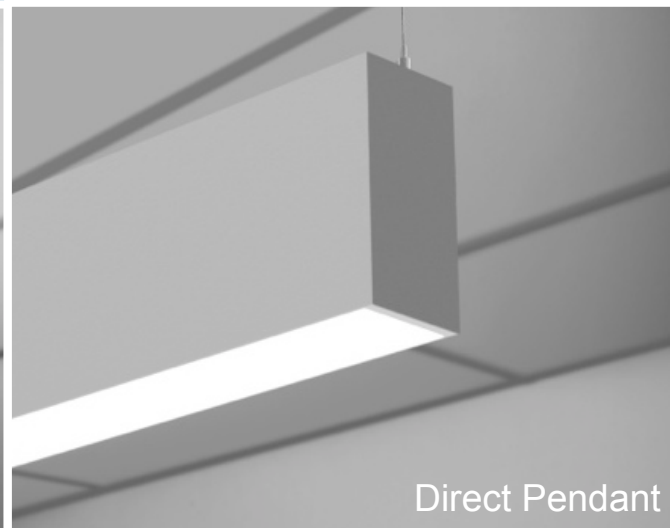

# LED Design – Long Life

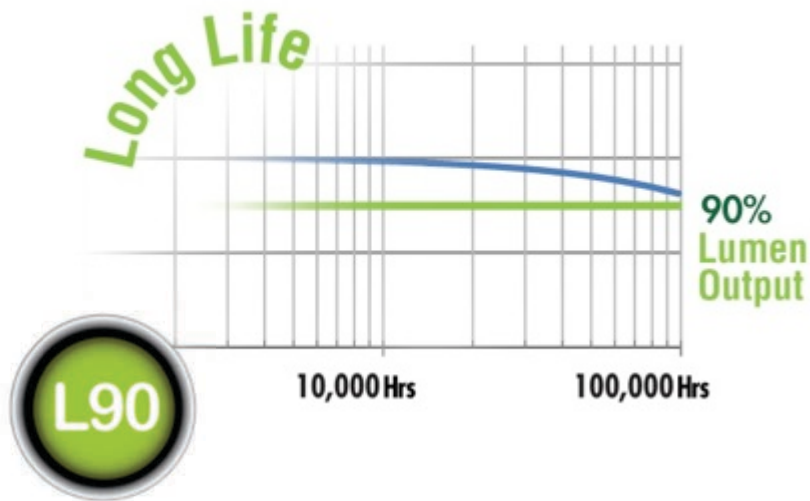

- Life: Delivers 90% light output to 100,000 hours
- TM21 reports to 168,000 hours

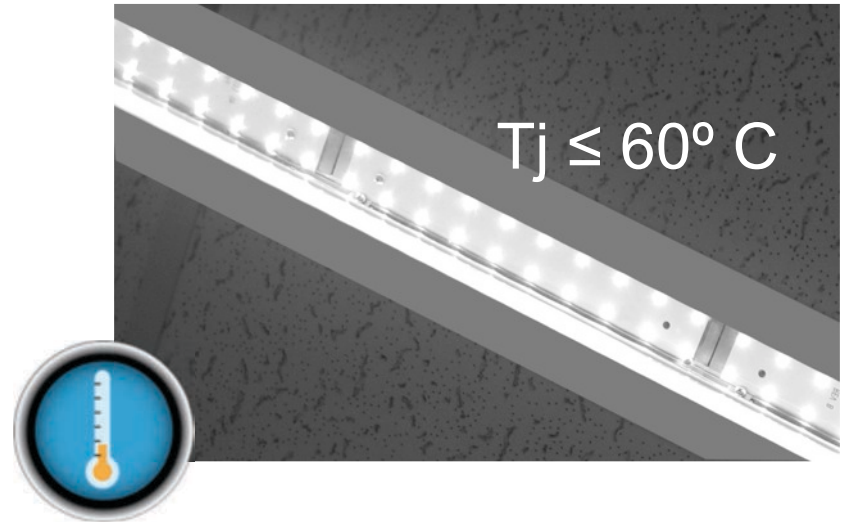

- Thermal Management: Mid-powered LEDs are spaced evenly to ensure maximum heat dissipation and long life

# Tailored Lighting



Project: Shutterfly Discovery Center  
Architect: Arizona Lighting Sales  
Lighting Designer: Arizona Lighting Sales



- Any length, 2-foot minimum, in increments down to 1/16<sup>th</sup>-inch
- Specify 90 degree angles in a single plane
- Projects ship in 10 working days

# Video

## VIDEO LIBRARY

### Tailored Lighting

LED technology has changed the way we light spaces. Let us show you better lighting, Tailored Lighting – lighting tailored to your requirements, to your expectations, to your design. With flexible lengths and configurations, Tailored lighting provides greater design freedom than ever before. Some Tailored Lighting options ship in 10 working days! Watch the video then [click here](#) to learn more.



[Click here to watch the video about Tailored Lighting on YouTube.](#)

# Tailored Lighting - Lengths

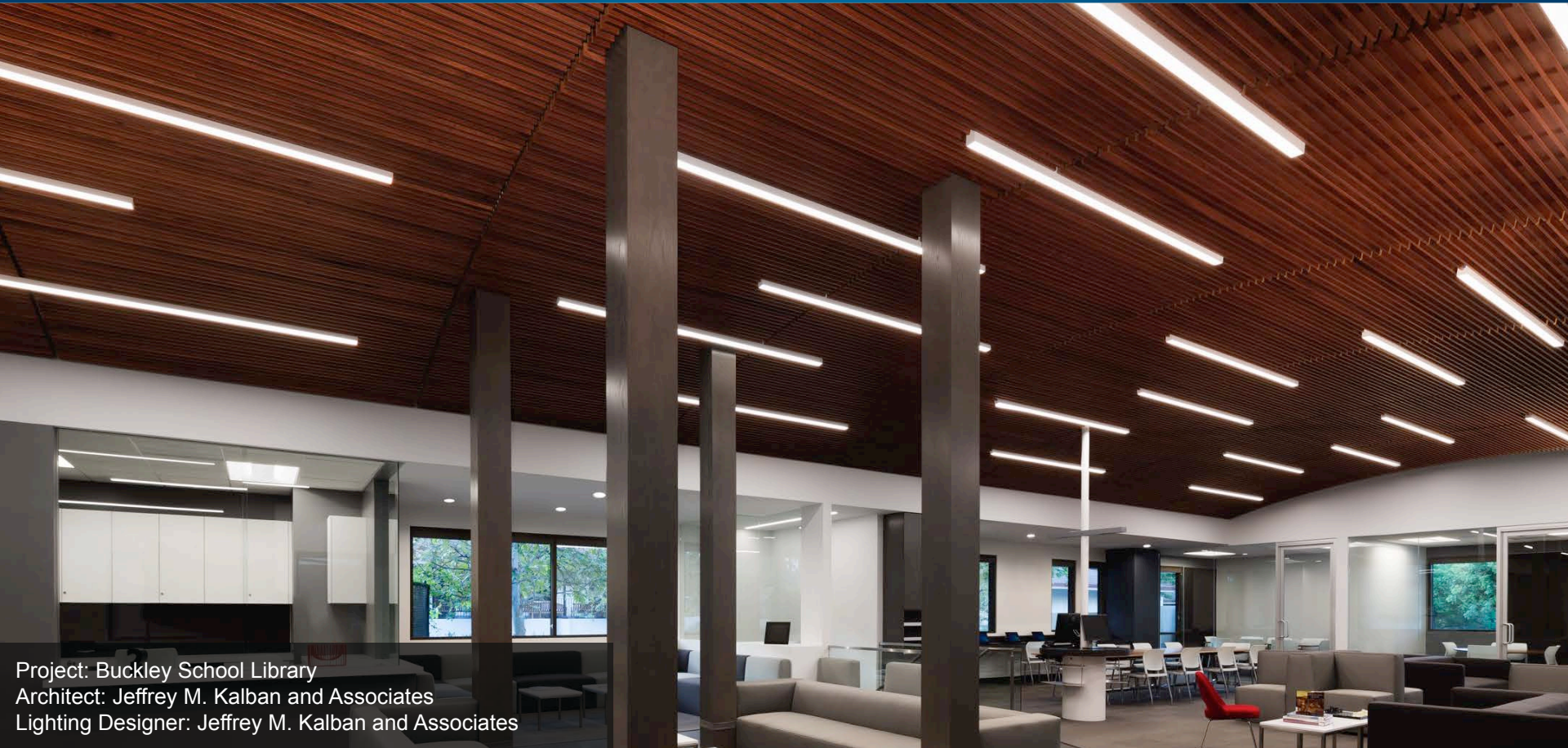

Project: Buckley School Library  
Architect: Jeffrey M. Kalban and Associates  
Lighting Designer: Jeffrey M. Kalban and Associates

- Any length greater than 2 feet, in increments accurate to 1/16" - inch

# Angles

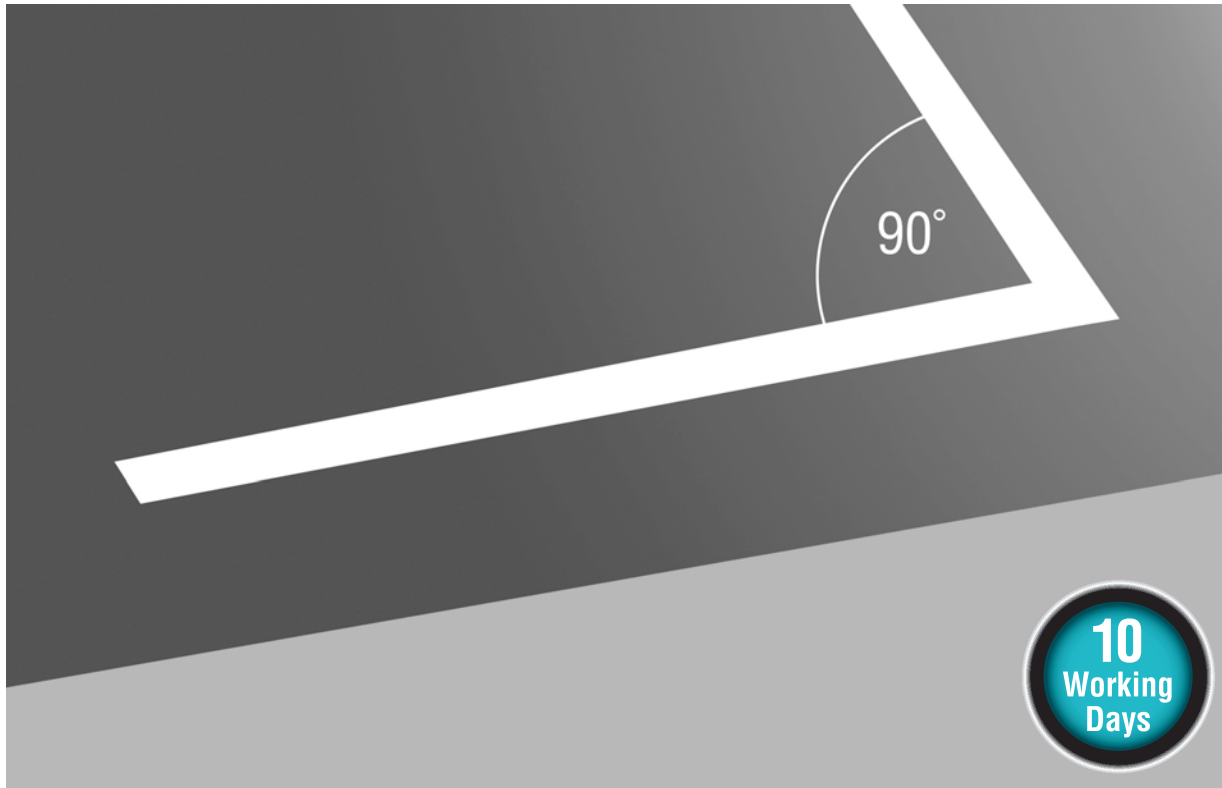

- 90-degree mitered corners in a single plane
- Corners available from 60°-180°, contact factory

# Features

- Any length, 2-foot minimum, in increments down to 1/16th-inch
- 10 Working days shipping on standard orders



*Contact factory for lengths in increments accurate of 1 foot to 1/16" inch*



# Configurations

HP-2 supports simple to complex configurations.

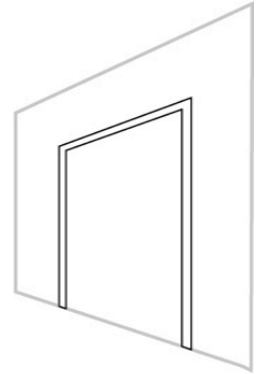
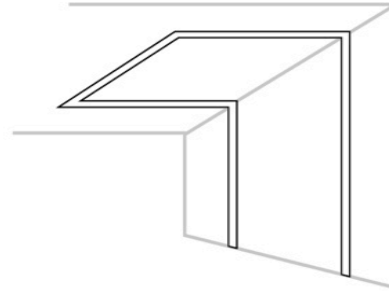
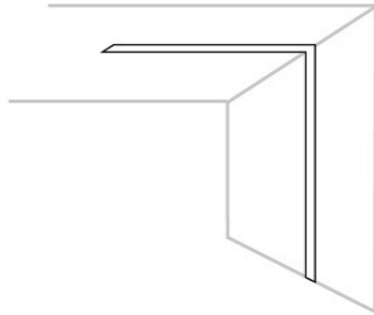
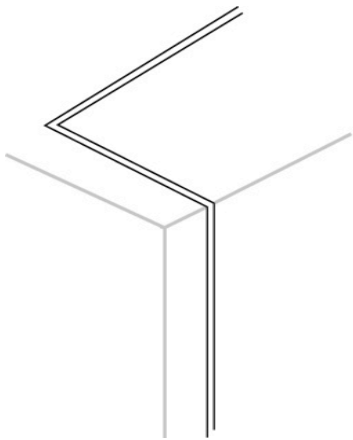

# Joining

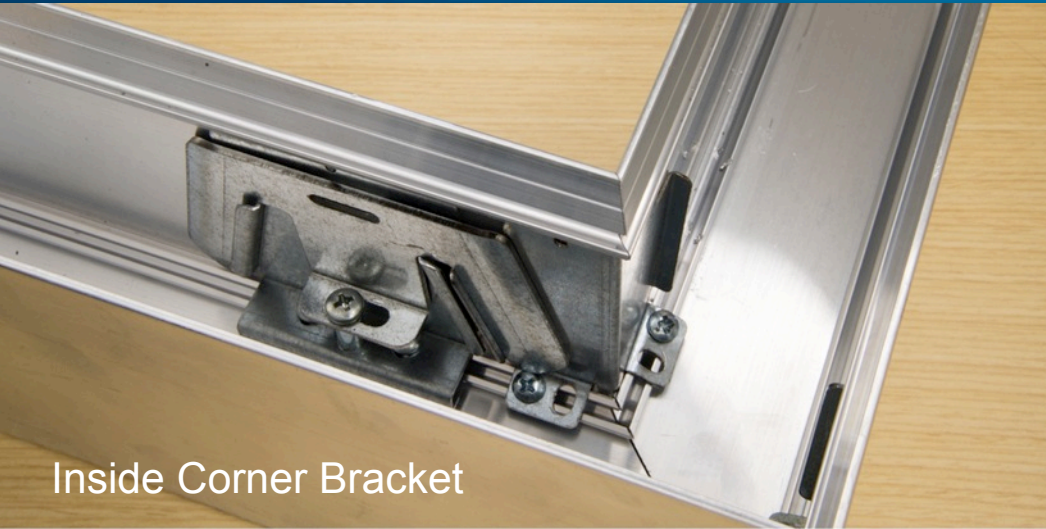

Inside Corner Bracket



Outside Corner Bracket

- Corner brackets secure luminaires together easier and faster for a tight joint

# Joining

Joint Bracket



- Linear joiner brackets secure luminaires together easier and faster for a tight joint

# Double Diffuser



- Corner diffusers prevent possibility of seeing LEDs at joints

# HP-2 Indirect/Direct Pendant

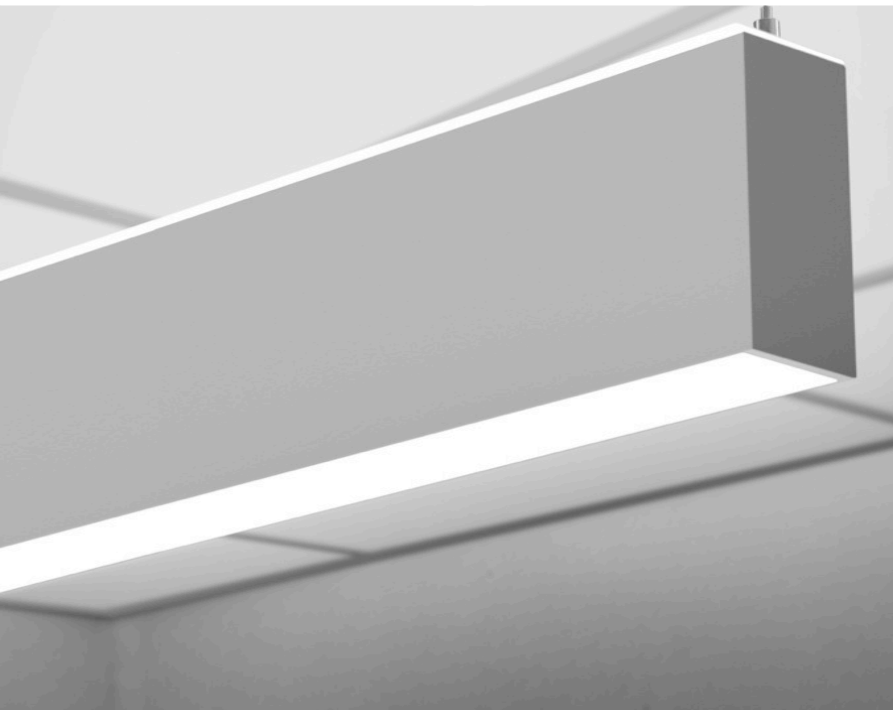
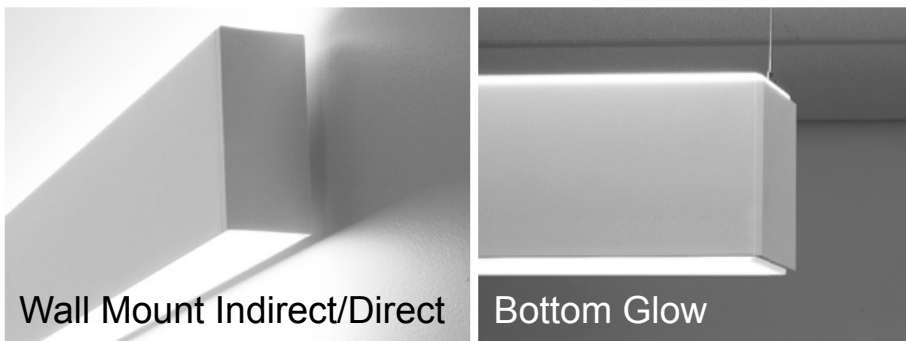

- Standard with Top Glow element
- Bottom Glow™ element optional
- Companion Wall Mount available

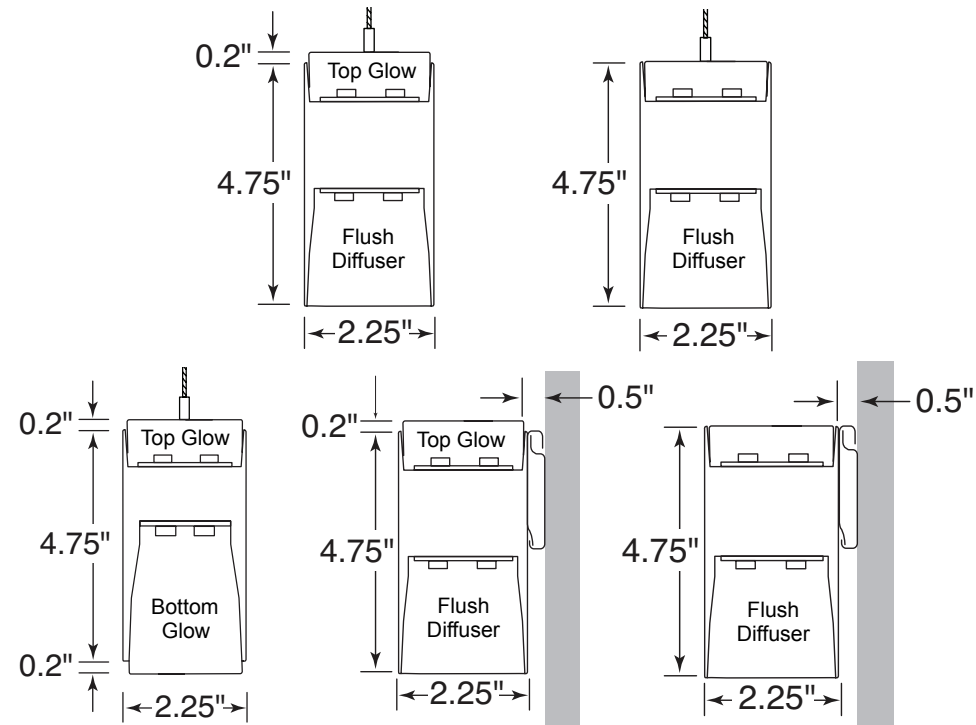

# HP-2 Direct Pendant

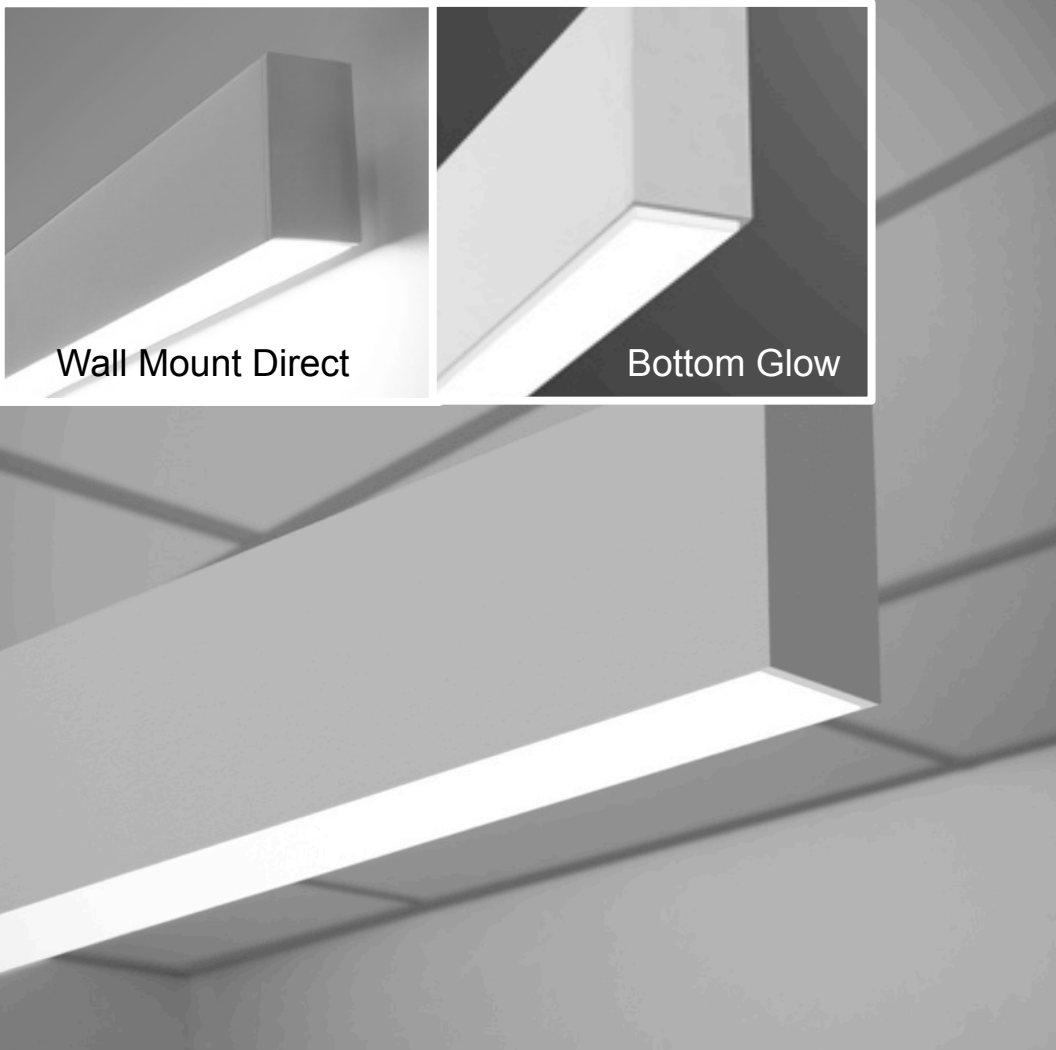

Wall Mount Direct

Bottom Glow

- Standard with flexible mounting
- Bottom Glow™ element optional
- Companion wall mount available

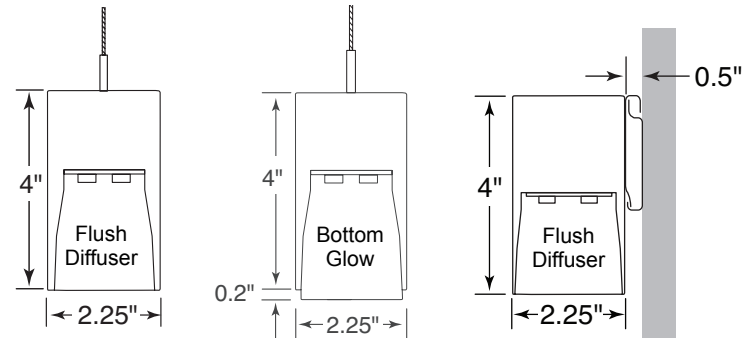

# HP-2 Indirect Pendant

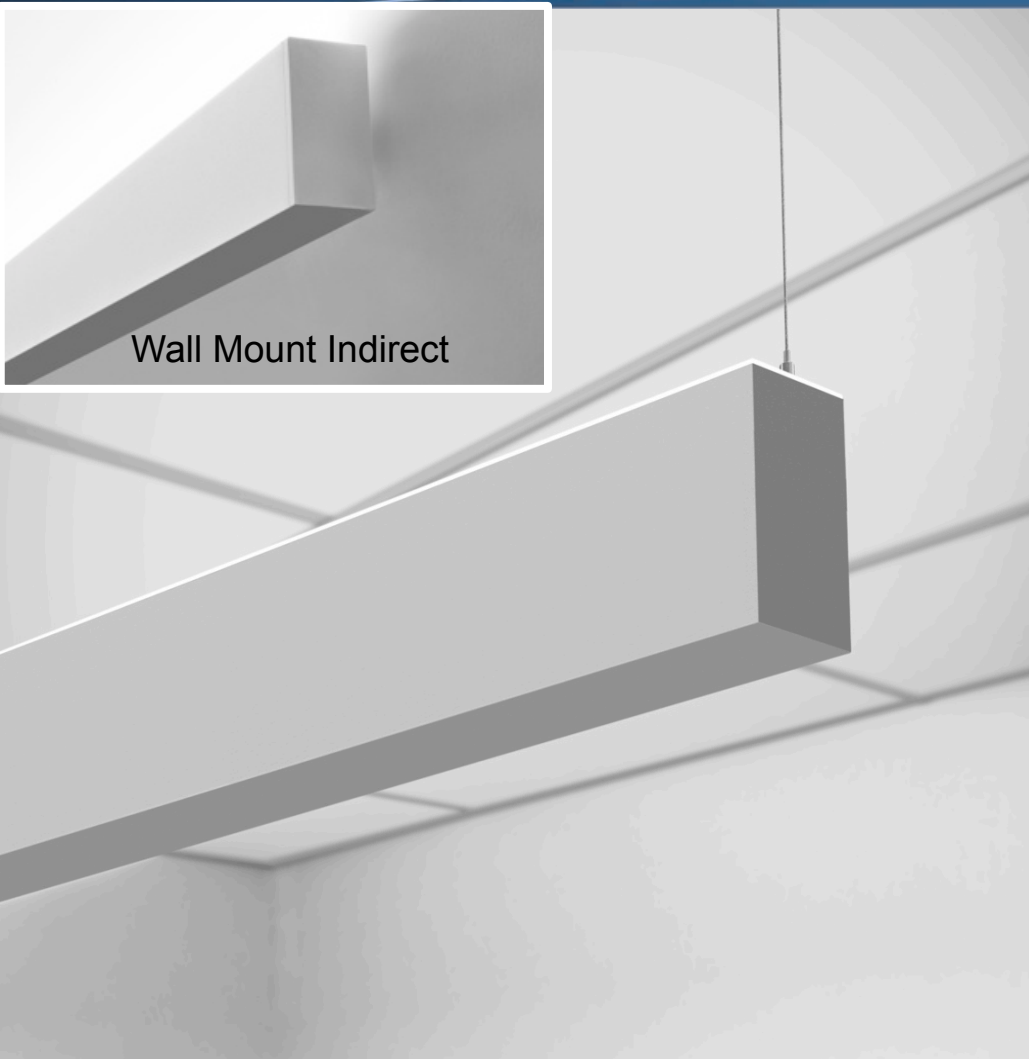

Wall Mount Indirect

- 100% Indirect with Top Glow diffuser standard
- Companion wall mount available

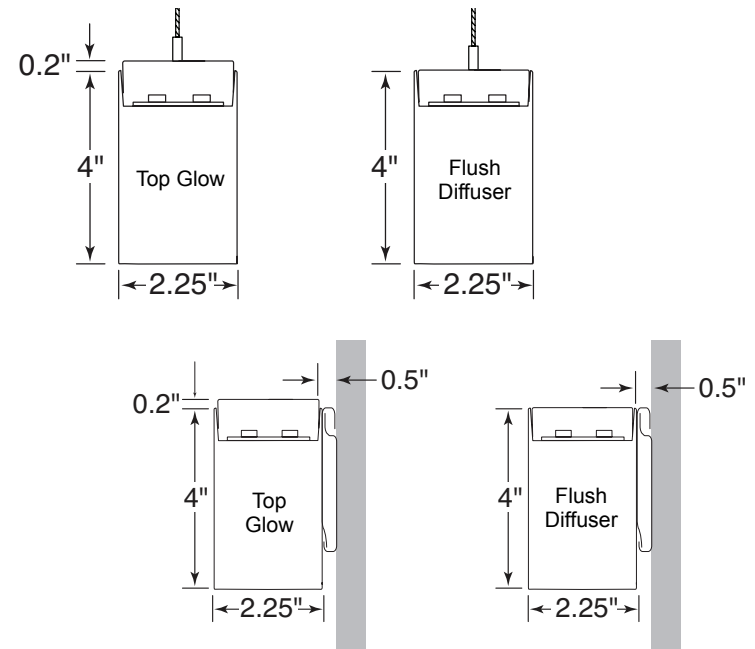

# HP-2 Recessed

- For ceiling or walls
- Mitered corners for clean, fined look

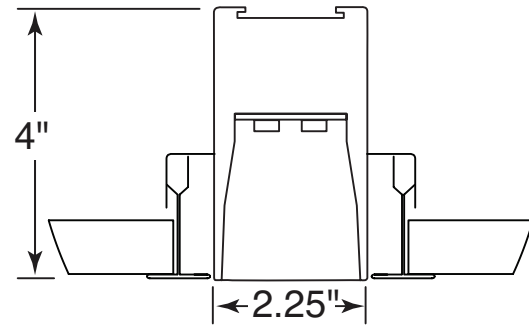

# HP-2 Recessed Ceiling Options

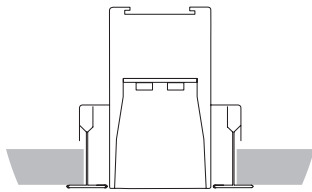

1" T-Bar(C1)

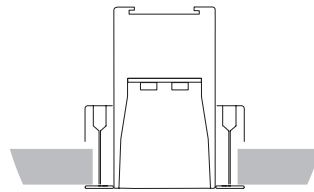

9/16" T-Bar (C2)

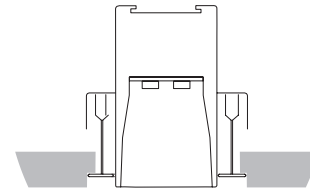

1" TEGULAR (C1T)

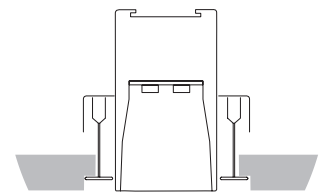

9/16" TEGULAR (C2T)

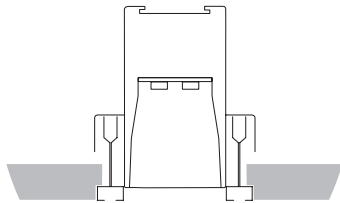

STANDARD SCREW  
SLOT (C3)

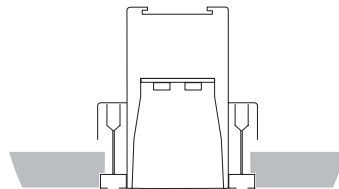

FLUSH SCREW SLOT (C3F)

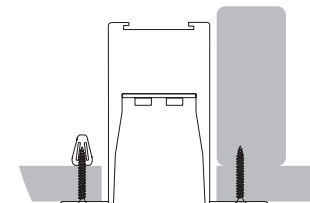

SPACKLE FLANGE (SF)

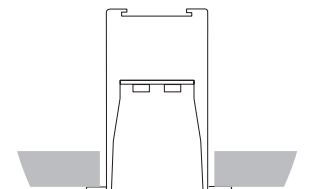

VISIBLE FLANGE (VF)

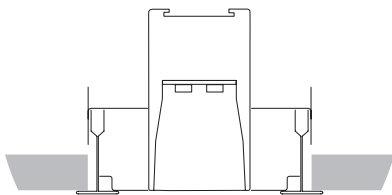

TECH ZONE 4"  
(TZ4 - C1, C2, C2T  
C3, C3F)



# HP-2 Recessed Cutout Dimensions

## MOUNTING TYPES: T-Bar

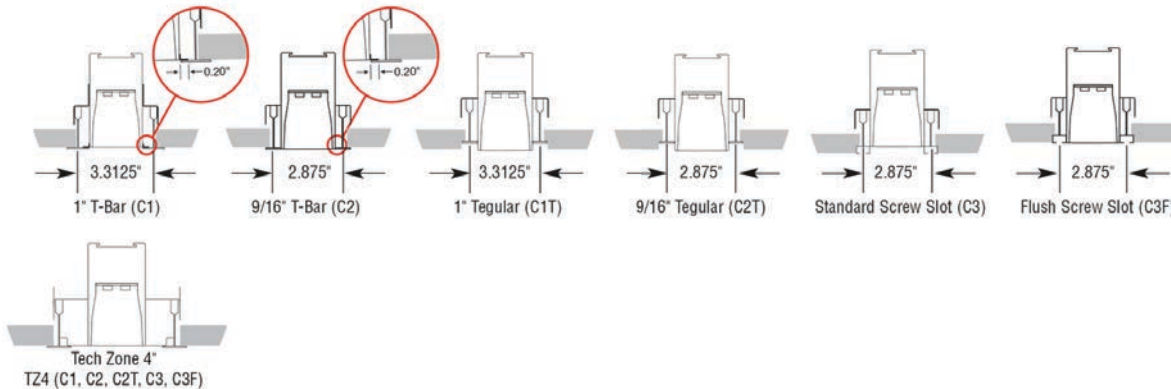

- Be sure to refer to the tech sheet for ceiling cutouts. Cutout dimension is different from the aperture dimension

## MOUNTING TYPES: CUTOUT DIMENSIONS

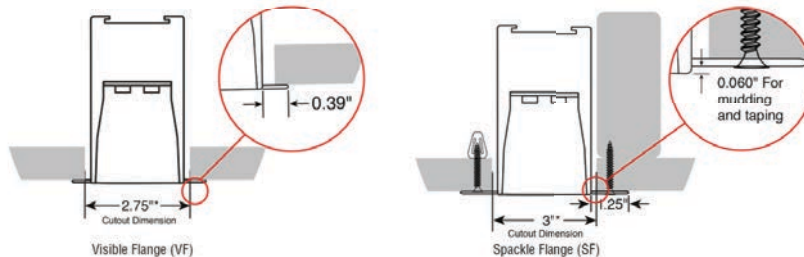

# HP-2 Surface Mount



- Bottom Glow™ element optional
- Mount to ceiling and walls
- Horizontal or vertical

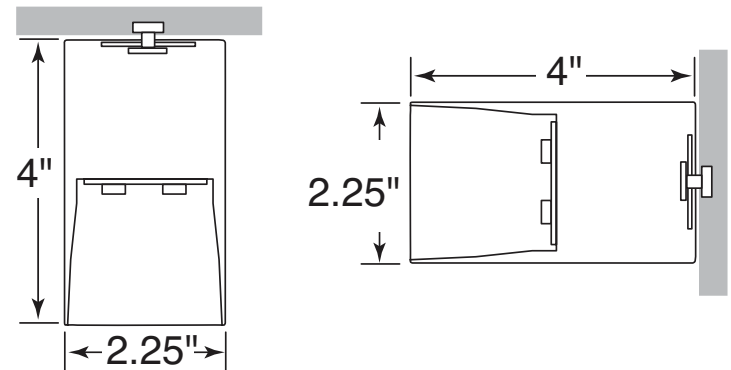

# HP-2 Wall Wash

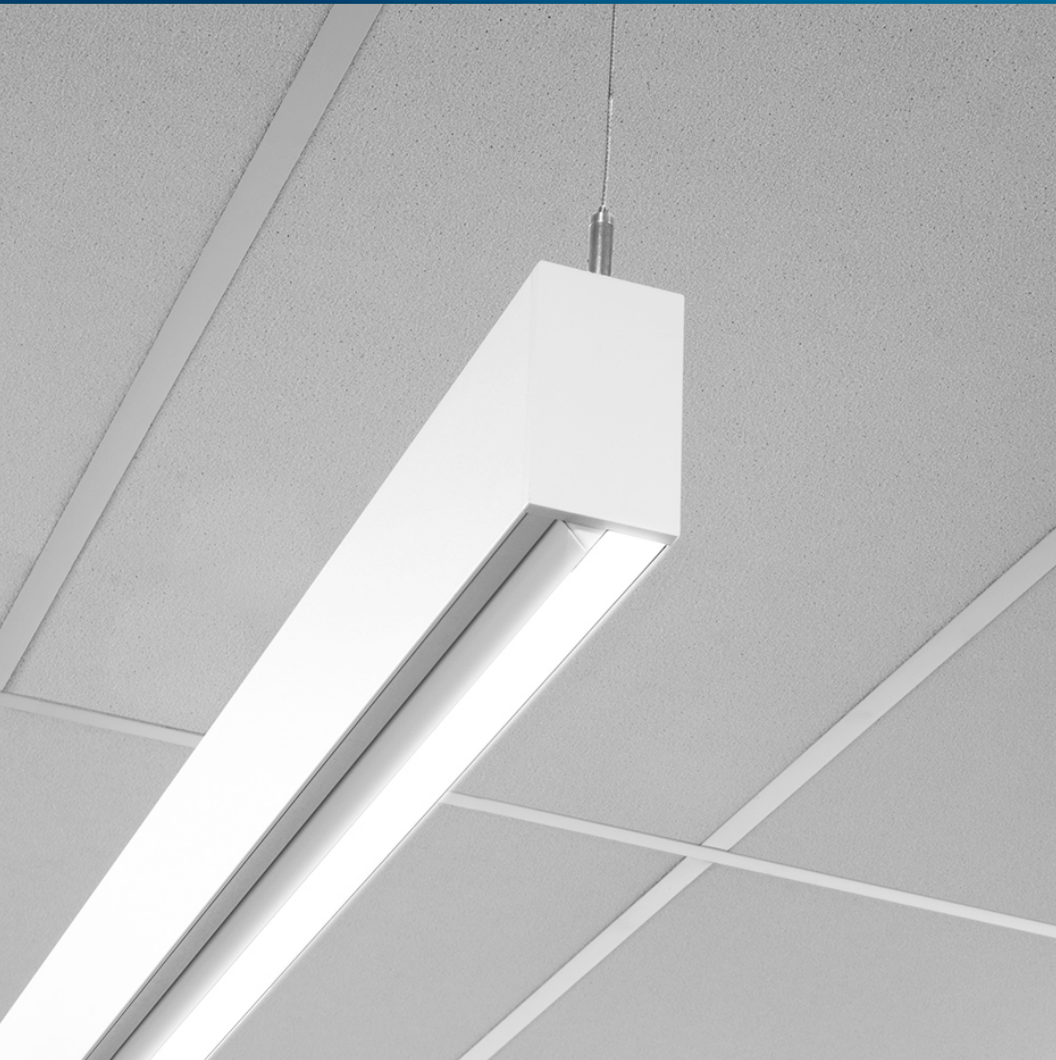

- Pendant, recessed, or surface mount options
- SO and HO outputs
- Available with kicker for improved performance on wall

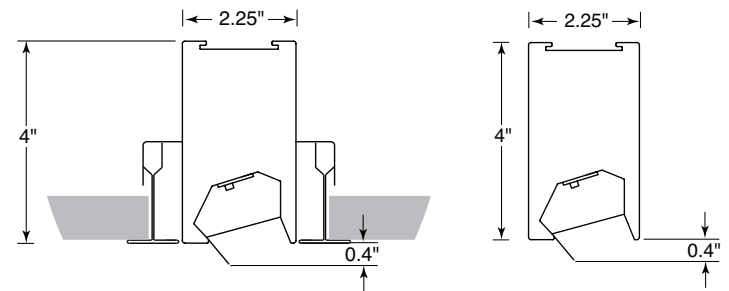

# Performance

## HP- 2 ID

### PHOTOMETRY

Standard Output/ Standard Output  
 Distribution: 56% Up (SO) / 44% Down (SO)  
 Efficacy: 81 lumen per watt  
 Uplight: 1602 lumens (400.6 lumens/foot)  
 Downlight: 1248 lumens (312 lumens/foot)  
 Total luminaire output: 2851 lumens (713 lumens/foot)  
 35.3 watts (8.8 watts/foot)

CCT: 4000K  
 Source Report 83154  
 (Family Correlation)

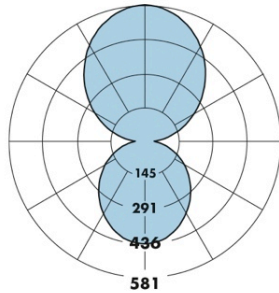
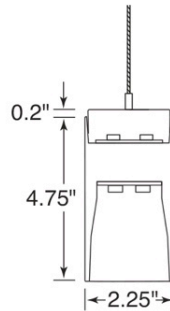

— Refer to [www.finelite.com](http://www.finelite.com) for additional photometry and product information.

CANDLEPOWER SUMMARY						
	0.0	22.5	45	67.5	90	Flux
0	436	436	436	436	436	
5	435	434	434	434	432	41
15	415	414	418	415	413	117
25	380	377	377	377	375	174
35	329	327	329	329	329	206
45	272	269	273	276	276	211
55	209	208	216	219	220	192
65	146	148	157	162	163	154
75	84	89	100	106	109	104
85	26	37	49	57	59	51
90	1	13	27	37	40	
95	27	39	53	62	66	56
105	96	108	121	130	134	125
115	173	184	196	206	208	192
125	256	265	277	285	286	246
135	336	347	359	364	364	274
145	422	427	435	438	438	270
155	495	495	500	502	501	230
165	549	548	549	550	549	155
175	578	578	577	577	576	55
180	581	581	581	581	581	

### PHOTOMETRY

Standard Output/ High Output  
 Distribution: 41% Up (SO) / 59% Down (HO)  
 Efficacy: 71 lumen per watt  
 Uplight: 1602 lumens (400.6 lumens/foot)  
 Downlight: 2263 lumens (565.6 lumens/foot)  
 Total luminaire output: 3865 lumens (966 lumens/foot)  
 54.1 watts (13.5 watts/foot)

CCT: 4000K  
 Source Report 83154  
 (Family Correlation)

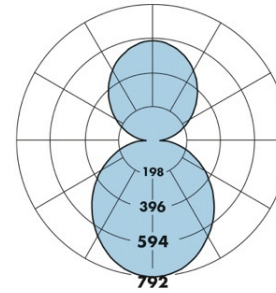
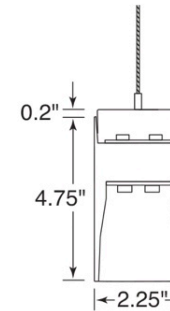

— Refer to [www.finelite.com](http://www.finelite.com) for additional photometry and product information.

CANDLEPOWER SUMMARY						
	0.0	22.5	45	67.5	90	Flux
0	792	792	792	792	792	
5	789	788	787	788	785	40
15	754	752	758	753	749	113
25	689	685	685	684	681	167
35	598	594	597	597	597	198
45	493	489	496	500	501	203
55	380	377	391	398	399	185
65	265	268	284	294	296	148
75	152	162	182	193	198	100
85	47	66	88	103	108	49
90	1	13	27	37	40	
95	27	39	53	62	66	54
105	96	108	121	130	134	121
115	173	184	196	206	208	185
125	256	265	277	285	286	237
135	336	347	359	364	364	264
145	422	427	435	438	438	260
155	495	495	500	502	501	221
165	549	548	548	550	549	149
175	578	578	577	577	576	53
180	581	581	581	581	581	

# Performance

## HP-2 ID Lumen Distribution Chart

Performance Data - 4000K				
	↑ SO/SO* ↓	↑ SO/HO* ↓	↑ HO/SO* ↓	↑ HO/HO* ↓
<b>Uplight</b> (lumens per foot)	400.6	400.6	727	727
<b>Downlight</b> (lumens per foot)	312	565.6	312.7	566.4
<b>Total Lumens Per Foot</b>	712.6	966.2	1039.7	1293.4
<b>Total Watts Per Foot</b>	8.8	13.5	13.5	18.2
<b>Efficacy</b> (LPW)	81	71	77	71

\* Family Correlation based on 4' luminaire 3500K HO/HO test. Consult [www.finelite.com](http://www.finelite.com) for 3000K and 3500K photometric reports.

# Performance

## HP-2 D, HP-2 WM-D, HP-2 R, and HP-2 SM

### PHOTOMETRY

Standard Output  
 Efficacy: 62 lumen per watt  
 Total luminaire output: 1148 lumens (287 lumens/foot)  
 18.5 watts (4.6 watts/foot)  
 Peak Candela Value: 420 @ 0°  
 CCT: 3500K  
 Source Report 81641  
 (Family Correlation)

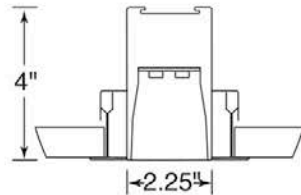

High Output  
 Efficacy: 56.9 lumen per watt  
 Total luminaire output: 2083 lumens (521 lumens/foot)  
 36.6 watts (9.1 watts/foot)  
 Peak Candela Value: 763 @ 0°  
 CCT: 3500K  
 ITL LM79 Report 81641

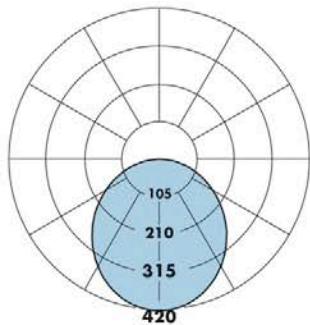
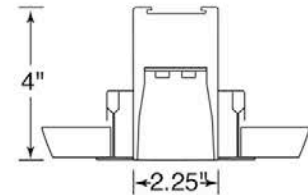

CANDLEPOWER SUMMARY						
	0.0	22.5	45	67.5	90	Flux
0	420	420	420	420	420	
5	418	417	417	417	417	40
15	401	398	400	400	398	113
25	366	362	364	363	362	167
35	319	315	316	314	314	197
45	263	261	261	259	258	201
55	203	201	201	199	198	179
65	141	139	139	138	138	138
75	82	80	80	79	79	85
85	26	26	26	26	25	28
90	0	0	0	0	0	

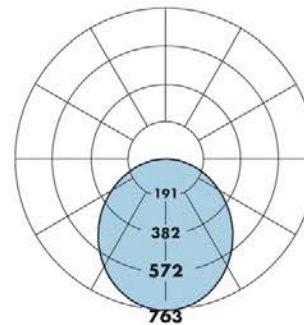

CANDLEPOWER SUMMARY						
	0.0	22.5	45	67.5	90	Flux
0	763	763	763	763	763	
5	760	757	757	758	756	72
15	727	723	726	725	723	204
25	664	657	661	658	656	303
35	578	572	574	570	569	358
45	478	473	473	470	469	364
55	368	365	364	361	360	325
65	256	253	253	251	251	250
75	148	146	145	144	144	154
85	48	47	47	47	46	51
90	0	0	0	0	0	

# Performance

## HP-2 D, WM-D, R and SM Lumen Distribution Chart

Performance Data						
	3000K		3500K		4000K	
	SO*	HO*	SO*	HO	SO*	HO*
<b>Total Lumens Per Foot</b>	275.2	499	287	520.75	297	540.5
<b>Total Watts Per Foot</b>	4.6	9.1	4.6	9.15	4.63	9.15
<b>Efficacy</b> (LPW)	59.8	54.8	62.4	56.9	64	59.1

\* Family Correlation based on 4' luminaire 3500K HO test.

# Performance

## HP-2 I

### PHOTOMETRY

Standard Output  
 Efficacy: 87 Lumen per watt  
 Total luminaire output: 1605 Lumens (401 lumens/foot)  
 18.5 Watts (4.6 watts/foot)  
 Peak Candela Value: 610 @ 180°  
 CCT: 3500K  
 Source Report 84078  
 (Family Correlation)

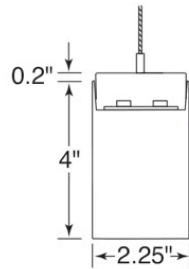

High Output  
 Efficacy: 80.2 Lumen per watt  
 Total luminaire output: 2911 Lumens (728 lumens/foot)  
 36.3 Watts (9.1 watts/foot)  
 Peak Candela Value: 1107 @ 180°  
 CCT: 3500K  
 ITL LM79 Report ITL84078

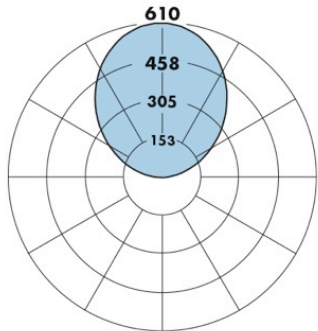
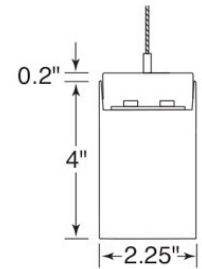

CANDLEPOWER SUMMARY						
	0.0	22.5	45	67.5	90	Flux
90	0	0	0	0	0	
95	29	29	29	27	28	32
105	105	104	103	101	102	109
115	192	190	189	186	184	186
125	282	280	278	276	273	248
135	369	369	369	366	363	284
145	455	453	455	451	449	283
155	527	524	527	524	523	242
165	579	578	579	578	578	163
175	607	607	607	607	607	58
180	610	610	610	610	610	

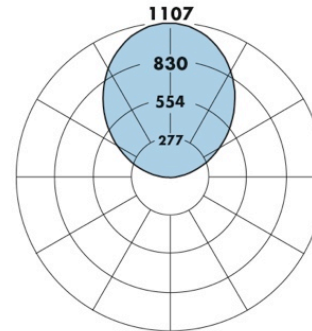

CANDLEPOWER SUMMARY						
	0.0	22.5	45	67.5	90	Flux
90	0	0	0	0	0	
95	52	52	52	49	50	58
105	191	189	186	184	185	198
115	348	344	342	337	334	338
125	511	507	505	500	496	450
135	670	669	670	664	659	515
145	825	822	825	818	814	513
155	956	951	956	950	949	439
165	1051	1048	1051	1048	1049	296
175	1101	1101	1101	1101	1101	104
180	1107	1107	1107	1107	1107	

# Performance

## HP-2 I Lumen Distribution Chart

Performance Data						
	3000K		3500K		4000K	
	SO*	HO*	SO*	HO	SO*	HO*
<b>Total Lumens Per Foot</b>	384.75	697.25	401.25	727.75	415	755.5
<b>Total Watts Per Foot</b>	4.625	9.075	4.625	9.075	4.625	9.075
<b>Efficacy (LPW)</b>	83	77	87	80.2	90	83

\* Family Correlation based on 4' luminaire 3500K HO test.

# Performance

## HP-2 WW

### PHOTOMETRY

High Output  
 Efficacy: 61.5 lumen per watt  
 Total luminaire output: 1206 lumens (302 lumens/foot)  
 19.6 watts (4.9 watts/foot)

CRI: 84  
 R9: 21  
 CCT: 3500K  
 ITL LM79 Report 84355

### With Kicker

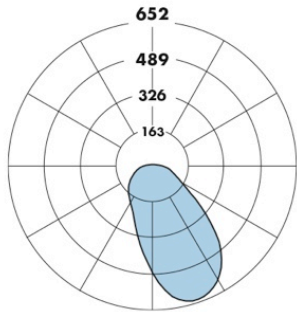
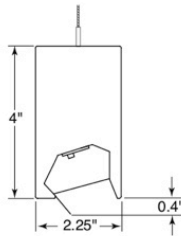

CANDLEPOWER SUMMARY						
	0.0	45.0	90.0	135.0	180.0	Flux
0	395	395	395	395	395	
5	487	459	394	333	309	38
15	625	570	382	232	199	112
25	651	602	355	173	152	176
35	602	563	313	136	117	214
45	485	478	260	101	77	215
55	317	356	197	63	42	178
65	202	232	133	30	13	125
75	148	142	73	2	0	79
85	110	88	22	0	0	45
90	86	63	0	0	0	

### PHOTOMETRY

High Output  
 Efficacy: 71.2 lumen per watt  
 Total luminaire output: 1396 lumens (349 lumens/foot)  
 19.6 watts (4.9 watts/foot)

CRI: 84  
 R9: 21  
 CCT: 3500K  
 ITL LM79 Report 84354

### Without Kicker

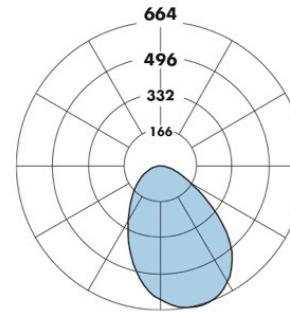
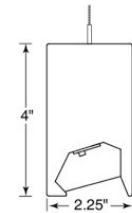

CANDLEPOWER SUMMARY						
	0.0	45.0	90.0	135.0	180.0	Flux
0	609	609	609	609	609	
5	637	628	608	583	574	57
15	664	643	587	503	464	161
25	646	623	529	403	342	235
35	571	555	450	299	242	267
45	433	452	357	214	170	255
55	249	316	258	144	115	201
65	124	177	168	87	70	132
75	61	77	88	40	35	68
85	21	21	26	10	9	20
90	0	0	0	0	0	



# Performance

## HP-2 Wall Wash Lumen Distribution Chart

Performance Data						
	3000K		3500K		4000K	
	SO*	HO*	SO*	HO	SO*	HO*
<b>Total Lumens Per Foot</b>	159.25	289	166.25	301.5	172	313
<b>Total Watts Per Foot</b>	2.6	4.9	2.6	4.9	2.6	4.9
<b>Efficacy (LPW)</b>	61	59	64	61.5	66	64

\* Family Correlation based on 4' luminaire 3500K HO test.



# Marketing Materials

**FINELITE**  
Better Lighting



Project: Buckley-Simons Library  
Architect: Jeffrey M. Kalban & Associates  
Lighting Designer: Jeffrey M. Kalban & Associates  
Location: Los Angeles, CA

## HP-2 With Tailored Lighting™

High Performance 2" Aperture  
LED COLLECTION







**FINELITE** High Performance 2" Aperture (HP-2) - Indirect/Direct

LED BUY AMERICAN ACT OF 2009 COMPLIANT

**DESCRIPTION**

High Performance 2" aperture Indirect/Direct (HP-2 ID) is a patented, linear LED luminaire with Flush, Top Glow™ and Bottom Glow™ options for up- and downlight. The micro shape delivers excellent performance using an advanced optical design and mid-power LEDs to achieve 90% of initial light output at 100,000 hours. Tailored Lighting options available.

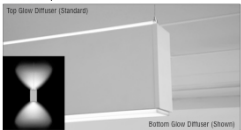
**Top Glow Diffuser (Standard)**



**Bottom Glow Diffuser (Optional)**

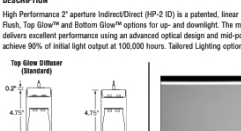

**Flush Uplight and Downlight Diffuser**

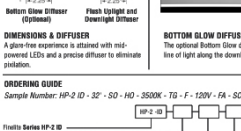

**BOTTOM GLOW DIFFUSER**

The optional Bottom Glow diffuser adds a clean line of light along the downlight element.

Date: \_\_\_\_\_

Project: \_\_\_\_\_

Type: \_\_\_\_\_

Comments: \_\_\_\_\_

**Tailored Lighting  
10 working days**

**TAILORED LIGHTING**  
Any length greater than 2 feet. In increments down to 1/16th inch and 90-degree corner centers in a single plane.

---

**Aperture (HP-2) - Recessed**

Date: \_\_\_\_\_

Project: \_\_\_\_\_

Type: \_\_\_\_\_

Comments: \_\_\_\_\_

**Tailored Lighting  
10 working days**

**TAILORED LIGHTING**  
Any length greater than 2 feet. In increments down to 1/16th inch and 90-degree corner centers in a single plane.

**ORDERING GUIDE**

Sample Number: HP-2 ID - 32" - SD - HD - 3500K - TG - F - 120V - FA - SC - C1 - 080

Finelite Series HP-2 ID

Length (Minimum 2" increments accurate to 1/16th", Standard) \_\_\_\_\_

Light Engine (SD - Standard Output, HD - High Output) \_\_\_\_\_

Downlight Engine (SD - Standard Output, HD - High Output) \_\_\_\_\_

LED Color Temperature (3000K, 3500K, 4000K) \_\_\_\_\_

Single Diffuser Option (TG - Top Glow (Standard), F - Flush (Optional), Downlight Diffuser Option (F - Flush (Standard), SD - Bottom Glow (Optional))

Voltage (120V, 277V) \_\_\_\_\_

Mounting (FA - Fully Adjustable) \_\_\_\_\_

Circuiting (SC - Single Circuit, DC - Dual Circuit) \_\_\_\_\_

Control Type (C1 - 1" Spoke, C2 - 3/16" Spoke, C3 - Screw Slot, C4 - Hard Ceiling, Integrated Sensor (OSD - Occupancy Sensor, ODD - Daylight)

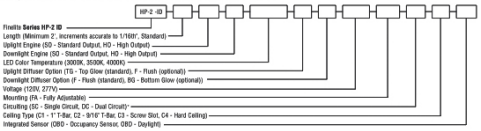

**Protected by one or more US Patents: 8915613; 8782-391; 8782-390; 8782-389; 8782-388; 8782-387; 8782-386 S; 8727-556 S; 8727-551 S**

Finelite, Inc. • 30500 Whipple Road • Union City, CA 94587-1530 • 510 / 441-1100 • Fax: 510 / 441-1510 • [www.finelite.com](http://www.finelite.com)

Due to continuing product improvements, Finelite reserves the right to change specifications without notice. Please visit [www.finelite.com](http://www.finelite.com) for most current data.

---

**ORDERING GUIDE**

Finelite Series HP-2 ID

Length (Minimum 2" increments accurate to 1/16th", Standard) \_\_\_\_\_

Light Engine (SD - Standard Output, HD - High Output) \_\_\_\_\_

LED Color Temperature (3000K, 3500K, 4000K) \_\_\_\_\_

Downlight Diffuser (F - Flush (Standard)) \_\_\_\_\_

Voltage (120V, 277V) \_\_\_\_\_

Circuiting (SC - Single Circuit)

Control Type (C1 - 1" Spoke, C2 - 3/16" Spoke, C3 - Screw Slot, C4 - Hard Ceiling, C5 - Flush Screen Slot, YF - Yokeless Hanger, C21 - 3/16" Taper, C11 - 1" Taper, C12 - 3/8" Taper, C13 - 1/2" Taper, C14 - 3/4" Taper, C15 - 1" Taper, C16 - 1 1/4" Taper, C17 - 1 1/2" Taper, C18 - 1 3/4" Taper, C19 - 2" Taper, C20 - 2 1/4" Taper, C22 - 2" Taper, C23 - 2 1/4" Taper, C24 - 2 1/2" Taper, C25 - 2 3/4" Taper, C26 - 3" Taper, C27 - 3 1/4" Taper, C28 - 3 1/2" Taper, C29 - 3 3/4" Taper, C30 - 4" Taper, C31 - 4 1/4" Taper, C32 - 4 1/2" Taper, C33 - 4 3/4" Taper, C34 - 5" Taper, C35 - 5 1/4" Taper, C36 - 5 1/2" Taper, C37 - 5 3/4" Taper, C38 - 6" Taper, C39 - 6 1/4" Taper, C40 - 6 1/2" Taper, C41 - 6 3/4" Taper, C42 - 7" Taper, C43 - 7 1/4" Taper, C44 - 7 1/2" Taper, C45 - 7 3/4" Taper, C46 - 8" Taper, C47 - 8 1/4" Taper, C48 - 8 1/2" Taper, C49 - 8 3/4" Taper, C50 - 9" Taper, C51 - 9 1/4" Taper, C52 - 9 1/2" Taper, C53 - 9 3/4" Taper, C54 - 10" Taper, C55 - 10 1/4" Taper, C56 - 10 1/2" Taper, C57 - 10 3/4" Taper, C58 - 11" Taper, C59 - 11 1/4" Taper, C60 - 11 1/2" Taper, C61 - 11 3/4" Taper, C62 - 12" Taper, C63 - 12 1/4" Taper, C64 - 12 1/2" Taper, C65 - 12 3/4" Taper, C66 - 13" Taper, C67 - 13 1/4" Taper, C68 - 13 1/2" Taper, C69 - 13 3/4" Taper, C70 - 14" Taper, C71 - 14 1/4" Taper, C72 - 14 1/2" Taper, C73 - 14 3/4" Taper, C74 - 15" Taper, C75 - 15 1/4" Taper, C76 - 15 1/2" Taper, C77 - 15 3/4" Taper, C78 - 16" Taper, C79 - 16 1/4" Taper, C80 - 16 1/2" Taper, C81 - 16 3/4" Taper, C82 - 17" Taper, C83 - 17 1/4" Taper, C84 - 17 1/2" Taper, C85 - 17 3/4" Taper, C86 - 18" Taper, C87 - 18 1/4" Taper, C88 - 18 1/2" Taper, C89 - 18 3/4" Taper, C90 - 19" Taper, C91 - 19 1/4" Taper, C92 - 19 1/2" Taper, C93 - 19 3/4" Taper, C94 - 20" Taper, C95 - 20 1/4" Taper, C96 - 20 1/2" Taper, C97 - 20 3/4" Taper, C98 - 21" Taper, C99 - 21 1/4" Taper, C100 - 21 1/2" Taper, C101 - 21 3/4" Taper, C102 - 22" Taper, C103 - 22 1/4" Taper, C104 - 22 1/2" Taper, C105 - 22 3/4" Taper, C106 - 23" Taper, C107 - 23 1/4" Taper, C108 - 23 1/2" Taper, C109 - 23 3/4" Taper, C110 - 24" Taper, C111 - 24 1/4" Taper, C112 - 24 1/2" Taper, C113 - 24 3/4" Taper, C114 - 25" Taper, C115 - 25 1/4" Taper, C116 - 25 1/2" Taper, C117 - 25 3/4" Taper, C118 - 26" Taper, C119 - 26 1/4" Taper, C120 - 26 1/2" Taper, C121 - 26 3/4" Taper, C122 - 27" Taper, C123 - 27 1/4" Taper, C124 - 27 1/2" Taper, C125 - 27 3/4" Taper, C126 - 28" Taper, C127 - 28 1/4" Taper, C128 - 28 1/2" Taper, C129 - 28 3/4" Taper, C130 - 29" Taper, C131 - 29 1/4" Taper, C132 - 29 1/2" Taper, C133 - 29 3/4" Taper, C134 - 30" Taper, C135 - 30 1/4" Taper, C136 - 30 1/2" Taper, C137 - 30 3/4" Taper, C138 - 31" Taper, C139 - 31 1/4" Taper, C140 - 31 1/2" Taper, C141 - 31 3/4" Taper, C142 - 32" Taper, C143 - 32 1/4" Taper, C144 - 32 1/2" Taper, C145 - 32 3/4" Taper, C146 - 33" Taper, C147 - 33 1/4" Taper, C148 - 33 1/2" Taper, C149 - 33 3/4" Taper, C150 - 34" Taper, C151 - 34 1/4" Taper, C152 - 34 1/2" Taper, C153 - 34 3/4" Taper, C154 - 35" Taper, C155 - 35 1/4" Taper, C156 - 35 1/2" Taper, C157 - 35 3/4" Taper, C158 - 36" Taper, C159 - 36 1/4" Taper, C160 - 36 1/2" Taper, C161 - 36 3/4" Taper, C162 - 37" Taper, C163 - 37 1/4" Taper, C164 - 37 1/2" Taper, C165 - 37 3/4" Taper, C166 - 38" Taper, C167 - 38 1/4" Taper, C168 - 38 1/2" Taper, C169 - 38 3/4" Taper, C170 - 39" Taper, C171 - 39 1/4" Taper, C172 - 39 1/2" Taper, C173 - 39 3/4" Taper, C174 - 40" Taper, C175 - 40 1/4" Taper, C176 - 40 1/2" Taper, C177 - 40 3/4" Taper, C178 - 41" Taper, C179 - 41 1/4" Taper, C180 - 41 1/2" Taper, C181 - 41 3/4" Taper, C182 - 42" Taper, C183 - 42 1/4" Taper, C184 - 42 1/2" Taper, C185 - 42 3/4" Taper, C186 - 43" Taper, C187 - 43 1/4" Taper, C188 - 43 1/2" Taper, C189 - 43 3/4" Taper, C190 - 44" Taper, C191 - 44 1/4" Taper, C192 - 44 1/2" Taper, C193 - 44 3/4" Taper, C194 - 45" Taper, C195 - 45 1/4" Taper, C196 - 45 1/2" Taper, C197 - 45 3/4" Taper, C198 - 46" Taper, C199 - 46 1/4" Taper, C200 - 46 1/2" Taper, C201 - 46 3/4" Taper, C202 - 47" Taper, C203 - 47 1/4" Taper, C204 - 47 1/2" Taper, C205 - 47 3/4" Taper, C206 - 48" Taper, C207 - 48 1/4" Taper, C208 - 48 1/2" Taper, C209 - 48 3/4" Taper, C210 - 49" Taper, C211 - 49 1/4" Taper, C212 - 49 1/2" Taper, C213 - 49 3/4" Taper, C214 - 50" Taper, C215 - 50 1/4" Taper, C216 - 50 1/2" Taper, C217 - 50 3/4" Taper, C218 - 51" Taper, C219 - 51 1/4" Taper, C220 - 51 1/2" Taper, C221 - 51 3/4" Taper, C222 - 52" Taper, C223 - 52 1/4" Taper, C224 - 52 1/2" Taper, C225 - 52 3/4" Taper, C226 - 53" Taper, C227 - 53 1/4" Taper, C228 - 53 1/2" Taper, C229 - 53 3/4" Taper, C230 - 54" Taper, C231 - 54 1/4" Taper, C232 - 54 1/2" Taper, C233 - 54 3/4" Taper, C234 - 55" Taper, C235 - 55 1/4" Taper, C236 - 55 1/2" Taper, C237 - 55 3/4" Taper, C238 - 56" Taper, C239 - 56 1/4" Taper, C240 - 56 1/2" Taper, C241 - 56 3/4" Taper, C242 - 57" Taper, C243 - 57 1/4" Taper, C244 - 57 1/2" Taper, C245 - 57 3/4" Taper, C246 - 58" Taper, C247 - 58 1/4" Taper, C248 - 58 1/2" Taper, C249 - 58 3/4" Taper, C250 - 59" Taper, C251 - 59 1/4" Taper, C252 - 59 1/2" Taper, C253 - 59 3/4" Taper, C254 - 60" Taper, C255 - 60 1/4" Taper, C256 - 60 1/2" Taper, C257 - 60 3/4" Taper, C258 - 61" Taper, C259 - 61 1/4" Taper, C260 - 61 1/2" Taper, C261 - 61 3/4" Taper, C262 - 62" Taper, C263 - 62 1/4" Taper, C264 - 62 1/2" Taper, C265 - 62 3/4" Taper, C266 - 63" Taper, C267 - 63 1/4" Taper, C268 - 63 1/2" Taper, C269 - 63 3/4" Taper, C270 - 64" Taper, C271 - 64 1/4" Taper, C272 - 64 1/2" Taper, C273 - 64 3/4" Taper, C274 - 65" Taper, C275 - 65 1/4" Taper, C276 - 65 1/2" Taper, C277 - 65 3/4" Taper, C278 - 66" Taper, C279 - 66 1/4" Taper, C280 - 66 1/2" Taper, C281 - 66 3/4" Taper, C282 - 67" Taper, C283 - 67 1/4" Taper, C284 - 67 1/2" Taper, C285 - 67 3/4" Taper, C286 - 68" Taper, C287 - 68 1/4" Taper, C288 - 68 1/2" Taper, C289 - 68 3/4" Taper, C290 - 69" Taper, C291 - 69 1/4" Taper, C292 - 69 1/2" Taper, C293 - 69 3/4" Taper, C294 - 70" Taper, C295 - 70 1/4" Taper, C296 - 70 1/2" Taper, C297 - 70 3/4" Taper, C298 - 71" Taper, C299 - 71 1/4" Taper, C300 - 71 1/2" Taper, C301 - 71 3/4" Taper, C302 - 72" Taper, C303 - 72 1/4" Taper, C304 - 72 1/2" Taper, C305 - 72 3/4" Taper, C306 - 73" Taper, C307 - 73 1/4" Taper, C308 - 73 1/2" Taper, C309 - 73 3/4" Taper, C310 - 74" Taper, C311 - 74 1/4" Taper, C312 - 74 1/2" Taper, C313 - 74 3/4" Taper, C314 - 75" Taper, C315 - 75 1/4" Taper, C316 - 75 1/2" Taper, C317 - 75 3/4" Taper, C318 - 76" Taper, C319 - 76 1/4" Taper, C320 - 76 1/2" Taper, C321 - 76 3/4" Taper, C322 - 77" Taper, C323 - 77 1/4" Taper, C324 - 77 1/2" Taper, C325 - 77 3/4" Taper, C326 - 78" Taper, C327 - 78 1/4" Taper, C328 - 78 1/2" Taper, C329 - 78 3/4" Taper, C330 - 79" Taper, C331 - 79 1/4" Taper, C332 - 79 1/2" Taper, C333 - 79 3/4" Taper, C334 - 80" Taper, C335 - 80 1/4" Taper, C336 - 80 1/2" Taper, C337 - 80 3/4" Taper, C338 - 81" Taper, C339 - 81 1/4" Taper, C340 - 81 1/2" Taper, C341 - 81 3/4" Taper, C342 - 82" Taper, C343 - 82 1/4" Taper, C344 - 82 1/2" Taper, C345 - 82 3/4" Taper, C346 - 83" Taper, C347 - 83 1/4" Taper, C348 - 83 1/2" Taper, C349 - 83 3/4" Taper, C350 - 84" Taper, C351 - 84 1/4" Taper, C352 - 84 1/2" Taper, C353 - 84 3/4" Taper, C354 - 85" Taper, C355 - 85 1/4" Taper, C356 - 85 1/2" Taper, C357 - 85 3/4" Taper, C358 - 86" Taper, C359 - 86 1/4" Taper, C360 - 86 1/2" Taper, C361 - 86 3/4" Taper, C362 - 87" Taper, C363 - 87 1/4" Taper, C364 - 87 1/2" Taper, C365 - 87 3/4" Taper, C366 - 88" Taper, C367 - 88 1/4" Taper, C368 - 88 1/2" Taper, C369 - 88 3/4" Taper, C370 - 89" Taper, C371 - 89 1/4" Taper, C372 - 89 1/2" Taper, C373 - 89 3/4" Taper, C374 - 90" Taper, C375 - 90 1/4" Taper, C376 - 90 1/2" Taper, C377 - 90 3/4" Taper, C378 - 91" Taper, C379 - 91 1/4" Taper, C380 - 91 1/2" Taper, C381 - 91 3/4" Taper, C382 - 92" Taper, C383 - 92 1/4" Taper, C384 - 92 1/2" Taper, C385 - 92 3/4" Taper, C386 - 93" Taper, C387 - 93 1/4" Taper, C388 - 93 1/2" Taper, C389 - 93 3/4" Taper, C390 - 94" Taper, C391 - 94 1/4" Taper, C392 - 94 1/2" Taper, C393 - 94 3/4" Taper, C394 - 95" Taper, C395 - 95 1/4" Taper, C396 - 95 1/2" Taper, C397 - 95 3/4" Taper, C398 - 96" Taper, C399 - 96 1/4" Taper, C400 - 96 1/2" Taper, C401 - 96 3/4" Taper, C402 - 97" Taper, C403 - 97 1/4" Taper, C404 - 97 1/2" Taper, C405 - 97 3/4" Taper, C406 - 98" Taper, C407 - 98 1/4" Taper, C408 - 98 1/2" Taper, C409 - 98 3/4" Taper, C410 - 99" Taper, C411 - 99 1/4" Taper, C412 - 99 1/2" Taper, C413 - 99 3/4" Taper, C414 - 100" Taper, C415 - 100 1/4" Taper, C416 - 100 1/2" Taper, C417 - 100 3/4" Taper, C418 - 101" Taper, C419 - 101 1/4" Taper, C420 - 101 1/2" Taper, C421 - 101 3/4" Taper, C422 - 102" Taper, C423 - 102 1/4" Taper, C424 - 102 1/2" Taper, C425 - 102 3/4" Taper, C426 - 103" Taper, C427 - 103 1/4" Taper, C428 - 103 1/2" Taper, C429 - 103 3/4" Taper, C430 - 104" Taper, C431 - 104 1/4" Taper, C432 - 104 1/2" Taper, C433 - 104 3/4" Taper, C434 - 105" Taper, C435 - 105 1/4" Taper, C436 - 105 1/2" Taper, C437 - 105 3/4" Taper, C438 - 106" Taper, C439 - 106 1/4" Taper, C440 - 106 1/2" Taper, C441 - 106 3/4" Taper, C442 - 107" Taper, C443 - 107 1/4" Taper, C444 - 107 1/2" Taper, C445 - 107 3/4" Taper, C446 - 108" Taper, C447 - 108 1/4" Taper, C448 - 108 1/2" Taper, C449 - 108 3/4" Taper, C450 - 109" Taper, C451 - 109 1/4" Taper, C452 - 109 1/2" Taper, C453 - 109 3/4" Taper, C454 - 110" Taper, C455 - 110 1/4" Taper, C456 - 110 1/2" Taper, C457 - 110 3/4" Taper, C458 - 111" Taper, C459 - 111 1/4" Taper, C460 - 111 1/2" Taper, C461 - 111 3/4" Taper, C462 - 112" Taper, C463 - 112 1/4" Taper, C464 - 112 1/2" Taper, C465 - 112 3/4" Taper, C466 - 113" Taper, C467 - 113 1/4" Taper, C468 - 113 1/2" Taper, C469 - 113 3/4" Taper, C470 - 114" Taper, C471 - 114 1/4" Taper, C472 - 114 1/2" Taper, C473 - 114 3/4" Taper, C474 - 115" Taper, C475 - 115 1/4" Taper, C476 - 115 1/2" Taper, C477 - 115 3/4" Taper, C478 - 116" Taper, C479 - 116 1/4" Taper, C480 - 116 1/2" Taper, C481 - 116 3/4" Taper, C482 - 117" Taper, C483 - 117 1/4" Taper, C484 - 117 1/2" Taper, C485 - 117 3/4" Taper, C486 - 118" Taper, C487 - 118 1/4" Taper, C488 - 118 1/2" Taper, C489 - 118 3/4" Taper, C490 - 119" Taper, C491 - 119 1/4" Taper, C492 - 119 1/2" Taper, C493 - 119 3/4" Taper, C494 - 120" Taper, C495 - 120 1/4" Taper, C496 - 120 1/2" Taper, C497 - 120 3/4" Taper, C498 - 121" Taper, C499 - 121 1/4" Taper, C500 - 121 1/2" Taper, C501 - 121 3/4" Taper, C502 - 122" Taper, C503 - 122 1/4" Taper, C504 - 122 1/2" Taper, C505 - 122 3/4" Taper, C506 - 123" Taper, C507 - 123 1/4" Taper, C508 - 123 1/2" Taper, C509 - 123 3/4" Taper, C510 - 124" Taper, C511 - 124 1/4" Taper, C512 - 124 1/2" Taper, C513 - 124 3/4" Taper, C514 - 125" Taper, C515 - 125 1/4" Taper, C516 - 125 1/2" Taper, C517 - 125 3/4" Taper, C518 - 126" Taper, C519 - 126 1/4" Taper, C520 - 126 1/2" Taper, C521 - 126 3/4" Taper, C522 - 127" Taper, C523 - 127 1/4" Taper, C524 - 127 1/2" Taper, C525 - 127 3/4" Taper, C526 - 128" Taper, C527 - 128 1/4" Taper, C528 - 128 1/2" Taper, C529 - 128 3/4" Taper, C530 - 129" Taper, C531 - 129 1/4" Taper, C532 - 129 1/2" Taper, C533 - 129 3/4" Taper, C534 - 130" Taper, C535 - 130 1/4" Taper, C536 - 130 1/2" Taper, C537 - 130 3/4" Taper, C538 - 131" Taper, C539 - 131 1/4" Taper, C540 - 131 1/2" Taper, C541 - 131 3/4" Taper, C542 - 132" Taper, C543 - 132 1/4" Taper, C544 - 132 1/2" Taper, C545 - 132 3/4" Taper, C546 - 133" Taper, C547 - 133 1/4" Taper, C548 - 133 1/2" Taper, C549 - 133 3/4" Taper, C550 - 134" Taper, C551 - 134 1/4" Taper, C552 - 134 1/2" Taper, C553 - 134 3/4" Taper, C554 - 135" Taper, C555 - 135 1/4" Taper, C556 - 135 1/2" Taper, C557 - 135 3/4" Taper, C558 - 136" Taper, C559 - 136 1/4" Taper, C560 - 136 1/2" Taper, C561 - 136 3/4" Taper, C562 - 137" Taper, C563 - 137 1/4" Taper, C564 - 137 1/2" Taper, C565 - 137 3/4" Taper, C566 - 138" Taper, C567 - 138 1/4" Taper, C568 - 138 1/2" Taper, C569 - 138 3/4" Taper, C570 - 139" Taper, C571 - 139 1/4" Taper, C572 - 139 1/2" Taper, C573 - 139 3/4" Taper, C574 - 140" Taper, C575 - 140 1/4" Taper, C576 - 140 1/2" Taper, C577 - 140 3/4" Taper, C578 - 141" Taper, C579 - 141 1/4" Taper, C580 - 141 1/2" Taper, C581 - 141 3/4" Taper, C582 - 142" Taper, C583 - 142 1/4" Taper, C584 - 142 1/2" Taper, C585 - 142 3/4" Taper, C586 - 143" Taper, C587 - 143 1/4" Taper, C588 - 143 1/2" Taper, C589 - 143 3/4" Taper, C590 - 144" Taper, C591 - 144 1/4" Taper, C592 - 144 1/2" Taper, C593 - 144 3/4" Taper, C594 - 145" Taper, C595 - 145 1/4" Taper, C596 - 145 1/2" Taper, C597 - 145 3/4" Taper, C598 - 146" Taper, C599 - 146 1/4" Taper, C600 - 146 1/2" Taper, C601 - 146 3/4" Taper, C602 - 147" Taper, C603 - 147 1/4" Taper, C604 - 147 1/2" Taper, C605 - 147 3/4" Taper, C606 - 148" Taper, C607 - 148 1/4" Taper, C608 - 148 1/2" Taper, C609 - 148 3/4" Taper, C610 - 149" Taper, C611 - 149 1/4" Taper, C612 - 149 1/2" Taper, C613 - 149 3/4" Taper, C614 - 150" Taper, C615 - 150 1/4" Taper, C616 - 150 1/2" Taper, C617 - 150 3/4" Taper, C618 - 151" Taper, C619 - 151 1/4" Taper, C620 - 151 1/2" Taper, C621 - 151 3/4" Taper, C622 - 152" Taper, C623 - 152 1/4" Taper, C624 - 152 1/2" Taper, C625 - 152 3/4" Taper, C626 - 153" Taper, C627 - 153 1/4" Taper, C628 - 153 1/2" Taper, C629 - 153 3/4" Taper, C630 - 154" Taper, C631 - 154 1/4" Taper, C632 - 154 1/2" Taper, C633 - 154 3/4" Taper, C634 - 155" Taper, C635 - 155 1/4" Taper, C636 - 155 1/2" Taper, C637 - 155 3/4" Taper, C638 - 156" Taper, C639 - 156 1/4" Taper, C640 - 156 1/2" Taper, C641 - 156 3/4" Taper, C642 - 157" Taper, C643 - 157 1/4" Taper, C644 - 157 1/2" Taper, C645 - 157 3/4" Taper, C646 - 158" Taper, C647 - 158 1/4" Taper, C648 - 158 1/2" Taper, C649 - 158 3/4" Taper, C650 - 159" Taper, C651 - 159 1/4" Taper, C652 - 159 1/2" Taper, C653 - 159 3/4" Taper, C654 - 160" Taper, C655 - 160 1/4" Taper, C656 - 160 1/2" Taper, C657 - 160 3/4" Taper, C658 - 161" Taper, C659 - 161 1/4" Taper, C660 - 161 1/2" Taper, C661 - 161 3/4" Taper, C662 - 162" Taper, C663 - 162 1/4" Taper, C664 - 162 1/2" Taper, C665 - 162 3/4" Taper, C666 - 163" Taper, C667 - 163 1/4" Taper, C668 - 163 1/2" Taper, C669 - 163 3/4" Taper, C670 - 164" Taper, C671 - 164 1/4" Taper, C672 - 164 1/2" Taper, C673 - 164 3/4" Taper, C674 - 165" Taper, C675 - 165 1/4" Taper, C676 - 165 1/2" Taper, C677 - 165 3/4" Taper, C678 - 166" Taper, C679 - 166 1/4" Taper, C680 - 166 1/2" Taper, C681 - 166 3/4" Taper, C682 - 167" Taper, C683 - 167 1/4" Taper, C684 - 167 1/2" Taper, C685 - 167 3/4" Taper, C686 - 168" Taper, C687 - 168 1/4" Taper, C688 - 168 1/2" Taper, C689 - 168 3/4" Taper, C690 - 169" Taper, C691 - 169 1/4" Taper, C692 - 169 1/2" Taper, C693 - 169 3/4" Taper, C694 - 170" Taper, C695 - 170 1/4" Taper, C696 - 170 1/2" Taper, C697 - 170

# Ordering Information

## Ordering Guide

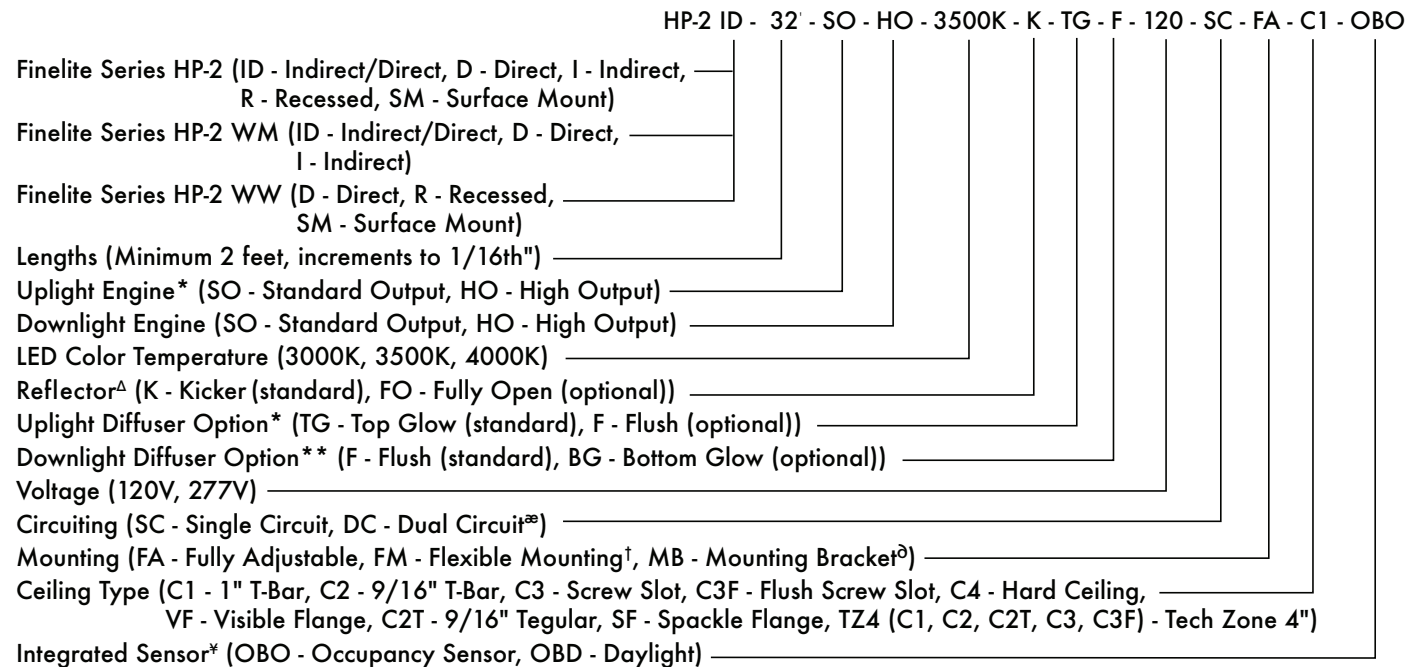

<sup>Δ</sup> Wall Wash only

\* Available on HP-2 Indirect/Direct and Indirect only

\*\* Available on HP-2 Direct, Indirect/Direct, and Surface Mount only

⊕ Dual Circuit for Indirect/Direct only

† Available on HP-2 Direct Pendant only

‡ Available on HP-2 Wall Mount only

¥ Not available for Wall Wash

# Finelite Commitment To You



- **10 Working days shipping on standard orders**



- **Focus on sustainability**



- **Buy American Act of 2009 Compliant**

# The Finelite LED Difference



- **10-year performance-based warranty**



- **90% of initial light output at 100,000 hours**

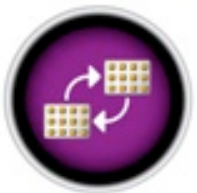

- **Replaceable LED light array**



- **Dimming standard**