

Seating

North America Price List – May 2017



This Price List is based upon Haworth's March 2017 pricing.

Electronic Update Page – Seating Price List

- The table below lists all of the updates and addendums added to this price list since the original version was created.
- All **Update** pages will replace the existing pages within the document.
- All **New** pages will be placed at the back of the document.

Link	Date	Page	Description
Click Here	September 2017	19-40	Update – Headrest and Faux Leather Back options added to Fern Price List pages.
Click Here	September 2017	1A	New – Fern At-A-Glance General Specifications page added for new Headrest and Faux Leather back options.
Click Here	September 2017	24	Update – To Order, specify code for mesh back was corrected.



This Haworth North American price book contains US list prices. Canadian customers can convert the US list price into their Canadian equivalent by going to www.Haworth.com/Canada to find the current Canadian multipliers. These multiplier factors allow you to convert the US list price into a Canadian list price.

Table of Contents

Product Directory	7-17	Wire Stacker Storage Rack	116
Task Seating		Wire Stacker Tablet Arm	116
Fern™ Seating		Ganging Connector	116
General Guidelines for Product Specification	19	Stacking Carts	117
Fern-At-A-Glance	20	Very Task-At-A-Glance	119
General Specifications	21-23	Very Task Value Model	124
Fern Value Model	24	Task Chair with 4D Arms	126-127
Task Chair with 4D Arms	25-26	Task Chair with Height Adjustable Arms	128-129
Task Chair with Height Adjustable Arms	27-28	Task Chair with Fixed Arms	130-131
Task Chair with Fixed Arms	29-30	Task Chair without Arms	132-133
Task Chair without Arms	31-32	Task Stool with 4D Arms	134-135
Task Stool with 4D Arms	33-34	Task Stool with Height Adjustable Arms	136-137
Task Stool with Height Adjustable Arms	35-36	Task Stool with Fixed Arms	138-139
Task Stool with Fixed Arms	37-38	Task Stool without Arms	140-141
Task Stool without Arms	39-40		
Zody® Seating		Lively®	
Zody-At-A-Glance	41	Lively-At-A-Glance	143
General Guidelines for Product Specification	42	General Guidelines for Product Specification	144
General Specifications	43-47	General Specifications	144-148
Zody Value Model	48	Lively Value Model	149
Task Chair with 4D Arms	49-51	Task Chair with 4D Arms	150
Task Chair with Height Adjustable Arms	53-55	Task Chair with Height Adjustable Arms	151
Task Chair with Fixed Arms	57-59	Task Chair with Fixed Arms	152
Task Chair without Arms	61-63	Task Chair without Arms	153
Task Stool with 4D Arms	64-66	Side Chair with Arms	154
Task Stool with Height Adjustable Arms	68-70	Side Chair without Arms	155
Task Stool with Fixed Arms	72-74		
Task Stool without Arms	76-78	X99® Seating	
Sled Base Chair	79	General Specifications	157-160
4 Leg Base Chair	80	General Guidelines for Product Specification	159
		Executive Chair with 3D Arms	161-163
		Executive Chair with Loop Arms	164-165
		Executive Chair without Arms	166-167
		Task Chair with 3D Arms	169-171
		Task Chair with Loop Arms	172-173
		Task Chair without Arms	174-175
		Guest Chair	176
		Seminar Chair with Arms	177
		Seminar Chair without Arms	178
		Advanced Seminar Chair with Arms	179
		Advanced Seminar Chair without Arms	180
		Improv® Series	
Very® Seating		General Specifications	181-184
General Specifications	81, 86, 97, 101, 112, 119-123	General Guidelines for Product Specification	185
Wire Stacker with Arms	82	High-Back Chair with Arms	186
Wire Stacker without Arms	83	High-Back Chair with Height Adjustable Arms	187
Wire Stool	84	High-Back Chair without Arms	188
Counter Height Wire Stool	85	Mid-Back Chair with Arms	189
Side Chair - Perforated with Arms	87	Mid-Back Chair with Height Adjustable Arms	190
Side Chair - Perforated without Arms	88	Mid-Back Chair without Arms	191
Side Chair - Perforated with Tablet Arm	89	Improv H.E. XL Chair with Task Arms	192-193
Side Chair - Perforated with Storage Rack with Arms	90	Improv H.E. XL Chair with Height Adjustable Task Arms	194-195
Side Stool - Perforated	91	Improv H.E. XL Chair with Flipper Arms	196-197
Counter Height Side Stool - Perforated	92	Improv H.E. XL Chair without Arms	199
Seminar Chair - Perforated with Arms	93	Improv H.E. High-Back Chair with Task Arms	200-201
Seminar Chair - Perforated without Arms	94	Improv H.E. High-Back Chair with Height Adjustable Task Arms	202-203
Seminar Chair with Tablet Arm	95	Improv H.E. High-Back Chair with Flipper Arms	204-205
Seminar Chair with Storage Rack	96	Improv H.E. High-Back Chair with Height and Width Adjustable 3-D Arms	206
Conference Chair - Perforated with Arms	98	Improv H.E. High-Back Chair without Arms	207
Conference Chair - Perforated without Arms	99	Improv H.E. Mid-Back Chair with Task Arms	208-209
Conference Stool - Perforated	100	Improv H.E. Mid-Back Chair with Height Adjustable Task Arms	210-211
Side Chair - Tetro Back with Arms	102		
Side Chair - Tetro Back without Arms	103		
Side Chair - Tetro Back with Tablet Arm	104		
Side Chair - Tetro Back with Storage Rack	105		
Side Stool - Tetro Back	106		
Counter Height Side Stool - Tetro Back	107		
Seminar Chair - Tetro Back with Arms	108		
Seminar Chair - Tetro Back without Arms	109		
Seminar Chair - Tetro Back with Tablet Arm	110		
Seminar Chair - Tetro Back with Storage Rack	111		
Conference Chair - Tetro Back with Arms	113		
Conference Chair - Tetro Back without Arms	114		
Conference Stool - Tetro Back	115		

Table of Contents

Improv H.E. Mid-Back Chair with Flipper Arms	212-213
Improv H.E. Mid-Back Chair with Height and Width Adjustable 3-D Arms	214
Improv H.E. Mid-Back Chair without Arms	215
Improv H.E. Stool with Task Arms	216-217
Improv H.E. Stool with Height Adjustable Task Arms	218-219
Improv H.E. Stool with Flipper Arms	220-221
Improv H.E. Stool with Height and Width Adjustable 3-D Arms	222
Improv H.E. Stool without Arms	223
Improv S.E. Mesh-Back Chair without Arms	224
Improv S.E. Mesh-Back Chair with Task Arms	226-227
Improv S.E. Mesh-Back Chair with Height Adjustable Task Arms	228-229
Improv S.E. Mesh-Back Chair with Flipper Arms	230-231
Improv S.E. Mesh-Back Chair with Height and Width Adjustable 3-D Arms	232
Improv Tag General Specifications	233
Improv Tag, Mesh Back Chair without Arms	234
Improv Tag, Mesh Back Chair with Fixed-Height Task Arms	235
Improv Tag, Mesh Back Chair with Height-Adjustable Task Arms	236
Improv Tag, Mesh Back Chair with Height- and Width-Adjustable 3-D Arms	237
Leg-Base Stacking Chair with Arms	238
Leg-Base Stacking Chair without Arms	239
Leg-Base Stacking Chair with Tablet Arm	240
Sled-Base Chair with Arms	241
Sled-Base Chair without Arms	242
Sled-Base Chair with Tablet Arm	243
Stool with Arms	244
Stool without Arms	244
Stacking Dolly	245
Book Rack	245
Tandem Seating and Tables Specifications	246
Tandem Seating and Tables Dimensions	247
Tandem Tables and Connecting Bars	248
Occasional Tables	249

LOOK®

General Specifications	251-252
High-Back Chair without Arms	253
High-Back Chair with Fixed Arms	254
High-Back Chair with Height Adjustable Arms	255
High-Back Chair with Height and Width Adjustable Arms	256
Mid-Back Chair without Arms	257
Mid-Back Chair with Fixed Arms	258
Mid-Back Chair with Height Adjustable Arms	259
Mid-Back Chair with Height and Width Adjustable Arms	260
Side Chair without Arms	261
Side Chair with Arms	262
Lounge Chair	263

Accolade® Seating

General Specifications	265-267
General Guidelines for Product Specification	268
High-Back Chair with Cantilever Arms	269
High-Back Chair without Arms	270
Mid-Back Chair with Cantilever Arms	271
Mid-Back Chair without Arms	272
Sled-Base Side Chair	273

Executive Seating

Monaco®

General Specifications	275-276
General Guidelines for Product Specification	276
Large High-Back Chair with Open Arms	277
Large High-Back Chair with Enclosed Arms	278
Medium High-Back Chair with Open Arms	279
Medium High-Back Chair with Enclosed Arms	280
Large Mid-Back Chair with Open Arms	281
Large Mid-Back Chair with Enclosed Arms	282
Medium Mid-Back Chair with Open Arms	283
Medium Mid-Back Chair with Enclosed Arms	284

Prescott™ Series

High-Back Chair, Fully-Upholstered Arm/Polypropylene Base	285
High-Back Chair, Fully-Upholstered Arm with Wood Arm Trim/Polypropylene Base	285
High-Back Chair, Fully-Upholstered Arm/Wood Base	285
High-Back Chair, Fully-Upholstered Arm with Wood Arm Trim/Wood Base	286
Mid-Back Chair, Fully-Upholstered Arm/Polypropylene Base	286
Mid-Back Chair, Fully-Upholstered Arm with Wood Arm Trim/Polypropylene Base	286
Mid-Back Chair, Fully-Upholstered Arm/Wood Base	287
Mid-Back Chair, Fully-Upholstered Arm with Wood Arm Trim/Wood Base	287

Stack Seating

System 12

General Specifications	289
General Guidelines for Product Specification	289
High-Density Stacking Chair with Arms	290
High-Density Stacking Chair without Arms	290
Tablet Board	291
Stacking Cart	291
Book Rack	291

Wood Side Seating and Tables

General Specifications	293
General Guidelines for Product Specification	293

Candor® Seating

Classic Fully Upholstered Seat and Back	294
Classic Fully Upholstered Seat and 3/4 Back	294
Classic Fully Upholstered Seat and Slat Back	294
Modern Fully Upholstered Seat and Back	295
Modern Fully Upholstered Seat and 1/2 Back	295
Modern Fully Upholstered Seat and Slat Back	295

Composites™ Seating Series

Arc Arm, Upholstered Back	296
Arc Arm, Circle Back	296
Arc Arm, Slat Back	296
Repose Arm, Upholstered Back	297
Repose Arm, Hourglass Back	297
Repose Arm, Cross Back	297
Cascade Arm, Upholstered Back	298
Cascade Arm, Circle Back	298
Cascade Arm, Slat Back	298
Contour Arm, Upholstered Back	299
Contour Arm, Hourglass Back	299

Table of Contents

Contour Arm, Cross Back299	Cup Holder332
Stacking Chair, Arc Arm, Upholstered Back300	Grommet Cover332
Stacking Chair, Arc Arm, Slat Back300	Ottoman333
Stool, Armless, Upholstered Back301		
Stool, Armless, Slat Back301		
Forenze™ Seating			
Serpentine Arm, Ellipse Back302		
Serpentine Arm, Wave Back302		
Serpentine Arm, Upholstered Back302		
Curve Arm, Ellipse Back303		
Curve Arm, Wave Back303		
Curve Arm, Upholstered Back303		
Scroll Arm, Star Back304		
Scroll Arm, Slat Back304		
Scroll Arm, Upholstered Back304		
Cabriole Arm, Star Back305		
Cabriole Arm, Slat Back305		
Cabriole Arm, Upholstered Back305		
Openest™ Collection			
Plume 3306		
Plume 6306		
Plume 9306		
Feather – Symmetrical307		
Feather – Asymmetrical307		
Chick Pouf with Back308		
Chick Pouf without Back308		
Rectangle309		
Round309		
Poppy™			
Poppy-At-A-Glance311		
Four Star Base with Glides312		
Five Star Base with Casters312		
Wood Base313		
Harbor Work Lounge®			
Harbor Work Lounge-At-A-Glance315		
Fully Upholstered, Cast Aluminum Base Lounge Chair316		
Fully Upholstered, Cast Aluminum Base Ottoman317		
Partially Upholstered, Cast Aluminum Base Lounge Chair318		
Partially Upholstered, Cast Aluminum Base Ottoman319		
Lounge			
Hello® Seating			
Lounge with Legs, Standard Arm320		
Mobile Lounge, Standard Arm321		
Tablet Arm322		
Cup Holder322		
Mini-mobile322		
Guest Seating Fixed Arms, Wood Legs323		
Guest Seating Fixed Arms, Metal Legs324		
Stools Fixed Arms, Metal Legs325		
ToDo®			
General Specifications326-327		
Single, Stationary328		
Single, Mobile329		
Double, Stationary330		
Triple, Stationary331		
Wood Tablet with Arm332		
		Open Lounge Seating334
		Fully Upholstered Lounge Seating and Tables335
		Preconfigured Seating, Seat, Seat336
		Preconfigured Seating, Seat, Seat, Seat336
		Preconfigured Seating, Seat, Table, Seat336
		Preconfigured Seating, Table, Seat, Seat337
		Preconfigured Seating, Seat, Seat, Table337
		Preconfigured Seating, Seat, Seat, Seat, Seat338
		Preconfigured Seating, Seat, Table, Seat, Seat338
		Preconfigured Seating, Seat, Seat, Table, Seat338
		Preconfigured Seating, Table, Seat, Seat, Seat339
		Preconfigured Seating, Seat, Seat, Seat, Table339
		Modular Seating Specifications340
		Modular Seating Dimensions341
		Starter Seat with Right Arm342
		Starter Seat with Left Arm342
		Starter Seat with Right and Left Arms342
		Starter Seat without Arms343
		Add-on Seat with Right Arm344
		Add-on Seat without Arm344
		Right End Table345
		Left End Table345
		Add-on In-Line Table346
		Add-on Square Corner Table346
		Add-on Radius Corner Table346
		Bariatric Lounge Seating347
		Galerie™ Collection	
		Leg-Base Chair, Fully-Upholstered348
		Lounge Chair348
		Settee348
		Sofa348
		Occasional Tables349-350
		Tuxedo™ Series	
		Lounge Chair351
		Settee351
		Sofa351
		Public Seating, Education Seating and Stools	
		Seating and Tables	
		General Specifications352-353
		General Guidelines for Product Specification353
		K120 Series, Sled Base with Arms, Open-Frame Base354
		K120 Series, Ganging Clip354
		K100 Series, Public Seating Specifications355
		K100 Series, Seats and Table356
		K100 Series, Corner Connecting Tables357
		K100 Series, Support Beams358-359
		Scamps™ Series, Chair with Arms360
		Scamps Series, Round Table360
		Tilt Stool361

Table of Contents

Finishes and Fabrics

Finish/Color Legends362-365
Fabric Pattern Usage Matrix366
Haworth Fabrics/Color Legend367-369
COM Information370

Terms of Sale

North America371-374
-------------------------	----------

Index375-382
------------------------	----------

Product WarrantyInside Back Cover
-----------------------------------	--------------------

Product Directory

Fern Task Chairs — pages 24-32



SFT-U0-7501A5 SFT-U0-7502A SFT-U0-4502A SFT-U0-1502A SFT-U0-0N02A

Fern Task Stools — pages 33-40



SFS-U0-7502A SFS-U0-4502A SFS-U0-1502A SFS-U0-0N02A

Zody Seating Task Chairs — pages 48-57



SZT-20-711MA5 SZT-20-702MA1 SZT-20-402MA1 SZT-20-102MA1

Zody Seating Task Chairs — page 61



SZT-20-002MA1

Zody Seating Task Stools — pages 64-76



SZTC-20-702MA1 SZTC-20-402MA1 SZTC-20-102MA1 SZTC-20-002MA1

Zody Seating — pages 79-80



SZG-22-1S SZG-22-1H

Very Wire Stacker — pages 82-85

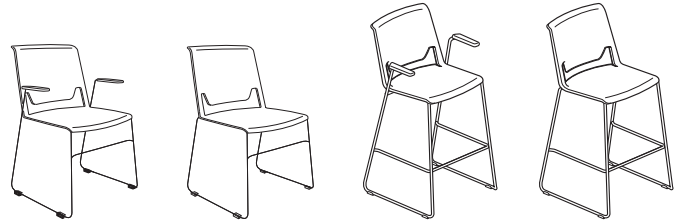

SCH-44-3S SCH-44-0S SCW-44-3S SCW-44-0S

Very Side Chair — Perforated — pages 87-88

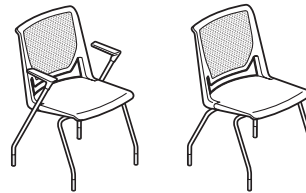

SCS-44-3H SCS-44-0H

Very Side Chair/Stool — Perforated Back — pages 89-92

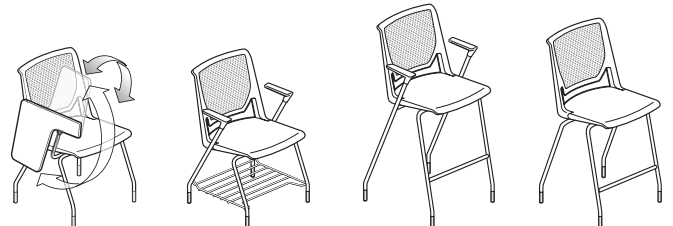

SCS-44-RH SCK-44-3H SCLC-44-3H SCLC-44-0H

Very Seminar Chair — Perforated — pages 93-94

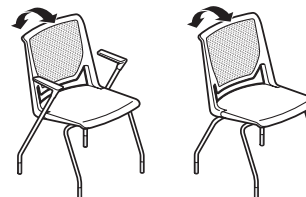

SCM-44-3H SCM-44-0H

Product Directory

Very Seminar with Tablet Arm/Storage Rack — pages 95-96



SCM-44-RH



SCB-44-3H



SCB-44-0H

Very Conference Chair — Perforated — pages 98-99



SCC-44-11



SCC-44-01

Very Conference Stool — Perforated — page 100



SCF-44-11



SCF-44-01

Very Side Chair — Tetro Back — pages 102-103



SCS-45-3H



SCS-45-0H

Very Side Chair with Tablet Arm — Tetro Back — page 104



SCS-45-RH

Very Side Chair with Storage Rack — Tetro Back — page 105



SCK-45-3H

Very Side Stool — Tetro Back — pages 106-107



SCL-45-3H



SCL-45-0H

Very Seminar Chair — Tetro Back — pages 108-109



SCM-45-3H



SCM-45-0H

Very Seminar with Tablet Arm — Tetro Back — page 110



SCM-45-RH

Very Seminar with Storage Rack — Tetro Back — page 111



SCB-45-3H

Very Conference Chair — Tetro Back — pages 113-114



SCC-45-11



SCC-45-01

Product Directory

Very Conference Stool — Tetro Back — page 115

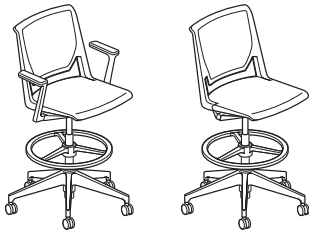

SCF-45-11

SCF-45-01

Very Accessories — pages 116-117

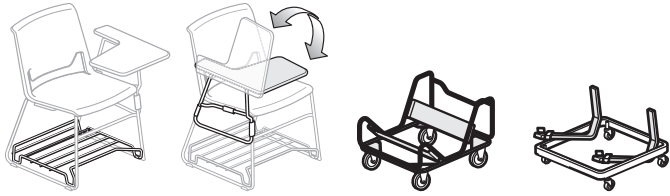

SCHR-1

SCHA-R

SCT-1

SCT-3
SCT-4

Very Task Chairs — pages 124-132



SCT-20-7115

SCT-20-7011

SCT-20-4011

SCT-20-1011

SCT-20-0011

Very Task Stools — pages 134-140



SCTC-20-7011

SCTC-20-4011

SCTC-20-1011

SCTC-20-0011

Lively Task Chairs — pages 149-153



SLT1-2T-7115A

SLT1-2T-7115A

SLT1-2T-4115A

SLT1-2T-1115A

SLT1-2T-0115A

Lively Side Chair — pages 154-155

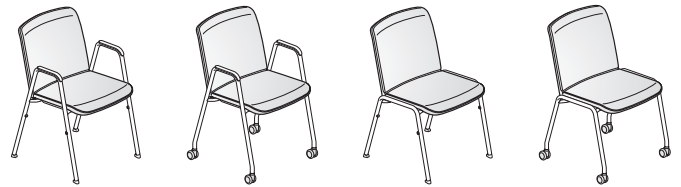

SLS1-2T-1H

SLS1-2T-11

SLS1-2T-0H

SLS1-2T-01

X99 Executive Seating — pages 161-167



X611-2W40
X611-2W44

X611-2140
X611-2144

X611-2040
X611-2044

X99 Task & Guest Seating — pages 169-176



X621-2W40
X621-2W44

X621-2140
X621-2144

X621-2040
X621-2044

X630-3100

X99 Seminar Chairs — pages 177-180



X640-0140

X640-0040

X641-2140

X641-2040

Improv Series High-Back Chairs — pages 186-188



M221-1142

M221-1742

M221-1042

Product Directory

Improv Series Mid-Back Chair — pages 189-191



M211-1142 M211-1742 M211-1042

Improv Series H.E. XL Chairs — pages 192-199



M271-1442 M271-1742 M271-1H42 M271-1042

Improv Series H.E. High-Back Chairs — pages 200-206

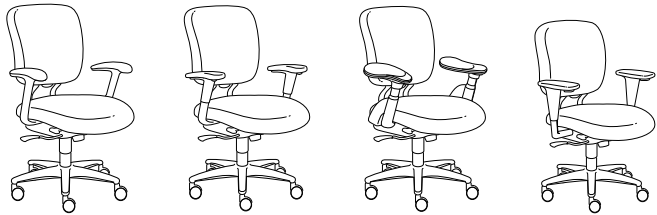

M251-1442 M251-1742 M251-1H42 M251-1W42

Improv Series H.E. High-Back Chairs — page 207



M251-1042

Improv Series H.E. Mid-Back Chairs — pages 208-211



M231-1442 M231-1742

Improv Series H.E. Mid-Back Chairs — pages 212-215



M231-1H42 M231-1W42 M231-1042

Improv Series H.E. Stools — pages 216-222



M2E1-1442 M2E1-1742 M2E1-1H42 M2E1-1W42

Improv Series H.E. Stools — page 223

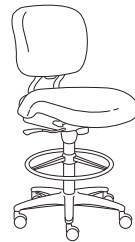

M2E1-1042

Improv Series S.E. Mesh Back Chair without Arms — page 224



M235-3042

Improv Series S.E. Mesh-Back Chair with Arms — pages 226-232

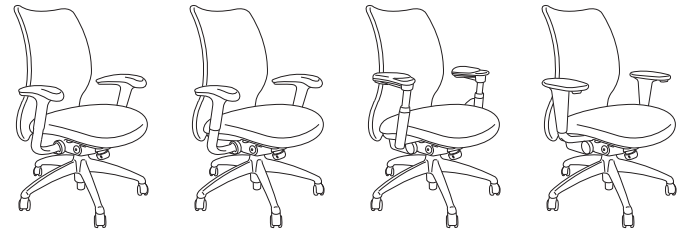

M235-3442 M235-3742 M235-3H42 M235-3W42

Improv Tag Mesh Back Chairs — pages 234-237

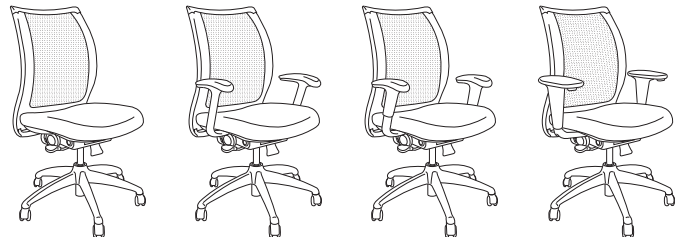

F235-2042 F235-2442 F235-2742 F235-2W42

Product Directory

Improv Series Leg-Base Stacking Chairs — page 238

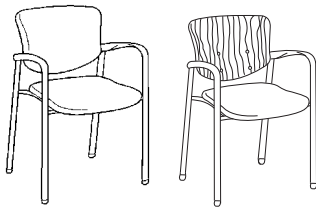

M600-2110

M600-2310

Improv Series Leg-Base Stacking Chairs without Arms — page 239

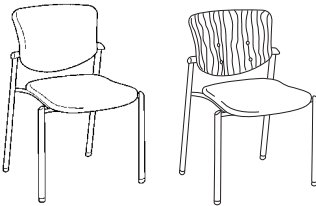

M600-2100

M600-2300

Improv Series Leg Base Chair with Tablet Arm — page 240



M600-2190

Improv Series Sled-Base Chairs — pages 241-242

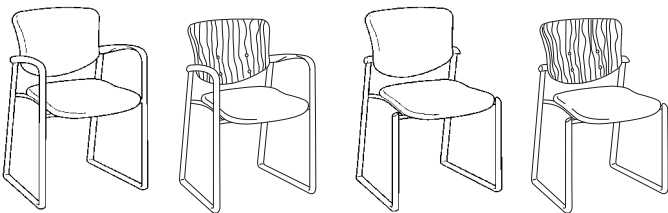

M601-2110

M601-2310

M601-2100

M601-2300

Improv Series Sled-Base Chair with Tablet Arm — page 243

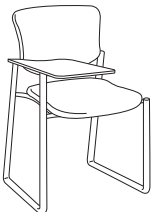

M601-2190

Improv Series Stools — page 244

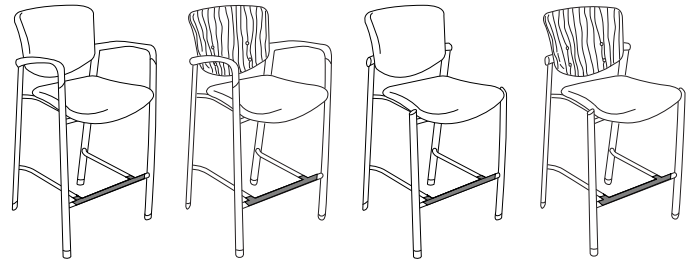

M600-8110

M600-8310

M600-8100

M600-8300

Improv Series Stacking Dolly and Book Rack — page 245

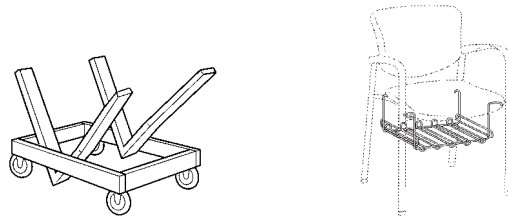

MPRV-CART

MPRV-RACK

Improv Series Tandem In-Line Table — page 248

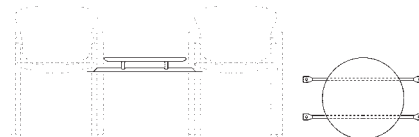

MTI1-20

Improv Series Tandem End-of-Run Table — page 248

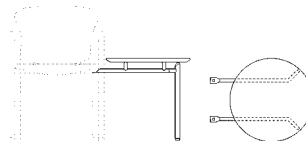

MTE1-20

Improv Series Occasional Tables — page 249



MTR1-20

MTV1-2048

LOOK High-Back Chairs — pages 253-256



Z851-1042

Z851-1442

Z851-1742

Z851-1W42

Product Directory

LOOK Mid-Back Chairs — pages 257-260



Z831-1042 Z831-1442 Z831-1742 Z831-1W42

Accolade Sled-Base Side Chairs — page 273



A802-3110

LOOK Side Chairs — pages 261-262

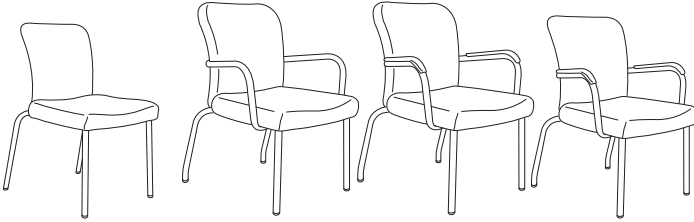

Z600-2100 Z600-2210 Z600-2230 Z600-2130

Monaco High-Back Chairs — pages 277-280

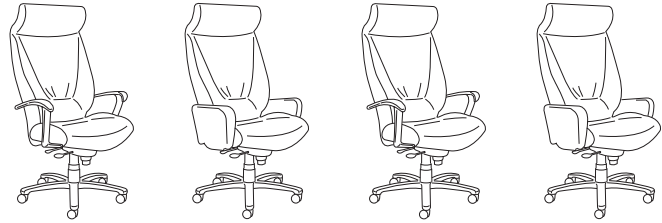

D811-2240 D811-2640 D821-2240 D821-2640

LOOK Lounge Chairs — page 263



Z600-2440

Monaco Mid-Back Chairs — pages 281-284



D831-2240 D831-2640 D841-2240 D841-2640

Accolade High-Back Chairs — pages 269-270

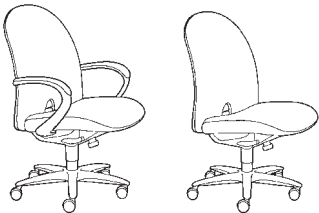

A871-1142 A871-1042

Prescott Series — pages 285-286



5215-32 5210-32

Accolade Mid-Back Chairs — pages 271-272

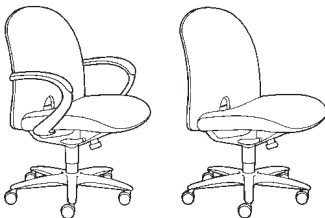

A831-1142 A831-1042

Prescott Series — pages 286-287



5225-32 5220-32

System 12 High-Density Stacking Chairs — page 290

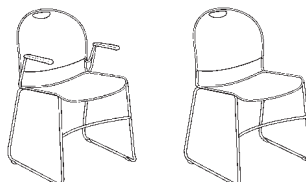

1201-2110 1200-2100

Product Directory

System 12 Accessories — page 291

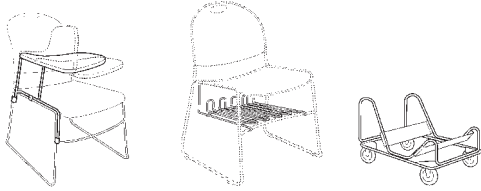

TABR-12

BOOK-12

CART-12

Wood Seating

Candor Classic Seating — page 294



SAS-22-A1B

SAS-22-A2B

SAS-2W-A4B

Candor Modern Seating — page 295



SAS-22-A1A

SAS-22-A3A

SAS-2W-A4A

Composites Arc Arm Models — page 296

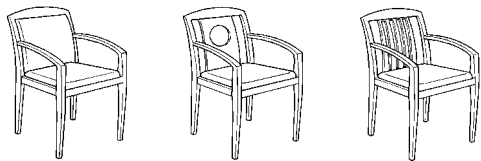

4045-00

4145-00

4245-00

Composites Repose Arm Models — page 297

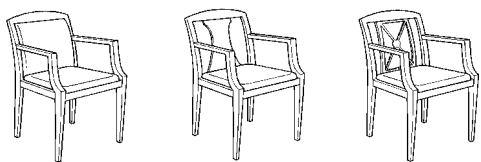

4046-00

4146-00

4246-00

Composites Cascade Arm Models — page 298

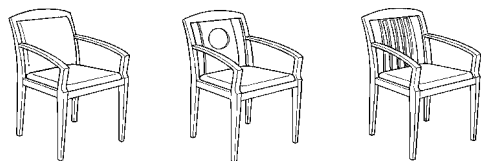

4047-00

4147-00

4247-00

Composites Contour Arm Models — page 299

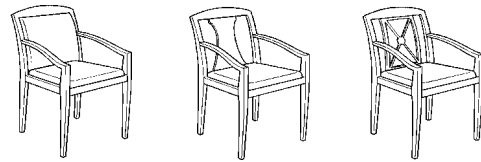

4048-00

4148-00

4248-00

Composites Stacking Chairs — page 300

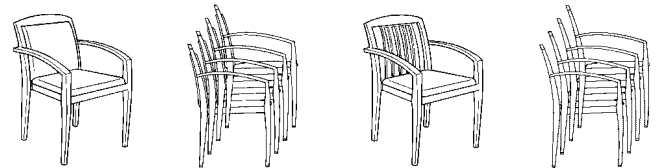

4043-00

4243-00

Composites Stools — page 301

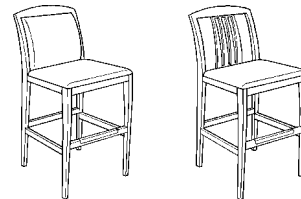

4049-00

4249-00

Forenze Serpentine Arm Models — page 302



8381-00

8281-00

8181-00

Forenze Curve Arm Models — page 303



8382-00

8282-00

8182-00

Forenze Scroll Arm Models — page 304



8583-00

8483-00

8183-00

Product Directory

Forenze Cabriole Arm Models — page 305



8584-00



8484-00



8184-00

Openest Collection Plume Screens — page 306

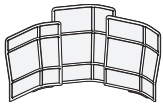

SON-3

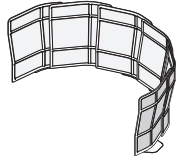

SON-6

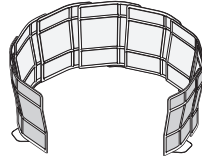

SON-9

Openest Collection Feather Sofa — page 307

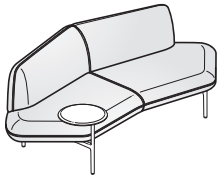

SOSS-1-RW

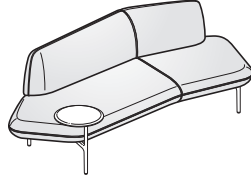

SOSR-1-RW

Openest Collection Chick Pouf — page 308

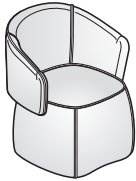

SOPB-22

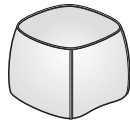

SOPN-22

Openest Collection Sprig Tables — page 309

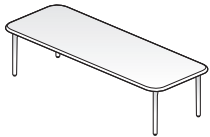

SORA-5320-P



SODC-1616-P



SODB-2424-P

Poppy — pages 312-313



SPG-11-4



SPG-11-5



SPG-11-W

Harbor Work Lounge — pages 316-319



SHL-22-1R10



SHL-22-1R12



SHO-22-G



SHL-25-1L10



SHL-25-1L12



SHO-25-G

Hello Lounge Seating with Legs — page 320

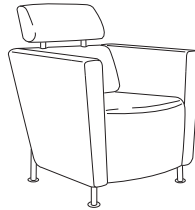

4854-0011

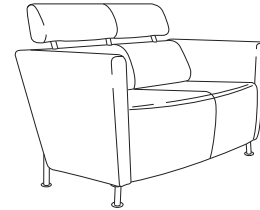

4854-0012

Hello Mobile Lounge Seating — page 321

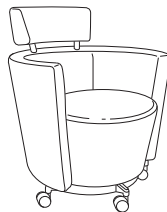

4855-0043

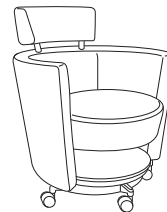

4855-0043-S



4855-0043-GSX

Hello Seating Accessories — page 322



4858-0001



4858-0002

Hello Seating Mini-Mobile — page 322

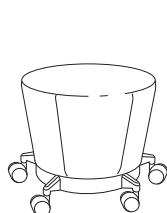

4856-0043

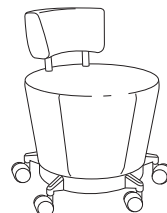

4856-0043-A

Product Directory

Hello Guest Seating/Stools — pages 323-325

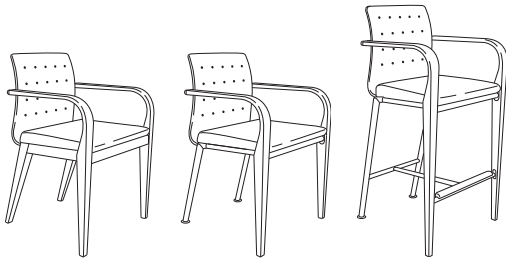

4851-0011-W 4851-0011 4852-0011

ToDo Stationary & Mobile Seating — pages 328-329

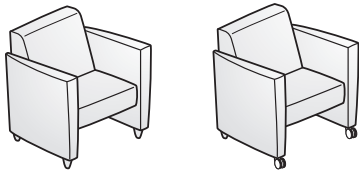

TQ84-0011 TQ85-0011

ToDo Stationary Seating — pages 330-331

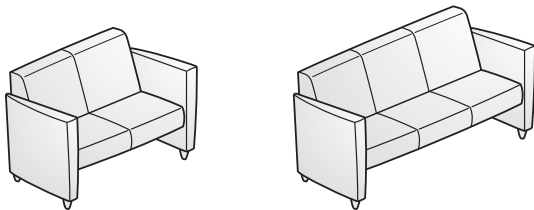

TQ84-0012 TQ84-0013

ToDo Accessories — page 332



Wood Tablet TQ90-0001 Cup Holder TQ90-0003 Grommet Cover TQ90-0006

ToDo Ottoman — page 333

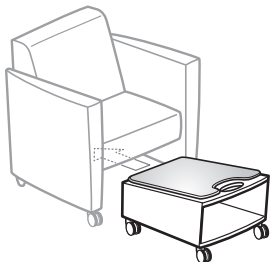

TQ90-0004

Tempo Open Frame Lounge — page 334

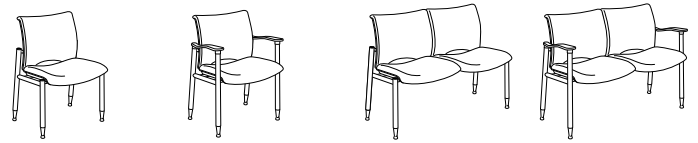

KL01-7200 KL01-7210/7220 KL02-7200 KL02-7210/7220

Tempo Fully Upholstered Lounge — page 335



KLU1-7220 KLU2-7220 KLU3-7220

Tempo Series Occasional Tables — page 335



KLT8-1818 KLT1-3030

Tempo Preconfigured Seating — page 336



KLP2-7210 KLP3-7210 KLPJ-7210

Tempo Preconfigured Seating — page 337

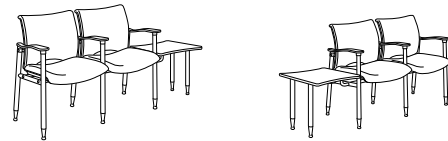

KLPK-7210 KLPL-7210

Tempo Preconfigured Seating — page 338

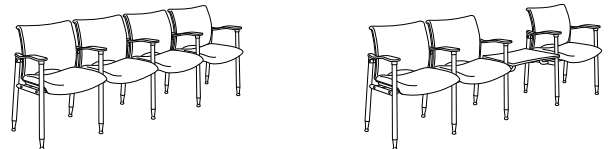

KLP4-7210 KLPM-7210

Tempo Preconfigured Seating — page 338



KLPN-7210

Product Directory

Tempo Preconfigured Seating — page 339

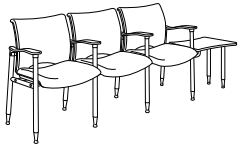

KLPP-7210



KLPO-7210

Tempo Modular Starter Seats — pages 342-343



KLCS-7210-R

KLCS-7210-L

KLCS-7210-B

KLCS-7200-N

Tempo Modular Add-on Seats — page 344

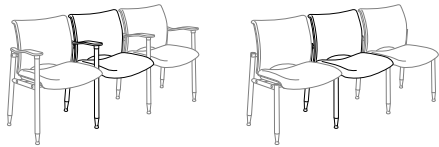

KLCA-7210-R

KLCA-7200-N

Tempo Modular Starter Tables — page 345

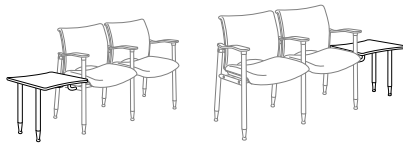

KLCE-7TQ0-R

KLCE-7TQ0-L

Tempo Modular Add-on Tables — page 346



KLCI-7TQ0

KLCC-7TQ0

KLCC-7TA0

Tempo Bariatric Lounge Seating — page 347

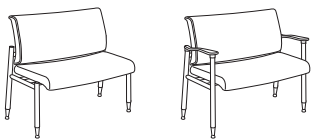

KLB1-7200

KLB1-7220

Galerie Collection Lounge Seating — page 348



4080-00

180-0028

180-0053

180-0075

Galerie 5800 Series Tables — page 349

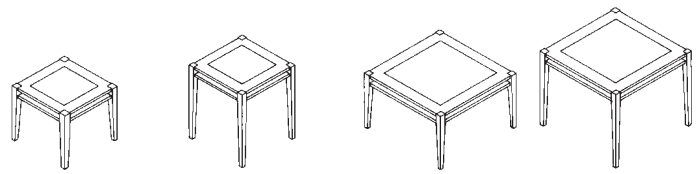

5818-1816

5818-1822

5826-2616

5826-2622

Galerie 5900 Series Tables — page 350

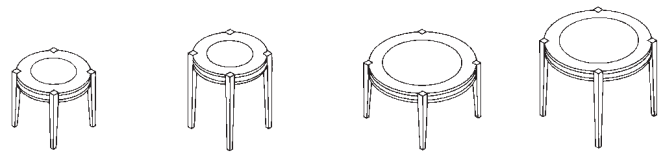

5918-1816

5918-1822

5926-2616

5926-2622

Tuxedo Series Lounge Seating — page 351

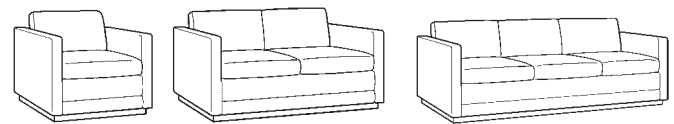

2006-0031

2006-0056

2006-0072

K120 Series Guest/Occasional Seating — page 354

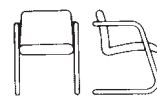

K120-2210

K100 Series/Public Seating — page 356



K156-221

K156-220

KPT9-2124

K100 Series/Public Seating — page 357

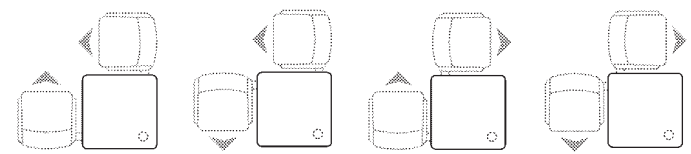

KPT0-2929

KPT1-2929

KPT2-2929

KPT3-2929

Product Directory

K100 Series/Public Seating Beams — pages 358-359

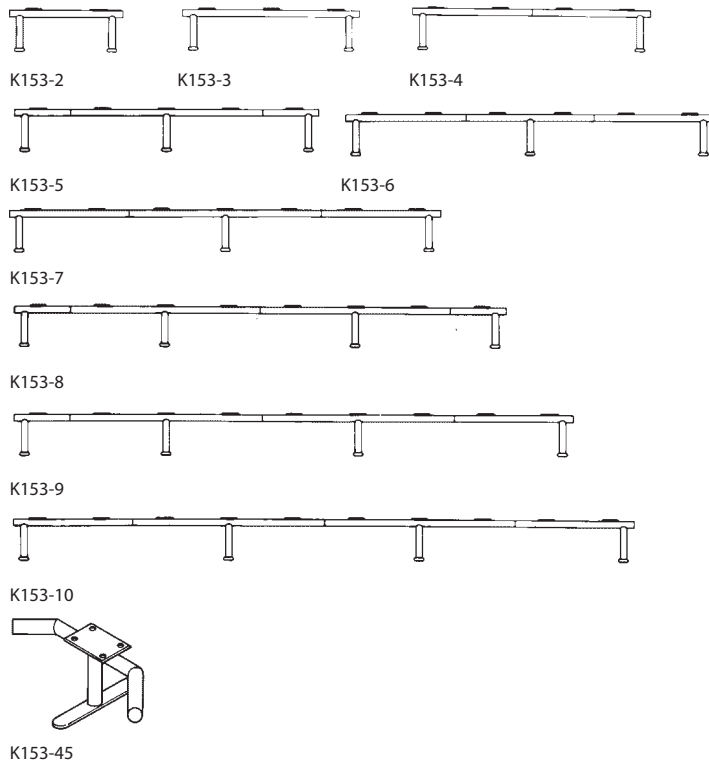

K100 Scamps Series Children's Furniture — page 360

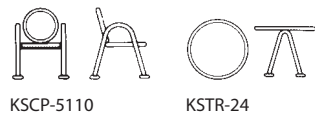

Tilt Stool — page 361

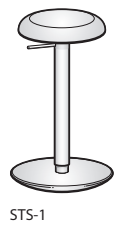

This page intentionally blank

Fern

General Specifications

General Guidelines for Product Specification

	<u>S</u>	<u>F</u>	<u>T - U</u>	<u>0 - 1</u>	<u>S</u>	<u>1</u>	<u>4</u>	<u>A</u>	<u>T</u>	<u>3A-18</u>	<u>MB-BE</u>	<u>TR-F</u>	<u>TR-TF</u>
Product Type	_____	_____	_____	_____	_____	_____	_____	_____	_____	_____	_____	_____	_____
(S) Seating	_____	_____	_____	_____	_____	_____	_____	_____	_____	_____	_____	_____	_____
Product Line	_____	_____	_____	_____	_____	_____	_____	_____	_____	_____	_____	_____	_____
(F) Fern	_____	_____	_____	_____	_____	_____	_____	_____	_____	_____	_____	_____	_____
Model (Product Type)	_____	_____	_____	_____	_____	_____	_____	_____	_____	_____	_____	_____	_____
(T) Task	_____	_____	_____	_____	_____	_____	_____	_____	_____	_____	_____	_____	_____
(S) Stool	_____	_____	_____	_____	_____	_____	_____	_____	_____	_____	_____	_____	_____
(E) Executive	_____	_____	_____	_____	_____	_____	_____	_____	_____	_____	_____	_____	_____
Seat (UPH)	_____	_____	_____	_____	_____	_____	_____	_____	_____	_____	_____	_____	_____
(U) Upholstery	_____	_____	_____	_____	_____	_____	_____	_____	_____	_____	_____	_____	_____
Back Upholstery	_____	_____	_____	_____	_____	_____	_____	_____	_____	_____	_____	_____	_____
(0) Knit	_____	_____	_____	_____	_____	_____	_____	_____	_____	_____	_____	_____	_____
(U) Upholstery	_____	_____	_____	_____	_____	_____	_____	_____	_____	_____	_____	_____	_____
Arms	_____	_____	_____	_____	_____	_____	_____	_____	_____	_____	_____	_____	_____
(0) No Arms	_____	_____	_____	_____	_____	_____	_____	_____	_____	_____	_____	_____	_____
(1) Fixed Arms	_____	_____	_____	_____	_____	_____	_____	_____	_____	_____	_____	_____	_____
(4) Height Adjustable	_____	_____	_____	_____	_____	_____	_____	_____	_____	_____	_____	_____	_____
(7) 4D Arms	_____	_____	_____	_____	_____	_____	_____	_____	_____	_____	_____	_____	_____
Arm Cap	_____	_____	_____	_____	_____	_____	_____	_____	_____	_____	_____	_____	_____
(S) Soft Cap	_____	_____	_____	_____	_____	_____	_____	_____	_____	_____	_____	_____	_____
(N) No Cap	_____	_____	_____	_____	_____	_____	_____	_____	_____	_____	_____	_____	_____
(L) Leather Cap (fixed arms only)	_____	_____	_____	_____	_____	_____	_____	_____	_____	_____	_____	_____	_____
Lumbar	_____	_____	_____	_____	_____	_____	_____	_____	_____	_____	_____	_____	_____
(0) No Lumbar	_____	_____	_____	_____	_____	_____	_____	_____	_____	_____	_____	_____	_____
(1) Lumbar	_____	_____	_____	_____	_____	_____	_____	_____	_____	_____	_____	_____	_____
Control	_____	_____	_____	_____	_____	_____	_____	_____	_____	_____	_____	_____	_____
(1) Pneumatic w/Back Stop	_____	_____	_____	_____	_____	_____	_____	_____	_____	_____	_____	_____	_____
(2) Pneumatic Synchronized Tilt	_____	_____	_____	_____	_____	_____	_____	_____	_____	_____	_____	_____	_____
(4) Pneumatic/Back Stop & Forward Tilt	_____	_____	_____	_____	_____	_____	_____	_____	_____	_____	_____	_____	_____
Seat Adjustment	_____	_____	_____	_____	_____	_____	_____	_____	_____	_____	_____	_____	_____
(A) Adjustable	_____	_____	_____	_____	_____	_____	_____	_____	_____	_____	_____	_____	_____
(F) Fixed	_____	_____	_____	_____	_____	_____	_____	_____	_____	_____	_____	_____	_____
Base & Caster Combo	_____	_____	_____	_____	_____	_____	_____	_____	_____	_____	_____	_____	_____
(1) Aluminum Hard Casters	_____	_____	_____	_____	_____	_____	_____	_____	_____	_____	_____	_____	_____
(2) Aluminum Soft Casters	_____	_____	_____	_____	_____	_____	_____	_____	_____	_____	_____	_____	_____
(T) Aluminum 2 Tone Hard Casters	_____	_____	_____	_____	_____	_____	_____	_____	_____	_____	_____	_____	_____
(5) Plastic Hard Casters	_____	_____	_____	_____	_____	_____	_____	_____	_____	_____	_____	_____	_____
(6) Plastic Soft Casters	_____	_____	_____	_____	_____	_____	_____	_____	_____	_____	_____	_____	_____
(7) Plastic 2 Tone Hard Casters	_____	_____	_____	_____	_____	_____	_____	_____	_____	_____	_____	_____	_____
(3) Aluminum Low Hard Casters	_____	_____	_____	_____	_____	_____	_____	_____	_____	_____	_____	_____	_____
(4) Aluminum Low Soft Casters	_____	_____	_____	_____	_____	_____	_____	_____	_____	_____	_____	_____	_____
Seat Upholstery	_____	_____	_____	_____	_____	_____	_____	_____	_____	_____	_____	_____	_____
Tellure	_____	_____	_____	_____	_____	_____	_____	_____	_____	_____	_____	_____	_____
Back Mesh	_____	_____	_____	_____	_____	_____	_____	_____	_____	_____	_____	_____	_____
Mesh	_____	_____	_____	_____	_____	_____	_____	_____	_____	_____	_____	_____	_____
Plastic Trim Color	_____	_____	_____	_____	_____	_____	_____	_____	_____	_____	_____	_____	_____
Plastic Model -	_____	_____	_____	_____	_____	_____	_____	_____	_____	_____	_____	_____	_____
(spine/wave suspension material/arm caps/levers/base)	_____	_____	_____	_____	_____	_____	_____	_____	_____	_____	_____	_____	_____
Aluminum Model -	_____	_____	_____	_____	_____	_____	_____	_____	_____	_____	_____	_____	_____
(spine/wave suspension material/arm caps/levers)	_____	_____	_____	_____	_____	_____	_____	_____	_____	_____	_____	_____	_____
Aluminum Trim Color	_____	_____	_____	_____	_____	_____	_____	_____	_____	_____	_____	_____	_____
Plastic Model -	_____	_____	_____	_____	_____	_____	_____	_____	_____	_____	_____	_____	_____
(back and arm upright/mechanism)	_____	_____	_____	_____	_____	_____	_____	_____	_____	_____	_____	_____	_____
Aluminum Model -	_____	_____	_____	_____	_____	_____	_____	_____	_____	_____	_____	_____	_____
(back and arm upright/mechanism/base)	_____	_____	_____	_____	_____	_____	_____	_____	_____	_____	_____	_____	_____

Fern At-A-Glance

General Specifications

Designer	Haworth Design Studio, through collaboration with ITO Design.
Fern	A revolutionary chair, backed by 16 patents and on-going research that blends science-based wellness and comfort with sustainability and international design.
Awards	2016 Best of Year award for Task Seating from Interior Design 2017 Red Dot award: Product Design
Environmental Factors	BIFMA Level 3 certified. Contains up to 95% recyclable materials. Contains 38% recycled content. Fern Task contains up to 26% post-consumer and 12% pre-consumer recycled content. Take Back Program - can be easily disassembled at the end of its useful life. Manufactured in a zero landfill, ISO 14001 certified facility in Holland, MI, USA. PED Sheet available.
Finishes and Fabrics	A complete listing of finishes and fabrics for Fern seating is available in the back of the price list.
COM & COL General Information	To order a COM fabric (Customer's Own Material) contact the Haworth Inquiry Center (1.800.462.8562), your local Haworth dealer, or go to Surfaces.haworth.com >COM library to find out if the COM you have selected has already been tested and approved. The surface collection site also has information on the Haworth+ alliance program with Carnegie, Luna Textiles, and Maharam as well as our industry-leading Pre-Approved COM program. COM fabrics are placed into Grades based on the cost per linear yard. If a fabric's cost exceeds the range of our highest Grade it will be noted as Non-Graded. The product will be priced at Grade A; the COM fabric costs will appear as a separate line item. The fabric charge will be Haworth's purchase cost plus a 4% administrative fee (based on the cost of the fabric). Yardage calculations will include any applicable fabric repeat. COM Leather products will be priced at a leather Grade A; COL costs will appear as a separate line item. The leather costs will be Haworth's purchase cost plus a 4% administrative fee (based on the cost of the leather).
Stain Repellent	Stain repellent available on seat only. To specify add "P" to the end of the product number. Example: SFT-U0-7S02A1P
Shipping Weights/Cube (Including packaging)	<ul style="list-style-type: none"> • Task Chair <ul style="list-style-type: none"> -With arms - 57 lbs. / 19.14 cubic feet -Armless - 53 lbs. / 19.14 cubic feet • Task Stool <ul style="list-style-type: none"> -With arms - 61 lbs. / 22.1 cubic feet -Armless - 57 lbs. / 22.1 cubic feet

Fern At-A-Glance

General Specifications

STANDARD MOBILITY AND ADJUSTABILITY

Seat Height Adjustment

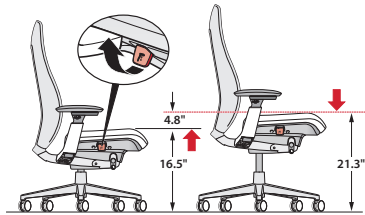

Features:

- Pneumatic seat height adjustment.
- Seat height adjusts 5" (127mm) from 16.5" to 21.5" (406mm-533mm) in standard models. Low-position adjusts from 15" to 17.5".

Benefits:

- Ensures the comfort of the lower limbs by avoiding pressure on the underside of the thigh caused by a seat pan that is too high, or decreased thigh-to-torso angle if the seat is too low.
- Accommodates users between approximately 4'11" (1499mm) and 6'3" (1905mm) tall to provide good leg circulation.
- Seat height adjustment is important in setting the proper hand position and allowing for proper sitting eye height as well.

Seat Depth Adjustment

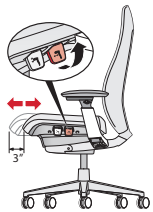

Features:

- Optional seat depth has 3" (76mm) seat depth range. Fixed seat also available.

Benefit:

- Supports the thighs, allows users to rest against the seat back for back support, and avoids pressure on the back of the knees of small to tall users.

Balanced 3-Point Tilt

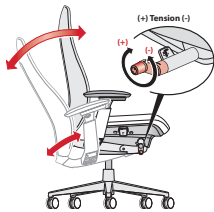

Features:

- Balanced 3-point tilt mechanism.
- Back reclines 24° from the upright position.
- Seat pan moves downward 5° from the initial position.

Benefits:

- Comfortable relaxed posture.
- Recline allows for the opening of the user's chest cavity providing good airflow to promote alertness.
- Users' feet remain flat on the floor.

Tilt Tension Control

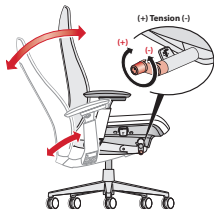

Features:

- Regulates the amount of resistance felt when leaning back in the chair and the effort required to recline the chair backwards.

Benefit:

- Personalized support to accommodate users of different body types and different work styles.

Edgeless Back Design

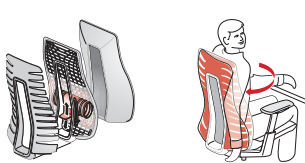

Features:

- Edgeless design provides flexibility.
- Patented design with flexible fronds and cradle system provide total back support.

Benefit:

- Encourages movement, eliminates pressure point from hard edge.

Back Support/ Lumbar Adjustment

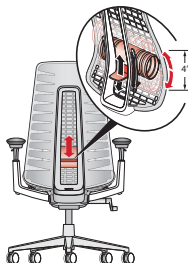

Features:

- Total back support, providing pelvic, to lumbar to thoracic support (upper back).
- Optional height adjustable lumbar.
- Range of 4" of height adjustment.

Benefits:

- Provides additional support in the lower back.
- Lumbar adjustment maintains the natural curvature of the spine at the lower back and allows users to choose the support that feels right for them.
- Integrated passive pelvic support rotates the pelvis forward to maintain the natural spine shape.

Fern At-A-Glance

General Specifications

STANDARD MOBILITY AND ADJUSTABILITY

Back Stop



Features:

- Optional Back Stop stops in 5 positions - upright and every 7° of back angle.

Benefit:

- Allows users the choice of selecting an upright position or limiting the amount of recline while performing different tasks.

Forward Tilt

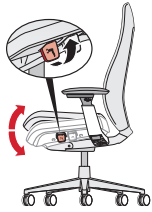

Features:

- Optional forward tilt allows seat pan to move downward 5° from the initial position.

Benefit:

- Allows user the opportunity to vary their posture throughout the day.

4D Arm

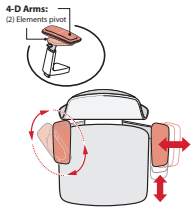

Features:

- Optional 4D arm adjusts in 4 ways:
 - Height adjustment 4.8"
 - Side-to-side arm cap adjustment range: 15" [7.5" each arm cap]
 - Front-to-back adjustment range: 3.5"(89mm)
 - Pivoting 40° in and 40° out

Benefits:

- Height adjustment offers users varying elbow rest heights so that users avoid lifting their shoulders or leaning sideways to get arm support.
- Front-to-back adjustment adjusts the armrest length, which is important because it allows users to get close to the worksurface while maintaining the effective use of the backrest.
- Side-to-side adjustment ensures a comfortable resting position for the arms with proper support of the forearm while allowing for easy entry/exit of the chair.
- Pivoting provides proper support of the forearm when performing tasks involving keying and mousing.

Height Adjustable Arm

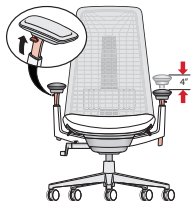

Features:

- Optional height adjustable arms adjust 4.8" vertically.

Benefit:

- Height adjustment accommodates users with varying elbow rest heights so that users avoid lifting their shoulders or leaning sideways to get arm support.

Base

Standard Plastic Base

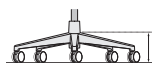

Colors:

Fog, Black

Casters:

Hard: Black or two-tone grey

Soft: Black

Optional Aluminum Base

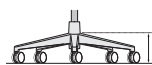

Colors:

Painted Metallic Silver, Metallic Champagne, Pitch (textured black), polished aluminum

Casters:

Hard: Black or two-tone grey

Soft: Black

Low Position Base (Aluminum only)

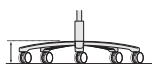

Colors:

Painted Metallic Silver, Metallic Champagne, Pitch (textured black)

Casters:

Hard: Black or two-tone grey

Soft: Black

Fern

General Specifications
UPHOLSTERY / AESTHETIC OPTIONS

Fern Plastic Model

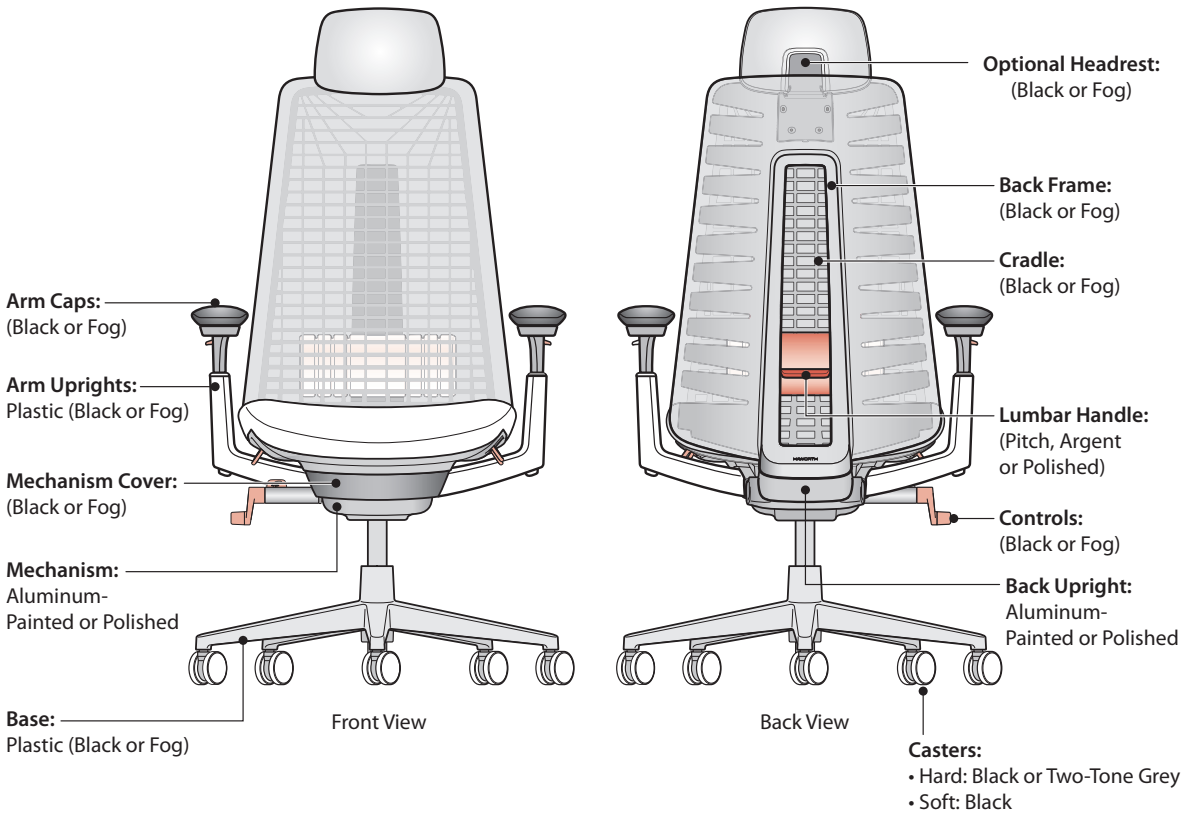

Fern Aluminum Model

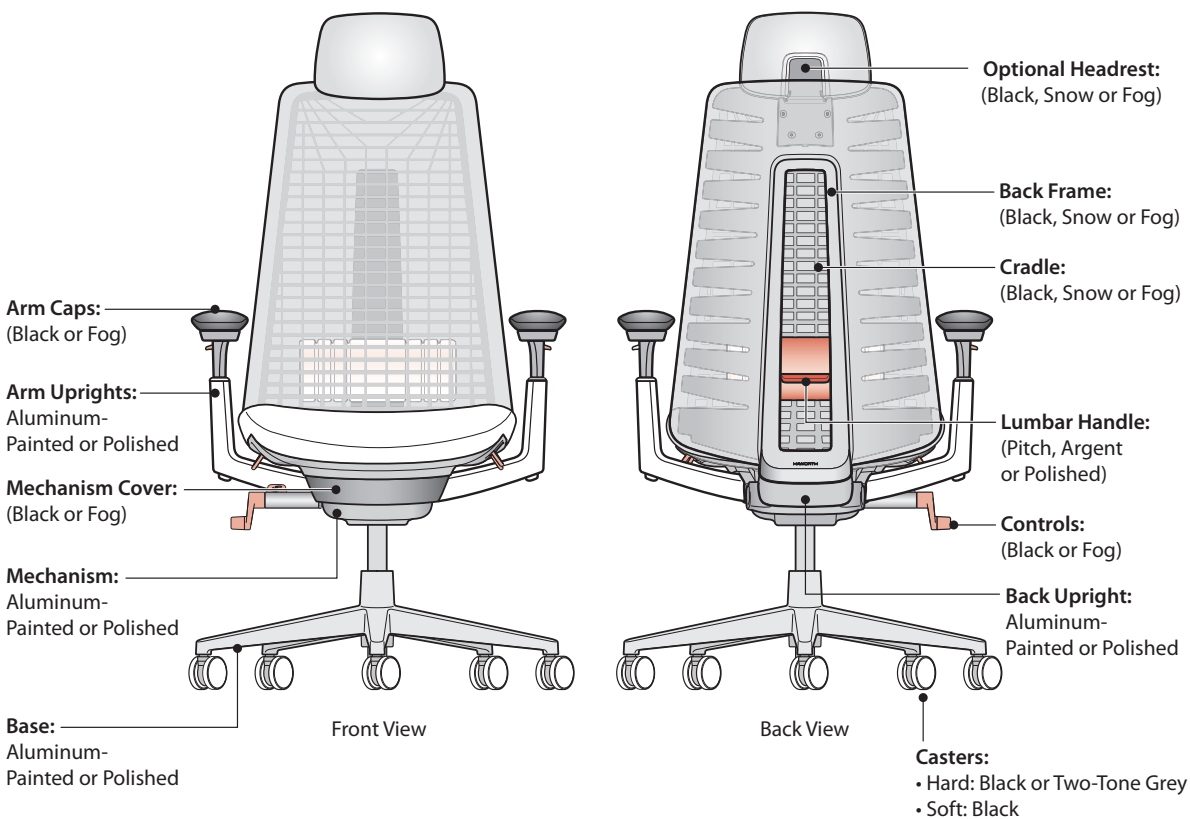

Fern Value Model

Task Chair with 4D Arms — Plastic Model



SFT-U0-7S01A5

Dimensions

- *SH: 16.5"-21.5"
(419mm-546mm)
- H: 41.5"-47"
(1054mm-1194mm)
- D: 28.5"(724mm)
- W: 29"(737mm)
- *SW: 19.9"(505mm)
- *AH: 6.7"-11.5"
(170mm-292mm)
- *SD: 15.5"-18.5"
(394mm-470mm)

* All measurements taken with the BIFMA chair measuring device.

Features

- Back: Flexible back with built in fronds wrapped in lofted mesh.
- Seat: Flexible seat pan with standard upholstered foam.
- Seat depth adjustment (3"(76mm) range).
- Base: Plastic five-star base.
- Arms: 4D arms with plastic upright.
 - Move fore, aft, side to side and pivot in and out.
 - Height adjustment range of 4.8"(122mm).
- Arm Caps: Standard with soft arm caps.
- Mechanism: Synchronized 3-point tilt; standard tilt tension adjustment.
- Height Adjustment: Pneumatic. Range: 16.5"-21.5"(419mm-546mm).
- Back Stop: 4 positions.
- Casters: Hard casters.

To Order, Specify:

- 1) Product number.
- 2) Seat surface/color: 4H-FT Blanket - Fort
- 3) Mesh back: MB-MU Mulch
- 4) Plastic trim color: TR-F Black
- 5) Aluminum trim color: TR-TF Pitch

Note: No changes to specification. No COM or Tailored Solutions.

Number	Price
SFT-U0-7S01A5	\$1123.81

Fern

Task Chair with 4D Arms — Plastic Model



SFT-U0-7S02A

1st Trim Color (Plastic)	Arm Cap/Levers	Lumbar Handle
TR-F Black	TR-F Black	TR-TF Pitch
TR-7 Fog	TR-7 Fog	TR-AR Argent

Dimensions

- *SH: 16.5"-21.5"
(419mm-546mm)
- H: 41.5"-47"
(1054mm-1194mm)
- D: 28.5"(724mm)
- W: 29"(737mm)
- *SW: 19.9"(505mm)
- *AH: 6.7"-11.5"
(170mm-292mm)
- *SD: 15.5"-18.5"
(394mm-470mm)

* All measurements taken with the BIFMA chair measuring device.

Features

- Back: Flexible back with built in fronds wrapped in lofted mesh or faux leather.
- Seat: Flexible seat pan with standard upholstered foam.
- Standard fixed seat. Optional seat depth adjustment (3"(76mm) range).
- Base: Plastic five-star base. Available in Black or Fog.
- Optional height adjustable lumbar support (4"(102mm) adjustment).
- Arms: 4D arms with plastic upright.
–Move fore, aft, side to side and pivot in and out.
–Height adjustment range of 4.8"(122mm).
- Arm Caps: Standard with soft arm caps.
- Optional headrest has an upholstered front with a plastic back. Headrest material and trim color are matched to the back.
- Mechanism: Synchronized 3-point tilt; standard tilt tension adjustment.
- Height Adjustment: Pneumatic. Range: 16.5"-21.5"(419mm-546mm).
- Optional Back Stop: 4 positions.
- Optional Forward Tilt (with Back Stop): 5° downward from initial position.
- Casters: Hard casters in black or two-tone grey; Soft casters black only.
- COM yardage / COL square footage:
(Seat only) 0.71/8

To Order, Specify:

- 1) Product number, including;
 - 1** **Caster Option:**
 - 5** Hard Casters (Black)
 - 6** Soft Casters (Black)
 - 7** Hard Two-Tone Casters (Grey)
- 2) Fabric surface and color (seat).
- 3) Mesh or faux leather color (back).
- 4) Plastic trim color (back frame/cradle/arm uprights/arm caps/levers/base).
- 5) Aluminum trim color (back upright and mechanism).
(Add **\$90.00** list for polished aluminum back upright and mechanism.)

Description	Number	Fabric Grade								Leather Grade A	Leather Grade B
		1 A	B	C	D	E	F	G	H		
Mesh Back, No Lumbar Adjustment											
Pneumatic w/Seat Depth Adjustment	SFT-U0-7S02A	\$1140.00	\$1174.00	\$1210.00	\$1228.00	\$1241.00	\$1273.00	\$1303.00	\$1382.00	\$1438.00	\$1580.00
Back Stop w/Seat Depth Adjustment	SFT-U0-7S01A	1220.00	1254.00	1290.00	1308.00	1321.00	1353.00	1383.00	1462.00	1518.00	1660.00
Back Stop Forward Tilt w/Seat Depth Adjustment	SFT-U0-7S04A	1300.00	1334.00	1370.00	1388.00	1401.00	1433.00	1463.00	1542.00	1598.00	1740.00
Mesh Back, Lumbar Adjustment											
Pneumatic w/Seat Depth Adjustment	SFT-U0-7S12A	\$1230.00	\$1264.00	\$1300.00	\$1318.00	\$1331.00	\$1363.00	\$1393.00	\$1472.00	\$1528.00	\$1670.00
Back Stop w/Seat Depth Adjustment	SFT-U0-7S11A	1310.00	1344.00	1380.00	1398.00	1411.00	1443.00	1473.00	1552.00	1608.00	1750.00
Back Stop Forward Tilt w/Seat Depth Adjustment	SFT-U0-7S14A	1390.00	1424.00	1460.00	1478.00	1491.00	1523.00	1553.00	1632.00	1688.00	1830.00

The following options require modification of the product number.

- Fixed seat To specify, change the 10th digit from an **A** to **F** and deduct **\$20.00** list; **Example:** SFT-U0-7S02F5
- Faux Leather back To specify, change the fifth digit in the product number to **U**; **Example:** SFT-UU-7S02A5 (Wellington; add **\$115.00** list, Brisa; add **\$297.00** list)
- Headrest To specify, change the third digit from a **T** to an **E**; **Example:** SFE-U0-7S02A5 (Mesh; add **\$100.00** list, Faux Leather; add **\$140.00** list)
- Stain repellent (Seat only) To specify, add **P** to the end of the product number and add **\$35.00** list; **Example:** SFT-U0-7S02ASP

Fern

Task Chair with 4D Arms — Aluminum Model



SFT-U0-7S02A

Dimensions

- *SH: 16.5"-21.5"
(419mm-546mm)
- H: 41.5"-47"
(1054mm-1194mm)
- D: 28.5"(724mm)
- W: 29"(737mm)
- *SW: 19.9"(505mm)
- *AH: 6.7"-11.5"
(170mm-292mm)
- *SD: 15.5"-18.5"
(394mm-470mm)

Low position seat height:
15"-17.5"
(381mm-445mm)

* All measurements taken with the BIFMA chair measuring device.

Features

- Back: Flexible back with built in fronds wrapped in lofted mesh or faux leather.
- Seat: Flexible seat pan with standard upholstered foam.
- Standard fixed seat. Optional seat depth adjustment (3"(76mm) range).
- Base: Aluminum five-star base.
- Optional height adjustable lumbar support (4"(102mm) adjustment).
- Arms: 4D arms with aluminum upright.
–Move fore, aft, side to side and pivot in and out.
–Height adjustment range of 4.8"(122mm).
- Arm Caps: Standard with soft arm caps.
- Optional headrest has an upholstered front with a plastic back. Headrest material and trim color are matched to the back.
- Mechanism: Synchronized 3-point tilt; standard tilt tension adjustment.
- Height Adjustment: Pneumatic or optional low position. Range: 15"-17.5"(381mm-445mm).
- Optional Back Stop: 4 positions.
- Optional Forward Tilt (with Back Stop): 5° downward from initial position.
- Casters: Hard casters in black or two-tone grey; Soft casters black only.
- COM yardage / COL square footage:
(Seat only) 0.71/8

To Order, Specify:

1) Product number, including;

1 Caster Option: Standard Base

- 1** Std. Base Hard Casters (Black)
- 2** Std. Base Soft Casters (Black)
- T** Std. Base Hard Two-Tone Casters (Grey)

Low Base

- 3** Low Base, Hard Casters (Black)
- 4** Low Base, Soft Casters (Black)

- 2) Fabric surface and color (seat).
- 3) Mesh or faux leather color (back).
- 4) Plastic trim color (back frame/cradle/arm caps/levers). (Add **\$55.00** list for Snow TR-UFM for back frame/cradle.)
- 5) Aluminum trim color (back and arm upright/mechanism/base). (Add **\$90.00** list for polished aluminum.)

1st Trim Color (Plastic)	Arm Cap/Levers	Lumbar Handle
TR-F Black	TR-F Black	TR-TF Pitch
TR-7 Fog	TR-7 Fog	TR-AR Argent
TR-UFM Snow	TR-7 Fog	TR-FS Snowfall
TR-UFM Snow w/2nd trim PM-P Polished Aluminum	TR-7 Fog	PM-P Polished Aluminum

Description	Number	1	Fabric Grade								Leather Grade A	Leather Grade B
			A	B	C	D	E	F	G	H		
Mesh Back, No Lumbar Adjustment												
Pneumatic w/Seat Depth Adjustment	SFT-U0-7S02A		\$1292.00	\$1326.00	\$1362.00	\$1380.00	\$1393.00	\$1425.00	\$1455.00	\$1534.00	\$1590.00	\$1732.00
Back Stop w/Seat Depth Adjustment	SFT-U0-7S01A		1372.00	1406.00	1442.00	1460.00	1473.00	1505.00	1535.00	1614.00	1670.00	1812.00
Back Stop Forward Tilt w/Seat Depth Adjustment	SFT-U0-7S04A		1452.00	1486.00	1522.00	1540.00	1553.00	1585.00	1615.00	1694.00	1750.00	1892.00
Mesh Back, Lumbar Adjustment												
Pneumatic w/Seat Depth Adjustment	SFT-U0-7S12A		\$1382.00	\$1416.00	\$1452.00	\$1470.00	\$1483.00	\$1515.00	\$1545.00	\$1624.00	\$1680.00	\$1822.00
Back Stop w/Seat Depth Adjustment	SFT-U0-7S11A		1462.00	1496.00	1532.00	1550.00	1563.00	1595.00	1625.00	1704.00	1760.00	1902.00
Back Stop Forward Tilt w/Seat Depth Adjustment	SFT-U0-7S14A		1542.00	1576.00	1612.00	1630.00	1643.00	1675.00	1705.00	1784.00	1840.00	1982.00

The following options require modification of the product number.

- Fixed seat To specify, change the 10th digit from an **A** to **F** and deduct **\$20.00** list; **Example:** SFT-U0-7S02**F**1
- Faux Leather back To specify, change the fifth digit in the product number to **U**; **Example:** SFT-U**U**-7S02A1 (Wellington; add **\$115.00** list, Brisa; add **\$297.00** list)
- Headrest To specify, change the third digit from a **T** to an **E**; **Example:** SFE-U0-7S02A1 (Mesh; add **\$100.00** list, Faux Leather; add **\$140.00** list)
- Stain repellent (Seat only) To specify, add **P** to the end of the product number and add **\$35.00** list; **Example:** SFT-U0-7S02A1**P**

Fern

Task Chair with Height Adjustable Arms — Plastic Model



SFT-U0-4S02A

1st Trim Color (Plastic)	Arm Cap/Levers	Lumbar Handle
TR-F Black	TR-F Black	TR-TF Pitch
TR-7 Fog	TR-7 Fog	TR-AR Argent

Dimensions

- *SH: 16.5"-21.5"
(419mm-546mm)
- H: 41.5"-47"
(1054mm-1194mm)
- D: 28.5"(724mm)
- W: 29"(737mm)
- *SW: 19.9"(505mm)
- *AH: 6.7"-11.5"
(170mm-292mm)
- *SD: 15.5"-18.5"
(394mm-470mm)

* All measurements taken with the BIFMA chair measuring device.

Features

- Back: Flexible back with built in fronds wrapped in lofted mesh or faux leather.
- Seat: Flexible seat pan with standard upholstered foam.
- Standard fixed seat. Optional seat depth adjustment (3"(76mm) range).
- Base: Plastic five-star base. Available in Black or Fog.
- Optional height adjustable lumbar support (4"(102mm) adjustment).
- Arms: Height Adjustable with soft arm caps. Adjustment range of 4.8"(122mm).
- Optional headrest has an upholstered front with a plastic back. Headrest material and trim color are matched to the back.
- Mechanism: Synchronized 3-point tilt; standard tilt tension adjustment.
- Height Adjustment: Pneumatic. Range: 16.5"-21.5"(419mm-546mm).
- Optional Back Stop: 4 positions.
- Optional Forward Tilt (with Back Stop): 5° downward from initial position.
- Casters: Hard casters in black or two-tone grey; Soft casters black only.
- COM yardage / COL square footage: (Seat only) 0.71/8

To Order, Specify:

- 1) Product number, including;
 - 1** **Caster Option:**
 - 5** Hard Casters (Black)
 - 6** Soft Casters (Black)
 - 7** Hard Two-Tone Casters (Grey)
- 2) Fabric surface and color (seat).
- 3) Mesh or faux leather color (back).
- 4) Plastic trim color (back frame/cradle/arm uprights/arm caps/levers/base).
- 5) Aluminum trim color (back upright and mechanism). (Add **\$90.00** list for polished aluminum back upright and mechanism.)

Description	Number	Fabric Grade								Leather Grade A	Leather Grade B
		1 A	B	C	D	E	F	G	H		
Mesh Back, No Lumbar Adjustment											
Pneumatic w/Seat Depth Adjustment	SFT-U0-4S02A	\$1115.00	\$1149.00	\$1185.00	\$1203.00	\$1216.00	\$1248.00	\$1278.00	\$1357.00	\$1413.00	\$1555.00
Back Stop w/Seat Depth Adjustment	SFT-U0-4S01A	1195.00	1229.00	1265.00	1283.00	1296.00	1328.00	1358.00	1437.00	1493.00	1635.00
Back Stop Forward Tilt w/Seat Depth Adjustment	SFT-U0-4S04A	1275.00	1309.00	1345.00	1363.00	1376.00	1408.00	1438.00	1517.00	1573.00	1715.00
Mesh Back, Lumbar Adjustment											
Pneumatic w/Seat Depth Adjustment	SFT-U0-4S12A	\$1205.00	\$1239.00	\$1275.00	\$1293.00	\$1306.00	\$1338.00	\$1368.00	\$1447.00	\$1503.00	\$1645.00
Back Stop w/Seat Depth Adjustment	SFT-U0-4S11A	1285.00	1319.00	1355.00	1373.00	1386.00	1418.00	1448.00	1527.00	1583.00	1725.00
Back Stop Forward Tilt w/Seat Depth Adjustment	SFT-U0-4S14A	1365.00	1399.00	1435.00	1453.00	1466.00	1498.00	1528.00	1607.00	1663.00	1805.00

The following options require modification of the product number.

- | | |
|-----------------------------|--|
| Fixed seat | To specify, change the 10th digit from an A to F and deduct \$20.00 list; Example: SFT-U0-4S02F5 |
| Faux Leather back | To specify, change the fifth digit in the product number to U ; Example: SFT-UU-4S02A5 (Wellington; add \$115.00 list, Brisa; add \$297.00 list) |
| Headrest | To specify, change the third digit from a T to an E ; Example: SFE-U0-4S02A5 (Mesh; add \$100.00 list, Faux Leather; add \$140.00 list) |
| Stain repellent (Seat only) | To specify, add P to the end of the product number and add \$35.00 list; Example: SFT-U0-4S02A5P |

Fern

Task Chair with Height Adjustable Arms — Aluminum Model



SFT-U0-4S02A

Dimensions

- *SH: 16.5"-21.5"
(419mm-546mm)
- H: 41.5"-47"
(1054mm-1194mm)
- D: 28.5"(724mm)
- W: 29"(737mm)
- *SW: 19.9"(505mm)
- *AH: 6.7"-11.5"
(170mm-292mm)
- *SD: 15.5"-18.5"
(394mm-470mm)

Low position seat height:
15"-17.5"
(381mm-445mm)

* All measurements taken with the BIFMA chair measuring device.

Features

- Back: Flexible back with built in fronds wrapped in lofted mesh or faux leather.
- Seat: Flexible seat pan with standard upholstered foam.
- Standard fixed seat. Optional seat depth adjustment (3"(76mm) range).
- Base: Aluminum five-star base.
- Optional height adjustable lumbar support (4"(102mm) adjustment).
- Arms: Height Adjustable with soft arm caps. Adjustment range of 4.8"(122mm).
- Optional headrest has an upholstered front with a plastic back. Headrest material and trim color are matched to the back.
- Mechanism: Synchronized 3-point tilt; standard tilt tension adjustment.
- Height Adjustment: Pneumatic or optional low position. Range: 15"-17.5"(381mm-445mm).
- Optional Back Stop: 4 positions.
- Optional Forward Tilt (with Back Stop): 5° downward from initial position.
- Casters: Hard casters in black or two-tone grey; Soft casters black only.
- COM yardage / COL square footage: (Seat only) 0.71/8

To Order, Specify:

1) Product number, including;

1 Caster Option: Standard Base

- 1** Std. Base Hard Casters (Black)
- 2** Std. Base Soft Casters (Black)
- T** Std. Hard Base Two-Tone Casters (Grey)

Low Base

- 3** Low Base, Hard Casters (Black)
- 4** Low Base, Soft Casters (Black)

- 2) Fabric surface and color (seat).
- 3) Mesh or faux leather color (back).
- 4) Plastic trim color (back frame/cradle/arm caps/levers). (Add **\$55.00** list for Snow TR-UFM for back frame/cradle.)
- 5) Aluminum trim color (back and arm upright/mechanism/base). (Add **\$90.00** list for polished aluminum.)

1st Trim Color (Plastic)	Arm Cap/Levers	Lumbar Handle
TR-F Black	TR-F Black	TR-TF Pitch
TR-7 Fog	TR-7 Fog	TR-AR Argent
TR-UFM Snow	TR-7 Fog	TR-FS Snowfall
TR-UFM Snow w/2nd trim PM-P Polished Aluminum	TR-7 Fog	PM-P Polished Aluminum

Description	Number 1	Fabric Grade								Leather Grade A	Leather Grade B
		A	B	C	D	E	F	G	H		
Mesh Back, No Lumbar Adjustment											
Pneumatic w/Seat Depth Adjustment	SFT-U0-4S02A	\$1267.00	\$1301.00	\$1337.00	\$1355.00	\$1368.00	\$1400.00	\$1430.00	\$1509.00	\$1565.00	\$1707.00
Back Stop w/Seat Depth Adjustment	SFT-U0-4S01A	1347.00	1381.00	1417.00	1435.00	1448.00	1480.00	1510.00	1589.00	1645.00	1787.00
Back Stop Forward Tilt w/Seat Depth Adjustment	SFT-U0-4S04A	1427.00	1461.00	1497.00	1515.00	1528.00	1560.00	1590.00	1669.00	1725.00	1867.00
Mesh Back, Lumbar Adjustment											
Pneumatic w/Seat Depth Adjustment	SFT-U0-4S12A	\$1357.00	\$1391.00	\$1427.00	\$1445.00	\$1458.00	\$1490.00	\$1520.00	\$1599.00	\$1655.00	\$1797.00
Back Stop w/Seat Depth Adjustment	SFT-U0-4S11A	1437.00	1471.00	1507.00	1525.00	1538.00	1570.00	1600.00	1679.00	1735.00	1877.00
Back Stop Forward Tilt w/Seat Depth Adjustment	SFT-U0-4S14A	1517.00	1551.00	1587.00	1605.00	1618.00	1650.00	1680.00	1759.00	1815.00	1957.00

The following options require modification of the product number.

- Fixed seat To specify, change the 10th digit from an **A** to **F** and deduct **\$20.00** list; **Example:** SFT-U0-4S02F1
- Faux Leather back To specify, change the fifth digit in the product number to **U**; **Example:** SFT-UU-4S02A1 (Wellington; add **\$115.00** list, Brisa; add **\$297.00** list)
- Headrest To specify, change the third digit from a **T** to an **E**; **Example:** SFE-U0-4S02A1 (Mesh; add **\$100.00** list, Faux Leather; add **\$140.00** list)
- Stain repellent (Seat only) To specify, add **P** to the end of the product number and add **\$35.00** list; **Example:** SFT-U0-4S02A1P

Fern

Task Chair with Fixed Arms — Plastic Model



SFT-U0-1S02A

1st Trim Color (Plastic)	Arm Cap/Levers	Lumbar Handle
TR-F Black	TR-F Black	TR-TF Pitch
TR-7 Fog	TR-7 Fog	TR-AR Argent

Dimensions

- *SH: 16.5"-21.5"
(419mm-546mm)
- H: 41.5"-47"
(1054mm-1194mm)
- D: 28.5"(724mm)
- W: 29"(737mm)
- *SW: 19.9"(505mm)
- *AH: 9"(229mm)
- *SD: 15.5"-18.5"
(394mm-470mm)

* All measurements taken with the BIFMA chair measuring device.

Features

- Back: Flexible back with built in fronds wrapped in lofted mesh or faux leather.
- Seat: Flexible seat pan with standard upholstered foam.
- Standard fixed seat. Optional seat depth adjustment (3"(76mm) range).
- Base: Plastic five-star base. Available in Black or Fog.
- Optional height adjustable lumbar support (4"(102mm) adjustment).
- Arms: Fixed aluminum arms with soft arm caps.
- Optional leather arm cap available when ordering a leather seat. Leather arm cap coordinates with leather seat selection.
- Optional headrest has an upholstered front with a plastic back. Headrest material and trim color are matched to the back.
- Mechanism: Synchronized 3-point tilt; standard tilt tension adjustment.
- Height Adjustment: Pneumatic. Range: 15"-17.5"(381mm-445mm).
- Optional Back Stop: 4 positions.
- Optional Forward Tilt (with Back Stop): 5° downward from initial position.
- Casters: Hard casters in black or two-tone grey; Soft casters black only.
- COM yardage / COL square footage: (Seat only) 0.71/8

To Order, Specify:

- 1) Product number, including;

1 Caster Option:

- 5 Hard Casters (Black)
- 6 Soft Casters (Black)
- 7 Hard Two-Tone Casters (Grey)

- 2) Fabric surface and color (seat).
- 3) Mesh or faux leather color (back).
- 4) Plastic trim color (back frame/cradle/arm caps/levers/base).
- 5) Aluminum trim color (back upright/arm uprights/mechanism). (Add **\$90.00** list for polished aluminum back upright and mechanism.)

Description	Number	①	Fabric Grade								Leather Grade A	Leather Grade B
			A	B	C	D	E	F	G	H		
Mesh Back, No Lumbar Adjustment												
Pneumatic w/Seat Depth Adjustment	SFT-U0-1S02A	■	\$1100.00	\$1134.00	\$1170.00	\$1188.00	\$1201.00	\$1233.00	\$1263.00	\$1342.00	\$1398.00	\$1540.00
Back Stop w/Seat Depth Adjustment	SFT-U0-1S01A	■	1180.00	1214.00	1250.00	1268.00	1281.00	1313.00	1343.00	1422.00	1478.00	1620.00
Back Stop Forward Tilt w/Seat Depth Adjustment	SFT-U0-1S04A	■	1260.00	1294.00	1330.00	1348.00	1361.00	1393.00	1423.00	1502.00	1558.00	1700.00
Mesh Back, Lumbar Adjustment												
Pneumatic w/Seat Depth Adjustment	SFT-U0-1S12A	■	\$1190.00	\$1224.00	\$1260.00	\$1278.00	\$1291.00	\$1323.00	\$1353.00	\$1432.00	\$1488.00	\$1630.00
Back Stop w/Seat Depth Adjustment	SFT-U0-1S11A	■	1270.00	1304.00	1340.00	1358.00	1371.00	1403.00	1433.00	1512.00	1568.00	1710.00
Back Stop Forward Tilt w/Seat Depth Adjustment	SFT-U0-1S14A	■	1350.00	1384.00	1420.00	1438.00	1451.00	1483.00	1513.00	1592.00	1648.00	1790.00

The following options require modification of the product number.

- | | |
|-----------------------------|--|
| Fixed seat | To specify, change the 10th digit from an A to F and deduct \$20.00 list; Example: SFT-U0-1S02F5 |
| Leather arm cap | To specify, change the 7th digit from S to L ; Example: SFT-U0-1L02A5 (matches required Leather seat), add \$70.00 list |
| Faux Leather back | To specify, change the fifth digit in the product number to U ; Example: SFT-UU-1S02A5 (Wellington; add \$115.00 list, Brisa; add \$297.00 list) |
| Headrest | To specify, change the third digit from a T to an E ; Example: SFE-U0-1S02A5 (Mesh; add \$100.00 list, Faux Leather; add \$140.00 list) |
| Stain repellent (Seat only) | To specify, add P to the end of the product number and add \$35.00 list; Example: SFT-U0-1S02A5P |

Fern

Task Chair with Fixed Arms — Aluminum Model



SFT-U0-1S02A

Dimensions

- *SH: 16.5"-21.5"
(419mm-546mm)
- H: 41.5"-47"
(1054mm-1194mm)
- D: 28.5"(724mm)
- W: 29"(737mm)
- *SW: 19.9"(505mm)
- *AH: 9"(229mm)
- *SD: 15.5"-18.5"
(394mm-470mm)

Low position seat height:
15"-17.5"(381mm-445mm)

* All measurements taken with the BIFMA chair measuring device.

Features

- Back: Flexible back with built in fronds wrapped in lofted mesh or faux leather.
- Seat: Flexible seat pan with standard upholstered foam.
- Standard fixed seat. Optional seat depth adjustment (3"(76mm) range).
- Base: Aluminum five-star base.
- Optional height adjustable lumbar support (4"(102mm) adjustment).
- Arms: Fixed with soft arm caps.
- Optional leather arm cap available when ordering a leather seat. Leather arm cap coordinates with leather seat selection.
- Optional headrest has an upholstered front with a plastic back. Headrest material and trim color are matched to the back.
- Mechanism: Synchronized 3-point tilt; standard tilt tension adjustment.
- Height Adjustment: Pneumatic or optional low position. Range: 15"-17.5"(381mm-445mm).
- Optional Back Stop: 4 positions.
- Optional Forward Tilt (with Back Stop): 5° downward from initial position.
- Casters: Hard casters in black or two-tone grey; Soft casters black only.
- COM yardage / COL square footage: (Seat only) 0.71/8

To Order, Specify:

1) Product number, including;

1 Caster Option: Standard Base

- 1** Std. Base Hard Casters (Black)
- 2** Std. Base Soft Casters (Black)
- T** Std. Base Hard Two-Tone Casters (Grey)

Low Base

- 3** Low Base, Hard Casters (Black)
- 4** Low Base, Soft Casters (Black)

- 2) Fabric surface and color (seat).
- 3) Mesh or faux leather color (back).
- 4) Plastic trim color (back frame/cradle/arm caps/levers). (Add **\$55.00** list for Snow TR-UFM for back frame/cradle/arm caps.)
- 5) Aluminum trim color (back and arm upright/mechanism/base). (Add **\$90.00** list for polished aluminum back upright and mechanism.)

1st Trim Color (Plastic)	Arm Cap/Levers	Lumbar Handle
TR-F Black	TR-F Black	TR-TF Pitch
TR-7 Fog	TR-7 Fog	TR-AR Argent
TR-UFM Snow	TR-7 Fog	TR-FS Snowfall
TR-UFM Snow w/2nd trim PM-P Polished Aluminum	TR-7 Fog	PM-P Polished Aluminum

Description	Number	1	Fabric Grade							Leather Grade A	Leather Grade B	
			A	B	C	D	E	F	G			H
Mesh Back, No Lumbar Adjustment												
Pneumatic w/Seat Depth Adjustment	SFT-U0-1S02A		\$1252.00	\$1286.00	\$1322.00	\$1340.00	\$1353.00	\$1385.00	\$1415.00	\$1494.00	\$1550.00	\$1692.00
Back Stop w/Seat Depth Adjustment	SFT-U0-1S01A		1332.00	1366.00	1402.00	1420.00	1433.00	1465.00	1495.00	1574.00	1630.00	1772.00
Back Stop Forward Tilt w/Seat Depth Adjustment	SFT-U0-1S04A		1412.00	1446.00	1482.00	1500.00	1513.00	1545.00	1575.00	1654.00	1710.00	1852.00
Mesh Back, Lumbar Adjustment												
Pneumatic w/Seat Depth Adjustment	SFT-U0-1S12A		\$1342.00	\$1376.00	\$1412.00	\$1430.00	\$1443.00	\$1475.00	\$1505.00	\$1584.00	\$1640.00	\$1782.00
Back Stop w/Seat Depth Adjustment	SFT-U0-1S11A		1422.00	1456.00	1492.00	1510.00	1523.00	1555.00	1585.00	1664.00	1720.00	1862.00
Back Stop Forward Tilt w/Seat Depth Adjustment	SFT-U0-1S14A		1502.00	1536.00	1572.00	1590.00	1603.00	1635.00	1665.00	1744.00	1800.00	1942.00

The following options require modification of the product number.

- Fixed seat To specify, change the 10th digit from an **A** to **F** and deduct **\$20.00** list; **Example:** SFT-U0-1S02F1
- Leather arm cap To specify, change the 7th digit from **S** to **L**; **Example:** SFT-U0-1L02A1 (matches required Leather seat), add **\$70.00** list
- Faux Leather back To specify, change the fifth digit in the product number to **U**; **Example:** SFT-UU-1S02A1 (Wellington; add **\$115.00** list, Brisa; add **\$297.00** list)
- Headrest To specify, change the third digit from a **T** to an **E**; **Example:** SFE-U0-1S02A1 (Mesh; add **\$100.00** list, Faux Leather; add **\$140.00** list)
- Stain repellent (Seat only) To specify, add **P** to the end of the product number and add **\$35.00** list; **Example:** SFT-U0-1S02A1P

Fern

Task Chair without Arms — **Plastic Model**



SFT-U0-0N02A

1st Trim Color (Plastic)	Levers	Lumbar Handle
TR-F Black	TR-F Black	TR-TF Pitch
TR-7 Fog	TR-7 Fog	TR-AR Argent

Dimensions

- *SH: 16.5"-21.5"
(419mm-546mm)
- H: 41.5"-47"
(1054mm-1194mm)
- D: 28.5"(724mm)
- W: 29"(737mm)
- *SW: 19.9"(505mm)
- *SD: 15.5"-18.5"
(394mm-470mm)

* All measurements taken with the BIFMA chair measuring device.

Features

- Back: Flexible back with built in fronds wrapped in lofted mesh or faux leather.
- Seat: Flexible seat pan with standard upholstered foam.
- Standard fixed seat. Optional seat depth adjustment (3"(76mm) range).
- Base: Plastic five-star base. Available in Black or Fog.
- Optional height adjustable lumbar support (4"(102mm) adjustment).
- Optional headrest has an upholstered front with a plastic back. Headrest material and trim color are matched to the back.
- Mechanism: Synchronized 3-point tilt; standard tilt tension adjustment.
- Height Adjustment: Pneumatic. Range: 16.5"-21.5"(419mm-546mm).
- Optional Back Stop: 4 positions.
- Optional Forward Tilt (with Back Stop): 5° downward from initial position.
- Casters: Hard casters in black or two-tone grey; Soft casters black only.
- COM yardage / COL square footage: (Seat only) 0.71/8

To Order, Specify:

- 1) Product number, including;
 - 1 Caster Option:**
 - 5** Hard Casters (Black)
 - 6** Soft Casters (Black)
 - 7** Hard Two-Tone Casters (Grey)
- 2) Fabric surface and color (seat).
- 3) Mesh or faux leather color (back).
- 4) Plastic trim color (back frame/cradle/levers/base).
- 5) Aluminum trim color (back upright and mechanism). (Add **\$90.00** list for polished aluminum back upright and mechanism.)

Description	Number	①	Fabric Grade								Leather Grade A	Leather Grade B
			A	B	C	D	E	F	G	H		
Mesh Back, No Lumbar Adjustment												
Pneumatic w/Seat Depth Adjustment	SFT-U0-0N02A		\$ 980.00	\$1014.00	\$1050.00	\$1068.00	\$1081.00	\$1113.00	\$1143.00	\$1222.00	\$1278.00	\$1420.00
Back Stop w/Seat Depth Adjustment	SFT-U0-0N01A		1060.00	1094.00	1130.00	1148.00	1161.00	1193.00	1223.00	1302.00	1358.00	1500.00
Back Stop Forward Tilt w/Seat Depth Adjustment	SFT-U0-0N04A		1140.00	1174.00	1210.00	1228.00	1241.00	1273.00	1303.00	1382.00	1438.00	1580.00
Mesh Back, Lumbar Adjustment												
Pneumatic w/Seat Depth Adjustment	SFT-U0-0N12A		\$1070.00	\$1104.00	\$1140.00	\$1158.00	\$1171.00	\$1203.00	\$1233.00	\$1312.00	\$1368.00	\$1510.00
Back Stop w/Seat Depth Adjustment	SFT-U0-0N11A		1150.00	1184.00	1220.00	1238.00	1251.00	1283.00	1313.00	1392.00	1448.00	1590.00
Back Stop Forward Tilt w/Seat Depth Adjustment	SFT-U0-0N14A		1230.00	1264.00	1300.00	1318.00	1331.00	1363.00	1393.00	1472.00	1528.00	1670.00

The following options require modification of the product number.

- | | |
|-----------------------------|--|
| Fixed seat | To specify, change the 10th digit from an A to F and deduct \$20.00 list; Example: SFT-U0-0N02F5 |
| Faux Leather back | To specify, change the fifth digit in the product number to U ; Example: SFT-UU-0N02A5 (Wellington; add \$115.00 list, Brisa; add \$297.00 list) |
| Headrest | To specify, change the third digit from a T to an E ; Example: SFE-U0-0N02A5 (Mesh; add \$100.00 list, Faux Leather; add \$140.00 list) |
| Stain repellent (Seat only) | To specify, add P to the end of the product number and add \$35.00 list; Example: SFT-U0-0N02A5P |

Fern

Task Chair without Arms — Aluminum Model



SFT-U0-0N02A

Dimensions

- *SH: 16.5"-21.5"
(419mm-546mm)
- H: 41.5"-47"
(1054mm-1194mm)
- D: 28.5"(724mm)
- W: 29"(737mm)
- *SW: 19.9"(505mm)
- *SD: 15.5"-18.5"
(394mm-470mm)

Low position seat height:
15"-17.5"(381mm-445mm)

* All measurements taken with the BIFMA chair measuring device.

Features

- Back: Flexible back with built in fronds wrapped in lofted mesh or faux leather.
- Seat: Flexible seat pan with standard upholstered foam.
- Standard fixed seat. Optional seat depth adjustment (3"(76mm) range).
- Base: Aluminum five-star base.
- Optional height adjustable lumbar support (4"(102mm) adjustment).
- Optional headrest has an upholstered front with a plastic back. Headrest material and trim color are matched to the back.
- Mechanism: Synchronized 3-point tilt; standard tilt tension adjustment.
- Height Adjustment: Pneumatic or optional low position. Range: 15"-17.5"(381mm-445mm).
- Optional Back Stop: 4 positions.
- Optional Forward Tilt (with Back Stop): 5° downward from initial position.
- Casters: Hard casters in black or two-tone grey; Soft casters black only.
- COM yardage / COL square footage: (Seat only) 0.71/8

To Order, Specify:

1) Product number, including;

1 Caster Option: Standard Base

- 1** Std. Base Hard Casters (Black)
- 2** Std. Base Soft Casters (Black)
- T** Std. Base Hard Two-Tone Casters (Grey)

Low Base

- 3** Low Base, Hard Casters (Black)
- 4** Low Base, Soft Casters (Black)

- 2) Fabric surface and color (seat).
- 3) Mesh or faux leather color (back).
- 4) Plastic trim color (back frame/cradle/levers). (Add **\$55.00** list for Snow TR-UFM for back frame/cradle.)
- 5) Aluminum trim color (back upright/mechanism/base). (Add **\$90.00** list for polished aluminum back upright and mechanism.)

1st Trim Color (Plastic)	Levers	Lumbar Handle
TR-F Black	TR-F Black	TR-TF Pitch
TR-7 Fog	TR-7 Fog	TR-AR Argent
TR-UFM Snow	TR-7 Fog	TR-FS Snowfall
TR-UFM Snow w/2nd trim PM-P Polished Aluminum	TR-7 Fog	PM-P Polished Aluminum

Description	Number	1	Fabric Grade								Leather Grade A	Leather Grade B
			A	B	C	D	E	F	G	H		
Mesh Back, No Lumbar Adjustment												
Pneumatic w/Seat Depth Adjustment	SFT-U0-0N02A		\$1132.00	\$1166.00	\$1202.00	\$1220.00	\$1233.00	\$1265.00	\$1295.00	\$1374.00	\$1430.00	\$1572.00
Back Stop w/Seat Depth Adjustment	SFT-U0-0N01A		1212.00	1246.00	1282.00	1300.00	1313.00	1345.00	1375.00	1454.00	1510.00	1652.00
Back Stop Forward Tilt w/Seat Depth Adjustment	SFT-U0-0N04A		1292.00	1326.00	1362.00	1380.00	1393.00	1425.00	1455.00	1534.00	1590.00	1732.00
Mesh Back, Lumbar Adjustment												
Pneumatic w/Seat Depth Adjustment	SFT-U0-0N12A		\$1222.00	\$1256.00	\$1292.00	\$1310.00	\$1323.00	\$1355.00	\$1385.00	\$1464.00	\$1520.00	\$1662.00
Back Stop w/Seat Depth Adjustment	SFT-U0-0N11A		1302.00	1336.00	1372.00	1390.00	1403.00	1435.00	1465.00	1544.00	1600.00	1742.00
Back Stop Forward Tilt w/Seat Depth Adjustment	SFT-U0-0N14A		1382.00	1416.00	1452.00	1470.00	1483.00	1515.00	1545.00	1624.00	1680.00	1822.00

The following options require modification of the product number.

- Fixed seat To specify, change the 10th digit from an **A** to **F** and deduct **\$20.00** list; **Example:** SFT-U0-0N02F1
- Faux Leather back To specify, change the fifth digit in the product number to **U**; **Example:** SFT-UU-0N02A1 (Wellington; add **\$115.00** list, Brisa; add **\$297.00** list)
- Headrest To specify, change the third digit from a **T** to an **E**; **Example:** SFE-U0-0N02A1 (Mesh; add **\$100.00** list, Faux Leather; add **\$140.00** list)
- Stain repellent (Seat only) To specify, add **P** to the end of the product number and add **\$35.00** list; **Example:** SFT-U0-0N02A1P

Fern

Task Stool with 4D Arms — Plastic Model



SFS-U0-7S02A

1st Trim Color (Plastic)	Arm Cap/Levers	Lumbar Handle
TR-F Black	TR-F Black	TR-TF Pitch
TR-7 Fog	TR-7 Fog	TR-AR Argent

Dimensions

- *SH: 21.75"-29.25"
(552mm-743mm)
- H: 46.75"-54.75"
(1187mm-1391mm)
- D: 28.5"(724mm)
- W: 29"(737mm)
- *SW: 19.9"(505mm)
- *AH: 6.7"-11.5"
(170mm-292mm)
- *SD: 15.5"-18.5"
(394mm-470mm)

* All measurements taken with the BIFMA chair measuring device.

Features

- Back: Flexible back with built in fronds wrapped in lofted mesh or faux leather.
- Seat: Flexible seat pan with standard upholstered foam.
- Standard fixed seat. Optional seat depth adjustment (3"(76mm) range).
- Optional height adjustable lumbar support (4"(102mm) adjustment).
- Arms: 4D arms with plastic upright.
 - Move fore, aft, side to side and pivot in and out.
 - Height adjustment range of 4.8"(122mm).
- Arm Caps: Standard with soft arm caps.
- Mechanism: Synchronized 3-point tilt; standard tilt tension adjustment.
- Height Adjustment: Pneumatic. Range: 21.75"-29.25"(552mm-743mm).
- Optional Back Stop: 4 positions.
- Base: Plastic five-star base.
- Footring: Adjusts 4"(102mm) up and down. Brushed aluminum finish.
- Casters: Hard casters in black or two-tone grey; Soft casters black only.
- COM yardage / COL square footage: (Seat only) 0.71/8

To Order, Specify:

- 1) Product number, including;
 - 1 Caster Option:**
 - 5** Hard Casters (Black)
 - 6** Soft Casters (Black)
 - 7** Hard Two-Tone Casters (Grey)
- 2) Fabric surface and color (seat).
- 3) Mesh or faux leather color (back).
- 4) Plastic trim color for back frame/cradle/arm uprights/arm caps/levers/base.
- 5) Aluminum trim color for back upright and mechanism.
(Add **\$90.00** list for polished aluminum back upright and mechanism.)

Description	Number	Fabric Grade								Leather Grade A	Leather Grade B
		1 A	B	C	D	E	F	G	H		
Mesh Back, No Lumbar Adjustment											
Pneumatic w/Seat Depth Adjustment	SFS-U0-7S02A	\$1542.00	\$1576.00	\$1612.00	\$1630.00	\$1643.00	\$1675.00	\$1705.00	\$1784.00	\$1840.00	\$1982.00
Back Stop w/Seat Depth Adjustment	SFS-U0-7S01A	1622.00	1656.00	1692.00	1710.00	1723.00	1755.00	1785.00	1864.00	1920.00	2062.00
Mesh Back, Lumbar Adjustment											
Pneumatic w/Seat Depth Adjustment	SFS-U0-7S12A	\$1632.00	\$1666.00	\$1702.00	\$1720.00	\$1733.00	\$1765.00	\$1795.00	\$1874.00	\$1930.00	\$2072.00
Back Stop w/Seat Depth Adjustment	SFS-U0-7S11A	1712.00	1746.00	1782.00	1800.00	1813.00	1845.00	1875.00	1954.00	2010.00	2152.00

The following options require modification of the product number.

- | | |
|-----------------------------|--|
| Fixed seat | To specify, change the 10th digit from an A to F and deduct \$20.00 list; Example: SFS-U0-7S02 F 5 |
| Faux Leather back | To specify, change the fifth digit in the product number to U ; Example: SFS-UU-7S02A5 (Wellington; add \$115.00 list, Brisa; add \$297.00 list) |
| Stain repellent (Seat only) | To specify, add P to the end of the product number and add \$35.00 list; Example: SFS-U0-7S02A5 P |

Fern

Task Stool with 4D Arms — Aluminum Model



SFS-U0-7S02A

Dimensions

- *SH: 21.75"-29.25"
(552mm-743mm)
- H: 46.75"-54.75"
(1187mm-1391mm)
- D: 28.5"(724mm)
- W: 29"(737mm)
- *SW: 19.9"(505mm)
- *AH: 6.7"-11.5"
(170mm-292mm)
- *SD: 15.5"-18.5"
(394mm-470mm)

* All measurements taken with the BIFMA chair measuring device.

Features

- Back: Flexible back with built in fronds wrapped in lofted mesh or faux leather.
- Seat: Flexible seat pan with standard upholstered foam.
- Standard fixed seat. Optional seat depth adjustment (3"(76mm) range).
- Optional height adjustable lumbar support (4"(102mm) adjustment).
- Arms: 4D arms with aluminum upright.
–Move fore, aft, side to side and pivot in and out.
–Height adjustment range of 4.8"(122mm).
- Arm Caps: Standard with soft arm caps.
- Mechanism: Synchronized 3-point tilt; standard tilt tension adjustment.
- Height Adjustment: Pneumatic. Range: 21.75"-29.25"(552mm-743mm).
- Optional Back Stop: 4 positions.
- Base: Aluminum five-star base.
- Footring: Adjusts 4"(102mm) up and down. Brushed aluminum finish.
- Casters: Hard casters in black or two-tone grey; Soft casters black only.
- COM yardage / COL square footage:
(Seat only) 0.71/8

To Order, Specify:

1) Product number, including;

1 Caster Option:

- 1** Hard Casters (Black)
- 2** Soft Casters (Black)
- T** Hard Two-Tone Casters (Grey)

2) Fabric surface and color (seat).

3) Mesh or faux leather color (back).

4) Plastic trim color for back frame/cradle/arm caps/levers. (Add **\$55.00** list for Snow TR-UFM for back frame/cradle.)

5) Aluminum trim color for back and arm upright/mechanism/base. (Add **\$90.00** list for polished aluminum back upright and mechanism.)

1st Trim Color (Plastic)	Arm Cap/Levers	Lumbar Handle
TR-F Black	TR-F Black	TR-TF Pitch
TR-7 Fog	TR-7 Fog	TR-AR Argent
TR-UFM Snow	TR-7 Fog	TR-FS Snowfall
TR-UFM Snow w/2nd trim PM-P Polished Aluminum	TR-7 Fog	PM-P Polished Aluminum

Description	Number	1	Fabric Grade							Leather Grade A	Leather Grade B	
			A	B	C	D	E	F	G			H
Mesh Back, No Lumbar Adjustment												
Pneumatic w/Seat Depth Adjustment	SFS-U0-7S02A		\$1694.00	\$1728.00	\$1764.00	\$1782.00	\$1795.00	\$1827.00	\$1857.00	\$1936.00	\$1992.00	\$2134.00
Back Stop w/Seat Depth Adjustment	SFS-U0-7S01A		1774.00	1808.00	1844.00	1862.00	1875.00	1907.00	1937.00	2016.00	2072.00	2214.00
Mesh Back, Lumbar Adjustment												
Pneumatic w/Seat Depth Adjustment	SFS-U0-7S12A		\$1784.00	\$1818.00	\$1854.00	\$1872.00	\$1885.00	\$1917.00	\$1947.00	\$2026.00	\$2082.00	\$2224.00
Back Stop w/Seat Depth Adjustment	SFS-U0-7S11A		1864.00	1898.00	1934.00	1952.00	1965.00	1997.00	2027.00	2106.00	2162.00	2304.00

The following options require modification of the product number.

- Fixed seat To specify, change the 10th digit from an **A** to **F** and deduct **\$20.00** list; **Example:** SFS-U0-7S02**F**1
- Faux Leather back To specify, change the fifth digit in the product number to **U**; **Example:** SFS-U**U**-7S02A1 (Wellington; add **\$115.00** list, Brisa; add **\$297.00** list)
- Stain repellent (Seat only) To specify, add **P** to the end of the product number and add **\$35.00** list; **Example:** SFS-U0-7S02A1**P**

Fern

Task Stool with Height Adjustable Arms — **Plastic Model**



SFS-U0-4S02A

Dimensions

- *SH: 21.75"-29.25"
(552mm-743mm)
- H: 46.75"-54.75"
(1187mm-1391mm)
- D: 28.5"(724mm)
- W: 29"(737mm)
- *SW: 19.9"(505mm)
- *AH: 6.7"-11.5"
(170mm-292mm)
- *SD: 15.5"-18.5"
(394mm-470mm)

* All measurements taken with the BIFMA chair measuring device.

Features

- Back: Flexible back with built in fronds wrapped in lofted mesh or faux leather.
- Seat: Flexible seat pan with standard upholstered foam.
- Standard fixed seat. Optional seat depth adjustment (3"(76mm) range).
- Base: Plastic five-star base.
- Optional height adjustable lumbar support (4"(102mm) adjustment).
- Arms: Height Adjustable with soft arm caps. Adjustment range of 4.8"(122mm).
- Mechanism: Synchronized 3-point tilt; standard tilt tension adjustment.
- Height Adjustment: Pneumatic. Range: 21.75"-29.25"(552mm-743mm).
- Optional Back Stop: 4 positions.
- Footring: Adjusts 4"(102mm) up and down. Brushed aluminum finish.
- Casters: Hard casters in black or two-tone grey; Soft casters black only.
- COM yardage / COL square footage: (Seat only) 0.71/8

To Order, Specify:

- 1) Product number, including;
 - 1 Caster Option:**
 - 5** Hard Casters (Black)
 - 6** Soft Casters (Black)
 - 7** Hard Two-Tone Casters (Grey)
- 2) Fabric surface and color (seat).
- 3) Mesh or faux leather color (back).
- 4) Plastic trim color for back frame/cradle/arm uprights/arm caps/levers/base.
- 5) Aluminum trim color for back upright and mechanism.
(Add **\$90.00** list for polished aluminum back upright and mechanism.)

1st Trim Color (Plastic)	Arm Cap/Levers	Lumbar Handle
TR-F Black	TR-F Black	TR-TF Pitch
TR-7 Fog	TR-7 Fog	TR-AR Argent

Description	Number	1	Fabric Grade								Leather Grade A	Leather Grade B
			A	B	C	D	E	F	G	H		
Mesh Back, No Lumbar Adjustment												
Pneumatic w/Seat Depth Adjustment	SFS-U0-4S02A		\$1517.00	\$1551.00	\$1587.00	\$1605.00	\$1618.00	\$1650.00	\$1680.00	\$1759.00	\$1815.00	\$1957.00
Back Stop w/Seat Depth Adjustment	SFS-U0-4S01A		1597.00	1631.00	1667.00	1685.00	1698.00	1730.00	1760.00	1839.00	1895.00	2037.00
Mesh Back, Lumbar Adjustment												
Pneumatic w/Seat Depth Adjustment	SFS-U0-4S12A		\$1607.00	\$1641.00	\$1677.00	\$1695.00	\$1708.00	\$1740.00	\$1770.00	\$1849.00	\$1905.00	\$2047.00
Back Stop w/Seat Depth Adjustment	SFS-U0-4S11A		1687.00	1721.00	1757.00	1775.00	1788.00	1820.00	1850.00	1929.00	1985.00	2127.00

The following options require modification of the product number.

- Fixed seat To specify, change the 10th digit from an **A** to **F** and deduct **\$20.00** list; **Example:** SFS-U0-4S02F5
- Faux Leather back To specify, change the fifth digit in the product number to **U**; **Example:** SFS-UU-4S02A5 (Wellington; add **\$115.00** list, Brisa; add **\$297.00** list)
- Stain repellent (Seat only) To specify, add **P** to the end of the product number and add **\$35.00** list; **Example:** SFS-U0-4S02A5P

Fern

Task Stool with Height Adjustable Arms — Aluminum Model



SFS-U0-4S02A

Dimensions

- *SH: 21.75"-29.25"
(552mm-743mm)
- H: 46.75"-54.75"
(1187mm-1391mm)
- D: 28.5"(724mm)
- W: 29"(737mm)
- *SW: 19.9"(505mm)
- *AH: 6.7"-11.5"
(170mm-292mm)
- *SD: 15.5"-18.5"
(394mm-470mm)

* All measurements taken with the BIFMA chair measuring device.

Features

- Back: Flexible back with built in fronds wrapped in lofted mesh or faux leather.
- Seat: Flexible seat pan with standard upholstered foam.
- Standard fixed seat. Optional seat depth adjustment (3"(76mm) range).
- Optional height adjustable lumbar support (4"(102mm) adjustment).
- Arms: Height Adjustable with soft arm caps. Adjustment range of 4.8"(122mm).
- Mechanism: Synchronized 3-point tilt; standard tilt tension adjustment.
- Height Adjustment: Pneumatic. Range: 21.75"-29.25"(552mm-743mm).
- Optional Back Stop: 4 positions.
- Base: Aluminum five-star base.
- Footring: Adjusts 4"(102mm) up and down. Brushed aluminum finish.
- Casters: Hard casters in black or two-tone grey; Soft casters black only.
- COM yardage / COL square footage: (Seat only) 0.71/8

To Order, Specify:

- 1) Product number, including;

1 Caster Option:

- 1** Hard Casters (Black)
- 2** Soft Casters (Black)
- T** Hard Two-Tone Casters (Grey)

- 2) Fabric surface and color (seat).
- 3) Mesh or faux leather color (back).
- 4) Plastic trim color for back frame/cradle/arm caps/levers. (Add **\$55.00** list for Snow TR-UFM for back frame/cradle.)
- 5) Aluminum trim color for back and arm upright/mechanism/base. (Add **\$90.00** list for polished aluminum back upright and mechanism.)

1st Trim Color (Plastic)	Arm Cap/Levers	Lumbar Handle
TR-F Black	TR-F Black	TR-TF Pitch
TR-7 Fog	TR-7 Fog	TR-AR Argent
TR-UFM Snow	TR-7 Fog	TR-FS Snowfall
TR-UFM Snow w/2nd trim PM-P Polished Aluminum	TR-7 Fog	PM-P Polished Aluminum

Description	Number	Fabric Grade								Leather Grade A	Leather Grade B	
		1	A	B	C	D	E	F	G			H
Mesh Back, No Lumbar Adjustment												
Pneumatic w/Seat Depth Adjustment	SFS-U0-4S02A		\$1669.00	\$1703.00	\$1739.00	\$1757.00	\$1770.00	\$1802.00	\$1832.00	\$1911.00	\$1967.00	\$2109.00
Back Stop w/Seat Depth Adjustment	SFS-U0-4S01A		1749.00	1783.00	1819.00	1837.00	1850.00	1882.00	1912.00	1991.00	2047.00	2189.00
Mesh Back, Lumbar Adjustment												
Pneumatic w/Seat Depth Adjustment	SFS-U0-4S12A		\$1759.00	\$1793.00	\$1829.00	\$1847.00	\$1860.00	\$1892.00	\$1922.00	\$2001.00	\$2057.00	\$2199.00
Back Stop w/Seat Depth Adjustment	SFS-U0-4S11A		1839.00	1873.00	1909.00	1927.00	1940.00	1972.00	2002.00	2081.00	2137.00	2279.00

The following options require modification of the product number.

- Fixed seat To specify, change the 10th digit from an **A** to **F** and deduct **\$20.00** list; **Example:** SFS-U0-4S02F1
- Faux Leather back To specify, change the fifth digit in the product number to **U**; **Example:** SFS-UU-4S02A1 (Wellington; add **\$115.00** list, Brisa; add **\$297.00** list)
- Stain repellent (Seat only) To specify, add **P** to the end of the product number and add **\$35.00** list; **Example:** SFS-U0-4S02A1P

Fern

Task Stool with Fixed Arms — **Plastic Model**



SFS-U0-1S02A

Dimensions

- *SH: 21.75"-29.25"
(552mm-743mm)
- H: 46.75"-54.75"
(1187mm-1391mm)
- D: 28.5"(724mm)
- W: 29"(737mm)
- *SW: 19.9"(505mm)
- *AH: 9"(229mm)
- *SD: 15.5"-18.5"
(394mm-470mm)

* All measurements taken with the BIFMA chair measuring device.

Features

- Back: Flexible back with built in fronds wrapped in lofted mesh or faux leather.
- Seat: Flexible seat pan with standard upholstered foam.
- Standard fixed seat. Optional seat depth adjustment (3"(76mm) range).
- Optional height adjustable lumbar support (4"(102mm) adjustment).
- Arms: Fixed aluminum arms with soft arm caps.
- Optional leather arm cap available when ordering a leather seat. Leather arm cap coordinates with leather seat selection.
- Mechanism: Synchronized 3-point tilt; standard tilt tension adjustment.
- Height Adjustment: Pneumatic. Range: 21.75"-29.25"(552mm-743mm).
- Optional Back Stop: 4 positions.
- Base: Plastic five-star base.
- Footring: Adjusts 4"(102mm) up and down. Brushed aluminum finish.
- Casters: Hard casters in black or two-tone grey; Soft casters black only.
- COM yardage / COL square footage: (Seat only) 0.71/8

To Order, Specify:

- 1) Product number, including;
 - 1 Caster Option:**
 - 5** Hard Casters (Black)
 - 6** Soft Casters (Black)
 - 7** Hard Two-Tone Casters (Grey)
- 2) Fabric surface and color (seat).
- 3) Mesh or faux leather color (back).
- 4) Plastic trim color for back frame/cradle/arm caps/levers/base.
- 5) Aluminum trim color for back and arm upright/mechanism. (Add **\$90.00** list for polished aluminum back upright and mechanism.)

1st Trim Color (Plastic)	Arm Cap/Levers	Lumbar Handle
TR-F Black	TR-F Black	TR-TF Pitch
TR-7 Fog	TR-7 Fog	TR-AR Argent

Description	Number	Fabric Grade								Leather Grade A	Leather Grade B
		1 A	B	C	D	E	F	G	H		
Mesh Back, No Lumbar Adjustment											
Pneumatic w/Seat Depth Adjustment	SFS-U0-1S02A	\$1502.00	\$1536.00	\$1572.00	\$1590.00	\$1603.00	\$1635.00	\$1665.00	\$1744.00	\$1800.00	\$1942.00
Back Stop w/Seat Depth Adjustment	SFS-U0-1S01A	1582.00	1616.00	1652.00	1670.00	1683.00	1715.00	1745.00	1824.00	1880.00	2022.00
Mesh Back, Lumbar Adjustment											
Pneumatic w/Seat Depth Adjustment	SFS-U0-1S12A	\$1592.00	\$1626.00	\$1662.00	\$1680.00	\$1693.00	\$1725.00	\$1755.00	\$1834.00	\$1890.00	\$2032.00
Back Stop w/Seat Depth Adjustment	SFS-U0-1S11A	1672.00	1706.00	1742.00	1760.00	1773.00	1805.00	1835.00	1914.00	1970.00	2112.00

The following options require modification of the product number.

- Fixed seat To specify, change the 10th digit from an **A** to **F** and deduct **\$20.00** list; **Example:** SFS-U0-1S02**F5**
- Leather arm cap To specify, change the 7th digit from **S** to **L**; **Example:** SFS-U0-1**L**02A5 (matches required Leather seat), add **\$70.00** list
- Faux Leather back To specify, change the fifth digit in the product number to **U**; **Example:** SFS-U**U**-1S02A5 (Wellington; add **\$115.00** list, Brisa; add **\$297.00** list)
- Stain repellent (Seat only) To specify, add **P** to the end of the product number and add **\$35.00** list; **Example:** SFS-U0-1S02A5**P**

Fern

Task Stool with Fixed Arms — Aluminum Model



SFS-U0-1S02A

Dimensions

- *SH: 21.75"-29.25"
(552mm-743mm)
- H: 46.75"-54.75"
(1187mm-1391mm)
- D: 28.5"(724mm)
- W: 29"(737mm)
- *SW: 19.9"(505mm)
- *AH: 9"(229mm)
- *SD: 15.5"-18.5"
(394mm-470mm)

* All measurements taken with the BIFMA chair measuring device.

Features

- Back: Flexible back with built in fronds wrapped in lofted mesh or faux leather.
- Seat: Flexible seat pan with standard upholstered foam.
- Standard fixed seat. Optional seat depth adjustment (3"(76mm) range).
- Optional height adjustable lumbar support (4"(102mm) adjustment).
- Arms: Fixed with soft arm caps.
- Optional leather arm cap available when ordering a leather seat. Leather arm cap coordinates with leather seat selection.
- Mechanism: Synchronized 3-point tilt; standard tilt tension adjustment.
- Height Adjustment: Pneumatic. Range: 21.75"-29.25"(552mm-743mm).
- Optional Back Stop: 4 positions.
- Base: Aluminum five-star base.
- Footring: Adjusts 4"(102mm) up and down. Brushed aluminum finish.
- Casters: Hard casters in black or two-tone grey; Soft casters black only.
- COM yardage / COL square footage: (Seat only) 0.71/8

To Order, Specify:

1) Product number, including;

1 Caster Option:

- 1** Hard Casters (Black)
- 2** Soft Casters (Black)
- T** Hard Two-Tone Casters (Grey)

2) Fabric surface and color (seat).

3) Mesh or faux leather color (back).

4) Plastic trim color for base frame/cradle/arm caps/levers. (Add **\$55.00** list for Snow TR-UFM for back frame/cradle.)

5) Aluminum trim color for back and arm upright/mechanism/base. (Add **\$90.00** list for polished aluminum back upright and mechanism.)

1st Trim Color (Plastic)	Arm Cap/Levers	Lumbar Handle
TR-F Black	TR-F Black	TR-TF Pitch
TR-7 Fog	TR-7 Fog	TR-AR Argent
TR-UFM Snow	TR-7 Fog	TR-FS Snowfall
TR-UFM Snow w/2nd trim PM-P Polished Aluminum	TR-7 Fog	PM-P Polished Aluminum

Description	Number	Fabric Grade								Leather Grade A	Leather Grade B	
		1	A	B	C	D	E	F	G			H
Mesh Back, No Lumbar Adjustment												
Pneumatic w/Seat Depth Adjustment	SFS-U0-1S02A		\$1654.00	\$1688.00	\$1724.00	\$1742.00	\$1755.00	\$1787.00	\$1817.00	\$1896.00	\$1952.00	\$2094.00
Back Stop w/Seat Depth Adjustment	SFS-U0-1S01A		1734.00	1768.00	1804.00	1822.00	1835.00	1867.00	1897.00	1976.00	2032.00	2174.00
Mesh Back, Lumbar Adjustment												
Pneumatic w/Seat Depth Adjustment	SFS-U0-1S12A		\$1744.00	\$1778.00	\$1814.00	\$1832.00	\$1845.00	\$1877.00	\$1907.00	\$1986.00	\$2042.00	\$2184.00
Back Stop w/Seat Depth Adjustment	SFS-U0-1S11A		1824.00	1858.00	1894.00	1912.00	1925.00	1957.00	1987.00	2066.00	2122.00	2264.00

The following options require modification of the product number.

- Fixed seat To specify, change the 10th digit from an **A** to **F** and deduct **\$20.00** list; **Example:** SFS-U0-1S02**F**1
- Leather arm cap To specify, change the 7th digit from **S** to **L**; **Example:** SFS-U0-1**L**02A1 (matches required Leather seat), add **\$70.00** list
- Faux Leather back To specify, change the fifth digit in the product number to **U**; **Example:** SFS-**UU**-1S02A1 (Wellington; add **\$115.00** list, Brisa; add **\$297.00** list)
- Stain repellent (Seat only) To specify, add **P** to the end of the product number and add **\$35.00** list; **Example:** SFS-U0-1S02A1**P**

Fern

Task Stool without Arms — Plastic Model



SFS-U0-0N02A

Dimensions

- *SH: 21.75"-29.25"
(552mm-743mm)
- H: 46.75"-54.75"
(1187mm-1391mm)
- D: 28.5"(724mm)
- W: 29"(737mm)
- *SW: 19.9"(505mm)
- *SD: 15.5"-18.5"
(394mm-470mm)

* All measurements taken with the BIFMA chair measuring device.

Features

- Back: Flexible back with built in fronds wrapped in lofted mesh or faux leather.
- Seat: Flexible seat pan with standard upholstered foam.
- Standard fixed seat. Optional seat depth adjustment (3"(76mm) range).
- Optional height adjustable lumbar support (4"(102mm) adjustment).
- Mechanism: Synchronized 3-point tilt; standard tilt tension adjustment.
- Height Adjustment: Pneumatic. Range: 21.75"-29.25"(552mm-743mm).
- Optional Back Stop: 4 positions.
- Footring: Adjusts 4"(102mm) up and down. Brushed aluminum finish.
- Casters: Hard casters in black or two-tone grey; Soft casters black only.
- COM yardage / COL square footage:
(Seat only) 0.71/8

To Order, Specify:

- 1) Product number, including;
 - 1** **Caster Option:**
 - 5** Hard Casters (Black)
 - 6** Soft Casters (Black)
 - 7** Hard Two-Tone Casters (Grey)
- 2) Fabric surface and color (seat).
- 3) Mesh or faux leather color (back).
- 4) Plastic trim color for back frame/cradle/ levers/base.
- 5) Aluminum trim color for back upright and mechanism.
(Add **\$90.00** list for polished aluminum back upright and mechanism.)

1st Trim Color (Plastic)	Levers	Lumbar Handle
TR-F Black	TR-F Black	TR-TF Pitch
TR-7 Fog	TR-7 Fog	TR-AR Argent

Description	Number	Fabric Grade								Leather Grade A	Leather Grade B	
		1	A	B	C	D	E	F	G			H
Mesh Back, No Lumbar Adjustment												
Pneumatic w/Seat Depth Adjustment	SFS-U0-0N02A		\$1382.00	\$1416.00	\$1452.00	\$1470.00	\$1483.00	\$1515.00	\$1545.00	\$1624.00	\$1680.00	\$1822.00
Back Stop w/Seat Depth Adjustment	SFS-U0-0N01A		1462.00	1496.00	1532.00	1550.00	1563.00	1595.00	1625.00	1704.00	1760.00	1902.00
Mesh Back, Lumbar Adjustment												
Pneumatic w/Seat Depth Adjustment	SFS-U0-0N12A		\$1472.00	\$1506.00	\$1542.00	\$1560.00	\$1573.00	\$1605.00	\$1635.00	\$1714.00	\$1770.00	\$1912.00
Back Stop w/Seat Depth Adjustment	SFS-U0-0N11A		1552.00	1586.00	1622.00	1640.00	1653.00	1685.00	1715.00	1794.00	1850.00	1992.00

The following options require modification of the product number.

- Fixed seat To specify, change the 10th digit from an **A** to **F** and deduct **\$20.00** list; **Example:** SFS-U0-0N02F5
- Faux Leather back To specify, change the fifth digit in the product number to **U**; **Example:** SFS-UU-0N02A5 (Wellington; add **\$115.00** list, Brisa; add **\$297.00** list)
- Stain repellent (Seat only) To specify, add **P** to the end of the product number and add **\$35.00** list; **Example:** SFS-U0-0N02A5P

Fern

Task Stool without Arms — Aluminum Model



SFS-U0-0N02A

Dimensions

- *SH: 21.75"-29.25"
(552mm-743mm)
- H: 46.75"-54.75"
(1187mm-1391mm)
- D: 28.5"(724mm)
- W: 29"(737mm)
- *SW: 19.9"(505mm)
- *SD: 15.5"-18.5"
(394mm-470mm)

* All measurements taken with the BIFMA chair measuring device.

Features

- Back: Flexible back with built in fronds wrapped in lofted mesh or faux leather.
- Seat: Flexible seat pan with standard upholstered foam.
- Standard fixed seat. Optional seat depth adjustment (3"(76mm) range).
- Optional height adjustable lumbar support (4"(102mm) adjustment).
- Mechanism: Synchronized 3-point tilt; standard tilt tension adjustment.
- Height Adjustment: Pneumatic. Range: 21.75"-29.25"(552mm-743mm).
- Optional Back Stop: 4 positions.
- Base: Aluminum five-star base.
- Footring: Adjusts 4"(102mm) up and down. Brushed aluminum finish.
- Casters: Hard casters in black or two-tone grey; Soft casters black only.
- COM yardage / COL square footage: (Seat only) 0.71/8

To Order, Specify:

- 1) Product number, including;

1) Caster Option:

- 1** Hard Casters (Black)
- 2** Soft Casters (Black)
- T** Hard Two-Tone Casters (Grey)

- 2) Fabric surface and color (seat).
- 3) Mesh or faux leather color (back).
- 4) Plastic trim color for back frame/cradle/levers. (Add **\$55.00** list for Snow TR-UFM for back frame/cradle.)
- 5) Aluminum trim color for back upright/mechanism/base. (Add **\$90.00** list for polished aluminum back upright and mechanism.)

1st Trim Color (Plastic)	Levers	Lumbar Handle
TR-F Black	TR-F Black	TR-TF Pitch
TR-7 Fog	TR-7 Fog	TR-AR Argent
TR-UFM Snow	TR-7 Fog	TR-FS Snowfall
TR-UFM Snow w/2nd trim PM-P Polished Aluminum	TR-7 Fog	PM-P Polished Aluminum

Description	Number	1	Fabric Grade								Leather Grade A	Leather Grade B
			A	B	C	D	E	F	G	H		
Mesh Back, No Lumbar Adjustment												
Pneumatic w/Seat Depth Adjustment	SFS-U0-0N02A		\$1534.00	\$1568.00	\$1604.00	\$1622.00	\$1635.00	\$1667.00	\$1697.00	\$1776.00	\$1832.00	\$1974.00
Back Stop w/Seat Depth Adjustment	SFS-U0-0N01A		1614.00	1648.00	1684.00	1702.00	1715.00	1747.00	1777.00	1856.00	1912.00	2054.00
Mesh Back, Lumbar Adjustment												
Pneumatic w/Seat Depth Adjustment	SFS-U0-0N12A		\$1624.00	\$1658.00	\$1694.00	\$1712.00	\$1725.00	\$1757.00	\$1787.00	\$1866.00	\$1922.00	\$2064.00
Back Stop w/Seat Depth Adjustment	SFS-U0-0N11A		1704.00	1738.00	1774.00	1792.00	1805.00	1837.00	1867.00	1946.00	2002.00	2144.00

The following options require modification of the product number.

- Fixed seat To specify, change the 10th digit from an **A** to **F** and deduct **\$20.00** list; **Example:** SFS-U0-0N02F1
- Faux Leather back To specify, change the fifth digit in the product number to **U**; **Example:** SFS-UU-0N02A1 (Wellington; add **\$115.00** list; Brisa; add **\$297.00** list)
- Stain repellent (Seat only) To specify, add **P** to the end of the product number and add **\$35.00** list; **Example:** SFS-U0-0N02A1P

Zody-At-A-Glance

Designer	ITO Design and Haworth Design Studio
Awards/Achievements	NeoCon Silver, Best of NeoCon, Seating: Ergonomic Desk/Task, June 2005, USA IIDEX/NeoCon Gold, Seating: Desk/Workstation Chairs, September 2005, Canada BIFMA level 3 certified.
Zody	A high-performing chair that blends science-based wellness and comfort with sustainability and international design.

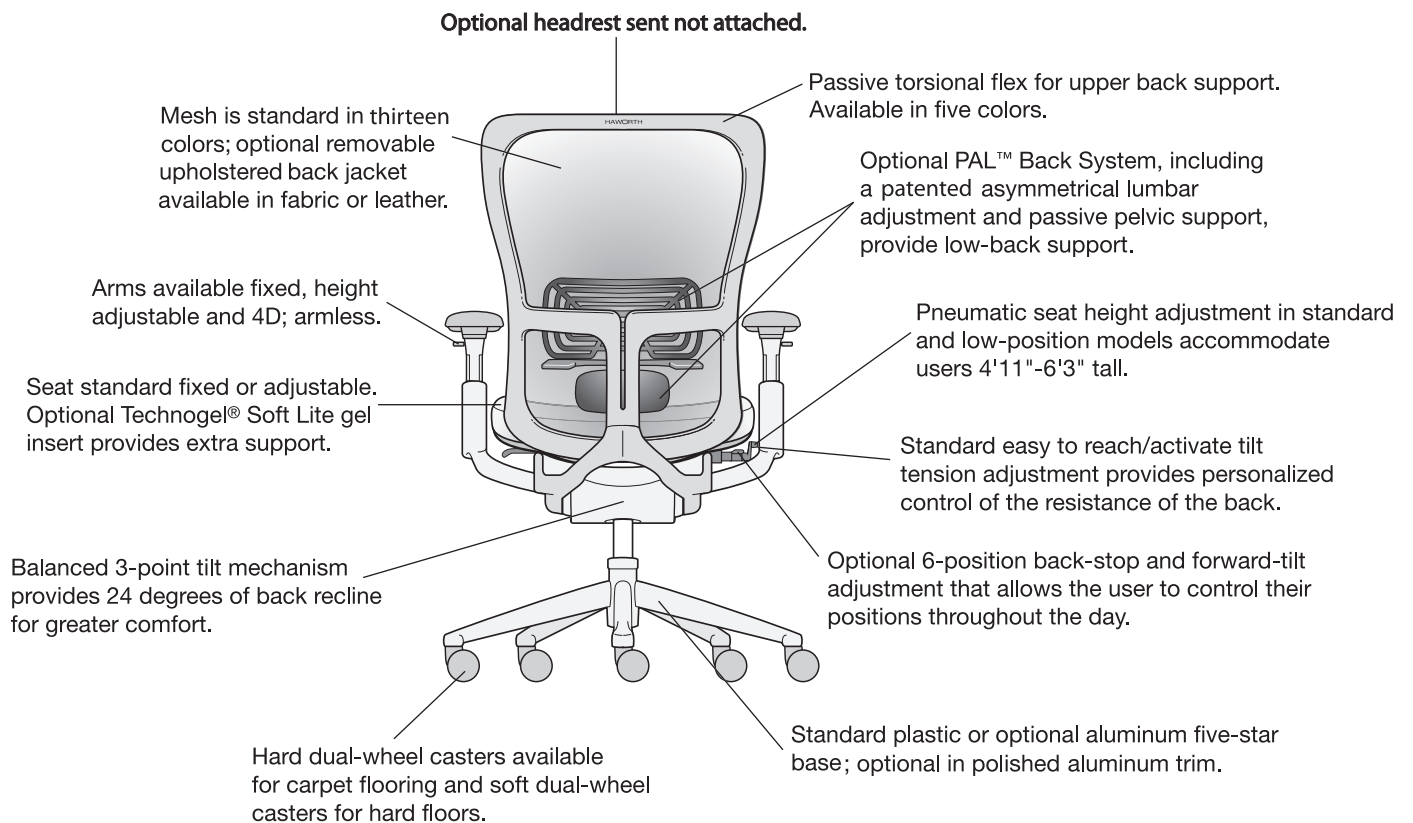

Note: Headrest and forward-tilt options not available on Stool.

Zody-At-A-Glance

General Specifications

General Guidelines for Product Specification

Zody seating specification numbers are based on an alpha-numeric logic that identifies a product by model and certain characteristics.

For example, a product number that reads **SZT-20-702MA5 3A-18 MA-001 TR-F TR-LE** identifies the product as a Zody mesh back chair with 4D arms, no lumbar, pneumatic seat height adjustment, foam adjustable seat and standard base with hard casters. The numeric logic for this model with fabric and finish codes is shown below:

Mesh Back

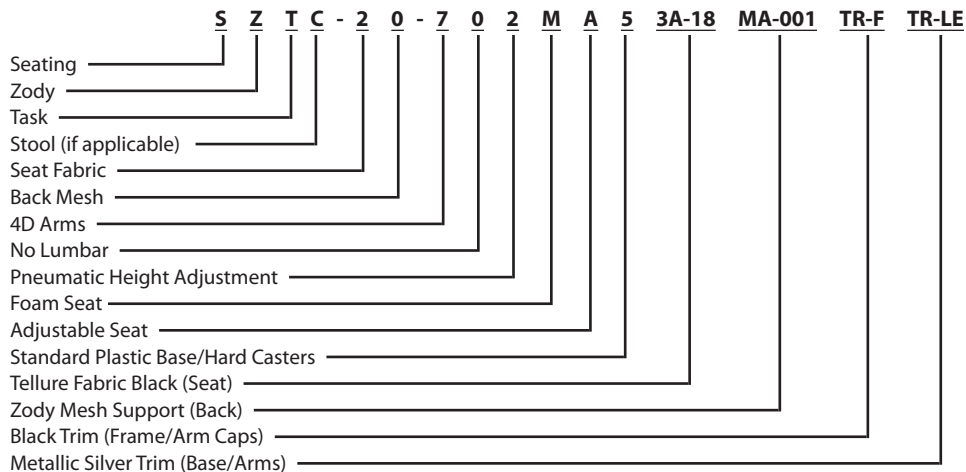

Mesh Back with Upholstered Back Jacket

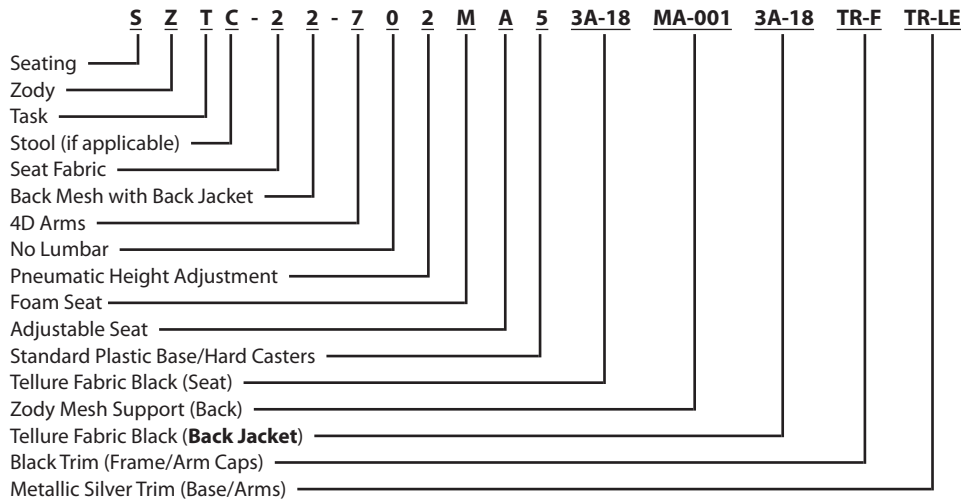

There are exceptions to this logic; therefore, always refer to the price charts for product numbers rather than attempting to construct them. Product number modification instructions for additional options appear in footnoted copy for each applicable model.

Beyond the printed product number, fabric and finish codes are required to complete an order specification. To communicate your order clearly, list the product number and fabric/finish codes in the sequence outlined on each price page.

Zody-At-A-Glance

General Specifications

Environmental Factors	<ul style="list-style-type: none"> • Zody has been evaluated for its human health, environmental health, lifecycle attributes, renewable energy, water stewardship and social responsibility characteristics against stringent certification criteria and is considered an ecologically intelligent product. • Greenguard Children and Schools certified for low emissions. • BIFMA level 3 certified 2012. • Zody has up to 51% recycled content and is up to 98% recyclable. • Zody is produced in an ISO 14001 certified manufacturing facility. • Zody is assembled using renewable power. Haworth has purchased 100% Green-e certified American wind power credits to offset the energy consumed in manufacturing the product. • Components are identified with ISO recycling symbols and material information to assist in the recycling effort, where practical. • Haworth will take back Zody chairs after their useful life and recycle the components. Please contact Haworth's Material Recovery Center at (616)393-1215. • Optional Trivalent chrome finish provides safer and more environmentally friendly alternative for customers requiring the attributes of a chrome finish.
COM & COL General Information	<p>To order a COM fabric (Customer's Own Material), contact the Haworth Inquiry Center (1.800.426.8562), your local Haworth dealer, or go to surfaces.haworth.com > COM Library to find out if the COM you have selected has already been tested and approved. The surface collection site also has information on the Haworth+ alliance program with Carnegie, Luna Textiles, and Maharam as well as our industry-leading Pre-Approved COM program.</p> <p>COM fabrics are placed into Grades based on the cost per linear yard. If a fabric's cost exceeds the range of our highest Grade it will be noted as Non-Graded. The product will be priced at Grade A; the COM fabric costs will appear as a separate line item. The fabric charge will be Haworth's purchase cost plus a 4% administrative fee (based on the cost of the fabric). Yardage calculations will include any applicable fabric repeat.</p> <p>COM Leather products will be priced at a leather Grade A; COL costs will appear as a separate line item. The leather costs will be Haworth's purchase cost plus a 4% administrative fee (based on the cost of the leather).</p>
Finishes and Fabrics	A complete listing of finishes and fabrics for Zody seating is available in the back of the price list.
Shipping Weights (Including packaging)	<ul style="list-style-type: none"> • Chairs with arms: 55 pounds/1 chair per carton/17.3 cubic feet • Chairs without arms: 51 pounds/1 chair per carton/17.3 cubic feet • Chairs with sled base: 24 pounds/1 chair per carton/17.3 cubic feet • Chairs with leg base: 21 pounds/1 chair per carton/17.3 cubic feet • Stool with arms: 58 pounds/1 stool per carton/21.5 cubic feet • Stool without arms: 54 pounds/1 stool per carton/21.5 cubic feet
RUSH	Select Zody seating models marked with a  symbol to denote availability on the RUSH program. Refer to the fabric and finish options for each product.
Stain Repellent	<p>To specify add "P" to end of product number. Example: SZT-22-702MA1P</p> <p>Not available on mesh, faux leather, or leather. For available fabrics, refer to surfaces.haworth.com.</p>

Zody

General Specifications

STANDARD MOBILITY AND ADJUSTABILITY

Balanced 3-point tilt

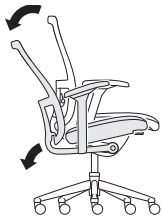

Features:

- Balanced 3-point tilt mechanism.
- Back reclines 24° from the upright position.
- Seat pan moves downward 3° from the initial position.

Benefits:

- Comfortable relaxed posture.
- Recline allows for the opening of the users' chest cavity providing good airflow to promote alertness.
- Users' feet remain flat.

Tilt Tension Control

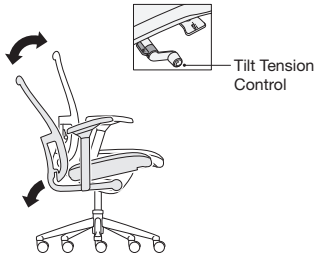

Feature:

- Easy-to-reach and easy-to-activate side-mounted tilt tension control regulates the amount of resistance felt when leaning back in the chair and the effort required to recline the chair backwards.

Benefit:

- Personalized support to accommodate users of different body types and different work styles.

Seat Height Adjustment

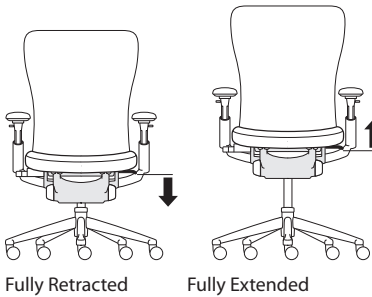

Features:

- Pneumatic seat height adjustment.
- Task chair seat height adjusts 5"(127mm) from 16" to 21"(406mm to 533mm) in standard models. Low-position adjusts 14" to 17"(356 to 432mm).
- Task stool seat height adjusts 7.5"(191mm) from 21.5" to 29"(546mm to 737mm).

Benefits:

- Ensures the comfort of the lower limbs by avoiding pressure on the underside of the thigh caused by a seat pan that is too high, or decreased thigh-to-torso angle if the seat pan is too low.
- Accommodates for users between approximately 4'11"(1499mm) and 6'3"(1905mm) tall to provide good leg circulation.
- Seat height adjustment also is important in setting the proper hand position and allowing for a proper sitting eye height.

Seat Depth Adjustment

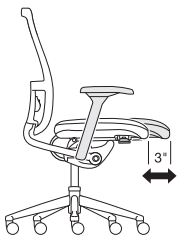

Features:

- 3"(76mm) of seat depth range. (Fixed seat also available.)
- Available with conventional foam material or optional Technogel® Soft Lite gel insert.
- Waterfall edge.

Benefit:

- Supports the thighs, allows users to rest against the seat back for back support, and avoids pressure on the back of the knees of small to tall users.

Upper Back Torsional Movement



Feature:

- Passive 2"(51mm) of torsional flex in the upper back.
- Patented mesh with built in tension zones for added comfort.

Benefit:

- Increases users' mobility and comfort when reaching sideways for objects.

Zody

General Specifications

OPTIONAL MOBILITY AND ADJUSTABILITY

PAL Back System**Features:**

- PAL Back System includes Asymmetrical Lumbar Adjustment and passive pelvic support.
- Asymmetrical Lumbar Adjustment adjusts 4"(102mm) in height; support level can be adjusted independently for right or left-hand side of users' body.
- Passive pelvic support.

Benefits:

- Lumbar adjustment maintains the natural curvature of the spine at the lower back and allows users to choose the support that feels right for them.
- Passive pelvic support rotates the pelvis forward to maintain the natural spine shape.

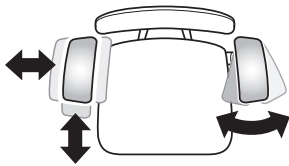
4D Arm**Features:**

- Optional 4D arm.
- Arm adjusts in 4 ways:
 - Height adjustment: 4"(102mm)
 - Side-to-side arm cap adjustment range: 3"(76mm) [1.5"(38mm) each arm cap]
 - Front-to-back adjustment range: 3 1/2"(89mm)
 - Pivoting: In 20°; out 20°

Benefits:

- Arms support the muscular system of users' neck and shoulders and proper arm support provides back relief. Arms can be an aid in standing or sitting down.
- Height adjustment accommodates for users with varying elbow rest heights so that users avoid lifting their shoulders or leaning sideways to get arm support.
- Front-to-back adjustment adjusts the armrest length, which is important because it allows users to get close to the worksurface while maintaining the effective use of the backrest.
- Side-to-side adjustment ensures a comfortable resting position for the arms with proper support of the forearm while allowing for easy entry/exit of the chair.
- Pivoting provides proper support of the forearm when performing tasks involving keying and mousing.

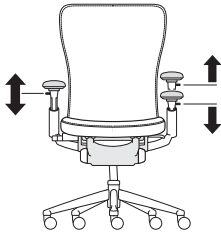
Adjustable Height Arm**Feature:**

- Optional height adjustable arms adjust 4"(102mm) vertically.

Benefit:

- Height adjustment accommodates users with varying elbow rest heights so that users avoid lifting their shoulders or leaning sideways to get arm support.

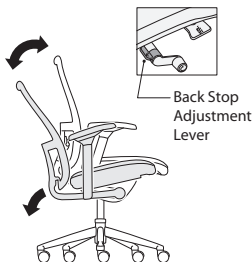
Tilt with Back Stop**Features:**

- Optional back stop;
- Back stops in 6 positions - upright and every 4° backward.
- Tilt limiter.

Benefit:

- Allows users the choice of selecting an upright position or limiting the amount of recline while performing different tasks.

Zody

General Specifications

OPTIONAL MOBILITY AND ADJUSTABILITY (continued)

Forward Tilt

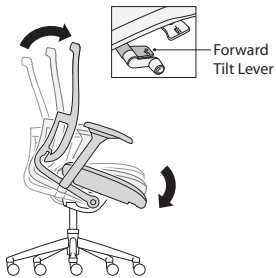

Features:

- Optional forward tilt.
- Seat pan moves downward 5° from the initial position.

Benefit:

- Allows the user the opportunity to vary their posture throughout the day.

Note: Not available on task stool.

Back Stop/Forward Tilt

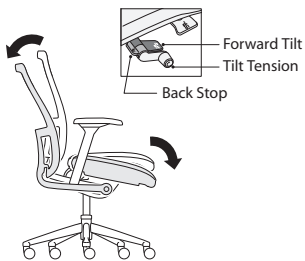

Feature:

- Optional back-stop and forward tilt.
- Back stops in 6 positions, upright and every 4° backward.

Benefit:

- Allows users to vary their posture for maximum comfort and for changes in task requirements.

Note: Not available on task stool.

Base

Standard Plastic Base

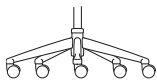

- TR-F Black
- TR-LE Metallic Silver
- TR-MC Metallic Champagne
- TR-MG Metallic Gunmetal*

Optional Aluminum Base

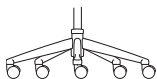

- TR-F Black
- TR-LE Metallic Silver
- TR-MC Metallic Champagne
- TR-MG Metallic Gunmetal*
- TR-RR Rusty Red
- TR-1M Sable
- PM-P Polished Aluminum

Low Position Base (Aluminum only)

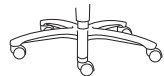

- TR-F Black
- TR-LE Metallic Silver
- TR-MC Metallic Champagne
- TR-MG Metallic Gunmetal*

*Color on Alert status and being considered for future obsolescence due to low volume.

Note: Low Position Base not available on stool.

Ergonomic Standards Guidelines

- All Zody models meet or exceed all ANSI/BIFMA durability standards for office seating.
- Zody meets the following ergonomic standards/guidelines:
 - BSR/HFES 100-2002
 - BIFMA G1-2002
 - CSA-Z412-2000
 - CAN/CGSB 44.232-2002
 - HFES 2007

Zody

General Specifications
UPHOLSTERY / AESTHETIC OPTIONS

Leather Upholstery



Seat: Stitched double seams. Vertically in the center and on the edges of the seat cushion.

Back: Vertical stitched double seams on the upholstered back jacket with leather or Customers Own Leather (COL).

Upholstered Back Jacket

Front View:

Leather Jacket



Back View:



Features

- Removable.
- Back jacket covers the inside back of the chairs allowing a back view of the mesh. Jacket consists of padding covered with fabric or leather upholstery.
- Available in fabric, faux leather, leather, COM and COL.

Headrest



Features

- Height-adjustable 2.5" to fit a wide range of users, headrest is TPU material, like Zody arm.
 - Trim color of headrest front and back are in same color. Black or Smoke only. If a trim color other than Black or Smoke is specified, the headrest will default to Black or Smoke based on the matrix below.
 - Headrest sent not attached; 10.5"W x 7.5"H, 2.5" height adjustment.
 - See Zody price pages for specification (available on all task seating models). Not available on stools. Specification Example: SZE-22-722MA1 (Zody with headrest, 4D arm).
- To add a headrest to an existing model in the field order service part: Back and Headrest replacement, see e-Parts.

Specification

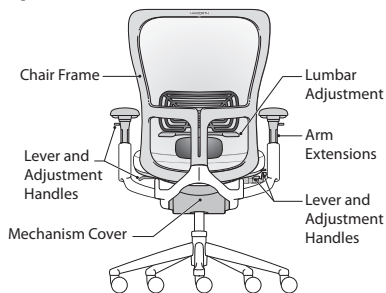

Features

- Trim color specification applies to the following components:
 - Chair frame
 - Levers
 - Adjustment handles
 - Lumbar adjustment (not lumbar pad)
 - Arm extensions
 - Mechanism covers
- Arm cap and Headrest color defaults based on the matrix below.

Trim Color	Arm Cap & Headrest Color*	
	Black	Smoke
Black (TR-F)	•	
Rusty Red (TR-RR)	•	
Sable (TR-1M)	•	
Smoke (TR-E)		•
Snow (TR-UFM)		•

*Not specifiable.

Zody Value Model

Task Chair with 4D Arms

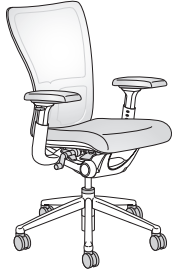

SZT-20-711MA5

Dimensions*

- *SH: 16-21"
(406mm-533mm)
- H: 38-43"(965mm-1092mm)
- D: 29"(737mm)
- W: 29"(737mm)
- *SW: 19 1/4"(489mm)
- *AH: 6.8-10.8"
(173mm-274mm)
- *SD: 16-19"(406mm-483mm)

* All measurements taken with the BIFMA chair measuring device.

Features

- Back: Soft mesh only.
- Seat:
 - Upholstered with foam.
 - Adjustable [3"(76mm) range]
- Base: Plastic five-star.
- Arms: 4D with soft arm caps.
- Mechanism: Balanced 3-point tilt; tilt tension.
- Pneumatic height adjustment.
- Back Stop: Tilt stop in 6 positions
- Asymmetrical Lumbar Adjustment: 4"(102mm) height adjustment; support level can be adjusted independently for right- or left-hand side of users body.
- Casters: Hard Casters
- Available on RUSH.

To Order, Specify:

- 1) Product number.
 - 2) Seat surface/color:
3A-18 Tellure - Black
 - 3) Mesh Back:
MA-001 Black
 - 4) Trim color for frame/arm caps:
TR-F Black
 - 5) Trim color for base/arms:
TR-F Black
- Note:** No changes to specification. No COM or Specials.

Number

SZT-20-711MA5 ■

Price

\$1190.00

Zody

Task Chair with 4D Arms



SZT-20-702MA1

Dimensions*

- *SH: 16-21"
(406mm-533mm)
- H: 38-43"(965mm-1092mm)
- D: 29"(737mm)
- W: 29"(737mm)
- *SW: 19 1/4"(489mm)
- *AH: 6.8-10.8"
(173mm-274mm)
- *SD: 16-19"(406mm-483mm)

Low position seat height:
14-17"(356mm-432mm)

* All measurements
taken with the
BIFMA chair
measuring device.

Trim Color	Arm Cap & Headrest Color*	
	Black	Smoke
Black (TR-F)	•	
Rusty Red (TR-RR)	•	
Sable (TR-1M)	•	
Smoke (TR-E)		•
Snow (TR-UFM)		•

*Not specifiable.

Features

- Back: Soft mesh only or mesh back with upholstered back jacket.
 - Seat: Standard upholstered with foam or optional foam with Technogel® Soft Lite gel insert.
 - Seat Type: Standard adjustable [3"(76mm) range] or optional fixed.
 - Base: Standard Plastic painted five-star base or optional painted aluminum or polished aluminum.
 - Plastic base available in Black, or painted Metallic Silver, Metallic Champagne and Metallic Gunmetal.
 - Aluminum base available with painted Black, Rusty Red, Snow, Metallic Silver, Metallic Champagne, Metallic Gunmetal, or optional Polished Aluminum.
 - Arms: 4D with soft arm caps. See matrix for default colors.
 - Mechanism: Balanced 3-point tilt; standard tilt tension.
 - Height adjustment: Pneumatic or low-position pneumatic.
 - Optional Back Stop: Tilt stop in 6 positions.
 - Optional Forward Tilt: 5 degrees downward from initial position.
 - Optional Back Stop with Forward Tilt
 - Optional Asymmetrical Lumbar Adjustment: 4"(102mm) height adjustment; support level can be adjusted independently for right or left hand side of users body. Optional PAL Back System: Passive pelvic support.
 - Casters: Standard with hard casters; optional soft casters.
 - COM yardage / COL square footage:
 - Mesh back model: .75/10
 - Mesh back/upholstered back jacket: 1.5/18
- Available on RUSH.

NOTE: When specifying fabric or leather back jacket; must also specify mesh surface color for outside back.

For different fabric grades on seat and upholstered back jacket, pricing will be determined by the sum of the upcharges of the selected jacket fabric grades (i.e. when choosing a Grade B fabric for the seat and a Grade D for the back, the final price will reflect the upcharge for a Grade B seat plus the upcharge for a Grade D back jacket.)

To Order with Mesh Back Specify:

- 1) Product number, including:

1 Base/Caster Option:**Aluminum Base**

- 1** Aluminum Base, Hard Caster, add **\$32.14** to list
- 2** Aluminum Base, Soft Caster, add **\$32.14** to list
- 3** Aluminum Low Base, Hard Caster, add **\$32.14** to list
- 4** Aluminum Low Base, Soft Caster, add **\$32.14** to list

Plastic Base

- 5** Plastic Std. Base, Hard Caster
- 6** Plastic Std. Base, Soft Caster

- 2) Fabric surface and color (seat).
- 3) Mesh surface and color (back).
- 4) Trim color for frame. (Add **\$55.00** list for Snow.)
- 5) Trim color for base/arms. (Add **\$187.83** list for polished aluminum.)

To Order with Fabric or Leather Upholstered Back Jacket Specify:

- 1) Product number, including:

1 Base/Caster Option:**Aluminum Base**

- 1** Aluminum Base, Hard Caster, add **\$32.14** to list
- 2** Aluminum Base, Soft Caster, add **\$32.14** to list
- 3** Aluminum Low Base, Hard Caster, add **\$32.14** to list
- 4** Aluminum Low Base, Soft Caster, add **\$32.14** to list

Plastic Base

- 5** Plastic Std. Base, Hard Caster
- 6** Plastic Std. Base, Soft Caster

- 2) Fabric surface and color (seat).
- 3) Mesh surface color (back).
- 4) Fabric surface and color (back jacket).
- 5) Trim color for frame. (Add **\$55.00** list for Snow.)
- 6) Trim color for base/arms. (Add **\$187.83** list for polished aluminum.)

Leather Seat with Mesh Back:

Change fourth digit in product number to **1**; fifth digit to **0**.

Example: SZT-10-702MA5

Leather Seat with Leather Upholstered Back Jacket:

Change fourth digit in product number to **1**; fifth digit to **1**.

Example: SZT-11-702MA5

Faux Leather Seat with Mesh Back:

Change the fourth digit in product number to **3**.

Example: SZT-30-702MA5

Faux Leather Seat with Faux Leather Upholstered Back Jacket:

Change the fourth and fifth digits in product number to **33**.

Example: SZT-33-702MA5

Zody

Task Chair with 4D Arms

Upholstered Foam Seat	Adjustments	Number	①	Fabric Grade								Leather Grade A	Leather Grade B
				A	B	C	D	E	F	G	H		
No Lumbar Adjustment - Mesh Back w/Plastic Base													
Pneumatic		SZT-20-702MA	■	\$1141.47	\$1175.21	\$1211.20	\$1229.21	\$1242.70	\$1275.32	\$1304.56	\$1384.42	\$1439.53	\$1586.02
Back Stop		SZT-20-701MA	■	1216.82	1250.56	1286.55	1304.56	1318.05	1350.67	1379.91	1459.77	1514.88	1661.37
Forward Tilt		SZT-20-703MA	■	1216.82	1250.56	1286.55	1304.56	1318.05	1350.67	1379.91	1459.77	1514.88	1661.37
Back Stop/ Forward Tilt		SZT-20-704MA	■	1240.45	1274.19	1310.18	1328.19	1341.68	1374.30	1403.54	1483.40	1538.51	1685.00
No Lumbar Adjustment - Upholstered Back Jacket w/Plastic Base													
Pneumatic		SZT-22-702MA	■	\$1252.82	\$1320.30	\$1392.28	\$1428.30	\$1455.28	\$1520.52	\$1579.00	\$1738.72	\$1848.94	\$2141.92
Back Stop		SZT-22-701MA	■	1328.17	1395.65	1467.63	1503.65	1530.63	1595.87	1654.35	1814.07	1924.29	2217.27
Forward Tilt		SZT-22-703MA	■	1328.17	1395.65	1467.63	1503.65	1530.63	1595.87	1654.35	1814.07	1924.29	2217.27
Back Stop/ Forward Tilt		SZT-22-704MA	■	1351.80	1419.28	1491.26	1527.28	1554.26	1619.50	1677.98	1837.70	1947.92	2240.90
Lumbar Adjustment - Mesh Back w/Plastic Base													
Pneumatic		SZT-20-712MA	■	\$1240.45	\$1274.19	\$1310.18	\$1328.19	\$1341.68	\$1374.30	\$1403.54	\$1483.40	\$1538.51	\$1685.00
Back Stop		SZT-20-711MA	■	1315.80	1349.54	1385.53	1403.54	1417.03	1449.65	1478.89	1558.75	1613.86	1760.35
Forward Tilt		SZT-20-713MA	■	1315.80	1349.54	1385.53	1403.54	1417.03	1449.65	1478.89	1558.75	1613.86	1760.35
Back Stop/ Forward Tilt		SZT-20-714MA	■	1339.43	1373.17	1409.16	1427.17	1440.66	1473.28	1502.52	1582.38	1637.49	1783.98
Lumbar Adjustment - Upholstered Back Jacket w/Plastic Base													
Pneumatic		SZT-22-712MA	■	\$1351.80	\$1419.28	\$1491.26	\$1527.28	\$1554.26	\$1619.50	\$1677.98	\$1837.70	\$1947.92	\$2240.90
Back Stop		SZT-22-711MA	■	1427.15	1494.63	1566.61	1602.63	1629.61	1694.85	1753.33	1913.05	2023.27	2316.25
Forward Tilt		SZT-22-713MA	■	1427.15	1494.63	1566.61	1602.63	1629.61	1694.85	1753.33	1913.05	2023.27	2316.25
Back Stop/ Forward Tilt		SZT-22-714MA	■	1450.78	1518.26	1590.24	1626.26	1653.24	1718.48	1776.96	1936.68	2046.90	2339.88
PAL Back System - Mesh Back w/Plastic Base													
Pneumatic		SZT-20-722MA	■	\$1266.32	\$1300.06	\$1336.05	\$1354.06	\$1367.55	\$1400.17	\$1429.41	\$1509.27	\$1564.38	\$1710.87
Back Stop		SZT-20-721MA	■	1341.67	1375.41	1411.40	1429.41	1442.90	1475.52	1504.76	1584.62	1639.73	1786.22
Forward Tilt		SZT-20-723MA	■	1341.67	1375.41	1411.40	1429.41	1442.90	1475.52	1504.76	1584.62	1639.73	1786.22
Back Stop/ Forward Tilt		SZT-20-724MA	■	1365.30	1399.04	1435.03	1453.04	1466.53	1499.15	1528.39	1608.25	1663.36	1809.85
PAL Back System - Upholstered Back Jacket w/Plastic Base													
Pneumatic		SZT-22-722MA	■	\$1377.67	\$1445.15	\$1517.13	\$1553.15	\$1580.13	\$1645.37	\$1703.85	\$1863.57	\$1973.79	\$2266.77
Back Stop		SZT-22-721MA	■	1453.02	1520.50	1592.48	1628.50	1655.48	1720.72	1779.20	1938.92	2049.14	2342.12
Forward Tilt		SZT-22-723MA	■	1453.02	1520.50	1592.48	1628.50	1655.48	1720.72	1779.20	1938.92	2049.14	2342.12
Back Stop/ Forward Tilt		SZT-22-724MA	■	1476.65	1544.13	1616.11	1652.13	1679.11	1744.35	1802.83	1962.55	2072.77	2365.75

The following options require modification of the product number.

Soft casters	To specify, change the 11th digit from a 1 (hard caster) to a 2 (soft caster); Example: SZT-20-702MA2
Aluminum Base	To specify, change the 11th digit from a 5 to a 1 (hard caster) or 2 (soft caster) and add \$32.14 list
Low position pneumatic	To specify, change the 11th digit from a 1 to a 3 (hard caster) or from a 2 to a 4 (soft caster); Examples: SZT-20-702MA3 is a low base with hard casters SZT-20-702MA4 is a low base with soft casters NOTE: Polished aluminum trim not available with this option.
Fixed seat	To specify, change the 10th digit from A to X; Example: SZT-20-702MX1
CAL 133	To specify, add F to the end of the product number; Example: SZT-20-712MA1F (add \$138.35 list)
Headrest	To specify, change the 3rd digit from a T to an E; Example: SZE-22-702MA1 with headrest (add \$58.48 list)
Stain repellent	To specify, add P to end of the product number (add \$34.87 list)

NOTE: CAL 133 is available on chairs with black frame and foam seat with or without the Lumbar option.
CAL 133 is not available on chairs with PAL back system.

For available fabrics, refer to surfaces.haworth.com.

Zody

Task Chair with 4D Arms

Upholstered Gel Insert Seat	Adjustments	Number	①	Fabric Grade								Leather Grade A	Leather Grade B
				A	B	C	D	E	F	G	H		
No Lumbar Adjustment - Mesh Back w/Plastic Base													
Pneumatic		SZT-20-702EA	■	\$1234.83	\$1268.57	\$1304.56	\$1322.57	\$1336.06	\$1368.68	\$1397.92	\$1477.78	\$1532.89	\$1679.38
Back Stop		SZT-20-701EA	■	1310.18	1343.92	1379.91	1397.92	1411.41	1444.03	1473.27	1553.13	1608.24	1754.73
Forward Tilt		SZT-20-703EA	■	1310.18	1343.92	1379.91	1397.92	1411.41	1444.03	1473.27	1553.13	1608.24	1754.73
Back Stop/ Forward Tilt		SZT-20-704EA	■	1333.81	1367.55	1403.54	1421.55	1435.04	1467.66	1496.90	1576.76	1631.87	1778.36
No Lumbar Adjustment - Upholstered Back Jacket w/Plastic Base													
Pneumatic		SZT-22-702EA	■	\$1346.18	\$1413.66	\$1485.64	\$1521.66	\$1548.64	\$1613.88	\$1672.36	\$1832.08	\$1942.30	\$2235.28
Back Stop		SZT-22-701EA	■	1421.53	1489.01	1560.99	1597.01	1623.99	1689.23	1747.71	1907.43	2017.65	2310.63
Forward Tilt		SZT-22-703EA	■	1421.53	1489.01	1560.99	1597.01	1623.99	1689.23	1747.71	1907.43	2017.65	2310.63
Back Stop/ Forward Tilt		SZT-22-704EA	■	1445.16	1512.64	1584.62	1620.64	1647.62	1712.86	1771.34	1931.06	2041.28	2334.26
Lumbar Adjustment - Mesh Back w/Plastic Base													
Pneumatic		SZT-20-712EA	■	\$1333.81	\$1367.55	\$1403.54	\$1421.55	\$1435.04	\$1467.66	\$1496.90	\$1576.76	\$1631.87	\$1778.36
Back Stop		SZT-20-711EA	■	1409.16	1442.90	1478.89	1496.90	1510.39	1543.01	1572.25	1652.11	1707.22	1853.71
Forward Tilt		SZT-20-713EA	■	1409.16	1442.90	1478.89	1496.90	1510.39	1543.01	1572.25	1652.11	1707.22	1853.71
Back Stop/ Forward Tilt		SZT-20-714EA	■	1432.79	1466.53	1502.52	1520.53	1534.02	1566.64	1595.88	1675.74	1730.85	1877.34
Lumbar Adjustment - Upholstered Back Jacket w/Plastic Base													
Pneumatic		SZT-22-712EA	■	\$1445.16	\$1512.64	\$1584.62	\$1620.64	\$1647.62	\$1712.86	\$1771.34	\$1931.06	\$2041.28	\$2334.26
Back Stop		SZT-22-711EA	■	1520.51	1587.99	1659.97	1695.99	1722.97	1788.21	1846.69	2006.41	2116.63	2409.61
Forward Tilt		SZT-22-713EA	■	1520.51	1587.99	1659.97	1695.99	1722.97	1788.21	1846.69	2006.41	2116.63	2409.61
Back Stop/ Forward Tilt		SZT-22-714EA	■	1544.14	1611.62	1683.60	1719.62	1746.60	1811.84	1870.32	2030.04	2140.26	2433.24
PAL Back System - Mesh Back w/Plastic Base													
Pneumatic		SZT-20-722EA	■	\$1359.68	\$1393.42	\$1429.41	\$1447.42	\$1460.91	\$1493.53	\$1522.77	\$1602.63	\$1657.74	\$1804.23
Back Stop		SZT-20-721EA	■	1435.03	1468.77	1504.76	1522.77	1536.26	1568.88	1598.12	1677.98	1733.09	1879.58
Forward Tilt		SZT-20-723EA	■	1435.03	1468.77	1504.76	1522.77	1536.26	1568.88	1598.12	1677.98	1733.09	1879.58
Back Stop/ Forward Tilt		SZT-20-724EA	■	1458.66	1492.40	1528.39	1546.40	1559.89	1592.51	1621.75	1701.61	1756.72	1903.21
PAL Back System - Upholstered Back Jacket w/Plastic Base													
Pneumatic		SZT-22-722EA	■	\$1471.03	\$1538.51	\$1610.49	\$1646.51	\$1673.49	\$1738.73	\$1797.21	\$1956.93	\$2067.15	\$2360.13
Back Stop		SZT-22-721EA	■	1546.38	1613.86	1685.84	1721.86	1748.84	1814.08	1872.56	2032.28	2142.50	2435.48
Forward Tilt		SZT-22-723EA	■	1546.38	1613.86	1685.84	1721.86	1748.84	1814.08	1872.56	2032.28	2142.50	2435.48
Back Stop/ Forward Tilt		SZT-22-724EA	■	1570.01	1637.49	1709.47	1745.49	1772.47	1837.71	1896.19	2055.91	2166.13	2459.11

The following options require modification of the product number.

- Soft casters To specify, change the 11th digit from a 1 (hard caster) to a 2 (soft caster); **Example:** SZT-20-702EA2
- Aluminum Base To specify, change the 11th digit from a 5 to a 1 (hard caster) or 2 (soft caster) and add **\$32.14** list
- Low position pneumatic To specify, change the 11th digit from a 1 to a 3 (hard caster) or from a 2 to a 4 (soft caster);
Examples: SZT-20-702EA3 is a low base with hard casters
SZT-20-702EA4 is a low base with soft casters
NOTE: Polished aluminum trim not available with this option.
- Fixed seat To specify, change the 10th digit from A to X; **Example:** SZT-20-702EX1
- Headrest To specify, change the 3rd digit from a T to an E; **Example:** SZE-22-702EA1 with headrest (add **\$58.48** list)
- Stain repellent To specify, add **P** to end of the product number (add **\$34.87** list)
NOTE: For available fabrics, refer to surfaces.haworth.com.

This page intentionally blank

Zody

Task Chair with Height Adjustable Arms



SZT-20-402MA1

Dimensions*

- *SH: 16-21"
(406mm-533mm)
- H: 38-43"(965mm-1092mm)
- D: 29"(737mm)
- W: 29"(737mm)
- *SW: 19 1/4"(489mm)
- *AH: 6.8-10.8"
(173mm-274mm)
- *SD: 16-19"(406mm-483mm)

Low position seat height:
14-17"(356mm-432mm)

* All measurements
taken with the
BIFMA chair
measuring device.

Trim Color	Arm Cap & Headrest Color*	
	Black	Smoke
Black (TR-F)	•	
Rusty Red (TR-RR)	•	
Sable (TR-1M)	•	
Smoke (TR-E)		•
Snow (TR-UFM)		•

*Not specifiable.

Features

- Back: Soft mesh only or mesh back with upholstered back jacket.
 - Seat: Standard upholstered with foam or optional foam with Technogel® Soft Lite gel insert.
 - Seat Type: Standard adjustable [3"(76mm) range] or optional fixed.
 - Base: Standard Plastic painted five-star base or optional painted aluminum or polished aluminum.
 - Plastic base available in Black, or painted Metallic Silver, Metallic Champagne and Metallic Gunmetal.
 - Aluminum base available with painted Black, Rusty Red, Snow, Metallic Silver, Metallic Champagne, Metallic Gunmetal, or optional Polished Aluminum.
 - Arms: Height-adjustable with soft arm caps. See matrix for default colors.
 - Mechanism: Balanced 3-point tilt; standard tilt tension.
 - Height adjustment: Pneumatic or low-position pneumatic.
 - Optional Back Stop: Tilt stop in 6 positions.
 - Optional Forward Tilt: 5 degrees downward from initial position.
 - Optional Back Stop with Forward Tilt
 - Optional Asymmetrical Lumbar Adjustment: 4"(102mm) height adjustment; support level can be adjusted independently for right or left hand side of users body. Optional PAL Back System: Passive pelvic support.
 - Casters: Standard with hard casters; optional soft casters.
 - COM yardage / COL square footage:
 - Mesh back model: 0.75/10
 - Mesh back/upholstered back jacket: 1.5/18
- Available on RUSH.

NOTE: When specifying fabric or leather back jacket; must also specify mesh surface color for outside back.

For different fabric grades on seat and upholstered back jacket, pricing will be determined by the sum of the upcharges of the selected jacket fabric grades (i.e. when choosing a Grade B fabric for the seat and a Grade D for the back, the final price will reflect the upcharge for a Grade B seat plus the upcharge for a Grade D back jacket.)

To Order with Mesh Back Specify:

- 1) Product number, including:

1 Base/Caster Option:**Aluminum Base**

- 1** Aluminum Base, Hard Caster, add **\$32.14** to list
- 2** Aluminum Base, Soft Caster, add **\$32.14** to list
- 3** Aluminum Low Base, Hard Caster, add **\$32.14** to list
- 4** Aluminum Low Base, Soft Caster, add **\$32.14** to list

Plastic Base

- 5** Plastic Std. Base, Hard Caster
- 6** Plastic Std. Base, Soft Caster

- 2) Fabric surface and color (seat).
- 3) Mesh surface and color (back).
- 4) Trim color for frame. (Add **\$55.00** list for Snow.)
- 5) Trim color for base/arms. (Add **\$187.83** list for polished aluminum.)

To Order with Fabric or Leather Upholstered Back Jacket Specify:

- 1) Product number, including:

1 Base/Caster Option:**Aluminum Base**

- 1** Aluminum Base, Hard Caster, add **\$32.14** to list
- 2** Aluminum Base, Soft Caster, add **\$32.14** to list
- 3** Aluminum Low Base, Hard Caster, add **\$32.14** to list
- 4** Aluminum Low Base, Soft Caster, add **\$32.14** to list

Plastic Base

- 5** Plastic Std. Base, Hard Caster
- 6** Plastic Std. Base, Soft Caster

- 2) Fabric surface and color (seat).
- 3) Mesh surface color (back).
- 4) Fabric surface and color (back jacket).
- 5) Trim color for frame. (Add **\$55.00** list for Snow.)
- 6) Trim color for base/arms. (Add **\$187.83** list for polished aluminum.)

Leather Seat with Mesh Back:

Change fourth digit in product number to **1**; fifth digit to **0**.

Example: SZT-10-402MA5

Leather Seat with Leather Upholstered Back Jacket:

Change fourth digit in product number to **1**; fifth digit to **1**.

Example: SZT-11-402MA5

Faux Leather Seat with Mesh Back:

Change the fourth digit in product number to **3**.

Example: SZT-30-402MA5

Faux Leather Seat with Faux Leather Upholstered Back Jacket:

Change the fourth and fifth digits in product number to **33**.

Example: SZT-33-402MA5

Zody

Task Chair with Height Adjustable Arms

Upholstered Foam Seat	Adjustments	Number	①	Fabric Grade								Leather Grade A	Leather Grade B
				A	B	C	D	E	F	G	H		
No Lumbar Adjustment - Mesh w/Plastic Base													
	Pneumatic	SZT-20-402MA	■	\$1104.35	\$1138.09	\$1174.08	\$1192.09	\$1205.58	\$1238.20	\$1267.44	\$1347.30	\$1402.41	\$1548.90
	Back Stop	SZT-20-401MA	■	1179.70	1213.44	1249.43	1267.44	1280.93	1313.55	1342.79	1422.65	1477.76	1624.25
	Forward Tilt	SZT-20-403MA	■	1179.70	1213.44	1249.43	1267.44	1280.93	1313.55	1342.79	1422.65	1477.76	1624.25
	Back Stop/ Forward Tilt	SZT-20-404MA	■	1203.33	1237.07	1273.06	1291.07	1304.56	1337.18	1366.42	1446.28	1501.39	1647.88
No Lumbar Adjustment - Upholstered Back Jacket w/Plastic Base													
	Pneumatic	SZT-22-402MA	■	\$1215.70	\$1283.18	\$1355.16	\$1391.18	\$1418.16	\$1483.40	\$1541.88	\$1701.60	\$1811.82	\$2104.80
	Back Stop	SZT-22-401MA	■	1291.05	1358.53	1430.51	1466.53	1493.51	1558.75	1617.23	1776.95	1887.17	2180.15
	Forward Tilt	SZT-22-403MA	■	1291.05	1358.53	1430.51	1466.53	1493.51	1558.75	1617.23	1776.95	1887.17	2180.15
	Back Stop/ Forward Tilt	SZT-22-404MA	■	1314.68	1382.16	1454.14	1490.16	1517.14	1582.38	1640.86	1800.58	1910.80	2203.78
Lumbar Adjustment - Mesh w/Plastic Base													
	Pneumatic	SZT-20-412MA	■	\$1203.33	\$1237.07	\$1273.06	\$1291.07	\$1304.56	\$1337.18	\$1366.42	\$1446.28	\$1501.39	\$1647.88
	Back Stop	SZT-20-411MA	■	1278.68	1312.42	1348.41	1366.42	1379.91	1412.53	1441.77	1521.63	1576.74	1723.23
	Forward Tilt	SZT-20-413MA	■	1278.68	1312.42	1348.41	1366.42	1379.91	1412.53	1441.77	1521.63	1576.74	1723.23
	Back Stop/ Forward Tilt	SZT-20-414MA	■	1302.31	1336.05	1372.04	1390.05	1403.54	1436.16	1465.40	1545.26	1600.37	1746.86
Lumbar Adjustment - Upholstered Back Jacket w/Plastic Base													
	Pneumatic	SZT-22-412MA	■	\$1314.68	\$1382.16	\$1454.14	\$1490.16	\$1517.14	\$1582.38	\$1640.86	\$1800.58	\$1910.80	\$2203.78
	Back Stop	SZT-22-411MA	■	1390.03	1457.51	1529.49	1565.51	1592.49	1657.73	1716.21	1875.93	1986.15	2279.13
	Forward Tilt	SZT-22-413MA	■	1390.03	1457.51	1529.49	1565.51	1592.49	1657.73	1716.21	1875.93	1986.15	2279.13
	Back Stop/ Forward Tilt	SZT-22-414MA	■	1413.66	1481.14	1553.12	1589.14	1616.12	1681.36	1739.84	1899.56	2009.78	2302.76
PAL Back System - Mesh w/Plastic Base													
	Pneumatic	SZT-20-422MA	■	\$1229.20	\$1262.94	\$1298.93	\$1316.94	\$1330.43	\$1363.05	\$1392.29	\$1472.15	\$1527.26	\$1673.75
	Back Stop	SZT-20-421MA	■	1304.55	1338.29	1374.28	1392.29	1405.78	1438.40	1467.64	1547.50	1602.61	1749.10
	Forward Tilt	SZT-20-423MA	■	1304.55	1338.29	1374.28	1392.29	1405.78	1438.40	1467.64	1547.50	1602.61	1749.10
	Back Stop/ Forward Tilt	SZT-20-424MA	■	1328.18	1361.92	1397.91	1415.92	1429.41	1462.03	1491.27	1571.13	1626.24	1772.73
PAL Back System - Upholstered Back Jacket w/Plastic Base													
	Pneumatic	SZT-22-422MA	■	\$1340.55	\$1408.03	\$1480.01	\$1516.03	\$1543.01	\$1608.25	\$1666.73	\$1826.45	\$1936.67	\$2229.65
	Back Stop	SZT-22-421MA	■	1415.90	1483.38	1555.36	1591.38	1618.36	1683.60	1742.08	1901.80	2012.02	2305.00
	Forward Tilt	SZT-22-423MA	■	1415.90	1483.38	1555.36	1591.38	1618.36	1683.60	1742.08	1901.80	2012.02	2305.00
	Back Stop/ Forward Tilt	SZT-22-424MA	■	1439.53	1507.01	1578.99	1615.01	1641.99	1707.23	1765.71	1925.43	2035.65	2328.63

The following options require modification of the product number.

Soft casters	To specify, change the 11th digit from a 1 (hard caster) to a 2 (soft caster); Example: SZT-20-402MA2
Aluminum Base	To specify, change the 11th digit from a 5 to a 1 (hard caster) or 2 (soft caster) and add \$32.14 list
Low position pneumatic	To specify, change the 11th digit from a 1 to a 3 (hard caster) or from a 2 to a 4 (soft caster); Examples: SZT-20-402MA3 is a low base with hard casters SZT-20-402MA4 is a low base with soft casters NOTE: Polished aluminum trim not available with this option.
Fixed seat	To specify, change the 10th digit from A to X; Example: SZT-20-402MX1
CAL 133	To specify, add F to the end of the product number; Example: SZT-20-401MA1F (add \$138.35 list)
Headrest	To specify, change the 3rd digit from a T to an E; Example: SZE-22-402MA1 with headrest (add \$58.48 list)
Stain repellent	To specify, add P to end of the product number (add \$34.87 list)

NOTE: CAL 133 is available on chairs with black frame and foam seat with or without the Lumbar option.
CAL 133 is not available on chairs with PAL back system.

For available fabrics, refer to surfaces.haworth.com.

Upholstered Gel Insert Seat	Adjustments	Number	①	Fabric Grade								Leather Grade A	Leather Grade B
				A	B	C	D	E	F	G	H		
No Lumbar Adjustment - Mesh w/Plastic Base													
	Pneumatic	SZT-20-402EA	■	\$1197.71	\$1231.45	\$1267.44	\$1285.45	\$1298.94	\$1331.56	\$1360.80	\$1440.66	\$1495.77	\$1642.26
	Back Stop	SZT-20-401EA	■	1273.06	1306.80	1342.79	1360.80	1374.29	1406.91	1436.15	1516.01	1571.12	1717.61
	Forward Tilt	SZT-20-403EA	■	1273.06	1306.80	1342.79	1360.80	1374.29	1406.91	1436.15	1516.01	1571.12	1717.61
	Back Stop/ Forward Tilt	SZT-20-404EA	■	1296.69	1330.43	1366.42	1384.43	1397.92	1430.54	1459.78	1539.64	1594.75	1741.24
No Lumbar Adjustment - Upholstered Back Jacket w/Plastic Base													
	Pneumatic	SZT-22-402EA	■	\$1309.06	\$1376.54	\$1448.52	\$1484.54	\$1511.52	\$1576.76	\$1635.24	\$1794.96	\$1905.18	\$2198.16
	Back Stop	SZT-22-401EA	■	1384.41	1451.89	1523.87	1559.89	1586.87	1652.11	1710.59	1870.31	1980.53	2273.51
	Forward Tilt	SZT-22-403EA	■	1384.41	1451.89	1523.87	1559.89	1586.87	1652.11	1710.59	1870.31	1980.53	2273.51
	Back Stop/ Forward Tilt	SZT-22-404EA	■	1408.04	1475.52	1547.50	1583.52	1610.50	1675.74	1734.22	1893.94	2004.16	2297.14
Lumbar Adjustment - Mesh w/Plastic Base													
	Pneumatic	SZT-20-412EA	■	\$1296.69	\$1330.43	\$1366.42	\$1384.43	\$1397.92	\$1430.54	\$1459.78	\$1539.64	\$1594.75	\$1741.24
	Back Stop	SZT-20-411EA	■	1372.04	1405.78	1441.77	1459.78	1473.27	1505.89	1535.13	1614.99	1670.10	1816.59
	Forward Tilt	SZT-20-413EA	■	1372.04	1405.78	1441.77	1459.78	1473.27	1505.89	1535.13	1614.99	1670.10	1816.59
	Back Stop/ Forward Tilt	SZT-20-414EA	■	1395.67	1429.41	1465.40	1483.41	1496.90	1529.52	1558.76	1638.62	1693.73	1840.22
Lumbar Adjustment - Upholstered Back Jacket w/Plastic Base													
	Pneumatic	SZT-22-412EA	■	\$1408.04	\$1475.52	\$1547.50	\$1583.52	\$1610.50	\$1675.74	\$1734.22	\$1893.94	\$2004.16	\$2297.14
	Back Stop	SZT-22-411EA	■	1483.39	1550.87	1622.85	1658.87	1685.85	1751.09	1809.57	1969.29	2079.51	2372.49
	Forward Tilt	SZT-22-413EA	■	1483.39	1550.87	1622.85	1658.87	1685.85	1751.09	1809.57	1969.29	2079.51	2372.49
	Back Stop/ Forward Tilt	SZT-22-414EA	■	1507.02	1574.50	1646.48	1682.50	1709.48	1774.72	1833.20	1992.92	2103.14	2396.12
PAL Back System - Mesh w/Plastic Base													
	Pneumatic	SZT-20-422EA	■	\$1322.56	\$1356.30	\$1392.29	\$1410.30	\$1423.79	\$1456.41	\$1485.65	\$1565.51	\$1620.62	\$1767.11
	Back Stop	SZT-20-421EA	■	1397.91	1431.65	1467.64	1485.65	1499.14	1531.76	1561.00	1640.86	1695.97	1842.46
	Forward Tilt	SZT-20-423EA	■	1397.91	1431.65	1467.64	1485.65	1499.14	1531.76	1561.00	1640.86	1695.97	1842.46
	Back Stop/ Forward Tilt	SZT-20-424EA	■	1421.54	1455.28	1491.27	1509.28	1522.77	1555.39	1584.63	1664.49	1719.60	1866.09
PAL Back System - Upholstered Back Jacket w/Plastic Base													
	Pneumatic	SZT-22-422EA	■	\$1433.91	\$1501.39	\$1573.37	\$1609.39	\$1636.37	\$1701.61	\$1760.09	\$1919.81	\$2030.03	\$2323.01
	Back Stop	SZT-22-421EA	■	1509.26	1576.74	1648.72	1684.74	1711.72	1776.96	1835.44	1995.16	2105.38	2398.36
	Forward Tilt	SZT-22-423EA	■	1509.26	1576.74	1648.72	1684.74	1711.72	1776.96	1835.44	1995.16	2105.38	2398.36
	Back Stop/ Forward Tilt	SZT-22-424EA	■	1532.89	1600.37	1672.35	1708.37	1735.35	1800.59	1859.07	2018.79	2129.01	2421.99

The following options require modification of the product number.

- Soft casters To specify, change the 11th digit from a 1 (hard caster) to a 2 (soft caster); **Example:** SZT-20-402EA2
- Aluminum Base To specify, change the 11th digit from a 5 to a 1 (hard caster) or 2 (soft caster) and add **\$32.14** list
- Low position pneumatic To specify, change the 11th digit from a 1 to a 3 (hard caster) or from a 2 to a 4 (soft caster);
Examples: SZT-20-402EA3 is a low base with hard casters
SZT-20-402EA4 is a low base with soft casters
NOTE: Polished aluminum trim not available with this option.
- Fixed seat To specify, change the 10th digit from A to X; **Example:** SZT-20-402EX1
- Headrest To specify, change the 3rd digit from a T to an E; **Example:** SZE-22-402EA1 with headrest (add **\$58.48** list)
- Stain repellent To specify, add **P** to end of the product number (add **\$34.87** list)

NOTE: For available fabrics, refer to surfaces.haworth.com.

This page intentionally blank

Zody

Task Chair with Fixed Arms



SZT-20-102MA1

Dimensions*

*SH: 16-21"
(406mm-533mm)
H: 38-43"(965mm-1092mm)
D: 29"(737mm)
W: 29"(737mm)
*SW: 19 1/4"(489mm)
*AH: 9"(229mm)
*SD: 16-19"(406mm-483mm)
Low position seat height:
14-17"(356mm-432mm)

* All measurements taken with the BIFMA chair measuring device.

Trim Color	Arm Cap & Headrest Color*	
	Black	Smoke
Black (TR-F)	•	
Rusty Red (TR-RR)	•	
Sable (TR-1M)	•	
Smoke (TR-E)		•
Snow (TR-UFM)		•

*Not specifiable.

Features

- Back: Soft mesh only or mesh back with upholstered back jacket.
 - Seat: Standard upholstered with foam or optional foam with Technogel® Soft Lite gel insert.
 - Seat Type: Standard adjustable [3"(76mm) range] or optional fixed.
 - Base: Standard Plastic painted five-star base or optional painted aluminum or polished aluminum. –Plastic base available in Black, or painted Metallic Silver, Metallic Champagne and Metallic Gunmetal. –Aluminum base available with painted Black, Rusty Red, Snow, Metallic Silver, Metallic Champagne, Metallic Gunmetal, or optional Polished Aluminum.
 - Arms: Fixed with soft arm caps. See matrix for default colors.
 - Mechanism: Balanced 3-point tilt; standard tilt tension.
 - Height adjustment: Pneumatic or low-position pneumatic.
 - Optional Back Stop: Tilt stop in 6 positions.
 - Optional Forward Tilt: 5 degrees downward from initial position.
 - Optional Back Stop with Forward Tilt
 - Optional Asymmetrical Lumbar Adjustment: 4"(102mm) height adjustment; support level can be adjusted independently for right or left hand side of users body. Optional PAL Back System: Passive pelvic support.
 - Casters: Standard with hard casters; optional soft casters.
 - COM yardage / COL square footage:
Mesh back model: 0.75/10
Mesh back/upholstered back jacket: 1.5/18
- Available on RUSH.

NOTE: When specifying fabric or leather back jacket; must also specify mesh surface color for outside back.

For different fabric grades on seat and upholstered back jacket, pricing will be determined by the sum of the upcharges of the selected jacket fabric grades (i.e. when choosing a Grade B fabric for the seat and a Grade D for the back, the final price will reflect the upcharge for a Grade B seat plus the upcharge for a Grade D back jacket.)

To Order with Mesh Back Specify:

- 1) Product number, including:

1 Base/Caster Option:**Aluminum Base**

- 1 Aluminum Base, Hard Caster, add **\$32.14** to list
- 2 Aluminum Base, Soft Caster, add **\$32.14** to list
- 3 Aluminum Low Base, Hard Caster, add **\$32.14** to list
- 4 Aluminum Low Base, Soft Caster, add **\$32.14** to list

Plastic Base

- 5 Plastic Std. Base, Hard Caster
- 6 Plastic Std. Base, Soft Caster

- 2) Fabric surface and color (seat).
- 3) Mesh surface and color (back).
- 4) Trim color for frame. (Add **\$55.00** list for Snow.)
- 5) Trim color for base/arms. (Add **\$187.83** list for polished aluminum.)

To Order with Fabric or Leather Upholstered Back Jacket Specify:

- 1) Product number, including:

1 Base/Caster Option:**Aluminum Base**

- 1 Aluminum Base, Hard Caster, add **\$32.14** to list
- 2 Aluminum Base, Soft Caster, add **\$32.14** to list
- 3 Aluminum Low Base, Hard Caster, add **\$32.14** to list
- 4 Aluminum Low Base, Soft Caster, add **\$32.14** to list

Plastic Base

- 5 Plastic Std. Base, Hard Caster
- 6 Plastic Std. Base, Soft Caster

- 2) Fabric surface and color (seat).
- 3) Mesh surface color (back).
- 4) Fabric surface and color (back jacket).
- 5) Trim color for frame. (Add **\$55.00** list for Snow.)
- 6) Trim color for base/arms. (Add **\$187.83** list for polished aluminum.)

Leather Seat with Mesh Back:

Change fourth digit in product number to 1; fifth digit to 0.

Example: SZT-10-102MA5

Leather Seat with Leather Upholstered Back Jacket:

Change fourth digit in product number to 1; fifth digit to 1.

Example: SZT-11-102MA5

Faux Leather Seat with Mesh Back:

Change the fourth digit in product number to 3.

Example: SZT-30-102MA5

Faux Leather Seat with Faux Leather Upholstered Back Jacket:

Change the fourth and fifth digits in product number to 33.

Example: SZT-33-102MA5

Zody

Task Chair with Fixed Arms

Upholstered Foam Seat	Adjustments	Number	①	Fabric Grade								Leather Grade A	Leather Grade B
				A	B	C	D	E	F	G	H		
No Lumbar Adjustment - Mesh Back w/Plastic Base													
Pneumatic		SZT-20-102MA	■	\$1027.87	\$1061.61	\$1097.60	\$1115.61	\$1129.10	\$1161.72	\$1190.96	\$1270.82	\$1325.93	\$1472.42
Back Stop		SZT-20-101MA	■	1103.22	1136.96	1172.95	1190.96	1204.45	1237.07	1266.31	1346.17	1401.28	1547.77
Forward Tilt		SZT-20-103MA	■	1103.22	1136.96	1172.95	1190.96	1204.45	1237.07	1266.31	1346.17	1401.28	1547.77
Back Stop/ Forward Tilt		SZT-20-104MA	■	1126.85	1160.59	1196.58	1214.59	1228.08	1260.70	1289.94	1369.80	1424.91	1571.40
No Lumbar Adjustment - Upholstered Back Jacket w/Plastic Base													
Pneumatic		SZT-22-102MA	■	\$1139.22	\$1206.70	\$1278.68	\$1314.70	\$1341.68	\$1406.92	\$1465.40	\$1625.12	\$1735.34	\$2028.32
Back Stop		SZT-22-101MA	■	1214.57	1282.05	1354.03	1390.05	1417.03	1482.27	1540.75	1700.47	1810.69	2103.67
Forward Tilt		SZT-22-103MA	■	1214.57	1282.05	1354.03	1390.05	1417.03	1482.27	1540.75	1700.47	1810.69	2103.67
Back Stop/ Forward Tilt		SZT-22-104MA	■	1238.20	1305.68	1377.66	1413.68	1440.66	1505.90	1564.38	1724.10	1834.32	2127.30
Lumbar Adjustment - Mesh Back w/Plastic Base													
Pneumatic		SZT-20-112MA	■	\$1126.85	\$1160.59	\$1196.58	\$1214.59	\$1228.08	\$1260.70	\$1289.94	\$1369.80	\$1424.91	\$1571.40
Back Stop		SZT-20-111MA	■	1202.20	1235.94	1271.93	1289.94	1303.43	1336.05	1365.29	1445.15	1500.26	1646.75
Forward Tilt		SZT-20-113MA	■	1202.20	1235.94	1271.93	1289.94	1303.43	1336.05	1365.29	1445.15	1500.26	1646.75
Back Stop/ Forward Tilt		SZT-20-114MA	■	1225.83	1259.57	1295.56	1313.57	1327.06	1359.68	1388.92	1468.78	1523.89	1670.38
Lumbar Adjustment - Upholstered Back Jacket w/Plastic Base													
Pneumatic		SZT-22-112MA	■	\$1238.20	\$1305.68	\$1377.66	\$1413.68	\$1440.66	\$1505.90	\$1564.38	\$1724.10	\$1834.32	\$2127.30
Back Stop		SZT-22-111MA	■	1313.55	1381.03	1453.01	1489.03	1516.01	1581.25	1639.73	1799.45	1909.67	2202.65
Forward Tilt		SZT-22-113MA	■	1313.55	1381.03	1453.01	1489.03	1516.01	1581.25	1639.73	1799.45	1909.67	2202.65
Back Stop/ Forward Tilt		SZT-22-114MA	■	1337.18	1404.66	1476.64	1512.66	1539.64	1604.88	1663.36	1823.08	1933.30	2226.28
PAL Back System - Mesh Back w/Plastic Base													
Pneumatic		SZT-20-122MA	■	\$1152.72	\$1186.46	\$1222.45	\$1240.46	\$1253.95	\$1286.57	\$1315.81	\$1395.67	\$1450.78	\$1597.27
Back Stop		SZT-20-121MA	■	1228.07	1261.81	1297.80	1315.81	1329.30	1361.92	1391.16	1471.02	1526.13	1672.62
Forward Tilt		SZT-20-123MA	■	1228.07	1261.81	1297.80	1315.81	1329.30	1361.92	1391.16	1471.02	1526.13	1672.62
Back Stop/ Forward Tilt		SZT-20-124MA	■	1251.70	1285.44	1321.43	1339.44	1352.93	1385.55	1414.79	1494.65	1549.76	1696.25
PAL Back System - Upholstered Back Jacket w/Plastic Base													
Pneumatic		SZT-22-122MA	■	\$1264.07	\$1331.55	\$1403.53	\$1439.55	\$1466.53	\$1531.77	\$1590.25	\$1749.97	\$1860.19	\$2153.17
Back Stop		SZT-22-121MA	■	1339.42	1406.90	1478.88	1514.90	1541.88	1607.12	1665.60	1825.32	1935.54	2228.52
Forward Tilt		SZT-22-123MA	■	1339.42	1406.90	1478.88	1514.90	1541.88	1607.12	1665.60	1825.32	1935.54	2228.52
Back Stop/ Forward Tilt		SZT-22-124MA	■	1363.05	1430.53	1502.51	1538.53	1565.51	1630.75	1689.23	1848.95	1959.17	2252.15

The following options require modification of the product number.

Soft casters	To specify, change the 11th digit from a 1 (hard caster) to a 2 (soft caster); Example: SZT-20-102MA2
Aluminum Base	To specify, change the 11th digit from a 5 to a 1 (hard caster) or 2 (soft caster) and add \$32.14 list
Low position pneumatic	To specify, change the 11th digit from a 1 to a 3 (hard caster) or from a 2 to a 4 (soft caster); Examples: SZT-20-102MA3 is a low base with hard casters SZT-20-102MA4 is a low base with soft casters NOTE: Polished aluminum trim not available with this option.
Fixed seat	To specify, change the 10th digit from A to X; Example: SZT-20-102MX1
CAL 133	To specify, add F to the end of the product number; Example: SZT-22-101MA1F (add \$138.35 list)
Headrest	To specify, change the 3rd digit from a T to an E; Example: SZE-22-102MA1 with headrest (add \$58.48 list)
Stain repellent	To specify, add P to end of the product number (add \$34.87 list)

NOTE: CAL 133 is available on chairs with black frame and foam seat with or without the Lumbar option.

CAL 133 is not available on chairs with PAL back system.

For available fabrics, refer to surfaces.haworth.com.

Zody

Task Chair with Fixed Arms

Upholstered Gel Insert Seat	Adjustments	Number	①	Fabric Grade								Leather Grade A	Leather Grade B
				A	B	C	D	E	F	G	H		
No Lumbar Adjustment - Mesh Back w/Plastic Base													
	Pneumatic	SZT-20-102EA	■	\$1121.23	\$1154.97	\$1190.96	\$1208.97	\$1222.46	\$1255.08	\$1284.32	\$1364.18	\$1419.29	\$1565.78
	Back Stop	SZT-20-101EA	■	1196.58	1230.32	1266.31	1284.32	1297.81	1330.43	1359.67	1439.53	1494.64	1641.13
	Forward Tilt	SZT-20-103EA	■	1196.58	1230.32	1266.31	1284.32	1297.81	1330.43	1359.67	1439.53	1494.64	1641.13
	Back Stop/ Forward Tilt	SZT-20-104EA	■	1220.21	1253.95	1289.94	1307.95	1321.44	1354.06	1383.30	1463.16	1518.27	1664.76
No Lumbar Adjustment - Upholstered Back Jacket w/Plastic Base													
	Pneumatic	SZT-22-102EA	■	\$1232.58	\$1300.06	\$1372.04	\$1408.06	\$1435.04	\$1500.28	\$1558.76	\$1718.48	\$1828.70	\$2121.68
	Back Stop	SZT-22-101EA	■	1307.93	1375.41	1447.39	1483.41	1510.39	1575.63	1634.11	1793.83	1904.05	2197.03
	Forward Tilt	SZT-22-103EA	■	1307.93	1375.41	1447.39	1483.41	1510.39	1575.63	1634.11	1793.83	1904.05	2197.03
	Back Stop/ Forward Tilt	SZT-22-104EA	■	1331.56	1399.04	1471.02	1507.04	1534.02	1599.26	1657.74	1817.46	1927.68	2220.66
Lumbar Adjustment - Mesh Back w/Plastic Base													
	Pneumatic	SZT-20-112EA	■	\$1220.21	\$1253.95	\$1289.94	\$1307.95	\$1321.44	\$1354.06	\$1383.30	\$1463.16	\$1518.27	\$1664.76
	Back Stop	SZT-20-111EA	■	1295.56	1329.30	1365.29	1383.30	1396.79	1429.41	1458.65	1538.51	1593.62	1740.11
	Forward Tilt	SZT-20-113EA	■	1295.56	1329.30	1365.29	1383.30	1396.79	1429.41	1458.65	1538.51	1593.62	1740.11
	Back Stop/ Forward Tilt	SZT-20-114EA	■	1319.19	1352.93	1388.92	1406.93	1420.42	1453.04	1482.28	1562.14	1617.25	1763.74
Lumbar Adjustment - Upholstered Back Jacket w/Plastic Base													
	Pneumatic	SZT-22-112EA	■	\$1331.56	\$1399.04	\$1471.02	\$1507.04	\$1534.02	\$1599.26	\$1657.74	\$1817.46	\$1927.68	\$2220.66
	Back Stop	SZT-22-111EA	■	1406.91	1474.39	1546.37	1582.39	1609.37	1674.61	1733.09	1892.81	2003.03	2296.01
	Forward Tilt	SZT-22-113EA	■	1406.91	1474.39	1546.37	1582.39	1609.37	1674.61	1733.09	1892.81	2003.03	2296.01
	Back Stop/ Forward Tilt	SZT-22-114EA	■	1430.54	1498.02	1570.00	1606.02	1633.00	1698.24	1756.72	1916.44	2026.66	2319.64
PAL Back System - Mesh Back w/Plastic Base													
	Pneumatic	SZT-20-122EA	■	\$1246.08	\$1279.82	\$1315.81	\$1333.82	\$1347.31	\$1379.93	\$1409.17	\$1489.03	\$1544.14	\$1690.63
	Back Stop	SZT-20-121EA	■	1321.43	1355.17	1391.16	1409.17	1422.66	1455.28	1484.52	1564.38	1619.49	1765.98
	Forward Tilt	SZT-20-123EA	■	1321.43	1355.17	1391.16	1409.17	1422.66	1455.28	1484.52	1564.38	1619.49	1765.98
	Back Stop/ Forward Tilt	SZT-20-124EA	■	1345.06	1378.80	1414.79	1432.80	1446.29	1478.91	1508.15	1588.01	1643.12	1789.61
PAL Back System - Upholstered Back Jacket w/Plastic Base													
	Pneumatic	SZT-22-122EA	■	\$1357.43	\$1424.91	\$1496.89	\$1532.91	\$1559.89	\$1625.13	\$1683.61	\$1843.33	\$1953.55	\$2246.53
	Back Stop	SZT-22-121EA	■	1432.78	1500.26	1572.24	1608.26	1635.24	1700.48	1758.96	1918.68	2028.90	2321.88
	Forward Tilt	SZT-22-123EA	■	1432.78	1500.26	1572.24	1608.26	1635.24	1700.48	1758.96	1918.68	2028.90	2321.88
	Back Stop/ Forward Tilt	SZT-22-124EA	■	1456.41	1523.89	1595.87	1631.89	1658.87	1724.11	1782.59	1942.31	2052.53	2345.51

The following options require modification of the product number.

- Soft casters To specify, change the 11th digit from a 1 (hard caster) to a 2 (soft caster); **Example:** SZT-20-102EA2
 - Aluminum Base To specify, change the 11th digit from a 5 to a 1 (hard caster) or 2 (soft caster) and add **\$32.14** list
 - Low position pneumatic To specify, change the 11th digit from a 1 to a 3 (hard caster) or from a 2 to a 4 (soft caster);
Examples: SZT-20-102EA3 is a low base with hard casters
SZT-20-102EA4 is a low base with soft casters
NOTE: Polished aluminum trim not available with this option.
 - Fixed seat To specify, change the 10th digit from A to X; **Example:** SZT-20-102EX1
 - Headrest To specify, change the 3rd digit from a T to an E; **Example:** SZE-22-102EA1 with headrest (add **\$58.48** list)
 - Stain repellent To specify, add **P** to end of the product number (add **\$34.87** list)
- For available fabrics, refer to surfaces.haworth.com.

This page intentionally blank

Zody

Task Chair without Arms



SZT-20-002MA1

Dimensions*

*SH: 16-21"
(406mm-533mm)
H: 38-43"(965mm-1092mm)
D: 29"(737mm)
W: 29"(737mm)
*SW: 19 1/4"(489mm)
*SD: 16-19"(406mm-483mm)

Low position seat height:
14-17"(356mm-432mm)

* All measurements
taken with the
BIFMA chair
measuring device.

Trim Color	Headrest Color*	
	Black	Smoke
Black (TR-F)	•	
Rusty Red (TR-RR)	•	
Sable (TR-1M)	•	
Smoke (TR-E)		•
Snow (TR-UFM)		•

*Not specifiable.

Features

- Back: Soft mesh only or mesh back with upholstered back jacket.
- Seat: Standard upholstered with foam or optional foam with Technogel® Soft Lite gel insert.
- Seat Type: Standard adjustable [3"(76mm) range] or optional fixed.
- Base: Standard Plastic painted five-star base or optional painted aluminum or polished aluminum.
 - Plastic base available in Black, or painted Metallic Silver, Metallic Champagne and Metallic Gunmetal.
 - Aluminum base available with painted Black, Rusty Red, Snow, Metallic Silver, Metallic Champagne, Metallic Gunmetal, or optional Polished Aluminum.
- Mechanism: Balanced 3-point tilt; standard tilt tension.
- Height adjustment: Pneumatic or low-position pneumatic.
- Optional Back Stop: Tilt stop in 6 positions.
- Optional Forward Tilt: 5 degrees downward from initial position.
- Optional Back Stop with Forward Tilt
- Optional Asymmetrical Lumbar Adjustment: 4"(102mm) height adjustment; support level can be adjusted independently for right or left hand side of users body. Optional PAL Back System: Passive pelvic support
- Casters: Standard with hard casters; optional soft casters.
- COM yardage / COL square footage:
 - Mesh back model: 0.75/10
 - Mesh back/upholstered back jacket: 1.5/18

■ Available on RUSH.

NOTE: When specifying fabric or leather back jacket; must also specify mesh surface color for outside back.

For different fabric grades on seat and upholstered back jacket, pricing will be determined by the sum of the upcharges of the selected jacket fabric grades (i.e. when choosing a Grade B fabric for the seat and a Grade D for the back, the final price will reflect the upcharge for a Grade B seat plus the upcharge for a Grade D back jacket.)

To Order with Mesh Back Specify:

1) Product number, including:

1 Base/Caster Option:**Aluminum Base**

- 1 Aluminum Base, Hard Caster, add **\$32.14** to list
- 2 Aluminum Base, Soft Caster, add **\$32.14** to list
- 3 Aluminum Low Base, Hard Caster, add **\$32.14** to list
- 4 Aluminum Low Base, Soft Caster, add **\$32.14** to list

Plastic Base

- 5 Plastic Std. Base, Hard Caster
- 6 Plastic Std. Base, Soft Caster

- 2) Fabric surface and color (seat).
- 3) Mesh surface and color (back).
- 4) Trim color for frame. (Add **\$55.00** list for Snow.)
- 5) Trim color for base. (Add **\$187.83** list for polished aluminum.)

To Order with Fabric or Leather Upholstered Back Jacket Specify:

1) Product number, including:

1 Base/Caster Option:**Aluminum Base**

- 1 Aluminum Base, Hard Caster, add **\$32.14** to list
- 2 Aluminum Base, Soft Caster, add **\$32.14** to list
- 3 Aluminum Low Base, Hard Caster, add **\$32.14** to list
- 4 Aluminum Low Base, Soft Caster, add **\$32.14** to list

Plastic Base

- 5 Plastic Std. Base, Hard Caster
- 6 Plastic Std. Base, Soft Caster

- 2) Fabric surface and color (seat).
- 3) Mesh surface color (back).
- 4) Fabric surface and color (back jacket).
- 5) Trim color for frame. (Add **\$55.00** list for Snow.)
- 6) Trim color for base. (Add **\$187.83** list for polished aluminum.)

Leather Seat with Mesh Back:

Change fourth digit in product number to 1; fifth digit to 0.

Example: SZT-10-002MA5

Leather Seat with Leather Upholstery Back Jacket:

Change fourth digit in product number to 1; fifth digit to 1.

Example: SZT-11-002MA5

Faux Leather Seat with Mesh Back:

Change the fourth digit in product number to 3.

Example: SZT-10-002MA5

Faux Leather Seat with Faux Leather Upholstery Back Jacket:

Change the fourth and fifth digits in product number to 33.

Example: SZT-33-002MA5

Zody

Task Chair without Arms

Upholstered Foam Seat	Adjustments	Number	①	Fabric Grade								Leather Grade A	Leather Grade B
				A	B	C	D	E	F	G	H		
No Lumbar Adjustment - Mesh Back w/Plastic Base													
Pneumatic		SZT-20-002MA	■	\$ 903.02	\$ 936.76	\$ 972.75	\$ 990.76	\$1004.25	\$1036.87	\$1066.11	\$1145.97	\$1201.08	\$1347.57
Back Stop		SZT-20-001MA	■	978.37	1012.11	1048.10	1066.11	1079.60	1112.22	1141.46	1221.32	1276.43	1422.92
Forward Tilt		SZT-20-003MA	■	978.37	1012.11	1048.10	1066.11	1079.60	1112.22	1141.46	1221.32	1276.43	1422.92
Back Stop/ Forward Tilt		SZT-20-004MA	■	1002.00	1035.74	1071.73	1089.74	1103.23	1135.85	1165.09	1244.95	1300.06	1446.55
No Lumbar Adjustment - Upholstered Back Jacket w/Plastic Base													
Pneumatic		SZT-22-002MA	■	\$1014.37	\$1081.85	\$1153.83	\$1189.85	\$1216.83	\$1282.07	\$1340.55	\$1500.27	\$1610.49	\$1903.47
Back Stop		SZT-22-001MA	■	1089.72	1157.20	1229.18	1265.20	1292.18	1357.42	1415.90	1575.62	1685.84	1978.82
Forward Tilt		SZT-22-003MA	■	1089.72	1157.20	1229.18	1265.20	1292.18	1357.42	1415.90	1575.62	1685.84	1978.82
Back Stop/ Forward Tilt		SZT-22-004MA	■	1113.35	1180.83	1252.81	1288.83	1315.81	1381.05	1439.53	1599.25	1709.47	2002.45
Lumbar Adjustment - Mesh Back w/Plastic Base													
Pneumatic		SZT-20-012MA	■	\$1002.00	\$1035.74	\$1071.73	\$1089.74	\$1103.23	\$1135.85	\$1165.09	\$1244.95	\$1300.06	\$1446.55
Back Stop		SZT-20-011MA	■	1077.35	1111.09	1147.08	1165.09	1178.58	1211.20	1240.44	1320.30	1375.41	1521.90
Forward Tilt		SZT-20-013MA	■	1077.35	1111.09	1147.08	1165.09	1178.58	1211.20	1240.44	1320.30	1375.41	1521.90
Back Stop/ Forward Tilt		SZT-20-014MA	■	1100.98	1134.72	1170.71	1188.72	1202.21	1234.83	1264.07	1343.93	1399.04	1545.53
Lumbar Adjustment - Upholstered Back Jacket w/Plastic Base													
Pneumatic		SZT-22-012MA	■	\$1113.35	\$1180.83	\$1252.81	\$1288.83	\$1315.81	\$1381.05	\$1439.53	\$1599.25	\$1709.47	\$2002.45
Back Stop		SZT-22-011MA	■	1188.70	1256.18	1328.16	1364.18	1391.16	1456.40	1514.88	1674.60	1784.82	2077.80
Forward Tilt		SZT-22-013MA	■	1188.70	1256.18	1328.16	1364.18	1391.16	1456.40	1514.88	1674.60	1784.82	2077.80
Back Stop/ Forward Tilt		SZT-22-014MA	■	1212.33	1279.81	1351.79	1387.81	1414.79	1480.03	1538.51	1698.23	1808.45	2101.43
PAL Back System - Mesh Back w/Plastic Base													
Pneumatic		SZT-20-022MA	■	\$1027.87	\$1061.61	\$1097.60	\$1115.61	\$1129.10	\$1161.72	\$1190.96	\$1270.82	\$1325.93	\$1472.42
Back Stop		SZT-20-021MA	■	1103.22	1136.96	1172.95	1190.96	1204.45	1237.07	1266.31	1346.17	1401.28	1547.77
Forward Tilt		SZT-20-023MA	■	1103.22	1136.96	1172.95	1190.96	1204.45	1237.07	1266.31	1346.17	1401.28	1547.77
Back Stop/ Forward Tilt		SZT-20-024MA	■	1126.85	1160.59	1196.58	1214.59	1228.08	1260.70	1289.94	1369.80	1424.91	1571.40
PAL Back System - Upholstered Back Jacket w/Plastic Base													
Pneumatic		SZT-22-022MA	■	\$1139.22	\$1206.70	\$1278.68	\$1314.70	\$1341.68	\$1406.92	\$1465.40	\$1625.12	\$1735.34	\$2028.32
Back Stop		SZT-22-021MA	■	1214.57	1282.05	1354.03	1390.05	1417.03	1482.27	1540.75	1700.47	1810.69	2103.67
Forward Tilt		SZT-22-023MA	■	1214.57	1282.05	1354.03	1390.05	1417.03	1482.27	1540.75	1700.47	1810.69	2103.67
Back Stop/ Forward Tilt		SZT-22-024MA	■	1238.20	1305.68	1377.66	1413.68	1440.66	1505.90	1564.38	1724.10	1834.32	2127.30

The following options require modification of the product number.

- Soft casters To specify, change the 11th digit from a 1 (hard caster) to a 2 (soft caster); **Example:** SZT-20-002MA2
- Aluminum Base To specify, change the 11th digit from a 5 to a 1 (hard caster) or 2 (soft caster) and add **\$32.14** list
- Low position pneumatic To specify, change the 11th digit from a 1 to a 3 (hard caster) or from a 2 to a 4 (soft caster);
Examples: SZT-20-002MA3 is a low base with hard casters
SZT-20-002MA4 is a low base with soft casters
NOTE: Polished aluminum trim not available with this option.
- Fixed seat To specify, change the 10th digit from A to X; **Example:** SZT-20-002MX1
- CAL 133 To specify, add **F** to the end of the product number; **Example:** SZT-20-002MA1F (add **\$138.35** list)
- Headrest To specify, change the 3rd digit from a T to an E; **Example:** SZE-22-002MA1 with headrest (add **\$58.48** list)
- Stain repellent To specify, add **P** to end of the product number (add **\$34.87** list)

NOTE: CAL 133 is available on chairs with black frame and foam seat with or without the Lumbar option.
CAL 133 is not available on chairs with PAL back system.

For available fabrics, refer to surfaces.haworth.com.

Upholstered Gel Insert Seat	Adjustments	Number	①	Fabric Grade								Leather Grade A	Leather Grade B
				A	B	C	D	E	F	G	H		
No Lumbar Adjustment - Mesh Back w/Plastic Base													
	Pneumatic	SZT-20-002EA	■	\$ 996.38	\$1030.12	\$1066.11	\$1084.12	\$1097.61	\$1130.23	\$1159.47	\$1239.33	\$1294.44	\$1440.93
	Back Stop	SZT-20-001EA	■	1071.73	1105.47	1141.46	1159.47	1172.96	1205.58	1234.82	1314.68	1369.79	1516.28
	Forward Tilt	SZT-20-003EA	■	1071.73	1105.47	1141.46	1159.47	1172.96	1205.58	1234.82	1314.68	1369.79	1516.28
	Back Stop/ Forward Tilt	SZT-20-004EA	■	1095.36	1129.10	1165.09	1183.10	1196.59	1229.21	1258.45	1338.31	1393.42	1539.91
No Lumbar Adjustment - Upholstered Back Jacket w/Plastic Base													
	Pneumatic	SZT-22-002EA	■	\$1107.73	\$1175.21	\$1247.19	\$1283.21	\$1310.19	\$1375.43	\$1433.91	\$1593.63	\$1703.85	\$1996.83
	Back Stop	SZT-22-001EA	■	1183.08	1250.56	1322.54	1358.56	1385.54	1450.78	1509.26	1668.98	1779.20	2072.18
	Forward Tilt	SZT-22-003EA	■	1183.08	1250.56	1322.54	1358.56	1385.54	1450.78	1509.26	1668.98	1779.20	2072.18
	Back Stop/ Forward Tilt	SZT-22-004EA	■	1206.71	1274.19	1346.17	1382.19	1409.17	1474.41	1532.89	1692.61	1802.83	2095.81
Lumbar Adjustment - Mesh Back w/Plastic Base													
	Pneumatic	SZT-20-012EA	■	\$1095.36	\$1129.10	\$1165.09	\$1183.10	\$1196.59	\$1229.21	\$1258.45	\$1338.31	\$1393.42	\$1539.91
	Back Stop	SZT-20-011EA	■	1170.71	1204.45	1240.44	1258.45	1271.94	1304.56	1333.80	1413.66	1468.77	1615.26
	Forward Tilt	SZT-20-013EA	■	1170.71	1204.45	1240.44	1258.45	1271.94	1304.56	1333.80	1413.66	1468.77	1615.26
	Back Stop/ Forward Tilt	SZT-20-014EA	■	1194.34	1228.08	1264.07	1282.08	1295.57	1328.19	1357.43	1437.29	1492.40	1638.89
Lumbar Adjustment - Upholstered Back Jacket w/Plastic Base													
	Pneumatic	SZT-22-012EA	■	\$1206.71	\$1274.19	\$1346.17	\$1382.19	\$1409.17	\$1474.41	\$1532.89	\$1692.61	\$1802.83	\$2095.81
	Back Stop	SZT-22-011EA	■	1282.06	1349.54	1421.52	1457.54	1484.52	1549.76	1608.24	1767.96	1878.18	2171.16
	Forward Tilt	SZT-22-013EA	■	1282.06	1349.54	1421.52	1457.54	1484.52	1549.76	1608.24	1767.96	1878.18	2171.16
	Back Stop/ Forward Tilt	SZT-22-014EA	■	1305.69	1373.17	1445.15	1481.17	1508.15	1573.39	1631.87	1791.59	1901.81	2194.79
PAL Back System - Mesh Back w/Plastic Base													
	Pneumatic	SZT-20-022EA	■	\$1121.23	\$1154.97	\$1190.96	\$1208.97	\$1222.46	\$1255.08	\$1284.32	\$1364.18	\$1419.29	\$1565.78
	Back Stop	SZT-20-021EA	■	1196.58	1230.32	1266.31	1284.32	1297.81	1330.43	1359.67	1439.53	1494.64	1641.13
	Forward Tilt	SZT-20-023EA	■	1196.58	1230.32	1266.31	1284.32	1297.81	1330.43	1359.67	1439.53	1494.64	1641.13
	Back Stop/ Forward Tilt	SZT-20-024EA	■	1220.21	1253.95	1289.94	1307.95	1321.44	1354.06	1383.30	1463.16	1518.27	1664.76
PAL Back System - Upholstered Back Jacket w/Plastic Base													
	Pneumatic	SZT-22-022EA	■	\$1232.58	\$1300.06	\$1372.04	\$1408.06	\$1435.04	\$1500.28	\$1558.76	\$1718.48	\$1828.70	\$2121.68
	Back Stop	SZT-22-021EA	■	1307.93	1375.41	1447.39	1483.41	1510.39	1575.63	1634.11	1793.83	1904.05	2197.03
	Forward Tilt	SZT-22-023EA	■	1307.93	1375.41	1447.39	1483.41	1510.39	1575.63	1634.11	1793.83	1904.05	2197.03
	Back Stop/ Forward Tilt	SZT-22-024EA	■	1331.56	1399.04	1471.02	1507.04	1534.02	1599.26	1657.74	1817.46	1927.68	2220.66

The following options require modification of the product number.

Soft casters	To specify, change the 11th digit from a 1 (hard caster) to a 2 (soft caster); Example: SZT-20-002EA2
Aluminum Base	To specify, change the 11th digit from a 5 to a 1 (hard caster) or 2 (soft caster) and add \$32.14 list
Low position pneumatic	To specify, change the 11th digit from a 1 to a 3 (hard caster) or from a 2 to a 4 (soft caster); Examples: SZT-20-002EA3 is a low base with hard casters SZT-20-002EA4 is a low base with soft casters NOTE: Polished aluminum trim not available with this option.
Fixed seat	To specify, change the 10th digit from A to X; Example: SZT-20-002EX1
Headrest	To specify, change the 3rd digit from a T to an E; Example: SZE-22-002EA1 with headrest (add \$58.48 list)
Stain repellent	To specify, add P to end of the product number (add \$34.87 list)
	For available fabrics, refer to surfaces.haworth.com .

Zody

Task Stool with 4D Arms



SZTC-20-702MA1

Dimensions*

- *SH: 21.5-29"
(546mm-737mm)
- H: 43-51"(1092mm-1295mm)
- D: 29"(737mm)
- W: 29"(737mm)
- *SW: 19 1/4"(489mm)
- *AH: 6.8-10.8"
(173mm-274mm)
- *SD: 16-19"(406mm-483mm)

* All measurements taken with the BIFMA chair measuring device.

Trim Color	Arm Cap Color*	
	Black	Smoke
Black (TR-F)	•	
Rusty Red (TR-RR)	•	
Sable (TR-1M)	•	
Smoke (TR-E)		•
Snow (TR-UFM)		•

*Not specifiable.

Features

- Back: Soft mesh only or mesh back with upholstered back jacket.
- Seat: Standard upholstered with foam or optional foam with Technogel® Soft Lite gel insert.
- Seat Type: Standard adjustable [3"(76mm) range] or optional fixed.
- Base: Standard Plastic painted five-star base or optional painted aluminum or polished aluminum. –Plastic base available in Black, or painted Metallic Silver, Metallic Champagne and Metallic Gunmetal. –Aluminum base available with painted Black, Rusty Red, Snow, Metallic Silver, Metallic Champagne, Metallic Gunmetal, or optional Polished Aluminum.
- Arms: 4D with soft arm caps. See matrix for default colors.
- Mechanism: Balanced 3-point tilt; standard tilt tension.
- Height adjustment: Pneumatic.
- Optional Back Stop: Tilt stop in 6 positions.
- Optional Asymmetrical Lumbar Adjustment: 4"(102mm) height adjustment; support level can be adjusted independently for right or left hand side of users body. Optional PAL Back System: Passive pelvic support.
- Casters: Standard with hard casters; optional soft casters.
- COM yardage / COL square footage: Mesh back model: .75/10
Mesh back/upholstered back jacket: 1.5/18

NOTE: When specifying fabric or leather back jacket; must also specify mesh surface color for outside back.

For different fabric grades on seat and upholstered back jacket, pricing will be determined by the sum of the upcharges of the selected jacket fabric grades (i.e. when choosing a Grade B fabric for the seat and a Grade D for the back, the final price will reflect the upcharge for a Grade B seat plus the upcharge for a Grade D back jacket.)

To Order with Mesh Back Specify:

1) Product number, including:

1 Base/Caster Option:

Aluminum Base

- 1 Aluminum Base, Hard Caster, add **\$32.14** to list
- 2 Aluminum Base, Soft Caster, add **\$32.14** to list

Plastic Base

- 5 Plastic Std. Base, Hard Caster
- 6 Plastic Std. Base, Soft Caster

- 2) Fabric surface and color (seat).
- 3) Mesh surface and color (back).
- 4) Trim color for frame. (Add **\$55.00** list for Snow.)
- 5) Trim color for base/arms. (Add **\$187.83** list for polished aluminum.)

To Order with Fabric or Leather Upholstered Back Jacket Specify:

1) Product number, including:

1 Base/Caster Option:

Aluminum Base

- 1 Aluminum Base, Hard Caster, add **\$32.14** to list
- 2 Aluminum Base, Soft Caster, add **\$32.14** to list

Plastic Base

- 5 Plastic Std. Base, Hard Caster
- 6 Plastic Std. Base, Soft Caster

- 2) Fabric surface and color (seat).
- 3) Mesh surface color (back).
- 4) Fabric surface and color (back jacket).
- 5) Trim color for frame. (Add **\$55.00** list for Snow.)
- 6) Trim color for base/arms. (Add **\$187.83** list for polished aluminum.)

Leather Seat with Mesh Back:

Change fifth digit in product number to 1; sixth digit to 0.

Example: SZTC-10-702MA5

Leather Seat with Leather Upholstered Back Jacket:

Change fifth digit in product number to 1; sixth digit to 1.

Example: SZTC-11-702MA5

Faux Leather Seat with Mesh Back:

Change the fifth digit in product number to 3.

Example: SZTC-30-702MA5

Faux Leather Seat with Faux Leather Upholstered Back Jacket:

Change the fifth and sixth digits in product number to 33.

Example: SZTC-33-702MA5

Zody

Task Stool with 4D Arms

Upholstered Foam Seat	Adjustments	Number	①	Fabric Grade								Leather Grade A	Leather Grade B
				A	B	C	D	E	F	G	H		
No Lumbar Adjustment - Mesh Back w/Plastic Base													
	Pneumatic	SZTC-20-702MA		\$1389.78	\$1423.52	\$1459.51	\$1477.52	\$1491.01	\$1523.63	\$1552.87	\$1632.73	\$1687.84	\$1834.33
	Back Stop	SZTC-20-701MA		1465.13	1498.87	1534.86	1552.87	1566.36	1598.98	1628.22	1708.08	1763.19	1909.68
No Lumbar Adjustment - Upholstered Back Jacket w/Plastic Base													
	Pneumatic	SZTC-22-702MA		\$1501.13	\$1568.61	\$1640.59	\$1676.61	\$1703.59	\$1768.83	\$1827.31	\$1987.03	\$2097.25	\$2390.23
	Back Stop	SZTC-22-701MA		1576.48	1643.96	1715.94	1751.96	1778.94	1844.18	1902.66	2062.38	2172.60	2465.58
Lumbar Adjustment - Mesh Back w/Plastic Base													
	Pneumatic	SZTC-20-712MA		\$1488.76	\$1522.50	\$1558.49	\$1576.50	\$1589.99	\$1622.61	\$1651.85	\$1731.71	\$1786.82	\$1933.31
	Back Stop	SZTC-20-711MA		1564.11	1597.85	1633.84	1651.85	1665.34	1697.96	1727.20	1807.06	1862.17	2008.66
Lumbar Adjustment - Upholstered Back Jacket w/Plastic Base													
	Pneumatic	SZTC-22-712MA		\$1600.11	\$1667.59	\$1739.57	\$1775.59	\$1802.57	\$1867.81	\$1926.29	\$2086.01	\$2196.23	\$2489.21
	Back Stop	SZTC-22-711MA		1675.46	1742.94	1814.92	1850.94	1877.92	1943.16	2001.64	2161.36	2271.58	2564.56
PAL Back System - Mesh Back w/Plastic Base													
	Pneumatic	SZTC-20-722MA		\$1514.63	\$1548.37	\$1584.36	\$1602.37	\$1615.86	\$1648.48	\$1677.72	\$1757.58	\$1812.69	\$1959.18
	Back Stop	SZTC-20-721MA		1589.98	1623.72	1659.71	1677.72	1691.21	1723.83	1753.07	1832.93	1888.04	2034.53
PAL Back System - Upholstered Back Jacket w/Plastic Base													
	Pneumatic	SZTC-22-722MA		\$1625.98	\$1693.46	\$1765.44	\$1801.46	\$1828.44	\$1893.68	\$1952.16	\$2111.88	\$2222.10	\$2515.08
	Back Stop	SZTC-22-721MA		1701.33	1768.81	1840.79	1876.81	1903.79	1969.03	2027.51	2187.23	2297.45	2590.43

The following options require modification of the product number.

Fixed seat

To specify, change the 11th digit from A to X; **Example:** SZTC-20-702MX1

Stain repellent

To specify, add **P** to end of the product number (add **\$34.87** list); **Example:** SZTC-20-712MA1P

For available fabrics, refer to surfaces.haworth.com.

Zody

Task Stool with 4D Arms

Upholstered Gel Insert Seat	Adjustments	Number	①	Fabric Grade								Leather Grade A	Leather Grade B
				A	B	C	D	E	F	G	H		
No Lumbar Adjustment - Mesh Back w/Plastic Base													
Pneumatic		SZTC-20-702EA		\$1483.14	\$1516.88	\$1552.87	\$1570.88	\$1584.37	\$1616.99	\$1646.23	\$1726.09	\$1781.20	\$1927.69
Back Stop		SZTC-20-701EA		1558.49	1592.23	1628.22	1646.23	1659.72	1692.34	1721.58	1801.44	1856.55	2003.04
No Lumbar Adjustment - Upholstered Back Jacket w/Plastic Base													
Pneumatic		SZTC-22-702EA		\$1594.49	\$1661.97	\$1733.95	\$1769.97	\$1796.95	\$1862.19	\$1920.67	\$2080.39	\$2190.61	\$2483.59
Back Stop		SZTC-22-701EA		1669.84	1737.32	1809.30	1845.32	1872.30	1937.54	1996.02	2155.74	2265.96	2558.94
Lumbar Adjustment - Mesh Back w/Plastic Base													
Pneumatic		SZTC-20-712EA		\$1582.12	\$1615.86	\$1651.85	\$1669.86	\$1683.35	\$1715.97	\$1745.21	\$1825.07	\$1880.18	\$2026.67
Back Stop		SZTC-20-711EA		1657.47	1691.21	1727.20	1745.21	1758.70	1791.32	1820.56	1900.42	1955.53	2102.02
Lumbar Adjustment - Upholstered Back Jacket w/Plastic Base													
Pneumatic		SZTC-22-712EA		\$1693.47	\$1760.95	\$1832.93	\$1868.95	\$1895.93	\$1961.17	\$2019.65	\$2179.37	\$2289.59	\$2582.57
Back Stop		SZTC-22-711EA		1768.82	1836.30	1908.28	1944.30	1971.28	2036.52	2095.00	2254.72	2364.94	2657.92
PAL Back System - Mesh Back w/Plastic Base													
Pneumatic		SZTC-20-722EA		\$1607.99	\$1641.73	\$1677.72	\$1695.73	\$1709.22	\$1741.84	\$1771.08	\$1850.94	\$1906.05	\$2052.54
Back Stop		SZTC-20-721EA		1683.34	1717.08	1753.07	1771.08	1784.57	1817.19	1846.43	1926.29	1981.40	2127.89
PAL Back System - Upholstered Back Jacket w/Plastic Base													
Pneumatic		SZTC-22-722EA		\$1719.34	\$1786.82	\$1858.80	\$1894.82	\$1921.80	\$1987.04	\$2045.52	\$2205.24	\$2315.46	\$2608.44
Back Stop		SZTC-22-721EA		1794.69	1862.17	1934.15	1970.17	1997.15	2062.39	2120.87	2280.59	2390.81	2683.79

The following options require modification of the product number.

Fixed seat	To specify, change the 11th digit from A to X; Example: SZTC-20-702EX1
Stain repellent	To specify, add P to end of the product number (add \$34.87 list); Example: SZTC-20-702EA1P
	For available fabrics, refer to surfaces.haworth.com .

This page intentionally blank

Zody

Task Stool with Height Adjustable Arms



SZTC-20-402MA1

Dimensions*

- *SH: 21.5-29"
(546mm-737mm)
- H: 43-51"(1092mm-1295mm)
- D: 29"(737mm)
- W: 29"(737mm)
- *SW: 19 1/4"(489mm)
- *AH: 6.8-10.8"
(173mm-274mm)
- *SD: 16-19"(406mm-483mm)

* All measurements taken with the BIFMA chair measuring device.

Trim Color	Arm Cap Color*	
	Black	Smoke
Black (TR-F)	•	
Rusty Red (TR-RR)	•	
Sable (TR-1M)	•	
Smoke (TR-E)		•
Snow (TR-UFM)		•

*Not specifiable.

Features

- Back: Soft mesh only or mesh back with upholstered back jacket.
- Seat: Standard upholstered with foam or optional foam with Technogel® Soft Lite gel insert.
- Seat Type: Standard adjustable [3"(76mm) range] or optional fixed.
- Base: Standard Plastic painted five-star base or optional painted aluminum or polished aluminum.
 - Plastic base available in Black, or painted Metallic Silver, Metallic Champagne and Metallic Gunmetal.
 - Aluminum base available with painted Black, Rusty Red, Snow, Metallic Silver, Metallic Champagne, Metallic Gunmetal, or optional Polished Aluminum.
- Arms: Height-adjustable with soft arm caps. See matrix for default colors.
- Mechanism: Balanced 3-point tilt; standard tilt tension.
- Height adjustment: Pneumatic.
- Optional Back Stop: Tilt stop in 6 positions.
- Optional Asymmetrical Lumbar Adjustment: 4"(102mm) height adjustment; support level can be adjusted independently for right or left hand side of users body. Optional PAL Back System: Passive pelvic support.
- Casters: Standard with hard casters; optional soft casters.
- COM yardage / COL square footage:
 - Mesh back model: 0.75/10
 - Mesh back/upholstered back jacket: 1.5/18

NOTE: When specifying fabric or leather back jacket; must also specify mesh surface color for outside back.

For different fabric grades on seat and upholstered back jacket, pricing will be determined by the sum of the upcharges of the selected jacket fabric grades (i.e. when choosing a Grade B fabric for the seat and a Grade D for the back, the final price will reflect the upcharge for a Grade B seat plus the upcharge for a Grade D back jacket.)

To Order with Mesh Back Specify:

- 1) Product number, including:

1 Base/Caster Option:

Aluminum Base

- 1 Aluminum Base, Hard Caster, add **\$32.14** to list
- 2 Aluminum Base, Soft Caster, add **\$32.14** to list

Plastic Base

- 5 Plastic Std. Base, Hard Caster
- 6 Plastic Std. Base, Soft Caster

- 2) Fabric surface and color (seat).
- 3) Mesh surface and color (back).
- 4) Trim color for frame. (Add **\$55.00** list for Snow.)
- 5) Trim color for base/arms. (Add **\$187.83** list for polished aluminum.)

To Order with Fabric or Leather Upholstered Back Jacket Specify:

- 1) Product number, including:

1 Base/Caster Option:

Aluminum Base

- 1 Aluminum Base, Hard Caster, add **\$32.14** to list
- 2 Aluminum Base, Soft Caster, add **\$32.14** to list

Plastic Base

- 5 Plastic Std. Base, Hard Caster
- 6 Plastic Std. Base, Soft Caster

- 2) Fabric surface and color (seat).
- 3) Mesh surface color (back).
- 4) Fabric surface and color (back jacket).
- 5) Trim color for frame. (Add **\$55.00** list for Snow.)
- 6) Trim color for base/arms. (Add **\$187.83** list for polished aluminum.)

Leather Seat with Mesh Back:

Change fifth digit in product number to 1; sixth digit to 0.

Example: SZTC-10-402MA5

Leather Seat with Leather Upholstered Back Jacket:

Change fifth digit in product number to 1; sixth digit to 1.

Example: SZTC-11-402MA5

Faux Leather Seat with Mesh Back:

Change the fifth digit in product number to 3.

Example: SZTC-30-402MA5

Faux Leather Seat with Faux Leather Upholstered Back Jacket:

Change the fifth and sixth digits in product number to 33.

Example: SZTC-33-402MA5

Zody

Task Stool with Height Adjustable Arms

Upholstered Foam Seat	Adjustments	Number	①	Fabric Grade								Leather Grade A	Leather Grade B
				A	B	C	D	E	F	G	H		
No Lumbar Adjustment - Mesh w/Plastic Base													
	Pneumatic	SZTC-20-402MA		\$1352.66	\$1386.40	\$1422.39	\$1440.40	\$1453.89	\$1486.51	\$1515.75	\$1595.61	\$1650.72	\$1797.21
	Back Stop	SZTC-20-401MA		1428.01	1461.75	1497.74	1515.75	1529.24	1561.86	1591.10	1670.96	1726.07	1872.56
No Lumbar Adjustment - Upholstered Back Jacket w/Plastic Base													
	Pneumatic	SZTC-22-402MA		\$1464.01	\$1531.49	\$1603.47	\$1639.49	\$1666.47	\$1731.71	\$1790.19	\$1949.91	\$2060.13	\$2353.11
	Back Stop	SZTC-22-401MA		1539.36	1606.84	1678.82	1714.84	1741.82	1807.06	1865.54	2025.26	2135.48	2428.46
Lumbar Adjustment - Mesh w/Plastic Base													
	Pneumatic	SZTC-20-412MA		\$1451.64	\$1485.38	\$1521.37	\$1539.38	\$1552.87	\$1585.49	\$1614.73	\$1694.59	\$1749.70	\$1896.19
	Back Stop	SZTC-20-411MA		1526.99	1560.73	1596.72	1614.73	1628.22	1660.84	1690.08	1769.94	1825.05	1971.54
Lumbar Adjustment - Upholstered Back Jacket w/Plastic Base													
	Pneumatic	SZTC-22-412MA		\$1562.99	\$1630.47	\$1702.45	\$1738.47	\$1765.45	\$1830.69	\$1889.17	\$2048.89	\$2159.11	\$2452.09
	Back Stop	SZTC-22-411MA		1638.34	1705.82	1777.80	1813.82	1840.80	1906.04	1964.52	2124.24	2234.46	2527.44
PAL Back System - Mesh w/Plastic Base													
	Pneumatic	SZTC-20-422MA		\$1477.51	\$1511.25	\$1547.24	\$1565.25	\$1578.74	\$1611.36	\$1640.60	\$1720.46	\$1775.57	\$1922.06
	Back Stop	SZTC-20-421MA		1552.86	1586.60	1622.59	1640.60	1654.09	1686.71	1715.95	1795.81	1850.92	1997.41
PAL Back System - Upholstered Back Jacket w/Plastic Base													
	Pneumatic	SZTC-22-422MA		\$1588.86	\$1656.34	\$1728.32	\$1764.34	\$1791.32	\$1856.56	\$1915.04	\$2074.76	\$2184.98	\$2477.96
	Back Stop	SZTC-22-421MA		1664.21	1731.69	1803.67	1839.69	1866.67	1931.91	1990.39	2150.11	2260.33	2553.31

The following options require modification of the product number.

Fixed seat

To specify, change the 11th digit from A to X; **Example:** SZTC-20-402MX1

Stain repellent

To specify, add **P** to end of the product number (add **\$34.87** list); **Example:** SZTC-20-401MAP

For available fabrics, refer to surfaces.haworth.com.

Zody

Task Stool with Height Adjustable Arms

Upholstered Gel Insert Seat	Adjustments	Number	①	Fabric Grade								Leather Grade A	Leather Grade B
				A	B	C	D	E	F	G	H		
No Lumbar Adjustment - Mesh w/Plastic Base													
Pneumatic		SZTC-20-402EA		\$1446.02	\$1479.76	\$1515.75	\$1533.76	\$1547.25	\$1579.87	\$1609.11	\$1688.97	\$1744.08	\$1890.57
Back Stop		SZTC-20-401EA		1521.37	1555.11	1591.10	1609.11	1622.60	1655.22	1684.46	1764.32	1819.43	1965.92
No Lumbar Adjustment - Upholstered Back Jacket w/Plastic Base													
Pneumatic		SZTC-22-402EA		\$1557.37	\$1624.85	\$1696.83	\$1732.85	\$1759.83	\$1825.07	\$1883.55	\$2043.27	\$2153.49	\$2446.47
Back Stop		SZTC-22-401EA		1632.72	1700.20	1772.18	1808.20	1835.18	1900.42	1958.90	2118.62	2228.84	2521.82
Lumbar Adjustment - Mesh w/Plastic Base													
Pneumatic		SZTC-20-412EA		\$1545.00	\$1578.74	\$1614.73	\$1632.74	\$1646.23	\$1678.85	\$1708.09	\$1787.95	\$1843.06	\$1989.55
Back Stop		SZTC-20-411EA		1620.35	1654.09	1690.08	1708.09	1721.58	1754.20	1783.44	1863.30	1918.41	2064.90
Lumbar Adjustment - Upholstered Back Jacket w/Plastic Base													
Pneumatic		SZTC-22-412EA		\$1656.35	\$1723.83	\$1795.81	\$1831.83	\$1858.81	\$1924.05	\$1982.53	\$2142.25	\$2252.47	\$2545.45
Back Stop		SZTC-22-411EA		1731.70	1799.18	1871.16	1907.18	1934.16	1999.40	2057.88	2217.60	2327.82	2620.80
PAL Back System - Mesh w/Plastic Base													
Pneumatic		SZTC-20-422EA		\$1570.87	\$1604.61	\$1640.60	\$1658.61	\$1672.10	\$1704.72	\$1733.96	\$1813.82	\$1868.93	\$2015.42
Back Stop		SZTC-20-421EA		1646.22	1679.96	1715.95	1733.96	1747.45	1780.07	1809.31	1889.17	1944.28	2090.77
PAL Back System - Upholstered Back Jacket w/Plastic Base													
Pneumatic		SZTC-22-422EA		\$1682.22	\$1749.70	\$1821.68	\$1857.70	\$1884.68	\$1949.92	\$2008.40	\$2168.12	\$2278.34	\$2571.32
Back Stop		SZTC-22-421EA		1757.57	1825.05	1897.03	1933.05	1960.03	2025.27	2083.75	2243.47	2353.69	2646.67

The following options require modification of the product number.

Fixed seat	To specify, change the 11th digit from A to X; Example: SZTC-20-402EX1
Stain repellent	To specify, add P to end of the product number (add \$34.87 list); Example: SZTC-20-422EA1P
	For available fabrics, refer to surfaces.haworth.com .

This page intentionally blank

Zody

Task Stool with Fixed Arms



SZTC-20-102MA1

Dimensions*

- *SH: 21.5-29"
(546mm-737mm)
- H: 43-51"(1092mm-1295mm)
- D: 29"(737mm)
- W: 29"(737mm)
- *SW: 19 1/4"(489mm)
- *AH: 9"(229mm)
- *SD: 16-19"(406mm-483mm)

* All measurements taken with the BIFMA chair measuring device.

Trim Color	Arm Cap Color*	
	Black	Smoke
Black (TR-F)	•	
Rusty Red (TR-RR)	•	
Sable (TR-1M)	•	
Smoke (TR-E)		•
Snow (TR-UFM)		•

*Not specifiable.

Features

- Back: Soft mesh only or mesh back with upholstered back jacket.
- Seat: Standard upholstered with foam or optional foam with Technogel® Soft Lite gel insert.
- Seat Type: Standard adjustable [3"(76mm) range] or optional fixed.
- Base: Standard Plastic painted five-star base or optional painted aluminum or polished aluminum.
 - Plastic base available in Black, or painted Metallic Silver, Metallic Champagne and Metallic Gunmetal.
 - Aluminum base available with painted Black, Rusty Red, Snow, Metallic Silver, Metallic Champagne, Metallic Gunmetal, or optional Polished Aluminum.
- Arms: Fixed with soft arm caps. See matrix for default colors.
- Mechanism: Balanced 3-point tilt; standard tilt tension.
- Height adjustment: Pneumatic.
- Optional Back Stop: Tilt stop in 6 positions.
- Optional Asymmetrical Lumbar Adjustment: 4"(102mm) height adjustment; support level can be adjusted independently for right or left hand side of users body. Optional PAL Back System: Passive pelvic support.
- Casters: Standard with hard casters; optional soft casters.
- COM yardage / COL square footage:
 - Mesh back model: 0.75/10
 - Mesh back/upholstered back jacket: 1.5/18

NOTE: When specifying fabric or leather back jacket; must also specify mesh surface color for outside back.

For different fabric grades on seat and upholstered back jacket, pricing will be determined by the sum of the upcharges of the selected jacket fabric grades (i.e. when choosing a Grade B fabric for the seat and a Grade D for the back, the final price will reflect the upcharge for a Grade B seat plus the upcharge for a Grade D back jacket.)

To Order with Mesh Back Specify:

- 1) Product number, including:

1 Base/Caster Option:

Aluminum Base

- 1 Aluminum Base, Hard Caster, add **\$32.14** to list
- 2 Aluminum Base, Soft Caster, add **\$32.14** to list

Plastic Base

- 5 Plastic Std. Base, Hard Caster
- 6 Plastic Std. Base, Soft Caster

- 2) Fabric surface and color (seat).
- 3) Mesh surface and color (back).
- 4) Trim color for frame. (Add **\$55.00** list for Snow.)
- 5) Trim color for base/arms. (Add **\$187.83** list for polished aluminum.)

To Order with Fabric or Leather Upholstered Back Jacket Specify:

- 1) Product number, including:

1 Base/Caster Option:

Aluminum Base

- 1 Aluminum Base, Hard Caster, add **\$32.14** to list
- 2 Aluminum Base, Soft Caster, add **\$32.14** to list

Plastic Base

- 5 Plastic Std. Base, Hard Caster
- 6 Plastic Std. Base, Soft Caster

- 2) Fabric surface and color (seat).
- 3) Mesh surface color (back).
- 4) Fabric surface and color (back jacket).
- 5) Trim color for frame. (Add **\$55.00** list for Snow.)
- 6) Trim color for base/arms. (Add **\$187.83** list for polished aluminum.)

Leather Seat with Mesh Back:

Change fifth digit in product number to 1; sixth digit to 0.

Example: SZTC-10-102MA5

Leather Seat with Leather Upholstered Back Jacket:

Change fifth digit in product number to 1; sixth digit to 1.

Example: SZTC-11-102MA5

Faux Leather Seat with Mesh Back:

Change the fifth digit in product number to 3.

Example: SZTC-30-102MA5

Faux Leather Seat with Faux Leather Upholstered Back Jacket:

Change the fifth and sixth digits in product number to 33.

Example: SZTC-33-102MA5

Zody

Task Stool with Fixed Arms

Upholstered Foam Seat	Adjustments	Number	①	Fabric Grade								Leather Grade A	Leather Grade B
				A	B	C	D	E	F	G	H		
No Lumbar Adjustment - Mesh Back w/Plastic Base													
Pneumatic		SZTC-20-102MA		\$1276.18	\$1309.92	\$1345.91	\$1363.92	\$1377.41	\$1410.03	\$1439.27	\$1519.13	\$1574.24	\$1720.73
Back Stop		SZTC-20-101MA		1351.53	1385.27	1421.26	1439.27	1452.76	1485.38	1514.62	1594.48	1649.59	1796.08
No Lumbar Adjustment - Upholstered Back Jacket w/Plastic Base													
Pneumatic		SZTC-22-102MA		\$1387.53	\$1455.01	\$1526.99	\$1563.01	\$1589.99	\$1655.23	\$1713.71	\$1873.43	\$1983.65	\$2276.63
Back Stop		SZTC-22-101MA		1462.88	1530.36	1602.34	1638.36	1665.34	1730.58	1789.06	1948.78	2059.00	2351.98
Lumbar Adjustment - Mesh Back w/Plastic Base													
Pneumatic		SZTC-20-112MA		\$1375.16	\$1408.90	\$1444.89	\$1462.90	\$1476.39	\$1509.01	\$1538.25	\$1618.11	\$1673.22	\$1819.71
Back Stop		SZTC-20-111MA		1450.51	1484.25	1520.24	1538.25	1551.74	1584.36	1613.60	1693.46	1748.57	1895.06
Lumbar Adjustment - Upholstered Back Jacket w/Plastic Base													
Pneumatic		SZTC-22-112MA		\$1486.51	\$1553.99	\$1625.97	\$1661.99	\$1688.97	\$1754.21	\$1812.69	\$1972.41	\$2082.63	\$2375.61
Back Stop		SZTC-22-111MA		1561.86	1629.34	1701.32	1737.34	1764.32	1829.56	1888.04	2047.76	2157.98	2450.96
PAL Back System - Mesh Back w/Plastic Base													
Pneumatic		SZTC-20-122MA		\$1401.03	\$1434.77	\$1470.76	\$1488.77	\$1502.26	\$1534.88	\$1564.12	\$1643.98	\$1699.09	\$1845.58
Back Stop		SZTC-20-121MA		1476.38	1510.12	1546.11	1564.12	1577.61	1610.23	1639.47	1719.33	1774.44	1920.93
PAL Back System - Upholstered Back Jacket w/Plastic Base													
Pneumatic		SZTC-22-122MA		\$1512.38	\$1579.86	\$1651.84	\$1687.86	\$1714.84	\$1780.08	\$1838.56	\$1998.28	\$2108.50	\$2401.48
Back Stop		SZTC-22-121MA		1587.73	1655.21	1727.19	1763.21	1790.19	1855.43	1913.91	2073.63	2183.85	2476.83

The following options require modification of the product number.

Fixed seat

To specify, change the 11th digit from A to X; **Example:** SZTC-20-102MX1

Stain repellent

To specify, add **P** to end of the product number (add **\$34.87** list); **Example:** SZTC-22-101MA1P

For available fabrics, refer to surfaces.haworth.com.

Zody

Task Stool with Fixed Arms

Upholstered Gel Insert Seat	Adjustments	Number	①	Fabric Grade								Leather Grade A	Leather Grade B
				A	B	C	D	E	F	G	H		
No Lumbar Adjustment - Mesh Back w/Plastic Base													
Pneumatic		SZTC-20-102EA		\$1369.54	\$1403.28	\$1439.27	\$1457.28	\$1470.77	\$1503.39	\$1532.63	\$1612.49	\$1667.60	\$1814.09
Back Stop		SZTC-20-101EA		1444.89	1478.63	1514.62	1532.63	1546.12	1578.74	1607.98	1687.84	1742.95	1889.44
No Lumbar Adjustment - Upholstered Back Jacket w/Plastic Base													
Pneumatic		SZTC-22-102EA		\$1480.89	\$1548.37	\$1620.35	\$1656.37	\$1683.35	\$1748.59	\$1807.07	\$1966.79	\$2077.01	\$2369.99
Back Stop		SZTC-22-101EA		1556.24	1623.72	1695.70	1731.72	1758.70	1823.94	1882.42	2042.14	2152.36	2445.34
Lumbar Adjustment - Mesh Back w/Plastic Base													
Pneumatic		SZTC-20-112EA		\$1468.52	\$1502.26	\$1538.25	\$1556.26	\$1569.75	\$1602.37	\$1631.61	\$1711.47	\$1766.58	\$1913.07
Back Stop		SZTC-20-111EA		1543.87	1577.61	1613.60	1631.61	1645.10	1677.72	1706.96	1786.82	1841.93	1988.42
Lumbar Adjustment - Upholstered Back Jacket w/Plastic Base													
Pneumatic		SZTC-22-112EA		\$1579.87	\$1647.35	\$1719.33	\$1755.35	\$1782.33	\$1847.57	\$1906.05	\$2065.77	\$2175.99	\$2468.97
Back Stop		SZTC-22-111EA		1655.22	1722.70	1794.68	1830.70	1857.68	1922.92	1981.40	2141.12	2251.34	2544.32
PAL Back System - Mesh Back w/Plastic Base													
Pneumatic		SZTC-20-122EA		\$1494.39	\$1528.13	\$1564.12	\$1582.13	\$1595.62	\$1628.24	\$1657.48	\$1737.34	\$1792.45	\$1938.94
Back Stop		SZTC-20-121EA		1569.74	1603.48	1639.47	1657.48	1670.97	1703.59	1732.83	1812.69	1867.80	2014.29
PAL Back System - Upholstered Back Jacket w/Plastic Base													
Pneumatic		SZTC-22-122EA		\$1605.74	\$1673.22	\$1745.20	\$1781.22	\$1808.20	\$1873.44	\$1931.92	\$2091.64	\$2201.86	\$2494.84
Back Stop		SZTC-22-121EA		1681.09	1748.57	1820.55	1856.57	1883.55	1948.79	2007.27	2166.99	2277.21	2570.19

The following options require modification of the product number.

Fixed seat	To specify, change the 11th digit from A to X; Example: SZTC-20-102EX1
Stain repellent	To specify, add P to end of the product number (add \$34.87 list); Example: SZTC-20-102EA1P
	For available fabrics, refer to surfaces.haworth.com .

This page intentionally blank

Zody

Task Stool without Arms



SZTC-20-002MA1

Dimensions*

- *SH: 21.5-29"
(546mm-737mm)
- H: 43-51"(1092mm-1295mm)
- D: 29"(737mm)
- W: 29"(737mm)
- *SW: 19 1/4"(489mm)
- *SD: 16-19"(406mm-483mm)

* All measurements taken with the BIFMA chair measuring device.

Features

- Back: Soft mesh only or mesh back with upholstered back jacket.
- Seat: Standard upholstered with foam or optional foam with Technogel® Soft Lite gel insert.
- Seat Type: Standard adjustable [3"(76mm) range] or optional fixed.
- Base: Standard Plastic painted five-star base or optional painted aluminum or polished aluminum.
 - Plastic base available in Black, or painted Metallic Silver, Metallic Champagne and Metallic Gunmetal.
 - Aluminum base available with painted Black, Rusty Red, Snow, Metallic Silver, Metallic Champagne, Metallic Gunmetal, or optional Polished Aluminum.
- Mechanism: Balanced 3-point tilt; standard tilt tension.
- Height adjustment: Pneumatic.
- Optional Back Stop: Tilt stop in 6 positions.
- Optional Asymmetrical Lumbar Adjustment: 4"(102mm) height adjustment; support level can be adjusted independently for right or left hand side of users body. Optional PAL Back System: Passive pelvic support
- Casters: Standard with hard casters; optional soft casters.
- COM yardage / COL square footage:
 - Mesh back model: 0.75/10
 - Mesh back/upholstered back jacket: 1.5/18

NOTE: When specifying fabric or leather back jacket; must also specify mesh surface color for outside back.

For different fabric grades on seat and upholstered back jacket, pricing will be determined by the sum of the upcharges of the selected jacket fabric grades (i.e. when choosing a Grade B fabric for the seat and a Grade D for the back, the final price will reflect the upcharge for a Grade B seat plus the upcharge for a Grade D back jacket.)

To Order with Mesh Back Specify:

- 1) Product number, including:

① Base/Caster Option:

Aluminum Base

- 1 Aluminum Base, Hard Caster, add **\$32.14** to list
- 2 Aluminum Base, Soft Caster, add **\$32.14** to list

Plastic Base

- 5 Plastic Std. Base, Hard Caster
- 6 Plastic Std. Base, Soft Caster

- 2) Fabric surface and color (seat).
- 3) Mesh surface and color (back).
- 4) Trim color for frame. (Add **\$55.00** list for Snow.)
- 5) Trim color for base. (Add **\$187.83** list for polished aluminum.)

To Order with Fabric or Leather Upholstered Back Jacket Specify:

- 1) Product number, including:

① Base/Caster Option:

Aluminum Base

- 1 Aluminum Base, Hard Caster, add **\$32.14** to list
- 2 Aluminum Base, Soft Caster, add **\$32.14** to list

Plastic Base

- 5 Plastic Std. Base, Hard Caster
- 6 Plastic Std. Base, Soft Caster

- 2) Fabric surface and color (seat).
- 3) Mesh surface color (back).
- 4) Fabric surface and color (back jacket).
- 5) Trim color for frame. (Add **\$55.00** list for Snow.)
- 6) Trim color for base. (Add **\$187.83** list for polished aluminum.)

Leather Seat with Mesh Back:

Change fifth digit in product number to 1; sixth digit to 0.

Example: SZTC-10-002MA5

Leather Seat with Leather Upholstery Back Jacket:

Change fifth digit in product number to 1; sixth digit to 1.

Example: SZTC-11-002MA5

Faux Leather Seat with Mesh Back:

Change the fifth digit in product number to 3.

Example: SZTC-10-002MA5

Faux Leather Seat with Faux Leather Upholstery Back Jacket:

Change the fifth and sixth digits in product number to 33.

Example: SZTC-33-002MA5

Zody

Task Stool without Arms

Upholstered Foam Seat	Adjustments	Number	①	Fabric Grade								Leather Grade A	Leather Grade B
				A	B	C	D	E	F	G	H		
No Lumbar Adjustment - Mesh Back w/Plastic Base													
	Pneumatic	SZTC-20-002MA		\$1151.33	\$1185.07	\$1221.06	\$1239.07	\$1252.56	\$1285.18	\$1314.42	\$1394.28	\$1449.39	\$1595.88
	Back Stop	SZTC-20-001MA		1226.68	1260.42	1296.41	1314.42	1327.91	1360.53	1389.77	1469.63	1524.74	1671.23
No Lumbar Adjustment - Upholstered Back Jacket w/Plastic Base													
	Pneumatic	SZTC-22-002MA		\$1262.68	\$1330.16	\$1402.14	\$1438.16	\$1465.14	\$1530.38	\$1588.86	\$1748.58	\$1858.80	\$2151.78
	Back Stop	SZTC-22-001MA		1338.03	1405.51	1477.49	1513.51	1540.49	1605.73	1664.21	1823.93	1934.15	2227.13
Lumbar Adjustment - Mesh Back w/Plastic Base													
	Pneumatic	SZTC-20-012MA		\$1250.31	\$1284.05	\$1320.04	\$1338.05	\$1351.54	\$1384.16	\$1413.40	\$1493.26	\$1548.37	\$1694.86
	Back Stop	SZTC-20-011MA		1325.66	1359.40	1395.39	1413.40	1426.89	1459.51	1488.75	1568.61	1623.72	1770.21
Lumbar Adjustment - Upholstered Back Jacket w/Plastic Base													
	Pneumatic	SZTC-22-012MA		\$1361.66	\$1429.14	\$1501.12	\$1537.14	\$1564.12	\$1629.36	\$1687.84	\$1847.56	\$1957.78	\$2250.76
	Back Stop	SZTC-22-011MA		1437.01	1504.49	1576.47	1612.49	1639.47	1704.71	1763.19	1922.91	2033.13	2326.11
PAL Back System - Mesh Back w/Plastic Base													
	Pneumatic	SZTC-20-022MA		\$1276.18	\$1309.92	\$1345.91	\$1363.92	\$1377.41	\$1410.03	\$1439.27	\$1519.13	\$1574.24	\$1720.73
	Back Stop	SZTC-20-021MA		1351.53	1385.27	1421.26	1439.27	1452.76	1485.38	1514.62	1594.48	1649.59	1796.08
PAL Back System - Upholstered Back Jacket w/Plastic Base													
	Pneumatic	SZTC-22-022MA		\$1387.53	\$1455.01	\$1526.99	\$1563.01	\$1589.99	\$1655.23	\$1713.71	\$1873.43	\$1983.65	\$2276.63
	Back Stop	SZTC-22-021MA		1462.88	1530.36	1602.34	1638.36	1665.34	1730.58	1789.06	1948.78	2059.00	2351.98

The following options require modification of the product number.

Fixed seat

To specify, change the 11th digit from A to X; **Example:** SZTC-20-002MX1

Stain repellent

To specify, add **P** to end of the product number (add **\$34.87** list); **Example:** SZTC-20-002MA1P

For available fabrics, refer to surfaces.haworth.com.

Zody

Task Stool without Arms

Upholstered Gel Insert Seat	Adjustments	Number	①	Fabric Grade								Leather Grade A	Leather Grade B
				A	B	C	D	E	F	G	H		
No Lumbar Adjustment - Mesh Back w/Plastic Base													
Pneumatic		SZTC-20-002EA		\$1244.69	\$1278.43	\$1314.42	\$1332.43	\$1345.92	\$1378.54	\$1407.78	\$1487.64	\$1542.75	\$1689.24
Back Stop		SZTC-20-001EA		1320.04	1353.78	1389.77	1407.78	1421.27	1453.89	1483.13	1562.99	1618.10	1764.59
No Lumbar Adjustment - Upholstered Back Jacket w/Plastic Base													
Pneumatic		SZTC-22-002EA		\$1356.04	\$1423.52	\$1495.50	\$1531.52	\$1558.50	\$1623.74	\$1682.22	\$1841.94	\$1952.16	\$2245.14
Back Stop		SZTC-22-001EA		1431.39	1498.87	1570.85	1606.87	1633.85	1699.09	1757.57	1917.29	2027.51	2320.49
Lumbar Adjustment - Mesh Back w/Plastic Base													
Pneumatic		SZTC-20-012EA		\$1343.67	\$1377.41	\$1413.40	\$1431.41	\$1444.90	\$1477.52	\$1506.76	\$1586.62	\$1641.73	\$1788.22
Back Stop		SZTC-20-011EA		1419.02	1452.76	1488.75	1506.76	1520.25	1552.87	1582.11	1661.97	1717.08	1863.57
Lumbar Adjustment - Upholstered Back Jacket w/Plastic Base													
Pneumatic		SZTC-22-012EA		\$1455.02	\$1522.50	\$1594.48	\$1630.50	\$1657.48	\$1722.72	\$1781.20	\$1940.92	\$2051.14	\$2344.12
Back Stop		SZTC-22-011EA		1530.37	1597.85	1669.83	1705.85	1732.83	1798.07	1856.55	2016.27	2126.49	2419.47
PAL Back System - Mesh Back w/Plastic Base													
Pneumatic		SZTC-20-022EA		\$1369.54	\$1403.28	\$1439.27	\$1457.28	\$1470.77	\$1503.39	\$1532.63	\$1612.49	\$1667.60	\$1814.09
Back Stop		SZTC-20-021EA		1444.89	1478.63	1514.62	1532.63	1546.12	1578.74	1607.98	1687.84	1742.95	1889.44
PAL Back System - Upholstered Back Jacket w/Plastic Base													
Pneumatic		SZTC-22-022EA		\$1480.89	\$1548.37	\$1620.35	\$1656.37	\$1683.35	\$1748.59	\$1807.07	\$1966.79	\$2077.01	\$2369.99
Back Stop		SZTC-22-021EA		1556.24	1623.72	1695.70	1731.72	1758.70	1823.94	1882.42	2042.14	2152.36	2445.34

The following options require modification of the product number.

Fixed seat	To specify, change the 11th digit from A to X; Example: SZTC-20-002EX1
Stain repellent	To specify, add P to end of the product number (add \$34.87 list); Example: SZTC-20-002EA1P
	For available fabrics, refer to surfaces.haworth.com .

Zody

Sled Base



SZG-22-1

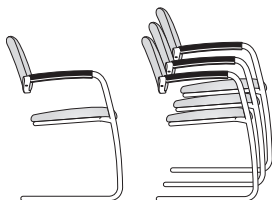

Dimensions*

*SH: 18" (457mm)
 H: 32.5" (826mm)
 D: 22.1" (501mm)
 W: 21" (533mm)
 *SW: 16.8" (427mm)
 *SD: 17" (432mm)
 *AH: 26" (660mm)

* All measurements taken with the BIFMA chair measuring device.

Features

- Back: Upholstered or Wood (Beech)
Fully cantilevered
- Seat: Upholstered
- Base: Sled
- Glide options: Plastic (S) or Felt (J)
(Felt glides for use on hard floors. Glides are retrofittable. See e-Parts.)
- Felt glides are black color.
- Optional Trivalent chrome frame
- Stacking: 4-high
- COM Yardage / COL square footage
Back: 0.75/15.2
Seat: 0.75/15.2
- Available on RUSH.

To Order, Specify:

1) Product number, including:

① Sled Base Glides:

- S** Plastic
J Felt

- 2) Seat surface and color
 3) Back surface and color
 4) Arm cap trim color
 5) Base trim color
 Trivalent chrome (KR-V)
 add **\$187.83** list

Faux Leather Seat and Back:

Change the fourth digit in product number to **33**.

Example: SZG-33-S

Faux Leather Seat with Wood Back:

Change the fourth and fifth digits in product number to **3W**.

Example: SZG-3W-J

Seat	Back	Number ①	Fabric Grade								Leather Grade A	Leather Grade B	
			A	B	C	D	E	F	G	H			
Fabric	Fabric	SZG-22-1	■	\$769.34	\$832.34	\$904.32	\$940.30	\$967.30	\$1030.28	\$1088.76	\$1250.74	N/A	N/A
Fabric	Wood	SZG-2W-1	■	\$863.82	\$895.32	\$931.31	\$949.30	\$962.80	\$ 994.29	\$1023.53	\$1104.52	N/A	N/A
Leather	Leather	SZG-11-1	■	N/A	N/A	N/A	N/A	N/A	N/A	N/A	N/A	\$1360.98	\$1652.00
Leather	Wood	SZG-1W-1	■	N/A	N/A	N/A	N/A	N/A	N/A	N/A	N/A	\$1159.64	\$1305.15

The following options require modification of the product number.

CAL 133
 Stain repellent
 Moisture barrier

To specify, add **F** to the end of the product number; **Example:** SZG-22-1SF (add **\$51.74** list)

To specify, add **P** to end of the product number (add **\$34.87** list)

To specify, add **D** to end of the product number (add **\$47.24** list)

NOTE: For different fabric grades on seat and back, pricing will be determined by the sum of the upcharges of the selected fabric grades (i.e. when choosing a Grade B fabric for the seat and a Grade D for the back, the final price will reflect the upcharge for a Grade B seat plus the upcharge for a Grade D back).

For available fabrics, refer to surfaces.haworth.com.

Zody

4 Leg



SZG-22-1



Dimensions*

- *SH: 18" (457mm)
- H: 32.5" (826mm)
- D: 22.13" (562mm)
- W: 21" (533mm)
- *SW: 16.4" (417mm)
- *SD: 17" (432mm)
- *AH: 26" (660mm)

* All measurements taken with the BIFMA chair measuring device.

Features

- Back: Upholstered or Wood (Beech) Fully cantilevered
- Seat: Upholstered
- Base: 4 Legs
- Optional Glide: Plastic (H) or Felt (K) (Felt glides for use on hard floors. Glides are retrofittable. See e-Parts.)
- Felt glides are black color.
- Optional Trivalent chrome frame
- Stacking: 6-high
- COM Yardage / COL square footage
Back: 0.75/15.2
Seat: 0.75/15.2
- Available on RUSH.

To Order, Specify:

1) Product number, including:

1 Leg Base Glides:

- H** Plastic
- K** Felt

- 2) Seat surface and color
- 3) Back surface and color
- 4) Arm cap trim color
- 5) Base trim color
Trivalent chrome (KR-V)
add **\$187.83** list

Faux Leather Seat and Back:

Change the fourth digit in product number to **33**.

Example: SZG-33-S

Faux Leather Seat with Wood Back:

Change the fourth and fifth digits in product number to **3W**.

Example: SZG-3W-J

Seat	Back	Number 1	Fabric Grade								Leather Grade A	Leather Grade B	
			A	B	C	D	E	F	G	H			
Fabric	Fabric	SZG-22-1	■	\$644.49	\$707.49	\$779.47	\$815.45	\$842.45	\$905.43	\$963.91	\$1125.89	N/A	N/A
Fabric	Wood	SZG-2W-1	■	\$738.97	\$770.47	\$806.46	\$824.45	\$837.95	\$869.44	\$898.68	\$ 979.67	N/A	N/A
Leather	Leather	SZG-11-1	■	N/A	N/A	N/A	N/A	N/A	N/A	N/A	N/A	\$1236.13	\$1527.15
Leather	Wood	SZG-1W-1	■	N/A	N/A	N/A	N/A	N/A	N/A	N/A	N/A	\$1034.79	\$1180.30

The following options require modification of the product number.

- CAL 133
- Stain repellent
- Moisture barrier

To specify, add **F** to the end of the product number; **Example:** SZG-22-1HF (add **\$51.74** list)

To specify, add **P** to end of the product number (add **\$34.87** list)

To specify, add **D** to end of the product number (add **\$47.24** list)

NOTE: For different fabric grades on seat and back, pricing will be determined by the sum of the upcharges of the selected fabric grades (i.e. when choosing a Grade B fabric for the seat and a Grade D for the back, the final price will reflect the upcharge for a Grade B seat plus the upcharge for a Grade D back).

For available fabrics, refer to surfaces.haworth.com.

Very Wire Stacker

General Specifications

Features and Options (Wire Stacker and Wire Stool)

Wire Stacker Chair

- 11mm solid steel rod frame
- Single piece high-strength polymer shell seat and back
- Clear nylon glides
- Frame finishes include: painted or Trivalent chrome
- Optional upholstered foam pad on seat or seat and back
- Fog or black trim arm caps
- Arm or armless version available
- Arm chair stacks 5-high on the floor or 15-high on a cart. Total height on cart is 54"(1372mm). Total depth 55"(1397mm). Height of front edge is 46.5"(1181mm).
- Armless stacks 10-high on the floor, upholstered or non-upholstered; stacks 40-high non-upholstered on a cart; stacks 25-high upholstered on a cart.
- Seat: Stitched double seams. Vertically in the center and on the edges of the leather and faux leather seat cushion. FOR the WIRE STACKER only.
- Ganging option: arm chair to armless, armless to armless.
- Chairs with arms: 16 lbs.
- Chairs without arms: 15 lbs.

Wire Stacker Stool

- Chrome frame
- Stacks 5-high on the floor.
- Single piece high-strength polymer shell seat and back
- Clear nylon glides
- Fog or black trim arm caps
- Arm or armless version available

General Guidelines for Product Specification

	<u>S</u>	<u>C</u>	<u>H</u>	<u>-</u>	<u>2</u>	<u>2</u>	<u>-</u>	<u>3</u>	<u>S</u>	<u>E</u>	<u>3A-18</u>	<u>3A-18</u>	<u>TR-FA</u>	<u>TR-F</u>	<u>KR-V</u>
Product Type	_____														
(S) Seating	_____														
Product Line	_____														
(C) Very	_____														
Model	_____														
(H) Wire Stack	_____														
(W) Stool	_____														
Seat Upholstery	_____														
(1) Leather	_____														
(2) Fabric	_____														
(3) Faux Leather	_____														
(4) Polymer	_____														
Back Upholstery	_____														
(1) Leather	_____														
(2) Fabric	_____														
(3) Faux Leather	_____														
(4) Polymer	_____														
Arm/Caps	_____														
(0) No Arms	_____														
(3) Fixed Arms, Hard Caps	_____														
Base Frame	_____														
(9) Plastic Glide, Ganging*	_____														
(S) Plastic Glide, Non-ganging*	_____														
Enhanced Upholstery	_____														
Seat Upholstery	_____														
Tellure	_____														
Back Upholstery	_____														
Tellure	_____														
Shell Color	_____														
Tomato	_____														
Trim Color	_____														
Black	_____														
Frame Trim Color	_____														
Trivalent Chrome	_____														

*Wire Stacker Chair only

Very

Wire Stacker

With Arms



SCH-44-35

Dimensions

SH: 17.3"(440mm)*
 H: 30.6"(778mm)
 D: 23.3"(591mm)
 W: 23"(584mm)
 SW: 18.8"(476mm)*
 SD: 17.3"(439mm)*
 AH: 8.5"(216mm)*
 Between Arms:
 19.2"(487mm)

* All measurements taken with the BIFMA chair measuring device.

Features

- 11 mm steel rod frame.
- Single high-strength polymer shell seat and back with an optional upholstery pad.
- Upholstered seat features 0.5"(12.7mm) foam pad.
- Upholstered back features 0.5"(12.7mm) foam pad.
- Arms: Black or Fog glass-filled polypropylene arm caps.
- Frame: Available painted or trivalent chrome.
- High impact clear nylon glides available with or without ganging option.
- Stacks 5-high on the floor or 15-high on a cart. Total height on cart is 54"(1372mm). Total depth 55"(1397mm). Height of front edge is 46.5"(1181mm).
- Ganging option: Arm to armless, armless to armless.
- COM yardage / COL square footage:
 Fully Upholstered: 1.5/17.0
 Upholstered seat: 0.8/10.6

■ Available on RUSH.

To Order, Specify:

1) Product number, including;

1 Seat or Seat Pad Option:

- 1 Leather
- 2 Fabric
- 3 Faux Leather
- 4 Polymer

2 Back or Back Pad Option:

- 1 Leather
- 2 Fabric
- 3 Faux Leather
- 4 Polymer

- 2) Fabric surface and color (seat).
- 3) Fabric surface and color (back).
- 4) Shell color - required for upholstered and non-upholstered.
- 5) Trim for arm caps and plastic components.
- 6) Frame trim color.

Ganging	Number 1 2	Price	Fabric Grade		C	D	E	F	G	H	Leather Grade A	Leather Grade B
			A	B								
Polymer Shell Without Optional Upholstered Pad												
Non-Ganging	SCH- 4 4 -3S	\$277.25	N/A	N/A	N/A	N/A	N/A	N/A	N/A	N/A	N/A	N/A
Ganging Glide	SCH- 4 4 -39	287.77	N/A	N/A	N/A	N/A	N/A	N/A	N/A	N/A	N/A	N/A
Polymer Shell With Upholstered Seat Pad												
Non-Ganging	SCH- 4 -3SE	N/A	\$332.23	\$366.15	\$402.43	\$418.80	\$434.00	\$464.42	\$493.67	\$570.89	\$488.99	\$ 629.19
Ganging Glide	SCH- 4 -39E	N/A	342.75	376.67	412.95	429.32	444.52	474.94	504.19	581.41	499.51	639.71
Polymer Shell With Upholstered Seat and Back Pads												
Non-Ganging	SCH- -3SE	N/A	\$398.91	\$466.75	\$539.31	\$572.05	\$602.45	\$663.29	\$721.79	\$876.23	\$712.43	\$ 992.83
Ganging Glide	SCH- -39E	N/A	409.43	477.27	549.83	582.57	612.97	673.81	732.31	886.75	722.95	1003.35

The following options require modification of the product number.

CAL 133
 Stain repellent

To specify, add **F** to the end of the product number; **Example:** SCH-22-3SEF (add \$66.68 list)
 To specify, add **P** to end of the product number (add \$36.26 list)

NOTE: CAL 133 is available on SCH-22 or SCH-33 fully upholstered fabric or faux leather models only.

Stain repellent is available on SCH-22 or SCH-24 models only.

For available fabrics, refer to surfaces.haworth.com.

Very

Wire Stacker

Without Arms



SCH-44-05

Dimensions

- SH: 17.3"(440mm)*
- H: 30.6"(778mm)
- D: 23.3"(591mm)
- W: 21.8"(554mm)
- SW: 18.8"(476mm)*
- SD: 17.3"(439mm)*

* All measurements taken with the BIFMA chair measuring device.

Features

- 11 mm steel rod frame.
- Single piece high-strength polymer shell seat and back with an optional upholstery pad.
- Upholstered seat features 0.5"(12.7mm) foam pad.
- Upholstered back features 0.5"(12.7mm) foam pad.
- Frame: Available painted or trivalent chrome.
- High impact clear nylon glides available with or without ganging option.
- Stacks 10-high on the floor, upholstered or non-upholstered; stacks 40-high non-upholstered on a cart; stacks 25-high upholstered on a cart.
- Ganging option: Arm to armless, armless to armless.
- COM yardage / COL square footage:
Fully Upholstered: 1.5/17.0
Upholstered seat: 0.8/10.6
- Available on RUSH.

To Order, Specify:

1) Product number, including;

1 Seat or Seat Pad Option:

- 1 Leather
- 2 Fabric
- 3 Faux Leather
- 4 Polymer

2 Back or Back Pad Option:

- 1 Leather
- 2 Fabric
- 3 Faux Leather
- 4 Polymer

- 2) Fabric surface and color (seat).
- 3) Fabric surface and color (back).
- 4) Shell color - required for upholstered and non-upholstered.
- 5) Frame trim color.

Ganging	Number 1 2	Price	Fabric Grade		C	D	E	F	G	H	Leather Grade A	Leather Grade B
			A	B								
Polymer Shell Without Optional Upholstered Pad												
Non-Ganging	SCH- 4 4 -05	\$216.42	N/A	N/A	N/A	N/A	N/A	N/A	N/A	N/A	N/A	N/A
Ganging Glide	SCH- 4 4 -09	226.94	N/A	N/A	N/A	N/A	N/A	N/A	N/A	N/A	N/A	N/A
Polymer Shell With Upholstered Seat Pad												
Non-Ganging	SCH- 4 -05E	N/A	\$271.40	\$305.32	\$341.60	\$357.97	\$373.17	\$403.59	\$432.84	\$510.06	\$428.16	\$568.36
Ganging Glide	SCH- 4 -09E	N/A	281.92	315.84	352.12	368.49	383.69	414.11	443.36	520.58	438.68	578.88
Polymer Shell With Upholstered Seat and Back Pads												
Non-Ganging	SCH- -05E	N/A	\$338.08	\$405.92	\$478.48	\$511.22	\$541.62	\$602.46	\$660.96	\$815.40	\$651.60	\$932.00
Ganging Glide	SCH- -09E	N/A	348.60	416.44	489.00	521.74	552.14	612.98	671.48	825.92	662.12	942.52

The following options require modification of the product number.

- CAL 133
- Stain repellent

To specify, add **F** to the end of the product number; **Example:** SCH-22-05EF (add **\$66.68** list)
To specify, add **P** to end of the product number (add **\$36.26** list)

NOTE: CAL 133 is available on SCH-22 or SCH-33 fully upholstered fabric or faux leather models only.
Stain repellent is available on SCH-22 or SCH-24 models only.
For available fabrics, refer to surfaces.haworth.com.

Very

Bar Height Wire Stool

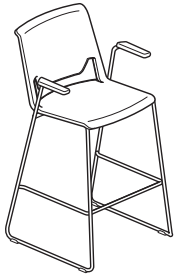

SCW-44-3S

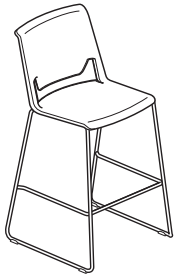

SCW-44-0S

Dimensions

SH: 29.75"(756mm)
 H: 43"(1092mm)
 W: 23"(587mm)
 D: 23"(587mm)
 SW: 18.68"(475mm)
 SD: 17.3"(439mm)

Between Arms:
 19.2"(488mm)

Features

- 11 mm steel rod frame.
- Single piece high-strength polymer shell seat and back with an optional upholstery pad.
- 10 shell color options.
- Upholstered seat features 0.5"(12.7mm) foam pad.
- Upholstered back features 0.5"(12.7mm) foam pad.
- Arms: Black or Fog glass-filled polypropylene arm caps.
- Base: trivalent chrome.
- High impact clear nylon glides.
- Stacks 5-high on the floor.
- Upholstered option.
- 29.75"(756mm) seated height. The foot rest is 11.84"(300.7mm) from the floor.
- COM yardage / COL square footage:
 Fully Upholstered: 1.5/12.5
 Upholstered seat: .8/7.5

To Order, Specify:

1) Product number.

1 Seat or Seat Pad Option:

- 1 Leather
- 2 Fabric
- 3 Faux Leather
- 4 Polymer

2 Back or Back Pad Option:

- 1 Leather
- 2 Fabric
- 3 Faux Leather
- 4 Polymer

- 2) Fabric surface and color (seat).
- 3) Fabric surface and color (back).
- 4) Shell color - required for upholstered and non-upholstered.
- 5) Trim for arm caps (if specified).
- 6) Frame trim color (KR-V only).

Description	Number 1 2	Price	Fabric Grade								Leather Grade A	Leather Grade B
			A	B	C	D	E	F	G	H		
Polymer Shell Without Optional Upholstered Pad												
With Arms	SCW- 44 -3S	\$470.28	N/A	N/A	N/A	N/A	N/A	N/A	N/A	N/A	N/A	N/A
Without Arms	SCW- 44 -0S	409.45	N/A	N/A	N/A	N/A	N/A	N/A	N/A	N/A	N/A	N/A
Polymer Shell With Upholstered Seat Pad												
With Arms	SCW- 4 -3SE	N/A	\$525.26	\$559.18	\$595.46	\$611.83	\$627.03	\$657.45	\$686.70	\$ 763.92	\$682.02	\$ 822.22
Without Arms	SCW- 4 -0SE	N/A	464.43	498.35	534.63	551.00	566.20	596.62	625.87	703.09	621.19	761.39
Polymer Shell With Upholstered Seat and Back Pads												
With Arms	SCW- 4 -3SE	N/A	\$591.94	\$659.78	\$732.34	\$765.08	\$795.48	\$856.32	\$914.82	\$1069.26	\$905.46	\$1185.86
Without Arms	SCW- 4 -0SE	N/A	531.11	598.95	671.51	704.25	734.65	795.49	853.99	1008.43	844.63	1125.03

The following options require modification of the product number.

CAL 133
 Stain repellent

To specify, add **F** to the end of the product number; **Example:** SCW-22-0SEF (add **\$68.68** list)
 To specify, add **P** to end of the product number (add **\$36.26** list)

NOTE: CAL 133 is available on SCW-22 or SCW-33 fully upholstered fabric or faux leather models only.

Stain repellent is available on SCW-22 or SCW-24 models only.

For available fabrics, refer to surfaces.haworth.com.

Very

Counter Height Wire Stool

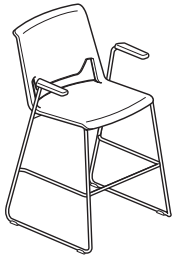

SCWC-44-3S

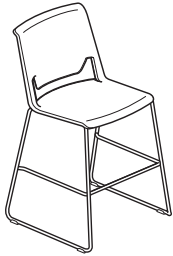

SCWC-44-0S

Dimensions

SH: 25.75"(654mm)
 H: 39"(991mm)
 W: 23"(587mm)
 D: 23"(587mm)
 SW: 18.68"(475mm)
 SD: 17.3"(439mm)

Between Arms:
 19.2"(488mm)

Features

- 11 mm steel rod frame.
- Single piece high-strength polymer shell seat and back with an optional upholstery pad.
- 10 shell color options.
- Upholstered seat features 0.5"(12.7mm) foam pad.
- Upholstered back features 0.5"(12.7mm) foam pad.
- Arms: Black or Fog glass-filled polypropylene arm caps.
- Base: trivalent chrome.
- High impact clear nylon glides.
- Stacks 5-high on the floor.
- Upholstered option.
- 25.75"(654mm) seated height. The foot rest is 7.84"(199.1mm) from the floor.
- COM yardage / COL square footage:
 Fully Upholstered: 1.5/12.5
 Upholstered seat: .8/7.5

To Order, Specify:

1) Product number.

1 Seat or Seat Pad Option:

- 1 Leather
- 2 Fabric
- 3 Faux Leather
- 4 Polymer

2 Back or Back Pad Option:

- 1 Leather
- 2 Fabric
- 3 Faux Leather
- 4 Polymer

- 2) Fabric surface and color (seat).
- 3) Fabric surface and color (back).
- 4) Shell color - required for upholstered and non-upholstered.
- 5) Trim for arm caps (if specified).
- 6) Frame trim color (KR-V only).

Description	Number 1 2	Price	Fabric Grade								Leather Grade A	Leather Grade B
			A	B	C	D	E	F	G	H		
Polymer Shell Without Optional Upholstered Pad												
With Arms	SCWC- 44 -3S	\$470.28	N/A	N/A	N/A	N/A	N/A	N/A	N/A	N/A	N/A	N/A
Without Arms	SCWC- 44 -0S	409.45	N/A	N/A	N/A	N/A	N/A	N/A	N/A	N/A	N/A	N/A
Polymer Shell With Upholstered Seat Pad												
With Arms	SCWC- 4 -3SE	N/A	\$525.26	\$559.18	\$595.46	\$611.83	\$627.03	\$657.45	\$686.70	\$ 763.92	\$682.02	\$ 822.22
Without Arms	SCWC- 4 -0SE	N/A	464.43	498.35	534.63	551.00	566.20	596.62	625.87	703.09	621.19	761.39
Polymer Shell With Upholstered Seat and Back Pads												
With Arms	SCWC- 4 -3SE	N/A	\$591.94	\$659.78	\$732.34	\$765.08	\$795.48	\$856.32	\$914.82	\$1069.26	\$905.46	\$1185.86
Without Arms	SCWC- 4 -0SE	N/A	531.11	598.95	671.51	704.25	734.65	795.49	853.99	1008.43	844.63	1125.03

The following options require modification of the product number.

CAL 133
 Stain repellent

To specify, add **F** to the end of the product number; **Example:** SCWC-22-0SEF (add \$68.68 list)
 To specify, add **P** to end of the product number (add \$36.26 list)

NOTE: CAL 133 is available on SCWC-22 or SCWC-33 fully upholstered fabric or faux leather models only.
 Stain repellent is available on SCWC-22 or SCWC-24 models only.
 For available fabrics, refer to surfaces.haworth.com.

Very Perforated Side, Seminar and Side Stool

General Specifications

Features and Options (Side, Seminar and Side Chair)

Side and Seminar Chair

- Back: High-strength polymer back with perforations for added flexibility and an optional upholstered foam pad
- Seat: High-strength polymer seat with an optional upholstered foam pad
- Casters: Hard (black), soft (black) or two-tone (fog and gray)
- Glides: Plastic or felt
- Frame finishes include: painted or trivalent chrome
- Weight assisted recline mechanism (Seminar model only)
- Fog or black trim arm caps and glides available
- Arm or armless version available
- Optional Laminate Tablet arm
- Optional Storage rack
- Stacking cart (8-high capacity)
- Stacks 5-high on the floor or 8-high (arms - 69" high x 46" wide x 24" deep), (armless - 57" high x 44" wide x 24" deep) on cart.
- 22mm 14-gauge steel leg tube
- Seminar Chair with intuitive reclining back.

Side Stool

- Back: High-strength polymer back with perforations for added flexibility and an optional upholstered foam pad
- Seat: High-strength polymer seat with an optional upholstered polyurethane foam pad
- Glides: Plastic or felt
- Frame finishes include: painted or trivalent chrome
- Fog or black trim arm caps and glides available
- Arm or armless version available
- Stacks 5-high on the floor

General Guidelines for Product Specification

	S	C	M	-	2	2	-	3	1	E	3A-18	3A-18	TR-FA	TR-F	TR-LE
Product Type	_____	_____	_____	_____	_____	_____	_____	_____	_____	_____	_____	_____	_____	_____	_____
(S) Seating	_____	_____	_____	_____	_____	_____	_____	_____	_____	_____	_____	_____	_____	_____	_____
Product Line	_____	_____	_____	_____	_____	_____	_____	_____	_____	_____	_____	_____	_____	_____	_____
(C) Very	_____	_____	_____	_____	_____	_____	_____	_____	_____	_____	_____	_____	_____	_____	_____
Model	_____	_____	_____	_____	_____	_____	_____	_____	_____	_____	_____	_____	_____	_____	_____
(M) Seminar	_____	_____	_____	_____	_____	_____	_____	_____	_____	_____	_____	_____	_____	_____	_____
(S) Side	_____	_____	_____	_____	_____	_____	_____	_____	_____	_____	_____	_____	_____	_____	_____
(L) Side Stool	_____	_____	_____	_____	_____	_____	_____	_____	_____	_____	_____	_____	_____	_____	_____
Seat Upholstery	_____	_____	_____	_____	_____	_____	_____	_____	_____	_____	_____	_____	_____	_____	_____
(1) Leather	_____	_____	_____	_____	_____	_____	_____	_____	_____	_____	_____	_____	_____	_____	_____
(2) Fabric	_____	_____	_____	_____	_____	_____	_____	_____	_____	_____	_____	_____	_____	_____	_____
(3) Faux Leather	_____	_____	_____	_____	_____	_____	_____	_____	_____	_____	_____	_____	_____	_____	_____
(4) Polymer	_____	_____	_____	_____	_____	_____	_____	_____	_____	_____	_____	_____	_____	_____	_____
Back Upholstery	_____	_____	_____	_____	_____	_____	_____	_____	_____	_____	_____	_____	_____	_____	_____
(1) Leather	_____	_____	_____	_____	_____	_____	_____	_____	_____	_____	_____	_____	_____	_____	_____
(2) Fabric	_____	_____	_____	_____	_____	_____	_____	_____	_____	_____	_____	_____	_____	_____	_____
(3) Faux Leather	_____	_____	_____	_____	_____	_____	_____	_____	_____	_____	_____	_____	_____	_____	_____
(4) Polymer	_____	_____	_____	_____	_____	_____	_____	_____	_____	_____	_____	_____	_____	_____	_____
Arm/Caps	_____	_____	_____	_____	_____	_____	_____	_____	_____	_____	_____	_____	_____	_____	_____
(0) No Arms	_____	_____	_____	_____	_____	_____	_____	_____	_____	_____	_____	_____	_____	_____	_____
(3) Fixed Arms, Hard Caps	_____	_____	_____	_____	_____	_____	_____	_____	_____	_____	_____	_____	_____	_____	_____
Base/Caster	_____	_____	_____	_____	_____	_____	_____	_____	_____	_____	_____	_____	_____	_____	_____
(H) 4-Leg, Plastic Glides	_____	_____	_____	_____	_____	_____	_____	_____	_____	_____	_____	_____	_____	_____	_____
(K) 4-Leg, Felt Glides	_____	_____	_____	_____	_____	_____	_____	_____	_____	_____	_____	_____	_____	_____	_____
(1) 4-Leg, Hard Casters*	_____	_____	_____	_____	_____	_____	_____	_____	_____	_____	_____	_____	_____	_____	_____
(2) 4-Leg, Soft Casters*	_____	_____	_____	_____	_____	_____	_____	_____	_____	_____	_____	_____	_____	_____	_____
(T) 4-Leg, Two-Tone Casters*	_____	_____	_____	_____	_____	_____	_____	_____	_____	_____	_____	_____	_____	_____	_____
Enhanced Upholstery	_____	_____	_____	_____	_____	_____	_____	_____	_____	_____	_____	_____	_____	_____	_____
Seat Upholstery	_____	_____	_____	_____	_____	_____	_____	_____	_____	_____	_____	_____	_____	_____	_____
Tellure	_____	_____	_____	_____	_____	_____	_____	_____	_____	_____	_____	_____	_____	_____	_____
Back Upholstery	_____	_____	_____	_____	_____	_____	_____	_____	_____	_____	_____	_____	_____	_____	_____
Tellure	_____	_____	_____	_____	_____	_____	_____	_____	_____	_____	_____	_____	_____	_____	_____
Shell Color	_____	_____	_____	_____	_____	_____	_____	_____	_____	_____	_____	_____	_____	_____	_____
Tomato	_____	_____	_____	_____	_____	_____	_____	_____	_____	_____	_____	_____	_____	_____	_____
Trim Color	_____	_____	_____	_____	_____	_____	_____	_____	_____	_____	_____	_____	_____	_____	_____
Black	_____	_____	_____	_____	_____	_____	_____	_____	_____	_____	_____	_____	_____	_____	_____
Frame Trim Color	_____	_____	_____	_____	_____	_____	_____	_____	_____	_____	_____	_____	_____	_____	_____
Metallic Silver	_____	_____	_____	_____	_____	_____	_____	_____	_____	_____	_____	_____	_____	_____	_____

*Side and Seminar chairs only.

Very

Side Chair – Perforated

With Arms

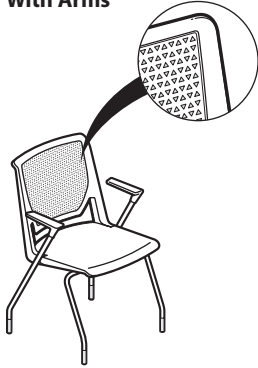

SCS-44-3H

Dimensions

- SH: 18.2"(461mm)*
- H: 33.9"(861mm)
- D: 22"(559mm)
- W: 23.5"(597mm)
- SW: 19.2"(487mm)*
- SD: 17.5"(443mm)*
- AH: 8.9"(226mm)*
- Between Arms: 19.6"(498mm)

* All measurements taken with the BIFMA chair measuring device.

Features

- Back: High-strength polymer back with flexing perforations and an optional upholstered foam pad.
 - Seat: High-strength polymer seat with an optional upholstery pad.
 - Upholstered seat features 1"(25.4mm) foam pad.
 - Upholstered back features 0.5"(12.7mm) foam pad.
 - Arms: Black or Fog glass-filled polypropylene arm caps.
 - Frame: Available painted or trivalent chrome.
 - Casters: Hard (black), soft (black) or two-tone (fog and gray).
 - Glides: Plastic or felt.
 - Stacks 5-high on the floor and 8-high on a cart with glides and casters.
 - COM yardage / COL square footage:
Fully Upholstered: 1.5/17.0
Upholstered seat: 0.75/9.5
- Available on RUSH.

To Order, Specify:

1) Product number, including;

1 Seat or Seat Pad Option:

- 1 Leather
- 2 Fabric
- 3 Faux Leather
- 4 Polymer

2 Back or Back Pad Option:

- 1 Leather
- 2 Fabric
- 3 Faux Leather
- 4 Polymer

3 Glide or Caster Option:

- H Plastic Glide
- K Felt Glide
- 1 Hard Casters, add \$42.12 list
- 2 Soft Casters, add \$42.12 list
- T Two-Tone Casters, add \$42.12 list

- 2) Fabric surface and color (seat).
- 3) Fabric surface and color (back).
- 4) Shell color – required for upholstered and non-upholstered.
- 5) Trim for arm caps, glides and plastic components.
- 6) Frame trim color.
Trivalent Chrome (KR-V) add \$181.33 list.

Number 1 2 3	Price	Fabric Grade		C	D	E	F	G	H	Leather Grade A	Leather Grade B
		A	B								
Polymer Shell Without Optional Upholstered Pad											
SCS- 4 4 -3 ■	\$325.22	N/A	N/A	N/A	N/A	N/A	N/A	N/A	N/A	N/A	N/A
Polymer Shell With Upholstered Seat Pad											
SCS- ■ 4 -3 ■ E ■	N/A	\$377.86	\$411.78	\$448.06	\$464.43	\$479.63	\$510.05	\$539.30	\$616.52	\$534.62	\$ 674.82
Polymer Shell With Upholstered Seat and Back Pads											
SCS- ■ ■ -3 ■ E	N/A	\$428.05	\$495.89	\$568.45	\$601.19	\$631.59	\$692.43	\$750.93	\$905.37	\$741.57	\$1021.97

The following options require modification of the product number.

- CAL 133
- Stain repellent

To specify, add **F** to the end of the product number; **Example:** SCS-22-3HEF (add \$66.68 list)
To specify, add **P** to end of the product number (add \$36.26 list)

NOTE: CAL 133 is available on SCS-22 or SCS-33 fully upholstered fabric or faux leather upholstered models only.
Stain repellent is available on SCS-22 and SCS-24 models only.
For available fabrics, refer to surfaces.haworth.com.

Very

Side Chair – Perforated

Without Arms

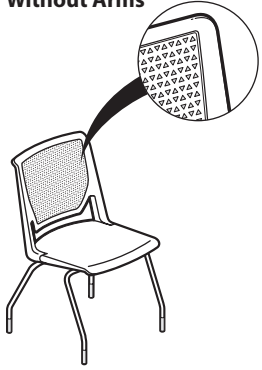

SCS-44-0H

Dimensions

- SH: 18.2"(461mm)*
- H: 33.9"(861mm)
- D: 22"(559mm)
- W: 22.3"(566mm)
- SW: 19.2"(487mm)*
- SD: 17.5"(443mm)*

* All measurements taken with the BIFMA chair measuring device.

Features

- Back: High-strength polymer back with flexing perforations and an optional upholstered foam pad.
- Seat: High-strength polymer seat with an optional upholstery pad.
- Upholstered seat features 1"(25.4mm) foam pad.
- Upholstered back features 0.5"(12.7mm) foam pad.
- Frame: Available painted or trivalent chrome.
- Casters: Hard (black), soft (black) or two-tone (fog and gray).
- Glides: Plastic or felt.
- Stacks 5-high on the floor and 8-high on a cart with glides and casters.
- COM yardage / COL square footage:
Fully Upholstered: 1.5/17
Upholstered seat: 0.75/9.5
- Available on RUSH.

To Order, Specify:

1) Product number, including;

1 Seat or Seat Pad Option:

- 1 Leather
- 2 Fabric
- 3 Faux Leather
- 4 Polymer

2 Back or Back Pad Option:

- 1 Leather
- 2 Fabric
- 3 Faux Leather
- 4 Polymer

3 Glide or Caster Option:

- H Plastic Glide
- K Felt Glide
- 1 Hard Casters, add \$42.12 list
- 2 Soft Casters, add \$42.12 list
- T Two-Tone Casters, add \$42.12 list

- 2) Fabric surface and color (seat).
 - 3) Fabric surface and color (back).
 - 4) Shell color – required for upholstered and non-upholstered.
 - 5) Add glide and plastic component trim color.
 - 6) Frame trim color.
- Trivalent Chrome (KR-V) add \$181.33 list.

Number ① ② ③	Price	Fabric Grade		C	D	E	F	G	H	Leather Grade A	Leather Grade B
		A	B								
Polymer Shell Without Optional Upholstered Pad											
SCS- 4 4 -0 ■	\$264.39	N/A	N/A	N/A	N/A	N/A	N/A	N/A	N/A	N/A	N/A
Polymer Shell With Upholstered Seat Pad											
SCS- ■ 4 -0 ■ E ■	N/A	\$317.03	\$350.95	\$387.23	\$403.60	\$418.80	\$449.22	\$478.47	\$555.69	\$473.79	\$613.99
Polymer Shell With Upholstered Seat and Back Pads											
SCS- ■ ■ -0 ■ E	N/A	\$367.22	\$435.06	\$507.62	\$540.36	\$570.76	\$631.60	\$690.10	\$844.54	\$680.74	\$961.14

The following options require modification of the product number.

CAL 133

Stain repellent

To specify, add **F** to the end of the product number; **Example:** SCS-22-0HEF (add \$66.68 list)

To specify, add **P** to end of the product number (add \$36.26 list)

NOTE: CAL 133 is available on SCS-22 or SCS-33 fully upholstered fabric or faux leather models only.

Stain repellent is available on SCS-22 and SCS-24 models only.

For available fabrics, refer to surfaces.haworth.com.

Very

Side Chair with Tablet Arm – Perforated Back

Side With Tablet Arm

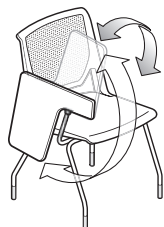

SCS-44-RH

Dimensions

- SH: 18.2"(461mm)*
- H: 33.9"(861mm)
- W: 23.5"(597mm)
- D: 22"(559mm)
- SW: 19.2"(487mm)*
- SD: 17.5"(443mm)*

Features

- Back: High-strength polymer back with flexing perforations and an optional upholstery pad.
- Seat: High-strength polymer with an optional upholstery pad.
- Upholstered seat features 1"(25.4mm) foam pad.
- Upholstered back features 0.5"(12.7mm) foam pad.
- Arm cap: Black.
- Tablet assembly painted black.
- Clearance from tablet to chair back 12.5"(318mm)-15.5"(394mm) angled.
- Flips up and fold away laminate tablet with matching laminate underside.
- Left or right-hand configurations.
- Tablet arm size: 15"W x 9.8"D (Sized to accommodate laptops).
- Base: available painted or optional trivalent chrome.
- Glides or Casters.
- Standard with hard casters, black or two-tone.
- Optional black soft casters.
- COM yardage / COL square footage:
Fully Upholstered: 1.5/13
Upholstered seat: .75/7.25

*All measurements taken with the BIFMA chair measuring device.

To Order, Specify:

1) Product number.

1 Seat or Seat Pad Option:

- 1 Leather
- 2 Fabric
- 3 Faux Leather
- 4 Polymer

2 Back or Back Pad Option:

- 1 Leather
- 2 Fabric
- 3 Faux Leather
- 4 Perforated Polymer

3 Arm or Tablet Option:

- R Right-Hand Tablet Arm
- L Left-Hand Tablet Arm

4 Glide or Caster Option:

- H Plastic Glide
- K Felt Glide
- 1 Hard Casters, add \$42.12 list
- 2 Soft Casters, add \$42.12 list
- T Two-Tone Casters, add \$42.12 list

- 2) Fabric surface and color (seat).
- 3) Fabric surface and color (back).
- 4) Shell color - required for upholstered and non-upholstered.
- 5) Trim for arm caps (if specified) and glides.
- 6) Frame trim color.
Trivalent Chrome (KR-V) add \$181.33 list.
- 7) Laminate for tablet (if specified).

Stain Repellent Upholstery:

Add a **P** to the end of the catalog code, and add \$36.26 list.

Example: SCS-22-RHEP

Description	Number 1 2 3 4	Price	Fabric Grade								Leather Grade A	Leather Grade B
			A	B	C	D	E	F	G	H		
Without Optional Upholstered Pad												
SCS- 4 4 -		\$469.11	N/A	N/A	N/A	N/A	N/A	N/A	N/A	N/A	N/A	N/A
With Upholstered Seat Pad												
SCS- 4 -	E	N/A	\$521.75	\$555.67	\$591.95	\$608.32	\$623.52	\$653.94	\$683.19	\$ 760.41	\$678.51	\$ 818.71
With Upholstered Seat and Back Pads												
SCS- -	E	N/A	\$571.94	\$639.78	\$712.34	\$745.08	\$775.48	\$805.90	\$894.82	\$1049.26	\$885.46	\$1165.86

Very

Side Chair with Storage Rack – Perforated Back



SCK-44-3H

Dimensions

SH: 18.2"(461mm)*
 H: 33.9"(861mm)
 W: 23.5"(597mm)
 D: 22"(559mm)
 SW: 19.2"(487mm)*
 SD: 17.5"(443mm)*
 AH: 8.9"(226mm)*

Between Arms:
 19.6"(498mm)

Features

- Back: High-strength polymer back with flexing perforations and an optional upholstery pad.
- Seat: Injection-molded with an optional upholstery pad.
- Upholstered seat features 1"(25.4mm) foam pad.
- Upholstered back features 0.5"(12.7mm) foam pad.
- Storage rack ships unassembled (chrome only).
- Arms: Black or Fog arm caps when no tablet is specified.
- Optional Tablet arm:
 - Tablet assembly painted black.
 - Flips up and fold away laminate tablet with matching laminate underside.
 - Left or right-hand configurations.
 - Tablet arm size: 15"W x 9.8"D (Sized to accommodate laptops).
- Base: available painted or optional trivalent chrome.
- Glides or Casters: Standard with hard casters, black or two-tone.
- Optional black soft casters.
- COM yardage / COL square footage:
 - Fully Upholstered: 1.5/13
 - Upholstered seat: .75/7.25

*All measurements taken with the BIFMA chair measuring device.

To Order, Specify:

1) Product number.

1 Seat or Seat Pad Option:

- 1 Leather
- 2 Fabric
- 3 Faux Leather
- 4 Polymer

2 Back or Back Pad Option:

- 1 Leather
- 2 Fabric
- 3 Faux Leather
- 4 Perforated Polymer

3 Arm or Cap Option:

- R Right-Hand Tablet Arm, add **\$204.72** list
- L Left-Hand Tablet Arm, add **\$204.72** list
- 0 No Arms
- 3 Fixed Arm, Hard Caps, add **\$60.83** list

4 Glide or Caster Option:

- H Plastic Glide
- K Felt Glide
- 1 Hard Casters, add **\$42.12** list
- 2 Soft Casters, add **\$42.12** list
- T Two-Tone Casters, add **\$42.12** list

2) Fabric surface and color (seat).

3) Fabric surface and color (back).

4) Shell color - required for upholstered and non-upholstered.

5) Trim for arm caps (if specified) and glides.

6) Frame trim color.

Trivalent Chrome (KR-V) add **\$181.33** list.

7) Laminate for tablet (if specified).

Stain Repellent Upholstery:

Add a **P** to the end of the catalog code, and add **\$36.26** list.

Example: SCK-22-RHEP

Description	Number 1 2 3 4	Price	Fabric Grade								Leather Grade A	Leather Grade B
			A	B	C	D	E	F	G	H		
Without Optional Upholstered Pad												
SCK- 4 4 - ■ ■		\$340.42	N/A	N/A	N/A	N/A	N/A	N/A	N/A	N/A	N/A	N/A
With Upholstered Seat Pad												
SCK- ■ 4 - ■ ■ E		N/A	\$393.06	\$426.98	\$463.26	\$479.63	\$494.83	\$525.25	\$554.50	\$631.72	\$549.82	\$ 690.02
With Upholstered Seat and Back Pads												
SCK- ■ ■ - ■ ■ E		N/A	\$443.25	\$511.09	\$583.65	\$616.39	\$646.79	\$707.63	\$766.13	\$920.57	\$756.77	\$1037.17

Very

Bar Height Side Stool – Perforated Back

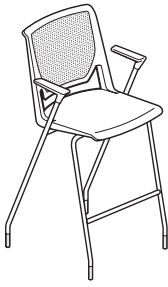

SCL-44-3H

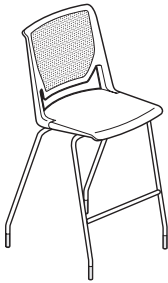

SCL-44-0H

Dimensions

SH: 29.75"(756mm)
 H: 46.25"(1175mm)
 W: 23.75"(604mm)
 D: 23"(587mm)
 SW: 18.75"(477mm)
 SD: 17.2"(434mm)
 AH: 8.9"(226mm)

Between Arms:
 19.6"(498mm)

Features

- Back options: High-strength polymer with flexing perforations and an optional upholstery pad.
- Seat: Injection-molded high-strength polymer seat with an optional upholstery pad.
- Upholstered seat features 1"(25.4mm) foam pad.
- Upholstered back features 0.5"(12.7mm) foam pad.
- Arms: Black or Fog high-strength polymer arm caps.
- Base: available painted or optional trivalent chrome.
- Standard with glides.
- Stacks 5 high on the floor.
- COM yardage / COL square footage:
 Fully Upholstered: 1.5/13
 Upholstered seat: .75/7.25

To Order, Specify:

1) Product number.

1 Seat or Seat Pad Option:

- 1 Leather
- 2 Fabric
- 3 Faux Leather
- 4 Polymer

2 Back or Back Pad Option:

- 1 Leather
- 2 Fabric
- 3 Faux Leather
- 4 Perforated Polymer

3 Glide Option:

- H Plastic Glide
- K Felt Glide

- 2) Fabric surface and color (seat).
 - 3) Fabric surface and color (back).
 - 4) Shell color - required for upholstered and non-upholstered.
 - 5) Trim for arm caps (if specified) and glides.
 - 6) Frame trim color.
- Trivalent Chrome (KR-V) add **\$181.33** list.

Description	Number 1 2 3	Price	Fabric Grade		C	D	E	F	G	H	Leather Grade A	Leather Grade B
			A	B								
Without Optional Upholstered Pad												
With Arms	SCL- 44 -3	\$675.01	N/A	N/A	N/A	N/A	N/A	N/A	N/A	N/A	N/A	N/A
Without Arms	SCL- 44 -0	614.18	N/A	N/A	N/A	N/A	N/A	N/A	N/A	N/A	N/A	N/A
With Upholstered Seat Pad												
With Arms	SCL- 4 -3 E	N/A	\$727.65	\$761.57	\$797.85	\$814.22	\$829.42	\$ 859.84	\$ 889.09	\$ 966.31	\$ 884.41	\$1024.61
Without Arms	SCL- 4 -0 E	N/A	666.82	700.74	737.02	753.39	768.59	799.01	828.26	905.48	823.58	963.78
With Upholstered Seat and Back Pads												
With Arms	SCL- -3 E	N/A	\$777.84	\$845.68	\$918.24	\$950.98	\$981.38	\$1042.22	\$1100.72	\$1255.16	\$1091.36	\$1371.76
Without Arms	SCL- -0 E	N/A	717.01	784.85	857.41	890.15	920.55	981.39	1039.89	1194.33	1030.53	1310.93

The following options require modification of the product number.

CAL 133
 Stain repellent

To specify, add **F** to the end of the product number; **Example:** SCL-22-3HEF (add **\$68.68** list)
 To specify, add **P** to end of the product number; **Example:** SCL-22-3HEP (add **\$36.26** list)

NOTE: CAL 133 is available on SCL-22 or SCL-33 fully upholstered fabric or faux leather models only.

Stain repellent is available on SCL-22 or SCL-24 models only.

For available fabrics, refer to surfaces.haworth.com.

Very

Counter Height Side Stool – Perforated Back

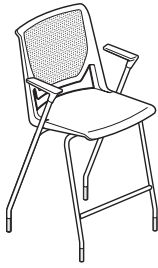

SCLC-44-3H

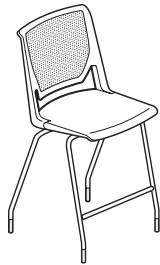

SCLC-44-0H

Dimensions

SH: 25.75"(654mm)
 H: 42.25"(1073mm)
 W: 23.75"(604mm)
 D: 21.7"(551mm)
 SW: 18.75"(477mm)
 SD: 17.2"(434mm)
 AH: 8.9"(226mm)

Between Arms:
 19.6"(498mm)

Features

- Back options: High-strength polymer with flexing perforations and an optional upholstery pad.
- Seat: Injection-molded high-strength polymer seat with an optional upholstery pad.
- Upholstered seat features 1"(25.4mm) foam pad.
- Upholstered back features 0.5"(12.7mm) foam pad.
- Arms: Black or Fog high-strength polymer arm caps.
- Base: available painted or optional trivalent chrome.
- Standard with glides.
- Stacks 5 high on the floor.
- COM yardage / COL square footage:
 Fully Upholstered: 1.5/13
 Upholstered seat: .75/7.25

To Order, Specify:

1) Product number.

1 Seat or Seat Pad Option:

- 1 Leather
- 2 Fabric
- 3 Faux Leather
- 4 Polymer

2 Back or Back Pad Option:

- 1 Leather
- 2 Fabric
- 3 Faux Leather
- 4 Perforated Polymer

3 Glide Option:

- H Plastic Glide
- K Felt Glide

2) Fabric surface and color (seat).

3) Fabric surface and color (back).

4) Shell color - required for upholstered and non-upholstered.

5) Trim for arm caps (if specified) and glides.

6) Frame trim color.

Trivalent Chrome (KR-V) add **\$181.33** list.

Description	Number			Price	Fabric Grade		C	D	E	F	G	H	Leather Grade A	Leather Grade B
	1	2	3		A	B								
Without Optional Upholstered Pad														
With Arms	SCLC-	44	-3	\$675.01	N/A	N/A	N/A	N/A	N/A	N/A	N/A	N/A	N/A	N/A
Without Arms	SCLC-	44	-0	614.18	N/A	N/A	N/A	N/A	N/A	N/A	N/A	N/A	N/A	N/A
With Upholstered Seat Pad														
With Arms	SCLC-	4	-3	N/A	\$727.65	\$761.57	\$797.85	\$814.22	\$829.42	\$ 859.84	\$ 889.09	\$ 966.31	\$ 884.41	\$1024.61
Without Arms	SCLC-	4	-0	N/A	666.82	700.74	737.02	753.39	768.59	799.01	828.26	905.48	823.58	963.78
With Upholstered Seat and Back Pads														
With Arms	SCLC-		-3	N/A	\$777.84	\$845.68	\$918.24	\$950.98	\$981.38	\$1042.22	\$1100.72	\$1255.16	\$1091.36	\$1371.76
Without Arms	SCLC-		-0	N/A	717.01	784.85	857.41	890.15	920.55	981.39	1039.89	1194.33	1030.53	1310.93

The following options require modification of the product number.

CAL 133

Stain repellent

To specify, add **F** to the end of the product number; **Example:** SCLC-22-3HEF (add **\$68.68** list)

To specify, add **P** to end of the product number; **Example:** SCLC-22-3HEP (add **\$36.26** list)

NOTE: CAL 133 is available on SCLC-22 or SCLC-33 fully upholstered fabric or faux leather models only.

Stain repellent is available on SCLC-22 or SCLC-24 models only.

For available fabrics, refer to surfaces.haworth.com.

Very Seminar Chair – Perforated

With Arms

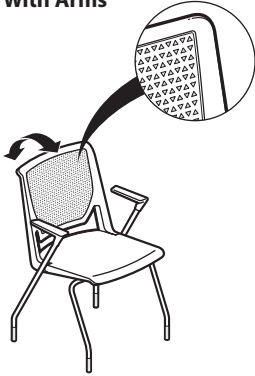

SCM-44-3H

Dimensions

- SH: 18.2”(461mm)*
- H: 33.9”(861mm)
- D: 22”(559mm)
- W: 23.5”(597mm)
- SW: 19.2”(487mm)*
- SD: 17.5”(443mm)*
- AH: 8.9”(226mm)*
- Between Arms: 19.6”(498mm)

* All measurements taken with the BIFMA chair measuring device.

Features

- Back: High-strength polymer back with flexing perforations and an optional upholstered foam pad.
- Seat: High-strength polymer seat with an optional upholstery pad.
- Weight assisted recline mechanism.
- Upholstered seat features 1”(25.4mm) foam pad.
- Upholstered back features 0.5”(12.7mm) foam pad.
- Arms: Black or Fog glass-filled polypropylene arm caps.
- Frame: Available painted or trivalent chrome.
- Casters: Hard (black), soft (black) or two-tone (fog and gray).
- Glides: Plastic or felt.
- Stacks 5-high on the floor and 8-high on a cart with glides and casters.
- COM yardage / COL square footage:
Fully Upholstered: 1.5/17
Upholstered seat: 0.75/9.5
- Available on RUSH.

To Order, Specify:

- 1) Product number, including;
 - 1** Seat or Seat Pad Option:
 - 1 Leather
 - 2 Fabric
 - 3 Faux Leather
 - 4 Polymer
 - 2** Back or Back Pad Option:
 - 1 Leather
 - 2 Fabric
 - 3 Faux Leather
 - 4 Polymer
 - 3** Glide or Caster Option:
 - H Plastic Glide
 - K Felt Glide
 - 1 Hard Casters, add **\$53.81** list
 - 2 Soft Casters, add **\$53.81** list
 - T Two-Tone Casters, add **\$53.81** list
- 2) Fabric surface and color (seat).
- 3) Fabric surface and color (back).
- 4) Shell color – required for upholstered and non-upholstered.
- 5) Trim for arm caps, glides, and plastic components.
- 6) Frame trim color.
Trivalent Chrome (KR-V) add **\$181.33** list.

Number ① ② ③	Price	Fabric Grade		C	D	E	F	G	H	Leather Grade A	Leather Grade B
		A	B								
Polymer Shell Without Optional Upholstered Pad											
SCM- 4 4 -3 ■	\$560.35	N/A	N/A	N/A	N/A	N/A	N/A	N/A	N/A	N/A	N/A
Polymer Shell With Upholstered Seat Pad											
SCM- ■ 4 -3 ■ E ■	N/A	\$617.67	\$651.59	\$687.87	\$704.24	\$719.44	\$749.86	\$ 779.11	\$ 856.33	\$ 774.43	\$ 914.63
Polymer Shell With Upholstered Seat and Back Pads											
SCM- ■ ■ -3 ■ E	N/A	\$689.03	\$756.87	\$829.43	\$862.17	\$892.57	\$953.41	\$1011.91	\$1166.35	\$1002.55	\$1282.95

The following options require modification of the product number.

- CAL 133
- Stain repellent

To specify, add **F** to the end of the product number; **Example:** SCM-22-3HEF (add **\$66.68** list)
To specify, add **P** to end of the product number (add **\$36.26** list)

NOTE: CAL 133 is available on SCM-22 or SCM-33 fully upholstered fabric or faux leather models only.
Stain repellent is available on SCM-22 and SCM-24 models only.
For available fabrics, refer to surfaces.haworth.com.

Very

Seminar Chair – Perforated

Without Arms

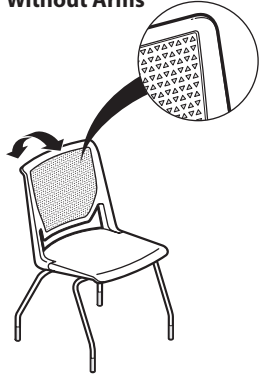

SCM-44-0H

Dimensions

- SH: 18.2"(461mm)*
- H: 33.9"(861mm)
- D: 22"(559mm)
- W: 22.3"(566mm)
- SW: 19.2"(487mm)*
- SD: 17.5"(443mm)*

* All measurements taken with the BIFMA chair measuring device.

Features

- Back: High-strength polymer back with flexing perforations and an optional upholstered foam pad.
- Seat: High-strength polymer seat with an optional upholstery pad.
- Weight assisted recline mechanism.
- Upholstered seat features 1"(25.4mm) foam pad.
- Upholstered back features 0.5"(12.7mm) foam pad.
- Arms: Black or Fog glass-filled polypropylene arm caps.
- Frame: Available painted or trivalent chrome.
- Casters: Hard (black), soft (black) or two-tone (fog and gray).
- Glides: Plastic or felt.
- Stacks 5-high on the floor and 8-high on a cart with glides and casters.
- COM yardage / COL square footage:
 - Fully Upholstered: 1.5/17
 - Upholstered seat: 0.75/9.5
- Available on RUSH.

To Order, Specify:

1) Product number, including;

1 Seat or Seat Pad Option:

- 1 Leather
- 2 Fabric
- 3 Faux Leather
- 4 Polymer

2 Back or Back Pad Option:

- 1 Leather
- 2 Fabric
- 3 Faux Leather
- 4 Polymer

3 Glide or Caster Option:

- H Plastic Glide
- K Felt Glide
- 1 Hard Casters, add \$53.81 list
- 2 Soft Casters, add \$53.81 list
- T Two-Tone Casters, add \$53.81 list

- 2) Fabric surface and color (seat).
 - 3) Fabric surface and color (back).
 - 4) Shell color – required for upholstered and non-upholstered.
 - 5) Glide and plastic component trim color.
 - 6) Frame trim color.
- Trivalent Chrome (KR-V) add \$181.33 list.

Number ① ② ③	Price	Fabric Grade										Leather Grade A	Leather Grade B
		A	B	C	D	E	F	G	H				
Polymer Shell Without Optional Upholstered Pad													
SCM- 4 4 -0 ■	\$499.52	N/A	N/A	N/A	N/A	N/A	N/A	N/A	N/A	N/A	N/A	N/A	N/A
Polymer Shell With Upholstered Seat Pad													
SCM- ■ 4 -0 ■ E ■	N/A	\$556.84	\$590.76	\$627.04	\$643.41	\$658.61	\$689.03	\$718.28	\$795.50	\$713.60	\$853.80		
Polymer Shell With Upholstered Seat and Back Pads													
SCM- ■ ■ -0 ■ E	N/A	\$628.20	\$696.04	\$768.60	\$801.34	\$831.74	\$892.58	\$951.08	\$1105.52	\$941.72	\$1222.12		

The following options require modification of the product number.

CAL 133

Stain repellent

To specify, add **F** to the end of the product number; **Example:** SCM-22-0HEF (add \$66.68 list)

To specify, add **P** to end of the product number (add \$36.26 list)

NOTE: CAL 133 is available on SCM-22 or SCM-33 fully upholstered fabric or faux leather models only.

Stain repellent is available on SCM-22 and SCM-24 models only.

For available fabrics, refer to surfaces.haworth.com.

Very

Seminar with Tablet Arm – Perforated Back

Seminar With Tablet Arm

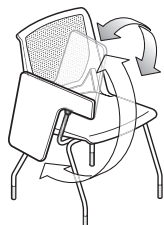

SCM-44-RH

Dimensions

- SH: 18.2"(461mm)*
- H: 33.9"(861mm)
- W: 23.5"(597mm)
- D: 22"(559mm)
- SW: 19.2"(487mm)*
- SD: 17.5"(443mm)*

Features

- Back: High-strength polymer back with flexing perforations and an optional upholstery pad.
- Seat: High-strength polymer with an optional upholstery pad.
- Weight assisted recline mechanism.
- Upholstered seat features 1"(25.4mm) foam pad.
- Upholstered back features 0.5"(12.7mm) foam pad.
- Arm caps: Black.
- Tablet assembly painted black.
- Clearance from tablet to chair back 12.5"(318mm)-15.5"(394mm) angled.
- Flips up and fold away laminate tablet with matching laminate underside.
- Left or right-hand configurations.
- Tablet arm size: 15"W x 9.8"D (Sized to accommodate laptops).
- Base: available painted or optional trivalent chrome.
- Glides or Casters.
- Standard with hard casters, black or two-tone.
- Optional black soft casters.
- COM yardage / COL square footage:
Fully Upholstered: 1.5/13
Upholstered seat: .75/7.25

*All measurements taken with the BIFMA chair measuring device.

To Order, Specify:

1) Product number.

1 Seat or Seat Pad Option:

- 1 Leather
- 2 Fabric
- 3 Faux Leather
- 4 Polymer

2 Back or Back Pad Option:

- 1 Leather
- 2 Fabric
- 3 Faux Leather
- 4 Perforated Polymer

3 Arm or Tablet Option:

- R Right-Hand Tablet Arm
- L Left-Hand Tablet Arm

4 Glide or Caster Option:

- H Plastic Glide
- K Felt Glide
- 1 Hard Casters, add **\$53.81** list
- 2 Soft Casters, add **\$53.81** list
- T Two-Tone Casters, add **\$53.81** list

- 2) Fabric surface and color (seat).
- 3) Fabric surface and color (back).
- 4) Shell color - required for upholstered and non-upholstered.
- 5) Trim for arm caps (if specified) and glides.
- 6) Frame trim color.
- Trivalent Chrome (KR-V) add **\$181.33** list.
- 7) Laminate for tablet (if specified).

Stain Repellent Upholstery:

Add a **P** to the end of the catalog code, and add **\$36.26** list.

Example: SCM-22-RHEP

Description	Number 1 2 3 4	Price	Fabric Grade								Leather Grade A	Leather Grade B	
			A	B	C	D	E	F	G	H			
Without Optional Upholstered Pad													
SCM- 4 4 -		\$704.24	N/A	N/A	N/A	N/A	N/A	N/A	N/A	N/A	N/A	N/A	N/A
With Upholstered Seat Pad													
SCM- 4 -	E	N/A	\$761.56	\$795.48	\$831.76	\$ 848.13	\$ 863.33	\$ 893.75	\$ 923.00	\$1000.22	\$ 918.32	\$1058.52	
With Upholstered Seat and Back Pads													
SCM- -	E	N/A	\$832.92	\$900.76	\$973.32	\$1006.06	\$1036.46	\$1097.30	\$1155.80	\$1310.24	\$1146.44	\$1426.84	

Very

Seminar with Storage Rack – Perforated Back

Seminar With Storage Rack



SCB-44-3H

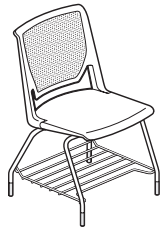

SCB-44-0H

Dimensions

SH: 18.2"(461mm)*
 H: 33.9"(861mm)
 W: 23.5"(597mm)
 D: 22"(559mm)
 SW: 19.2"(487mm)*
 SD: 17.5"(443mm)*
 AH: 8.9"(226mm)*

Between Arms:
 19.6"(498mm)

Features

- Back: High-strength polymer back with flexing perforations and an optional upholstery pad.
- Seat: High-strength polymer seat with an optional upholstery pad.
- Weight assisted recline mechanism.
- Upholstered seat features 1"(25.4mm) foam pad.
- Upholstered back features 0.5"(12.7mm) foam pad.
- Arms: Black or Fog arm caps.
- Storage rack available in Chrome only.
- Tablet assembly painted black.
- Flips up and fold away laminate tablet with matching laminate underside.
- Left or right-hand configurations.
- Tablet arm size: 15"W x 9.8"D (Sized to accommodate laptops).
- Ships with chair, unassembled.
- Base: available painted or optional trivalent chrome.
- Glides or Casters: Standard with hard casters, black or two-tone.
- Optional black soft casters.
- COM yardage / COL square footage:
 Fully Upholstered: 1.5/13
 Upholstered seat: .75/7.25

*All measurements taken with the BIFMA chair measuring device.

To Order, Specify:

1) Product number.

1 Seat or Seat Pad Option:

- 1 Leather
- 2 Fabric
- 3 Faux Leather
- 4 Polymer Back or Back Pad

2 Back or Back Pad Option:

- 1 Leather
- 2 Fabric Faux Leather
- 4 Perforated Polymer

3 Arm or Cap Option:

- R Right-Hand Tablet Arm, add \$204.72 list
- L Left-Hand Tablet Arm, add \$204.72 list
- 0 No Arms
- 3 Fixed Arm, Hard Caps, add \$60.83 list

4 Glide or Caster Option:

- H Plastic Glide
- K Felt Glide
- 1 Hard Casters, add \$53.81 list
- 2 Soft Casters, add \$53.81 list
- T Two-Tone Casters, add \$53.81 list

2) Fabric surface and color (seat).

3) Fabric surface and color (back).

4) Shell color - required for upholstered and non-upholstered.

5) Trim for arm caps (if specified) and glides.

6) Frame trim color.

Trivalent Chrome (KR-V) add \$181.33 list.

Stain Repellent Upholstery:

Add a **P** to the end of the catalog code, and add \$36.26 list.

Example: SCB-22-RHEP

Description	Number ① ② ③ ④	Price	Fabric Grade								Leather Grade A	Leather Grade B
			A	B	C	D	E	F	G	H		
Without Optional Upholstered Pad												
SCB- 4 4 - ■ ■		\$575.55	N/A	N/A	N/A	N/A	N/A	N/A	N/A	N/A	N/A	N/A
With Upholstered Seat Pad												
SCB- ■ 4 - ■ ■ E		N/A	\$632.87	\$666.79	\$703.07	\$719.44	\$734.64	\$765.06	\$ 794.31	\$ 871.53	\$ 789.63	\$ 929.83
With Upholstered Seat and Back Pads												
SCB- ■ ■ - ■ ■ E		N/A	\$704.23	\$772.07	\$844.63	\$877.37	\$907.77	\$968.61	\$1027.11	\$1181.55	\$1017.75	\$1298.15

Very Perforated Conference Chair and Conference Stool

General Specifications

**Features and Options
(Conference Chair and Conference Stool)**

- Back: High-strength polymer back with flexing perforations and an optional upholstered foam pad
- Seat: High-strength polymer seat with an optional upholstered polyurethane foam pad
- Five-star base with casters: hard (black), soft (black) or two-tone (fog and gray)
- Base: painted aluminum, polished aluminum or plastic (fog or black)
- Frame finishes include: painted or polished aluminum
- Weight assisted recline mechanism
- Pneumatic height adjustment
- Fog or black trim arm caps
- Arm or armless version available
- Adjustable footring in brushed aluminum (stool only)

**General Guidelines for
Product Specification**

	S	C	C - 2	2 - 1	1	E	3A-18	3A-18	TR-FA	TR-F	TR-LE
Conference											
Product Type	_____	_____	_____	_____	_____	_____	_____	_____	_____	_____	_____
(S) Seating	_____	_____	_____	_____	_____	_____	_____	_____	_____	_____	_____
Product Line	_____	_____	_____	_____	_____	_____	_____	_____	_____	_____	_____
(C) Very	_____	_____	_____	_____	_____	_____	_____	_____	_____	_____	_____
Model	_____	_____	_____	_____	_____	_____	_____	_____	_____	_____	_____
(C) Conference	_____	_____	_____	_____	_____	_____	_____	_____	_____	_____	_____
(F) Stool	_____	_____	_____	_____	_____	_____	_____	_____	_____	_____	_____
Seat Upholstery	_____	_____	_____	_____	_____	_____	_____	_____	_____	_____	_____
(1) Leather	_____	_____	_____	_____	_____	_____	_____	_____	_____	_____	_____
(2) Fabric	_____	_____	_____	_____	_____	_____	_____	_____	_____	_____	_____
(3) Faux Leather	_____	_____	_____	_____	_____	_____	_____	_____	_____	_____	_____
(4) Polymer	_____	_____	_____	_____	_____	_____	_____	_____	_____	_____	_____
Back Upholstery	_____	_____	_____	_____	_____	_____	_____	_____	_____	_____	_____
(1) Leather	_____	_____	_____	_____	_____	_____	_____	_____	_____	_____	_____
(2) Fabric	_____	_____	_____	_____	_____	_____	_____	_____	_____	_____	_____
(3) Faux Leather	_____	_____	_____	_____	_____	_____	_____	_____	_____	_____	_____
(4) Polymer	_____	_____	_____	_____	_____	_____	_____	_____	_____	_____	_____
Arm/Caps	_____	_____	_____	_____	_____	_____	_____	_____	_____	_____	_____
(0) No Arms	_____	_____	_____	_____	_____	_____	_____	_____	_____	_____	_____
(1) Fixed Arms, Soft Caps	_____	_____	_____	_____	_____	_____	_____	_____	_____	_____	_____
Base/Caster	_____	_____	_____	_____	_____	_____	_____	_____	_____	_____	_____
(1) Aluminum Standard Base, Hard Caster	_____	_____	_____	_____	_____	_____	_____	_____	_____	_____	_____
(2) Aluminum Standard Base, Soft Caster	_____	_____	_____	_____	_____	_____	_____	_____	_____	_____	_____
(3) Aluminum Low Base, Hard Caster	_____	_____	_____	_____	_____	_____	_____	_____	_____	_____	_____
(4) Aluminum Low Base, Soft Caster	_____	_____	_____	_____	_____	_____	_____	_____	_____	_____	_____
(5) Plastic Standard Base, Hard Caster	_____	_____	_____	_____	_____	_____	_____	_____	_____	_____	_____
(6) Plastic Standard Base, Soft Caster	_____	_____	_____	_____	_____	_____	_____	_____	_____	_____	_____
(7) Plastic Low Base, Hard Caster	_____	_____	_____	_____	_____	_____	_____	_____	_____	_____	_____
(8) Plastic Low Base, Soft Caster	_____	_____	_____	_____	_____	_____	_____	_____	_____	_____	_____
(N) Plastic Low Base, Two-Tone Casters	_____	_____	_____	_____	_____	_____	_____	_____	_____	_____	_____
(P) Plastic Standard Base, Two-Tone Casters	_____	_____	_____	_____	_____	_____	_____	_____	_____	_____	_____
(R) Aluminum Low Base, Two-Tone Casters	_____	_____	_____	_____	_____	_____	_____	_____	_____	_____	_____
(T) Aluminum Standard Base, Two-Tone Casters	_____	_____	_____	_____	_____	_____	_____	_____	_____	_____	_____
Enhanced Upholstery	_____	_____	_____	_____	_____	_____	_____	_____	_____	_____	_____
Seat Upholstery	_____	_____	_____	_____	_____	_____	_____	_____	_____	_____	_____
Tellure	_____	_____	_____	_____	_____	_____	_____	_____	_____	_____	_____
Back Upholstery	_____	_____	_____	_____	_____	_____	_____	_____	_____	_____	_____
Tellure	_____	_____	_____	_____	_____	_____	_____	_____	_____	_____	_____
Shell Color	_____	_____	_____	_____	_____	_____	_____	_____	_____	_____	_____
Tomato	_____	_____	_____	_____	_____	_____	_____	_____	_____	_____	_____
Trim Color	_____	_____	_____	_____	_____	_____	_____	_____	_____	_____	_____
Black	_____	_____	_____	_____	_____	_____	_____	_____	_____	_____	_____
Frame Trim Color	_____	_____	_____	_____	_____	_____	_____	_____	_____	_____	_____
Metallic Silver	_____	_____	_____	_____	_____	_____	_____	_____	_____	_____	_____

Very

Conference Chair - Perforated

With Arms



SCC-44-11

Dimensions

- SH: 15.5"(394mm)-20.5"(521mm)*
- H: 36.9"(937mm)
- D: 26.7"(678mm)
- W: 25"(635mm)
- SW: 19.2"(487mm)*
- SD: 17.5"(443mm)*
- AH: 8.7"(220mm)*
- Between Arms: 20.8"(528mm)

Low position base:

- SH: 14.4"(366mm)-19.4"(493mm)*

* All measurements taken with the BIFMA chair measuring device.

Features

- Back: High-strength polymer with flexing perforations and an optional upholstered foam pad.
- Seat: High-strength polymer with an optional upholstered foam pad.
- Upholstered seat features 1"(25.4mm) foam pad.
- Upholstered back features 0.5"(12.7mm) foam pad.
- Arms: Black or Fog glass-filled polypropylene hard arm caps.
- Base: Standard five-star all aluminum or all plastic base. Optional low-base range 14.4"(366mm)-19.4(493mm).
- 5"(127mm) height adjustment.
- Weight assisted recline mechanism.
- Casters: Hard (black), soft (black) or two-tone (fog and gray).
- Back tilts backward 14° from the upright position. Additional recline achieved in flexible back.
- Painted or optional polished aluminum.
- COM yardage / COL square footage:
Fully Upholstered: 1.5/17
Upholstered seat: 0.75/9.5

■ Available on RUSH.

To Order, Specify (cont'd):

3 Base/Caster Option:

Aluminum Base

- 1 Aluminum Std. Base, Hard Caster
- 2 Aluminum Std. Base, Soft Caster
- 3 Aluminum Low Base, Hard Caster
- 4 Aluminum Low Base, Soft Caster

Plastic Base

- 5 Plastic Std. Base, Hard Caster
- 6 Plastic Std. Base, Soft Caster
- 7 Plastic Low Base, Hard Caster
- 8 Plastic Low Base, Soft Caster

Two-Tone Casters

- N Plastic Low Base, Two-Tone Casters
- P Plastic Std. Base, Two-Tone Casters
- R Aluminum Low Base, Two-Tone Casters
- T Aluminum Std. Base, Two-Tone Casters

- 2) Fabric surface and color (seat).
- 3) Fabric surface and color (back).
- 4) Shell color – required for upholstered and non-upholstered.
- 5) Trim for arm caps, plastic components and base (plastic base only).
- 6) Trim color for aluminum components (aluminum base, control housing, and frame).

Polished Aluminum (PM-P) add \$181.33 list.

To Order, Specify:

- 1) Product number, including;

1 Seat or Seat Pad Option:

- 1 Leather
- 2 Fabric
- 3 Faux Leather
- 4 Polymer

2 Back or Back Pad Option:

- 1 Leather
- 2 Fabric
- 3 Faux Leather
- 4 Polymer

Number 1 2 3	Price	Fabric Grade		C	D	E	F	G	H	Leather Grade A	Leather Grade B
		A	B								
Polymer Shell - Aluminum Base Without Optional Upholstered Pad											
SCC- 4 4 -1 ■	\$905.46	N/A	N/A	N/A	N/A	N/A	N/A	N/A	N/A	N/A	N/A
Polymer Shell - Aluminum Base With Upholstered Seat Pad											
SCC- ■ 4 -1 ■ E ■	N/A	\$ 968.64	\$1002.56	\$1038.84	\$1055.21	\$1070.41	\$1100.83	\$1130.08	\$1207.30	\$1125.40	\$1265.60
Polymer Shell - Aluminum Base With Upholstered Seat and Back Pads											
SCC- ■ ■ -1 ■ E	N/A	\$1048.19	\$1116.03	\$1188.59	\$1221.33	\$1251.73	\$1312.57	\$1371.07	\$1525.51	\$1361.71	\$1642.11
Number 1 2 3	Price	Fabric Grade		C	D	E	F	G	H	Leather Grade A	Leather Grade B
		A	B								
Polymer Shell - Plastic Base Without Optional Upholstered Pad											
SCC- 4 4 -1 ■	\$784.97	N/A	N/A	N/A	N/A	N/A	N/A	N/A	N/A	N/A	N/A
Polymer Shell - Plastic Base With Upholstered Seat Pad											
SCC- ■ 4 -1 ■ E ■	N/A	\$848.15	\$882.07	\$ 918.35	\$ 934.72	\$ 949.92	\$ 980.34	\$1009.59	\$1086.81	\$1004.91	\$1145.11
Polymer Shell - Plastic Base With Upholstered Seat and Back Pads											
SCC- ■ ■ -1 ■ E	N/A	\$927.70	\$995.54	\$1068.10	\$1100.84	\$1131.24	\$1192.08	\$1250.58	\$1405.02	\$1241.22	\$1521.62

The following options require modification of the product number.

- CAL 133
- Stain repellent

To specify, add **F** to the end of the product number; **Example:** SCC-22-11EF (add \$66.68 list)
To specify, add **P** to end of the product number (add \$36.26 list)

NOTE: CAL 133 is available on SCC-22 or SCC-33 fully upholstered fabric or faux leather models only.

Stain repellent is available on SCC-22 and SCC-24 models only.

For available fabrics, refer to surfaces.haworth.com.

Very

Conference Chair - Perforated

Without Arms



SCC-44-01

Dimensions

- SH: 15.5"(394mm)-20.5"(521mm)*
- Low position base: SH: 10.4"(264mm)-14.4"(366mm)*
- H: 36.9"(937mm)
- D: 26.7"(678mm)
- W: 21.8"(554mm)
- SW: 19.2"(487mm)*
- SD: 17.5"(443mm)*
- Low position base: SH: 14.4"(366mm)-19.4"(493mm)*

* All measurements taken with the BIFMA chair measuring device.

Features

- Back: High-strength polymer with flexing perforations and an optional upholstered foam pad.
- Seat: High-strength polymer with an optional upholstered foam pad.
- Upholstered seat features 1"(25.4mm) foam pad.
- Upholstered back features 0.5"(12.7mm) foam pad.
- Base: Standard five-star all aluminum or all plastic base. Optional low-base range 14.4"(366mm)-19.4"(493mm).
- 5"(127mm) height adjustment.
- Weight assisted recline mechanism.
- Casters: Hard (black), soft (black) or two-tone (fog and gray).
- Back tilts backward 14° from the upright position. Additional recline achieved in flexible back.
- Painted or optional polished aluminum.
- COM yardage / COL square footage:
Fully Upholstered: 1.5/17
Upholstered seat: 0.75/9.5
- Available on RUSH.

To Order, Specify:

1) Product number, including;

1 Seat or Seat Pad Option:

- 1 Leather
- 2 Fabric
- 3 Faux Leather
- 4 Polymer

2 Back or Back Pad Option:

- 1 Leather
- 2 Fabric
- 3 Faux Leather
- 4 Polymer

To Order, Specify (cont'd):

3 Base/Caster Option:

Aluminum Base

- 1 Aluminum Std. Base, Hard Caster
- 2 Aluminum Std. Base, Soft Caster
- 3 Aluminum Low Base, Hard Caster
- 4 Aluminum Low Base, Soft Caster

Plastic Base

- 5 Plastic Std. Base, Hard Caster
- 6 Plastic Std. Base, Soft Caster
- 7 Plastic Low Base, Hard Caster
- 8 Plastic Low Base, Soft Caster

Two-Tone Casters

- N Plastic Low Base, Two-Tone Casters
- P Plastic Std. Base, Two-Tone Casters
- R Aluminum Low Base, Two-Tone Casters
- T Aluminum Std. Base, Two-Tone Casters

- 2) Fabric surface and color (seat).
- 3) Fabric surface and color (back).
- 4) Shell color – required for upholstered and non-upholstered.
- 5) Trim for plastic components and base (plastic base only).
- 6) Trim color for aluminum components (aluminum base, control housing, and frame).

Polished Aluminum (PM-P) add \$181.33 list.

Number 1 2 3	Price	Fabric Grade		C	D	E	F	G	H	Leather Grade A	Leather Grade B
		A	B								
Polymer Shell - Aluminum Base Without Optional Upholstered Pad											
SCC- 4 4 -0 ■	\$832.93	N/A	N/A	N/A	N/A	N/A	N/A	N/A	N/A	N/A	N/A
Polymer Shell - Aluminum Base With Upholstered Seat Pad											
SCC- ■ 4 -0 ■ E ■	N/A	\$896.11	\$ 930.03	\$ 966.31	\$ 982.68	\$ 997.88	\$1028.30	\$1057.55	\$1134.77	\$1052.87	\$1193.07
Polymer Shell - Aluminum Base With Upholstered Seat and Back Pads											
SCC- ■ ■ -0 ■ E	N/A	\$975.66	\$1043.50	\$1116.06	\$1148.80	\$1179.20	\$1240.04	\$1298.54	\$1452.98	\$1289.18	\$1569.58

Number 1 2 3	Price	Fabric Grade		C	D	E	F	G	H	Leather Grade A	Leather Grade B
		A	B								
Polymer Shell - Plastic Base Without Optional Upholstered Pad											
SCC- 4 4 -0 ■	\$712.44	N/A	N/A	N/A	N/A	N/A	N/A	N/A	N/A	N/A	N/A
Polymer Shell - Plastic Base With Upholstered Seat Pad											
SCC- ■ 4 -0 ■ E ■	N/A	\$775.62	\$809.54	\$845.82	\$ 862.19	\$ 877.39	\$ 907.81	\$ 937.06	\$1014.28	\$ 932.38	\$1072.58
Polymer Shell - Plastic Base With Upholstered Seat and Back Pads											
SCC- ■ ■ -0 ■ E	N/A	\$855.17	\$923.01	\$995.57	\$1028.31	\$1058.71	\$1119.55	\$1178.05	\$1332.49	\$1168.69	\$1449.09

The following options require modification of the product number.

CAL 133
Stain repellent

To specify, add **F** to the end of the product number; **Example:** SCC-22-01EF (add \$66.68 list)
To specify, add **P** to end of the product number (add \$36.26 list)

NOTE: CAL 133 is available on SCC-22 or SCC-33 fully upholstered fabric or faux leather models only.

Stain repellent is available on SCC-22 and SCC-24 models only.

For available fabrics, refer to surfaces.haworth.com.

Very

Conference Stool – Perforated Back



SCF-44-11



SCF-44-01

Dimensions

SH: 23"-32"
(584mm-813mm)
W: 25"(635mm)
D: 26.7"(678mm)
SW: 18.75"(477mm)
SD: 17.2"(434mm)
AH: 8.7"(221mm)

Between Arms:
20.8"(528mm)

Features

- Back: High-strength polymer back with flexing perforations and an optional upholstery pad.
- Seat: High-strength polymer seat with an optional upholstery pad.
- Weight assisted recline mechanism.
- Upholstered seat features 1"(25.4mm) foam pad.
- Upholstered back features 0.5"(12.7mm) foam pad.
- Arms: Black or Fog hard arm caps.
- Base: Standard five-star all aluminum or all plastic base.
- Footring: Brushed Aluminum finish.
- Adjustable footring: adjusts 4"(102mm) up and down.
- Casters: Standard with hard casters, black or two-tone.
- Optional black soft casters.
- COM yardage / COL square footage:
Fully Upholstered: 1.5/13
Upholstered seat: .75/7.25

To Order, Specify:

1) Product number.

1 Seat or Seat Pad Option:

- 1 Leather
- 2 Fabric
- 3 Faux Leather
- 4 Polymer

2 Back or Back Pad Option:

- 1 Leather
- 2 Fabric
- 3 Faux Leather
- 4 Perforated Polymer

3 Arm or Cap Option:

- 0 No Arms
- 1 Fixed Arm, Hard Caps, add \$145.06 list

4 Base or Caster Option:

Aluminum Base

- 1 Aluminum Std. Base, Hard Casters
- 2 Aluminum Std. Base, Soft Casters
- T Aluminum Std. Base, Two-Tone Casters

Plastic Base

- 5 Plastic Std. Base, Hard Casters
- 6 Plastic Std. Base, Soft Casters
- P Plastic Std. Base, Two-Tone Casters

- 2) Fabric surface and color (seat).
- 3) Fabric surface and color (back).
- 4) Shell color - required for upholstered and non-upholstered.
- 5) Trim for arm caps (if specified). (base if plastic is specified above).
- 6) Frame trim color- Aluminum components (base if aluminum and arm uprights).

Stain Repellent Upholstery:

Add a **P** to the end of the catalog code, and add \$36.26 list.

Example: SCF-22-01EP

Description	Number 1 2 3 4	Price	Fabric Grade		C	D	E	F	G	H	Leather Grade A	Leather Grade B
			A	B								
Aluminum Base Without Optional Upholstered Pad												
SCF- 4 4 -		\$1175.70	N/A	N/A	N/A	N/A	N/A	N/A	N/A	N/A	N/A	N/A
Aluminum Base With Upholstered Seat Pad												
SCF- 4 -	E	N/A	\$1238.88	\$1272.80	\$1309.08	\$1325.45	\$1340.65	\$1371.07	\$1400.32	\$1477.54	\$1395.64	\$1535.84
Aluminum Base With Upholstered Seat and Back Pads												
SCF- -	E	N/A	\$1318.43	\$1386.27	\$1458.83	\$1491.57	\$1521.97	\$1582.81	\$1641.31	\$1795.75	\$1631.95	\$1912.35
Plastic Base Without Optional Upholstered Pad												
SCF- 4 4 -		\$1055.21	N/A	N/A	N/A	N/A	N/A	N/A	N/A	N/A	N/A	N/A
Plastic Base With Upholstered Seat Pad												
SCF- 4 -	E	N/A	\$1118.39	\$1152.31	\$1188.59	\$1204.96	\$1220.16	\$1250.58	\$1279.83	\$1357.05	\$1275.15	\$1415.35
Plastic Base With Upholstered Seat and Back Pads												
SCF- -	E	N/A	\$1197.94	\$1265.78	\$1338.34	\$1371.08	\$1401.48	\$1462.32	\$1520.82	\$1675.26	\$1511.46	\$1791.86

Very Tetro Back Side, Seminar Chair and Side Stool

General Specifications

**Features and Options
(Side Chair, Seminar Chair and Side Stool)**

Side and Seminar Chair

- Back: High-strength polymer back with injection molded technology
- Seat: High-strength polymer seat with an optional upholstered foam pad
- Casters: Hard (black), soft (black) or two-tone (fog and gray)
- Glides: Plastic or felt
- Frame finishes include: painted or trivalent chrome
- Weight assisted recline mechanism (Seminar model only)
- Fog or black trim arm caps and glides available
- Arm or armless version available
- Stacks 5-high on the floor or 8-high (71.75" high by 48.25" wide by 25.5" deep) on cart

Side Stool

- Back: High-strength polymer back with injection molded technology
- Seat: High-strength polymer seat with an optional upholstered foam pad
- Glides: Plastic or felt
- Frame finishes include: painted or trivalent chrome
- Fog or black trim arm caps and glides available
- Arm or armless version available
- Stacks 5-high on the floor

**General Guidelines for
Product Specification**

Side and Seminar

	<u>S</u>	<u>C</u>	<u>M</u>	<u>-</u>	<u>2</u>	<u>5</u>	<u>-</u>	<u>3</u>	<u>1</u>	<u>E</u>	<u>3A-18</u>	<u>TR-FA</u>	<u>TR-F</u>	<u>TR-LE</u>
Product Type	_____													
(S) Seating	_____													
Product Line	_____													
(C) Very	_____													
Model	_____													
(M) Seminar	_____													
(S) Side	_____													
(L) Side Stool	_____													
Seat Upholstery	_____													
(1) Leather	_____													
(2) Fabric	_____													
(3) Faux Leather	_____													
(4) Polymer	_____													
Back	_____													
(5) Tetro Back	_____													
Arm/Caps	_____													
(0) No Arms	_____													
(3) Fixed Arms, Hard Caps	_____													
Base/Caster	_____													
(H) 4-Leg, Plastic Glides	_____													
(K) 4-Leg, Felt Glides	_____													
(1) 4-Leg, Hard Casters*	_____													
(2) 4-Leg, Soft Casters*	_____													
(T) 4-Leg, Two-Tone Casters*	_____													
Enhanced Upholstery	_____													
Seat Upholstery	_____													
Tellure	_____													
Shell Color	_____													
Tomato	_____													
Trim Color	_____													
Black	_____													
Frame Trim Color	_____													
Metallic Silver	_____													

*Side and Seminar chairs only

Very

Side Chair – Tetro Back

With Arms



SCS-45-3H

Dimensions

SH: 18.2"(461mm)*
 H: 33.9"(861mm)
 D: 22"(559mm)
 W: 23.5"(597mm)
 SW: 19.2"(487mm)*
 SD: 17.5"(443mm)*
 AH: 8.9"(226mm)*
 Between Arms:
 19.6"(498mm)

Features

- Back: High-strength polymer back with injection molded technology.
- Seat: High-strength polymer seat with an optional upholstery pad.
- Upholstered seat features 1"(25.4mm) foam pad.
- Arms: Black or Fog glass-filled polypropylene arm caps.
- Frame: available painted or trivalent chrome.
- Casters: Hard (black), soft (black) or two-tone (fog and gray).
- Glides: Plastic or felt.
- Stacks 5 high on the floor and 8 high on a cart
- COM yardage / COL square footage:
 Upholstered seat: .75/ 7.25

*All measurements taken with the BIFMA chair measuring device.

To Order, Specify:

1) Product number, including;

1 Seat or Seat Pad Option:

- 1 Leather
- 2 Fabric
- 3 Faux Leather
- 4 Polymer

2 Glide or Caster Option:

- H Plastic Glide
- K Felt Glide
- 1 Hard Casters, add \$42.12 list
- 2 Soft Casters, add \$42.12 list
- T Two-Tone Casters, add \$42.12 list

2) Fabric surface and color (seat).

3) Shell color – required for upholstered and non-upholstered.

4) Trim for arm caps, glides and plastic components.

5) Frame trim color.

Trivalent Chrome (KR-V) add \$181.33 list.

Stain Repellent Upholstery:

Add a **P** to the end of the catalog code, and add \$36.26 list.

Example: SCS-25-3HEP

Number	①	②	Price	Fabric Grade		C	D	E	F	G	H	Leather Grade A	Leather Grade B		
				A	B										
Tetro Back Without Optional Upholstered Pad															
SCS-	4	5	-3	\$325.22	N/A	N/A	N/A	N/A	N/A	N/A	N/A	N/A	N/A		
Tetro Back With Upholstered Seat Pad															
SCS-		5	-3	E	N/A	\$377.86	\$411.78	\$448.06	\$464.43	\$479.63	\$510.05	\$539.30	\$616.52	\$534.62	\$674.82

Very

Side Chair – Tetro Back

Without Arms



SCS-45-0H

Dimensions

- SH: 18.2"(461mm)*
- H: 33.9"(861mm)
- D: 22"(559mm)
- W: 22.3"(566mm)
- SW: 19.2"(487mm)*
- SD: 17.5"(443mm)*

Features

- Back: High-strength polymer back with injection molded technology.
- Seat: High-strength polymer seat with an optional upholstery pad.
- Upholstered seat features 1"(25.4mm) foam pad.
- Frame: available painted or trivalent chrome.
- Casters: Hard (black), soft (black) or two-tone (fog and gray).
- Glides: Plastic or felt.
- Stacks 5 high on the floor and 8 high on a cart
- COM yardage / COL square footage:
Upholstered seat: .75/ 7.25

*All measurements taken with the BIFMA chair measuring device.

To Order, Specify:

1) Product number, including;

1 Seat or Seat Pad Option:

- 1** Leather
- 2** Fabric
- 3** Faux Leather
- 4** Polymer

2 Glide or Caster Option:

- H** Plastic Glide
- K** Felt Glide
- 1** Hard Casters, add **\$42.12** list
- 2** Soft Casters, add **\$42.12** list
- T** Two-Tone Casters, add **\$42.12** list

- 2) Fabric surface and color (seat).
- 3) Shell color – required for upholstered and non-upholstered.
- 4) Add glide and plastic component trim color.
- 5) Frame trim color.
Trivalent Chrome (KR-V) add **\$181.33** list.

Stain Repellent Upholstery:

Add a **P** to the end of the catalog code, and add **\$36.26** list.

Example: SCS-25-0HEP

Number 1 2	Price	Fabric Grade		C	D	E	F	G	H	Leather Grade A	Leather Grade B
		A	B								
Tetro Back Without Optional Upholstered Pad											
SCS- 4 5 -0 ■	\$264.39	N/A	N/A	N/A	N/A	N/A	N/A	N/A	N/A	N/A	N/A
Tetro Back With Upholstered Seat Pad											
SCS- ■ 5 -0 ■ E	N/A	\$317.03	\$350.95	\$387.23	\$403.60	\$418.80	\$449.22	\$478.47	\$555.69	\$473.79	\$613.99

Very

Side Chair with Tablet Arm – Tetro Back

Side With Tablet Arm



SCS-45-RH

Dimensions

- SH: 18.2"(461mm)
- H: 33.9"(861mm)
- W: 23.5"(597mm)
- D: 22"(559mm)
- SW: 19.2"(487mm)
- SD: 17.5"(443mm)

Features

- Back: High-strength polymer back with injection molded technology.
- Seat: High-strength polymer with an optional upholstery pad.
- Upholstered seat features 1"(25.4mm) foam pad.
- Arm cap: Black.
- Tablet assembly painted black.
- Flips up and fold away laminate tablet with matching laminate underside.
- Left or right-hand configurations.
- Tablet arm size: 15"W x 9.8"D (Sized to accommodate laptops).
- Clearance from tablet to chair back 12.5"(318mm)-15.5"(394mm) angled.
- Base: available painted or optional trivalent chrome.
- Glides or Casters.
- Standard with hard casters, black or two-tone.
- Optional black soft casters.
- COM yardage / COL square footage:
Fully Upholstered: 1.5/13
Upholstered seat: .75/7.25

*All measurements taken with the BIFMA chair measuring device.

To Order, Specify:

1) Product number.

1 Seat or Seat Pad Option:

- 1 Leather
- 2 Fabric
- 3 Faux Leather
- 4 Polymer

2 Arm or Tablet Option:

- R Right-Hand Tablet Arm
- L Left-Hand Tablet Arm

3 Glide or Caster Option:

- H Plastic Glide
- K Felt Glide
- 1 Hard Casters, add \$42.12 list
- 2 Soft Casters, add \$42.12 list
- T Two-Tone Casters, add \$42.12 list

- 2) Fabric surface and color (seat).
- 3) Shell color - required for upholstered and non-upholstered.
- 4) Glide and plastic component trim color.
- 5) Frame trim color.
- Trivalent Chrome (KR-V) add \$181.33 list.
- 6) Laminate for tablet (if specified).

Stain Repellent Upholstery:

Add a **P** to the end of the catalog code, and add \$36.26 list.

Example: SCS-25-RHEP

Description	Number			Price	Fabric Grade		C	D	E	F	G	H	Leather Grade A	Leather Grade B
	1	2	3		A	B								
Tetro Back Without Optional Upholstered Pad														
SCS- 4 5- ■ ■				\$469.11	N/A	N/A	N/A	N/A	N/A	N/A	N/A	N/A	N/A	N/A
Tetro Back With Upholstered Seat Pad														
SCS- ■ 5- ■ ■ E				N/A	\$521.75	\$555.67	\$591.95	\$608.32	\$623.52	\$653.94	\$683.19	\$760.41	\$678.51	\$818.71

Very

Side Chair with Storage Rack – Tetro Back



SCK-45-3H

Dimensions

- SH: 18.2"(461mm)*
- H: 33.9"(861mm)
- W: 23.5"(597mm)
- D: 22"(559mm)
- SW: 19.2"(487mm)*
- SD: 17.5"(443mm)*
- AH: 8.9"(226mm)*

Between Arms:
19.6"(498mm)

Features

- Back: High-strength polymer back with injection molded technology.
- Seat: Injection-molded high-strength polymer seat with an optional upholstery pad.
- Upholstered seat features 1"(25.4mm) foam pad.
- Storage rack ships unassembled (chrome only).
- Arms: Black or Fog arm caps when no tablet is specified.
- Optional Tablet arm:
 - Tablet assembly painted black.
 - Flips up and fold away laminate tablet with matching laminate underside.
 - Left or right-hand configurations.
 - Tablet arm size: 15"W x 9.8"D (Sized to accommodate laptops).
- Base: available painted or optional trivalent chrome.
- Glides or Casters: Standard with hard casters, black or two-tone.
- Optional black soft casters.
- COM yardage / COL square footage:
 - Fully Upholstered: 1.5/13
 - Upholstered seat: .75/7.25

*All measurements taken with the BIFMA chair measuring device.

To Order, Specify:

1) Product number.

1 Seat or Seat Pad Option:

- 1 Leather
- 2 Fabric
- 3 Faux Leather
- 4 Polymer

2 Arm or Cap Option:

- 0 No Arms
- 3 Fixed Arm, Hard Caps, add **\$60.83** list

3 Glide or Caster Option:

- H Plastic Glide
- K Felt Glide
- 1 Hard Casters, add **\$42.12** list
- 2 Soft Casters, add **\$42.12** list
- T Two-Tone Casters, add **\$42.12** list

- 2) Fabric surface and color (seat).
- 3) Shell color - required for upholstered and non-upholstered.
- 4) Trim for arm caps (if specified) and glides.
- 5) Frame trim color.
Trivalent Chrome (KR-V) add **\$181.33** list.
- 6) Laminate for tablet (if specified).

Stain Repellent Upholstery:

Add a **P** to the end of the catalog code, and add **\$36.26** list.

Example: SCK-25-0HEP

Description	Number ① ② ③	Price	Fabric Grade								Leather Grade A	Leather Grade B
			A	B	C	D	E	F	G	H		
Tetro Back Without Optional Upholstered Pad												
SCK- 4 5- ■ ■		\$340.42	N/A	N/A	N/A	N/A	N/A	N/A	N/A	N/A	N/A	N/A
Tetro Back With Upholstered Seat Pad												
SCK- ■ 5- ■ ■ E		N/A	\$393.06	\$426.98	\$463.26	\$479.63	\$494.83	\$525.25	\$554.50	\$631.72	\$549.82	\$690.02

Very

Bar Height Side Stool – Tetro Back

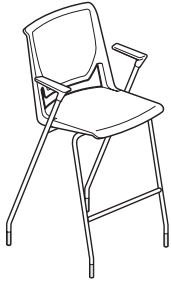

SCL-45-3H

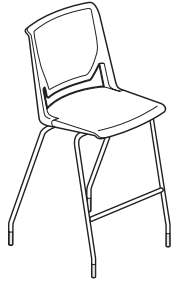

SCL-45-0H

Dimensions

SH: 29.75"(756mm)
 H: 46.25"(1175mm)
 W: 23.75"(604mm)
 D: 23"(587mm)
 SW: 18.75"(477mm)
 SD: 17.2"(434mm)
 AH: 8.9"(226mm)

Between Arms:
 19.6"(498mm)

Features

- Back: High-strength polymer back with injection molded technology.
- Seat: High-strength polymer seat with an optional upholstery pad.
- Upholstered seat features 1"(25.4mm) foam pad.
- Arms: Black or Fog high-strength polymer arm caps.
- Base: available painted or optional trivalent chrome.
- Stacks 5 high on the floor.
- Standard with glides, Black or Fog.
- COM yardage / COL square footage:
 Fully Upholstered: 1.5/13
 Upholstered seat: .75/7.25

To Order, Specify:

1) Product number.

1 Seat or Seat Pad Option:

- 1 Leather
- 2 Fabric
- 3 Faux Leather
- 4 Polymer

2 Glide Option:

- H Plastic Glide
- K Felt Glide

2) Fabric surface and color (seat).

3) Shell color - required for upholstered and non-upholstered.

4) Trim for arm caps (if specified) and glides.

5) Frame trim color.

Trivalent Chrome (KR-V) add **\$181.33** list.

Stain Repellent Upholstery:

Add a **P** to the end of the catalog code, and add **\$36.26** list.

Example: SCL-25-0HEP

Description	Number		Price	Fabric Grade		C	D	E	F	G	H	Leather Grade A	Leather Grade B
	1	2		A	B								
Tetro Back Without Optional Upholstered Pad													
With Arms	SCL- 4	5-3	\$675.01	N/A	N/A	N/A	N/A	N/A	N/A	N/A	N/A	N/A	N/A
Without Arms	SCL- 4	5-0	614.18	N/A	N/A	N/A	N/A	N/A	N/A	N/A	N/A	N/A	N/A
Tetro Back With Upholstered Seat Pad													
With Arms	SCL- 4	5-3 E	N/A	\$727.65	\$761.57	\$797.85	\$814.22	\$829.42	\$859.84	\$889.09	\$966.31	\$884.41	\$1024.61
Without Arms	SCL- 4	5-0 E	N/A	666.82	700.74	737.02	753.39	768.59	799.01	828.26	905.48	823.58	963.78

Very

Counter Height Side Stool – Tetro Back

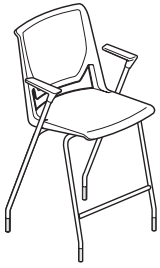

SCLC-45-3H

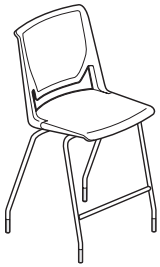

SCLC-45-0H

Dimensions

SH: 25.75"(654mm)
 H: 42.25"(1073mm)
 W: 23.75"(604mm)
 D: 21.7"(551mm)
 SW: 18.75"(477mm)
 SD: 17.2"(434mm)
 AH: 8.9"(226mm)

Between Arms:
 19.6"(498mm)

Features

- Back: High-strength polymer back with injection molded technology.
- Seat: High-strength polymer seat with an optional upholstery pad.
- Upholstered seat features 1"(25.4mm) foam pad.
- Arms: Black or Fog high-strength polymer arm caps.
- Base: available painted or optional trivalent chrome.
- Stacks 5 high on the floor.
- Standard with glides, Black or Fog.
- COM yardage / COL square footage:
 Fully Upholstered: 1.5/13
 Upholstered seat: .75/7.25

To Order, Specify:

1) Product number.

1 Seat or Seat Pad Option:

- 1 Leather
- 2 Fabric
- 3 Faux Leather
- 4 Polymer

2 Glide Option:

- H Plastic Glide
- K Felt Glide

- 2) Fabric surface and color (seat).
 - 3) Shell color - required for upholstered and non-upholstered.
 - 4) Trim for arm caps (if specified) and glides.
 - 5) Frame trim color.
- Trivalent Chrome (KR-V) add **\$181.33** list.

Stain Repellent Upholstery:

Add a **P** to the end of the catalog code, and add **\$36.26** list.
Example: SCLC-25-0HEP

Description	Number		Price	Fabric Grade		C	D	E	F	G	H	Leather Grade A	Leather Grade B
	1	2		A	B								
Tetro Back Without Optional Upholstered Pad													
With Arms	SCLC-	4 5-3	\$675.01	N/A	N/A	N/A	N/A	N/A	N/A	N/A	N/A	N/A	N/A
Without Arms	SCLC-	4 5-0	614.18	N/A	N/A	N/A	N/A	N/A	N/A	N/A	N/A	N/A	N/A
Tetro Back With Upholstered Seat Pad													
With Arms	SCLC-	5-3 E	N/A	\$727.65	\$761.57	\$797.85	\$814.22	\$829.42	\$859.84	\$889.09	\$966.31	\$884.41	\$1024.61
Without Arms	SCLC-	5-0 E	N/A	666.82	700.74	737.02	753.39	768.59	799.01	828.26	905.48	823.58	963.78

Very

Seminar Chair – Tetro Back

With Arms



SCM-45-3H

Dimensions

- SH: 18.2"(461mm)*
- H: 33.9"(861mm)
- D: 22"(559mm)
- W: 23.5"(597mm)
- SW: 19.2"(487mm)*
- SD: 17.5"(443mm)*
- AH: 8.9"(226mm)*
- Between Arms: 19.6"(498mm)

Features

- Back: High-strength polymer back with injection molded technology.
- Seat: High-strength polymer seat with an optional upholstery pad.
- Weight assisted recline mechanism.
- Upholstered seat features 1"(25.4mm) foam pad.
- Arms: Black or Fog glass-filled polypropylene arm caps.
- Frame: available painted or trivalent chrome.
- Casters: Hard (black), soft (black) or two-tone (fog and gray).
- Glides: Plastic or felt.
- Stacks 5 high on the floor and 8 high on a cart
- COM yardage / COL square footage:
Upholstered seat: .75/7.25

*All measurements taken with the BIFMA chair measuring device.

To Order, Specify:

1) Product number, including;

1 Seat or Seat Pad Option:

- 1 Leather
- 2 Fabric
- 3 Faux Leather
- 4 Polymer

2 Glide or Caster Option:

- H Plastic Glide
- K Felt Glide
- 1 Hard Casters, add **\$53.81** list
- 2 Soft Casters, add **\$53.81** list
- T Two-Tone Casters, add **\$53.81** list

- 2) Fabric surface and color (seat).
- 3) Shell color – required for upholstered and non-upholstered.
- 4) Trim for arm caps, glides, and plastic components.
- 5) Frame trim color.
Trivalent Chrome (KR-V) add **\$181.33** list.

Stain Repellent Upholstery:

Add a **P** to the end of the catalog code, and add **\$36.26** list.

Example: SCM-25-3HEP

Description	Number		Price	Fabric Grade								Leather Grade A	Leather Grade B
	1	2		A	B	C	D	E	F	G	H		
Tetro Back Without Optional Upholstered Pad													
	SCM-	4 5 -3	\$560.35	N/A	N/A	N/A	N/A	N/A	N/A	N/A	N/A	N/A	N/A
Tetro Back With Upholstered Seat Pad													
	SCM-	5 -3	N/A	\$617.67	\$651.59	\$687.87	\$704.24	\$719.44	\$749.86	\$779.11	\$856.33	\$774.43	\$914.63

Very

Seminar Chair – Tetro Back

Without Arms



SCM-45-0H

Dimensions

- SH: 18.2"(461mm)*
- H: 33.9"(861mm)
- D: 22"(559mm)
- W: 22.3"(566mm)
- SW: 19.2"(487mm)*
- SD: 17.5"(443mm)*

Features

- Back: High-strength polymer back with injection molded technology.
- Seat: High-strength polymer seat with an optional upholstery pad.
- Weight assisted recline mechanism.
- Upholstered seat features 1"(25.4mm) foam pad.
- Arms: Black or Fog glass-filled polypropylene arm caps.
- Frame: available painted or trivalent chrome.
- Casters: Hard (black), soft (black) or two-tone (fog and gray).
- Glides: Plastic or felt.
- Stacks 5 high on the floor and 8 high on a cart
- COM yardage / COL square footage:
Upholstered seat: .75/7.25

*All measurements taken with the BIFMA chair measuring device.

To Order, Specify:

1) Product number, including;

1 Seat or Seat Pad Option:

- 1** Leather
- 2** Fabric
- 3** Faux Leather
- 4** Polymer

2 Glide or Caster Option:

- H** Plastic Glide
- K** Felt Glide
- 1** Hard Casters, add **\$53.81** list
- 2** Soft Casters, add **\$53.81** list
- T** Two-Tone Casters, add **\$53.81** list

- 2) Fabric surface and color (seat).
 - 3) Shell color – required for upholstered and non-upholstered.
 - 4) Glide and plastic component trim color.
 - 5) Frame trim color.
- Trivalent Chrome (KR-V) add **\$181.33** list.

Stain Repellent Upholstery:

Add a **P** to the end of the catalog code, and add **\$36.26** list.
Example: SCM-25-0HEP

Description	Number		Price	Fabric Grade								Leather Grade A	Leather Grade B
	1	2		A	B	C	D	E	F	G	H		
Tetro Back Without Optional Upholstered Pad													
	SCM-	4 5 -0	\$499.52	N/A	N/A	N/A	N/A	N/A	N/A	N/A	N/A	N/A	N/A
Tetro Back With Upholstered Seat Pad													
	SCM-	5 -0 E	N/A	\$556.84	\$590.76	\$627.04	\$643.41	\$658.61	\$689.03	\$718.28	\$795.50	\$713.60	\$853.80

Very

Seminar with Tablet Arm – Tetro Back

Seminar With Tablet Arm



SCM-45-RH

Dimensions

- SH: 18.2"(461mm)*
- H: 33.9"(861mm)
- W: 23.5"(597mm)
- D: 22"(559mm)
- SW: 19.2"(487mm)*
- SD: 17.5"(443mm)*

Features

- Back: High-strength polymer back with injection molded technology.
- Seat: High-strength polymer with an optional upholstery pad.
- Weight assisted recline mechanism.
- Upholstered seat features 1"(25.4mm) foam pad.
- Arm caps: Black.
- Tablet assembly painted black.
- Clearance from tablet to chair back 12.5"(318mm)-15.5"(394mm) angled.
- Flips up and fold away laminate tablet with matching laminate underside.
- Left or right-hand configurations.
- Tablet arm size: 15"W x 9.8"D (Sized to accommodate laptops).
- Base: available painted or optional trivalent chrome.
- Glides or Casters.
- Standard with hard casters, black or two-tone.
- Optional black soft casters.
- COM yardage / COL square footage:
Fully Upholstered: 1.5/13
Upholstered seat: .75/7.25

*All measurements taken with the BIFMA chair measuring device.

To Order, Specify:

- 1) Product number.
 - 1 Seat or Seat Pad Option:**
 - 1** Leather
 - 2** Fabric
 - 3** Faux Leather
 - 4** Polymer
 - 2 Arm or Tablet Option:**
 - R** Right-Hand Tablet Arm
 - L** Left-Hand Tablet Arm
 - 3 Glide or Caster Option:**
 - H** Plastic Glide
 - K** Felt Glide
 - 1** Hard Casters, add **\$53.81** list
 - 2** Soft Casters, add **\$53.81** list
 - T** Two-Tone Casters, add **\$53.81** list
- 2) Fabric surface and color (seat).
 - 3) Shell color - required for upholstered and non-upholstered.
 - 4) Glide and plastic component trim color.
 - 5) Frame trim color.
- Trivalent Chrome (KR-V) add **\$181.33** list.
- 6) Laminate for tablet (if specified).

Stain Repellent Upholstery:

Add a **P** to the end of the catalog code, and add **\$36.26** list.
Example: SCM-25-RHEP

Description	Number			Price	Fabric Grade		C	D	E	F	G	H	Leather Grade A	Leather Grade B
	1	2	3		A	B								
Tetro Back Without Optional Upholstered Pad														
SCM- 4 5- ■ ■				\$704.24	N/A	N/A	N/A	N/A	N/A	N/A	N/A	N/A	N/A	N/A
Tetro Back With Upholstered Seat Pad														
SCM- ■ 5- ■ ■ E			E	N/A	\$761.56	\$795.48	\$831.76	\$848.13	\$863.33	\$893.75	\$923.00	\$1000.22	\$918.32	\$1058.52

Seminar With Storage Rack

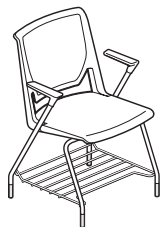

SCB-45-3H

Dimensions

- SH: 18.2"(461mm)*
- H: 33.9"(861mm)
- W: 23.5"(597mm)
- D: 22"(559mm)
- SW: 19.2"(487mm)*
- SD: 17.5"(443mm)*
- AH: 8.9"(226mm)*

Between Arms:
19.6"(498mm)

Features

- Back: High-strength polymer back with back with injection molded technology.
- Seat: High-strength polymer seat with an optional upholstery pad.
- Weight assisted recline mechanism.
- Upholstered seat features 1"(25.4mm) foam pad.
- Arms: Black or Fog arm caps.
- Storage rack available in Chrome only.
- Ships with chair, unassembled.
- Tablet assembly painted black.
- Flips up and fold away laminate tablet with matching laminate underside.
- Left or right-hand configurations.
- Tablet arm size: 15"W x 9.8"D (Sized to accommodate laptops).
- Base: available painted or optional trivalent chrome.
- Glides or Casters: Standard with hard casters, black or two-tone.
- Optional black soft casters.
- Weight: COM yardage / COL square footage:
Fully Upholstered: 1.5/13
Upholstered seat: .75/7.25

*All measurements taken with the BIFMA chair measuring device.

To Order, Specify:

1) Product number.

1 Seat or Seat Pad Option:

- 1** Leather
- 2** Fabric
- 3** Faux Leather
- 4** Polymer

2 Arm or Cap Option:

- 0** No Arms
- 3** Fixed Arm, Hard Caps, add **\$60.83** list

3 Glide or Caster Option:

- H** Plastic Glide
- K** Felt Glide
- 1** Hard Casters, add **\$53.81** list
- 2** Soft Casters, add **\$53.81** list
- T** Two-Tone Casters, add **\$53.81** list

- 2) Fabric surface and color (seat).
- 3) Shell color - required for upholstered and non-upholstered.
- 4) Trim for arm caps (if specified) and glides.
- 5) Frame trim color.
Trivalent Chrome (KR-V) add **\$181.33** list.
- 6) Laminate for tablet (if specified).

Stain Repellent Upholstery:

Add a **P** to the end of the catalog code, and add **\$36.26** list.

Example: SCB-25-OHEP

Description	Number 1 2 3	Price	Fabric Grade								Leather Grade A	Leather Grade B
			A	B	C	D	E	F	G	H		
Tetro Back Without Optional Upholstered Pad												
SCB- 4 5-	■ ■	\$575.55	N/A	N/A	N/A	N/A	N/A	N/A	N/A	N/A	N/A	N/A
Tetro Back With Upholstered Seat Pad												
SCB- 5-	■ ■ E	N/A	\$632.87	\$666.79	\$703.07	\$719.44	\$734.64	\$765.06	\$794.31	\$871.53	\$789.63	\$929.83

Very Tetro Back Conference Chair and Conference Stool

General Specifications

Features and Options (Conference Chair and Conference Stool)

- Back: High-strength polymer back with injection molded technology
- Seat: High-strength polymer seat with an optional upholstered foam pad
- Five-star base with casters: hard (black), soft (black) or two-tone (fog and gray)
- Base: painted aluminum, polished aluminum or plastic (fog or black)
- Frame finishes include: painted or polished aluminum
- Weight assisted recline mechanism
- Standard Pneumatic height adjustment
- Fog or black trim arm caps
- Arm or armless version available
- Adjustable footring in brushed aluminum (stool only)

General Guidelines for Product Specification

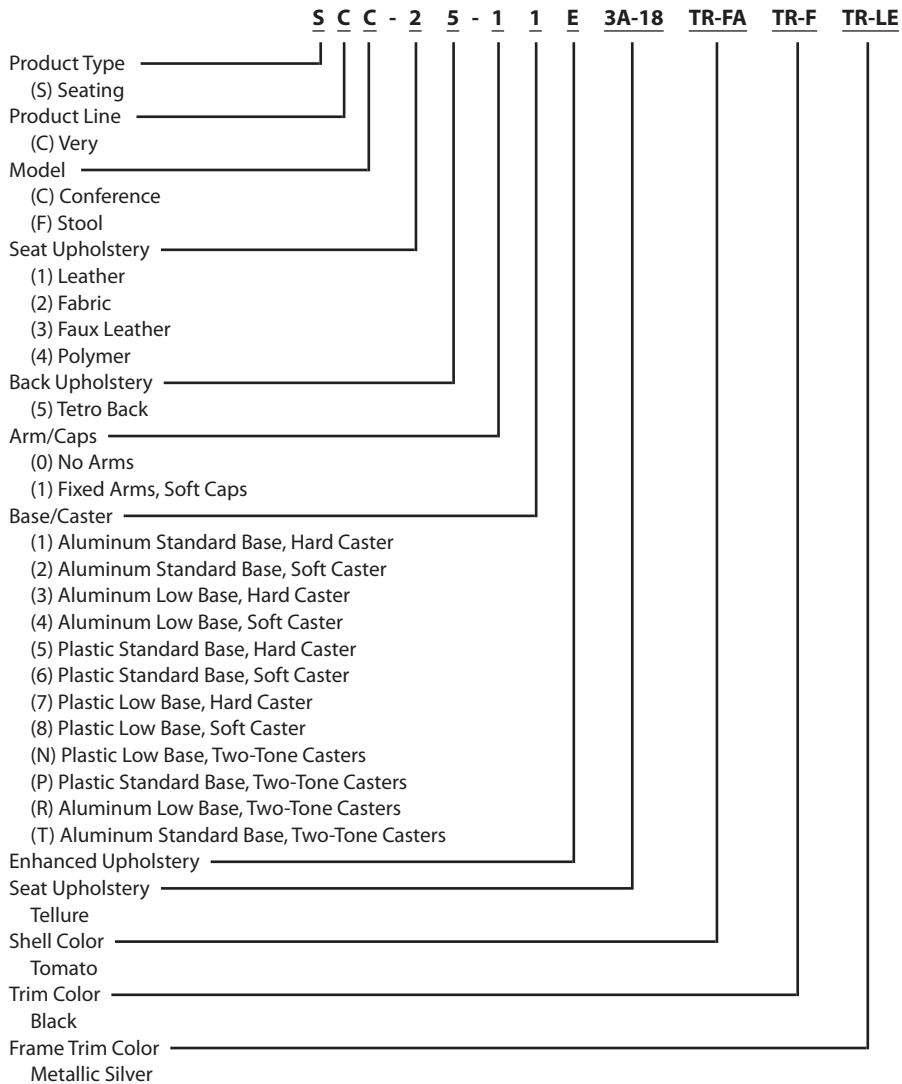

Very

Conference Chair - Tetro Back

With Arms



SCC-45-11

Dimensions

- SH: 15.5"(394mm)-20.5"(521mm)*
- H: 36.9"(937mm)
- D: 26.7"(678mm)
- W: 25"(635mm)
- SW: 19.2"(487mm)*
- SD: 17.5"(443mm)*
- AH: 8.7"(220mm)*
- Between Arms: 20.8"(528mm)

Features

- Back: High-strength polymer with injection molded technology.
- Seat: High-strength polymer with an optional upholstered foam pad.
- Upholstered seat features 1"(25.4mm) foam pad.
- Arms: Black or Fog glass-filled polypropylene soft arm caps.
- Base: Standard five-star all aluminum or all plastic base. Optional low-base range 14.4"(366mm)-19.4(493mm).
- 5"(127mm) height adjustment.
- Weight assisted recline mechanism.
- Casters: Hard (black), soft (black) or two-tone (fog and gray).
- Back tilts backward 14° from the upright position. Additional recline achieved in flexible back.
- Painted or optional polished aluminum.
- COM yardage / COL square footage:
Upholstered seat: .75/7.25

*All measurements taken with the BIFMA chair measuring device.

To Order, Specify:

1) Product number, including;

1 Seat or Seat Pad Option:

- 1 Leather
- 2 Fabric
- 3 Faux Leather
- 4 Polymer

2 Base/Caster Option:

Aluminum Base

- 1 Aluminum Std. Base, Hard Caster
- 2 Aluminum Std. Base, Soft Caster
- 3 Aluminum Low Base, Hard Caster
- 4 Aluminum Low Base, Soft Caster

Plastic Base

- 5 Plastic Std. Base, Hard Caster
- 6 Plastic Std. Base, Soft Caster
- 7 Plastic Low Base, Hard Caster
- 8 Plastic Low Base, Soft Caster

Two-Tone Casters

- N Plastic Low Base, Two-Tone Casters
- P Plastic Std. Base, Two-Tone Casters
- R Aluminum Low Base, Two-Tone Casters
- T Aluminum Std. Base, Two-Tone Casters

- 2) Fabric surface and color (seat).
- 3) Shell color – required for upholstered and non-upholstered.
- 4) Trim for arm caps, plastic components and base (plastic base only).
- 5) Trim color for frame, aluminum base and control housing.

Polished Aluminum (PM-P) add **\$181.33** list.

Stain Repellent Upholstery:

Add a **P** to the end of the catalog code, and add **\$36.26** list.
Example: SCC-25-11EP

Tetro Back - Aluminum Base	Number		Price	Fabric Grade								Leather Grade A	Leather Grade B	
	1	2		A	B	C	D	E	F	G	H			
Without Optional Upholstered Pad														
	SCC-	4 5 -1	\$905.46	N/A	N/A	N/A	N/A	N/A	N/A	N/A	N/A	N/A	N/A	N/A
With Upholstered Seat Pad														
	SCC-	5 -1 E	N/A	\$968.64	\$1002.56	\$1038.84	\$1055.21	\$1070.41	\$1100.83	\$1130.08	\$1207.30	\$1125.40	\$1265.60	

Tetro Back - Plastic Base	Number		Price	Fabric Grade								Leather Grade A	Leather Grade B	
	1	2		A	B	C	D	E	F	G	H			
Without Optional Upholstered Pad														
	SCC-	4 5 -1	\$784.97	N/A	N/A	N/A	N/A	N/A	N/A	N/A	N/A	N/A	N/A	N/A
With Upholstered Seat Pad														
	SCC-	5 -1 E	N/A	\$848.15	\$882.07	\$918.35	\$934.72	\$949.92	\$980.34	\$1009.59	\$1086.81	\$1004.91	\$1145.11	

Very

Conference Chair - Tetro Back

Without Arms



SCC-45-01

Dimensions

- SH: 15.5"(394mm)-20.5"(521mm)*
- H: 36.9"(937mm)
- D: 26.7"(678mm)
- W: 19.4"(493mm)
- SW: 19.2"(487mm)*
- SD: 17.5"(443mm)*

Features

- Back: High-strength polymer with injection molded technology.
- Seat: High-strength polymer with an optional upholstered foam pad.
- Upholstered seat features 1"(25.4mm) foam pad.
- Base: Standard five-star all aluminum or all plastic base. Optional low-base range 14.4"(366mm)-19.4(493mm)
- 5"(127mm) height adjustment.
- Weight assisted recline mechanism.
- Casters: Hard (black), soft (black) or two-tone (fog and gray).
- Back tilts backward 14° from the upright position. Additional recline achieved in flexible back.
- Painted or optional polished aluminum.
- COM yardage / COL square footage:
Upholstered seat: .75/7.25

*All measurements taken with the BIFMA chair measuring device.

To Order, Specify:

1) Product number, including;

1 Seat or Seat Pad Option:

- 1 Leather
- 2 Fabric
- 3 Faux Leather
- 4 Polymer

2 Base/Caster Option:

Aluminum Base

- 1 Aluminum Std. Base, Hard Caster
- 2 Aluminum Std. Base, Soft Caster
- 3 Aluminum Low Base, Hard Caster
- 4 Aluminum Low Base, Soft Caster

Plastic Base

- 5 Plastic Std. Base, Hard Caster
- 6 Plastic Std. Base, Soft Caster
- 7 Plastic Low Base, Hard Caster
- 8 Plastic Low Base, Soft Caster

Two-Tone Casters

- N Plastic Low Base, Two-Tone Casters
- P Plastic Std. Base, Two-Tone Casters
- R Aluminum Low Base, Two-Tone Casters
- T Aluminum Std. Base, Two-Tone Casters

- 2) Fabric surface and color (seat).
- 3) Shell color – required for upholstered and non-upholstered.
- 4) Trim for arm caps, plastic components and base (plastic base only).
- 5) Trim color for frame, aluminum base and control housing.

Polished Aluminum (PM-P) add **\$181.33** list.

Stain Repellent Upholstery:

Add a **P** to the end of the catalog code, and add **\$36.26** list.
Example: SCC-25-01EP

Tetro Back - Aluminum Base	Number		Price	Fabric Grade								Leather Grade A	Leather Grade B
	1	2		A	B	C	D	E	F	G	H		
Without Optional Upholstered Pad													
	SCC-	4 5 -0	\$832.93	N/A	N/A	N/A	N/A	N/A	N/A	N/A	N/A	N/A	N/A
With Upholstered Seat Pad													
	SCC-	5 -0	N/A	\$896.11	\$930.03	\$966.31	\$982.68	\$997.88	\$1028.30	\$1057.55	\$1134.77	\$1052.87	\$1193.07

Tetro Back - Plastic Base	Number		Price	Fabric Grade								Leather Grade A	Leather Grade B
	1	2		A	B	C	D	E	F	G	H		
Without Optional Upholstered Pad													
	SCC-	4 5 -0	\$712.44	N/A	N/A	N/A	N/A	N/A	N/A	N/A	N/A	N/A	N/A
With Upholstered Seat Pad													
	SCC-	5 -0	N/A	\$775.62	\$809.54	\$845.82	\$862.19	\$877.39	\$907.81	\$937.06	\$1014.28	\$932.38	\$1072.58

Very

Conference Stool – Tetro Back



SCF-45-11



SCF-45-01

Dimensions

SH: 23"-32"
(584mm-813mm)
W: 25"(635mm)
D: 26.7"(678mm)
SW: 18.7"(477mm)
SD: 17.2"(434mm)
AH: 8.7"(221mm)

Between Arms:
20.8"(528mm)

Features

- Back: High-strength polymer with injection molded technology.
- Seat: High-strength polymer with an optional upholstered foam pad.
- Weight assisted recline mechanism.
- Upholstered seat features 1"(25.4mm) foam pad.
- Arms: Black or Fog hard arm caps.
- Base: Standard five-star all aluminum or all plastic base.
- Footring: Brushed Aluminum finish.
- Adjustable footring: adjusts 4"(102mm) up and down.
- Casters: Standard with hard casters, black or two-tone.
- Optional black soft casters.
- COM yardage / COL square footage:
Fully Upholstered: 1.5/13
Upholstered seat: .75/7.25

To Order, Specify:

1) Product number.

1 Seat or Seat Pad Option:

- 1** Leather
- 2** Fabric
- 3** Faux Leather
- 4** Polymer

2 Arm or Cap Option:

- 0** No Arms
- 1** Fixed Arm, Hard Caps, add **\$145.06** list

3 Base or Caster Option:

Aluminum Base

- 1** Aluminum Std. Base, Hard Casters
- 2** Aluminum Std. Base, Soft Casters
- T** Aluminum Std. Base, Two-Tone Casters

Plastic Base

- 5** Plastic Std. Base, Hard Casters
- 6** Plastic Std. Base, Soft Casters
- P** Plastic Std. Base, Two-Tone Casters

- 2) Fabric surface and color (seat).
- 3) Fabric surface and color (back).
- 4) Shell color - required for upholstered and non-upholstered.
- 5) Trim for arm caps (if specified). (base if plastic is specified above).
- 6) Frame trim color- Aluminum components (base if aluminum and arm uprights).

Polished Aluminum (PM-P) add **\$181.33** list.

Stain Repellent Upholstery:

Add a **P** to the end of the catalog code, and add **\$36.26** list.

Example: SCF-25-11EP

Description	Number			Price	Fabric Grade								Leather Grade A	Leather Grade B
	1	2	3		A	B	C	D	E	F	G	H		
Aluminum Base Without Optional Upholstered Pad														
SCF- 4 5-	■	■		\$1175.70	N/A	N/A	N/A	N/A	N/A	N/A	N/A	N/A	N/A	N/A
Aluminum Base With Upholstered Seat Pad														
SCF- ■ 5-	■	■	E	N/A	\$1238.88	\$1272.80	\$1309.08	\$1325.45	\$1340.65	\$1371.07	\$1400.32	\$1477.54	\$1395.64	\$1535.84
Plastic Base Without Optional Upholstered Pad														
SCF- 4 5-	■	■		\$1055.21	N/A	N/A	N/A	N/A	N/A	N/A	N/A	N/A	N/A	N/A
Plastic Base With Upholstered Seat Pad														
SCF- ■ 5-	■	■	E	N/A	\$1118.39	\$1152.31	\$1188.59	\$1204.96	\$1220.16	\$1250.58	\$1279.83	\$1357.05	\$1275.15	\$1415.35

Very

Accessories

	Description	Number	Price
Wire Stacker Storage Rack	Storage Rack	SCHR-1	\$76.03

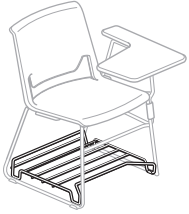

SCHR-1
Class VY – SIN 711-18;
Discount Group XVIII

Features

- Chrome only.
- Recommended for use with Chrome chairs for durability and common finishes.
- Ships separate from chair (installation clips included).

To Order, Specify:

- 1) Product number.
(No finish specification required.)

Wire Stacker Tablet Arm	Right Tablet Arm	SCHA-R	\$163.78
	Left Tablet Arm	SCHA-L	\$163.78

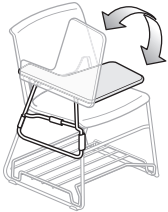

SCHA-R
Class VY – SIN 711-18;
Discount Group XVIII

Features

- Ships unassembled.
- Flips up for access.
- Tablet assembly chrome.
- Clearance from tablet to chair back 12.5"(318mm)-15.5"(394mm) angled.
- Recommended for use with Chrome chairs for durability and common finishes.
- Laminate tablet with matching laminate underside.
- Tablet arm size: 15"W x 9.8"D (Sized to accommodate laptops).
- Left or right-hand configurations.

To Order, Specify:

- 1) Product number.
- 2) Laminate surface specification.

Note: Tool from 2474-7601 required for installation. Every order for 1-30 chairs will come with 1 installation tool (ie, a 90 chair order will come with 3 tools).

Ganging Connector	Arm to Armless and Armless to Armless	SCSG-1	\$15.20
	Arm to Arm	SCSG-2	\$15.94

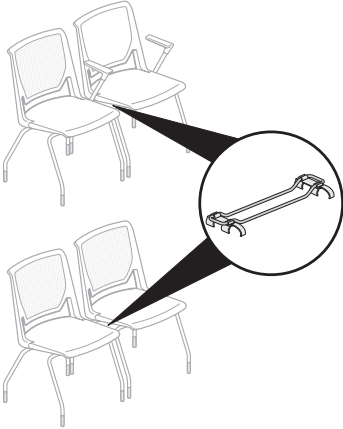

SCSG-1

Features



- Field retrofittable.
- Recommended for use on chairs with glides only.
- Release for fire safety.

To Order, Specify:

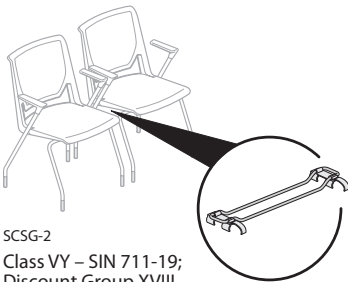
- 1) Product number.
(No finish specification required.)



SCSG-2
Class VY – SIN 711-19;
Discount Group XVIII

	Description	Number	Price
Stacking Carts			
 SCT-1	Stacking Cart	SCT-1	\$460.93
	Features <ul style="list-style-type: none"> Stacking Heights: <ul style="list-style-type: none"> With or Without Arms: <ul style="list-style-type: none"> -40 chairs on cart (75 1/2" high x 39 1/2" deep x 24" wide) -10 chairs on the floor (39 1/4" high x 23" wide x 33" deep) Upholstered Seat: <ul style="list-style-type: none"> -25 maximum stack quality on cart -25 armless on cart (61" high x 40 1/2" deep x 24" wide) -25 with arms on cart (69" high x 38" deep x 24" wide) Standard in black finish color only. Not for use with Wire Stacker stools. 	To Order, Specify: <ul style="list-style-type: none"> 1) Product number. (No color specification required.) 	
Stacking Carts			
 SCT-3 SCT-4	Side/Seminar Chairs with Arms	SCT-3	\$386.06
	Side/Seminar Chairs without Arms	SCT-4	386.06
	Features <ul style="list-style-type: none"> Permits stacking 8-high with glides and casters. Standard in black finish color only. Cart Only Dimensions: <ul style="list-style-type: none"> -SCT-3 25.5"(648mm) x 27"(685mm) x 13.8"(352mm) (wt: 10.09kg) -SCT-4 25.5"(648mm) x 30"(772mm) x 14.1"(359mm) (wt: 10.09kg) Not for use with Side Stools. 	To Order, Specify: <ul style="list-style-type: none"> 1) Product number. (No color specification required.) 	

This page intentionally blank

Very Task

General Specifications

At-A-Glance

The Very Task chair offers state-of-the-art ergonomic support, at a sensible price point. Very Task offers Haworth's patented asymmetrical lumbar along with supporting mesh. A clean simple aesthetic, with unlimited choices, allowing you to personalize how you want to sit and work.

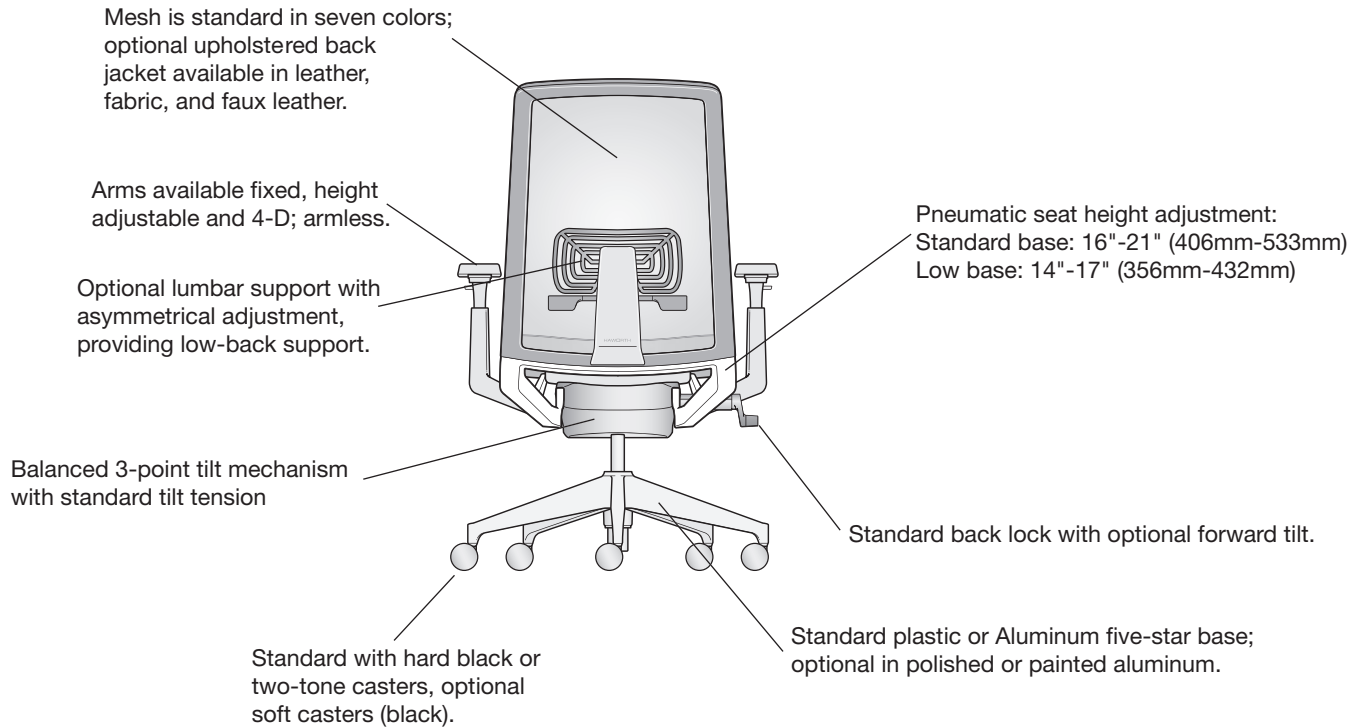

Very Task

General Specifications

Features and Options (Task Chair)

- Back: Mesh with optional upholstered back jacket.
- Seat: Standard upholstered with foam.
- Seat Type: Standard depth adjustable range 16"-19" (406mm-483mm).
- Base: Standard plastic or optional painted five-star aluminum base or optional polished aluminum.
- Optional low base 14"-17"(356mm-432mm) (not available in high polished)
- Arms: 4D, Height Adjustable arms, fixed arms with soft arm caps. Armless model available.
- Mechanism: Balanced 3-point tilt; standard tilt tension.
- Height adjustment: Pneumatic or low-position pneumatic.
- Standard Back lock.
- Optional Forward Tilt: 5 degrees downward from initial position.
- Optional Adjustable Lumbar: 4" adjustment, flexible support.
- Optional Headrest: Height adjustable with articulating movement.
- Casters: Five-star base with casters: hard (black or two-tone (fog and gray), soft (black).
- Headrest sent not attached.

General Guidelines for Product Specification

	<u>S</u>	<u>C</u>	<u>T - 2</u>	<u>0 - 4</u>	<u>1</u>	<u>1</u>	<u>1</u>	<u>3A-18</u>	<u>MS-FM</u>	<u>TR-F</u>	<u>TR-LE</u>	<u>TR-LE</u>
Product Fixed Arm												
(S) Seating												
Product Line												
(C) Very												
Model												
(E) Headrest												
(T) Task												
Seat Upholstery												
(1) Leather												
(2) Fabric												
(3) Faux Leather												
Mesh Back												
(0) Mesh - No Jacket												
(1) Leather Back Jacket												
(2) Fabric Back Jacket												
(3) Faux Leather Back Jacket												
Arms												
(0) No Arms												
(1) Fixed Arms												
(4) Height Adjustable												
(7) 4D Arms												
Lumbar												
(0) No Lumbar												
(1) Lumbar												
Back Lock												
(1) Back Lock												
(4) Forward Tilt/Back Lock												
Base/Caster												
(1) Aluminum Standard Base, Hard Caster												
(2) Aluminum Standard Base, Soft Caster												
(3) Aluminum Low Base, Hard Caster												
(4) Aluminum Low Base, Soft Caster												
(5) Plastic Standard Base, Hard Caster												
(6) Plastic Standard Base, Soft Caster												
(P) Plastic Standard Base, Two-Tone Caster												
(T) Aluminum Standard Base, Two-Tone Caster												
Seat Upholstery												
Tellure												
Back Upholstery												
Mesh Snow												
Trim Color (Plastic Components)												
Black												
Frame Trim Color (Aluminum)												
Metallic Silver												
Base Trim Color (Plastic or Aluminum)												
Metallic Silver												

Very Task

General Specifications

Environmental Factors	<ul style="list-style-type: none"> • Very Task is BIFMA level 3 certified. • Greenguard Gold certified for low emissions. • Very has up to 65% recycled content and is up to 98% recyclable. • Very is produced in an ISO 14001 certified manufacturing facility. • Very Task is part of the Haworth Take Back Program. • Haworth will take back Very chairs after their useful life and recycle the components. Please contact Haworth's Material Recovery Center at (616)393-1215.
COM & COL General Information	<p>To order a COM fabric (Customer's Own Material), contact the Haworth Inquiry Center (1.800.426.8562), your local Haworth dealer, or go to haworth.com/surfaces > COM Library to find out if the COM you have selected has already been tested and approved. The surface collection site also has information on the Haworth+ alliance program with Carnegie, Luna Textiles, and Maharam as well as our industry-leading Pre-Approved COM program.</p> <p>COM fabrics are placed into Grades based on the cost per linear yard. If a fabric's cost exceeds the range of our highest Grade it will be noted as Non-Graded. The product will be priced at Grade A; the COM fabric costs will appear as a separate line item. The fabric charge will be Haworth's purchase cost plus a 4% administrative fee (based on the cost of the fabric). Yardage calculations will include any applicable fabric repeat.</p> <p>COM Leather products will be priced at a leather Grade A; COL costs will appear as a separate line item. The leather costs will be Haworth's purchase cost plus a 4% administrative fee (based on the cost of the leather).</p>
Finishes and Fabrics	A complete listing of finishes and fabrics for Very seating is available in the back of the price list.
Shipping Weights (Including packaging)	<ul style="list-style-type: none"> • Chairs with arms: 55.2 pounds/1 chair per carton/17.37 cubic feet • Chairs without arms: 51.2 pounds/1 chair per carton/17.37 cubic feet
Seat	Stitched double seams. Vertically in the center and on the edges of the leather seat cushion.
Back	Vertical stitched double seams on the upholstered back jacket with leather and faux leather or Customers Own Leather or COM faux leather.

Very Task

General Specifications

STANDARD MOBILITY AND ADJUSTABILITY

Balanced 3-point tilt



Features:

- Balanced 3-point tilt mechanism.
- Back reclines 20° from the upright position.
- Seat pan moves downward 3° from the initial position.
- 2:1 recline ratio.

Benefits:

- Comfortable relaxed posture.
- Recline allows for the opening of the users' chest cavity providing good airflow to promote alertness.
- Users' feet remain flat on the floor.

Tilt Tension Control

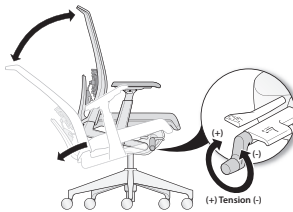

Feature:

- Easy-to-reach and easy-to-activate side-mounted unlimited tilt tension control regulates the amount of resistance felt when leaning back in the chair and the effort required to recline the chair backwards.

Benefit:

- Personalized support to accommodate users of different body types and different work styles.

Seat Height Adjustment

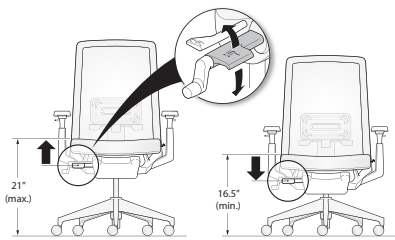

Features:

- Pneumatic seat height adjustment.
- Seat height adjusts 5"(127mm) from 16" to 21"(406mm to 533mm) in standard models. Low-position adjusts 14" to 17"(356 to 432mm).

Benefits:

- Ensures the comfort of the lower limbs by avoiding pressure on the underside of the thigh caused by a seat pan that is too high, or decreased thigh-to-torso angle if the seat pan is too low.
- Seat height adjustment also is important in setting the proper hand position and allowing for a proper sitting eye height.

Seat Depth Adjustment

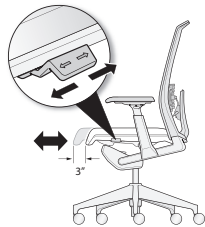

Features:

- 3"(76mm) of seat depth range.

Benefit:

- Supports the thighs, allows users to rest against the seat back for back support, and avoids pressure on the back of the knees of small to tall users.

Back Lock

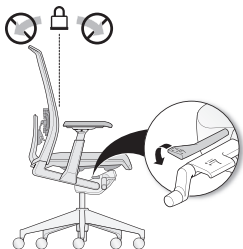

Feature:

- Single position Back Lock.

Benefit:

- Allows users to lock the back of the chair in the upright position for tasking application.

Very Task

General Specifications

OPTIONAL MOBILITY AND ADJUSTABILITY

Lumbar Support**Features:**

- Asymmetrical Left/right Lumbar Adjustment adjusts 4"(102mm) in height, flexible lumbar support with depth adjustment.

Benefits:

- Lumbar adjustment maintains the natural curvature of the spine at the lower back and allows users to choose the support that feels right for them.

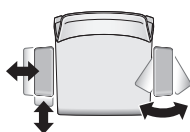
4D Arm**Features:**

- Optional 4D arm.
- Arm adjusts in 4 ways:
 - Height adjustment: 4"(102mm)
 - Side-to-side arm cap adjustment range: 3"(76mm) [1.5"(38.1mm) each arm cap]
 - Front-to-back adjustment range: 3 1/2"(89mm)
 - Pivoting: In 20°; out 20°

Benefits:

- Arms support the muscular system of users' neck and shoulders and proper arm support provides back relief. Arms can be an aid in standing or sitting down.
- Height adjustment accommodates for users with varying elbow rest heights so that users avoid lifting their shoulders or leaning sideways to get arm support.
- Front-to-back adjustment adjusts the armrest length, which is important because it allows users to get close to the worksurface while maintaining the effective use of the backrest.
- Side-to-side adjustment ensures a comfortable resting position for the arms with proper support of the forearm while allowing for easy entry/exit of the chair.
- Pivoting provides proper support of the forearm when performing tasks involving keying and mousing.

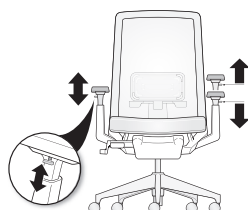
Adjustable Height Arm**Feature:**

- Optional height adjustable arms adjust 4"(102mm) vertically.

Benefit:

- Height adjustment accommodates users with varying elbow rest heights so that users avoid lifting their shoulders or leaning sideways to get arm support.

Forward Tilt**Features:**

- Optional forward tilt.
- 5°

Benefit:

- Allows users the ability to elect an upright forward position.

Headrest**Features:**

- Height adjustable 4.2"(107mm), articulating movement of headrest pad and mount to fit a wide range of users.
- Headrest is TPU material. Available in two finishes; Black or fog, coordinates with the chair's arm rest color specified.
- See price pages for specification (available on all models).
- To add a headrest to an existing model in the field order service part: Back and Headrest placement, see e-Parts.
- Headrest sent not attached.

Very Task Value Model

Task Chair with 4D Arms

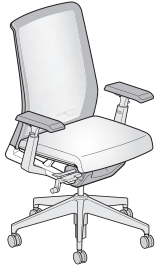

SCT-20-7115

Dimensions

- *SH: 16-21"
(406mm-533mm)
- H: 39-44"
(991mm-1118mm)
- D: 26"(660mm)
- W: 27"(686mm)
- *SW: 19"(483mm)

* Measurements taken with the BIFMA chair measuring device.

Features

- Back: Soft mesh.
- Seat: Standard upholstered foam (3 lbs. polyurethane foam construction).
- Seat Depth Adjustment: Standard adjustable range 16"-19" (406mm-483mm).
- Base: Plastic base.
- Arms: 4D with soft arm caps. Arm adjusts up and down, side to side.
- Mechanism: Balanced 3-point tilt; standard tilt tension.
- Back Lock: Single position upright back lock.
- Asymmetrical Lumbar Adjustment: 4"(102mm) height adjustment; support level can be adjusted independently for right or left hand side of users body.
- Casters: Hard black
 - Available on RUSH.

To Order, Specify:

- 1) Product number.
- 2) Seat surface/color: 3A-18 Tellure - Black
- 3) Mesh Back: MS-F Black
- 4) Plastic trim color (including base): TR-F Black
- 5) Aluminum trim color: TR-F Black

Note: No changes to specification. No COM or Tailored Solutions.

Number

SCT-20-7115 ■

Price

\$784.24

This page intentionally blank

Very Task

Task Chair with 4D Arms



SCT-20-7011

Dimensions

*SH: 16-21"(406mm-533mm)
 H: 39-44"(991mm-1118mm)
 D: 26"(660mm)
 W: 27"(686mm)
 *SW: 19"(483mm)

Low Base:
 14-17"(356mm-432mm)

* Measurements taken with the BIFMA chair measuring device.

Features

- Back: Soft mesh or mesh back with upholstered back jacket.
- Seat: Standard upholstered foam (3 lbs. polyurethane foam construction).
- Seat Depth Adjustment: Standard adjustable range 16"-19" (406mm-483mm).
- Base: Plastic base or optional painted five-star aluminum or polished aluminum base.
- Arms: 4D with soft arm caps. Arm adjusts up and down, side to side.
- Mechanism: Balanced 3-point tilt; standard tilt tension.
- Back Lock: Single position upright back lock.
- Optional Forward Tilt: 5 degrees downward from initial position.
- Optional Asymmetrical Lumbar Adjustment: 4"(102mm) height adjustment; support level can be adjusted independently for right or left hand side of users body.
- Casters: Standard with hard black or two-tone casters; optional soft casters.
- COM yardage / COL square footage:
 Mesh back model: 0.83/20
 Mesh back/upholstered back jacket: 1.5/40

NOTE: When specifying a back jacket; must also specify mesh surface color for outside of back. Back jacket is not field retrofittable. To add a back jacket in the field, see e-Parts for replacement back with an attached jacket.

■ Available on RUSH.

To Order, Specify:

1) Product number, including:

1 Base/Caster Option:**Aluminum Base**

- 1** Aluminum Std. Base, Hard Caster
- 2** Aluminum Std. Base, Soft Caster
- T** Aluminum Std. Base, Two-Tone Casters
- 3** Aluminum Low Base, Hard Caster
- 4** Aluminum Low Base, Soft Caster

Plastic Base

- 5** Plastic Std. Base, Hard Caster
- 6** Plastic Std. Base, Soft Caster
- P** Plastic Std. Base, Two-Tone Casters

- 2) Fabric surface and color (seat).
- 3) Mesh surface and color (back).
- 4) Back Jacket (if applicable) Fabric surface and color.
- 5) Trim color (plastic components) (arm caps, control cover, adjustment levers, 4D or height adjustable arm uprights).

Note: If TR-UFM is specified, arm caps and adjustment levers default to TR-7 Fog. (Add **\$91.25** list for TR-UFM Snow.)

- 6) Frame trim color (aluminum components - underside of chair).
- 7) Base trim color (plastic or aluminum) dependent upon base style selected; TR-UFM Snow (plastic) and TR-FS Snowfall (aluminum) not available.

Note: If PM-P Polished Aluminum is selected for aluminum frame components (#6) or aluminum base (#7), or both, a total upcharge of **\$187.47** list will apply.

Leather Seat with Mesh Back:

Change the fourth digit in the product number to **1**.

Example: SCT-10-7011

Leather Seat with Leather Upholstered Back Jacket:

Change the fourth and fifth digits in the product number to **11**.

Example: SCT-11-7011

Faux Leather Seat with Mesh Back:

Change the fourth digit in the product number to **3**.

Example: SCT-30-7011

Stain Repellent Upholstery:

Change the tenth digit in the product number to **P**, and add **\$37.50** list.

Example: SCT-20-7011**P**

Note: Stain repellent is available on SCT-20 and SCT-22 models only.

Very Task

Task Chair with 4D Arms

Upholstered Seat Adjustments	Number ①	Fabric Grade		C	D	E	F	G	H	Leather Grade A	Leather Grade B
		A	B								
Plastic Base - Mesh Back											
Back Lock	SCT-20-701	\$ 921.64	\$ 955.50	\$ 991.79	\$1008.73	\$1023.24	\$1054.69	\$1083.71	\$1161.12	\$1230.06	\$1381.02
Forward Tilt/Back Lock	SCT-20-704	988.17	1022.03	1058.32	1075.26	1089.77	1121.22	1150.24	1227.65	1296.59	1447.55
Plastic Base - Upholstered Back Jacket											
Back Lock	SCT-22-701	\$1048.64	\$1116.36	\$1188.94	\$1222.82	\$1251.84	\$1314.74	\$1372.78	\$1527.60	\$1665.48	\$1967.40
Forward Tilt/Back Lock	SCT-22-704	1115.17	1182.89	1255.47	1289.35	1318.37	1381.27	1439.31	1594.13	1732.01	2033.93
Plastic Base with Lumbar Adjustment - Mesh Back											
Back Lock	SCT-20-711	\$1006.31	\$1040.17	\$1076.46	\$1093.40	\$1107.91	\$1139.36	\$1168.38	\$1245.79	\$1314.73	\$1465.69
Forward Tilt/Back Lock	SCT-20-714	1072.84	1106.70	1142.99	1159.93	1174.44	1205.89	1234.91	1312.32	1381.26	1532.22
Plastic Base with Lumbar Adjustment - Upholstered Back Jacket											
Back Lock	SCT-22-711	\$1133.31	\$1201.03	\$1273.61	\$1307.49	\$1336.51	\$1399.41	\$1457.45	\$1612.27	\$1750.15	\$2052.07
Forward Tilt/Back Lock	SCT-22-714	1199.84	1267.56	1340.14	1374.02	1403.04	1465.94	1523.98	1678.80	1816.68	2118.60
Aluminum Base - Mesh Back											
Back Lock	SCT-20-701	\$ 982.12	\$1015.98	\$1052.27	\$1069.21	\$1083.72	\$1115.17	\$1144.19	\$1221.60	\$1290.54	\$1441.50
Forward Tilt/Back Lock	SCT-20-704	1048.65	1082.51	1118.80	1135.74	1150.25	1181.70	1210.72	1288.13	1357.07	1508.03
Aluminum Base - Upholstered Back Jacket											
Back Lock	SCT-22-701	\$1109.12	\$1176.84	\$1249.42	\$1283.30	\$1312.32	\$1375.22	\$1433.26	\$1588.08	\$1725.96	\$2027.88
Forward Tilt/Back Lock	SCT-22-704	1175.65	1243.37	1315.95	1349.83	1378.85	1441.75	1499.79	1654.61	1792.49	2094.41
Aluminum Base with Lumbar Adjustment - Mesh Back											
Back Lock	SCT-20-711	\$1066.79	\$1100.65	\$1136.94	\$1153.88	\$1168.39	\$1199.84	\$1228.86	\$1306.27	\$1375.21	\$1526.17
Forward Tilt/Back Lock	SCT-20-714	1133.32	1167.18	1203.47	1220.41	1234.92	1266.37	1295.39	1372.80	1441.74	1592.70
Aluminum Base with Lumbar Adjustment - Upholstered Back Jacket											
Back Lock	SCT-22-711	\$1193.79	\$1261.51	\$1334.09	\$1367.97	\$1396.99	\$1459.89	\$1517.93	\$1672.75	\$1810.63	\$2112.55
Forward Tilt/Back Lock	SCT-22-714	1260.32	1328.04	1400.62	1434.50	1463.52	1526.42	1584.46	1739.28	1877.16	2179.08

The following options require modification of the product number.

CAL 133
Headrest

To specify, add **F** to the end of the product number; **Example:** SCT-20-7011F (add **\$142.73** list)

To specify, change the 3rd digit from a T to an E. **Example:** SCE-22-7112 with headrest (add **\$84.67** list)

NOTE: CAL 133 is available on SCT-20 models only.

Very Task

Task Chair with Height Adjustable Arms



SCT-20-4011

Dimensions

*SH: 16-21"(406mm-533mm)
 H: 39-44"(991mm-1118mm)
 D: 26"(660mm)
 W: 27"(686mm)
 *SW: 19"(483mm)

Low Base:
 14-17"(356mm-432mm)

* Measurements taken with the BIFMA chair measuring device.

Features

- Back: Soft mesh only or mesh back with upholstered back jacket.
- Seat: Standard upholstered foam (3 lbs. polyurethane foam construction).
- Seat Depth Adjustment: Standard adjustable range 16"-19" (406mm-483mm).
- Base: Plastic base or optional painted five-star aluminum or polished aluminum base.
- Arms: Height-adjustable arms with plastic uprights (black or fog) with soft arm caps.
- Mechanism: Balanced 3-point tilt; standard tilt tension.
- Back Lock: Single position upright back lock.
- Optional Forward Tilt: 5 degrees downward from initial position.
- Optional Asymmetrical Lumbar Adjustment: 4"(102mm) height adjustment; support level can be adjusted independently for right or left hand side of users body.
- Casters: Standard with hard black or two-tone casters; optional soft casters.
- COM yardage / COL square footage:
 Mesh back model: 0.83/20
 Mesh back/upholstered back jacket: 1.5/40

NOTE: When specifying a back jacket; must also specify mesh surface color for outside of back. Back jacket is not field retrofittable. To add a back jacket in the field, see e-Parts for replacement back with an attached jacket.

- Available on RUSH.

To Order, Specify:

1) Product number, including:

1 Base/Caster Option:**Aluminum Base**

- 1** Aluminum Std. Base, Hard Caster
- 2** Aluminum Std. Base, Soft Caster
- T** Aluminum Std. Base, Two-Tone Casters
- 3** Aluminum Low Base, Hard Caster
- 4** Aluminum Low Base, Soft Caster

Plastic Base

- 5** Plastic Std. Base, Hard Caster
- 6** Plastic Std. Base, Soft Caster
- P** Plastic Std. Base, Two-Tone Casters

- 2) Fabric surface and color (seat).
- 3) Mesh surface and color (back).
- 4) Back Jacket (if applicable) Fabric surface and color.
- 5) Trim color (plastic components) (arm caps, control cover, adjustment levers, 4D or height adjustable arm uprights).

Note: If TR-UFM is specified, arm caps and adjustment levers default to TR-7 Fog. (Add **\$91.52** list for TR-UFM Snow.)

- 6) Frame trim color (aluminum components - underside of chair).
- 7) Base trim color (plastic or aluminum) dependent upon base style selected; TR-UFM Snow (plastic) and TR-FS Snowfall (aluminum) not available.

Note: If PM-P Polished Aluminum is selected for aluminum frame components (#6) or aluminum base (#7), or both, a total upcharge of **\$187.47** list will apply.

Leather Seat with Mesh Back:

Change the fourth digit in the product number to **1**.

Example: SCT-10-4011

Leather Seat with Leather Upholstered Back Jacket:

Change the fourth and fifth digits in the product number to **11**.

Example: SCT-11-4011

Faux Leather Seat with Mesh Back:

Change the fourth digit in the product number to **3**.

Example: SCT-30-4011

Stain Repellent Upholstery:

Change the tenth digit in the product number to **P**, and add **\$37.50** list.

Example: SCT-20-4011**P**

Note: Stain repellent is available on SCT-20 and SCT-22 models only.

Very Task

Task Chair with Height Adjustable Arms

Upholstered Foam Seat Adjustments	Number ①	Fabric Grade								Leather Grade A	Leather Grade B
		A	B	C	D	E	F	G	H		
Plastic Base - Mesh Back											
Back Lock	SCT-20-401	\$ 861.16	\$ 895.02	\$ 931.31	\$ 948.25	\$ 962.76	\$ 994.21	\$ 1023.23	\$ 1100.64	\$ 1169.58	\$ 1320.54
Forward Tilt/Back Lock	SCT-20-404	927.69	961.55	997.84	1014.78	1029.29	1060.74	1089.76	1167.17	1236.11	1387.07
Plastic Base - Upholstered Back Jacket											
Back Lock	SCT-22-401	\$ 988.16	\$ 1055.88	\$ 1128.46	\$ 1162.34	\$ 1191.36	\$ 1254.26	\$ 1312.30	\$ 1467.12	\$ 1605.00	\$ 1906.92
Forward Tilt/Back Lock	SCT-22-404	1054.69	1122.41	1194.99	1228.87	1257.89	1320.79	1378.83	1533.65	1671.53	1973.45
Plastic Base with Lumbar Adjustment - Mesh Back											
Back Lock	SCT-20-411	\$ 945.83	\$ 979.69	\$ 1015.98	\$ 1032.92	\$ 1047.43	\$ 1078.88	\$ 1107.90	\$ 1185.31	\$ 1254.25	\$ 1405.21
Forward Tilt/Back Lock	SCT-20-414	1012.36	1046.22	1082.51	1099.45	1113.96	1145.41	1174.43	1251.84	1320.78	1471.74
Plastic Base with Lumbar Adjustment - Upholstered Back Jacket											
Back Lock	SCT-22-411	\$ 1072.83	\$ 1140.55	\$ 1213.13	\$ 1247.01	\$ 1276.03	\$ 1338.93	\$ 1396.97	\$ 1551.79	\$ 1689.67	\$ 1991.59
Forward Tilt/Back Lock	SCT-22-414	1139.36	1207.08	1279.66	1313.54	1342.56	1405.46	1463.50	1618.32	1756.20	2058.12
Aluminum Base - Mesh Back											
Back Lock	SCT-20-401	\$ 921.64	\$ 955.50	\$ 991.79	\$ 1008.73	\$ 1023.24	\$ 1054.69	\$ 1083.71	\$ 1161.12	\$ 1230.06	\$ 1381.02
Forward Tilt/Back Lock	SCT-20-404	988.17	1022.03	1058.32	1075.26	1089.77	1121.22	1150.24	1227.65	1296.59	1447.55
Aluminum Base - Upholstered Back Jacket											
Back Lock	SCT-22-401	\$ 1048.64	\$ 1116.36	\$ 1188.94	\$ 1222.82	\$ 1251.84	\$ 1314.74	\$ 1372.78	\$ 1527.60	\$ 1665.48	\$ 1967.40
Forward Tilt/Back Lock	SCT-22-404	1115.17	1182.89	1255.47	1289.35	1318.37	1381.27	1439.31	1594.13	1732.01	2033.93
Aluminum Base with Lumbar Adjustment - Mesh Back											
Back Lock	SCT-20-411	\$ 1006.31	\$ 1040.17	\$ 1076.46	\$ 1093.40	\$ 1107.91	\$ 1139.36	\$ 1168.38	\$ 1245.79	\$ 1314.73	\$ 1465.69
Forward Tilt/Back Lock	SCT-20-414	1072.84	1106.70	1142.99	1159.93	1174.44	1205.89	1234.91	1312.32	1381.26	1532.22
Aluminum Base with Lumbar Adjustment - Upholstered Back Jacket											
Back Lock	SCT-22-411	\$ 1133.31	\$ 1201.03	\$ 1273.61	\$ 1307.49	\$ 1336.51	\$ 1399.41	\$ 1457.45	\$ 1612.27	\$ 1750.15	\$ 2052.07
Forward Tilt/Back Lock	SCT-22-414	1199.84	1267.56	1340.14	1374.02	1403.04	1465.94	1523.98	1678.80	1816.68	2118.60

The following options require modification of the product number.

CAL 133
HeadrestTo specify, add **F** to the end of the product number; **Example:** SCT-20-401**F** (add **\$142.73** list)
To specify, change the 3rd digit from a **T** to an **E**. **Example:** SCE-22-7112 with headrest (add **\$84.67** list)**NOTE:** CAL 133 is available on SCT-20 models only.

Very Task

Task Chair with Fixed Arms



SCT-20-1011

Dimensions

*SH: 16-21"(406mm-533mm)
 H: 39-44"(991mm-1118mm)
 D: 26"(660mm)
 W: 27"(686mm)
 *SW: 19"(483mm)

Low Base:
 14-17"(356mm-432mm)

* Measurements taken with the BIFMA chair measuring device.

Features

- Back: Soft mesh only or mesh back with upholstered back jacket.
- Seat: Standard upholstered foam (3 lbs. polyurethane foam construction).
- Seat Depth Adjustment: Standard adjustable range 16"-19" (406mm-483mm).
- Seat Type: Standard adjustable 3"(76mm) range.
- Base: Plastic base or optional painted five-star aluminum or polished aluminum base.
- Arms: Fixed height arms with aluminum uprights in either painted or polished, soft arm caps.
- Mechanism: Balanced 3-point tilt; standard tilt tension.
- Back Lock: Single position upright back lock.
- Optional Forward Tilt: 5 degrees downward from initial position.
- Optional Asymmetrical Lumbar Adjustment: 4"(102mm) height adjustment; support level can be adjusted independently for right or left hand side of users body.
- Casters: Standard with hard black or two-tone casters; optional soft casters.
- COM yardage / COL square footage:
 Mesh back model: 0.83/20
 Mesh back/upholstered back jacket: 1.5/40

NOTE: When specifying a back jacket; must also specify mesh surface color for outside of back. Back jacket is not field retrofittable. To add a back jacket in the field, see e-Parts for replacement back with an attached jacket.

■ Available on RUSH.

To Order, Specify:

1) Product number, including:

1 Base/Caster Option:**Aluminum Base**

- 1** Aluminum Std. Base, Hard Caster
- 2** Aluminum Std. Base, Soft Caster
- T** Aluminum Std. Base, Two-Tone Casters
- 3** Aluminum Low Base, Hard Caster
- 4** Aluminum Low Base, Soft Caster

Plastic Base

- 5** Plastic Std. Base, Hard Caster
- 6** Plastic Std. Base, Soft Caster
- P** Plastic Std. Base, Two-Tone Casters

- 2) Fabric surface and color (seat).
- 3) Mesh surface and color (back).
- 4) Back Jacket (if applicable) Fabric surface and color.
- 5) Trim color (plastic components) (arm caps, control cover, adjustment levers, 4D or height adjustable arm uprights).

Note: If TR-UFM is specified, arm caps and adjustment levers default to TR-7 Fog. (Add **\$91.52** list for TR-UFM Snow.)

- 6) Frame trim color (aluminum components - underside of chair).
- 7) Base trim color (plastic or aluminum) dependent upon base style selected; TR-UFM Snow (plastic) and TR-FS Snowfall (aluminum) not available.

Note: If PM-P Polished Aluminum is selected for aluminum frame components (#6) or aluminum base (#7), or both, a total upcharge of **\$187.47** list will apply.

Leather Seat with Mesh Back:

Change the fourth digit in the product number to **1**.

Example: SCT-10-1011

Leather Seat with Leather Upholstered Back Jacket:

Change the fourth and fifth digits in the product number to **11**.

Example: SCT-11-1011

Faux Leather Seat with Mesh Back:

Change the fourth digit in the product number to **3**.

Example: SCT-30-1011

Stain Repellent Upholstery:

Change the tenth digit in the product number to **P**, and add **\$37.50** list.

Example: SCT-20-1011**P**

Note: Stain repellent is available on SCT-20 and SCT-22 models only.

Very Task

Task Chair with Fixed Arms

Upholstered Foam Seat Adjustments	Number ①	Fabric Grade								Leather Grade A	Leather Grade B
		A	B	C	D	E	F	G	H		
Plastic Base - Mesh Back											
Back Lock	SCT-20-101	\$ 849.07	\$ 882.93	\$ 919.22	\$ 936.16	\$ 950.67	\$ 982.12	\$1011.14	\$1088.55	\$1157.49	\$1308.45
Forward Tilt/Back Lock	SCT-20-104	915.60	949.46	985.75	1002.69	1017.20	1048.65	1077.67	1155.08	1224.02	1374.98
Plastic Base - Upholstered Back Jacket											
Back Lock	SCT-22-101	\$ 976.07	\$1043.79	\$1116.37	\$1150.25	\$1179.27	\$1242.17	\$1300.21	\$1455.03	\$1592.91	\$1894.83
Forward Tilt/Back Lock	SCT-22-104	1042.60	1110.32	1182.90	1216.78	1245.80	1308.70	1366.74	1521.56	1659.44	1961.36
Plastic Base with Lumbar Adjustment - Mesh Back											
Back Lock	SCT-20-111	\$ 933.74	\$ 967.60	\$1003.89	\$1020.83	\$1035.34	\$1066.79	\$1095.81	\$1173.22	\$1242.16	\$1393.12
Forward Tilt/Back Lock	SCT-20-114	1000.27	1034.13	1070.42	1087.36	1101.87	1133.32	1162.34	1239.75	1308.69	1459.65
Plastic Base with Lumbar Adjustment - Upholstered Back Jacket											
Back Lock	SCT-22-111	\$1060.74	\$1128.46	\$1201.04	\$1234.92	\$1263.94	\$1326.84	\$1384.88	\$1539.70	\$1677.58	\$1979.50
Forward Tilt/Back Lock	SCT-22-114	1127.27	1194.99	1267.57	1301.45	1330.47	1393.37	1451.41	1606.23	1744.11	2046.03
Aluminum Base - Mesh Back											
Back Lock	SCT-20-101	\$ 909.55	\$ 943.41	\$ 979.70	\$ 996.64	\$1011.15	\$1042.60	\$1071.62	\$1149.03	\$1217.97	\$1368.93
Forward Tilt/Back Lock	SCT-20-104	976.08	1009.94	1046.23	1063.17	1077.68	1109.13	1138.15	1215.56	1284.50	1435.46
Aluminum Base - Upholstered Back Jacket											
Back Lock	SCT-22-101	\$1036.55	\$1104.27	\$1176.85	\$1210.73	\$1239.75	\$1302.65	\$1360.69	\$1515.51	\$1653.39	\$1955.31
Forward Tilt/Back Lock	SCT-22-104	1103.08	1170.80	1243.38	1277.26	1306.28	1369.18	1427.22	1582.04	1719.92	2021.84
Aluminum Base with Lumbar Adjustment - Mesh Back											
Back Lock	SCT-20-111	\$ 994.22	\$1028.08	\$1064.37	\$1081.31	\$1095.82	\$1127.27	\$1156.29	\$1233.70	\$1302.64	\$1453.60
Forward Tilt/Back Lock	SCT-20-114	1060.75	1094.61	1130.90	1147.84	1162.35	1193.80	1222.82	1300.23	1369.17	1520.13
Aluminum Base with Lumbar Adjustment - Upholstered Back Jacket											
Back Lock	SCT-22-111	\$1121.22	\$1188.94	\$1261.52	\$1295.40	\$1324.42	\$1387.32	\$1445.36	\$1600.18	\$1738.06	\$2039.98
Forward Tilt/Back Lock	SCT-22-114	1187.75	1255.47	1328.05	1361.93	1390.95	1453.85	1511.89	1666.71	1804.59	2106.51

The following options require modification of the product number.

CAL 133
Headrest

To specify, add **F** to the end of the product number; **Example:** SCT-20-101**F** (add **\$142.73** list)
To specify, change the 3rd digit from a T to an E. **Example:** SCE-22-7112 with headrest (add **\$84.67** list)

NOTE: CAL 133 is available on SCT-20 models only.

Very Task

Task Chair without Arms



SCT-20-0011

Dimensions

*SH: 16-21"(406mm-533mm)
 H: 39-44"(991mm-1118mm)
 D: 26"(660mm)
 W: 27"(686mm)
 *SW: 19"(483mm)

Low Base:
 14-17"(356mm-432mm)

* Measurements
 taken with the
 BIFMA chair
 measuring device.

Features

- Back: Soft mesh only or mesh back with upholstered back jacket.
- Seat: Standard upholstered foam (3 lbs. polyurethane foam construction).
- Seat Depth Adjustment: Standard Adjustable range 16"-19" (406mm-483mm).
- Seat Type: Standard adjustable 3"(76mm) range.
- Base: Plastic base or optional painted five-star aluminum or polished aluminum base.
- Mechanism: Balanced 3-point tilt; standard tilt tension.
- Back Lock: Single position upright back lock.
- Optional Forward Tilt: 5 degrees downward from initial position.
- Optional Asymmetrical Lumbar Adjustment: 4"(102mm) height adjustment; support level can be adjusted independently for right or left hand side of users body.
- Casters: Standard with hard black or two-tone casters; optional soft casters.
- COM yardage / COL square footage:
 Mesh back model: 0.83/20
 Mesh back/upholstered back jacket: 1.5/40

NOTE: When specifying a back jacket; must also specify mesh surface color for outside of back. Back jacket is not field retrofittable. To add a back jacket in the field, see e-Parts for replacement back with an attached jacket.

■ Available on RUSH.

To Order, Specify:

1) Product number, including:

1 Base/Caster Option:**Aluminum Base**

- 1** Aluminum Std. Base, Hard Caster
- 2** Aluminum Std. Base, Soft Caster
- T** Aluminum Std. Base, Two-Tone Casters
- 3** Aluminum Low Base, Hard Caster
- 4** Aluminum Low Base, Soft Caster

Plastic Base

- 5** Plastic Std. Base, Hard Caster
- 6** Plastic Std. Base, Soft Caster
- P** Plastic Std. Base, Two-Tone Casters

- 2) Fabric surface and color (seat).
- 3) Mesh surface and color (back).
- 4) Back Jacket (if applicable) Fabric surface and color.
- 5) Trim color (plastic components) (arm caps, control cover, adjustment levers, 4D or height adjustable arm uprights).

Note: If TR-UFM is specified, arm caps and adjustment levers default to TR-7 Fog. (Add **\$91.52** list for TR-UFM Snow.)

- 6) Frame trim color (aluminum components - underside of chair).
- 7) Base trim color (plastic or aluminum) dependent upon base style selected; TR-UFM Snow (plastic) and TR-FS Snowfall (aluminum) not available.

Note: If PM-P Polished Aluminum is selected for aluminum frame components (#6) or aluminum base (#7), or both, a total upcharge of **\$187.47** list will apply.

Leather Seat with Mesh Back:

Change the fourth digit in the product number to **1**.

Example: SCT-10-0011

Leather Seat with Leather Upholstered Back Jacket:

Change the fourth and fifth digits in the product number to **11**.

Example: SCT-11-0011

Faux Leather Seat with Mesh Back:

Change the fourth digit in the product number to **3**.

Example: SCT-30-0011

Stain Repellent Upholstery:

Change the tenth digit in the product number to **P**, and add **\$37.50** list.

Example: SCT-20-0011**P**

Note: Stain repellent is available on SCT-20 and SCT-22 models only.

Very Task

Task Chair without Arms

Upholstered Foam Seat Adjustments	Number ①	Fabric Grade								Leather Grade A	Leather Grade B
		A	B	C	D	E	F	G	H		
Plastic Base - Mesh Back											
Back Lock	SCT-20-001	\$ 709.98	\$ 743.84	\$ 780.13	\$ 797.07	\$ 811.58	\$ 843.03	\$ 872.05	\$ 949.46	\$1018.40	\$1169.36
Forward Tilt/Back Lock	SCT-20-004	776.51	810.37	846.66	863.60	878.11	909.56	938.58	1015.99	1084.93	1235.89
Plastic Base - Upholstered Back Jacket											
Back Lock	SCT-22-001	\$ 836.98	\$ 904.70	\$ 977.28	\$1011.16	\$1040.18	\$1103.08	\$1161.12	\$1315.94	\$1453.82	\$1755.74
Forward Tilt/Back Lock	SCT-22-004	903.51	971.23	1043.81	1077.69	1106.71	1169.61	1227.65	1382.47	1520.35	1822.27
Plastic Base with Lumbar Adjustment - Mesh Back											
Back Lock	SCT-20-011	\$ 794.65	\$ 828.51	\$ 864.80	\$ 881.74	\$ 896.25	\$ 927.70	\$ 956.72	\$1034.13	\$1103.07	\$1254.03
Forward Tilt/Back Lock	SCT-20-014	861.18	895.04	931.33	948.27	962.78	994.23	1023.25	1100.66	1169.60	1320.56
Plastic Base with Lumbar Adjustment - Upholstered Back Jacket											
Back Lock	SCT-22-011	\$ 921.65	\$ 989.37	\$1061.95	\$1095.83	\$1124.85	\$1187.75	\$1245.79	\$1400.61	\$1538.49	\$1840.41
Forward Tilt/Back Lock	SCT-22-014	988.18	1055.90	1128.48	1162.36	1191.38	1254.28	1312.32	1467.14	1605.02	1906.94
Aluminum Base - Mesh Back											
Back Lock	SCT-20-001	\$ 770.46	\$ 804.32	\$ 840.61	\$ 857.55	\$ 872.06	\$ 903.51	\$ 932.53	\$1009.94	\$1078.88	\$1229.84
Forward Tilt/Back Lock	SCT-20-004	836.99	870.85	907.14	924.08	938.59	970.04	999.06	1076.47	1145.41	1296.37
Aluminum Base - Upholstered Back Jacket											
Back Lock	SCT-22-001	\$ 897.46	\$ 965.18	\$1037.76	\$1071.64	\$1100.66	\$1163.56	\$1221.60	\$1376.42	\$1514.30	\$1816.22
Forward Tilt/Back Lock	SCT-22-004	963.99	1031.71	1104.29	1138.17	1167.19	1230.09	1288.13	1442.95	1580.83	1882.75
Aluminum Base with Lumbar Adjustment - Mesh Back											
Back Lock	SCT-20-011	\$ 855.13	\$ 888.99	\$ 925.28	\$ 942.22	\$ 956.73	\$ 988.18	\$1017.20	\$1094.61	\$1163.55	\$1314.51
Forward Tilt/Back Lock	SCT-20-014	921.66	955.52	991.81	1008.75	1023.26	1054.71	1083.73	1161.14	1230.08	1381.04
Aluminum Base with Lumbar Adjustment - Upholstered Back Jacket											
Back Lock	SCT-22-011	\$ 982.13	\$1049.85	\$1122.43	\$1156.31	\$1185.33	\$1248.23	\$1306.27	\$1461.09	\$1598.97	\$1900.89
Forward Tilt/Back Lock	SCT-22-014	1048.66	1116.38	1188.96	1222.84	1251.86	1314.76	1372.80	1527.62	1665.50	1967.42

The following options require modification of the product number.

CAL 133
Headrest

To specify, add **F** to the end of the product number; **Example:** SCT-20-011**F** (add **\$142.73** list)
To specify, change the 3rd digit from a **T** to an **E**. **Example:** SCE-22-7112 with headrest (add **\$84.67** list)

NOTE: CAL 133 is available on SCT-20 models only.

Very Task

Task Stool with 4D Arms



SCTC-20-7011

Dimensions

- *SH: 20-28"
(508mm-711mm)
H: 43-51"
(1092mm-1295mm)
D: 26"(660mm)
W: 27"(686mm)
*SW: 19"(483mm)

* Measurements taken with the BIFMA chair measuring device.

Features

- Back: Soft mesh or mesh back with upholstered back jacket.
- Seat: Standard upholstered foam (3 lbs. polyurethane foam construction).
- Seat Depth Adjustment: Standard adjustable range 16"-19" (406mm-483mm).
- Base: Plastic base or optional painted five-star aluminum or polished aluminum base.
- Arms: 4D with soft arm caps. Arm adjusts up and down, side to side.
- Mechanism: Balanced 3-point tilt; standard tilt tension.
- Back Lock: Single position upright back lock.
- Optional Asymmetrical Lumbar Adjustment: 4"(102mm) height adjustment; support level can be adjusted independently for right or left hand side of users body.
- Casters: Standard with hard black or two-tone casters; optional soft casters.
- Adjustable height foot ring.
- COM yardage / COL square footage:
Mesh back model: 0.83/20
Mesh back/upholstered back jacket: 1.5/40

NOTE: When specifying a back jacket; must also specify mesh surface color for outside of back. Back jacket is not field retrofittable. To add a back jacket in the field, see e-Parts for replacement back with an attached jacket.

To Order, Specify:

1) Product number, including:

1 Base/Caster Option:**Aluminum Base**

- 1** Aluminum Std. Base, Hard Caster
- 2** Aluminum Std. Base, Soft Caster
- T** Aluminum Std. Base, Two-Tone Casters

Plastic Base

- 5** Plastic Std. Base, Hard Caster
- 6** Plastic Std. Base, Soft Caster
- P** Plastic Std. Base, Two-Tone Casters

- 2) Fabric surface and color (seat).
- 3) Mesh surface and color (back).
- 4) Back Jacket (if applicable) Fabric surface and color.
- 5) Trim color (plastic components) (arm caps, control cover, adjustment levers, 4D or height adjustable arm uprights).

Note: If TR-UFM is specified, arm caps and adjustment levers default to TR-7 Fog. (Add **\$91.52** list for TR-UFM Snow.)

- 6) Frame trim color (aluminum components - underside of chair).
- 7) Base trim color (plastic or aluminum) dependent upon base style selected; TR-UFM Snow (plastic) and TR-FS Snowfall (aluminum) not available.

Note: If PM-P Polished Aluminum is selected for aluminum frame components (#6) or aluminum base (#7), or both, a total upcharge of **\$187.47** list will apply.

Leather Seat with Mesh Back:

Change the fourth digit in the product number to **1**.

Example: SCTC-10-7011

Leather Seat with Leather Upholstered Back Jacket:

Change the fourth and fifth digits in the product number to **11**.

Example: SCTC-11-7011

Faux Leather Seat with Mesh Back:

Change the fourth digit in the product number to **3**.

Example: SCTC-30-7011

Stain Repellent Upholstery:

Change the tenth digit in the product number to **P**, and add **\$37.50** list.

Example: SCTC-20-7011P

Note: Stain repellent is available on SCTC-20 and SCTC-22 models only.

Very Task

Task Stool with 4D Arms

Upholstered Seat Adjustments	Number ①	Fabric Grade								Leather Grade A	Leather Grade B
		A	B	C	D	E	F	G	H		
Plastic Base											
Mesh Back/Back Lock	SCTC-20-701	\$1340.06	\$1373.92	\$1410.21	\$1427.15	\$1441.66	\$1473.11	\$1502.13	\$1579.54	\$1648.48	\$1799.44
Upholstered Back Jacket/Back Lock	SCTC-22-701	1467.06	1534.78	1607.36	1641.24	1670.26	1733.16	1791.20	1946.02	2083.90	2385.82
Plastic Base with Lumbar Adjustment											
Mesh Back/Back Lock	SCTC-20-711	\$1424.73	\$1458.59	\$1494.88	\$1511.82	\$1526.33	\$1557.78	\$1586.80	\$1664.21	\$1733.15	\$1884.11
Upholstered Back Jacket/Back Lock	SCTC-22-711	1551.73	1619.45	1692.03	1725.91	1754.93	1817.83	1875.87	2030.69	2168.57	2470.49
Aluminum Base											
Mesh Back/Back Lock	SCTC-20-701	\$1400.54	\$1434.40	\$1470.69	\$1487.63	\$1502.14	\$1533.59	\$1562.61	\$1640.02	\$1708.96	\$1859.92
Upholstered Back Jacket/Back Lock	SCTC-22-701	1527.54	1595.26	1667.84	1701.72	1730.74	1793.64	1851.68	2006.50	2144.38	2446.30
Aluminum Base with Lumbar Adjustment											
Mesh Back/Back Lock	SCTC-20-711	\$1485.21	\$1519.07	\$1555.36	\$1572.30	\$1586.81	\$1618.26	\$1647.28	\$1724.69	\$1793.63	\$1944.59
Upholstered Back Jacket/Back Lock	SCTC-22-711	1612.21	1679.93	1752.51	1786.39	1815.41	1878.31	1936.35	2091.17	2229.05	2530.97

The following options require modification of the product number.

CAL 133

To specify, add **F** to the end of the product number; **Example:** SCTC-20-7011F (add \$142.73 list)

NOTE: CAL 133 is available on SCTC-20 models only.

Very Task

Task Stool with Height Adjustable Arms



SCTC-20-4011

Dimensions

- *SH: 20-28"
(508mm-711mm)
- H: 43-51"
(1092mm-1295mm)
- D: 26"(660mm)
- W: 27"(686mm)
- *SW: 19"(483mm)

* Measurements taken with the BIFMA chair measuring device.

Features

- Back: Soft mesh only or mesh back with upholstered back jacket.
- Seat: Standard upholstered foam (3 lbs. polyurethane foam construction).
- Seat Depth Adjustment: Standard adjustable range 16"-19" (406mm-483mm).
- Base: Plastic base or optional painted five-star aluminum or polished aluminum base.
- Arms: Height-adjustable arms with plastic uprights (black or fog) with soft arm caps.
- Mechanism: Balanced 3-point tilt; standard tilt tension.
- Back Lock: Single position upright back lock.
- Optional Asymmetrical Lumbar Adjustment: 4"(102mm) height adjustment; support level can be adjusted independently for right or left hand side of users body.
- Casters: Standard with hard black or two-tone casters; optional soft casters.
- Adjustable height foot ring.
- COM yardage / COL square footage:
 - Mesh back model: 0.83/20
 - Mesh back/upholstered back jacket: 1.5/40

NOTE: When specifying a back jacket; must also specify mesh surface color for outside of back. Back jacket is not field retrofittable. To add a back jacket in the field, see e-Parts for replacement back with an attached jacket.

To Order, Specify:

- 1) Product number, including:

1 Base/Caster Option:

Aluminum Base

- 1** Aluminum Std. Base, Hard Caster
- 2** Aluminum Std. Base, Soft Caster
- T** Aluminum Std. Base, Two-Tone Casters

Plastic Base

- 5** Plastic Std. Base, Hard Caster
- 6** Plastic Std. Base, Soft Caster
- P** Plastic Std. Base, Two-Tone Casters

- 2) Fabric surface and color (seat).
- 3) Mesh surface and color (back).
- 4) Back Jacket (if applicable) Fabric surface and color.
- 5) Trim color (plastic components) (arm caps, control cover, adjustment levers, 4D or height adjustable arm uprights).

Note: If TR-UFM is specified, arm caps and adjustment levers default to TR-7 Fog. (Add **\$91.52** list for TR-UFM Snow.)

- 6) Frame trim color (aluminum components - underside of chair).
- 7) Base trim color (plastic or aluminum) dependent upon base style selected; TR-UFM Snow (plastic) and TR-FS Snowfall (aluminum) not available.

Note: If PM-P Polished Aluminum is selected for aluminum frame components (#6) or aluminum base (#7), or both, a total upcharge of **\$187.47** list will apply.

Leather Seat with Mesh Back:

Change the fourth digit in the product number to **1**.

Example: SCTC-10-4011

Leather Seat with Leather Upholstered Back Jacket:

Change the fourth and fifth digits in the product number to **11**.

Example: SCTC-11-4011

Faux Leather Seat with Mesh Back:

Change the fourth digit in the product number to **3**.

Example: SCTC-30-4011

Stain Repellent Upholstery:

Change the tenth digit in the product number to **P**, and add **\$37.50** list.

Example: SCTC-20-4011P

Note: Stain repellent is available on SCTC-20 and SCTC-22 models only.

Very Task

Task Stool with Height Adjustable Arms

Upholstered Foam Seat Adjustments	Number ①	Fabric Grade								Leather Grade A	Leather Grade B
		A	B	C	D	E	F	G	H		
Plastic Base											
Mesh Back/Back Lock	SCTC-20-401	\$1279.58	\$1313.44	\$1349.73	\$1366.67	\$1381.18	\$1412.63	\$1441.65	\$1519.06	\$1588.00	\$1738.96
Upholstered Back Jacket/Back Lock	SCTC-22-401	1406.58	1474.30	1546.88	1580.76	1609.78	1672.68	1730.72	1885.54	2023.42	2325.34
Plastic Base with Lumbar Adjustment											
Mesh Back/Back Lock	SCTC-20-411	\$1364.25	\$1398.11	\$1434.40	\$1451.34	\$1465.85	\$1497.30	\$1526.32	\$1603.73	\$1672.67	\$1823.63
Upholstered Back Jacket/Back Lock	SCTC-22-411	1491.25	1558.97	1631.55	1665.43	1694.45	1757.35	1815.39	1970.21	2108.09	2410.01
Aluminum Base											
Mesh Back/Back Lock	SCTC-20-401	\$1340.06	\$1373.92	\$1410.21	\$1427.15	\$1441.66	\$1473.11	\$1502.13	\$1579.54	\$1648.48	\$1799.44
Upholstered Back Jacket/Back Lock	SCTC-22-401	1467.06	1534.78	1607.36	1641.24	1670.26	1733.16	1791.20	1946.02	2083.90	2385.82
Aluminum Base with Lumbar Adjustment											
Mesh Back/Back Lock	SCTC-20-411	\$1424.73	\$1458.59	\$1494.88	\$1511.82	\$1526.33	\$1557.78	\$1586.80	\$1664.21	\$1733.15	\$1884.11
Upholstered Back Jacket/Back Lock	SCTC-22-411	1551.73	1619.45	1692.03	1725.91	1754.93	1817.83	1875.87	2030.69	2168.57	2470.49

The following options require modification of the product number.

CAL 133

To specify, add **F** to the end of the product number; **Example:** SCTC-20-4011F (add \$142.73 list)

NOTE: CAL 133 is available on SCTC-20 models only.

Very Task

Task Stool with Fixed Arms



SCTC-20-1011

Dimensions

- *SH: 20-28"
(508mm-711mm)
- H: 43-51"
(1092mm-1295mm)
- D: 26"(660mm)
- W: 27"(686mm)
- *SW: 19"(483mm)

* Measurements taken with the BIFMA chair measuring device.

Features

- Back: Soft mesh only or mesh back with upholstered back jacket.
- Seat: Standard upholstered foam (3 lbs. polyurethane foam construction).
- Seat Depth Adjustment: Standard adjustable range 16"-19" (406mm-483mm).
- Seat Type: Standard adjustable 3"(76mm) range.
- Base: Plastic base or optional painted five-star aluminum or polished aluminum base.
- Arms: Fixed height arms with aluminum uprights in either painted or polished, soft arm caps.
- Mechanism: Balanced 3-point tilt; standard tilt tension.
- Back Lock: Single position upright back lock.
- Optional Asymmetrical Lumbar Adjustment: 4"(102mm) height adjustment; support level can be adjusted independently for right or left hand side of users body.
- Casters: Standard with hard black or two-tone casters; optional soft casters.
- Adjustable height foot ring.
- COM yardage / COL square footage:
Mesh back model: 0.83/20
Mesh back/upholstered back jacket: 1.5/40

NOTE: When specifying a back jacket; must also specify mesh surface color for outside of back. Back jacket is not field retrofittable. To add a back jacket in the field, see e-Parts for replacement back with an attached jacket.

To Order, Specify:

- 1) Product number, including:

1 Base/Caster Option:

Aluminum Base

- 1** Aluminum Std. Base, Hard Caster
- 2** Aluminum Std. Base, Soft Caster
- T** Aluminum Std. Base, Two-Tone Casters

Plastic Base

- 5** Plastic Std. Base, Hard Caster
- 6** Plastic Std. Base, Soft Caster
- P** Plastic Std. Base, Two-Tone Casters

- 2) Fabric surface and color (seat).
- 3) Mesh surface and color (back).
- 4) Back Jacket (if applicable) Fabric surface and color.
- 5) Trim color (plastic components) (arm caps, control cover, adjustment levers, 4D or height adjustable arm uprights).

Note: If TR-UFM is specified, arm caps and adjustment levers default to TR-7 Fog. (Add **\$91.52** list for TR-UFM Snow.)

- 6) Frame trim color (aluminum components - underside of chair).
- 7) Base trim color (plastic or aluminum) dependent upon base style selected; TR-UFM Snow (plastic) and TR-FS Snowfall (aluminum) not available.

Note: If PM-P Polished Aluminum is selected for aluminum frame components (#6) or aluminum base (#7), or both, a total upcharge of **\$187.47** list will apply.

Leather Seat with Mesh Back:

Change the fourth digit in the product number to **1**.

Example: SCTC-10-1011

Leather Seat with Leather Upholstered Back Jacket:

Change the fourth and fifth digits in the product number to **11**.

Example: SCTC-11-1011

Faux Leather Seat with Mesh Back:

Change the fourth digit in the product number to **3**.

Example: SCTC-30-1011

Stain Repellent Upholstery:

Change the tenth digit in the product number to **P**, and add **\$37.50** list.

Example: SCTC-20-1011P

Note: Stain repellent is available on SCTC-20 and SCTC-22 models only.

Very Task

Task Stool with Fixed Arms

Upholstered Foam Seat Adjustments	Number ^①	Fabric Grade								Leather Grade A	Leather Grade B
		A	B	C	D	E	F	G	H		
Plastic Base											
Mesh Back/Back Lock	SCTC-20-101	\$1267.49	\$1301.35	\$1337.64	\$1354.58	\$1369.09	\$1400.54	\$1429.56	\$1506.97	\$1575.91	\$1726.87
Upholstered Back Jacket/Back Lock	SCTC-22-101	1394.49	1462.21	1534.79	1568.67	1597.69	1660.59	1718.63	1873.45	2011.33	2313.25
Plastic Base with Lumbar Adjustment											
Mesh Back/Back Lock	SCTC-20-111	\$1352.16	\$1386.02	\$1422.31	\$1439.25	\$1453.76	\$1485.21	\$1514.23	\$1591.64	\$1660.58	\$1811.54
Upholstered Back Jacket/Back Lock	SCTC-22-111	1479.16	1546.88	1619.46	1653.34	1682.36	1745.26	1803.30	1958.12	2096.00	2397.92
Aluminum Base											
Mesh Back/Back Lock	SCTC-20-101	\$1327.97	\$1361.83	\$1398.12	\$1415.06	\$1429.57	\$1461.02	\$1490.04	\$1567.45	\$1636.39	\$1787.35
Upholstered Back Jacket/Back Lock	SCTC-22-101	1454.97	1522.69	1595.27	1629.15	1658.17	1721.07	1779.11	1933.93	2071.81	2373.73
Aluminum Base with Lumbar Adjustment											
Mesh Back/Back Lock	SCTC-20-111	\$1412.64	\$1446.50	\$1482.79	\$1499.73	\$1514.24	\$1545.69	\$1574.71	\$1652.12	\$1721.06	\$1872.02
Upholstered Back Jacket/Back Lock	SCTC-22-111	1539.64	1607.36	1679.94	1713.82	1742.84	1805.74	1863.78	2018.60	2156.48	2458.40

The following options require modification of the product number.

CAL 133

To specify, add **F** to the end of the product number; **Example:** SCTC-20-1011F (add \$142.73 list)

NOTE: CAL 133 is available on SCTC-20 models only.

Very Task

Task Stool without Arms



SCTC-20-0011

Dimensions

- *SH: 20-28"
(508mm-711mm)
- H: 43-51"
(1092mm-12958mm)
- D: 26"(660mm)
- W: 27"(686mm)
- *SW: 19"(483mm)

* Measurements taken with the BIFMA chair measuring device.

Features

- Back: Soft mesh only or mesh back with upholstered back jacket.
- Seat: Standard upholstered foam (3 lbs. polyurethane foam construction).
- Seat Depth Adjustment: Standard Adjustable range 16"-19" (406mm-483mm).
- Seat Type: Standard adjustable 3"(76mm) range.
- Base: Plastic base or optional painted five-star aluminum or polished aluminum base.
- Mechanism: Balanced 3-point tilt; standard tilt tension.
- Back Lock: Single position upright back lock.
- Optional Asymmetrical Lumbar Adjustment: 4"(102mm) height adjustment; support level can be adjusted independently for right or left hand side of users body.
- Casters: Standard with hard black or two-tone casters; optional soft casters.
- Adjustable height foot ring.
- COM yardage / COL square footage:
Mesh back model: 0.83/20
Mesh back/upholstered back jacket: 1.5/40

NOTE: When specifying a back jacket; must also specify mesh surface color for outside of back. Back jacket is not field retrofittable. To add a back jacket in the field, see e-Parts for replacement back with an attached jacket.

To Order, Specify:

1) Product number, including:

1 Base/Caster Option:

Aluminum Base

- 1** Aluminum Std. Base, Hard Caster
- 2** Aluminum Std. Base, Soft Caster
- T** Aluminum Std. Base, Two-Tone Casters

Plastic Base

- 5** Plastic Std. Base, Hard Caster
- 6** Plastic Std. Base, Soft Caster
- P** Plastic Std. Base, Two-Tone Casters

- 2) Fabric surface and color (seat).
 - 3) Mesh surface and color (back).
 - 4) Back Jacket (if applicable) Fabric surface and color.
 - 5) Trim color (plastic components) (arm caps, control cover, adjustment levers, 4D or height adjustable arm uprights).
- Note:** If TR-UFM is specified, arm caps and adjustment levers default to TR-7 Fog. (Add **\$91.52** list for TR-UFM Snow.)
- 6) Frame trim color (aluminum components - underside of chair).
 - 7) Base trim color (plastic or aluminum) dependent upon base style selected; TR-UFM Snow (plastic) and TR-FS Snowfall (aluminum) not available.

Note: If PM-P Polished Aluminum is selected for aluminum frame components (#6) or aluminum base (#7), or both, a total upcharge of **\$187.47** list will apply.

Leather Seat with Mesh Back:

Change the fourth digit in the product number to **1**.

Example: SCTC-10-0011

Leather Seat with Leather Upholstered Back Jacket:

Change the fourth and fifth digits in the product number to **11**.

Example: SCTC-11-0011

Faux Leather Seat with Mesh Back:

Change the fourth digit in the product number to **3**.

Example: SCTC-30-0011

Stain Repellent Upholstery:

Change the tenth digit in the product number to **P**, and add **\$37.50** list.

Example: SCTC-20-0011P

Note: Stain repellent is available on SCTC-20 and SCTC-22 models only.

Very Task

Task Stool without Arms

Upholstered Foam Seat Adjustments	Number ①	Fabric Grade								Leather Grade A	Leather Grade B
		A	B	C	D	E	F	G	H		
Plastic Base											
Mesh Back/Back Lock	SCTC-20-001	\$1128.40	\$1162.26	\$1198.55	\$1215.49	\$1230.00	\$1261.45	\$1290.47	\$1367.88	\$1436.82	\$1587.78
Upholstered Back Jacket/Back Lock	SCTC-22-001	1255.40	1323.12	1395.70	1429.58	1458.60	1521.50	1579.54	1734.36	1872.24	2174.16
Plastic Base with Lumbar Adjustment											
Mesh Back/Back Lock	SCTC-20-011	\$1213.07	\$1246.93	\$1283.22	\$1300.16	\$1314.67	\$1346.12	\$1375.14	\$1452.55	\$1521.49	\$1672.45
Upholstered Back Jacket/Back Lock	SCTC-22-011	1340.07	1407.79	1480.37	1514.25	1543.27	1606.17	1664.21	1819.03	1956.91	2258.83
Aluminum Base											
Mesh Back/Back Lock	SCTC-20-001	\$1188.88	\$1222.74	\$1259.03	\$1275.97	\$1290.48	\$1321.93	\$1350.95	\$1428.36	\$1497.30	\$1648.26
Upholstered Back Jacket/Back Lock	SCTC-22-001	1315.88	1383.60	1456.18	1490.06	1519.08	1581.98	1640.02	1794.84	1932.72	2234.64
Aluminum Base with Lumbar Adjustment											
Mesh Back/Back Lock	SCTC-20-011	\$1273.55	\$1307.41	\$1343.70	\$1360.64	\$1375.15	\$1406.60	\$1435.62	\$1513.03	\$1581.97	\$1732.93
Upholstered Back Jacket/Back Lock	SCTC-22-011	1400.55	1468.27	1540.85	1574.73	1603.75	1666.65	1724.69	1879.51	2017.39	2319.31

The following options require modification of the product number.

CAL 133

To specify, add **F** to the end of the product number; **Example:** SCTC-20-0111F (add \$142.73 list)

NOTE: CAL 133 is available on SCTC-20 models only.

This page intentionally blank

Lively-At-A-Glance

Designer Steve Nemeth and the Haworth Design Studio

Lively Lively provides a seating collection that is affordable without compromise. It offers daylong comfort, worry-free quality and a light-scale aesthetic.

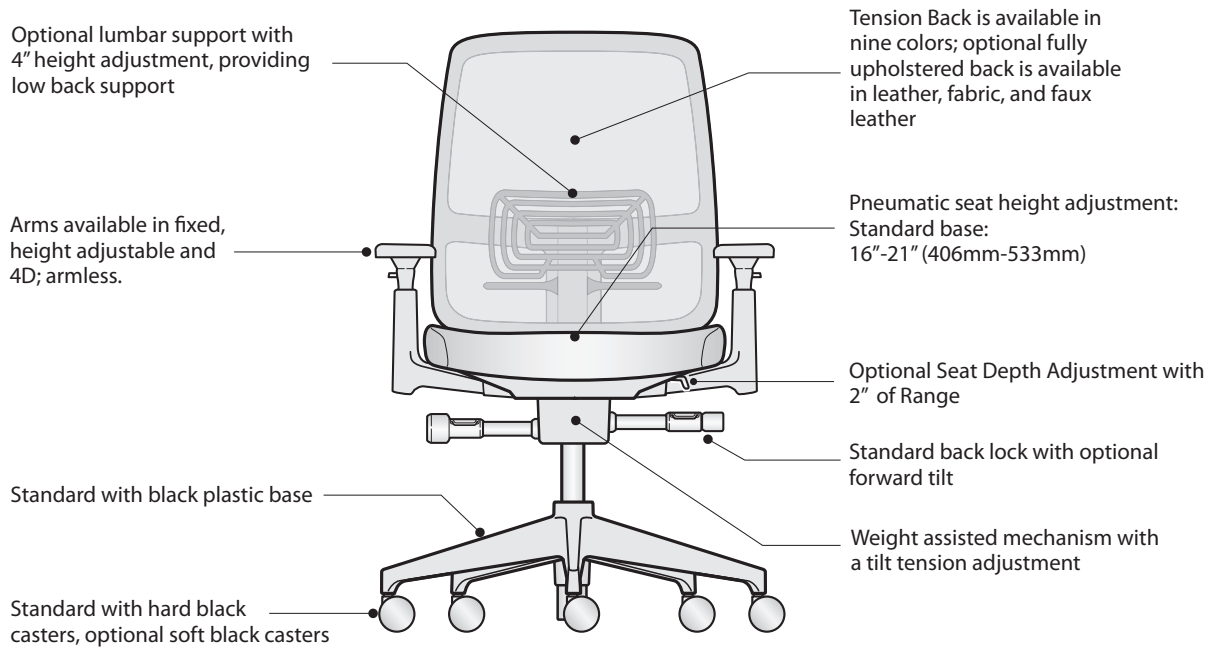

Lively Task

General Specifications

Features and Options (Task Chair)

- Back: Tension back or fully upholstered.
- Seat: Standard upholstered with foam.
- Base: Black plastic.
- Arms: 4D, Height Adjustable, or Fixed arms. Armless model available.
- Mechanism: Weight assisted mechanism with tilt tension adjustment.
- Height Adjustment: Pneumatic.
- Standard back lock.
- Optional Forward Tilt: 5° downward from initial position.
- Optional Adjustable Lumbar: 4" adjustment, flexible support.
- Optional Seat Depth Adjustment: Adjustable range is 16.75"-19"(425mm-483mm).
- Casters: Five-Star base with casters; hard (black) or soft (black).
- Lively Task chairs are warranted for persons up to 325 lbs. for 12 years 24/7.

General Guidelines for Product Specification

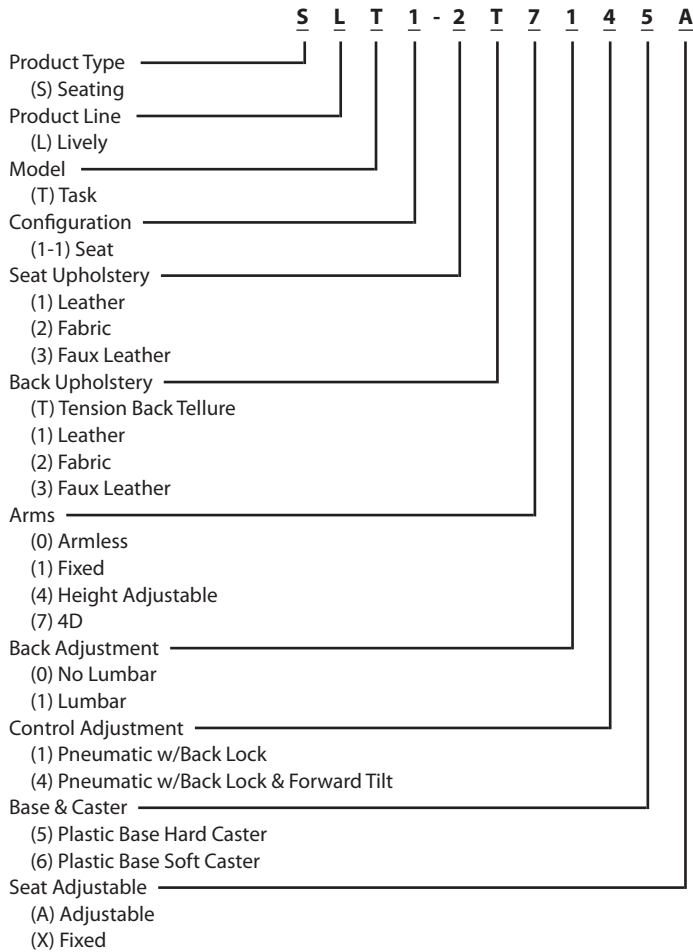

Lively Task

General Specifications

Environmental Factors

- Greenguard Gold certified for low emissions.
- Lively Task is BIFMA level 2 certified.
- Lively is produced in an ISO 14001 certified manufacturing facility.
- Haworth will take back Lively chairs after their useful life and recycle the components. Please contact Haworth's Material Recovery Center at (616)393-1215.
- Lively has 52% recycled content and is up to 97% recyclable.

COM & COL General Information

To order a COM fabric (Customer's Own Material), contact the Haworth Inquiry Center (1.800.426.8562), your local Haworth dealer, or go to haworth.com/surfaces > COM Library to find out if the COM you have selected has already been tested and approved. The surface collection site also has information on the Haworth+ alliance program with Carnegie, Luna Textiles, and Maharam as well as our industry-leading Pre-Approved COM program.

COM fabrics are placed into Grades based on the cost per linear yard. If a fabric's cost exceeds the range of our highest Grade it will be noted as Non-Graded. The product will be priced at Grade A; the COM fabric costs will appear as a separate line item. The fabric charge will be Haworth's purchase cost plus a 4% administrative fee (based on the cost of the fabric). Yardage calculations will include any applicable fabric repeat.

COM Leather products will be priced at a leather Grade A; COL costs will appear as a separate line item. The leather costs will be Haworth's purchase cost plus a 4% administrative fee (based on the cost of the leather).

Finishes and Fabrics

A complete listing of finishes and fabrics for Lively seating is available in the surface materials section of the Seating price list.

Shipping Weights (Including packaging)

- Chairs with arms: 42 pounds/1 chair per carton
- Chairs without arms: 38.8 pounds/1 chair per carton

Lively

General Specifications

STANDARD MOBILITY AND ADJUSTABILITY

Weight Assisted Tilt Tension Mechanism

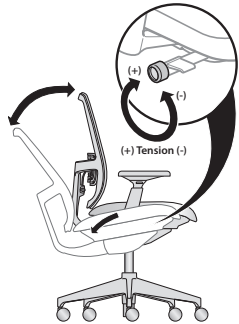

Features:

- Back reclines 24° from the upright position.
- Responds to users weight in combination with the tilt tension to maximize comfort.

Benefits:

- Comfortable relaxed posture.
- Recline allows for the opening of the users' chest cavity providing good airflow to promote alertness.

Seat Height Adjustment

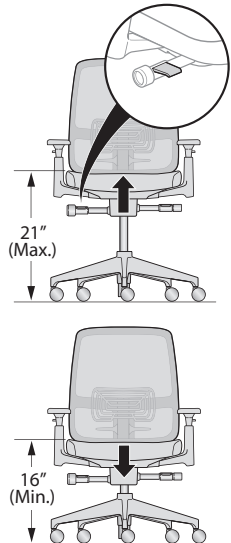

Features:

- Pneumatic seat height adjustment.
- Seat height adjusts 5"(127mm) from 16" to 21"(406mm to 533mm).

Benefits:

- Ensures the comfort of the lower limbs by avoiding pressure on the underside of the thigh caused by a seat pan that is too high, or decreased thigh-to-torso angle if the seat pan is too low.
- Seat height adjustment also is important in setting the proper hand position and allowing for a proper sitting eye height.

Back Lock

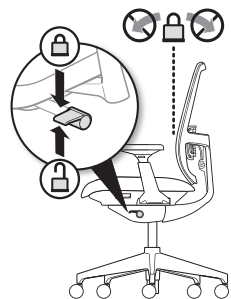

Features:

- Single position Back Lock.

Benefit:

- Allows users to lock the back of the chair in the upright position for tasking application.

Lively

General Specifications

OPTIONAL MOBILITY AND ADJUSTABILITY

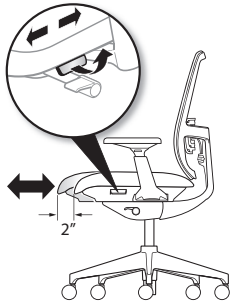
Seat Depth Adjustment**Features:**

- 2" (51mm) of seat depth range.

Benefit:

- Supports the thighs, allows users to rest against the seat back for back support, and avoids pressure on the back of the knees of small to tall users.

Forward Tilt**Feature:**

- Optional forward tilt.
- Seat pan moves downward 5° from initial position.

Benefit:

- Promotes a healthy spinal posture where your back stays in contact with the chair as a user sits on the front of their chair.

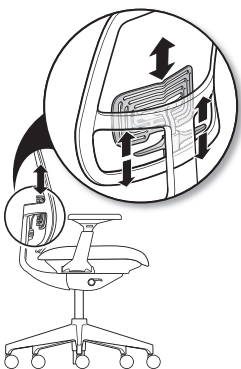
Lumbar Support**Features:**

- Lumbar adjustment adjusts 4" (102mm) in height.

Benefits:

- Lumbar adjustment maintains the natural curvature of the spine at the lower back and allows users to choose the support that feels right for them.

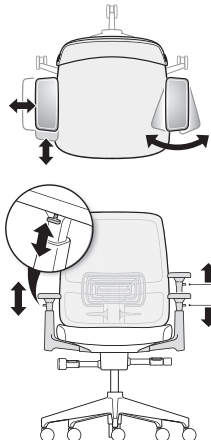
4D Arm**Features:**

- Optional 4D arm.
- Arm adjusts in 4 ways:
 - Height adjustment: 4" (102mm)
 - Side-to-side arm cap adjustment range: 3" (76mm) [1 1/2" (38mm) each arm cap]
 - Front-to-back adjustment range: 3 1/2" (89mm)
 - Pivoting: In 20°; out 20°

Benefits:

- Arms support the muscular system of users' neck and shoulders and proper arm support provides back relief. Arms can be an aid in standing or sitting down.
- Height adjustment accommodates for users with varying elbow rest heights so that users avoid lifting their shoulders or leaning sideways to get arm support.
- Side-to-side adjustment ensures a comfortable resting position for the arms with proper support of the forearm while allowing for easy entry/exit of the chair.
- Front-to-back adjustment adjusts the armrest length, which is important because it allows users to get close to the worksurface while maintaining the effective use of the backrest.
- Pivoting provides proper support of the forearm when performing tasks involving keying and mousing.

Lively

General Specifications

OPTIONAL MOBILITY AND ADJUSTABILITY (continued)

Height Adjustable Arm

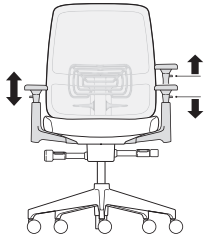

Features:

- Optional height adjustable arms adjust 4"(102mm) vertically.

Benefit:

- Height adjustment accommodates users with varying elbow rest heights so that users avoid lifting their shoulders or leaning sideways to get arm support.
-

Leather Upholstery



Seat:

- Stitched double seams. Vertically in the center and on the edges of the seat cushion.

Back:

- Vertical stitched double seams on the upholstered back with leather or Customer's Own Leather (COL).

Lively Value Model

Task Chair with 4D Arms



SLT1-2T-7115A

Dimensions*

*SH: 16"-21"
(406mm-533mm)
H: 36"-41"
(914mm-1041mm)
D: 24"(610mm)
W: 28"(711mm)
*SW: 19"(483mm)

* All measurements taken with the BIFMA chair measuring device.

Features

- Back: Tension back.
- Tension back is fabric suspended between a frame.
- Seat: Standard upholstered foam.
- Base: Black plastic base.
- Arms: 4D with soft arm caps. Arm adjusts up and down, side to side, front to back and pivot.
- Mechanism: Weight assisted mechanism with tilt tension adjustment.
- Back-Lock: Single position upright back lock.
- Seat Depth Adjustment: 16.75"-19"(425mm-483mm).
- Optional Adjustable Lumbar: 4"(102mm) height adjustment, flexible lumbar support.
- Casters: Hard black casters.

To Order, Specify:

- 1) Product number.
- 2) Seat surface/color: 3A-18 Tellure - Black
- 3) Tension Back: 3T-18 Black
- 4) Trim color: TR-F Black

Note: No changes to specification.
No COM or Tailored Solutions.

Number	Price
SLT1-2T-7115A	\$655.60

Lively

Task Chair with 4D Arms



SLT1-2T-7115A

Dimensions

- *SH: 16"-21"
(406mm-533mm)
- H: 36"-41"
(914mm-1041mm)
- D: 24"(610mm)
- W: 28"(711mm)
- *SW: 19"(483mm)

* All measurements taken with the BIFMA chair measuring device.

Features

- Back: Tension back or fully upholstered.
- Tension back is fabric suspended between a frame.
- Fully upholstered back features a slim foam pad.
- Seat: Standard upholstered foam.
- Base: Black plastic base.
- Arms: 4D with soft arm caps. Arm adjusts up and down, side to side, front to back and pivot.
- Mechanism: Weight assisted mechanism with tilt tension adjustment.
- Back-Lock: Single position upright back lock.
- Optional Forward Tilt: 5° downward from initial position.
- Optional Seat Depth Adjustment: 16.75"-19"(425mm-483mm).
- Optional Adjustable Lumbar: 4"(102mm) height adjustment, flexible lumbar support.
- Casters: Standard with hard black casters; optional soft casters.
- COM yardage / COL square footage:
Tension back model: 0.66/4.1
Fully upholstered model: 0.75/8.2

To Order, Specify:

- 1) Product number, including;

① Seat or Seat Pad Option:

- Fixed Seat
- Adjustable Seat, add **\$33.75** list

- 2) Surface and color (seat).
- 3) Surface and color for tension back material (back).
- 4) Surface and color for fabric on fully upholstered (back).
- 5) Base.

Note: When specifying a fully upholstered chair; must also specify a tension back color for outside of back.

Leather Seat with Tension Back:

Change the fifth digit in the product number to **1**.

Example: SLT1-1T-7115A.

Leather Seat with Leather Back:

Change the fifth and sixth digits in the product number to **11**.

Example: SLT1-11-7115A.

Faux Leather Seat with Tension Back:

Change the fifth digit in the product number to **3**.

Example: SLT1-3T-7115A.

Upholstered Seat Adjustments	Number ①	Fabric Grade								Leather Grade A	Leather Grade B
		A	B	C	D	E	F	G	H		
No Lumbar Adjustment - Tension Back											
Back Lock	SLT1-2T-7015	\$724.41	\$755.90	\$ 789.65	\$ 805.41	\$ 818.89	\$ 848.15	\$ 875.14	\$ 947.14	\$1011.25	\$1151.86
Forward Tilt/Back Lock	SLT1-2T-7045	758.16	789.65	823.40	839.16	852.64	881.90	908.89	980.89	1045.00	1185.61
No Lumbar Adjustment - Fully Upholstered											
Back Lock	SLT1-22-7015	\$836.90	\$899.88	\$ 967.38	\$ 998.90	\$1025.86	\$1084.38	\$1138.36	\$1282.36	\$1410.58	\$1691.80
Forward Tilt/Back Lock	SLT1-22-7045	870.65	933.63	1001.13	1032.65	1059.61	1118.13	1172.11	1316.11	1444.33	1725.55
Lumbar Adjustment - Tension Back											
Back Lock	SLT1-2T-7115	\$780.65	\$812.14	\$ 845.89	\$ 861.65	\$ 875.13	\$ 904.39	\$ 931.38	\$1003.38	\$1067.49	\$1208.10
Forward Tilt/Back Lock	SLT1-2T-7145	814.40	845.89	879.64	895.40	908.88	938.14	965.13	1037.13	1101.24	1241.85
Lumbar Adjustment - Fully Upholstered											
Back Lock	SLT1-22-7115	\$893.14	\$956.12	\$1023.62	\$1055.14	\$1082.10	\$1140.62	\$1194.60	\$1338.60	\$1466.82	\$1748.04
Forward Tilt/Back Lock	SLT1-22-7145	926.89	989.87	1057.37	1088.89	1115.85	1174.37	1228.35	1372.35	1500.57	1781.79

The following options require modification of the product number.

- Soft Casters
- CAL 133
- Stain repellent

To specify, change the 10th digit from a **5** to a **6**; **Example:** SLT1-22-7016A

To specify, add **F** to the end of the product number; **Example:** SLT1-22-7015AF (add **\$132.74** list)

To specify, add **P** to end of the product number; **Example:** SLT1-22-7015AP (add **\$34.87** list)

NOTE: Stain repellent is available on SLT1-2T and SLT1-22 models only.

Lively

Task Chair with Height Adjustable Arms



SLT1-2T-4115A

Dimensions

*SH: 16"-21"
(406mm-533mm)
H: 36"-41"
(914mm-1041mm)
D: 24"(610mm)
W: 28"(711mm)
*SW: 19"(483mm)

* All measurements taken with the BIFMA chair measuring device.

Features

- Back: Tension back or fully upholstered.
- Tension back is fabric suspended between a frame.
- Fully upholstered back features a slim foam pad.
- Seat: Standard upholstered foam.
- Base: Black plastic base.
- Arms: Height adjustable arms with plastic uprights (black) with soft arm caps.
- Mechanism: Weight assisted mechanism with tilt tension adjustment.
- Back-Lock: Single position upright back lock.
- Optional Forward Tilt: 5° downward from initial position.
- Optional Seat Depth Adjustment: 16.75"-19"(425mm-483mm).
- Optional Adjustable Lumbar: 4"(102mm) height adjustment, flexible lumbar support.
- Casters: Standard with hard black casters; optional soft casters.
- COM yardage / COL square footage:
Tension back model: 0.66/4.1
Fully upholstered model: 0.75/8.2

To Order, Specify:

1) Product number, including;

1 Seat or Seat Pad Option:

- Fixed Seat
 Adjustable Seat, add **\$33.75** list

2) Surface and color (seat).

3) Surface and color for tension back material (back).

4) Surface and color for fabric on fully upholstered (back).

5) Base.

Note: When specifying a fully upholstered chair; must also specify a tension back color for outside of back.

Leather Seat with Tension Back:

Change the fifth digit in the product number to **1**.

Example: SLT1-1T-4115A.

Leather Seat with Leather Back:

Change the fifth and sixth digits in the product number to **11**.

Example: SLT1-11-4115A.

Faux Leather Seat with Tension Back:

Change the fifth digit in the product number to **3**.

Example: SLT1-3T-4115A.

Upholstered Seat Adjustments	Number ①	Fabric Grade								Leather Grade A	Leather Grade B
		A	B	C	D	E	F	G	H		
No Lumbar Adjustment - Tension Back											
Back Lock	SLT1-2T-4015	\$696.29	\$727.78	\$ 761.53	\$ 777.29	\$ 790.77	\$ 820.03	\$ 847.02	\$ 919.02	\$ 983.13	\$1123.74
Forward Tilt/Back Lock	SLT1-2T-4045	730.04	761.53	795.28	811.04	824.52	853.78	880.77	952.77	1016.88	1157.49
No Lumbar Adjustment - Fully Upholstered											
Back Lock	SLT1-22-4015	\$808.78	\$871.76	\$ 939.26	\$ 970.78	\$ 997.74	\$1056.26	\$1110.24	\$1254.24	\$1382.46	\$1663.68
Forward Tilt/Back Lock	SLT1-22-4045	842.53	905.51	973.01	1004.53	1031.49	1090.01	1143.99	1287.99	1416.21	1697.43
Lumbar Adjustment - Tension Back											
Back Lock	SLT1-2T-4115	\$752.53	\$784.02	\$ 817.77	\$ 833.53	\$ 847.01	\$ 876.27	\$ 903.26	\$ 975.26	\$1039.37	\$1179.98
Forward Tilt/Back Lock	SLT1-2T-4145	786.28	817.77	851.52	867.28	880.76	910.02	937.01	1009.01	1073.12	1213.73
Lumbar Adjustment - Fully Upholstered											
Back Lock	SLT1-22-4115	\$865.02	\$928.00	\$ 995.50	\$1027.02	\$1053.98	\$1112.50	\$1166.48	\$1310.48	\$1438.70	\$1719.92
Forward Tilt/Back Lock	SLT1-22-4145	898.77	961.75	1029.25	1060.77	1087.73	1146.25	1200.23	1344.23	1472.45	1753.67

The following options require modification of the product number.

Soft Casters

To specify, change the 10th digit from a **5** to a **6**; **Example:** SLT1-22-4016A

CAL 133

To specify, add **F** to the end of the product number; **Example:** SLT1-22-4015AF (add **\$132.74** list)

Stain repellent

To specify, add **P** to end of the product number; **Example:** SLT1-22-4015AP (add **\$34.87** list)

NOTE: Stain repellent is available on SLT1-2T and SLT1-22 models only.

Lively

Task Chair with Fixed Arms



SLT1-2T-1115A

Dimensions

- *SH: 16"-21"
(406mm-533mm)
- H: 36"-41"
(914mm-1041mm)
- D: 24"(610mm)
- W: 28"(711mm)
- *SW: 19"(483mm)

* All measurements taken with the BIFMA chair measuring device.

Features

- Back: Tension back or fully upholstered.
- Tension back is fabric suspended between a frame.
- Fully upholstered back features a slim foam pad.
- Seat: Standard upholstered foam.
- Base: Black plastic base.
- Arms: Black plastic fixed arms.
- Mechanism: Weight assisted mechanism with tilt tension adjustment.
- Back-Lock: Single position upright back lock.
- Optional Forward Tilt: 5° downward from initial position.
- Optional Seat Depth Adjustment: 16.75"-19"(425mm-483mm).
- Optional Adjustable Lumbar: 4"(102mm) height adjustment, flexible lumbar support.
- Casters: Standard with hard black casters; optional soft casters.
- COM yardage / COL square footage:
Tension back model: 0.66/4.1
Fully upholstered model: 0.75/8.2

To Order, Specify:

- 1) Product number, including;

1 Seat or Seat Pad Option:

- Fixed Seat
- Adjustable Seat, add **\$33.75** list

- 2) Surface and color (seat).
- 3) Surface and color for tension back material (back).
- 4) Surface and color for fabric on fully upholstered (back).
- 5) Base.

Note: When specifying a fully upholstered chair; must also specify a tension back color for outside of back.

Leather Seat with Tension Back:

Change the fifth digit in the product number to **1**.

Example: SLT1-1T-1115A.

Leather Seat with Leather Back:

Change the fifth and sixth digits in the product number to **11**.

Example: SLT1-11-1115A.

Faux Leather Seat with Tension Back:

Change the fifth digit in the product number to **3**.

Example: SLT1-3T-1115A.

Upholstered Seat Adjustments	Number 1	Fabric Grade								Leather Grade A	Leather Grade B
		A	B	C	D	E	F	G	H		
No Lumbar Adjustment - Tension Back											
Back Lock	SLT1-2T-1015	\$645.67	\$677.16	\$710.91	\$ 726.67	\$ 740.15	\$ 769.41	\$ 796.40	\$ 868.40	\$ 932.51	\$1073.12
Forward Tilt/Back Lock	SLT1-2T-1045	679.42	710.91	744.66	760.42	773.90	803.16	830.15	902.15	966.26	1106.87
No Lumbar Adjustment - Fully Upholstered											
Back Lock	SLT1-22-1015	\$758.16	\$821.14	\$888.64	\$ 920.16	\$ 947.12	\$1005.64	\$1059.62	\$1203.62	\$1331.84	\$1613.06
Forward Tilt/Back Lock	SLT1-22-1045	791.91	854.89	922.39	953.91	980.87	1039.39	1093.37	1237.37	1365.59	1646.81
Lumbar Adjustment - Tension Back											
Back Lock	SLT1-2T-1115	\$701.91	\$733.40	\$767.15	\$ 782.91	\$ 796.39	\$ 825.65	\$ 852.64	\$ 924.64	\$ 988.75	\$1129.36
Forward Tilt/Back Lock	SLT1-2T-1145	735.66	767.15	800.90	816.66	830.14	859.40	886.39	958.39	1022.50	1163.11
Lumbar Adjustment - Fully Upholstered											
Back Lock	SLT1-22-1115	\$814.40	\$877.38	\$944.88	\$ 976.40	\$1003.36	\$1061.88	\$1115.86	\$1259.86	\$1388.08	\$1669.30
Forward Tilt/Back Lock	SLT1-22-1145	848.15	911.13	978.63	1010.15	1037.11	1095.63	1149.61	1293.61	1421.83	1703.05

The following options require modification of the product number.

- Soft Casters
- CAL 133
- Stain repellent

To specify, change the 10th digit from a **5** to a **6**; **Example:** SLT1-22-1016A
 To specify, add **F** to the end of the product number; **Example:** SLT1-22-1015AF (add **\$132.74** list)
 To specify, add **P** to end of the product number; **Example:** SLT1-22-1015AP (add **\$34.87** list)

NOTE: Stain repellent is available on SLT1-2T and SLT1-22 models only.

Lively

Task Chair without Arms



SLT1-2T-0115A

Dimensions

*SH: 16"-21"
(406mm-533mm)
H: 36"-41"
(914mm-1041mm)
D: 24"(610mm)
W: 28"(711mm)
*SW: 19"(483mm)

* All measurements taken with the BIFMA chair measuring device.

Features

- Back: Tension back or fully upholstered.
- Tension back is fabric suspended between a frame.
- Fully upholstered back features a slim foam pad.
- Seat: Standard upholstered foam.
- Base: Black plastic base.
- Mechanism: Weight assisted mechanism with tilt tension adjustment.
- Back-Lock: Single position upright back lock.
- Optional Forward Tilt: 5° downward from initial position.
- Optional Seat Depth Adjustment: 16.75"-19"(425mm-483mm).
- Optional Adjustable Lumbar: 4"(102mm) height adjustment, flexible lumbar support.
- Casters: Standard with hard black casters; optional soft casters.
- COM yardage / COL square footage:
Tension back model: 0.66/4.1
Fully upholstered model: 0.75/8.2

To Order, Specify:

1) Product number, including;

1 Seat or Seat Pad Option:

- Fixed Seat
 Adjustable Seat, add \$33.75 list

2) Surface and color (seat).

3) Surface and color for tension back material (back).

4) Surface and color for fabric on fully upholstered (back).

5) Base.

Note: When specifying a fully upholstered chair; must also specify a tension back color for outside of back.

Leather Seat with Tension Back:

Change the fifth digit in the product number to **1**.

Example: SLT1-1T-0115A.

Leather Seat with Leather Back:

Change the fifth and sixth digits in the product number to **11**.

Example: SLT1-11-0115A.

Faux Leather Seat with Tension Back:

Change the fifth digit in the product number to **3**.

Example: SLT1-3T-0115A.

Upholstered Seat Adjustments	Number ①	Fabric Grade		C	D	E	F	G	H	Leather Grade A	Leather Grade B
		A	B								
No Lumbar Adjustment - Tension Back											
Back Lock	SLT1-2T-0015	\$589.43	\$620.92	\$654.67	\$670.43	\$683.91	\$ 713.17	\$ 740.16	\$ 812.16	\$ 876.27	\$1016.88
Forward Tilt/Back Lock	SLT1-2T-0045	623.18	654.67	688.42	704.18	717.66	746.92	773.91	845.91	910.02	1050.63
No Lumbar Adjustment - Fully Upholstered											
Back Lock	SLT1-22-0015	\$701.92	\$764.90	\$832.40	\$863.92	\$890.88	\$ 949.40	\$1003.38	\$1147.38	\$1275.60	\$1556.82
Forward Tilt/Back Lock	SLT1-22-0045	735.67	798.65	866.15	897.67	924.63	983.15	1037.13	1181.13	1309.35	1590.57
Lumbar Adjustment - Tension Back											
Back Lock	SLT1-2T-0115	\$645.67	\$677.16	\$710.91	\$726.67	\$740.15	\$ 769.41	\$ 796.40	\$ 868.40	\$ 932.51	\$1073.12
Forward Tilt/Back Lock	SLT1-2T-0145	679.42	710.91	744.66	760.42	773.90	803.16	830.15	902.15	966.26	1106.87
Lumbar Adjustment - Fully Upholstered											
Back Lock	SLT1-22-0115	\$758.16	\$821.14	\$888.64	\$920.16	\$947.12	\$1005.64	\$1059.62	\$1203.62	\$1331.84	\$1613.06
Forward Tilt/Back Lock	SLT1-22-0145	791.91	854.89	922.39	953.91	980.87	1039.39	1093.37	1237.37	1365.59	1646.81

The following options require modification of the product number.

Soft Casters
CAL 133
Stain repellent

To specify, change the 10th digit from a **5** to a **6**; **Example:** SLT1-22-0016A

To specify, add **F** to the end of the product number; **Example:** SLT1-22-0015AF (add \$132.74 list)

To specify, add **P** to end of the product number; **Example:** SLT1-22-0015AP (add \$34.87 list)

NOTE: Stain repellent is available on SLT1-2T and SLT1-22 models only.

Lively

Side Chair

With Arms



SLS1-2T-1H



SLS1-2T-11

Dimensions*

SH: 18"(457mm)
 H: 33"(838mm)
 D: 24.5"(622mm)
 W: 21.5"(536mm)
 SW: 19.5"(495mm)

* All measurements taken with the BIFMA chair measuring device.

Features

- Back: Tension back or fully upholstered.
- Tension back is fabric suspended between a frame.
- Fully upholstered back features a slim foam pad.
- Seat: Standard upholstered foam.
- Base: Steel painted in black or metallic silver.
- Arms: Fixed arms with black plastic arm cap.
- Side chair with glides can stack 5 high on the floor.
- Side chair with casters does NOT stack.
- COM yardage / COL square footage:
 Tension back model: 0.75/4.1
 Fully upholstered model: 0.75/8.2

To Order, Specify:

1) Product number, including;

1 Glide or Caster Option:

- K** Felt Glide
- H** Plastic Glide
- 1** Hard Casters add **\$16.87** list
- 2** Soft Casters add **\$16.87** list

- 2) Surface and color (seat).
- 3) Surface and color for tension back material (back).
- 4) Surface and color for fabric on fully upholstered (back).
- 5) Frame color.

Note: When specifying a fully upholstered chair; must also specify a tension back color for outside of back.

Leather Seat with Tension Back:

Change the fifth digit in the product number to **1**.

Example: SLS1-1T-1H.

Leather Seat with Leather Back:

Change the fifth and sixth digits in the product number to **11**.

Example: SLS1-11-1H.

Faux Leather Seat with Tension Back:

Change the fifth digit in the product number to **3**.

Example: SLS1-3T-1H.

Upholstered Seat	Number 1	Fabric Grade								Leather Grade A	Leather Grade B
		A	B	C	D	E	F	G	H		
Tension Back	SLS1-2T-1	\$415.07	\$447.69	\$482.57	\$498.31	\$512.93	\$542.18	\$570.30	\$644.55	\$565.80	\$ 700.79
Fully Upholstered	SLS1-22-1	431.94	497.18	566.94	598.42	627.66	686.16	742.40	890.90	733.40	1003.38

The following options require modification of the product number.

CAL 133

Stain repellent

To specify, add **F** to the end of the product number; **Example:** SLS1-2T-1HF (add **\$64.12** list)

To specify, add **P** to end of the product number; **Example:** SLS1-22-1HP (add **\$34.87** list)

Lively

Side Chair

Without Arms



SLS1-2T-0H



SLS1-2T-01

Dimensions*

- SH: 18"(457mm)
- H: 33"(838mm)
- D: 24.5"(622mm)
- W: 21.5"(536mm)
- SW: 19.5"(495mm)

* All measurements taken with the BIFMA chair measuring device.

Features

- Back: Tension back or fully upholstered.
- Tension back is fabric suspended between a frame.
- Fully upholstered back features a slim foam pad.
- Seat: Standard upholstered foam.
- Base: Steel painted in black or metallic silver.
- Side chair with glides can stack 5 high on the floor.
- Side chair with casters does NOT stack.
- COM yardage / COL square footage:
Tension back model: 0.75/4.1
Fully upholstered model: 0.75/8.2

To Order, Specify:

1) Product number, including;

1) Glide or Caster Option:

- K** Felt Glide
- H** Plastic Glide
- 1** Hard Casters add **\$16.87** list
- 2** Soft Casters add **\$16.87** list

- 2) Surface and color (seat).
- 3) Surface and color for tension back material (back).
- 4) Surface and color for fabric on fully upholstered (back).
- 5) Frame color.

Note: When specifying a fully upholstered chair; must also specify a tension back color for outside of back.

Leather Seat with Tension Back:

Change the fifth digit in the product number to **1**.

Example: SLS1-1T-0H.

Leather Seat with Leather Back:

Change the fifth and sixth digits in the product number to **11**.

Example: SLS1-11-0H.

Faux Leather Seat with Tension Back:

Change the fifth digit in the product number to **3**.

Example: SLS1-3T-0H.

Upholstered Seat	Number 1	Fabric Grade								Leather Grade A	Leather Grade B
		A	B	C	D	E	F	G	H		
Tension Back	SLS1-2T-0	\$358.83	\$391.45	\$426.33	\$442.07	\$456.69	\$485.94	\$514.06	\$588.31	\$509.56	\$644.55
Fully Upholstered	SLS1-22-0	375.70	440.94	510.70	542.18	571.42	629.92	686.16	834.66	677.16	947.14

The following options require modification of the product number.

- CAL 133
- Stain repellent

- To specify, add **F** to the end of the product number; **Example:** SLS1-2T-0HF (add **\$64.12** list)
- To specify, add **P** to end of the product number; **Example:** SLS1-22-0HP (add **\$34.87** list)

This page intentionally blank

**Features and Options
(Task and Executive)**

- Upholstered seat
- Soft mesh or upholstered back
- Soft mesh consists of chenille, poly-filament blend
- Pneumatic seat-height adjustment
- Optional low-position pneumatic seat-height adjustment: range 15"-18"(381-457mm) (steel base only)
- Optional height-and-depth adjustable lumbar
- Optional 3-position seat-depth adjustment (seat depth range: 16"-18"(406-457mm))
- Back stop, lockable in the upright position
- Tuck-away tilt tension adjustment
- Free-floating forward tilt
- 3-point tilt mechanism
- 3-dimensional arms, loop arms or armless
- Standard soft arm caps, upholstered (fabric or leather) arm caps, or vinyl gel arm caps
- Aluminum five-star base
- Finishes include: powder-coated paint (black or silver) and chrome
- Hard dual-wheel casters for carpeted floors (black)
- Optional soft dual-wheel casters for resilient floor surfaces (black)
- Contoured headrest on executive chair
- All **X99** models meet or exceed all ANSI/BIFMA durability standards for office seating

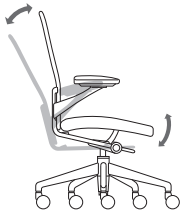
Mobility and Adjustability

- Back reclines 25° from the upright position
- Seat pan moves downward 3° from the initial position
- 3-dimensional arm adjustment
- Arm height adjustment: 4"(102mm)
- Arm cap slide range: 2.4"(61mm)
- Arm cap pivot range: 30° (18° in/12° out)

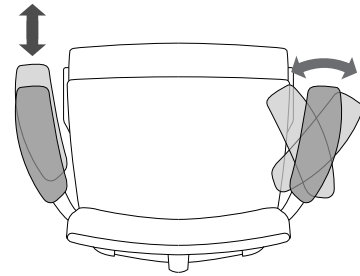
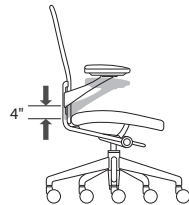

- Height-and-depth adjustable lumbar - mesh or upholstered back
- 4"(102mm) vertical adjustment; 1"(25mm) depth adjustment

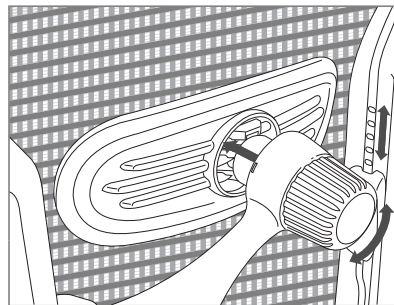
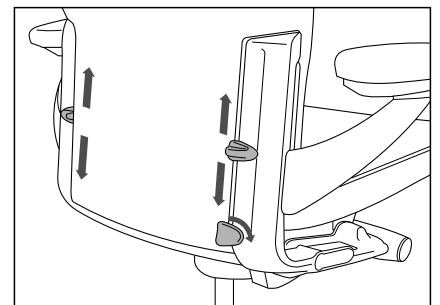
**Lumbar Adjustment, Mesh Back****Lumbar Adjustment, Upholstered Back****Standard Aluminum Base**

X99

General Specifications

- 3-position seat-depth up to 3.5 inches of adjustment

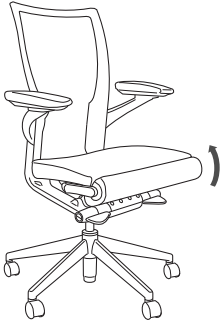

Features and Options (Guest Chair)

- Upholstered seat
- Soft mesh or upholstered back
- Soft mesh consists of chenille, poly-filament blend
- Black polypropylene arm caps
- Aluminum uprights with welded steel frame
- Finishes include: powder-coated paint (black or silver) and chrome
- Black nylon glides
- Stacks up to 4-high

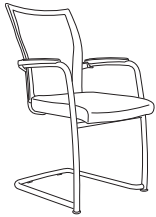

Shipping Weights (including packaging)

- Executive chair: 60 pounds/1 chair per carton/23.8 cubic feet
- Task chair: 52 pounds/1 chair per carton/19.7 cubic feet
- Guest chair with sled base: 35 pounds/1 chair per carton/19.5 cubic feet
- Seminar chair: 34 pounds/1 chair per carton/18.7 cubic feet
- Advanced Seminar chair: 40 pounds/1 chair per carton/16.0 cubic feet

General Guidelines for Product Specification

X99 specification numbers are based on an alpha-numeric logic that identifies a product by model and specific characteristics.

For instance, a product number that reads **X621-2Y41** identifies the product as an **X99** Task Chair, with 3-dimensional arms, mesh back and fabric upholstery seat, pneumatic height adjustment, and hard casters.

The numeric logic for this model with fabric and finish codes is shown below:

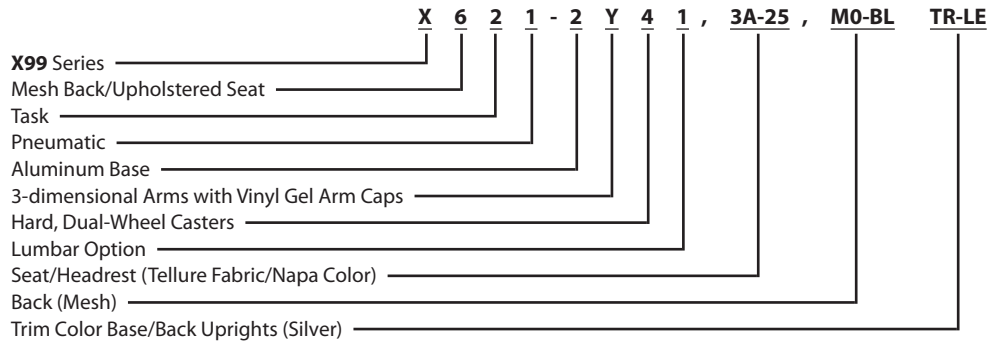

There are exceptions to this logic; therefore, always refer to the price charts for product numbers rather than attempting to construct them. Product number modification instructions for additional options appear in footnoted copy for each applicable model.

Beyond the printed product number, fabric and finish codes are required to complete an order specification. To communicate your order clearly, list the product number and finish codes in the sequence outlined on each price page.

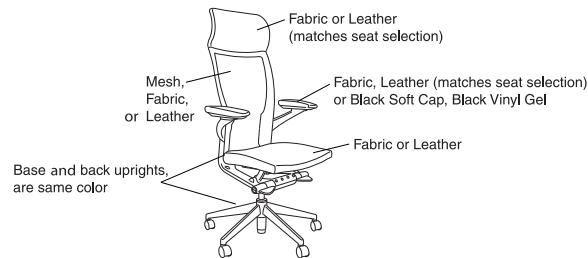

Note:

- Fully upholstered models require fabric/leather for seat and back to match. No dual fabrics or materials.
- Arms are black only.

COM & COL General Information

To order a COM fabric (Customer's Own Material), contact the Haworth Inquiry Center (1.800.426.8562), your local Haworth dealer, or go to haworth.com/surfaces > COM Library to find out if the COM you have selected has already been tested and approved. The surface collection site also has information on the Haworth+ alliance program with Carnegie, Luna Textiles, and Maharam as well as our industry-leading Pre-Approved COM program.

COM fabrics are placed into Grades based on the cost per linear yard. If a fabric's cost exceeds the range of our highest Grade it will be noted as Non-Graded. The product will be priced at Grade A; the COM fabric costs will appear as a separate line item. The fabric charge will be Haworth's purchase cost plus a 4% administrative fee (based on the cost of the fabric). Yardage calculations will include any applicable fabric repeat.

COM Leather products will be priced at a leather Grade A; COL costs will appear as a separate line item. The leather costs will be Haworth's purchase cost plus a 4% administrative fee (based on the cost of the leather).

X99

General Specifications

Finishes and Fabrics

A complete listing of finishes and fabrics for **X99** seating is available on pages 364 and 366-368.

Environmental FactorsMaterial Off Gassing

In an effort to ensure air quality standards, all **X99** parts suppliers are required to provide Material Data Sheets and/or other documentation, verifying their products do not emit volatile organic compounds (VOC). In addition, the powder-coat paint process used in the manufacturing of **X99** seating is free of VOCs. Our manufacturing processes have also eliminated all use of chlorofluorocarbons (CFCs) and ozone depleting chemicals (ODCs) in the chair's construction.

Recycling

All **X99** seating fabric scraps are recycled, reducing the amount of material sent to landfills, and all chair components disassemble easily to increase the potential for recycling. In addition, all thermo-plastic parts are 100% reprocessible, and all raw materials used in its manufacturing can be recycled at the end of the useful life of the product. Recyclable parts are identified with the recycle symbol where practical.

X99

Executive with 3-dimensional Arms

Deep Seat



X611-2W44

Dimensions*

- *SH: 16" - 20.5"
(406mm - 521mm)
- H: 47" - 51.5"
(1194mm - 1308mm)
- D: 25"(635mm)
- W: 26"(660mm)
- *SW: 18.6"(472mm)
- *AH: 6.3" - 10.8"
(160mm - 274mm)
- *SD: 17.5"(445mm)

Low-position pneumatic seat-height adjustment range:

15-18"(381mm-457mm)

Features

- Back: Soft mesh or upholstered.
- Seat: Standard upholstered.
- Base: Five-star aluminum base standard.
- Arm caps: Soft, upholstered or vinyl gel with pivoting and sliding capability.
- Casters: Standard with hard casters; for optional soft casters, see below.
- Mechanism: 3-point tilt.
- Height adjustment: Pneumatic or low position pneumatic; see below.
- Arm adjustment: 4"(102mm) height adjustment.
- Back stop: Single position.
- Free-floating forward tilt.
- Adjustable lumbar models available, with 1"(25mm) depth and 4"(102mm) height adjustment.
- COM yardage / COL square footage:
Mesh back model: 1.0/15
Fully upholstered model: 2.0/40
- Available on RUSH.

* Measurements taken with the BIFMA chair measuring device.

To Order, Specify:

- 1) Product number.
- 2) Fabric surface and color (seat/headrest/arm cap).
- 3) Fabric or mesh surface and color (back).
- 4) Trim color for base/back uprights. (Add **\$336.62** for chrome finish.)

Leather Upholstery Option:

Leather upholstery option requires modification of the product number. Change the second digit in the product number as follows:

Leather Seat with Mesh Back:

Change second digit in mesh back model to **5**.

Example: X511-2W44

Leather Seat with Leather Back:

Change second digit in upholstered back model to **7**.

Example: X711-2W44

Deep Seat	Back	Arm Caps	Number	Fabric Grade								Leather Grade A	Leather Grade B
				A	B	C	D	E	F	G	H		
Pneumatic Height													
Upholstered	Mesh	Soft	X611-2W44 ■	\$1976.00	\$2014.98	\$2052.77	\$2072.84	\$2088.21	\$2170.89	\$2213.40	\$2329.15	\$2301.99	\$2457.44
		Upholstered	X611-2X44 ■	2036.24	2075.22	2113.01	2133.08	2148.45	2231.13	2273.64	2389.39	2362.23	2517.68
		Vinyl Gel	X611-2Y44 ■	2036.24	2075.22	2113.01	2133.08	2148.45	2231.13	2273.64	2389.39	2362.23	2517.68
Upholstered	Upholstered	Soft	X811-2W44	\$2050.41	\$2128.37	\$2203.95	\$2244.09	\$2274.83	\$2440.19	\$2525.21	\$2756.71	\$2702.39	\$3013.29
		Upholstered	X811-2X44	2110.65	2188.61	2264.19	2304.33	2335.07	2500.43	2585.45	2816.95	2762.63	3073.53
		Vinyl Gel	X811-2Y44	2110.65	2188.61	2264.19	2304.33	2335.07	2500.43	2585.45	2816.95	2762.63	3073.53
Pneumatic Height Adjustment with Lumbar													
Upholstered	Mesh	Soft	X611-2W45 ■	\$2052.77	\$2091.75	\$2129.54	\$2149.61	\$2164.98	\$2247.66	\$2290.17	\$2405.92	\$2378.76	\$2534.21
		Upholstered	X611-2X45 ■	2113.01	2151.99	2189.78	2209.85	2225.22	2307.90	2350.41	2466.16	2439.00	2594.45
		Vinyl Gel	X611-2Y45 ■	2113.01	2151.99	2189.78	2209.85	2225.22	2307.90	2350.41	2466.16	2439.00	2594.45
Upholstered	Upholstered	Soft	X811-2W45	\$2127.18	\$2205.14	\$2280.72	\$2320.86	\$2351.60	\$2516.96	\$2601.98	\$2833.48	\$2779.16	\$3090.06
		Upholstered	X811-2X45	2187.42	2265.38	2340.96	2381.10	2411.84	2577.20	2662.22	2893.72	2839.40	3150.30
		Vinyl Gel	X811-2Y45	2187.42	2265.38	2340.96	2381.10	2411.84	2577.20	2662.22	2893.72	2839.40	3150.30

Soft Caster Option:

Soft caster option requires modification of the product number. Change the seventh digit in the product number from **4** to **2**.

Example: X611-2W24

CAL 133 Option:

CAL 133 option is available on mesh back models with upholstered arm caps only. To specify, add **-F** to the product number and add **\$114.57** list.

Low-position Pneumatic Option:

Low-position pneumatic option requires modification of the product number. To specify, change the fourth digit in the product number to **3**, and the fifth digit to **1**.

Example: X613-1W44

NOTE: Low-position pneumatic option will have a steel base.

X99

Executive with 3-dimensional Arms

Standard Seat



X611-2W40

Dimensions*

- *SH: 16" - 20.5"
(406mm - 521mm)
- H: 47" - 51.5"
(1194mm - 1308mm)
- D: 25"(635mm)
- W: 26"(660mm)
- *SW: 18.6"(472mm)
- *AH: 6.3" - 10.8"
(160mm - 274mm)
- *SD: 16"(407mm)

Low-position pneumatic seat-height adjustment range:
15-18"(381mm-457mm)

Features

- Back: Soft mesh or upholstered.
- Seat: Standard upholstered.
- Base: Five-star aluminum base standard.
- Arm caps: Soft, upholstered or vinyl gel with pivoting and sliding capability.
- Casters: Standard with hard casters; for optional soft casters, see page 163.
- Mechanism: 3-point tilt.
- Height adjustment: Pneumatic or low position pneumatic; see page 163.
- Arm adjustment: 4"(102mm) height adjustment.
- Back stop: Single position.
- Free-floating forward tilt.
- Adjustable lumbar models available, with 1"(25mm) depth and 4"(102mm) height adjustment.
- 3-position seat-depth adjustment models are available with a 3 1/2"(89mm) range.
- COM yardage / COL square footage:
Mesh back model: 1.0/15
Fully upholstered model: 2.0/40
- Available on RUSH.

* Measurements taken with the BIFMA chair measuring device.

To Order, Specify:

- 1) Product number.
- 2) Fabric surface and color (seat/headrest/arm cap).
- 3) Fabric or mesh surface and color (back).
- 4) Trim color for base/back uprights. (Add **\$336.62** for chrome finish.)

Leather Upholstery Option:

Leather upholstery option requires modification of the product number. Change the second digit in the product number as follows:

Leather Seat with Mesh Back:

Change second digit in mesh back model to **5**.

Example: X511-2W40

Leather Seat with Leather Back:

Change second digit in upholstered back model to **7**.

Example: X711-2W40

Standard Seat	Back	Arm Caps	Number	Fabric Grade								Leather Grade A	Leather Grade B
				A	B	C	D	E	F	G	H		
Pneumatic Height Adjustment													
Upholstered	Mesh	Soft	X611-2W40	\$1976.00	\$2014.98	\$2052.77	\$2072.84	\$2088.21	\$2170.89	\$2213.40	\$2329.15	\$2301.99	\$2457.44
		Upholstered	X611-2X40	2036.24	2075.22	2113.01	2133.08	2148.45	2231.13	2273.64	2389.39	2362.23	2517.68
		Vinyl Gel	X611-2Y40	2036.24	2075.22	2113.01	2133.08	2148.45	2231.13	2273.64	2389.39	2362.23	2517.68
Upholstered	Upholstered	Soft	X811-2W40	\$2050.41	\$2128.37	\$2203.95	\$2244.09	\$2274.83	\$2440.19	\$2525.21	\$2756.71	\$2702.39	\$3013.29
		Upholstered	X811-2X40	2110.65	2188.61	2264.19	2304.33	2335.07	2500.43	2585.45	2816.95	2762.63	3073.53
		Vinyl Gel	X811-2Y40	2110.65	2188.61	2264.19	2304.33	2335.07	2500.43	2585.45	2816.95	2762.63	3073.53
Pneumatic Height Adjustment with Lumbar													
Upholstered	Mesh	Soft	X611-2W41	\$2052.77	\$2091.75	\$2129.54	\$2149.61	\$2164.98	\$2247.66	\$2290.17	\$2405.92	\$2378.76	\$2534.21
		Upholstered	X611-2X41	2113.01	2151.99	2189.78	2209.85	2225.22	2307.90	2350.41	2466.16	2439.00	2594.45
		Vinyl Gel	X611-2Y41	2113.01	2151.99	2189.78	2209.85	2225.22	2307.90	2350.41	2466.16	2439.00	2594.45
Upholstered	Upholstered	Soft	X811-2W41	\$2127.18	\$2205.14	\$2280.72	\$2320.86	\$2351.60	\$2516.96	\$2601.98	\$2833.48	\$2779.16	\$3090.06
		Upholstered	X811-2X41	2187.42	2265.38	2340.96	2381.10	2411.84	2577.20	2662.22	2893.72	2839.40	3150.30
		Vinyl Gel	X811-2Y41	2187.42	2265.38	2340.96	2381.10	2411.84	2577.20	2662.22	2893.72	2839.40	3150.30

X99

Executive with 3-dimensional Arms

Standard Seat

Standard Seat	Back	Arm Caps	Number	Fabric Grade								Leather Grade A	Leather Grade B
				A	B	C	D	E	F	G	H		
Pneumatic Height Adjustment with Seat Depth Adjustment													
Upholstered	Mesh	Soft	X611-2W42	\$2129.55	\$2168.53	\$2206.32	\$2226.39	\$2241.76	\$2324.44	\$2366.95	\$2482.70	\$2455.54	\$2610.99
		Upholstered	X611-2X42	2189.79	2228.77	2266.56	2286.63	2302.00	2384.68	2427.19	2542.94	2515.78	2671.23
		Vinyl Gel	X611-2Y42	2189.79	2228.77	2266.56	2286.63	2302.00	2384.68	2427.19	2542.94	2515.78	2671.23
Upholstered	Upholstered	Soft	X811-2W42	\$2203.96	\$2281.92	\$2357.50	\$2397.64	\$2428.38	\$2593.74	\$2678.76	\$2910.26	\$2855.94	\$3166.84
		Upholstered	X811-2X42	2264.20	2342.16	2417.74	2457.88	2488.62	2653.98	2739.00	2970.50	2916.18	3227.08
		Vinyl Gel	X811-2Y42	2264.20	2342.16	2417.74	2457.88	2488.62	2653.98	2739.00	2970.50	2916.18	3227.08
Pneumatic Height Adjustment with Lumbar and Seat Depth Adjustment													
Upholstered	Mesh	Soft	X611-2W43	\$2206.32	\$2245.30	\$2283.09	\$2303.16	\$2318.53	\$2401.21	\$2443.72	\$2559.47	\$2532.31	\$2687.76
		Upholstered	X611-2X43	2266.56	2305.54	2343.33	2363.40	2378.77	2461.45	2503.96	2619.71	2592.55	2748.00
		Vinyl Gel	X611-2Y43	2266.56	2305.54	2343.33	2363.40	2378.77	2461.45	2503.96	2619.71	2592.55	2748.00
Upholstered	Upholstered	Soft	X811-2W43	\$2280.73	\$2358.69	\$2434.27	\$2474.41	\$2505.15	\$2670.51	\$2755.53	\$2987.03	\$2932.71	\$3243.61
		Upholstered	X811-2X43	2340.97	2418.93	2494.51	2534.65	2565.39	2730.75	2815.77	3047.27	2992.95	3303.85
		Vinyl Gel	X811-2Y43	2340.97	2418.93	2494.51	2534.65	2565.39	2730.75	2815.77	3047.27	2992.95	3303.85

Soft Caster Option:

Soft caster option requires modification of the product number. Change the seventh digit in the product number from **4** to **2**.

Example: X611-2W20

CAL 133 Option:

CAL 133 option is available on mesh back models with upholstered arm caps only. To specify, add **-F** to the product number and add **\$114.57** list.

Low-position Pneumatic Option:

Low-position pneumatic option requires modification of the product number. To specify, change the fourth digit in the product number to **3**, and the fifth digit to **1**.

Example: X613-1W40

NOTE: Low-position pneumatic option will have a steel base.

X99

Executive with Loop Arms

Deep Seat



X611-2144

Dimensions*

- *SH: 16" - 20.5"
(406mm - 521mm)
- H: 47" - 51.5"
(1194mm - 1308mm)
- D: 25"(635mm)
- W: 26"(660mm)
- *SW: 18.6"(472mm)
- *AH: 7.3"(185mm)
- *SD: 17.5"(445mm)

Low-position pneumatic seat-height adjustment range: 15-18"(381mm-457mm)

Features

- Back: Soft mesh or upholstered.
 - Seat: Standard upholstered.
 - Base: Five-star aluminum base standard.
 - Arms: Fixed loop with black polypropylene arm caps.
 - Casters: Standard with hard casters; for optional soft casters, see below.
 - Mechanism: 3-point tilt.
 - Height adjustment: Pneumatic or low-position pneumatic; see below.
 - Back stop: Single position.
 - Free-floating forward tilt.
 - Adjustable lumbar models available, with 1"(25mm) depth and 4"(102mm) height adjustment.
 - COM yardage / COL square footage:
 - Mesh back model: 1.0/15
 - Fully upholstered model: 2.0/40
- Available on RUSH.

* Measurements taken with the BIFMA chair measuring device.

To Order, Specify:

- 1) Product number.
- 2) Fabric surface and color (seat/headrest/arm cap).
- 3) Fabric or mesh surface and color (back).
- 4) Trim color for base/back uprights. (Add **\$336.62** for chrome finish.)

Leather Upholstery Option:

Leather upholstery option requires modification of the product number. Change the second digit in the product number as follows:

Leather Seat with Mesh Back:

Change second digit in mesh back model to **5**.

Example: X511-2144

Leather Seat with Leather Back:

Change second digit in upholstered back model to **7**.

Example: X711-2144

Deep Seat	Back	Arm Caps	Number	Fabric Grade								Leather Grade A	Leather Grade B
				A	B	C	D	E	F	G	H		
Pneumatic Height													
Upholstered	Mesh	Standard	X611-2144	\$1823.63	\$1862.61	\$1900.40	\$1920.47	\$1935.84	\$2018.52	\$2061.03	\$2176.78	\$2149.62	\$2305.07
Upholstered	Upholstered	Standard	X811-2144	1898.04	1976.00	2051.58	2091.72	2122.46	2287.82	2372.84	2604.34	2550.02	2860.92
Pneumatic Height Adjustment with Lumbar													
Upholstered	Mesh	Standard	X611-2145	\$1900.40	\$1939.38	\$1977.17	\$1997.24	\$2012.61	\$2095.29	\$2137.80	\$2253.55	\$2226.39	\$2381.84
Upholstered	Upholstered	Standard	X811-2145	1974.81	2052.77	2128.35	2168.49	2199.23	2364.59	2449.61	2681.11	2626.79	2937.69

Soft Caster Option:

Soft caster option requires modification of the product number. Change the seventh digit in the product number from **4** to **2**.

Example: X611-2124

Low-position Pneumatic Option:

Low-position pneumatic option requires modification of the product number. To specify, change the fourth digit in the product number to **3**, and the fifth digit to **1**.

Example: X613-1144

NOTE: Low-position pneumatic option will have a steel base.

X99

Executive with Loop Arms

Standard Seat



X611-2140

Dimensions*

- *SH: 16" - 20.5"
(406mm - 521mm)
- H: 47" - 51.5"
(1194mm - 1308mm)
- D: 25"(635mm)
- W: 26"(660mm)
- *SW: 18.6"(472mm)
- *AH: 7.3"(185mm)
- *SD: 16"(407mm)

Low-position pneumatic seat-height adjustment range:
15-18"(381mm-457mm)

Features

- Back: Soft mesh or upholstered.
- Seat: Standard upholstered.
- Base: Five-star aluminum base standard.
- Arms: Fixed loop with black polypropylene arm caps.
- Casters: Standard with hard casters; for optional soft casters, see below.
- Mechanism: 3-point tilt.
- Height adjustment: Pneumatic or low-position pneumatic; see below.
- Back stop: Single position.
- Free-floating forward tilt.
- Adjustable lumbar models available, with 1"(25mm) depth and 4"(102mm) height adjustment.
- 3-position seat-depth adjustment models are available with a 3 1/2"(89mm) range.
- COM yardage / COL square footage:
Mesh back model: 1.0/15
Fully upholstered model: 2.0/40
- Available on RUSH.

* Measurements taken with the BIFMA chair measuring device.

To Order, Specify:

- 1) Product number.
- 2) Fabric surface and color (seat/headrest/arm cap).
- 3) Fabric or mesh surface and color (back).
- 4) Trim color for base/back uprights. (Add **\$336.62** for chrome finish.)

Leather Upholstery Option:

Leather upholstery option requires modification of the product number. Change the second digit in the product number as follows:

Leather Seat with Mesh Back:

Change second digit in mesh back model to **5**.

Example: X511-2140

Leather Seat with Leather Back:

Change second digit in upholstered back model to **7**.

Example: X711-2140

Standard Seat	Back	Arm Caps	Number	Fabric Grade								Leather Grade A	Leather Grade B
				A	B	C	D	E	F	G	H		
Pneumatic Height Adjustment													
Upholstered	Mesh	Standard	X611-2140	\$1823.63	\$1862.61	\$1900.40	\$1920.47	\$1935.84	\$2018.52	\$2061.03	\$2176.78	\$2149.62	\$2305.07
Upholstered	Upholstered	Standard	X811-2140	1898.04	1976.00	2051.58	2091.72	2122.46	2287.82	2372.84	2604.34	2550.02	2860.92
Pneumatic Height Adjustment with Lumbar													
Upholstered	Mesh	Standard	X611-2141	\$1900.40	\$1939.38	\$1977.17	\$1997.24	\$2012.61	\$2095.29	\$2137.80	\$2253.55	\$2226.39	\$2381.84
Upholstered	Upholstered	Standard	X811-2141	1974.81	2052.77	2128.35	2168.49	2199.23	2364.59	2449.61	2681.11	2626.79	2937.69
Pneumatic Height Adjustment with Seat Depth Adjustment													
Upholstered	Mesh	Standard	X611-2142	\$1977.18	\$2016.16	\$2053.95	\$2074.02	\$2089.39	\$2172.07	\$2214.58	\$2330.33	\$2303.17	\$2458.62
Upholstered	Upholstered	Standard	X811-2142	2051.59	2129.55	2205.13	2245.27	2276.01	2441.37	2526.39	2757.89	2703.57	3014.47
Pneumatic Height Adjustment with Lumbar and Seat Depth Adjustment													
Upholstered	Mesh	Standard	X611-2143	\$2053.95	\$2092.93	\$2130.72	\$2150.79	\$2166.16	\$2248.84	\$2291.35	\$2407.10	\$2379.94	\$2535.39
Upholstered	Upholstered	Standard	X811-2143	2128.36	2206.32	2281.90	2322.04	2352.78	2518.14	2603.16	2834.66	2780.34	3091.24

Soft Caster Option:

Soft caster option requires modification of the product number. Change the seventh digit in the product number from **4** to **2**.

Example: X611-2120

Low-position Pneumatic Option:

Low-position pneumatic option requires modification of the product number. To specify, change the fourth digit in the product number to **3**, and the fifth digit to **1**.

Example: X613-1140

NOTE: Low-position pneumatic option will have a steel base.

X99

Executive without Arms

Deep Seat



X611-2044

Dimensions*

- *SH: 16" - 20.5"
(406mm - 521mm)
- H: 47" - 51.5"
(1194mm - 1308mm)
- D: 25"(635mm)
- W: 26"(660mm)
- *SW: 18.6"(472mm)
- *SD: 17.5"(445mm)

Low-position pneumatic seat-height adjustment range:
15-18"(381mm-457mm)

Features

- Back: Soft mesh or upholstered.
- Seat: Standard upholstered.
- Base: Five-star aluminum base standard.
- Casters: Standard with hard casters; for optional soft casters, see below.
- Mechanism: 3-point tilt.
- Height adjustment: Pneumatic or low-position pneumatic; see below.
- Back stop: Single position.
- Free-floating forward tilt.
- Adjustable lumbar models available, with 1"(25mm) depth and 4"(102mm) height adjustment.
- COM yardage / COL square footage:
Mesh back model: 1.0/15
Fully upholstered model: 2.0/40

* Measurements taken with the BIFMA chair measuring device.

To Order, Specify:

- 1) Product number.
- 2) Fabric surface and color (seat/headrest).
- 3) Fabric or mesh surface and color (back).
- 4) Trim color for base/back uprights. (Add **\$336.62** for chrome finish.)

Leather Upholstery Option:

Leather upholstery option requires modification of the product number. Change the second digit in the product number as follows:

Leather Seat with Mesh Back:

Change second digit in mesh back model to **5**.

Example: X511-2044

Leather Seat with Leather Back:

Change second digit in upholstered back model to **7**.

Example: X711-2044

Deep Seat	Back	Number	Fabric Grade								Leather Grade A	Leather Grade B
			A	B	C	D	E	F	G	H		
Pneumatic Height												
Upholstered	Mesh	X611-2044	\$1668.91	\$1707.89	\$1745.68	\$1765.75	\$1781.12	\$1863.80	\$1906.31	\$2022.06	\$1994.90	\$2150.35
Upholstered	Upholstered	X811-2044	1743.32	1821.28	1896.86	1937.00	1967.74	2133.10	2218.12	2449.62	2395.30	2706.20
Pneumatic Height Adjustment with Lumbar												
Upholstered	Mesh	X611-2045	\$1745.68	\$1784.66	\$1822.45	\$1842.52	\$1857.89	\$1940.57	\$1983.08	\$2098.83	\$2071.67	\$2227.12
Upholstered	Upholstered	X811-2045	1820.09	1898.05	1973.63	2013.77	2044.51	2209.87	2294.89	2526.39	2472.07	2782.97

Soft Caster Option:

Soft caster option requires modification of the product number. Change the seventh digit in the product number from **4** to **2**.
Example: X611-2024

CAL 133 Option:

CAL 133 option is available on mesh back models with upholstered arm caps only. To specify, add **-F** to the product number and add **\$114.57** list.

Low-position Pneumatic Option:

Low-position pneumatic option requires modification of the product number. To specify, change the fourth digit in the product number to **3**, and the fifth digit to **1**.
Example: X613-1044

NOTE: Low-position pneumatic option will have a steel base.

X99

Executive without Arms

Standard Seat



X611-2040

Dimensions*

- *SH: 16" - 20.5"
(406mm - 521mm)
- H: 47" - 51.5"
(1194mm - 1308mm)
- D: 25"(635mm)
- W: 26"(660mm)
- *SW: 18.6"(472mm)
- *SD: 16"(407mm)

Low-position pneumatic seat-height adjustment range:
15-18"(381mm-457mm)

Features

- Back: Soft mesh or upholstered.
- Seat: Standard upholstered.
- Base: Five-star aluminum base standard.
- Casters: Standard with hard casters; for optional soft casters, see below.
- Mechanism: 3-point tilt.
- Height adjustment: Pneumatic or low-position pneumatic; see below.
- Back stop: Single position.
- Free-floating forward tilt.
- Adjustable lumbar models available, with 1"(25mm) depth and 4"(102mm) height adjustment.
- 3-position seat-depth adjustment models are available with a 3 1/2"(89mm) range.
- COM yardage / COL square footage:
Mesh back model: 1.0/15
Fully upholstered model: 2.0/40

* Measurements taken with the BIFMA chair measuring device.

To Order, Specify:

- 1) Product number.
- 2) Fabric surface and color (seat/headrest).
- 3) Fabric or mesh surface and color (back).
- 4) Trim color for base/back uprights. (Add **\$336.62** for chrome finish.)

Leather Upholstery Option:

Leather upholstery option requires modification of the product number. Change the second digit in the product number as follows:

Leather Seat with Mesh Back:

Change second digit in mesh back model to **5**.

Example: X511-2040

Leather Seat with Leather Back:

Change second digit in upholstered back model to **7**.

Example: X711-2040

Standard Seat	Back	Number	Fabric Grade								Leather Grade A	Leather Grade B
			A	B	C	D	E	F	G	H		
Pneumatic Height Adjustment												
Upholstered	Mesh	X611-2040	\$1668.91	\$1707.89	\$1745.68	\$1765.75	\$1781.12	\$1863.80	\$1906.31	\$2022.06	\$1994.90	\$2150.35
Upholstered	Upholstered	X811-2040	1743.32	1821.28	1896.86	1937.00	1967.74	2133.10	2218.12	2449.62	2395.30	2706.20
Pneumatic Height Adjustment with Lumbar												
Upholstered	Mesh	X611-2041	\$1745.68	\$1784.66	\$1822.45	\$1842.52	\$1857.89	\$1940.57	\$1983.08	\$2098.83	\$2071.67	\$2227.12
Upholstered	Upholstered	X811-2041	1820.09	1898.05	1973.63	2013.77	2044.51	2209.87	2294.89	2526.39	2472.07	2782.97
Pneumatic Height Adjustment with Seat Depth Adjustment												
Upholstered	Mesh	X611-2042	\$1822.46	\$1861.44	\$1899.23	\$1919.30	\$1934.67	\$2017.35	\$2059.86	\$2175.61	\$2148.45	\$2303.90
Upholstered	Upholstered	X811-2042	1896.87	1974.83	2050.41	2090.55	2121.29	2286.65	2371.67	2603.17	2548.85	2859.75
Pneumatic Height Adjustment with Lumbar and Seat Depth Adjustment												
Upholstered	Mesh	X611-2043	\$1899.23	\$1938.21	\$1976.00	\$1996.07	\$2011.44	\$2094.12	\$2136.63	\$2252.38	\$2225.22	\$2380.67
Upholstered	Upholstered	X811-2043	1973.64	2051.60	2127.18	2167.32	2198.06	2363.42	2448.44	2679.94	2625.62	2936.52

Soft Caster Option:

Soft caster option requires modification of the product number. Change the seventh digit in the product number from **4** to **2**.

Example: X611-2020

CAL 133 Option:

CAL 133 option is available on mesh back models with upholstered arm caps only. To specify, add **-F** to the product number and add **\$114.57** list.

Low-position Pneumatic Option:

Low-position pneumatic option requires modification of the product number. To specify, change the fourth digit in the product number to **3**, and the fifth digit to **1**.

Example: X613-1040

NOTE: Low-position pneumatic option will have a steel base.

This page intentionally blank

X99

Task Chair with 3-dimensional Arms

Deep Seat



X621-2W44

Dimensions*

*SH: 16" - 20.5"
(406mm - 521mm)
H: 38.5" - 43"
(978mm - 1092mm)
D: 25"(635mm)
W: 26"(660mm)
*SW: 18.6"(472mm)
*AH: 6.3" - 10.8"
(160mm - 274mm)
*SD: 17.5"(445mm)

Low-position pneumatic
seat-height adjustment
range:

15-18"(381mm-457mm)

Features

- Back: Soft mesh or upholstered.
- Seat: Standard upholstered.
- Base: Five-star aluminum base standard.
- Arm caps: Soft, upholstered or vinyl gel with pivoting and sliding capability.
- Casters: Standard with hard casters; for optional soft casters, see below.
- Mechanism: 3-point tilt.
- Height adjustment: Pneumatic or low-position pneumatic; see below.
- Arm adjustment: 4"(102mm) height adjustment.
- Back stop: Single position.
- Free-floating forward tilt.
- Adjustable lumbar models available, with 1"(25mm) depth and 4"(102mm) height adjustment.
- COM yardage / COL square footage:
Mesh back model: 0.75/15
Fully upholstered model: 1.75/25

■ Available on RUSH.

* Measurements taken with the BIFMA chair measuring device.

To Order, Specify:

- 1) Product number.
- 2) Fabric surface and color (seat/arm cap).
- 3) Fabric or mesh surface and color (back).
- 4) Trim color for base/back uprights. (Add **\$336.62** for chrome finish.)

Leather Upholstery Option:

Leather upholstery option requires modification of the product number. Change the second digit in the product number as follows:

Leather Seat with Mesh Back:

Change second digit in mesh back model to **5**.

Example: X521-2W44

Leather Seat with Leather Back:

Change second digit in upholstered back model to **7**.

Example: X721-2W44

Deep Seat	Back	Arm Caps	Number	Fabric Grade						Leather Grade A	Leather Grade B		
				A	B	C	D	E	F			G	H
Pneumatic Height													
Upholstered	Mesh	Soft	X621-2W44 ■	\$1820.09	\$1859.07	\$1896.86	\$1916.93	\$1932.30	\$1966.55	\$1998.44	\$2085.84	\$2146.08	\$2301.53
		Upholstered	X621-2X44 ■	1880.33	1919.31	1957.10	1977.17	1992.54	2026.79	2058.68	2146.08	2206.32	2361.77
		Vinyl Gel	X621-2Y44 ■	1880.33	1919.31	1957.10	1977.17	1992.54	2026.79	2058.68	2146.08	2206.32	2361.77
Upholstered	Upholstered	Soft	X821-2W44	\$1896.86	\$1974.82	\$2050.40	\$2090.54	\$2121.28	\$2189.78	\$2253.56	\$2428.36	\$2548.84	\$2859.74
		Upholstered	X821-2X44	1957.10	2035.06	2110.64	2150.78	2181.52	2250.02	2313.80	2488.60	2609.08	2919.98
		Vinyl Gel	X821-2Y44	1957.10	2035.06	2110.64	2150.78	2181.52	2250.02	2313.80	2488.60	2609.08 ■	2919.98
Pneumatic Height Adjustment with Lumbar													
Upholstered	Mesh	Soft	X621-2W45 ■	\$1896.86	\$1935.84	\$1973.63	\$1993.70	\$2009.07	\$2043.32	\$2075.21	\$2162.61	\$2222.85	\$2378.30
		Upholstered	X621-2X45 ■	1957.10	1996.08	2033.87	2053.94	2069.31	2103.56	2135.45	2222.85	2283.09	2438.54
		Vinyl Gel	X621-2Y45 ■	1957.10	1996.08	2033.87	2053.94	2069.31	2103.56	2135.45	2222.85	2283.09	2438.54
Upholstered	Upholstered	Soft	X821-2W45	\$1973.63	\$2051.59	\$2127.17	\$2167.31	\$2198.05	\$2266.55	\$2330.33	\$2505.13	\$2625.61	\$2936.51
		Upholstered	X821-2X45	2033.87	2111.83	2187.41	2227.55	2258.29	2326.79	2390.57	2565.37	2685.85	2996.75
		Vinyl Gel	X821-2Y45	2033.87	2111.83	2187.41	2227.55	2258.29	2326.79	2390.57	2565.37	2685.85 ■	2996.75

Soft Caster Option:

Soft caster option requires modification of the product number. Change the seventh digit in the product number from **4** to **2**.

Example: X621-2W24

CAL 133 Option:

CAL 133 option is available on mesh back models with upholstered arm caps only. To specify, add **-F** to the product number and add **\$114.57** list.

Stain Repellent Option:

To specify, add **-P** to end of the product number and add **\$37.79** list.

Example: X621-2W44-P

For available fabrics, refer to surfaces.haworth.com.

Low-position Pneumatic Option:

Low-position pneumatic option requires modification of the product number. To specify, change the fourth digit in the product number to **3**, and the fifth digit to **1**.

Example: X623-1W44

NOTE: Low-position pneumatic option will have a steel base.

X99

Task Chair with 3-dimensional Arms

Standard Seat



X621-2W40

Dimensions*

- *SH: 16" - 20.5"
(406mm - 521mm)
- H: 38.5" - 43"
(978mm - 1092mm)
- D: 25"(635mm)
- W: 26"(660mm)
- *SW: 18.6"(472mm)
- *AH: 6.3" - 10.8"
(160mm - 274mm)
- *SD: 16"(407mm)

Low-position pneumatic seat-height adjustment range:
15-18"(381mm-457mm)

Features

- Back: Soft mesh or upholstered.
- Seat: Standard upholstered.
- Base: Five-star aluminum base standard.
- Arm caps: Soft, upholstered or vinyl gel with pivoting and sliding capability.
- Casters: Standard with hard casters; for optional soft casters, see page 171.
- Mechanism: 3-point tilt.
- Height adjustment: Pneumatic or low-position pneumatic; see page 171.
- Arm adjustment: 4"(102mm) height adjustment.
- Back stop: Single position.
- Free-floating forward tilt.
- Adjustable lumbar models available, with 1"(25mm) depth and 4"(102mm) height adjustment.
- 3-position seat-depth adjustment models are available with a 3 1/2"(89mm) range.
- COM yardage / COL square footage:
Mesh back model: 0.75/15
Fully upholstered model: 1.75/25

■ Available on RUSH.

* Measurements taken with the BIFMA chair measuring device.

To Order, Specify:

- 1) Product number.
- 2) Fabric surface and color (seat/arm cap).
- 3) Fabric or mesh surface and color (back).
- 4) Trim color for base/back uprights. (Add **\$336.62** for chrome finish.)

Leather Upholstery Option:

Leather upholstery option requires modification of the product number. Change the second digit in the product number as follows:

Leather Seat with Mesh Back:

Change second digit in mesh back model to **5**.

Example: X521-2W40

Leather Seat with Leather Back:

Change second digit in upholstered back model to **7**.

Example: X721-2W40

Standard Seat	Back	Arm Caps	Number	Fabric Grade								Leather Grade A	Leather Grade B
				A	B	C	D	E	F	G	H		
Pneumatic Height Adjustment													
Upholstered	Mesh	Soft	X621-2W40 ■	\$1820.09	\$1859.07	\$1896.86	\$1916.93	\$1932.30	\$1966.55	\$1998.44	\$2085.84	\$2146.08	\$2301.53
		Upholstered	X621-2X40 ■	1880.33	1919.31	1957.10	1977.17	1992.54	2026.79	2058.68	2146.08	2206.32	2361.77
		Vinyl Gel	X621-2Y40 ■	1880.33	1919.31	1957.10	1977.17	1992.54	2026.79	2058.68	2146.08	2206.32	2361.77
Upholstered	Upholstered	Soft	X821-2W40	\$1896.86	\$1974.82	\$2050.40	\$2090.54	\$2121.28	\$2189.78	\$2253.56	\$2428.36	\$2548.84	\$2859.74
		Upholstered	X821-2X40	1957.10	2035.06	2110.64	2150.78	2181.52	2250.02	2313.80	2488.60	2609.08	2919.98
		Vinyl Gel	X821-2Y40	1957.10	2035.06	2110.64	2150.78	2181.52	2250.02	2313.80	2488.60	2609.08 ■	2919.98
Pneumatic Height Adjustment with Lumbar													
Upholstered	Mesh	Soft	X621-2W41 ■	\$1896.86	\$1935.84	\$1973.63	\$1993.70	\$2009.07	\$2043.32	\$2075.21	\$2162.61	\$2222.85	\$2378.30
		Upholstered	X621-2X41 ■	1957.10	1996.08	2033.87	2053.94	2069.31	2103.56	2135.45	2222.85	2283.09	2438.54
		Vinyl Gel	X621-2Y41 ■	1957.10	1996.08	2033.87	2053.94	2069.31	2103.56	2135.45	2222.85	2283.09	2438.54
Upholstered	Upholstered	Soft	X821-2W41	\$1973.63	\$2051.59	\$2127.17	\$2167.31	\$2198.05	\$2266.55	\$2330.33	\$2505.13	\$2625.61	\$2936.51
		Upholstered	X821-2X41	2033.87	2111.83	2187.41	2227.55	2258.29	2326.79	2390.57	2565.37	2685.85	2996.75
		Vinyl Gel	X821-2Y41	2033.87	2111.83	2187.41	2227.55	2258.29	2326.79	2390.57	2565.37	2685.85 ■	2996.75

Seat	Back	Arm Caps	Number	Fabric Grade								Leather Grade A	Leather Grade B
				A	B	C	D	E	F	G	H		
Pneumatic Height Adjustment with Seat Depth Adjustment													
Upholstered	Mesh	Soft	X621-2W42	\$1974.81	\$2013.79	\$2051.58	\$2071.65	\$2087.02	\$2121.27	\$2153.16	\$2240.56	\$2300.80	\$2456.25
		Upholstered	X621-2X42	2035.05	2074.03	2111.82	2131.89	2147.26	2181.51	2213.40	2300.80	2361.04	2516.49
		Vinyl Gel	X621-2Y42	2035.05	2074.03	2111.82	2131.89	2147.26	2181.51	2213.40	2300.80	2361.04	2516.49
Upholstered	Upholstered	Soft	X821-2W42	\$2051.58	\$2129.54	\$2205.12	\$2245.26	\$2276.00	\$2344.50	\$2408.28	\$2583.08	\$2703.56	\$3014.46
		Upholstered	X821-2X42	2111.82	2189.78	2265.36	2305.50	2336.24	2404.74	2468.52	2643.32	2763.80	3074.70
		Vinyl Gel	X821-2Y42	2111.82	2189.78	2265.36	2305.50	2336.24	2404.74	2468.52	2643.32	2763.80	3074.70
Pneumatic Height Adjustment with Lumbar and Seat Depth Adjustment													
Upholstered	Mesh	Soft	X621-2W43	\$2051.58	\$2090.56	\$2128.35	\$2148.42	\$2163.79	\$2198.04	\$2229.93	\$2317.33	\$2377.57	\$2533.02
		Upholstered	X621-2X43	2111.82	2150.80	2188.59	2208.66	2224.03	2258.28	2290.17	2377.57	2437.81	2593.26
		Vinyl Gel	X621-2Y43	2111.82	2150.80	2188.59	2208.66	2224.03	2258.28	2290.17	2377.57	2437.81	2593.26
Upholstered	Upholstered	Soft	X821-2W43	\$2128.35	\$2206.31	\$2281.89	\$2322.03	\$2352.77	\$2421.27	\$2485.05	\$2659.85	\$2780.33	\$3091.23
		Upholstered	X821-2X43	2188.59	2266.55	2342.13	2382.27	2413.01	2481.51	2545.29	2720.09	2840.57	3151.47
		Vinyl Gel	X821-2Y43	2188.59	2266.55	2342.13	2382.27	2413.01	2481.51	2545.29	2720.09	2840.57	3151.47

Soft Caster Option:

Soft caster option requires modification of the product number. Change the seventh digit in the product number from **4** to **2**.

Example: X621-2W20

CAL 133 Option:

CAL 133 option is available on mesh back models with upholstered arm caps only. To specify, add **-F** to the product number and add **\$114.57** list.

Stain Repellent Option:

To specify, add **-P** to end of the product number and add **\$37.79** list.

Example: X621-2W40-P

For available fabrics, refer to surfaces.haworth.com.

Low-position Pneumatic Option:

Low-position pneumatic option requires modification of the product number. To specify, change the fourth digit in the product number to **3**, and the fifth digit to **1**.

Example: X623-1W40

NOTE: Low-position pneumatic option will have a steel base.

X99

Task Chair with Loop Arms

Deep Seat



X621-2144

Dimensions*

- *SH: 16" - 20.5"
(406mm - 521mm)
- H: 38.5" - 43"
(978mm-1092mm)
- D: 25"(635mm)
- W: 26"(660mm)
- *SW: 18.6"(472mm)
- *AH: 7.3"(185mm)
- *SD: 17.5"(445mm)

Low-position pneumatic seat-height adjustment range:

15-18"(381mm-457mm)

Features

- Back: Soft mesh or upholstered.
- Seat: Standard upholstered.
- Base: Five-star aluminum base standard.
- Arms: Fixed loop with black polypropylene arm caps.
- Casters: Standard with hard casters; for optional soft casters, see below.
- Mechanism: 3-point tilt.
- Height adjustment: Pneumatic or low-position pneumatic; see below.
- Back stop: Single position.
- Free-floating forward tilt.
- Adjustable lumbar models available, with 1"(25mm) depth and 4"(102mm) height adjustment.
- COM yardage / COL square footage:
Mesh back model: 0.75/15
Fully upholstered model: 1.75/25

■ Available on RUSH.

* Measurements taken with the BIFMA chair measuring device.

To Order, Specify:

- 1) Product number.
- 2) Fabric surface and color (seat/arm cap).
- 3) Fabric or mesh surface and color (back).
- 4) Trim color for base/back uprights. (Add **\$336.62** for chrome finish.)

Leather Upholstery Option:

Leather upholstery option requires modification of the product number. Change the second digit in the product number as follows:

Leather Seat with Mesh Back:

Change second digit in mesh back model to **5**.

Example: X521-2144

Leather Seat with Leather Back:

Change second digit in upholstered back model to **7**.

Example: X721-2144

Deep Seat	Back	Arm Caps	Number	Fabric Grade								Leather Grade A	Leather Grade B
				A	B	C	D	E	F	G	H		
Pneumatic Height													
Upholstered	Mesh	Standard	X621-2144 ■	\$1668.90	\$1707.88	\$1745.67	\$1765.74	\$1781.11	\$1815.36	\$1847.25	\$1934.65	\$1994.89	\$2150.34
Upholstered	Upholstered	Standard	X821-2144	1745.67	1823.63	1899.21	1939.35	1970.09	2038.59	2102.37	2277.17	2397.65 ■	2708.55
Pneumatic Height Adjustment with Lumbar													
Upholstered	Mesh	Standard	X621-2145 ■	\$1745.67	\$1784.65	\$1822.44	\$1842.51	\$1857.88	\$1892.13	\$1924.02	\$2011.42	\$2071.66	\$2227.11
Upholstered	Upholstered	Standard	X821-2145	1822.44	1900.40	1975.98	2016.12	2046.86	2115.36	2179.14	2353.94	2474.42 ■	2785.32

Soft Caster Option:

Soft caster option requires modification of the product number. Change the seventh digit in the product number from **4** to **2**.
Example: X621-2124

Stain Repellent Option:

To specify, add **-P** to end of the product number and add **\$37.79** list.
Example: X621-2144-P
For available fabrics, refer to surfaces.haworth.com.

Low-position Pneumatic Option:

Low-position pneumatic option requires modification of the product number. To specify, change the fourth digit in the product number to **3**, and the fifth digit to **1**.
Example: X623-1144

NOTE: Low-position pneumatic option will have a steel base.

X99

Task Chair with Loop Arms

Standard Seat



X621-2140

Dimensions*

- *SH: 16" - 20.5"
(406mm - 521mm)
- H: 38.5" - 43"
(978mm-1092mm)
- D: 25"(635mm)
- W: 26"(660mm)
- *SW: 18.6"(472mm)
- *AH: 7.3"(185mm)
- *SD: 16"(407mm)

Low-position pneumatic seat-height adjustment range:
15-18"(381mm-457mm)

Features

- Back: Soft mesh or upholstered.
- Seat: Standard upholstered.
- Base: Five-star aluminum base standard.
- Arms: Fixed loop with black polypropylene arm caps.
- Casters: Standard with hard casters; for optional soft casters, see below.
- Mechanism: 3-point tilt.
- Height adjustment: Pneumatic or low-position pneumatic; see below.
- Back stop: Single position.
- Free-floating forward tilt.
- Adjustable lumbar models available, with 1"(25mm) depth and 4"(102mm) height adjustment.
- 3-position seat-depth adjustable models are available with a 3 1/2"(89mm) range.
- COM yardage / COL square footage:
Mesh back model: 0.75/15
Fully upholstered model: 1.75/25
- Available on RUSH.

* Measurements taken with the BIFMA chair measuring device.

To Order, Specify:

- 1) Product number.
- 2) Fabric surface and color (seat/arm cap).
- 3) Fabric or mesh surface and color (back).
- 4) Trim color for base/back uprights. (Add **\$336.62** for chrome finish.)

Leather Upholstery Option:

Leather upholstery option requires modification of the product number. Change the second digit in the product number as follows:

Leather Seat with Mesh Back:

Change second digit in mesh back model to **5**.

Example: X521-2140

Leather Seat with Leather Back:

Change second digit in upholstered back model to **7**.

Example: X721-2140

Standard Seat	Back	Arm Caps	Number	Fabric Grade								Leather Grade A	Leather Grade B
				A	B	C	D	E	F	G	H		
Pneumatic Height Adjustment													
Upholstered	Mesh	Standard	X621-2140 ■	\$1668.90	\$1707.88	\$1745.67	\$1765.74	\$1781.11	\$1815.36	\$1847.25	\$1934.65	\$1994.89	\$2150.34
Upholstered	Upholstered	Standard	X821-2140	1745.67	1823.63	1899.21	1939.35	1970.09	2038.59	2102.37	2277.17	2397.65	2708.55
Pneumatic Height Adjustment with Lumbar													
Upholstered	Mesh	Standard	X621-2141 ■	\$1745.67	\$1784.65	\$1822.44	\$1842.51	\$1857.88	\$1892.13	\$1924.02	\$2011.42	\$2071.66	\$2227.11
Upholstered	Upholstered	Standard	X821-2141	1822.44	1900.40	1975.98	2016.12	2046.86	2115.36	2179.14	2353.94	2474.42	2785.32
Pneumatic Height Adjustment with Seat Depth Adjustment													
Upholstered	Mesh	Standard	X621-2142 ■	\$1823.62	\$1862.60	\$1900.39	\$1920.46	\$1935.83	\$1970.08	\$2001.97	\$2089.37	\$2149.61	\$2305.06
Upholstered	Upholstered	Standard	X821-2142	1900.39	1978.35	2053.93	2094.07	2124.81	2193.31	2257.09	2431.89	2552.37	2863.27
Pneumatic Height Adjustment with Lumbar and Seat Depth Adjustment													
Upholstered	Mesh	Standard	X621-2143 ■	\$1900.39	\$1939.37	\$1977.16	\$1997.23	\$2012.60	\$2046.85	\$2078.74	\$2166.14	\$2226.38	\$2381.83
Upholstered	Upholstered	Standard	X821-2143	1977.16	2055.12	2130.70	2170.84	2201.58	2270.08	2333.86	2508.66	2629.14	2940.04

Soft Caster Option:

Soft caster option requires modification of the product number. Change the seventh digit in the product number from **4** to **2**.

Example: X621-2120

Stain Repellent Option:

To specify, add **-P** to end of the product number and add **\$37.79** list.

Example: X621-2140-P

For available fabrics, refer to surfaces.haworth.com.

Low-position Pneumatic Option:

Low-position pneumatic option requires modification of the product number. To specify, change the fourth digit in the product number to **3**, and the fifth digit to **1**.

Example: X623-1140

NOTE: Low-position pneumatic option will have a steel base.

X99

Task Chair without Arms

Deep Seat



X621-2044

Dimensions*

- *SH: 16" - 20.5"
(406mm - 521mm)
- H: 38.5" - 43"
(978mm-1092mm)
- D: 25"(635mm)
- W: 26"(660mm)
- *SW: 18.6"(472mm)
- *SD: 17.5"(445mm)

Low-position pneumatic seat-height adjustment range:
15-18"(381mm-457mm)

Features

- Back: Soft mesh or upholstered.
- Seat: Standard upholstered.
- Base: Five-star aluminum base standard.
- Casters: Standard with hard casters; for optional soft casters, see below.
- Mechanism: 3-point tilt.
- Height adjustment: Pneumatic or low-position pneumatic; see below.
- Back stop: Single position.
- Free-floating forward tilt.
- Adjustable lumbar models available, with 1"(25mm) depth and 4"(102mm) height adjustment.
- COM yardage / COL square footage:
Mesh back model: 0.75/15
Fully upholstered model: 1.75/25

* Measurements taken with the BIFMA chair measuring device.

To Order, Specify:

- 1) Product number.
- 2) Fabric surface and color (seat).
- 3) Fabric or mesh surface and color (back).
- 4) Trim color for base/back uprights. (Add **\$336.62** for chrome finish.)

Leather Upholstery Option:

Leather upholstery option requires modification of the product number. Change the second digit in the product number as follows:

Leather Seat with Mesh Back:

Change second digit in mesh back model to **5**.

Example: X521-2044

Leather Seat with Leather Back:

Change second digit in upholstered back model to **7**.

Example: X721-2044

Deep Seat	Back	Number	Fabric Grade		C	D	E	F	G	H	Leather Grade A	Leather Grade B
			A	B								
Pneumatic Height												
Upholstered	Mesh	X621-2044	\$1514.18	\$1553.16	\$1590.95	\$1611.02	\$1626.39	\$1660.64	\$1692.53	\$1779.93	\$1840.17	\$1995.62
Upholstered	Upholstered	X821-2044	1590.95	1668.91	1744.49	1784.63	1815.37	1883.87	1947.65	2122.45	2242.93	2553.83
Pneumatic Height Adjustment with Lumbar												
Upholstered	Mesh	X621-2045	\$1590.95	\$1629.93	\$1667.72	\$1687.79	\$1703.16	\$1737.41	\$1769.30	\$1856.70	\$1916.94	\$2072.39
Upholstered	Upholstered	X821-2045	1667.72	1745.68	1821.26	1861.40	1892.14	1960.64	2024.42	2199.22	2319.70	2630.60

Soft Caster Option:

Soft caster option requires modification of the product number. Change the seventh digit in the product number from **4** to **2**.

Example: X621-2024

CAL 133 Option:

CAL 133 option is available on mesh back models only. To specify, add **-F** to the product number and add **\$114.57** list.

Stain Repellent Option:

To specify, add **-P** to end of the product number and add **\$37.79** list.

Example: X621-2044-P

For available fabrics, refer to surfaces.haworth.com.

Low-position Pneumatic Option:

Low-position pneumatic option requires modification of the product number. To specify, change the fourth digit in the product number to **3**, and the fifth digit to **1**.

Example: X623-1044

NOTE: Low-position pneumatic option will have a steel base.

X99

Task Chair without Arms

Standard Seat



X621-2040

Dimensions*

- *SH: 16" - 20.5"
(406mm - 521mm)
- H: 38.5" - 43"
(978mm-1092mm)
- D: 25"(635mm)
- W: 26"(660mm)
- *SW: 18.6"(472mm)
- *SD: 16"(407mm)

Seat depth adjustment model:
16"-18"(407mm-457mm)

Low-position pneumatic seat-height adjustment range:
15-18"(381mm-457mm)

Features

- Back: Soft mesh or upholstered.
- Seat: Standard upholstered.
- Base: Five-star aluminum base standard.
- Casters: Standard with hard casters; for optional soft casters, see below.
- Mechanism: 3-point tilt.
- Height adjustment: Pneumatic or low-position pneumatic; see below.
- Back stop: Single position.
- Free-floating forward tilt.
- Adjustable lumbar models available, with 1"(25mm) depth and 4"(102mm) height adjustment.
- 3-position seat-depth adjustment models are available with a 3 1/2"(89mm) range.
- COM yardage / COL square footage:
Mesh back model: 0.75/15
Fully upholstered model: 1.75/25

* Measurements taken with the BIFMA chair measuring device.

To Order, Specify:

- 1) Product number.
- 2) Fabric surface and color (seat).
- 3) Fabric or mesh surface and color (back).
- 4) Trim color for base/back uprights. (Add **\$336.62** for chrome finish.)

Leather Upholstery Option:

Leather upholstery option requires modification of the product number. Change the second digit in the product number as follows:

Leather Seat with Mesh Back:

Change second digit in mesh back model to **5**.

Example: X521-2040

Leather Seat with Leather Back:

Change second digit in upholstered back model to **7**.

Example: X721-2040

Seat	Back	Number	Fabric Grade		C	D	E	F	G	H	Leather Grade A	Leather Grade B
			A	B								
Pneumatic Height Adjustment												
Upholstered	Mesh	X621-2040	\$1514.18	\$1553.16	\$1590.95	\$1611.02	\$1626.39	\$1660.64	\$1692.53	\$1779.93	\$1840.17	\$1995.62
Upholstered	Upholstered	X821-2040	1590.95	1668.91	1744.49	1784.63	1815.37	1883.87	1947.65	2122.45	2242.93	2553.83
Pneumatic Height Adjustment with Lumbar												
Upholstered	Mesh	X621-2041	\$1590.95	\$1629.93	\$1667.72	\$1687.79	\$1703.16	\$1737.41	\$1769.30	\$1856.70	\$1916.94	\$2072.39
Upholstered	Upholstered	X821-2041	1667.72	1745.68	1821.26	1861.40	1892.14	1960.64	2024.42	2199.22	2319.70	2630.60
Pneumatic Height Adjustment with Seat Depth Adjustment												
Upholstered	Mesh	X621-2042	\$1668.90	\$1707.88	\$1745.67	\$1765.74	\$1781.11	\$1815.36	\$1847.25	\$1934.65	\$1994.89	\$2150.34
Upholstered	Upholstered	X821-2042	1745.67	1823.63	1899.21	1939.35	1970.09	2038.59	2102.37	2277.17	2397.65	2708.55
Pneumatic Height Adjustment with Lumbar and Seat Depth Adjustment												
Upholstered	Mesh	X621-2043	\$1745.67	\$1784.65	\$1822.44	\$1842.51	\$1857.88	\$1892.13	\$1924.02	\$2011.42	\$2071.66	\$2227.11
Upholstered	Upholstered	X821-2043	1822.44	1900.40	1975.98	2016.12	2046.86	2115.36	2179.14	2353.94	2474.42	2785.32

Soft Caster Option:

Soft caster option requires modification of the product number. Change the seventh digit in the product number from **4** to **2**.

Example: X621-2020

CAL 133 Option:

CAL 133 option is available on mesh back models only. To specify, add **-F** to the product number and add **\$114.57** list.

Stain Repellent Option:

To specify, add **-P** to end of the product number and add **\$37.79** list.

Example: X621-2040-P

For available fabrics, refer to surfaces.haworth.com.

Low-position Pneumatic Option:

Low-position pneumatic option requires modification of the product number. To specify, change the fourth digit in the product number to **3**, and the fifth digit to **1**.

Example: X623-1040

NOTE: Low-position pneumatic option will have a steel base.

X99

Guest Chair

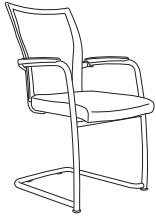

X630-3100

Dimensions*

- *SH: 18"(457mm)
- H: 36"(914)
- D: 24"(610mm)
- W: 22"(559mm)
- *SW: 19"(483mm)
- *SD: 18"(457mm)
- *AH: 8"(203mm)

Features

- Back: Soft mesh or upholstered.
- Seat: Standard upholstered.
- Arms: Black polypropylene arm caps.
- Black glides only.
- Aluminum uprights with welded steel frame.
- COM yardage / COL square footage:
 Mesh back model: 0.5/15
 Fully upholstered model: 1.4/25

■ Available on RUSH.

* Measurements taken with the BIFMA chair measuring device.

To Order, Specify:

- 1) Product number.
- 2) Fabric surface and color (seat).
- 3) Fabric or mesh surface and color (back).
- 4) Trim color for frame.
(Add **\$199.61** for chrome finish.)

Leather Upholstery Option:

Leather upholstery option requires modification of the product number. Change the second digit in the product number as follows:

Leather Seat with Mesh Back:

Change second digit in mesh back model to **5**.

Example: X530-3100

Leather Seat with Leather Back:

Change second digit in upholstered back model to **7**.

Example: X730-3100

Seat	Back	Arm Caps	Number	Fabric Grade								Leather Grade A	Leather Grade B
				A	B	C	D	E	F	G	H		
Upholstered	Mesh	Standard	X630-3100 ■	\$ 994.48	\$1033.46	\$1071.25	\$1091.32	\$1106.69	\$1140.94	\$1172.83	\$1260.23	\$1320.47	\$1475.92
Upholstered	Upholstered	Standard	X830-3100	1070.08	1148.04	1223.62	1263.76	1294.50	1363.00	1426.78	1601.58	1722.06	2032.96

CAL 133 Option:

CAL 133 option is available on mesh back models only. To specify, add **-F** to the product number and add **\$114.57** list.

Stain Repellent Option:

To specify, add **-P** to end of the product number and add **\$37.79** list.

Example: X630-3100-P

For available fabrics, refer to surfaces.haworth.com.

Moisture Barrier Option:

To specify, add **-D** to end of the product number and add **\$49.60** list.

Example: X630-3100-D

For available fabrics, refer to surfaces.haworth.com.

X99

Seminar Chair

With Arms



X840-0140

Dimensions*

- *SH: 18"(457mm)
- H: 36"(914mm)
- D: 24"(610mm)
- W: 22"(559mm)
- *SW: 19"(483mm)
- *SD: 18"(457mm)
- *AH: 8"(203mm)

Features

- Back: Soft mesh or upholstered.
- Seat: Standard upholstered, with folding seat.
- Arms: Black polypropylene arm caps.
- Casters: Standard with hard casters; or optional soft casters, see below.
- Optional black glides, see below.
- Aluminum uprights with welded steel frame.
- Each nested chair adds 7.5"(191mm) of floor space.
- COM yardage / COL square footage:
 Mesh back model: 0.5/15
 Fully upholstered model: 1.4/25
- Casters shipped unassembled.

■ Available on RUSH.

* Measurements taken with the BIFMA chair measuring device.

To Order, Specify:

- 1) Product number.
- 2) Fabric surface and color (seat).
- 3) Fabric or mesh surface and color (back).
- 4) Trim color for frame.
(Add **\$336.62** for chrome finish.)

Leather Upholstery Option:

Leather upholstery option requires modification of the product number. Change the second digit in the product number as follows:

Leather Seat with Mesh Back:

Change second digit in mesh back model to **5**.

Example: X540-0140

Leather Seat with Leather Back:

Change second digit in upholstered back model to **7**.

Example: X740-0140

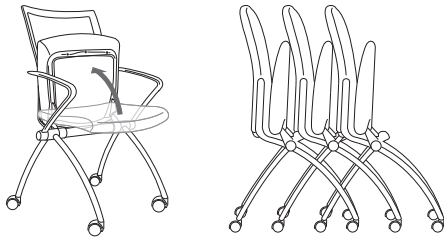

Seat	Back	Arm Caps	Number	Fabric Grade								Leather Grade A	Leather Grade B
				A	B	C	D	E	F	G	H		
Upholstered	Mesh	Standard	X640-0140 ■	\$ 956.68	\$ 995.66	\$1033.45	\$1053.52	\$1068.89	\$1103.14	\$1135.03	\$1222.43	\$1282.67	\$1438.12
Upholstered	Upholstered	Standard	X840-0140	1032.28	1110.24	1185.82	1225.96	1256.70	1325.20	1388.98	1563.78	1684.26	1995.16

Soft Caster Option:

Soft caster option requires modification of the product number. Change the seventh digit in the product number from **4** to **2**.

Example: X640-0120

Glide Option:

Glide option requires modification of the product number. Change the seventh digit in the product number from **4** to **0**.

Example: X640-0100

X99

Seminar Chair

Without Arms



X640-0040

Dimensions*

- *SH: 18"(457mm)
- H: 36"(914mm)
- D: 24"(610mm)
- W: 22"(559mm)
- *SW: 19"(483mm)
- *SD: 18"(457mm)

Features

- Back: Soft mesh or upholstered.
- Seat: Standard upholstered, with folding seat.
- Casters: Standard with hand casters; or optional soft casters, see below.
- Optional black glides, see below.
- Aluminum uprights with welded steel frame.
- COM yardage / COL square footage:
 Mesh back model: 0.5/15
 Fully upholstered model: 1.4/25
- Casters shipped unassembled.

* Measurements taken with the BIFMA chair measuring device.

To Order, Specify:

- 1) Product number.
- 2) Fabric surface and color (seat).
- 3) Fabric surface and color (back). (Specify M0-BL for mesh back).
- 4) Trim color for frame. (Add **\$336.62** for chrome finish.)

Leather Upholstery Option:

Leather upholstery option requires modification of the product number. Change the second digit in the product number as follows:

Leather Seat with Mesh Back:

Change second digit in mesh back model to **5**.

Example: X540-0040

Leather Seat with Leather Back:

Change second digit in upholstered back model to **7**.

Example: X740-0040

Seat	Back	Number	Fabric Grade							Leather Grade A	Leather Grade B	
			A	B	C	D	E	F	G			H
Upholstered	Mesh	X640-0040	\$895.27	\$ 934.25	\$ 972.04	\$ 992.11	\$1007.48	\$1041.73	\$1073.62	\$1161.02	\$1221.26	\$1376.71
Upholstered	Upholstered	X840-0040	970.87	1048.83	1124.41	1164.55	1195.29	1263.79	1327.57	1502.37	1622.85	1933.75

Soft Caster Option:

Soft caster option requires modification of the product number. Change the seventh digit in the product number from **4** to **2**.

Example: X640-0020

Stain Repellent Option:

To specify, add **-P** to end of product number and add **\$37.79** list.

Example: X640-0040-**P**

For available fabrics, refer to surfaces.haworth.com.

Glide Option:

Glide option requires modification of the product number. Change the seventh digit in the product number from **4** to **0**.

Example: X640-0000

Moisture Barrier Option:

To specify, add **-D** to end of product number and add **\$49.60** list.

Example: X640-0040-**D**

For available fabrics, refer to surfaces.haworth.com.

CAL 133 Option:

CAL 133 option is available on mesh back models only. To specify, add **-F** to the product number and add **\$114.57** list.

X99

Advanced Seminar Chair

With Arms



X641-2140

Dimensions*

- *SH: 16" - 21"
(406mm - 533mm)
- H: 33 1/2" - 38 1/2"
(851mm - 978mm)
- D: 26 1/2"(673mm)
- W: 26 1/2"(673mm)
- *SW: 18 1/2"(470mm)
- *SD: 16"(406mm)
- *AH: 8"(203mm)

Features

- Back: Soft mesh or upholstered.
- Seat: Standard upholstered.
- Arms: Black polypropylene arm caps.
- Base: Five-star aluminum base.
- Casters: Standard with hard casters; or optional soft casters, see below.
- Back tilts backward 21° from the upright position.
- Optional chrome finish chairs are standard with chrome base, uprights and back crossbar.
- COM yardage / COL square footage:
Mesh back model: 0.5/15
Fully upholstered model: 1.4/25
- Available on RUSH.

* Measurements taken with the BIFMA chair measuring device.

To Order, Specify:

- 1) Product number.
- 2) Fabric surface and color (seat).
- 3) Fabric or mesh surface and color (back).
- 4) Trim color for frame. (Add **\$336.62** for chrome finish.)

Leather Upholstery Option:

Leather upholstery option requires modification of the product number. Change the second digit in the product number as follows:

Leather Seat with Mesh Back:

Change second digit in mesh back model to **5**.

Example: X541-2140

Leather Seat with Leather Back:

Change second digit in upholstered back model to **7**.

Example: X741-2140

Seat	Back	Arm Caps	Number	Fabric Grade								Leather Grade A	Leather Grade B
				A	B	C	D	E	F	G	H		
Upholstered	Mesh	Standard	X641-2140 ■	\$1109.07	\$1148.05	\$1185.84	\$1205.91	\$1221.28	\$1255.53	\$1287.42	\$1374.82	\$1435.06	\$1590.51
Upholstered	Upholstered	Standard	X841-2140	1184.67	1262.63	1338.21	1378.35	1409.09	1477.59	1541.37	1716.17	1836.65	2147.55

Soft Caster Option:

Soft caster option requires modification of the product number. Change the seventh digit in the product number from **4** to **2**.

Example: X641-2120

X99

Advanced Seminar Chair

Without Arms



X641-2040

Dimensions*

- *SH: 16" - 21"
(406mm - 533mm)
- H: 33 1/2" - 38 1/2"
(851mm - 978mm)
- D: 26 1/2" (673mm)
- W: 26 1/2" (673mm)
- *SW: 18 1/2" (470mm)
- *SD: 16" (406mm)

Features

- Back: Soft mesh or upholstered.
- Seat: Standard upholstered.
- Base: Five-star aluminum base.
- Casters: Standard with hand casters; or optional soft casters, see below.
- Back tilts backward 21° from the upright position.
- Optional chrome finish chairs are standard with chrome base, uprights and back crossbar.
- COM yardage / COL square footage:
Mesh back model: 0.5/15
Fully upholstered model: 1.4/25
- Available on RUSH.

* Measurements taken with the BIFMA chair measuring device.

To Order, Specify:

- 1) Product number.
- 2) Fabric surface and color (seat).
- 3) Fabric surface and color (back).
- 4) Trim color for frame. (Add **\$336.62** for chrome finish.)

Leather Upholstery Option:

Leather upholstery option requires modification of the product number. Change the second digit in the product number as follows:

Leather Seat with Mesh Back:

Change second digit in mesh back model to **5**.
Example: X541-2040

Leather Seat with Leather Back:

Change second digit in upholstered back model to **7**.
Example: X741-2040

Seat	Back	Number	Fabric Grade								Leather Grade A	Leather Grade B
			A	B	C	D	E	F	G	H		
Upholstered	Mesh	X641-2040 ■	\$1048.83	\$1087.81	\$1125.60	\$1145.67	\$1161.04	\$1195.29	\$1227.18	\$1314.58	\$1374.82	\$1530.27
Upholstered	Upholstered	X841-2040	1124.43	1202.39	1277.97	1318.11	1348.85	1417.35	1481.13	1655.93	1776.41	2087.31

Soft Caster Option:

Soft caster option requires modification of the product number. Change the seventh digit in the product number from **4** to **2**.
Example: X641-2020

CAL 133 Option:

CAL 133 option is available on mesh back models only. To specify, add **-F** to the product number and add **\$114.57** list.

Stain Repellent Option:

To specify, add **-P** to end of product number and add **\$37.79** list.
Example: X641-2040-P
For available fabrics, refer to surfaces.haworth.com.

Improv Series

General Specifications

Features and Options (Desk Chairs)

Improv Series desk chairs features:

- Molded-polyfoam, contoured seat and back cushions
- Polypropylene or upholstered outer shell
- Optional steel base with plastic cover
- Hard, dual-wheel casters for carpeted floors (black)
- Optional soft, dual-wheel casters for resilient floor surfaces (black)
- Pneumatic height adjustment
- Optional high arc plastic base
- Loop arms, height-adjustable arms or armless
- Standard hard arm caps or upholstered (fabric, leather, or soft black vinyl) arm caps
- Optional two-stage seat height adjustment and low-position seat height adjustment
- Improv does offer Nano-Tex and DuraBlock on the fully upholstered back chair models.
- Tilt tension

Improv Series desk chairs meet or exceed all ANSI/BIFMA durability standards for office seating.

Mobility and Adjustability (Desk Chairs)

The following features are available on Improv Series desk chair models.



- ▶ Synchronized-tilt (standard)
 - Back and seat recline at a 2:1 ratio with no front seat rise
 - Back tilts backwards 15° from the upright position
 - Seat pan moves downward 7° from the initial position

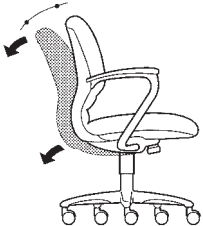

- ▶ Synchronized-tilt with back-lock
 - Back and seat recline at a 2:1 ratio with no front seat rise
 - Back is lockable in two positions within tilt range
 - Back tilts backwards 15° from the upright position
 - Seat pan moves downward 7° from the initial position
 - Back is lockable in two positions within tilt range, full upright and 5° recline

- ▶ Two-stage seat height adjustment
HAB or 2 stage seat height
(14.3"-21.9"(363mm-556mm))

- ▶ Low-position seat height adjustment
(14"-19"(356mm-483mm))

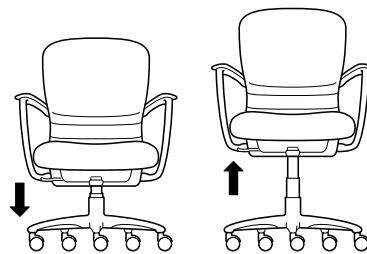

Fully Retracted (.7"(18mm) below standard) Fully Extended (1.9"(48mm) above standard)

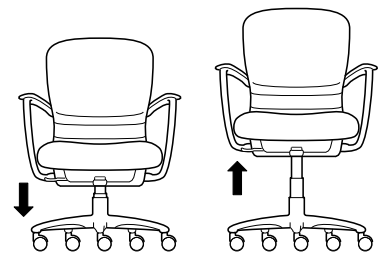

Fully Retracted (1"(25mm) below standard) Fully Extended (1"(25mm) below standard)

- ▶ Optional high arc base

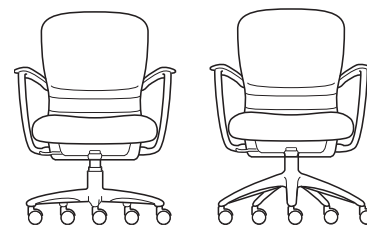

Standard Steel Base High Arc Base
Standard or High Arc Base seat height
(15"-20"(381mm-508mm))

Improv Series

General Specifications

Features and Options (Improv H.E.)

Improv H.E. chairs features:

- Molded-polyfoam, contoured seat and back cushions
- Separate seat and back cushions
- Polypropylene outer shell
- Five-star base with black casters only
- Hard dual-wheel casters (standard) or soft dual-wheel casters (optional)
- Pneumatic seat height adjustment
- Flipper arms, height-adjustable task arms, task arms, 3-D arms or armless
- Optional two-stage seat height adjustment or low-position seat height adjustment
- Optional adjustable air lumbar
- Optional high arc plastic base
- Optional H.E. XL chair for users up to 500 pounds

Mobility and Adjustability (Improv H.E., Tag and S.E.)

The following features are available on Improv H.E. and S.E. chair models (Refer to price page for specific features).



- Synchronized-tilt (standard)
 - Back and seat recline at a 2:1 ratio with no front seat rise
 - Back tilts backward 20° from the upright position
 - Seat pan moves downward 10° from the initial position



- Synchronized-tilt with back-lock
 - Back and seat recline at a 2:1 ratio with no front seat rise
 - Back is lockable in two positions within tilt range
 - Back tilts backward 20° from the upright position
 - Seat pan moves downward 10° from the initial position

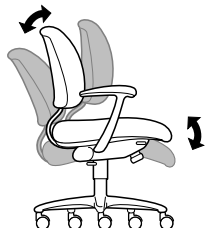

- Forward-tilt
 - Both chair back and seat pan are lockable in three forward positions (1°, 3°, and 5°)

- Adjustable Air Lumbar (H.E. only)
 - Back lumbar has up to 1.5"(38mm) of in/out deflection.



- Seat pan and arms slide horizontally within a 3"(76mm) range

- Two-stage seat height adjustment

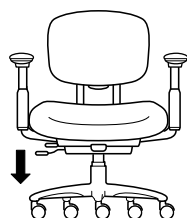

Fully Retracted
(.7"(18mm) below standard)

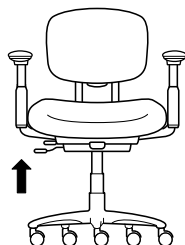

Full Extended
(1.9"(48mm) above standard)

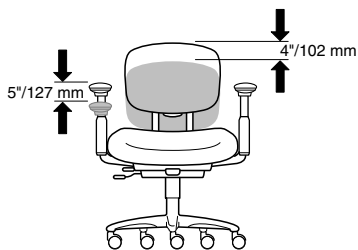

- Back adjusts vertically within a 4"(102mm) range (H.E. only)
- Flipper arms adjust vertically within a 5"(127mm) range

- Low-position seat height adjustment

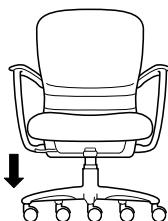

Fully Retracted
(1"(25mm) below standard)

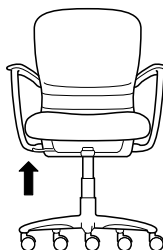

Fully Extended
(1"(25mm) below standard)

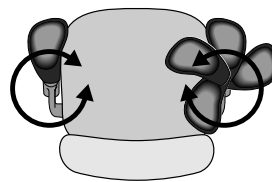

- Flipper arms rotate 360°

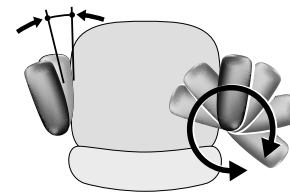

- 3D arms adjust vertically within a 4"(102mm) range and rotate 360°.

- Adjustable Air Lumbar (H.E. only)



- Back lumbar has up to 1.5"(38mm) of in/out deflection.

Improv Series

General Specifications

**Features and Options
(Improv S.E.)**

All Improv S.E. chairs feature

- Molded-polyfoam contoured seat
- Mesh “form fit” back available as round or square
- Five-star plastic high arc base with black casters only
- Hard dual-wheel casters (standard) or soft dual-wheel casters (optional)
- Pneumatic seat height adjustment
- Flipper arms, height-adjustable task arms, task arms, 3-D arms or armless
- Optional two-stage seat height adjustment
- Optional low-position seat height adjustment
- Optional steel base

Mobility and adjustability - Refer to page 182

These two features are not available on Improv S.E.

- Adjustable air lumbar
- Vertical back adjustment

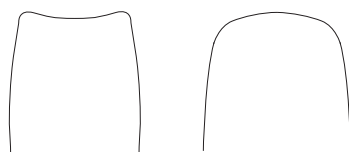
S.E. Back Shapes

Square

Round

**Features and Options
(Leg-Base and Sled-Base Chairs)**

Improv Series leg-base and sled-base models feature

- 14-gauge elliptical steel tubing legs
- 14-gauge steel side and front stretchers (with arms, tablet and chairs with casters)
- 11-gauge steel front stretchers (without arms)
- Molded polyurethane seat and back foam
- Optional wood back
- Polypropylene or upholstered outer back shell, or full wood back
- High-density polyethylene floor glides (leg-base models)
- Leg base models available with caster option
- Glass-filled nylon sled-base runners with high-density polyethylene floor glides (sled-base models)
- Powder coated frame
- Ganging device option
- Leg-base models with arms stack 6-high (44”(1118mm)) on the floor and 10-high (62”(1575mm)) on the stacking dolly
- Leg-base armless models stack 6-high (44”(1118mm)) on the floor and 10-high (58”(1473mm)) on the stacking dolly
- Leg-base models with casters stack 5-high (42”(1067mm)) on the floor and 6-high (50”(1270mm)) on the stacking dolly
- Wood back model has same stacking capabilities as the leg-base models

Arm chair models feature:

- Glass reinforced polypropylene arms

Armless models feature:

- High-density polyethylene top caps on exposed legs

Tablet arm models feature:

- Right- or left-hand flip-up tablet arm
- 11”(279mm) or 14”(356mm) tablet arms
- Plywood core with high-pressure laminate surface and clear lacquered edge

All Improv table models feature:

- 1”(25mm)-thick particle board core top with laminate or veneer finished surface
- Bullnose PVC or chamfered hardwood edges
- 14-gauge oval steel tube legs
- 3/4” diameter steel stretchers
- High-density polyethylene floor glides
- High-density polyethylene leg top caps

Improv series chairs meet or exceed ANSI/BIFMA durability standards for office seating.

Improv Series

General Specifications

Shipping Weights (Leg-Base and Sled-Base Chairs)	<p>The following weights include packaging materials</p> <ul style="list-style-type: none"> • All leg-base and sled-base chairs 25 lbs. per chair/9.6 cubic ft. (up to 3 chairs per carton) • 20"(508mm) diameter tables 19 lbs./5.3 cubic ft. • 24" x 48"(610mm x 1219mm) oval tables 35 lbs./11 cubic ft. • Chairs without tablet arms are packaged three (3) per carton • Chairs with tablet arms are packaged two (2) per carton • Chairs with leather seats are packaged one (1) per carton <p>NOTE: Models with casters: add one (1) pound per chair</p>
Features and Options (Stools)	<p>All Improv Series stools feature</p> <ul style="list-style-type: none"> • 14-gauge elliptical steel tubing legs • 14-gauge steel side and front stretchers • 14-gauge steel foot rest with lightly textured protective nylon cover • Molded polyurethane seat foam, 1 3/8"(35mm) thick • Molded polyurethane back foam, 7/8"(22mm) thick • Optional wood back • Polypropylene (3/4"(19mm)) or upholstered (1 1/4"(32mm)) seat and back shell • High-density polyethylene floor glides • Glass reinforced polypropylene arms or high-density polyethylene top caps on exposed legs • Powder coated frame
Shipping Weights (Stools)	<p>The following weights do not include packaging materials.</p> <p>Stool with arms: 30 lbs./13.608k Stool without arms: 27 lbs./12.247k</p>
COM & COL General Information	<p>To order a COM fabric (Customer's Own Material), contact the Haworth Inquiry Center (1.800.426.8562), your local Haworth dealer, or go to haworth.com/surfaces > COM Library to find out if the COM you have selected has already been tested and approved. The surface collection site also has information on the Haworth+ alliance program with Carnegie, Luna Textiles, and Maharam as well as our industry-leading Pre-Approved COM program.</p> <p>COM fabrics are placed into Grades based on the cost per linear yard. If a fabric's cost exceeds the range of our highest Grade it will be noted as Non-Graded. The product will be priced at Grade A; the COM fabric costs will appear as a separate line item. The fabric charge will be Haworth's purchase cost plus a 4% administrative fee (based on the cost of the fabric). Yardage calculations will include any applicable fabric repeat.</p> <p>COM Leather products will be priced at a leather Grade A; COL costs will appear as a separate line item. The leather costs will be Haworth's purchase cost plus a 4% administrative fee (based on the cost of the leather).</p>
Flammability Requirements	<p>Improv Series models are available with an optional fire retardant construction to comply with California Bulletin #133. Refer to the price pages for ordering information. Refer to the Haworth.com/surfaces for a listing of the approved fabrics.</p>
Environmental Factors	<p><u>Material Off Gassing</u></p> <p>In an effort to ensure air quality standards, all Improv parts suppliers are required to provide Material Data Sheets and/or other documentation, verifying that their products do not emit volatile organic compounds (VOCs). In addition, the powder-coat paint process used in the manufacturing of Improv seating is free of VOCs. Our manufacturing processes have also eliminated all use of chlorofluorocarbons (CFCs) and ozone depleting chemicals (ODCs) in the chair's construction.</p> <p><u>Recycling</u></p> <p>All fabric scraps are recycled, reducing the amount of material sent to landfills, and all chair components disassemble easily to increase the potential for recycling. In addition, all thermo-plastic parts are 100% reprocessible, and all raw materials used in its manufacturing can be recycled at the end of the useful life of the product. Recyclable parts are identified with the recycle symbol where practical.</p>

Improv Series

General Specifications

General Guidelines for Product Specification

Improv Series seating specification numbers are based on an alpha-numeric logic that identifies a product by model and certain characteristics.

For example, a product number that reads **M221-2241** identifies the product as an Improv high-back chair with seamless upholstered outer shell, pneumatic seat height adjustment, upholstered arms, back-lock, and hard dual-wheel casters.

The alpha-numeric logic for this model complete with fabric and finish codes is shown below:

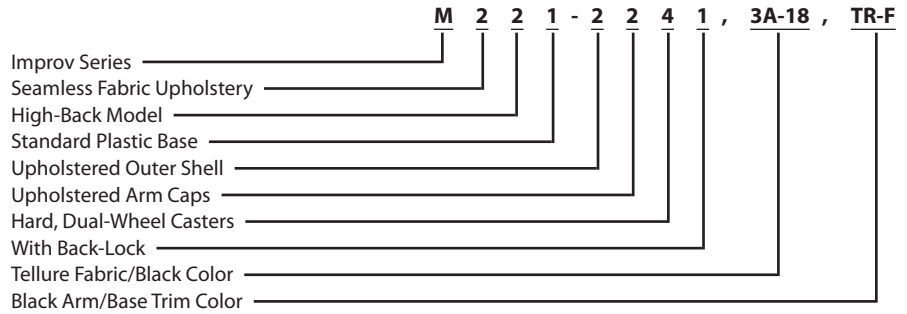

A ninth-digit suffix of the product number will indicate functional option, such as -F for CAL 133 option.

A product number that reads **M245-3942** identifies the product as an Improv S.E. chair with square mesh back, high arc plastic base, soft black vinyl arms, with forward tilt, and hard dual-wheel casters.

The alpha-numeric logic for this model complete with fabric and finish codes is shown below:

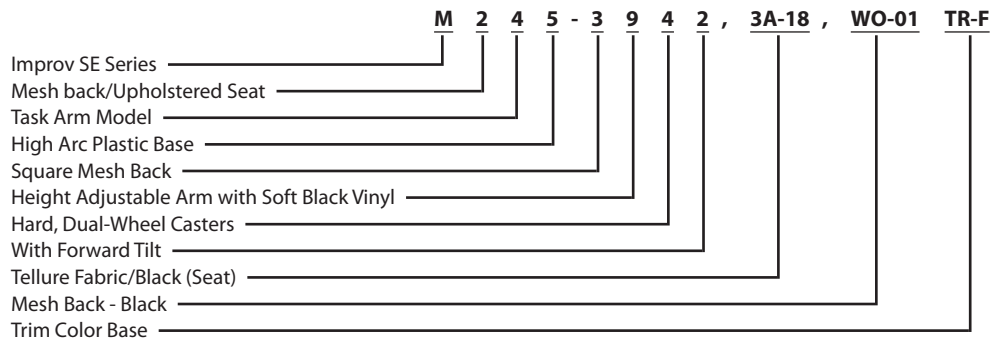

There are exceptions to this logic; therefore, always refer to the price charts for product numbers rather than attempting to construct them. Product number modification instructions for additional options appear in footnoted copy for each applicable model.

Beyond the printed product number, fabric and finish codes are required to complete an order specification. To communicate your order clearly, list the product number and fabric/finish codes in the sequence outlined on each price page.

RUSH

Select Improv Series seating models are marked with a **■** symbol to denote availability on the RUSH program. Refer to the fabric and finish options for each product.

Finishes and Fabrics

A complete listing of finishes and fabrics for Improv Series desk chairs can be found in the back of the price list.

Improv Series

High-Back Chair with Arms



M221-1142

Dimensions

SH: 15" - 20"
(381mm-508mm)
H: 37 1/2"(953mm)
D: 25"(635mm)
W: 25 1/2"(648mm)
SW: 20 1/2"(521mm)
SD: 16 1/2"(419mm)
AH: 8 11/16"(221mm)
Two-stage seat height:
.7"(18mm) below
standard
1.9"(48mm) above
standard

Features

- Outer Shells: Polypropylene or upholstered.
- Arm Caps: Standard, upholstered fabric or soft black vinyl.
- Casters: Standard with hard casters; or optional soft casters, see below.
- Standard plastic base or optional high arc, or steel base.
- Mechanism: Swivel with synchronized-tilt.
- Height Adjustment: Pneumatic, pneumatic with two-stage seat height, or pneumatic with low position seat height option.
- Optional Back-Lock: Lockable in two positions.
- Tilt tension.
- Fire retardant construction is available to comply with California Bulletin #133, see below.
- COM yardage / COL square footage:
Polypropylene shell: 2.0/44
Upholstered shell: 3.0/66
- Available on RUSH with hard casters.

To Order, Specify:

- 1) Product number.
- 2) Fabric surface and color. (NOTE: For leather upholstery, see below.)
- 3) Trim color for shell (if applicable), arms and base.

Shells	Arms/Caps	Number	Fabric Grade								Leather Grade A	Leather Grade B
			A	B	C	D	E	F	G	H		
Pneumatic Height Adjustment												
Polypropylene	Standard	M221-1142	\$1090.77	\$1167.81	\$1244.87	\$1285.79	\$1319.53	\$1490.47	\$1577.15	\$1813.13	\$1750.53	\$1930.07
	Upholstered	M221-1242	1146.15	1223.19	1300.25	1341.17	1374.91	1545.85	1632.53	1868.51	1805.91	1985.45
	Soft Black Vinyl	M221-1342	1146.15	1223.19	1300.25	1341.17	1374.91	1545.85	1632.53	1868.51	1805.91	1985.45
Upholstered	Standard	M221-2142	\$1367.68	\$1463.98	\$1565.12	\$1618.10	\$1663.86	\$1967.26	\$2097.26	\$2448.82	\$2251.36	\$2447.78
	Upholstered	M221-2242	1423.06	1519.36	1620.50	1673.48	1719.24	2022.64	2152.64	2504.20	2306.74	2503.16
	Soft Black Vinyl	M221-2342	1423.06	1519.36	1620.50	1673.48	1719.24	2022.64	2152.64	2504.20	2306.74	2503.16
Pneumatic Height Adjustment/Back-Lock												
Polypropylene	Standard	M221-1141	\$1146.15	\$1223.19	\$1300.25	\$1341.17	\$1374.91	\$1545.85	\$1632.53	\$1868.51	\$1805.91	\$1985.45
	Upholstered	M221-1241	1201.53	1278.57	1355.63	1396.55	1430.29	1601.23	1687.91	1923.89	1861.29	2040.83
	Soft Black Vinyl	M221-1341	1201.53	1278.57	1355.63	1396.55	1430.29	1601.23	1687.91	1923.89	1861.29	2040.83
Upholstered	Standard	M221-2141	\$1423.06	\$1519.36	\$1620.50	\$1673.48	\$1719.24	\$2022.64	\$2152.64	\$2504.20	\$2306.74	\$2503.16
	Upholstered	M221-2241	1478.44	1574.74	1675.88	1728.86	1774.62	2078.02	2208.02	2559.58	2362.12	2558.54
	Soft Black Vinyl	M221-2341	1478.44	1574.74	1675.88	1728.86	1774.62	2078.02	2208.02	2559.58	2362.12	2558.54

The following options require modification of the product number.

- Low-position seat height - Plastic
- Two-stage seat height- HAB
- High arc base
- Steel base - Standard
- Steel base - Low height
- Soft casters
- Leather upholstery
- CAL 133
- Stain repellent

- To specify, change the 4th digit from a 1 to a 4; **Example:** M224-1142
 - To specify, change the 4th digit from a 1 to a 3; **Example:** M223-1142 (add \$99.93 list)
 - To specify, change the 4th digit from a 1 to a 5; **Example:** M225-1142
 - To specify, change the 4th digit from a 1 to a 6; **Example:** M226-1142
 - To specify, change the 4th digit from a 1 to a 7; **Example:** M227-1142
 - To specify, change the 7th digit from a 4 to a 2; **Example:** M221-1122
 - To specify, change the 2nd digit from a 2 to a 1; **Example:** M121-1142
 - To specify, add -F to the end of the product number; **Example:** M221-1142-F (add \$116.78 list)
 - To specify, add -P to end of the product number; **Example:** M221-1141-P (add \$38.52 list)
- NOTE:** For available fabrics, refer to surfaces.haworth.com.

Improv Series

High-Back Chair with Height Adjustable Arms



M221-1742

Dimensions

SH: 15" - 20"
(381mm-508mm)
H: 37 1/2"(953mm)
D: 25"(635mm)
W: 27 1/4"(692mm)
SW: 20 1/2"(521mm)
SD: 16 1/2"(419mm)
AH: 7" - 11"
(179mm-279mm)

Two-stage seat height:
.7"(18mm) below
standard
1.9"(48mm) above
standard

Features

- Outer Shells: Polypropylene or upholstered.
- Arm Caps: Standard, upholstered fabric or soft black vinyl.
- Arm Adjustment Controls: Fingertip activation.
- Arm Adjustment: 4"(102mm) height adjustment at a 13° angle.
- Casters: Standard with hard casters; or optional soft casters, see below.
- Standard plastic base or optional high arc, or steel base.
- Mechanism: Swivel with synchronized-tilt.
- Height Adjustment: Pneumatic, pneumatic with two-stage seat height, or pneumatic with low position seat height option.
- Optional Back-Lock: Lockable in two positions.
- Tilt tension.
- COM yardage / COL square footage:
Polypropylene shell: 2.0/44
Upholstered shell: 3.0/66

To Order, Specify:

- 1) Product number.
- 2) Fabric surface and color. (NOTE: For leather upholstery, see below.)
- 3) Trim color for shell (if applicable), arms and base.

Shells	Arms/Caps	Number	Fabric Grade								Leather Grade A	Leather Grade B
			A	B	C	D	E	F	G	H		
Pneumatic Height Adjustment												
Polypropylene	Standard	M221-1742	\$1219.58	\$1296.62	\$1373.68	\$1414.60	\$1448.34	\$1619.28	\$1705.96	\$1941.94	\$1879.34	\$2058.88
	Upholstered	M221-1842	1274.96	1352.00	1429.06	1469.98	1503.72	1674.66	1761.34	1997.32	1934.72	2114.26
	Soft Black Vinyl	M221-1942	1274.96	1352.00	1429.06	1469.98	1503.72	1674.66	1761.34	1997.32	1934.72	2114.26
Upholstered	Standard	M221-2742	\$1496.49	\$1592.79	\$1693.93	\$1746.91	\$1792.67	\$2096.07	\$2226.07	\$2577.63	\$2380.17	\$2576.59
	Upholstered	M221-2842	1551.87	1648.17	1749.31	1802.29	1848.05	2151.45	2281.45	2633.01	2435.55	2631.97
	Soft Black Vinyl	M221-2942	1551.87	1648.17	1749.31	1802.29	1848.05	2151.45	2281.45	2633.01	2435.55	2631.97
Pneumatic Height Adjustment/Back-Lock												
Polypropylene	Standard	M221-1741	\$1274.96	\$1352.00	\$1429.06	\$1469.98	\$1503.72	\$1674.66	\$1761.34	\$1997.32	\$1934.72	\$2114.26
	Upholstered	M221-1841	1330.34	1407.38	1484.44	1525.36	1559.10	1730.04	1816.72	2052.70	1990.10	2169.64
	Soft Black Vinyl	M221-1941	1330.34	1407.38	1484.44	1525.36	1559.10	1730.04	1816.72	2052.70	1990.10	2169.64
Upholstered	Standard	M221-2741	\$1551.87	\$1648.17	\$1749.31	\$1802.29	\$1848.05	\$2151.45	\$2281.45	\$2633.01	\$2435.55	\$2631.97
	Upholstered	M221-2841	1607.25	1703.55	1804.69	1857.67	1903.43	2206.83	2336.83	2688.39	2490.93	2687.35
	Soft Black Vinyl	M221-2941	1607.25	1703.55	1804.69	1857.67	1903.43	2206.83	2336.83	2688.39	2490.93	2687.35

The following options require modification of the product number.

- | | |
|------------------------------------|--|
| Low-position seat height - Plastic | To specify, change the 4th digit from a 1 to a 4; Example: M224-1742 |
| Two-stage seat height- HAB | To specify, change the 4th digit from a 1 to a 3; Example: M223-1742 (add \$99.93 list) |
| High arc base | To specify, change the 4th digit from a 1 to a 5; Example: M225-1742 |
| Steel base - Standard height | To specify, change the 4th digit from a 1 to a 6; Example: M226-1742 |
| Steel base - Low height | To specify, change the 4th digit from a 1 to a 7; Example: M227-1742 |
| Soft casters | To specify, change the 7th digit from a 4 to a 2; Example: M221-1722 |
| Leather upholstery | To specify, change the 2nd digit from a 2 to a 1; Example: M121-1742 |
| CAL 133 | To specify, add -F to the end of the product number; Example: M221-1742-F (add \$116.78 list) |
| Stain repellent | To specify, add -P to the end of the product number; Example: M221-1742-P (add \$38.52 list) |

NOTE: For available fabrics, refer to surfaces.haworth.com.

Improv Series

High-Back Chair without Arms



M221-1042

Dimensions

SH: 15" - 20"
(381mm-508mm)
H: 37 1/2"(953mm)
D: 25"(635mm)
W: 20 1/2"(521mm)
SW: 20 1/2"(521mm)
SD: 16 1/2"(419mm)

Two-stage seat height:
.7"(18mm) below
standard
1.9"(48mm) above
standard

Features

- Outer Shells: Polypropylene or upholstered.
 - Casters: Standard with hard casters; or optional soft casters, see below.
 - Standard plastic base or optional high arc, or steel base.
 - Mechanism: Swivel with synchronized-tilt.
 - Height Adjustment: Pneumatic, pneumatic with two-stage seat height, or pneumatic with low-position seat height option.
 - Optional Back-Lock: Lockable in two positions.
 - Tilt tension.
 - Fire retardant construction is available to comply with California Bulletin #133, see below.
 - COM yardage / COL square footage:
Polypropylene shell: 2.0/44
Upholstered shell: 3.0/66
- Available on RUSH with hard casters.

To Order, Specify:

- 1) Product number.
- 2) Fabric surface and color.
(NOTE: For leather upholstery, see below.)
- 3) Trim color for shell (if applicable) and base.

Shells	Number	Fabric Grade		C	D	E	F	G	H	Leather Grade A	Leather Grade B
		A	B								
Pneumatic Height Adjustment											
Polypropylene	M221-1042 ■	\$1000.47	\$1077.51	\$1154.57	\$1195.49	\$1229.23	\$1400.17	\$1486.85	\$1722.83	\$1660.23	\$1839.77
Upholstered	M221-2042 ■	1277.38	1373.68	1474.82	1527.80	1573.56	1876.96	2006.96	2358.52	2161.06	2357.48
Pneumatic Height Adjustment/Back-Lock											
Polypropylene	M221-1041 ■	\$1055.85	\$1132.89	\$1209.95	\$1250.87	\$1284.61	\$1455.55	\$1542.23	\$1778.21	\$1715.61	\$1895.15
Upholstered	M221-2041 ■	1332.76	1429.06	1530.20	1583.18	1628.94	1932.34	2062.34	2413.90	2216.44	2412.86

The following options require modification of the product number.

- | | |
|------------------------------------|---|
| Low-position seat height - Plastic | To specify, change the 4th digit from a 1 to a 4; Example: M224-1042 |
| Two-stage seat height- HAB | To specify, change the 4th digit from a 1 to a 3; Example: M223-1042 (add \$99.93 list) |
| High arc base | To specify, change the 4th digit from a 1 to a 5; Example: M225-1042 |
| Steel base - Standard height | To specify, change the 4th digit from a 1 to a 6; Example: M226-1042 |
| Steel base - Low height | To specify, change the 4th digit from a 1 to a 7; Example: M227-1042 |
| Soft casters | To specify, change the 7th digit from a 4 to a 2; Example: M221-1022 |
| Leather upholstery | To specify, change the 2nd digit from a 2 to a 1; Example: M121-1042 |
| CAL 133 | To specify, add -F to the end of the product number; Example: M221-1042-F (add \$116.78 list) |
| Stain repellent | To specify, add -P to the end of the product number; Example: M221-1042-P (add \$38.52 list) |

NOTE: For available fabrics, refer to surfaces.haworth.com.

Improv Series

Mid-Back Chair with Arms



M211-1142

Dimensions

SH: 15" - 20"
(381mm-508mm)
H: 34 1/2"(876mm)
D: 25"(635mm)
W: 25 1/2"(648mm)
SW: 20 1/2"(521mm)
SD: 16 1/2"(419mm)
AH: 8 11/16"(221mm)

Two-stage seat height:
.7"(18mm) below
standard
1.9"(48mm) above
standard

Features

- Outer Shells: Polypropylene or upholstered.
- Arm Caps: Standard, upholstered fabric or soft black vinyl.
- Casters: Standard with hard casters; or optional soft casters, see below.
- Standard plastic base or optional high arc, or steel base.
- Mechanism: Swivel with synchronized-tilt.
- Height Adjustment: Pneumatic, pneumatic with two-stage seat height, or pneumatic with low-position seat height option.
- Optional Back-Lock: Lockable in two positions.
- Tilt tension.
- Fire retardant construction is available to comply with California Bulletin #133, see below.
- COM yardage / COL square footage:
Polypropylene shell: 1.75/39
Upholstered shell: 2.75/61
- Available on RUSH with hard casters.

To Order, Specify:

- 1) Product number.
- 2) Fabric surface and color.
(NOTE: For leather upholstery, see below.)
- 3) Trim color for shell (if applicable), arms and base.

Shells	Arms/Caps	Number	Fabric Grade								Leather Grade A	Leather Grade B
			A	B	C	D	E	F	G	H		
Pneumatic Height Adjustment												
Polypropylene	Standard	M211-1142	\$ 963.15	\$1040.19	\$1117.25	\$1158.17	\$1191.91	\$1362.85	\$1449.53	\$1685.51	\$1622.91	\$1802.45
	Upholstered	M211-1242	1018.53	1095.57	1172.63	1213.55	1247.29	1418.23	1504.91	1740.89	1678.29	1857.83
	Soft Black Vinyl	M211-1342	1018.53	1095.57	1172.63	1213.55	1247.29	1418.23	1504.91	1740.89	1678.29	1857.83
Upholstered	Standard	M211-2142	\$1240.06	\$1336.36	\$1437.50	\$1490.48	\$1536.24	\$1839.64	\$1969.64	\$2321.20	\$2123.74	\$2320.16
	Upholstered	M211-2242	1295.44	1391.74	1492.88	1545.86	1591.62	1895.02	2025.02	2376.58	2179.12	2375.54
	Soft Black Vinyl	M211-2342	1295.44	1391.74	1492.88	1545.86	1591.62	1895.02	2025.02	2376.58	2179.12	2375.54
Pneumatic Height Adjustment/Back-Lock												
Polypropylene	Standard	M211-1141	\$1018.53	\$1095.57	\$1172.63	\$1213.55	\$1247.29	\$1418.23	\$1504.91	\$1740.89	\$1678.29	\$1857.83
	Upholstered	M211-1241	1073.91	1150.95	1228.01	1268.93	1302.67	1473.61	1560.29	1796.27	1733.67	1913.21
	Soft Black Vinyl	M211-1341	1073.91	1150.95	1228.01	1268.93	1302.67	1473.61	1560.29	1796.27	1733.67	1913.21
Upholstered	Standard	M211-2141	\$1295.44	\$1391.74	\$1492.88	\$1545.86	\$1591.62	\$1895.02	\$2025.02	\$2376.58	\$2179.12	\$2375.54
	Upholstered	M211-2241	1350.82	1447.12	1548.26	1601.24	1647.00	1950.40	2080.40	2431.96	2234.50	2430.92
	Soft Black Vinyl	M211-2341	1350.82	1447.12	1548.26	1601.24	1647.00	1950.40	2080.40	2431.96	2234.50	2430.92

The following options require modification of the product number.

- Low-position seat height - Plastic
- Two-stage seat height- HAB
- High arc base
- Steel base - Standard height
- Steel base - Low height
- Soft casters
- Leather upholstery
- CAL 133
- Stain repellent

- To specify, change the 4th digit from a 1 to a 4; **Example:** M214-1142
- To specify, change the 4th digit from a 1 to a 3; **Example:** M213-1142 (add \$99.93 list)
- To specify, change the 4th digit from a 1 to a 5; **Example:** M215-1142
- To specify, change the 4th digit from a 1 to a 6; **Example:** M216-1142
- To specify, change the 4th digit from a 1 to a 7; **Example:** M217-1142
- To specify, change the 7th digit from a 4 to a 2; **Example:** M211-1122
- To specify, change the 2nd digit from a 2 to a 1; **Example:** M111-1142
- To specify, add -F to the end of the product number; **Example:** M211-1142-F (add \$116.78 list)
- To specify, add -P to the end of the product number; **Example:** M211-1142-P (add \$38.52 list)

NOTE: For available fabrics, refer to surfaces.haworth.com.

Improv Series

Mid-Back Chair with Height Adjustable Arms



M211-1742

Dimensions

SH: 15" - 20"
(381mm-508mm)
H: 34 1/2"(876mm)
D: 25"(635mm)
W: 27 1/4"(692mm)
SW: 20 1/2"(521mm)
SD: 16 1/2"(419mm)
AH: 7" - 11"
(179mm-279mm)

Two-stage seat height:
.7"(18mm) below
standard
1.9"(48mm) above
standard

Features

- Outer Shells: Polypropylene or upholstered.
- Arms: Standard, upholstered fabric or soft black vinyl arm caps.
- Arm Adjustment Controls: Fingertip activation.
- Casters: Standard with hard casters; for optional soft casters, see below.
- Standard plastic base or optional high arc, or steel base.
- Mechanism: Swivel with synchronized-tilt.
- Height Adjustment: Pneumatic, pneumatic with two-stage seat height, or pneumatic with low-position seat height option.
- Arm Adjustment: 4"(102mm) height adjustment at a 13° angle.
- Optional Back-Lock: Lockable in two positions.
- Tilt tension.
- COM yardage / COL square footage:
Polypropylene shell: 1.75/39
Upholstered shell: 2.75/61

■ Available on RUSH with hard casters.

To Order, Specify:

- 1) Product number.
- 2) Fabric surface and color. (NOTE: For leather upholstery, see below.)
- 3) Trim color for shell (if applicable), arms and base.

Shells	Arms/Caps	Number	Fabric Grade								Leather Grade A	Leather Grade B
			A	B	C	D	E	F	G	H		
Pneumatic Height Adjustment												
Polypropylene	Standard	M211-1742	\$1091.96	\$1169.00	\$1246.06	\$1286.98	\$1320.72	\$1491.66	\$1578.34	\$1814.32	\$1751.72	\$1931.26
	Upholstered	M211-1842	1147.34	1224.38	1301.44	1342.36	1376.10	1547.04	1633.72	1869.70	1807.10	1986.64
	Soft Black Vinyl	M211-1942	1147.34	1224.38	1301.44	1342.36	1376.10	1547.04	1633.72	1869.70	1807.10	1986.64
Upholstered	Standard	M211-2742	\$1368.87	\$1465.17	\$1566.31	\$1619.29	\$1665.05	\$1968.45	\$2098.45	\$2450.01	\$2252.55	\$2448.97
	Upholstered	M211-2842	1424.25	1520.55	1621.69	1674.67	1720.43	2023.83	2153.83	2505.39	2307.93	2504.35
	Soft Black Vinyl	M211-2942	1424.25	1520.55	1621.69	1674.67	1720.43	2023.83	2153.83	2505.39	2307.93	2504.35
Pneumatic Height Adjustment/Back-Lock												
Polypropylene	Standard	M211-1741	\$1147.34	\$1224.38	\$1301.44	\$1342.36	\$1376.10	\$1547.04	\$1633.72	\$1869.70	\$1807.10	\$1986.64
	Upholstered	M211-1841	1202.72	1279.76	1356.82	1397.74	1431.48	1602.42	1689.10	1925.08	1862.48	2042.02
	Soft Black Vinyl	M211-1941	1202.72	1279.76	1356.82	1397.74	1431.48	1602.42	1689.10	1925.08	1862.48	2042.02
Upholstered	Standard	M211-2741	\$1424.25	\$1520.55	\$1621.69	\$1674.67	\$1720.43	\$2023.83	\$2153.83	\$2505.39	\$2307.93	\$2504.35
	Upholstered	M211-2841	1479.63	1575.93	1677.07	1730.05	1775.81	2079.21	2209.21	2560.77	2363.31	2559.73
	Soft Black Vinyl	M211-2941	1479.63	1575.93	1677.07	1730.05	1775.81	2079.21	2209.21	2560.77	2363.31	2559.73

The following options require modification of the product number.

- Low-position seat height - Plastic
- Two-stage seat height- HAB
- High arc base
- Steel base - Standard height
- Steel base - Low height
- Soft casters
- Leather upholstery
- CAL 133
- Stain repellent

- To specify, change the 4th digit from a 1 to a 4; **Example:** M214-1742
- To specify, change the 4th digit from a 1 to a 3; **Example:** M213-1742 (add \$99.93 list)
- To specify, change the 4th digit from a 1 to a 5; **Example:** M215-1742
- To specify, change the 4th digit from a 1 to a 6; **Example:** M216-1742
- To specify, change the 4th digit from a 1 to a 7; **Example:** M217-1742
- To specify, change the 7th digit from a 4 to a 2; **Example:** M211-1722
- To specify, change the 2nd digit from a 2 to a 1; **Example:** M111-1742
- To specify, add **-F** to the end of the product number; **Example:** M211-1742-F (add \$116.78 list)
- To specify, add **-P** to the end of the product number; **Example:** M211-1742-P (add \$38.52 list)

NOTE: For available fabrics, refer to surfaces.haworth.com.

Improv Series

Mid-Back Chair without Arms

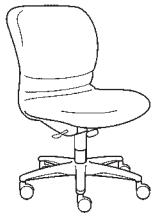

M211-1042

Dimensions

SH: 15" - 20"
(381mm-508mm)
H: 34 1/2"(876mm)
D: 25"(635mm)
W: 20 1/2"(521mm)
SW: 20 1/2"(521mm)
SD: 16 1/2"(419mm)

Two-stage seat height:
.7"(18mm) below
standard
1.9"(48mm) above
standard

Features

- Outer Shells: Polypropylene or upholstered.
 - Casters: Standard with hard casters; or optional soft casters, see below.
 - Standard plastic base or optional high arc, or steel base.
 - Mechanism: Swivel with synchronized-tilt.
 - Height Adjustment: Pneumatic, pneumatic with two-stage seat height, or pneumatic with low-position seat height option.
 - Optional Back-Lock: Lockable in two positions.
 - Tilt tension.
 - Fire retardant construction is available to comply with California Bulletin #133, see below.
 - COM yardage / COL square footage:
Polypropylene shell: 1.75/39
Upholstered shell: 2.75/61
- Available on RUSH with hard casters.

To Order, Specify:

- 1) Product number.
- 2) Fabric surface and color. (NOTE: For leather upholstery, see below.)
- 3) Trim color for shell (if applicable) and base.

Shells	Number	Fabric Grade		C	D	E	F	G	H	Leather Grade A	Leather Grade B
		A	B								
Pneumatic Height Adjustment											
Polypropylene	M211-1042 ■	\$ 872.85	\$ 949.89	\$1026.95	\$1067.87	\$1101.61	\$1272.55	\$1359.23	\$1595.21	\$1532.61	\$1712.15
Upholstered	M211-2042 ■	1149.76	1246.06	1347.20	1400.18	1445.94	1749.34	1879.34	2230.90	2033.44	2229.86
Pneumatic Height Adjustment/Back-Lock											
Polypropylene	M211-1041 ■	\$ 928.23	\$1005.27	\$1082.33	\$1123.25	\$1156.99	\$1327.93	\$1414.61	\$1650.59	\$1587.99	\$1767.53
Upholstered	M211-2041 ■	1205.14	1301.44	1402.58	1455.56	1501.32	1804.72	1934.72	2286.28	2088.82	2285.24

The following options require modification of the product number.

- | | |
|------------------------------------|---|
| Low-position seat height - Plastic | To specify, change the 4th digit from a 1 to a 4; Example: M214-1042 |
| Two-stage seat height- HAB | To specify, change the 4th digit from a 1 to a 3; Example: M213-1042 (add \$99.93 list) |
| High arc base | To specify, change the 4th digit from a 1 to a 5; Example: M215-1042 |
| Steel base - Standard height | To specify, change the 4th digit from a 1 to a 6; Example: M216-1042 |
| Steel base - Low height | To specify, change the 4th digit from a 1 to a 7; Example: M217-1042 |
| Soft casters | To specify, change the 7th digit from a 4 to a 2; Example: M211-1022 |
| Leather upholstery | To specify, change the 2nd digit from a 2 to a 1; Example: M111-1042 |
| CAL 133 | To specify, add -F to the end of the product number; Example: M211-1042-F (add \$116.78 list) |
| Stain repellent | To specify, add -P to the end of the product number; Example: M211-1042-P (add \$38.52 list) |

NOTE: For available fabrics, refer to surfaces.haworth.com.

Improv Series

Improv H.E. XL Chair with Task Arms



M271-1442

Dimensions

SH: 16" - 20 1/2"
(406mm - 521mm)
H: 36 1/2" - 45"
(957mm - 1143mm)
D: 23 1/2" - 26 1/2"
(597mm - 673mm)
W: 30"(762mm)
SW: 23 3/4"(603mm)
SD: 16" - 19"
(406mm - 483mm)
AH: 9.6"(244mm)

Features

- Accommodates up to 500 pounds.
- Outer Shells: Polypropylene or upholstered.
- Arms: Standard, upholstered fabric or soft black vinyl arm caps.
- Casters: Standard with hard casters.
- Mechanism: Swivel with synchronized-tilt.
- Height Adjustment: Pneumatic.
- Optional Back-Lock: Lockable in two positions.
- Optional Forward Tilt: Lockable in 3 positions.
- Tilt tension.
- Optional Adjustable Air Lumbar additional 1 1/2"(38mm) of lumbar support.
- Fire retardant construction is available to comply with California Bulletin #133.
- COM yardage / COL square footage:
Polypropylene shell: 2.41/51
Upholstered shell: 3.31/75

To Order, Specify:

- 1) Product number.
- 2) Fabric surface and color. (NOTE: For leather upholstery, see page 193.)
- 3) Trim color for shell, arms and base.

* All measurements taken with the BIFMA chair measuring device.

Shells	Arms/Caps	Number	Fabric Grade		C	D	E	F	G	H	Leather Grade A	Leather Grade B
			A	B								
Pneumatic Height Adjustment												
Polypropylene	Standard	M271-1442	\$2189.96	\$2265.82	\$2345.26	\$2384.98	\$2419.88	\$2489.74	\$2553.54	\$2730.52	\$2853.30	\$3035.00
	Upholstered	M271-1542	2241.74	2317.60	2397.04	2436.76	2471.66	2541.52	2605.32	2782.30	2905.08	3086.78
	Soft Black Vinyl	M271-1642	2241.74	2317.60	2397.04	2436.76	2471.66	2541.52	2605.32	2782.30	2905.08	3086.78
Upholstered	Standard	M271-2442	\$2315.17	\$2391.03	\$2470.47	\$2510.19	\$2545.09	\$2614.95	\$2678.75	\$2855.73	\$3206.06	\$3387.76
	Upholstered	M271-2542	2366.95	2442.81	2522.25	2561.97	2596.87	2666.73	2730.53	2907.51	3257.84	3439.54
	Soft Black Vinyl	M271-2642	2366.95	2442.81	2522.25	2561.97	2596.87	2666.73	2730.53	2907.51	3257.84	3439.54
Pneumatic Height Adjustment/Back-Lock												
Polypropylene	Standard	M271-1441	\$2241.74	\$2317.60	\$2397.04	\$2436.76	\$2471.66	\$2541.52	\$2605.32	\$2782.30	\$2905.08	\$3086.78
	Upholstered	M271-1541	2293.52	2369.38	2448.82	2488.54	2523.44	2593.30	2657.10	2834.08	2956.86	3138.56
	Soft Black Vinyl	M271-1641	2293.52	2369.38	2448.82	2488.54	2523.44	2593.30	2657.10	2834.08	2956.86	3138.56
Upholstered	Standard	M271-2441	\$2366.95	\$2442.81	\$2522.25	\$2561.97	\$2596.87	\$2666.73	\$2730.53	\$2907.51	\$3257.84	\$3439.54
	Upholstered	M271-2541	2418.73	2494.59	2574.03	2613.75	2648.65	2718.51	2782.31	2959.29	3309.62	3491.32
	Soft Black Vinyl	M271-2641	2418.73	2494.59	2574.03	2613.75	2648.65	2718.51	2782.31	2959.29	3309.62	3491.32
Pneumatic Height Adjustment/Forward-Tilt												
Polypropylene	Standard	M281-1442	\$2240.52	\$2316.38	\$2395.82	\$2435.54	\$2470.44	\$2540.30	\$2604.10	\$2781.08	\$2903.86	\$3085.56
	Upholstered	M281-1542	2292.30	2368.16	2447.60	2487.32	2522.22	2592.08	2655.88	2832.86	2955.64	3137.34
	Soft Black Vinyl	M281-1642	2292.30	2368.16	2447.60	2487.32	2522.22	2592.08	2655.88	2832.86	2955.64	3137.34
Upholstered	Standard	M281-2442	\$2365.73	\$2441.59	\$2521.03	\$2560.75	\$2595.65	\$2665.51	\$2729.31	\$2906.29	\$3256.62	\$3438.32
	Upholstered	M281-2542	2417.51	2493.37	2572.81	2612.53	2647.43	2717.29	2781.09	2958.07	3308.40	3490.10
	Soft Black Vinyl	M281-2642	2417.51	2493.37	2572.81	2612.53	2647.43	2717.29	2781.09	2958.07	3308.40	3490.10

Improv Series

Improv H.E. XL Chair with Task Arms

Shells	Arms/Caps	Number	Fabric Grade								Leather Grade A	Leather Grade B
			A	B	C	D	E	F	G	H		
Pneumatic Height Adjustment with Adjustable Air Lumbar												
Polypropylene	Standard	M271-1444	\$2315.17	\$2391.03	\$2470.47	\$2510.19	\$2545.09	\$2614.95	\$2678.75	\$2855.73	\$2978.51	\$3160.21
	Upholstered	M271-1544	2366.95	2442.81	2522.25	2561.97	2596.87	2666.73	2730.53	2907.51	3030.29	3211.99
	Soft Black Vinyl	M271-1644	2366.95	2442.81	2522.25	2561.97	2596.87	2666.73	2730.53	2907.51	3030.29	3211.99
Upholstered	Standard	M271-2444	\$2440.38	\$2516.24	\$2595.68	\$2635.40	\$2670.30	\$2740.16	\$2803.96	\$2980.94	\$3331.27	\$3512.97
	Upholstered	M271-2544	2492.16	2568.02	2647.46	2687.18	2722.08	2791.94	2855.74	3032.72	3383.05	3564.75
	Soft Black Vinyl	M271-2644	2492.16	2568.02	2647.46	2687.18	2722.08	2791.94	2855.74	3032.72	3383.05	3564.75
Pneumatic Height Adjustment/Back-Lock with Adjustable Air Lumbar												
Polypropylene	Standard	M271-1443	\$2366.95	\$2442.81	\$2522.25	\$2561.97	\$2596.87	\$2666.73	\$2730.53	\$2907.51	\$3030.29	\$3211.99
	Upholstered	M271-1543	2418.73	2494.59	2574.03	2613.75	2648.65	2718.51	2782.31	2959.29	3082.07	3263.77
	Soft Black Vinyl	M271-1643	2418.73	2494.59	2574.03	2613.75	2648.65	2718.51	2782.31	2959.29	3082.07	3263.77
Upholstered	Standard	M271-2443	\$2492.16	\$2568.02	\$2647.46	\$2687.18	\$2722.08	\$2791.94	\$2855.74	\$3032.72	\$3383.05	\$3564.75
	Upholstered	M271-2543	2543.94	2619.80	2699.24	2738.96	2773.86	2843.72	2907.52	3084.50	3434.83	3616.53
	Soft Black Vinyl	M271-2643	2543.94	2619.80	2699.24	2738.96	2773.86	2843.72	2907.52	3084.50	3434.83	3616.53
Pneumatic Height Adjustment/Forward-Tilt with Adjustable Air Lumbar												
Polypropylene	Standard	M281-1444	\$2365.73	\$2441.59	\$2521.03	\$2560.75	\$2595.65	\$2665.51	\$2729.31	\$2906.29	\$3029.07	\$3210.77
	Upholstered	M281-1544	2417.51	2493.37	2572.81	2612.53	2647.43	2717.29	2781.09	2958.07	3080.85	3262.55
	Soft Black Vinyl	M281-1644	2417.51	2493.37	2572.81	2612.53	2647.43	2717.29	2781.09	2958.07	3080.85	3262.55
Upholstered	Standard	M281-2444	\$2490.94	\$2566.80	\$2646.24	\$2685.96	\$2720.86	\$2790.72	\$2854.52	\$3031.50	\$3381.83	\$3563.53
	Upholstered	M281-2544	2542.72	2618.58	2698.02	2737.74	2772.64	2842.50	2906.30	3083.28	3433.61	3615.31
	Soft Black Vinyl	M281-2644	2542.72	2618.58	2698.02	2737.74	2772.64	2842.50	2906.30	3083.28	3433.61	3615.31

The following options require modification of the product number.

Faux Leather upholstery
 Leather upholstery
 CAL 133
 Stain repellent

To specify, change the 2nd digit from a 2 to a 3; **Example:** M371-1542

To specify, change the 2nd digit from a 2 to a 1; **Example:** M171-1542

To specify, add -F to the end of the product number; **Example:** M271-2542-F (add \$116.78 list)

To specify, add -P to the end of the product number; **Example:** M271-1442-P (add \$38.52 list)

NOTE: CAL 133 is available on all fully upholstered models and chairs with black (TR-F) polypropylene shells backs.

For available fabrics, refer to surfaces.haworth.com.

Improv Series

Improv H.E. XL Chair with Height Adjustable Task Arms



M271-1742

Dimensions

SH: 16" - 20 1/2"
(406mm - 521mm)
H: 36 1/2" - 45"
(957mm - 1143mm)
D: 23 1/2" - 26 1/2"
(597mm - 673mm)
W: 30"(762mm)
SW: 23 3/4"(603mm)
SD: 16" - 19"
(406mm - 483mm)
AH: 6.9" - 10.8"
(175mm - 274mm)

Features

- Accommodates up to 500 pounds.
- Outer Shells: Polypropylene or upholstered.
- Arms: Standard, upholstered fabric or soft black vinyl arm caps.
- Arm Adjustment Controls: Fingertip activation.
- Arm Adjustment: 4"(102mm) height adjustment.
- Casters: Standard with hard casters.
- Mechanism: Swivel with synchronized-tilt.
- Height Adjustment: Pneumatic.
- Optional Back-Lock: Lockable in two positions.
- Optional Forward Tilt: Lockable in 3 positions.
- Tilt tension
- Optional Adjustable Air Lumbar: additional 1 1/2"(38mm) of lumbar support.
- Fire retardant construction is available to comply with California Bulletin #133.
- COM yardage / COL square footage:
Polypropylene shell: 2.41/51
Upholstered shell: 3.31/75

To Order, Specify:

- 1) Product number.
- 2) Fabric surface and color. (NOTE: For leather upholstery, see page 195.)
- 3) Trim color for shell, arms and base.

* All measurements taken with the BIFMA chair measuring device.

Shells	Arms/Caps	Number	Fabric Grade		C	D	E	F	G	H	Leather Grade A	Leather Grade B
			A	B								
Pneumatic Height Adjustment												
Polypropylene	Standard	M271-1742	\$2298.31	\$2374.17	\$2453.61	\$2493.33	\$2528.23	\$2598.09	\$2661.89	\$2838.87	\$2961.65	\$3143.35
	Upholstered	M271-1842	2350.09	2425.95	2505.39	2545.11	2580.01	2649.87	2713.67	2890.65	3013.43	3195.13
	Soft Black Vinyl	M271-1942	2350.09	2425.95	2505.39	2545.11	2580.01	2649.87	2713.67	2890.65	3013.43	3195.13
Upholstered	Standard	M271-2742	\$2423.52	\$2499.38	\$2578.82	\$2618.54	\$2653.44	\$2723.30	\$2787.10	\$2964.08	\$3314.41	\$3496.11
	Upholstered	M271-2842	2475.30	2551.16	2630.60	2670.32	2705.22	2775.08	2838.88	3015.86	3366.19	3547.89
	Soft Black Vinyl	M271-2942	2475.30	2551.16	2630.60	2670.32	2705.22	2775.08	2838.88	3015.86	3366.19	3547.89
Pneumatic Height Adjustment/Back-Lock												
Polypropylene	Standard	M271-1741	\$2350.09	\$2425.95	\$2505.39	\$2545.11	\$2580.01	\$2649.87	\$2713.67	\$2890.65	\$3013.43	\$3195.13
	Upholstered	M271-1841	2401.87	2477.73	2557.17	2596.89	2631.79	2701.65	2765.45	2942.43	3065.21	3246.91
	Soft Black Vinyl	M271-1941	2401.87	2477.73	2557.17	2596.89	2631.79	2701.65	2765.45	2942.43	3065.21	3246.91
Upholstered	Standard	M271-2741	\$2475.30	\$2551.16	\$2630.60	\$2670.32	\$2705.22	\$2775.08	\$2838.88	\$3015.86	\$3366.19	\$3547.89
	Upholstered	M271-2841	2527.08	2602.94	2682.38	2722.10	2757.00	2826.86	2890.66	3067.64	3417.97	3599.67
	Soft Black Vinyl	M271-2941	2527.08	2602.94	2682.38	2722.10	2757.00	2826.86	2890.66	3067.64	3417.97	3599.67
Pneumatic Height Adjustment/Forward-Tilt												
Polypropylene	Standard	M281-1742	\$2348.87	\$2424.73	\$2504.17	\$2543.89	\$2578.79	\$2648.65	\$2712.45	\$2889.43	\$3012.21	\$3193.91
	Upholstered	M281-1842	2400.65	2476.51	2555.95	2595.67	2630.57	2700.43	2764.23	2941.21	3063.99	3245.69
	Soft Black Vinyl	M281-1942	2400.65	2476.51	2555.95	2595.67	2630.57	2700.43	2764.23	2941.21	3063.99	3245.69
Upholstered	Standard	M281-2742	\$2474.08	\$2549.94	\$2629.38	\$2669.10	\$2704.00	\$2773.86	\$2837.66	\$3014.64	\$3364.97	\$3546.67
	Upholstered	M281-2842	2525.86	2601.72	2681.16	2720.88	2755.78	2825.64	2889.44	3066.42	3416.75	3598.45
	Soft Black Vinyl	M281-2942	2525.86	2601.72	2681.16	2720.88	2755.78	2825.64	2889.44	3066.42	3416.75	3598.45

Improv Series

Improv H.E. XL Chair with Height Adjustable Task Arms

Shells	Arms/Caps	Number	Fabric Grade								Leather Grade A	Leather Grade B
			A	B	C	D	E	F	G	H		
Pneumatic Height Adjustment with Adjustable Air Lumbar												
Polypropylene	Standard	M271-1744	\$2423.52	\$2499.38	\$2578.82	\$2618.54	\$2653.44	\$2723.30	\$2787.10	\$2964.08	\$3086.86	\$3268.56
	Upholstered	M271-1844	2475.30	2551.16	2630.60	2670.32	2705.22	2775.08	2838.88	3015.86	3138.64	3320.34
	Soft Black Vinyl	M271-1944	2475.30	2551.16	2630.60	2670.32	2705.22	2775.08	2838.88	3015.86	3138.64	3320.34
Upholstered	Standard	M271-2744	\$2548.73	\$2624.59	\$2704.03	\$2743.75	\$2778.65	\$2848.51	\$2912.31	\$3089.29	\$3439.62	\$3621.32
	Upholstered	M271-2844	2600.51	2676.37	2755.81	2795.53	2830.43	2900.29	2964.09	3141.07	3491.40	3673.10
	Soft Black Vinyl	M271-2944	2600.51	2676.37	2755.81	2795.53	2830.43	2900.29	2964.09	3141.07	3491.40	3673.10
Pneumatic Height Adjustment/Back-Lock with Adjustable Air Lumbar												
Polypropylene	Standard	M271-1743	\$2475.30	\$2551.16	\$2630.60	\$2670.32	\$2705.22	\$2775.08	\$2838.88	\$3015.86	\$3138.64	\$3320.34
	Upholstered	M271-1843	2527.08	2602.94	2682.38	2722.10	2757.00	2826.86	2890.66	3067.64	3190.42	3372.12
	Soft Black Vinyl	M271-1943	2527.08	2602.94	2682.38	2722.10	2757.00	2826.86	2890.66	3067.64	3190.42	3372.12
Upholstered	Standard	M271-2743	\$2600.51	\$2676.37	\$2755.81	\$2795.53	\$2830.43	\$2900.29	\$2964.09	\$3141.07	\$3491.40	\$3673.10
	Upholstered	M271-2843	2652.29	2728.15	2807.59	2847.31	2882.21	2952.07	3015.87	3192.85	3543.18	3724.88
	Soft Black Vinyl	M271-2943	2652.29	2728.15	2807.59	2847.31	2882.21	2952.07	3015.87	3192.85	3543.18	3724.88
Pneumatic Height Adjustment/Forward-Tilt with Adjustable Air Lumbar												
Polypropylene	Standard	M281-1744	\$2474.08	\$2549.94	\$2629.38	\$2669.10	\$2704.00	\$2773.86	\$2837.66	\$3014.64	\$3137.42	\$3319.12
	Upholstered	M281-1844	2525.86	2601.72	2681.16	2720.88	2755.78	2825.64	2889.44	3066.42	3189.20	3370.90
	Soft Black Vinyl	M281-1944	2525.86	2601.72	2681.16	2720.88	2755.78	2825.64	2889.44	3066.42	3189.20	3370.90
Upholstered	Standard	M281-2744	\$2599.29	\$2675.15	\$2754.59	\$2794.31	\$2829.21	\$2899.07	\$2962.87	\$3139.85	\$3490.18	\$3671.88
	Upholstered	M281-2844	2651.07	2726.93	2806.37	2846.09	2880.99	2950.85	3014.65	3191.63	3541.96	3723.66
	Soft Black Vinyl	M281-2944	2651.07	2726.93	2806.37	2846.09	2880.99	2950.85	3014.65	3191.63	3541.96	3723.66

The following options require modification of the product number.

Faux Leather upholstery
Leather upholstery
CAL 133
Stain repellent

To specify, change the 2nd digit from a 2 to a 3; **Example:** M371-1842

To specify, change the 2nd digit from a 2 to a 1; **Example:** M171-1842

To specify, add **-F** to the end of the product number; **Example:** M271-2842-F (add \$116.78 list)

To specify, add **-P** to the end of the product number; **Example:** M271-1744-P (add \$38.52 list)

NOTE: CAL 133 is available on all fully upholstered models and chairs with black (TR-F) polypropylene shells backs.

For available fabrics, refer to surfaces.haworth.com.

Improv Series

Improv H.E. XL Chair with Flipper Arms



M271-1H42

Dimensions

SH: 16" - 20 1/2"
(406mm - 521mm)
H: 36 1/2" - 45"
(957mm - 1143mm)
D: 23 1/2" - 26 1/2"
(597mm - 673mm)
W: 30"(762mm)
SW: 23 3/4"(603mm)
SD: 16" - 19"
(406mm - 483mm)
AH: 6.2" - 11.1"
(157mm-282mm)

Features

- Accommodates up to 500 pounds.
- Outer Shells: Polypropylene or upholstered.
- Arms: Standard, upholstered fabric or black vinyl gel arm caps.
- Arm Adjustment Controls: Fingertip activation.
- Arm Adjustment: 5"(127mm) height adjustment.
- Arm Pad Rotation: 360°
- Casters: Standard with hard casters.
- Mechanism: Swivel with synchronized-tilt.
- Height Adjustment: Pneumatic.
- Optional Back-Lock: Lockable in two positions.
- Optional Forward Tilt: Lockable in 3 positions.
- Tilt tension.
- Optional Adjustable Air Lumbar additional 1 1/2"(38mm) of lumbar support.
- Fire retardant construction is available to comply with California Bulletin #133.
- COM yardage / COL square footage:
Polypropylene shell: 2.41/51
Upholstered shell: 3.31/75

To Order, Specify:

- 1) Product number.
- 2) Fabric surface and color. (NOTE: For leather upholstery, see page 197.)
- 3) Trim color for shell, arms and base.

* All measurements taken with the BIFMA chair measuring device.

Shells	Arms/Caps	Number	Fabric Grade		C	D	E	F	G	H	Leather Grade A	Leather Grade B
			A	B								
Pneumatic Height Adjustment												
Polypropylene	Standard	M271-1H42	\$2519.83	\$2595.69	\$2675.13	\$2714.85	\$2749.75	\$2819.61	\$2883.41	\$3060.39	\$3183.17	\$3364.87
	Vinyl Gel	M271-1G42	2586.04	2661.90	2741.34	2781.06	2815.96	2885.82	2949.62	3126.60	3249.38	3431.08
	Upholstered	M271-1U42	2633.00	2708.86	2788.30	2828.02	2862.92	2932.78	2996.58	3173.56	3296.34	3478.04
Upholstered	Standard	M271-2H42	\$2645.04	\$2720.90	\$2800.34	\$2840.06	\$2874.96	\$2944.82	\$3008.62	\$3185.60	\$3535.93	\$3717.63
	Vinyl Gel	M271-2G42	2711.25	2787.11	2866.55	2906.27	2941.17	3011.03	3074.83	3251.81	3602.14	3783.84
	Upholstered	M271-2U42	2758.21	2834.07	2913.51	2953.23	2988.13	3057.99	3121.79	3298.77	3649.10	3830.80
Pneumatic Height Adjustment/Back-Lock												
Polypropylene	Standard	M271-1H41	\$2571.61	\$2647.47	\$2726.91	\$2766.63	\$2801.53	\$2871.39	\$2935.19	\$3112.17	\$3234.95	\$3416.65
	Vinyl Gel	M271-1G41	2637.82	2713.68	2793.12	2832.84	2867.74	2937.60	3001.40	3178.38	3301.16	3482.86
	Upholstered	M271-1U41	2684.78	2760.64	2840.08	2879.80	2914.70	2984.56	3048.36	3225.34	3348.12	3529.82
Upholstered	Standard	M271-2H41	\$2696.82	\$2772.68	\$2852.12	\$2891.84	\$2926.74	\$2996.60	\$3060.40	\$3237.38	\$3587.71	\$3769.41
	Vinyl Gel	M271-2G41	2763.03	2838.89	2918.33	2958.05	2992.95	3062.81	3126.61	3303.59	3653.92	3835.62
	Upholstered	M271-2U41	2809.99	2885.85	2965.29	3005.01	3039.91	3109.77	3173.57	3350.55	3700.88	3882.58
Pneumatic Height Adjustment/Forward-Tilt												
Polypropylene	Standard	M281-1H42	\$2570.39	\$2646.25	\$2725.69	\$2765.41	\$2800.31	\$2870.17	\$2933.97	\$3110.95	\$3233.73	\$3415.43
	Vinyl Gel	M281-1G42	2636.60	2712.46	2791.90	2831.62	2866.52	2936.38	3000.18	3177.16	3299.94	3481.64
	Upholstered	M281-1U42	2683.56	2759.42	2838.86	2878.58	2913.48	2983.34	3047.14	3224.12	3346.90	3528.60
Upholstered	Standard	M281-2H42	\$2695.60	\$2771.46	\$2850.90	\$2890.62	\$2925.52	\$2995.38	\$3059.18	\$3236.16	\$3586.49	\$3768.19
	Vinyl Gel	M281-2G42	2761.81	2837.67	2917.11	2956.83	2991.73	3061.59	3125.39	3302.37	3652.70	3834.40
	Upholstered	M281-2U42	2808.77	2884.63	2964.07	3003.79	3038.69	3108.55	3172.35	3349.33	3699.66	3881.36

Improv Series

Improv H.E. XL Chair with Flipper Arms

Shells	Arms/Caps	Number	Fabric Grade								Leather Grade A	Leather Grade B
			A	B	C	D	E	F	G	H		
Pneumatic Height Adjustment with Adjustable Air Lumbar												
Polypropylene	Standard	M271-1H44	\$2645.04	\$2720.90	\$2800.34	\$2840.06	\$2874.96	\$2944.82	\$3008.62	\$3185.60	\$3308.38	\$3490.08
	Vinyl Gel	M271-1G44	2711.25	2787.11	2866.55	2906.27	2941.17	3011.03	3074.83	3251.81	3374.59	3556.29
	Upholstered	M271-1U44	2758.21	2834.07	2913.51	2953.23	2988.13	3057.99	3121.79	3298.77	3421.55	3603.25
Upholstered	Standard	M271-2H44	\$2770.25	\$2846.11	\$2925.55	\$2965.27	\$3000.17	\$3070.03	\$3133.83	\$3310.81	\$3661.14	\$3842.84
	Vinyl Gel	M271-2G44	2836.46	2912.32	2991.76	3031.48	3066.38	3136.24	3200.04	3377.02	3727.35	3909.05
	Upholstered	M271-2U44	2883.42	2959.28	3038.72	3078.44	3113.34	3183.20	3247.00	3423.98	3774.31	3956.01
Pneumatic Height Adjustment/Back-Lock with Adjustable Air Lumbar												
Polypropylene	Standard	M271-1H43	\$2696.82	\$2772.68	\$2852.12	\$2891.84	\$2926.74	\$2996.60	\$3060.40	\$3237.38	\$3360.16	\$3541.86
	Vinyl Gel	M271-1G43	2763.03	2838.89	2918.33	2958.05	2992.95	3062.81	3126.61	3303.59	3426.37	3608.07
	Upholstered	M271-1U43	2809.99	2885.85	2965.29	3005.01	3039.91	3109.77	3173.57	3350.55	3473.33	3655.03
Upholstered	Standard	M271-2H43	\$2822.03	\$2897.89	\$2977.33	\$3017.05	\$3051.95	\$3121.81	\$3185.61	\$3362.59	\$3712.92	\$3894.62
	Vinyl Gel	M271-2G43	2888.24	2964.10	3043.54	3083.26	3118.16	3188.02	3251.82	3428.80	3779.13	3960.83
	Upholstered	M271-2U43	2935.20	3011.06	3090.50	3130.22	3165.12	3234.98	3298.78	3475.76	3826.09	4007.79
Pneumatic Height Adjustment/Forward-Tilt with Adjustable Air Lumbar												
Polypropylene	Standard	M281-1H44	\$2695.60	\$2771.46	\$2850.90	\$2890.62	\$2925.52	\$2995.38	\$3059.18	\$3236.16	\$3358.94	\$3540.64
	Vinyl Gel	M281-1G44	2761.81	2837.67	2917.11	2956.83	2991.73	3061.59	3125.39	3302.37	3425.15	3606.85
	Upholstered	M281-1U44	2808.77	2884.63	2964.07	3003.79	3038.69	3108.55	3172.35	3349.33	3472.11	3653.81
Upholstered	Standard	M281-2H44	\$2820.81	\$2896.67	\$2976.11	\$3015.83	\$3050.73	\$3120.59	\$3184.39	\$3361.37	\$3711.70	\$3893.40
	Vinyl Gel	M281-2G44	2887.02	2962.88	3042.32	3082.04	3116.94	3186.80	3250.60	3427.58	3777.91	3959.61
	Upholstered	M281-2U44	2933.98	3009.84	3089.28	3129.00	3163.90	3233.76	3297.56	3474.54	3824.87	4006.57

The following options require modification of the product number.

Faux Leather upholstery
 Leather upholstery
 CAL 133
 Stain repellent

To specify, change the 2nd digit from a 2 to a 3; **Example:** M371-1H42

To specify, change the 2nd digit from a 2 to a 1; **Example:** M171-1H42

To specify, add **-F** to the end of the product number; **Example:** M271-2U42-F (add \$116.78 list)

To specify, add **-P** to the end of the product number; **Example:** M271-1H44-P (add \$38.52 list)

NOTE: CAL 133 is available on all fully upholstered models and chairs with black (TR-F) polypropylene shells backs.

CAL 133 is not available on chairs with vinyl gel arm caps.

For available fabrics, refer to surfaces.haworth.com.

This page intentionally blank

Improv Series

Improv H.E. XL Chair without Arms



M271-1042

Dimensions

SH: 16" - 20 1/2"
(406mm - 521mm)
H: 36 1/2" - 45"
(957mm-1143mm)
D: 23 1/2" - 26 1/2"
(597mm - 673mm)
W: 30"(762mm)
SW: 23 3/4"(603mm)
SD: 16" - 19"
(406mm - 483mm)

Features

- Accommodates up to 500 pounds.
- Outer Shells: Polypropylene or upholstered.
- Casters: Standard with hard casters.
- Mechanism: Swivel with synchronized-tilt.
- Height Adjustment: Pneumatic.
- Optional Adjustable Air Lumbar models available: additional 1 1/2"(38mm) of lumbar support.
- Optional Back-Lock: Lockable in two positions.
- Optional Forward Tilt: Lockable in 3 positions.
- Tilt tension.
- Fire retardant construction is available to comply with California Bulletin #133, see below.
- COM yardage / COL square footage:
Polypropylene shell: 2.41/51
Upholstered shell: 3.31/75

To Order, Specify:

- 1) Product number.
- 2) Fabric surface and color.
(NOTE: For leather upholstery, see below.)
- 3) Trim color for shell and base.

* All measurements taken with the BIFMA chair measuring device.

Shells	Number	Fabric Grade		C	D	E	F	G	H	Leather Grade A	Leather Grade B
		A	B								
Pneumatic Height Adjustment											
Polypropylene	M271-1042	\$2088.82	\$2164.68	\$2244.12	\$2283.84	\$2318.74	\$2388.60	\$2452.40	\$2629.38	\$2752.16	\$2933.86
Upholstered	M271-2042	2214.03	2289.89	2369.33	2409.05	2443.95	2513.81	2577.61	2754.59	3104.92	3286.62
Pneumatic Height Adjustment/Back-Lock											
Polypropylene	M271-1041	\$2140.60	\$2216.46	\$2295.90	\$2335.62	\$2370.52	\$2440.38	\$2504.18	\$2681.16	\$2803.94	\$2985.64
Upholstered	M271-2041	2265.81	2341.67	2421.11	2460.83	2495.73	2565.59	2629.39	2806.37	3156.70	3338.40
Pneumatic Height Adjustment/Forward-Tilt											
Polypropylene	M281-1042	\$2139.38	\$2215.24	\$2294.68	\$2334.40	\$2369.30	\$2439.16	\$2502.96	\$2679.94	\$2802.72	\$2984.42
Upholstered	M281-2042	2264.59	2340.45	2419.89	2459.61	2494.51	2564.37	2628.17	2805.15	3155.48	3337.18
Pneumatic Height Adjustment with Adjustable Air Lumbar											
Polypropylene	M271-1044	\$2214.03	\$2289.89	\$2369.33	\$2409.05	\$2443.95	\$2513.81	\$2577.61	\$2754.59	\$2877.37	\$3059.07
Upholstered	M271-2044	2339.24	2415.10	2494.54	2534.26	2569.16	2639.02	2702.82	2879.80	3230.13	3411.83
Pneumatic Height Adjustment/Back-Lock with Adjustable Air Lumbar											
Polypropylene	M271-1043	\$2265.81	\$2341.67	\$2421.11	\$2460.83	\$2495.73	\$2565.59	\$2629.39	\$2806.37	\$2929.15	\$3110.85
Upholstered	M271-2043	2391.02	2466.88	2546.32	2586.04	2620.94	2690.80	2754.60	2931.58	3281.91	3463.61
Pneumatic Height Adjustment/Forward-Tilt with Adjustable Air Lumbar											
Polypropylene	M281-1044	\$2264.59	\$2340.45	\$2419.89	\$2459.61	\$2494.51	\$2564.37	\$2628.17	\$2805.15	\$2927.93	\$3109.63
Upholstered	M281-2044	2389.80	2465.66	2545.10	2584.82	2619.72	2689.58	2753.38	2930.36	3280.69	3462.39

The following options require modification of the product number.

Faux Leather upholstery
Leather upholstery
CAL 133
Stain repellent

To specify, change the 2nd digit from a 2 to a 3; **Example:** M371-2042
To specify, change the 2nd digit from a 2 to a 1; **Example:** M171-2042
To specify, add -F to the end of the product number; **Example:** M271-2042-F (add \$116.78 list)
To specify, add -P to the end of the product number; **Example:** M271-1042-P (add \$38.52 list)

NOTE: CAL 133 is available on all fully upholstered models and chairs with black (TR-F) polypropylene shells backs.

For available fabrics, refer to surfaces.haworth.com.

Improv Series

Improv H.E. High-Back Chair with Task Arms



M251-1442

Dimensions

- SH: 16" - 21"
(406mm-533mm)
- H: 36 1/2" - 45"
(957mm - 1143mm)
- D: 24" - 27 1/4"
(610mm - 692mm)
- W: 25"(635mm)
- SW: 19.2"(488mm)
- SD: 16" - 19"
(406mm - 483mm)
- AH: 9.6"(244mm)

Two-stage seat height:
.7"(18mm) below
standard
1.9"(48mm) above
standard

Features

- Outer Shells: Polypropylene or upholstered.
- Arms: Standard, upholstered fabric or soft black vinyl arm caps.
- 3"(76mm) sliding seat pan.
- Casters: Standard with hard casters; or optional soft casters.
- Standard plastic base or optional high arc, or steel base.
- Mechanism: Swivel with synchronized-tilt.
- Height Adjustment: Pneumatic, pneumatic with two-stage seat height, or pneumatic with low-position seat height option.
- Optional Back-Lock: Lockable in two positions.
- Optional Forward Tilt: Lockable in 3 positions.
- Tilt tension.
- Optional Adjustable Air Lumbar: additional 1 1/2"(38mm) of lumbar support.
- Fire retardant construction is available to comply with California Bulletin #133.
- COM yardage / COL square footage:
Polypropylene shell: 2.13/45
Upholstered shell: 2.75/62
- Available on RUSH.

To Order, Specify:

- 1) Product number.
- 2) Fabric surface and color.
(NOTE: For leather upholstery, see page 201.)
- 3) Trim color for shell, arms and base.

* All measurements taken with the BIFMA chair measuring device.

Shells	Arms/Caps	Number	Fabric Grade		C	D	E	F	G	H	Leather Grade A	Leather Grade B
			A	B								
Pneumatic Height Adjustment												
Polypropylene	Standard	M251-1442	\$1097.99	\$1173.85	\$1253.29	\$1293.01	\$1327.91	\$1397.77	\$1461.57	\$1638.55	\$1761.33	\$1943.03
	Upholstered	M251-1542	1149.77	1225.63	1305.07	1344.79	1379.69	1449.55	1513.35	1690.33	1813.11	1994.81
	Soft Black Vinyl	M251-1642	1149.77	1225.63	1305.07	1344.79	1379.69	1449.55	1513.35	1690.33	1813.11	1994.81
Upholstered	Standard	M251-2442	\$1223.20	\$1299.06	\$1378.50	\$1418.22	\$1453.12	\$1522.98	\$1586.78	\$1763.76	\$2114.09	\$2295.79
	Upholstered	M251-2542	1274.98	1350.84	1430.28	1470.00	1504.90	1574.76	1638.56	1815.54	2165.87	2347.57
	Soft Black Vinyl	M251-2642	1274.98	1350.84	1430.28	1470.00	1504.90	1574.76	1638.56	1815.54	2165.87	2347.57
Pneumatic Height Adjustment/Back-Lock												
Polypropylene	Standard	M251-1441	\$1149.77	\$1225.63	\$1305.07	\$1344.79	\$1379.69	\$1449.55	\$1513.35	\$1690.33	\$1813.11	\$1994.81
	Upholstered	M251-1541	1201.55	1277.41	1356.85	1396.57	1431.47	1501.33	1565.13	1742.11	1864.89	2046.59
	Soft Black Vinyl	M251-1641	1201.55	1277.41	1356.85	1396.57	1431.47	1501.33	1565.13	1742.11	1864.89	2046.59
Upholstered	Standard	M251-2441	\$1274.98	\$1350.84	\$1430.28	\$1470.00	\$1504.90	\$1574.76	\$1638.56	\$1815.54	\$2165.87	\$2347.57
	Upholstered	M251-2541	1326.76	1402.62	1482.06	1521.78	1556.68	1626.54	1690.34	1867.32	2217.65	2399.35
	Soft Black Vinyl	M251-2641	1326.76	1402.62	1482.06	1521.78	1556.68	1626.54	1690.34	1867.32	2217.65	2399.35
Pneumatic Height Adjustment/Forward-Tilt												
Polypropylene	Standard	M261-1442	\$1148.55	\$1224.41	\$1303.85	\$1343.57	\$1378.47	\$1448.33	\$1512.13	\$1689.11	\$1811.89	\$1993.59
	Upholstered	M261-1542	1200.33	1276.19	1355.63	1395.35	1430.25	1500.11	1563.91	1740.89	1863.67	2045.37
	Soft Black Vinyl	M261-1642	1200.33	1276.19	1355.63	1395.35	1430.25	1500.11	1563.91	1740.89	1863.67	2045.37
Upholstered	Standard	M261-2442	\$1273.76	\$1349.62	\$1429.06	\$1468.78	\$1503.68	\$1573.54	\$1637.34	\$1814.32	\$2164.65	\$2346.35
	Upholstered	M261-2542	1325.54	1401.40	1480.84	1520.56	1555.46	1625.32	1689.12	1866.10	2216.43	2398.13
	Soft Black Vinyl	M261-2642	1325.54	1401.40	1480.84	1520.56	1555.46	1625.32	1689.12	1866.10	2216.43	2398.13

Improv Series

Improv H.E. High-Back Chair with Task Arms

Shells	Arms/Caps	Number	Fabric Grade								Leather Grade A	Leather Grade B
			A	B	C	D	E	F	G	H		
Pneumatic Height Adjustment with Adjustable Air Lumbar												
Polypropylene	Standard	M251-1444	\$1223.20	\$1299.06	\$1378.50	\$1418.22	\$1453.12	\$1522.98	\$1586.78	\$1763.76	\$1886.54	\$2068.24
	Upholstered	M251-1544	1274.98	1350.84	1430.28	1470.00	1504.90	1574.76	1638.56	1815.54	1938.32	2120.02
	Soft Black Vinyl	M251-1644	1274.98	1350.84	1430.28	1470.00	1504.90	1574.76	1638.56	1815.54	1938.32	2120.02
Upholstered	Standard	M251-2444	\$1348.41	\$1424.27	\$1503.71	\$1543.43	\$1578.33	\$1648.19	\$1711.99	\$1888.97	\$2239.30	\$2421.00
	Upholstered	M251-2544	1400.19	1476.05	1555.49	1595.21	1630.11	1699.97	1763.77	1940.75	2291.08	2472.78
	Soft Black Vinyl	M251-2644	1400.19	1476.05	1555.49	1595.21	1630.11	1699.97	1763.77	1940.75	2291.08	2472.78
Pneumatic Height Adjustment/Back-Lock with Adjustable Air Lumbar												
Polypropylene	Standard	M251-1443	\$1274.98	\$1350.84	\$1430.28	\$1470.00	\$1504.90	\$1574.76	\$1638.56	\$1815.54	\$1938.32	\$2120.02
	Upholstered	M251-1543	1326.76	1402.62	1482.06	1521.78	1556.68	1626.54	1690.34	1867.32	1990.10	2171.80
	Soft Black Vinyl	M251-1643	1326.76	1402.62	1482.06	1521.78	1556.68	1626.54	1690.34	1867.32	1990.10	2171.80
Upholstered	Standard	M251-2443	\$1400.19	\$1476.05	\$1555.49	\$1595.21	\$1630.11	\$1699.97	\$1763.77	\$1940.75	\$2291.08	\$2472.78
	Upholstered	M251-2543	1451.97	1527.83	1607.27	1646.99	1681.89	1751.75	1815.55	1992.53	2342.86	2524.56
	Soft Black Vinyl	M251-2643	1451.97	1527.83	1607.27	1646.99	1681.89	1751.75	1815.55	1992.53	2342.86	2524.56
Pneumatic Height Adjustment/Forward-Tilt with Adjustable Air Lumbar												
Polypropylene	Standard	M261-1444	\$1273.76	\$1349.62	\$1429.06	\$1468.78	\$1503.68	\$1573.54	\$1637.34	\$1814.32	\$1937.10	\$2118.80
	Upholstered	M261-1544	1325.54	1401.40	1480.84	1520.56	1555.46	1625.32	1689.12	1866.10	1988.88	2170.58
	Soft Black Vinyl	M261-1644	1325.54	1401.40	1480.84	1520.56	1555.46	1625.32	1689.12	1866.10	1988.88	2170.58
Upholstered	Standard	M261-2444	\$1398.97	\$1474.83	\$1554.27	\$1593.99	\$1628.89	\$1698.75	\$1762.55	\$1939.53	\$2289.86	\$2471.56
	Upholstered	M261-2544	1450.75	1526.61	1606.05	1645.77	1680.67	1750.53	1814.33	1991.31	2341.64	2523.34
	Soft Black Vinyl	M261-2644	1450.75	1526.61	1606.05	1645.77	1680.67	1750.53	1814.33	1991.31	2341.64	2523.34

The following options require modification of the product number.

Two-stage seat height	To specify, change the 4th digit from a 1 to a 3; Example: M253-1442 (add \$99.93 list)
High arc base	To specify, change the 4th digit from a 1 to a 5; Example: M255-1442
Steel base - Standard height	To specify, change the 4th digit from a 1 to a 6; Example: M256-1442
Steel base - Low height	To specify, change the 4th digit from a 1 to a 7; Example: M257-1442
Plastic base - Low height	To specify, change the 4th digit from a 1 to a 4; Example: M254-1442
Soft casters	To specify, change the 7th digit from a 4 to a 2; Example: M251-1422
Faux Leather upholstery	To specify, change the 2nd digit from a 2 to a 3; Example: M351-1442
Leather upholstery	To specify, change the 2nd digit from a 2 to a 1; Example: M151-1442
CAL 133	To specify, add -F to the end of the product number; Example: M251-2542-F (add \$116.78 list)
Stain repellent	To specify, add -P to the end of the product number; Example: M251-1444-P (add \$38.52 list)

NOTE: CAL 133 is available on all fully upholstered models and chairs with black (TR-F) polypropylene shells backs.

High arc base available in black only.

For available fabrics, refer to surfaces.haworth.com.

Improv Series

Improv H.E. High-Back Chair with Height Adjustable Task Arms



M251-1742

Dimensions

SH: 16" - 21"
(406mm - 533mm)
H: 36 1/2" - 45"
(957mm - 1143mm)
D: 24" - 27 1/4"
(610mm - 692mm)
W: 25"(635mm)
SW: 19.2"(488mm)
SD: 16" - 19"
(406mm - 483mm)
AH: 6.9" - 10.8"
(175mm - 274mm)

Two-stage seat height:
.7"(18mm) below
standard
1.9"(48mm) above
standard

Features

- Outer Shells: Polypropylene or upholstered.
 - Arms: Standard, upholstered fabric or soft black vinyl arm caps.
 - Arm Adjustment Controls: Fingertip activation.
 - Arm Adjustment: 4"(102mm) height adjustment.
 - 3"(76mm) sliding seat pan.
 - Casters: Standard with hard casters; or optional soft casters.
 - Standard plastic base or optional high arc, or steel base.
 - Mechanism: Swivel with synchronized-tilt.
 - Height Adjustment: Pneumatic, pneumatic with two-stage seat height, or pneumatic with low-position seat height option.
 - Optional Back-Lock: Lockable in two positions.
 - Optional Forward Tilt: Lockable in 3 positions.
 - Tilt tension.
 - Optional Adjustable Air Lumbar: additional 1 1/2"(38mm) of lumbar support.
 - Fire retardant construction is available to comply with California Bulletin #133.
 - COM yardage / COL square footage:
Polypropylene shell: 2.13/45
Upholstered shell: 2.75/62
- Available on RUSH.

To Order, Specify:

- 1) Product number.
- 2) Fabric surface and color.
(NOTE: For leather upholstery, see page 203.)
- 3) Trim color for shell, arms and base.

* All measurements taken with the BIFMA chair measuring device.

Shells	Arms/Caps	Number	Fabric Grade								Leather Grade A	Leather Grade B
			A	B	C	D	E	F	G	H		
Pneumatic Height Adjustment												
Polypropylene	Standard	M251-1742	\$1206.34	\$1282.20	\$1361.64	\$1401.36	\$1436.26	\$1506.12	\$1569.92	\$1746.90	\$1869.68	\$2051.38
	Upholstered	M251-1842	1258.12	1333.98	1413.42	1453.14	1488.04	1557.90	1621.70	1798.68	1921.46	2103.16
	Soft Black Vinyl	M251-1942	1258.12	1333.98	1413.42	1453.14	1488.04	1557.90	1621.70	1798.68	1921.46	2103.16
Upholstered	Standard	M251-2742	\$1331.55	\$1407.41	\$1486.85	\$1526.57	\$1561.47	\$1631.33	\$1695.13	\$1872.11	\$2222.44	\$2404.14
	Upholstered	M251-2842	1383.33	1459.19	1538.63	1578.35	1613.25	1683.11	1746.91	1923.89	2274.22	2455.92
	Soft Black Vinyl	M251-2942	1383.33	1459.19	1538.63	1578.35	1613.25	1683.11	1746.91	1923.89	2274.22	2455.92
Pneumatic Height Adjustment/Back-Lock												
Polypropylene	Standard	M251-1741	\$1258.12	\$1333.98	\$1413.42	\$1453.14	\$1488.04	\$1557.90	\$1621.70	\$1798.68	\$1921.46	\$2103.16
	Upholstered	M251-1841	1309.90	1385.76	1465.20	1504.92	1539.82	1609.68	1673.48	1850.46	1973.24	2154.94
	Soft Black Vinyl	M251-1941	1309.90	1385.76	1465.20	1504.92	1539.82	1609.68	1673.48	1850.46	1973.24	2154.94
Upholstered	Standard	M251-2741	\$1383.33	\$1459.19	\$1538.63	\$1578.35	\$1613.25	\$1683.11	\$1746.91	\$1923.89	\$2274.22	\$2455.92
	Upholstered	M251-2841	1435.11	1510.97	1590.41	1630.13	1665.03	1734.89	1798.69	1975.67	2326.00	2507.70
	Soft Black Vinyl	M251-2941	1435.11	1510.97	1590.41	1630.13	1665.03	1734.89	1798.69	1975.67	2326.00	2507.70
Pneumatic Height Adjustment/Forward-Tilt												
Polypropylene	Standard	M261-1742	\$1256.90	\$1332.76	\$1412.20	\$1451.92	\$1486.82	\$1556.68	\$1620.48	\$1797.46	\$1920.24	\$2101.94
	Upholstered	M261-1842	1308.68	1384.54	1463.98	1503.70	1538.60	1608.46	1672.26	1849.24	1972.02	2153.72
	Soft Black Vinyl	M261-1942	1308.68	1384.54	1463.98	1503.70	1538.60	1608.46	1672.26	1849.24	1972.02	2153.72
Upholstered	Standard	M261-2742	\$1382.11	\$1457.97	\$1537.41	\$1577.13	\$1612.03	\$1681.89	\$1745.69	\$1922.67	\$2273.00	\$2454.70
	Upholstered	M261-2842	1433.89	1509.75	1589.19	1628.91	1663.81	1733.67	1797.47	1974.45	2324.78	2506.48
	Soft Black Vinyl	M261-2942	1433.89	1509.75	1589.19	1628.91	1663.81	1733.67	1797.47	1974.45	2324.78	2506.48

Improv Series

Improv H.E. High-Back Chair with Height Adjustable Task Arms

Shells	Arms/Caps	Number	Fabric Grade								Leather Grade A	Leather Grade B
			A	B	C	D	E	F	G	H		
Pneumatic Height Adjustment with Adjustable Air Lumbar												
Polypropylene	Standard	M251-1744	\$1331.55	\$1407.41	\$1486.85	\$1526.57	\$1561.47	\$1631.33	\$1695.13	\$1872.11	\$1994.89	\$2176.59
	Upholstered	M251-1844	1383.33	1459.19	1538.63	1578.35	1613.25	1683.11	1746.91	1923.89	2046.67	2228.37
	Soft Black Vinyl	M251-1944	1383.33	1459.19	1538.63	1578.35	1613.25	1683.11	1746.91	1923.89	2046.67	2228.37
Upholstered	Standard	M251-2744	\$1456.76	\$1532.62	\$1612.06	\$1651.78	\$1686.68	\$1756.54	\$1820.34	\$1997.32	\$2347.65	\$2529.35
	Upholstered	M251-2844	1508.54	1584.40	1663.84	1703.56	1738.46	1808.32	1872.12	2049.10	2399.43	2581.13
	Soft Black Vinyl	M251-2944	1508.54	1584.40	1663.84	1703.56	1738.46	1808.32	1872.12	2049.10	2399.43	2581.13
Pneumatic Height Adjustment/Back-Lock with Adjustable Air Lumbar												
Polypropylene	Standard	M251-1743	\$1383.33	\$1459.19	\$1538.63	\$1578.35	\$1613.25	\$1683.11	\$1746.91	\$1923.89	\$2046.67	\$2228.37
	Upholstered	M251-1843	1435.11	1510.97	1590.41	1630.13	1665.03	1734.89	1798.69	1975.67	2098.45	2280.15
	Soft Black Vinyl	M251-1943	1435.11	1510.97	1590.41	1630.13	1665.03	1734.89	1798.69	1975.67	2098.45	2280.15
Upholstered	Standard	M251-2743	\$1508.54	\$1584.40	\$1663.84	\$1703.56	\$1738.46	\$1808.32	\$1872.12	\$2049.10	\$2399.43	\$2581.13
	Upholstered	M251-2843	1560.32	1636.18	1715.62	1755.34	1790.24	1860.10	1923.90	2100.88	2451.21	2632.91
	Soft Black Vinyl	M251-2943	1560.32	1636.18	1715.62	1755.34	1790.24	1860.10	1923.90	2100.88	2451.21	2632.91
Pneumatic Height Adjustment/Forward-Tilt with Adjustable Air Lumbar												
Polypropylene	Standard	M261-1744	\$1382.11	\$1457.97	\$1537.41	\$1577.13	\$1612.03	\$1681.89	\$1745.69	\$1922.67	\$2045.45	\$2227.15
	Upholstered	M261-1844	1433.89	1509.75	1589.19	1628.91	1663.81	1733.67	1797.47	1974.45	2097.23	2278.93
	Soft Black Vinyl	M261-1944	1433.89	1509.75	1589.19	1628.91	1663.81	1733.67	1797.47	1974.45	2097.23	2278.93
Upholstered	Standard	M261-2744	\$1507.32	\$1583.18	\$1662.62	\$1702.34	\$1737.24	\$1807.10	\$1870.90	\$2047.88	\$2398.21	\$2579.91
	Upholstered	M261-2844	1559.10	1634.96	1714.40	1754.12	1789.02	1858.88	1922.68	2099.66	2449.99	2631.69
	Soft Black Vinyl	M261-2944	1559.10	1634.96	1714.40	1754.12	1789.02	1858.88	1922.68	2099.66	2449.99	2631.69

The following options require modification of the product number.

Two-stage seat height	To specify, change the 4th digit from a 1 to a 3; Example: M253-1742 (add \$99.93 list)
High arc base	To specify, change the 4th digit from a 1 to a 5; Example: M255-1742
Steel base - Standard height	To specify, change the 4th digit from a 1 to a 6; Example: M256-1742
Steel base - Low height	To specify, change the 4th digit from a 1 to a 7; Example: M257-1742
Plastic base - Low height	To specify, change the 4th digit from a 1 to a 4; Example: M254-1742
Soft casters	To specify, change the 7th digit from a 4 to a 2; Example: M251-1722
Faux Leather upholstery	To specify, change the 2nd digit from a 2 to a 3; Example: M351-1742
Leather upholstery	To specify, change the 2nd digit from a 2 to a 1; Example: M151-1742
CAL 133	To specify, add -F to the end of the product number; Example: M251-2842-F (add \$116.78 list)
Stain repellent	To specify, add -P to the end of the product number; Example: M251-1744-P (add \$38.52 list)

NOTE: CAL 133 is available on all fully upholstered models and chairs with black (TR-F) polypropylene shells backs.

High arc base available in black only.

For available fabrics, refer to surfaces.haworth.com.

Improv Series

Improv H.E. High-Back Chair with Flipper Arms



M251-1H42

NOTE:
M261-1G42 offers the best value package of options for this model.

Dimensions

SH: 16" - 21"
(406mm - 533mm)
H: 36 1/2" - 45"
(957mm-1143mm)
D: 24" - 27 1/4"
(610mm - 692mm)
W: 26 1/2"(673mm)
SW: 19.2"(488mm)
SD: 16" - 19"
(406mm - 483mm)
AH: 6.2" - 11.3"
(157mm-287mm)

Two-stage seat height:
.7"(18mm) below
standard
1.9"(48mm) above
standard

Features

- Outer Shells: Polypropylene or upholstered.
- Arms: Standard, upholstered fabric or black vinyl gel arm caps.
- Arm Adjustment Controls: Fingertip activation.
- Arm Adjustment: 5"(127mm) height adjustment.
- Arm Pad Rotation: 360°.
- 3"(76mm) sliding seat pan.
- Casters: Standard with hard casters; for optional soft casters.
- Standard plastic base or optional high arc, or steel base.
- Mechanism: Swivel with synchronized-tilt.
- Height Adjustment: Pneumatic, pneumatic with two-stage seat height, or pneumatic with low-position seat height option.
- Optional Back-Lock: Lockable in two positions.
- Optional Forward Tilt: Lockable in 3 positions.
- Tilt tension.
- Optional Adjustable Air Lumbar: additional 1 1/2"(38mm) of lumbar support.
- Fire retardant construction is available to comply with California Bulletin #133.
- COM yardage / COL square footage:
Polypropylene shell: 2.13/45
Upholstered shell: 2.75/62
- Available on RUSH.

To Order, Specify:

- 1) Product number.
- 2) Fabric surface and color.
(NOTE: For leather upholstery, see page 205.)
- 3) Trim color for shell, arms and base.

* All measurements taken with the BIFMA chair measuring device.

Shells	Arms/Caps	Number	Fabric Grade		C	D	E	F	G	H	Leather Grade A	Leather Grade B
			A	B								
Pneumatic Height Adjustment												
Polypropylene	Standard	M251-1H42	\$1427.86	\$1503.72	\$1583.16	\$1622.88	\$1657.78	\$1727.64	\$1791.44	\$1968.42	\$2091.20	\$2272.90
	Vinyl Gel	M251-1G42	1494.07	1569.93	1649.37	1689.09	1723.99	1793.85	1857.65	2034.63	2157.41	2339.11
	Upholstered	M251-1U42	1541.03	1616.89	1696.33	1736.05	1770.95	1840.81	1904.61	2081.59	2204.37	2386.07
Upholstered	Standard	M251-2H42	\$1553.07	\$1628.93	\$1708.37	\$1748.09	\$1782.99	\$1852.85	\$1916.65	\$2093.63	\$2443.96	\$2625.66
	Vinyl Gel	M251-2G42	1619.28	1695.14	1774.58	1814.30	1849.20	1919.06	1982.86	2159.84	2510.17	2691.87
	Upholstered	M251-2U42	1666.24	1742.10	1821.54	1861.26	1896.16	1966.02	2029.82	2206.80	2557.13	2738.83
Pneumatic Height Adjustment/Back-Lock												
Polypropylene	Standard	M251-1H41	\$1479.64	\$1555.50	\$1634.94	\$1674.66	\$1709.56	\$1779.42	\$1843.22	\$2020.20	\$2142.98	\$2324.68
	Vinyl Gel	M251-1G41	1545.85	1621.71	1701.15	1740.87	1775.77	1845.63	1909.43	2086.41	2209.19	2390.89
	Upholstered	M251-1U41	1592.81	1668.67	1748.11	1787.83	1822.73	1892.59	1956.39	2133.37	2256.15	2437.85
Upholstered	Standard	M251-2H41	\$1604.85	\$1680.71	\$1760.15	\$1799.87	\$1834.77	\$1904.63	\$1968.43	\$2145.41	\$2495.74	\$2677.44
	Vinyl Gel	M251-2G41	1671.06	1746.92	1826.36	1866.08	1900.98	1970.84	2034.64	2211.62	2561.95	2743.65
	Upholstered	M251-2U41	1718.02	1793.88	1873.32	1913.04	1947.94	2017.80	2081.60	2258.58	2608.91	2790.61
Pneumatic Height Adjustment/Forward-Tilt												
Polypropylene	Standard	M261-1H42	\$1478.42	\$1554.28	\$1633.72	\$1673.44	\$1708.34	\$1778.20	\$1842.00	\$2018.98	\$2141.76	\$2323.46
	Vinyl Gel	M261-1G42	1544.63	1620.49	1699.93	1739.65	1774.55	1844.41	1908.21	2085.19	2207.97	2389.67
	Upholstered	M261-1U42	1591.59	1667.45	1746.89	1786.61	1821.51	1891.37	1955.17	2132.15	2254.93	2436.63
Upholstered	Standard	M261-2H42	\$1603.63	\$1679.49	\$1758.93	\$1798.65	\$1833.55	\$1903.41	\$1967.21	\$2144.19	\$2494.52	\$2676.22
	Vinyl Gel	M261-2G42	1669.84	1745.70	1825.14	1864.86	1899.76	1969.62	2033.42	2210.40	2560.73	2742.43
	Upholstered	M261-2U42	1716.80	1792.66	1872.10	1911.82	1946.72	2016.58	2080.38	2257.36	2607.69	2789.39

Improv Series

Improv H.E. High-Back Chair with Flipper Arms

Shells	Arms/Caps	Number	Fabric Grade								Leather Grade A	Leather Grade B
			A	B	C	D	E	F	G	H		
Pneumatic Height Adjustment with Adjustable Air Lumbar												
Polypropylene	Standard	M251-1H44	\$1553.07	\$1628.93	\$1708.37	\$1748.09	\$1782.99	\$1852.85	\$1916.65	\$2093.63	\$2216.41	\$2398.11
	Vinyl Gel	M251-1G44	1619.28	1695.14	1774.58	1814.30	1849.20	1919.06	1982.86	2159.84	2282.62	2464.32
	Upholstered	M251-1U44	1666.24	1742.10	1821.54	1861.26	1896.16	1966.02	2029.82	2206.80	2329.58	2511.28
Upholstered	Standard	M251-2H44	\$1678.28	\$1754.14	\$1833.58	\$1873.30	\$1908.20	\$1978.06	\$2041.86	\$2218.84	\$2569.17	\$2750.87
	Vinyl Gel	M251-2G44	1744.49	1820.35	1899.79	1939.51	1974.41	2044.27	2108.07	2285.05	2635.38	2817.08
	Upholstered	M251-2U44	1791.45	1867.31	1946.75	1986.47	2021.37	2091.23	2155.03	2332.01	2682.34	2864.04
Pneumatic Height Adjustment/Back-Lock with Adjustable Air Lumbar												
Polypropylene	Standard	M251-1H43	\$1604.85	\$1680.71	\$1760.15	\$1799.87	\$1834.77	\$1904.63	\$1968.43	\$2145.41	\$2268.19	\$2449.89
	Vinyl Gel	M251-1G43	1671.06	1746.92	1826.36	1866.08	1900.98	1970.84	2034.64	2211.62	2334.40	2516.10
	Upholstered	M251-1U43	1718.02	1793.88	1873.32	1913.04	1947.94	2017.80	2081.60	2258.58	2381.36	2563.06
Upholstered	Standard	M251-2H43	\$1730.06	\$1805.92	\$1885.36	\$1925.08	\$1959.98	\$2029.84	\$2093.64	\$2270.62	\$2620.95	\$2802.65
	Vinyl Gel	M251-2G43	1796.27	1872.13	1951.57	1991.29	2026.19	2096.05	2159.85	2336.83	2687.16	2868.86
	Upholstered	M251-2U43	1843.23	1919.09	1998.53	2038.25	2073.15	2143.01	2206.81	2383.79	2734.12	2915.82
Pneumatic Height Adjustment/Forward-Tilt with Adjustable Air Lumbar												
Polypropylene	Standard	M261-1H44	\$1603.63	\$1679.49	\$1758.93	\$1798.65	\$1833.55	\$1903.41	\$1967.21	\$2144.19	\$2266.97	\$2448.67
	Vinyl Gel	M261-1G44	1669.84	1745.70	1825.14	1864.86	1899.76	1969.62	2033.42	2210.40	2333.18	2514.88
	Upholstered	M261-1U44	1716.80	1792.66	1872.10	1911.82	1946.72	2016.58	2080.38	2257.36	2380.14	2561.84
Upholstered	Standard	M261-2H44	\$1728.84	\$1804.70	\$1884.14	\$1923.86	\$1958.76	\$2028.62	\$2092.42	\$2269.40	\$2619.73	\$2801.43
	Vinyl Gel	M261-2G44	1795.05	1870.91	1950.35	1990.07	2024.97	2094.83	2158.63	2335.61	2685.94	2867.64
	Upholstered	M261-2U44	1842.01	1917.87	1997.31	2037.03	2071.93	2141.79	2205.59	2382.57	2732.90	2914.60

The following options require modification of the product number.

Two-stage seat height	To specify, change the 4th digit from a 1 to a 3; Example: M253-1H42 (add \$99.93 list)
High arc base	To specify, change the 4th digit from a 1 to a 5; Example: M255-1H42
Steel base - Standard height	To specify, change the 4th digit from a 1 to a 6; Example: M256-1H42
Steel base - Low height	To specify, change the 4th digit from a 1 to a 7; Example: M257-1H42
Plastic base - Low height	To specify, change the 4th digit from a 1 to a 4; Example: M254-1H42
Soft casters	To specify, change the 7th digit from a 4 to a 2; Example: M251-1H22
Faux Leather upholstery	To specify, change the 2nd digit from a 2 to a 3; Example: M351-1H42
Leather upholstery	To specify, change the 2nd digit from a 2 to a 1; Example: M151-1H42
CAL 133	To specify, add -F to the end of the product number; Example: M251-2U42-F (add \$116.78 list)
Stain repellent	To specify, add -P to the end of the product number; Example: M251-1H44-P (add \$38.52 list)

NOTE: CAL 133 is available on all fully upholstered models and chairs with black (TR-F) polypropylene shells backs.

CAL 133 is not available on chairs with vinyl gel arm caps.

High arc base available in black only.

For available fabrics, refer to surfaces.haworth.com.

Improv Series

Improv H.E. High-Back Chair with Height and Width Adjustable 3-D Arms



M251-1W42

Dimensions

SH: 16" - 21"
(406mm - 533mm)
H: 36 1/2" - 45"
(957mm - 1143mm)
D: 24" - 27 1/4"
(610mm - 692mm)
W: 25"(635mm)
SW: 19.2"(488mm)
SD: 16" - 19"
(406mm - 483mm)
AH: 3 3/4" - 7 3/4"
(95mm-197mm)
AW: 25 1/2" - 29 1/4"
(647mm-743mm)

Two-stage seat height:
.7"(18mm) below
standard
1.9"(48mm) above
standard

Features

- Outer Shells: Polypropylene or upholstered.
- Arms: Molded black vinyl.
- 3"(76mm) sliding seat pan.
- Casters: Standard with hard casters; or optional soft casters, see below.
- Standard plastic base or optional high arc, or steel base.
- Mechanism: Swivel with synchronized-tilt.
- Height Adjustment: Pneumatic, pneumatic with two-stage seat height, or pneumatic with low-position seat height option.
- Arm Adjustment: 4"(102mm) height adjustment.
- Arm Width Adjustment: 1 1/2"(38mm) per arm in-out adjustment.
- Arm Pad Rotation: 360°.
- Arm Adjustment Controls: Fingertip activation.
- Optional Back-Lock: Lockable in two positions.
- Optional Forward Tilt: Lockable in 3 positions.
- Tilt tension.
- Optional Adjustable Air Lumbar: additional 1 1/2"(38mm) of lumbar support.
- COM yardage / COL square footage:
Polypropylene shell: 2.13/45
Upholstered shell: 2.75/62

To Order, Specify:

- 1) Product number.
- 2) Fabric surface and color.
(NOTE: For leather upholstery, see below.)
- 3) Trim color for shell, arms and base.

* All measurements taken with the BIFMA chair measuring device.

Shells	Arms/Caps	Number	Fabric Grade								Leather Grade A	Leather Grade B
			A	B	C	D	E	F	G	H		
Pneumatic Height Adjustment												
Polypropylene	Molded Black Vinyl	M251-1W42	\$1339.97	\$1415.83	\$1495.27	\$1534.99	\$1569.89	\$1639.75	\$1703.55	\$1880.53	\$2003.31	\$2185.01
Upholstered	Molded Black Vinyl	M251-2W42	1465.18	1541.04	1620.48	1660.20	1695.10	1764.96	1828.76	2005.74	2356.07	2537.77
Pneumatic Height Adjustment/Back-Lock												
Polypropylene	Molded Black Vinyl	M251-1W41	\$1391.75	\$1467.61	\$1547.05	\$1586.77	\$1621.67	\$1691.53	\$1755.33	\$1932.31	\$2055.09	\$2236.79
Upholstered	Molded Black Vinyl	M251-2W41	1516.96	1592.82	1672.26	1711.98	1746.88	1816.74	1880.54	2057.52	2407.85	2589.55
Pneumatic Height Adjustment/Forward-Tilt												
Polypropylene	Molded Black Vinyl	M261-1W42	\$1390.53	\$1466.39	\$1545.83	\$1585.55	\$1620.45	\$1690.31	\$1754.11	\$1931.09	\$2053.87	\$2235.57
Upholstered	Molded Black Vinyl	M261-2W42	1515.74	1591.60	1671.04	1710.76	1745.66	1815.52	1879.32	2056.30	2406.63	2588.33
Pneumatic Height Adjustment with Adjustable Air Lumbar												
Polypropylene	Molded Black Vinyl	M251-1W44	\$1465.18	\$1541.04	\$1620.48	\$1660.20	\$1695.10	\$1764.96	\$1828.76	\$2005.74	\$2128.52	\$2310.22
Upholstered	Molded Black Vinyl	M251-2W44	1590.39	1666.25	1745.69	1785.41	1820.31	1890.17	1953.97	2130.95	2481.28	2662.98
Pneumatic Height Adjustment/Back-Lock with Adjustable Air Lumbar												
Polypropylene	Molded Black Vinyl	M251-1W43	\$1516.96	\$1592.82	\$1672.26	\$1711.98	\$1746.88	\$1816.74	\$1880.54	\$2057.52	\$2180.30	\$2362.00
Upholstered	Molded Black Vinyl	M251-2W43	1642.17	1718.03	1797.47	1837.19	1872.09	1941.95	2005.75	2182.73	2533.06	2714.76
Pneumatic Height Adjustment/Forward-Tilt with Adjustable Air Lumbar												
Polypropylene	Molded Black Vinyl	M261-1W44	\$1515.74	\$1591.60	\$1671.04	\$1710.76	\$1745.66	\$1815.52	\$1879.32	\$2056.30	\$2179.08	\$2360.78
Upholstered	Molded Black Vinyl	M261-2W44	1640.95	1716.81	1796.25	1835.97	1870.87	1940.73	2004.53	2181.51	2531.84	2713.54

The following options require modification of the product number.

- Two-stage seat height
- High arc base
- Steel base - Standard height
- Steel base - Low height
- Plastic base - Low height
- Soft casters
- Faux Leather upholstery
- Leather upholstery
- CAL 133
- Stain repellent

- To specify, change the 4th digit from a 1 to a 3; **Example:** M253-1W42 (add **\$99.93** list)
- To specify, change the 4th digit from a 1 to a 5; **Example:** M255-1W42
- To specify, change the 4th digit from a 1 to a 6; **Example:** M256-1W42
- To specify, change the 4th digit from a 1 to a 7; **Example:** M257-1W42
- To specify, change the 4th digit from a 1 to a 4; **Example:** M254-1W42
- To specify, change the 7th digit from a 4 to a 2; **Example:** M251-1W22
- To specify, change the 2nd digit from a 2 to a 3; **Example:** M351-1W42
- To specify, change the 2nd digit from a 2 to a 1; **Example:** M151-1W42
- To specify, add **-F** to the end of the product number; **Example:** M251-2W42-F (add **\$116.78** list)
- To specify, add **-P** to the end of the product number; **Example:** M251-1W42-P (add **\$38.52** list)

NOTE: CAL 133 is available on all fully upholstered models and chairs with black (TR-F) polypropylene shells backs.

High arc base available in black only.

For available fabrics, refer to surfaces.haworth.com.

Improv Series

Improv H.E. High-Back Chair without Arms



M251-1042

Dimensions

SH: 16" - 21"
(406mm - 533mm)
H: 36 1/2" - 45"
(957mm-1143mm)
D: 24" - 27 1/4"
(610mm - 692mm)
W: 26 1/2"(673mm)
SW: 19.2"(488mm)
SD: 16" - 19"
(406mm - 483mm)

Two-stage seat height:
.7"(18mm) below
standard
1.9"(48mm) above
standard

Features

- Outer Shells: Polypropylene or upholstered.
- Casters: Standard with hard casters; or optional soft casters, see below.
- 3"(76mm) sliding seat pan.
- Standard plastic base or optional high arc, or steel base.
- Mechanism: Swivel with synchronized-tilt.
- Height Adjustment: Pneumatic or pneumatic with two-stage seat height, see below.
- Optional Back-Lock: Lockable in two positions.
- Optional Forward Tilt: Lockable in 3 positions.
- Tilt tension.
- Optional Adjustable Air Lumbar: additional 1 1/2"(38mm) of lumbar support.
- Fire retardant construction is available to comply with California Bulletin #133, see below.
- COM yardage / COL square footage:
Polypropylene shell: 2.13/45
Upholstered shell: 2.75/62
- Available on RUSH.

To Order, Specify:

- 1) Product number.
- 2) Fabric surface and color.
(NOTE: For leather upholstery, see below.)
- 3) Trim color for shell and base.

* All measurements taken with the BIFMA chair measuring device.

Shells	Number	Fabric Grade		C	D	E	F	G	H	Leather Grade A	Leather Grade B
		A	B								
Pneumatic Height Adjustment											
Polypropylene	M251-1042 ■	\$ 996.85	\$1072.71	\$1152.15	\$1191.87	\$1226.77	\$1296.63	\$1360.43	\$1537.41	\$1660.19	\$1841.89
Upholstered	M251-2042 ■	1122.06	1197.92	1277.36	1317.08	1351.98	1421.84	1485.64	1662.62	2012.95	2194.65
Pneumatic Height Adjustment/Back-Lock											
Polypropylene	M251-1041 ■	\$1048.63	\$1124.49	\$1203.93	\$1243.65	\$1278.55	\$1348.41	\$1412.21	\$1589.19	\$1711.97	\$1893.67
Upholstered	M251-2041 ■	1173.84	1249.70	1329.14	1368.86	1403.76	1473.62	1537.42	1714.40	2064.73	2246.43
Pneumatic Height Adjustment/Forward-Tilt											
Polypropylene	M261-1042 ■	\$1047.41	\$1123.27	\$1202.71	\$1242.43	\$1277.33	\$1347.19	\$1410.99	\$1587.97	\$1710.75	\$1892.45
Upholstered	M261-2042 ■	1172.62	1248.48	1327.92	1367.64	1402.54	1472.40	1536.20	1713.18	2063.51	2245.21
Pneumatic Height Adjustment with Adjustable Air Lumbar											
Polypropylene	M251-1044	\$1122.06	\$1197.92	\$1277.36	\$1317.08	\$1351.98	\$1421.84	\$1485.64	\$1662.62	\$1785.40	\$1967.10
Upholstered	M251-2044	1247.27	1323.13	1402.57	1442.29	1477.19	1547.05	1610.85	1787.83	2138.16	2319.86
Pneumatic Height Adjustment/Back-Lock with Adjustable Air Lumbar											
Polypropylene	M251-1043	\$1173.84	\$1249.70	\$1329.14	\$1368.86	\$1403.76	\$1473.62	\$1537.42	\$1714.40	\$1837.18	\$2018.88
Upholstered	M251-2043	1299.05	1374.91	1454.35	1494.07	1528.97	1598.83	1662.63	1839.61	2189.94	2371.64
Pneumatic Height Adjustment/Forward-Tilt with Adjustable Air Lumbar											
Polypropylene	M261-1044	\$1172.62	\$1248.48	\$1327.92	\$1367.64	\$1402.54	\$1472.40	\$1536.20	\$1713.18	\$1835.96	\$2017.66
Upholstered	M261-2044	1297.83	1373.69	1453.13	1492.85	1527.75	1597.61	1661.41	1838.39	2188.72	2370.42

The following options require modification of the product number.

- Two-stage seat height
- High arc base
- Steel base - Standard height
- Steel base - Low height
- Plastic base - Low height
- Soft casters
- Faux Leather upholstery
- Leather upholstery
- CAL 133
- Stain repellent

- To specify, change the 4th digit from a 1 to a 3; **Example:** M253-1042 (add \$99.93 list)
- To specify, change the 4th digit from a 1 to a 5; **Example:** M255-1042
- To specify, change the 4th digit from a 1 to a 6; **Example:** M256-1042
- To specify, change the 4th digit from a 1 to a 7; **Example:** M257-1042
- To specify, change the 4th digit from a 1 to a 4; **Example:** M254-1042
- To specify, change the 7th digit from a 4 to a 2; **Example:** M251-1022
- To specify, change the 2nd digit from a 2 to a 3; **Example:** M351-1042
- To specify, change the 2nd digit from a 2 to a 1; **Example:** M151-1042
- To specify, add -F to the end of the product number; **Example:** M251-2042-F (add \$116.78 list)
- To specify, add -P to the end of the product number; **Example:** M251-1042-P (add \$38.52 list)

NOTE: CAL 133 is available on all fully upholstered models and chairs with black (TR-F) polypropylene shells backs.

High arc base available in black only.

For available fabrics, refer to surfaces.haworth.com.

Improv Series

Improv H.E. Mid-Back Chair with Task Arms



M231-1442

Dimensions

- SH: 16" - 21"
(406mm - 533mm)
- H: 34" - 42 1/2"
(864mm - 1080mm)
- D: 23" - 25 1/2"
(584mm - 648mm)
- W: 25"(635mm)
- SW: 19.2"(488mm)
- SD: 16" - 19"
(406mm - 483mm)
- AH: 9 5/8"(244mm)

Two-stage seat height:
.7"(18mm) below
standard
1.9"(48mm) above
standard

Features

- Outer Shells: Polypropylene or upholstered.
- Arms: Standard, upholstered fabric or soft black vinyl arm caps.
- Casters: Standard with hard casters; or optional soft casters.
- 3"(76mm) sliding seat pan.
- Standard plastic base or optional high arc, or steel base.
- Mechanism: Swivel with synchronized-tilt.
- Height Adjustment: Pneumatic, pneumatic with two-stage seat height, or pneumatic with low- position seat height.
- Optional Back-Lock: Lockable in two positions.
- Optional Forward Tilt: Lockable in 3 positions.
- Tilt tension.
- Optional Adjustable Air Lumbar: additional 1 1/2"(38mm) of lumbar support.
- Fire retardant construction is available to comply with California Bulletin #133.
- COM yardage / COL square footage:
Polypropylene shell: 1.50/39
Upholstered shell: 2.25/45
- Available on RUSH with hard casters.

To Order, Specify:

- 1) Product number.
- 2) Fabric surface and color.
(NOTE: For leather upholstery, see page 209.)
- 3) Trim color for shell, arms and base.

* All measurements taken with the BIFMA chair measuring device.

Shells	Arms/Caps	Number	Fabric Grade		C	D	E	F	G	H	Leather Grade A	Leather Grade B
			A	B								
Pneumatic Height Adjustment												
Polypropylene	Standard	M231-1442	\$1017.33	\$1093.19	\$1172.63	\$1212.35	\$1247.25	\$1317.11	\$1380.91	\$1557.89	\$1680.67	\$1862.37
	Upholstered	M231-1542	1069.11	1144.97	1224.41	1264.13	1299.03	1368.89	1432.69	1609.67	1732.45	1914.15
	Soft Black Vinyl	M231-1642	1069.11	1144.97	1224.41	1264.13	1299.03	1368.89	1432.69	1609.67	1732.45	1914.15
Upholstered	Standard	M231-2442	\$1142.54	\$1218.40	\$1297.84	\$1337.56	\$1372.46	\$1442.32	\$1506.12	\$1683.10	\$2033.43	\$2215.13
	Upholstered	M231-2542	1194.32	1270.18	1349.62	1389.34	1424.24	1494.10	1557.90	1734.88	2085.21	2266.91
	Soft Black Vinyl	M231-2642	1194.32	1270.18	1349.62	1389.34	1424.24	1494.10	1557.90	1734.88	2085.21	2266.91
Pneumatic Height Adjustment/Back-Lock												
Polypropylene	Standard	M231-1441	\$1069.11	\$1144.97	\$1224.41	\$1264.13	\$1299.03	\$1368.89	\$1432.69	\$1609.67	\$1732.45	\$1914.15
	Upholstered	M231-1541	1120.89	1196.75	1276.19	1315.91	1350.81	1420.67	1484.47	1661.45	1784.23	1965.93
	Soft Black Vinyl	M231-1641	1120.89	1196.75	1276.19	1315.91	1350.81	1420.67	1484.47	1661.45	1784.23	1965.93
Upholstered	Standard	M231-2441	\$1194.32	\$1270.18	\$1349.62	\$1389.34	\$1424.24	\$1494.10	\$1557.90	\$1734.88	\$2085.21	\$2266.91
	Upholstered	M231-2541	1246.10	1321.96	1401.40	1441.12	1476.02	1545.88	1609.68	1786.66	2136.99	2318.69
	Soft Black Vinyl	M231-2641	1246.10	1321.96	1401.40	1441.12	1476.02	1545.88	1609.68	1786.66	2136.99	2318.69
Pneumatic Height Adjustment/Forward-Tilt												
Polypropylene	Standard	M241-1442	\$1067.89	\$1143.75	\$1223.19	\$1262.91	\$1297.81	\$1367.67	\$1431.47	\$1608.45	\$1731.23	\$1912.93
	Upholstered	M241-1542	1119.67	1195.53	1274.97	1314.69	1349.59	1419.45	1483.25	1660.23	1783.01	1964.71
	Soft Black Vinyl	M241-1642	1119.67	1195.53	1274.97	1314.69	1349.59	1419.45	1483.25	1660.23	1783.01	1964.71
Upholstered	Standard	M241-2442	\$1193.10	\$1268.96	\$1348.40	\$1388.12	\$1423.02	\$1492.88	\$1556.68	\$1733.66	\$2083.99	\$2265.69
	Upholstered	M241-2542	1244.88	1320.74	1400.18	1439.90	1474.80	1544.66	1608.46	1785.44	2135.77	2317.47
	Soft Black Vinyl	M241-2642	1244.88	1320.74	1400.18	1439.90	1474.80	1544.66	1608.46	1785.44	2135.77	2317.47

Improv Series

Improv H.E. Mid-Back Chair with Task Arms

Shells	Arms/Caps	Number	Fabric Grade								Leather Grade A	Leather Grade B
			A	B	C	D	E	F	G	H		
Pneumatic Height Adjustment with Adjustable Air Lumbar												
Polypropylene	Standard	M231-1444	\$1142.54	\$1218.40	\$1297.84	\$1337.56	\$1372.46	\$1442.32	\$1506.12	\$1683.10	\$1805.88	\$1987.58
	Upholstered	M231-1544	1194.32	1270.18	1349.62	1389.34	1424.24	1494.10	1557.90	1734.88	1857.66	2039.36
	Soft Black Vinyl	M231-1644	1194.32	1270.18	1349.62	1389.34	1424.24	1494.10	1557.90	1734.88	1857.66	2039.36
Upholstered	Standard	M231-2444	\$1267.75	\$1343.61	\$1423.05	\$1462.77	\$1497.67	\$1567.53	\$1631.33	\$1808.31	\$2158.64	\$2340.34
	Upholstered	M231-2544	1319.53	1395.39	1474.83	1514.55	1549.45	1619.31	1683.11	1860.09	2210.42	2392.12
	Soft Black Vinyl	M231-2644	1319.53	1395.39	1474.83	1514.55	1549.45	1619.31	1683.11	1860.09	2210.42	2392.12
Pneumatic Height Adjustment/Back-Lock with Adjustable Air Lumbar												
Polypropylene	Standard	M231-1443	\$1194.32	\$1270.18	\$1349.62	\$1389.34	\$1424.24	\$1494.10	\$1557.90	\$1734.88	\$1857.66	\$2039.36
	Upholstered	M231-1543	1246.10	1321.96	1401.40	1441.12	1476.02	1545.88	1609.68	1786.66	1909.44	2091.14
	Soft Black Vinyl	M231-1643	1246.10	1321.96	1401.40	1441.12	1476.02	1545.88	1609.68	1786.66	1909.44	2091.14
Upholstered	Standard	M231-2443	\$1319.53	\$1395.39	\$1474.83	\$1514.55	\$1549.45	\$1619.31	\$1683.11	\$1860.09	\$2210.42	\$2392.12
	Upholstered	M231-2543	1371.31	1447.17	1526.61	1566.33	1601.23	1671.09	1734.89	1911.87	2262.20	2443.90
	Soft Black Vinyl	M231-2643	1371.31	1447.17	1526.61	1566.33	1601.23	1671.09	1734.89	1911.87	2262.20	2443.90
Pneumatic Height Adjustment/Forward-Tilt with Adjustable Air Lumbar												
Polypropylene	Standard	M241-1444	\$1193.10	\$1268.96	\$1348.40	\$1388.12	\$1423.02	\$1492.88	\$1556.68	\$1733.66	\$1856.44	\$2038.14
	Upholstered	M241-1544	1244.88	1320.74	1400.18	1439.90	1474.80	1544.66	1608.46	1785.44	1908.22	2089.92
	Soft Black Vinyl	M241-1644	1244.88	1320.74	1400.18	1439.90	1474.80	1544.66	1608.46	1785.44	1908.22	2089.92
Upholstered	Standard	M241-2444	\$1318.31	\$1394.17	\$1473.61	\$1513.33	\$1548.23	\$1618.09	\$1681.89	\$1858.87	\$2209.20	\$2390.90
	Upholstered	M241-2544	1370.09	1445.95	1525.39	1565.11	1600.01	1669.87	1733.67	1910.65	2260.98	2442.68
	Soft Black Vinyl	M241-2644	1370.09	1445.95	1525.39	1565.11	1600.01	1669.87	1733.67	1910.65	2260.98	2442.68

The following options require modification of the product number.

Low-position seat height - Plastic	To specify, change the 4th digit from a 1 to a 4; Example: M234-1442
Two-stage seat height- HAB	To specify, change the 4th digit from a 1 to a 3; Example: M233-1442 (add \$99.93 list)
High arc base	To specify, change the 4th digit from a 1 to a 5; Example: M235-1442
Steel base - Standard height	To specify, change the 4th digit from a 1 to a 6; Example: M236-1442
Steel base - Low height	To specify, change the 4th digit from a 1 to a 7; Example: M237-1442
Soft casters	To specify, change the 7th digit from a 4 to a 2; Example: M231-1422
Faux Leather upholstery	To specify, change the 2nd digit from a 2 to a 3; Example: M331-1442
Leather upholstery	To specify, change the 2nd digit from a 2 to a 1; Example: M131-1442
CAL 133	To specify, add -F to the end of the product number; Example: M231-2542-F (add \$116.78 list)
Stain repellent	To specify, add -P to the end of the product number; Example: M231-1444-P (add \$38.52 list)

NOTE: CAL 133 is available on all fully upholstered models and chairs with black (TR-F) polypropylene shells backs.

High arc base available in black only.

For available fabrics, refer to surfaces.haworth.com.

Improv Series

Improv H.E. Mid-Back Chair with Height Adjustable Task Arms



M231-1742

Dimensions

SH: 16" - 21"
(406mm - 533mm)
H: 34" - 42 1/2"
(864mm - 1080mm)
D: 23" - 25 1/2"
(584mm - 648mm)
W: 25"(635mm)
SW: 19.2"(488mm)
SD: 16" - 19"
(406mm - 483mm)
AH: 4.6" - 8.4"
(117mm-213mm)

Two-stage seat height:
.7"(18mm) below
standard
1.9"(48mm) above
standard

Features

- Outer Shells: Polypropylene or upholstered.
 - Arms: Standard, upholstered fabric or soft black vinyl arm caps.
 - Arm Adjustment Controls: Fingertip activation.
 - Casters: Standard with hard casters; or optional soft casters.
 - 3"(76mm) sliding seat pan.
 - Standard plastic base or optional high arc, or steel base.
 - Mechanism: Swivel with synchronized-tilt.
 - Height Adjustment: Pneumatic, pneumatic with two-stage seat height, or pneumatic with low-position seat height option.
 - Arm Adjustment: 4"(102mm) height adjustment.
 - Optional Back-Lock: Lockable in two positions.
 - Optional Forward Tilt: Lockable in 3 positions.
 - Tilt tension.
 - Optional Adjustable Air Lumbar: additional 1 1/2"(38mm) of lumbar support.
 - Fire retardant construction is available to comply with California Bulletin #133.
 - COM yardage / COL square footage:
Polypropylene shell: 1.50/39
Upholstered shell: 2.25/45
- Available on RUSH with hard casters.

To Order, Specify:

- 1) Product number.
- 2) Fabric surface and color.
(NOTE: For leather upholstery, see page 211.)
- 3) Trim color for shell, arms and base.

* All measurements taken with the BIFMA chair measuring device.

Shells	Arms/Caps	Number	Fabric Grade								Leather Grade A	Leather Grade B
			A	B	C	D	E	F	G	H		
Pneumatic Height Adjustment												
Polypropylene	Standard	M231-1742	\$1125.68	\$1201.54	\$1280.98	\$1320.70	\$1355.60	\$1425.46	\$1489.26	\$1666.24	\$1789.02	\$1970.72
	Upholstered	M231-1842	1177.46	1253.32	1332.76	1372.48	1407.38	1477.24	1541.04	1718.02	1840.80	2022.50
	Soft Black Vinyl	M231-1942	1177.46	1253.32	1332.76	1372.48	1407.38	1477.24	1541.04	1718.02	1840.80	2022.50
Upholstered	Standard	M231-2742	\$1250.89	\$1326.75	\$1406.19	\$1445.91	\$1480.81	\$1550.67	\$1614.47	\$1791.45	\$2141.78	\$2323.48
	Upholstered	M231-2842	1302.67	1378.53	1457.97	1497.69	1532.59	1602.45	1666.25	1843.23	2193.56	2375.26
	Soft Black Vinyl	M231-2942	1302.67	1378.53	1457.97	1497.69	1532.59	1602.45	1666.25	1843.23	2193.56	2375.26
Pneumatic Height Adjustment/Back-Lock												
Polypropylene	Standard	M231-1741	\$1177.46	\$1253.32	\$1332.76	\$1372.48	\$1407.38	\$1477.24	\$1541.04	\$1718.02	\$1840.80	\$2022.50
	Upholstered	M231-1841	1229.24	1305.10	1384.54	1424.26	1529.02	1529.02	1592.82	1769.80	1892.58	2074.28
	Soft Black Vinyl	M231-1941	1229.24	1305.10	1384.54	1424.26	1459.16	1529.02	1592.82	1769.80	1892.58	2074.28
Upholstered	Standard	M231-2741	\$1302.67	\$1378.53	\$1457.97	\$1497.69	\$1532.59	\$1602.45	\$1666.25	\$1843.23	\$2193.56	\$2375.26
	Upholstered	M231-2841	1354.45	1430.31	1509.75	1549.47	1584.37	1654.23	1718.03	1895.01	2245.34	2427.04
	Soft Black Vinyl	M231-2941	1354.45	1430.31	1509.75	1549.47	1584.37	1654.23	1718.03	1895.01	2245.34	2427.04
Pneumatic Height Adjustment/Forward-Tilt												
Polypropylene	Standard	M241-1742	\$1176.24	\$1252.10	\$1331.54	\$1371.26	\$1406.16	\$1476.02	\$1539.82	\$1716.80	\$1839.58	\$2021.28
	Upholstered	M241-1842	1228.02	1303.88	1383.32	1423.04	1457.94	1527.80	1591.60	1768.58	1891.36	2073.06
	Soft Black Vinyl	M241-1942	1228.02	1303.88	1383.32	1423.04	1457.94	1527.80	1591.60	1768.58	1891.36	2073.06
Upholstered	Standard	M241-2742	\$1301.45	\$1377.31	\$1456.75	\$1496.47	\$1531.37	\$1601.23	\$1665.03	\$1842.01	\$2192.34	\$2374.04
	Upholstered	M241-2842	1353.23	1429.09	1508.53	1548.25	1583.15	1653.01	1716.81	1893.79	2244.12	2425.82
	Soft Black Vinyl	M241-2942	1353.23	1429.09	1508.53	1548.25	1583.15	1653.01	1716.81	1893.79	2244.12	2425.82

Improv Series

Improv H.E. Mid-Back Chair with Height Adjustable Task Arms

Shells	Arms/Caps	Number	Fabric Grade								Leather Grade A	Leather Grade B
			A	B	C	D	E	F	G	H		
Pneumatic Height Adjustment with Adjustable Air Lumbar												
Polypropylene	Standard	M231-1744	\$1250.89	\$1326.75	\$1406.19	\$1445.91	\$1480.81	\$1550.67	\$1614.47	\$1791.45	\$1914.23	\$2095.93
	Upholstered	M231-1844	1302.67	1378.53	1457.97	1497.69	1532.59	1602.45	1666.25	1843.23	1966.01	2147.71
	Soft Black Vinyl	M231-1944	1302.67	1378.53	1457.97	1497.69	1532.59	1602.45	1666.25	1843.23	1966.01	2147.71
Upholstered	Standard	M231-2744	\$1376.10	\$1451.96	\$1531.40	\$1571.12	\$1606.02	\$1675.88	\$1739.68	\$1916.66	\$2266.99	\$2448.69
	Upholstered	M231-2844	1427.88	1503.74	1583.18	1622.90	1657.80	1727.66	1791.46	1968.44	2318.77	2500.47
	Soft Black Vinyl	M231-2944	1427.88	1503.74	1583.18	1622.90	1657.80	1727.66	1791.46	1968.44	2318.77	2500.47
Pneumatic Height Adjustment/Back-Lock with Adjustable Air Lumbar												
Polypropylene	Standard	M231-1743	\$1302.67	\$1378.53	\$1457.97	\$1497.69	\$1532.59	\$1602.45	\$1666.25	\$1843.23	\$1966.01	\$2147.71
	Upholstered	M231-1843	1354.45	1430.31	1509.75	1549.47	1584.37	1654.23	1718.03	1895.01	2017.79	2199.49
	Soft Black Vinyl	M231-1943	1354.45	1430.31	1509.75	1549.47	1584.37	1654.23	1718.03	1895.01	2017.79	2199.49
Upholstered	Standard	M231-2743	\$1427.88	\$1503.74	\$1583.18	\$1622.90	\$1657.80	\$1727.66	\$1791.46	\$1968.44	\$2318.77	\$2500.47
	Upholstered	M231-2843	1479.66	1555.52	1634.96	1674.68	1709.58	1779.44	1843.24	2020.22	2370.55	2552.25
	Soft Black Vinyl	M231-2943	1479.66	1555.52	1634.96	1674.68	1709.58	1779.44	1843.24	2020.22	2370.55	2552.25
Pneumatic Height Adjustment/Forward-Tilt with Adjustable Air Lumbar												
Polypropylene	Standard	M241-1744	\$1301.45	\$1377.31	\$1456.75	\$1496.47	\$1531.37	\$1601.23	\$1665.03	\$1842.01	\$1964.79	\$2146.49
	Upholstered	M241-1844	1353.23	1429.09	1508.53	1548.25	1583.15	1653.01	1716.81	1893.79	2016.57	2198.27
	Soft Black Vinyl	M241-1944	1353.23	1429.09	1508.53	1548.25	1583.15	1653.01	1716.81	1893.79	2016.57	2198.27
Upholstered	Standard	M241-2744	\$1426.66	\$1502.52	\$1581.96	\$1621.68	\$1656.58	\$1726.44	\$1790.24	\$1967.22	\$2317.55	\$2499.25
	Upholstered	M241-2844	1478.44	1554.30	1633.74	1673.46	1708.36	1778.22	1842.02	2019.00	2369.33	2551.03
	Soft Black Vinyl	M241-2944	1478.44	1554.30	1633.74	1673.46	1708.36	1778.22	1842.02	2019.00	2369.33	2551.03

The following options require modification of the product number.

Low-position seat height - Plastic	To specify, change the 4th digit from a 1 to a 4; Example: M234-1742
Two-stage seat height- HAB	To specify, change the 4th digit from a 1 to a 3; Example: M233-1742 (add \$99.93 list)
High arc base	To specify, change the 4th digit from a 1 to a 5; Example: M235-1742
Steel base - Standard height	To specify, change the 4th digit from a 1 to a 6; Example: M236-1742
Steel base - Low height	To specify, change the 4th digit from a 1 to a 7; Example: M237-1742
Soft casters	To specify, change the 7th digit from a 4 to a 2; Example: M231-1722
Faux Leather upholstery	To specify, change the 2nd digit from a 2 to a 3; Example: M331-1742
Leather upholstery	To specify, change the 2nd digit from a 2 to a 1; Example: M131-1742
CAL 133	To specify, add -F to the end of the product number; Example: M231-2842-F (add \$116.78 list)
Stain repellent	To specify, add -P to the end of the product number; Example: M231-1744-P (add \$38.52 list)

NOTE: CAL 133 is available on all fully upholstered models and chairs with black (TR-F) polypropylene shells backs.

High arc base available in black only.

For available fabrics, refer to surfaces.haworth.com.

Improv Series

Improv H.E. Mid-Back Chair with Flipper Arms



M231-1H42

NOTE:
M241-1G42 offers the best value package of options for this model.

Dimensions

SH: 16" - 21"
(406mm - 533mm)
H: 34" - 42 1/2"
(864mm-1080mm)
D: 23" - 25 1/2"
(584mm - 648mm)
W: 26 1/2"(673mm)
SW: 19.2"(488mm)
SD: 16" - 19"
(406mm - 483mm)
AH: 6.2" - 11.3"
(157mm-287mm)

Two-stage seat height:
.7"(18mm) below
standard
1.9"(48mm) above
standard

Features

- Outer Shells: Polypropylene or upholstered.
- Arms: Standard, upholstered fabric or black vinyl gel arm caps.
- Arm Adjustment Controls: Fingertip activation.
- 3"(76mm) Sliding seat pan.
- Casters: Standard with hard casters; or optional soft casters.
- Standard plastic base or optional high arc, or steel base.
- Mechanism: Swivel with synchronized-tilt.
- Height Adjustment: Pneumatic, pneumatic with two-stage seat height, or pneumatic with low-position seat height option.
- Arm Adjustment: 5"(127mm) height adjustment.
- Arm Pad Rotation: 360°.
- Optional Back-Lock: Lockable in two positions.
- Optional Forward Tilt: Lockable in 3 positions.
- Tilt tension.
- Optional Adjustable Air Lumbar: additional 1 1/2"(38mm) of lumbar support.
- Fire retardant construction is available to comply with California Bulletin #133.
- COM yardage / COL square footage:
Polypropylene shell: 1.50/39
Upholstered shell: 2.25/45
- Available on RUSH with hard casters.

To Order, Specify:

- 1) Product number.
- 2) Fabric surface and color.
(NOTE: For leather upholstery, see page 213.)
- 3) Trim color for shell, arms and base.

* All measurements taken with the BIFMA chair measuring device.

Shells	Arms/Caps	Number	Fabric Grade								Leather Grade A	Leather Grade B
			A	B	C	D	E	F	G	H		
Pneumatic Height Adjustment												
Polypropylene	Standard	M231-1H42	\$1347.20	\$1423.06	\$1502.50	\$1542.22	\$1577.12	\$1646.98	\$1710.78	\$1887.76	\$2010.54	\$2192.24
	Vinyl Gel	M231-1G42	1413.41	1489.27	1568.71	1608.43	1643.33	1713.19	1776.99	1953.97	2076.75	2258.45
	Upholstered	M231-1U42	1460.37	1536.23	1615.67	1655.39	1690.29	1760.15	1823.95	2000.93	2123.71	2305.41
Upholstered	Standard	M231-2H42	\$1472.41	\$1548.27	\$1627.71	\$1667.43	\$1702.33	\$1772.19	\$1835.99	\$2012.97	\$2363.30	\$2545.00
	Vinyl Gel	M231-2G42	1538.62	1614.48	1693.92	1733.64	1768.54	1838.40	1902.20	2079.18	2429.51	2611.21
	Upholstered	M231-2U42	1585.58	1661.44	1740.88	1780.60	1815.50	1885.36	1949.16	2126.14	2476.47	2658.17
Pneumatic Height Adjustment/Back-Lock												
Polypropylene	Standard	M231-1H41	\$1398.98	\$1474.84	\$1554.28	\$1594.00	\$1628.90	\$1698.76	\$1762.56	\$1939.54	\$2062.32	\$2244.02
	Vinyl Gel	M231-1G41	1465.19	1541.05	1620.49	1660.21	1695.11	1764.97	1828.77	2005.75	2128.53	2310.23
	Upholstered	M231-1U41	1512.15	1588.01	1667.45	1707.17	1742.07	1811.93	1875.73	2052.71	2175.49	2357.19
Upholstered	Standard	M231-2H41	\$1524.19	\$1600.05	\$1679.49	\$1719.21	\$1754.11	\$1823.97	\$1887.77	\$2064.75	\$2415.08	\$2596.78
	Vinyl Gel	M231-2G41	1590.40	1666.26	1745.70	1785.42	1820.32	1890.18	1953.98	2130.96	2481.29	2662.99
	Upholstered	M231-2U41	1637.36	1713.22	1792.66	1832.38	1867.28	1937.14	2000.94	2177.92	2528.25	2709.95
Pneumatic Height Adjustment/Forward-Tilt												
Polypropylene	Standard	M241-1H42	\$1397.97	\$1473.62	\$1553.06	\$1592.78	\$1627.68	\$1697.54	\$1761.34	\$1938.32	\$2061.10	\$2242.80
	Vinyl Gel	M241-1G42	1463.97	1539.83	1619.27	1658.99	1693.89	1763.75	1827.55	2004.53	2127.31	2309.01
	Upholstered	M241-1U42	1510.93	1586.79	1666.23	1705.95	1740.85	1810.71	1874.51	2051.49	2174.27	2355.97
Upholstered	Standard	M241-2H42	\$1522.97	\$1598.83	\$1678.27	\$1717.99	\$1752.89	\$1822.75	\$1886.55	\$2063.53	\$2413.86	\$2595.56
	Vinyl Gel	M241-2G42	1589.18	1665.04	1744.48	1784.20	1819.10	1888.96	1952.76	2129.74	2480.07	2661.77
	Upholstered	M241-2U42	1636.14	1712.00	1791.44	1831.16	1866.06	1935.92	1999.72	2176.70	2527.03	2708.73

Improv Series

Improv H.E. Mid-Back Chair with Flipper Arms

Shells	Arms/Caps	Number	Fabric Grade								Leather Grade A	Leather Grade B
			A	B	C	D	E	F	G	H		
Pneumatic Height Adjustment with Adjustable Air Lumbar												
Polypropylene	Standard	M231-1H44	\$1472.41	\$1548.27	\$1627.71	\$1667.43	\$1702.33	\$1772.19	\$1835.99	\$2012.97	\$2135.75	\$2317.45
	Vinyl Gel	M231-1G44	1538.62	1614.48	1693.92	1733.64	1768.54	1838.40	1902.20	2079.18	2201.96	2383.66
	Upholstered	M231-1U44	1585.58	1661.44	1740.88	1780.60	1815.50	1885.36	1949.16	2126.14	2248.92	2430.62
Upholstered	Standard	M231-2H44	\$1597.62	\$1673.48	\$1752.92	\$1792.64	\$1827.54	\$1897.40	\$1961.20	\$2138.18	\$2488.51	\$2670.21
	Vinyl Gel	M231-2G44	1663.83	1739.69	1819.13	1858.85	1893.75	1963.61	2027.41	2204.39	2554.72	2736.42
	Upholstered	M231-2U44	1710.79	1786.65	1866.09	1905.81	1940.71	2010.57	2074.37	2251.35	2601.68	2783.38
Pneumatic Height Adjustment/Back-Lock with Adjustable Air Lumbar												
Polypropylene	Standard	M231-1H43	\$1524.19	\$1600.05	\$1679.49	\$1719.21	\$1754.11	\$1823.97	\$1887.77	\$2064.75	\$2187.53	\$2369.23
	Vinyl Gel	M231-1G43	1590.40	1666.26	1745.70	1785.42	1820.32	1890.18	1953.98	2130.96	2253.74	2435.44
	Upholstered	M231-1U43	1637.36	1713.22	1792.66	1832.38	1867.28	1937.14	2000.94	2177.92	2300.70	2482.40
Upholstered	Standard	M231-2H43	\$1649.40	\$1725.26	\$1804.70	\$1844.42	\$1879.32	\$1949.18	\$2012.98	\$2189.96	\$2540.29	\$2721.99
	Vinyl Gel	M231-2G43	1715.61	1791.47	1870.91	1910.63	1945.53	2015.39	2079.19	2256.17	2606.50	2788.20
	Upholstered	M231-2U43	1762.57	1838.43	1917.87	1957.59	1992.49	2062.35	2126.15	2303.13	2653.46	2835.16
Pneumatic Height Adjustment/Forward-Tilt with Adjustable Air Lumbar												
Polypropylene	Standard	M241-1H44	\$1522.97	\$1598.83	\$1678.27	\$1717.99	\$1752.89	\$1822.75	\$1886.55	\$2063.53	\$2186.31	\$2368.01
	Vinyl Gel	M241-1G44	1589.18	1665.04	1744.48	1784.20	1819.10	1888.96	1952.76	2129.74	2252.52	2434.22
	Upholstered	M241-1U44	1636.14	1712.00	1791.44	1831.16	1866.06	1935.92	1999.72	2176.70	2299.48	2481.18
Upholstered	Standard	M241-2H44	\$1648.18	\$1724.04	\$1803.48	\$1843.20	\$1878.10	\$1947.96	\$2011.76	\$2188.74	\$2539.07	\$2720.77
	Vinyl Gel	M241-2G44	1714.39	1790.25	1869.69	1909.41	1944.31	2014.17	2077.97	2254.95	2605.28	2786.98
	Upholstered	M241-2U44	1761.35	1837.21	1916.65	1956.37	1991.27	2061.13	2124.93	2301.91	2652.24	2833.94

The following options require modification of the product number.

Low-position seat height - Plastic

Two-stage seat height- HAB

High arc base

Steel base - Standard height

Steel base - Low height

Soft casters

Faux Leather upholstery

Leather upholstery

CAL 133

Stain repellent

To specify, change the 4th digit from a 1 to a 4; **Example:** M234-1H42

To specify, change the 4th digit from a 1 to a 3; **Example:** M233-1H42 (add \$99.93 list)

To specify, change the 4th digit from a 1 to a 5; **Example:** M235-1H42

To specify, change the 4th digit from a 1 to a 6; **Example:** M236-1H42

To specify, change the 4th digit from a 1 to a 7; **Example:** M237-1H42

To specify, change the 7th digit from a 4 to a 2; **Example:** M231-1H22

To specify, change the 2nd digit from a 2 to a 3; **Example:** M331-1H42

To specify, change the 2nd digit from a 2 to a 1; **Example:** M131-1H42

To specify, add **-F** to the end of the product number; **Example:** M231-1H42-F (add \$116.78 list)

To specify, add **-P** to the end of the product number; **Example:** M231-1H44-P (add \$38.52 list)

NOTE: CAL 133 is available on all fully upholstered models and chairs with black (TR-F) polypropylene shells backs.

CAL 133 is not available on chairs with vinyl gel arm caps.

High arc base available in black only.

For available fabrics, refer to surfaces.haworth.com.

Improv Series

Improv H.E. Mid-Back Chair with Height and Width Adjustable 3-D Arms



M231-1W42

Dimensions

- SH: 16" - 21"
(406mm - 533mm)
- H: 34" - 42 1/2"
(864mm - 1080mm)
- D: 23" - 25 1/2"
(584mm - 648mm)
- W: 25"(635mm)
- SW: 19.2"(488mm)
- SD: 16" - 19"
(406mm - 483mm)
- AH: 3 3/4" - 7 3/4"
(95mm-197mm)
- AW: 25 1/2" - 29 1/4"
(648mm-743mm)

Two-stage seat height:
.7"(18mm) below
standard
1.9"(48mm) above
standard

Features

- Outer Shells: Polypropylene or upholstered.
- Arms: Molded black vinyl.
- 3"(76mm) Sliding seat pan.
- Casters: Standard with hard casters; or optional soft casters, see below.
- Standard plastic base or optional high arc, or steel base.
- Mechanism: Swivel with synchronized-tilt.
- Height Adjustment: Pneumatic, pneumatic with two-stage seat height, or pneumatic with low-position seat height option.
- Arm Adjustment: 4"(102mm) height adjustment.
- Arm Width Adjustment: 1 1/2"(38mm) each arm in-out adjustment.
- Arm Pad Rotation: 360°.
- Arm Adjustment Controls: Fingertip activation.
- Optional Back-Lock: Lockable in two positions.
- Optional Forward Tilt: Lockable in 3 positions.
- Tilt tension.
- Optional Adjustable Air Lumbar: additional 1 1/2"(38mm) of lumbar support.
- COM yardage / COL square footage:
Polypropylene shell: 1.50/39
Upholstered shell: 2.25/45

To Order, Specify:

- 1) Product number.
- 2) Fabric surface and color.
(NOTE: For leather upholstery, see below.)
- 3) Trim color for shell, arms and base.

* All measurements taken with the BIFMA chair measuring device.

Shells	Arms/Caps	Number	Fabric Grade								Leather Grade A	Leather Grade B
			A	B	C	D	E	F	G	H		
Pneumatic Height Adjustment												
Polypropylene	Molded Black Vinyl	M231-1W42	\$1259.31	\$1335.17	\$1414.61	\$1454.33	\$1489.23	\$1559.09	\$1622.89	\$1799.87	\$1922.65	\$2104.35
Upholstered	Molded Black Vinyl	M231-2W42	1384.52	1460.38	1539.82	1579.54	1614.44	1684.30	1748.10	1925.08	2275.41	2457.11
Pneumatic Height Adjustment/Back-Lock												
Polypropylene	Molded Black Vinyl	M231-1W41	\$1311.09	\$1386.95	\$1466.39	\$1506.11	\$1541.01	\$1610.87	\$1674.67	\$1851.65	\$1974.43	\$2156.13
Upholstered	Molded Black Vinyl	M231-2W41	1436.30	1512.16	1591.60	1631.32	1666.22	1736.08	1799.88	1976.86	2327.19	2508.89
Pneumatic Height Adjustment/Forward-Tilt												
Polypropylene	Molded Black Vinyl	M241-1W42	\$1309.87	\$1385.73	\$1465.17	\$1504.89	\$1539.79	\$1609.65	\$1673.45	\$1850.43	\$1973.21	\$2154.91
Upholstered	Molded Black Vinyl	M241-2W42	1435.08	1510.94	1590.38	1630.10	1665.00	1734.86	1798.66	1975.64	2325.97	2507.67
Pneumatic Height Adjustment with Adjustable Air Lumbar												
Polypropylene	Molded Black Vinyl	M231-1W44	\$1384.52	\$1460.38	\$1539.82	\$1579.54	\$1614.44	\$1684.30	\$1748.10	\$1925.08	\$2047.86	\$2229.56
Upholstered	Molded Black Vinyl	M231-2W44	1509.73	1585.59	1665.03	1704.75	1739.65	1809.51	1873.31	2050.29	2400.62	2582.32
Pneumatic Height Adjustment/Back-Lock with Adjustable Air Lumbar												
Polypropylene	Molded Black Vinyl	M231-1W43	\$1436.30	\$1512.16	\$1591.60	\$1631.32	\$1666.22	\$1736.08	\$1799.88	\$1976.86	\$2099.64	\$2281.34
Upholstered	Molded Black Vinyl	M231-2W43	1561.51	1637.37	1716.81	1756.53	1791.43	1861.29	1925.09	2102.07	2452.40	2634.10
Pneumatic Height Adjustment/Forward-Tilt with Adjustable Air Lumbar												
Polypropylene	Molded Black Vinyl	M241-1W44	\$1435.08	\$1510.94	\$1590.38	\$1630.10	\$1665.00	\$1734.86	\$1798.66	\$1975.64	\$2098.42	\$2280.12
Upholstered	Molded Black Vinyl	M241-2W44	1560.29	1636.15	1715.59	1755.31	1790.21	1860.07	1923.87	2100.85	2451.18	2632.88

The following options require modification of the product number.

- Low-position seat height - Plastic
- Two-stage seat height- HAB
- High arc base
- Steel base - Standard height
- Steel base - Low height
- Soft casters
- Faux Leather upholstery
- Leather upholstery
- CAL 133
- Stain repellent

- To specify, change the 4th digit from a 1 to a 4; **Example:** M234-1W42
- To specify, change the 4th digit from a 1 to a 3; **Example:** M233-1W42 (add \$99.93 list)
- To specify, change the 4th digit from a 1 to a 5; **Example:** M235-1W42
- To specify, change the 4th digit from a 1 to a 6; **Example:** M236-1W42
- To specify, change the 4th digit from a 1 to a 7; **Example:** M237-1W42
- To specify, change the 7th digit from a 4 to a 2; **Example:** M231-1W22
- To specify, change the 2nd digit from a 2 to a 3; **Example:** M331-1W42
- To specify, change the 2nd digit from a 2 to a 1; **Example:** M131-1W42
- To specify, add -F to the end of the product number; **Example:** M231-2W42-F (add \$116.78 list)
- To specify, add -P to the end of the product number; **Example:** M231-1W42-P (add \$38.52 list)

NOTE: CAL 133 is available on all fully upholstered models and chairs with black (TR-F) polypropylene shells backs.

High arc base available in black only.

For available fabrics, refer to surfaces.haworth.com.

Improv Series

Improv H.E. Mid-Back Chair without Arms

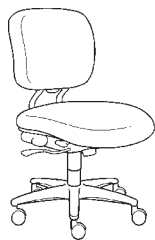

M231-1042

Dimensions

- SH: 16" - 21"
(406mm - 533mm)
- H: 34" - 42 1/2"
(864mm - 1080mm)
- D: 23" - 25 1/2"
(584mm - 648mm)
- W: 26 1/2"(673mm)
- SW: 19.2"(488mm)
- SD: 16" - 19"
(406mm - 483mm)

Two-stage seat height:
.7"(18mm) below standard
1.9"(48mm) above standard

Features

- Outer Shells: Polypropylene or upholstered.
- 3"(76mm) Sliding seat pan.
- Casters: Standard with hard casters; or optional soft casters, see below.
- Standard plastic base or optional high arc, or steel base.
- Mechanism: Swivel with synchronized-tilt.
- Height Adjustment: Pneumatic, pneumatic with two-stage seat height, or pneumatic with low-position seat height option.
- Optional Back-Lock: Lockable in two positions.
- Optional Forward Tilt: Lockable in 3 positions.
- Tilt tension.
- Optional Adjustable Air Lumbar models available: additional 1 1/2"(38mm) of lumbar support.
- Fire retardant construction is available to comply with California Bulletin #133, see below.
- COM yardage / COL square footage:
Polypropylene shell: 1.50/39
Upholstered shell: 2.25/45
- Available on RUSH with hard casters.

To Order, Specify:

- 1) Product number.
- 2) Fabric surface and color.
(NOTE: For leather upholstery, see below.)
- 3) Trim color for shell and base.

* All measurements taken with the BIFMA chair measuring device.

Shells	Number	Fabric Grade								Leather Grade A	Leather Grade B
		A	B	C	D	E	F	G	H		
Pneumatic Height Adjustment											
Polypropylene	M231-1042 ■	\$ 916.19	\$ 992.05	\$1071.49	\$1111.21	\$1146.11	\$1215.97	\$1279.77	\$1456.75	\$1579.53	\$1761.23
Upholstered	M231-2042 ■	1041.40	1117.26	1196.70	1236.42	1271.32	1341.18	1404.98	1581.96	1932.29	2113.99
Pneumatic Height Adjustment/Back-Lock											
Polypropylene	M231-1041 ■	\$ 967.97	\$1043.83	\$1123.27	\$1162.99	\$1197.89	\$1267.75	\$1331.55	\$1508.53	\$1631.31	\$1813.01
Upholstered	M231-2041 ■	1093.18	1169.04	1248.48	1288.20	1323.10	1392.96	1456.76	1633.74	1984.07	2165.77
Pneumatic Height Adjustment/Forward-Tilt											
Polypropylene	M241-1042 ■	\$ 966.75	\$1042.61	\$1122.05	\$1161.77	\$1196.67	\$1266.53	\$1330.33	\$1507.31	\$1630.09	\$1811.79
Upholstered	M241-2042 ■	1091.96	1167.82	1247.26	1286.98	1321.88	1391.74	1455.54	1632.52	1982.85	2164.55
Pneumatic Height Adjustment with Adjustable Lumbar											
Polypropylene	M231-1044	\$1041.40	\$1117.26	\$1196.70	\$1236.42	\$1271.32	\$1341.18	\$1404.98	\$1581.96	\$1704.74	\$1886.44
Upholstered	M231-2044	1166.61	1242.47	1321.91	1361.63	1396.53	1466.39	1530.19	1707.17	2057.50	2239.20
Pneumatic Height Adjustment/Back-Lock with Adjustable Air Lumbar											
Polypropylene	M231-1043	\$1093.18	\$1169.04	\$1248.48	\$1288.20	\$1323.10	\$1392.96	\$1456.76	\$1633.74	\$1756.52	\$1938.22
Upholstered	M231-2043	1218.39	1294.25	1373.69	1413.41	1448.31	1518.17	1581.97	1758.95	2109.28	2290.98
Pneumatic Height Adjustment/Forward-Tilt with Adjustable Air Lumbar											
Polypropylene	M241-1044	\$1091.96	\$1167.82	\$1247.26	\$1286.98	\$1321.88	\$1391.74	\$1455.54	\$1632.52	\$1755.30	\$1937.00
Upholstered	M241-2044	1217.17	1293.03	1372.47	1412.19	1447.09	1516.95	1580.75	1757.73	2108.06	2289.76

The following options require modification of the product number.

- Low-position seat height - Plastic
- Two-stage seat height- HAB
- High arc base
- Steel base - Standard height
- Steel base - Low height
- Soft casters
- Faux Leather upholstery
- Leather upholstery
- CAL 133
- Stain repellent

- To specify, change the 4th digit from a 1 to a 4; **Example:** M234-1042
- To specify, change the 4th digit from a 1 to a 3; **Example:** M233-1042 (add \$99.93 list)
- To specify, change the 4th digit from a 1 to a 5; **Example:** M235-1042
- To specify, change the 4th digit from a 1 to a 6; **Example:** M236-1042
- To specify, change the 4th digit from a 1 to a 7; **Example:** M237-1042
- To specify, change the 7th digit from a 4 to a 2; **Example:** M231-1022
- To specify, change the 2nd digit from a 2 to a 3; **Example:** M331-1042
- To specify, change the 2nd digit from a 2 to a 1; **Example:** M131-1042
- To specify, add -F to the end of the product number; **Example:** M231-2042-F (add \$116.78 list)
- To specify, add -P to the end of the product number; **Example:** M231-1042-P (add \$38.52 list)

NOTE: CAL 133 is available on all fully upholstered models and chairs with black (TR-F) polypropylene shells backs.

High arc base available in black only.

For available fabrics, refer to surfaces.haworth.com.

Improv Series

Improv H.E. Stool with Task Arms



M2E1-1442

Dimensions

- SH: 24" - 32"
(610mm - 813mm)
- H: 42" - 54"
(1067mm - 1372mm)
- D: 23" - 25 1/2"
(584mm - 648mm)
- W: 25"(635mm)
- SW: 19.2"(488mm)
- SD: 18"(459mm)
- AH: 9.6"(244mm)

Features

- Outer Shells: Polypropylene or upholstered.
- Arms: Standard, upholstered fabric or soft black vinyl arm caps.
- Casters: Standard with hard casters; or optional soft casters or glides.
- Mechanism: Swivel with synchronized-tilt.
- Height Adjustment: Pneumatic
- Optional Back-Lock: Lockable in two positions.
- Tilt tension.
- Optional Adjustable Air Lumbar: additional 1 1/2"(38mm) of lumbar support.
- Forward tilt not available on stools.
- Seat pan can be manually adjusted 3"(76mm).
Foot ring adjustment: 6 1/2" - 15"
(165mm - 381mm).
- Foot ring available in chrome only; ring support black only; base cover will match trim color.
- Fire retardant construction is available to comply with California Bulletin #133.
- COM yardage / COL square footage:
Polypropylene shell: 1.75/39
Upholstered shell: 2.25/45

To Order, Specify:

- 1) Product number.
- 2) Fabric surface and color.
(NOTE: For leather upholstery, see page 217.)
- 3) Trim color for shell, arms and base.

* All measurements taken with the BIFMA chair measuring device.

Shells	Arms/Caps	Number	Fabric Grade		C	D	E	F	G	H	Leather Grade A	Leather Grade B
			A	B								
Pneumatic Height Adjustment												
Polypropylene	Standard	M2E1-1442	\$1561.50	\$1637.36	\$1716.80	\$1756.52	\$1791.42	\$1861.28	\$1925.08	\$2102.06	\$2224.84	\$2406.54
	Upholstered	M2E1-1542	1613.28	1689.14	1768.58	1808.30	1843.20	1913.06	1976.86	2153.84	2276.62	2458.32
	Soft Black Vinyl	M2E1-1642	1613.28	1689.14	1768.58	1808.30	1843.20	1913.06	1976.86	2153.84	2276.62	2458.32
Upholstered	Standard	M2E1-2442	\$1686.71	\$1762.57	\$1842.01	\$1881.73	\$1916.63	\$1986.49	\$2050.29	\$2227.27	\$2577.60	\$2759.30
	Upholstered	M2E1-2542	1738.49	1814.35	1893.79	1933.51	1968.41	2038.27	2102.07	2279.05	2629.38	2811.08
	Soft Black Vinyl	M2E1-2642	1738.49	1814.35	1893.79	1933.51	1968.41	2038.27	2102.07	2279.05	2629.38	2811.08
Pneumatic Height Adjustment/Back-Lock												
Polypropylene	Standard	M2E1-1441	\$1613.28	\$1689.14	\$1768.58	\$1808.30	\$1843.20	\$1913.06	\$1976.86	\$2153.84	\$2276.62	\$2458.32
	Upholstered	M2E1-1541	1665.06	1740.92	1820.36	1860.08	1894.98	1964.84	2028.64	2205.62	2328.40	2510.10
	Soft Black Vinyl	M2E1-1641	1665.06	1740.92	1820.36	1860.08	1894.98	1964.84	2028.64	2205.62	2328.40	2510.10
Upholstered	Standard	M2E1-2441	\$1738.49	\$1814.35	\$1893.79	\$1933.51	\$1968.41	\$2038.27	\$2102.07	\$2279.05	\$2629.38	\$2811.08
	Upholstered	M2E1-2541	1790.27	1866.13	1945.57	1985.29	2020.19	2090.05	2153.85	2330.83	2681.16	2862.86
	Soft Black Vinyl	M2E1-2641	1790.27	1866.13	1945.57	1985.29	2020.19	2090.05	2153.85	2330.83	2681.16	2862.86

Improv Series

Improv H.E. Stool with Task Arms

Shells	Arms/Caps	Number	Fabric Grade								Leather Grade A	Leather Grade B
			A	B	C	D	E	F	G	H		
Pneumatic Height Adjustment with Adjustable Air Lumbar												
Polypropylene	Standard	M2E1-1444	\$1686.71	\$1762.57	\$1842.01	\$1881.73	\$1916.63	\$1986.49	\$2050.29	\$2227.27	\$2350.05	\$2531.75
	Upholstered	M2E1-1544	1738.49	1814.35	1893.79	1933.51	1968.41	2038.27	2102.07	2279.05	2401.83	2583.53
	Soft Black Vinyl	M2E1-1644	1738.49	1814.35	1893.79	1933.51	1968.41	2038.27	2102.07	2279.05	2401.83	2583.53
Upholstered	Standard	M2E1-2444	\$1811.92	\$1887.78	\$1967.22	\$2006.94	\$2041.84	\$2111.70	\$2175.50	\$2352.48	\$2702.81	\$2884.51
	Upholstered	M2E1-2544	1863.70	1939.56	2019.00	2058.72	2093.62	2163.48	2227.28	2404.26	2754.59	2936.29
	Soft Black Vinyl	M2E1-2644	1863.70	1939.56	2019.00	2058.72	2093.62	2163.48	2227.28	2404.26	2754.59	2936.29
Pneumatic Height Adjustment/Back-Lock with Adjustable Air Lumbar												
Polypropylene	Standard	M2E1-1443	\$1738.49	\$1814.35	\$1893.79	\$1933.51	\$1968.41	\$2038.27	\$2102.07	\$2279.05	\$2401.83	\$2583.53
	Upholstered	M2E1-1543	1790.27	1866.13	1945.57	1985.29	2020.19	2090.05	2153.85	2330.83	2453.61	2635.31
	Soft Black Vinyl	M2E1-1643	1790.27	1866.13	1945.57	1985.29	2020.19	2090.05	2153.85	2330.83	2453.61	2635.31
Upholstered	Standard	M2E1-2443	\$1863.70	\$1939.56	\$2019.00	\$2058.72	\$2093.62	\$2163.48	\$2227.28	\$2404.26	\$2754.59	\$2936.29
	Upholstered	M2E1-2543	1915.48	1991.34	2070.78	2110.50	2145.40	2215.26	2279.06	2456.04	2806.37	2988.07
	Soft Black Vinyl	M2E1-2643	1915.48	1991.34	2070.78	2110.50	2145.40	2215.26	2279.06	2456.04	2806.37	2988.07

The following options require modification of the product number.

Glides
Soft casters
Faux Leather upholstery
Leather upholstery
CAL 133
Stain repellent

To specify, change the 7th digit from a 4 to a 0; **Example:** M2E1-1402
To specify, change the 7th digit from a 4 to a 2; **Example:** M2E1-1422
To specify, change the 2nd digit from a 2 to a 3; **Example:** M3E1-1442
To specify, change the 2nd digit from a 2 to a 1; **Example:** M1E1-1442
To specify, add -F to the end of the product number; **Example:** M2E1-2542-F (add \$116.78 list)
To specify, add -P to the end of the product number; **Example:** M2E1-1444-P (add \$38.52 list)

NOTE: CAL 133 is available on all fully upholstered models and chairs with black (TR-F) polypropylene shells backs.

For available fabrics, refer to surfaces.haworth.com.

Improv Series

Improv H.E. Stool with Height Adjustable Task Arms



M2E1-1742

Dimensions

SH: 24" - 32"
(610mm - 813mm)
H: 42" - 54"
(1067mm - 1372mm)
D: 23" - 25 1/2"
(584mm - 648mm)
W: 25"(635mm)
SW: 19.2"(488mm)
SD: 18"(458mm)
AH: 6.9" - 10.8"
(175mm - 274mm)

Features

- Outer Shells: Polypropylene or upholstered.
- Arms: Standard, upholstered fabric or soft black vinyl arm caps.
- Arm Adjustment Controls: Fingertip activation.
- Standard with hard casters; or optional soft casters or glides.
- Mechanism: Swivel with synchronized-tilt.
- Height Adjustment: Pneumatic
- Arm Adjustment: 5"(127mm) height adjustment.
- Optional Back-Lock: Lockable in two positions.
- Tilt tension.
- Optional Adjustable Air Lumbar: additional 1 1/2"(38mm) of lumbar support.
- Forward tilt not available on stools.
- Seat pan can be manually adjusted 3"(76mm).
- Foot ring adjustment: 6 1/2" - 15" (165mm - 381mm).
- Foot ring available in chrome only; ring support black only; base cover will match trim color.
- Fire retardant construction is available to comply with California Bulletin #133.
- COM yardage / COL square footage:
Polypropylene shell: 1.75/39
Upholstered shell: 2.25/45

To Order, Specify:

- 1) Product number.
- 2) Fabric surface and color.
(NOTE: For leather upholstery, see page 219.)
- 3) Trim color for shell, arms and base.

* All measurements taken with the BIFMA chair measuring device.

Shells	Arms/Caps	Number	Fabric Grade								Leather Grade A	Leather Grade B
			A	B	C	D	E	F	G	H		
Pneumatic Height Adjustment												
Polypropylene	Standard	M2E1-1742	\$1669.85	\$1745.71	\$1825.15	\$1864.87	\$1899.77	\$1969.63	\$2033.43	\$2210.41	\$2333.19	\$2514.89
	Upholstered	M2E1-1842	1721.63	1797.49	1876.93	1916.65	1951.55	2021.41	2085.21	2262.19	2384.97	2566.67
	Soft Black Vinyl	M2E1-1942	1721.63	1797.49	1876.93	1916.65	1951.55	2021.41	2085.21	2262.19	2384.97	2566.67
Upholstered	Standard	M2E1-2742	\$1795.06	\$1870.92	\$1950.36	\$1990.08	\$2024.98	\$2094.84	\$2158.64	\$2335.62	\$2685.95	\$2867.65
	Upholstered	M2E1-2842	1846.84	1922.70	2002.14	2041.86	2076.76	2146.62	2210.42	2387.40	2737.73	2919.43
	Soft Black Vinyl	M2E1-2942	1846.84	1922.70	2002.14	2041.86	2076.76	2146.62	2210.42	2387.40	2737.73	2919.43
Pneumatic Height Adjustment/Back-Lock												
Polypropylene	Standard	M2E1-1741	\$1721.63	\$1797.49	\$1876.93	\$1916.65	\$1951.55	\$2021.41	\$2085.21	\$2262.19	\$2384.97	\$2566.67
	Upholstered	M2E1-1841	1773.41	1849.27	1928.71	1968.43	2003.33	2073.19	2136.99	2313.97	2436.75	2618.45
	Soft Black Vinyl	M2E1-1941	1773.41	1849.27	1928.71	1968.43	2003.33	2073.19	2136.99	2313.97	2436.75	2618.45
Upholstered	Standard	M2E1-2741	\$1846.84	\$1922.70	\$2002.14	\$2041.86	\$2076.76	\$2146.62	\$2210.42	\$2387.40	\$2737.73	\$2919.43
	Upholstered	M2E1-2841	1898.62	1974.48	2053.92	2093.64	2128.54	2198.40	2262.20	2439.18	2789.51	2971.21
	Soft Black Vinyl	M2E1-2941	1898.62	1974.48	2053.92	2093.64	2128.54	2198.40	2262.20	2439.18	2789.51	2971.21

Improv Series

Improv H.E. Stool with Height Adjustable Task Arms

Shells	Arms/Caps	Number	Fabric Grade								Leather Grade A	Leather Grade B
			A	B	C	D	E	F	G	H		
Pneumatic Height Adjustment with Adjustable Air Lumbar												
Polypropylene	Standard	M2E1-1744	\$1795.06	\$1870.92	\$1950.36	\$1990.08	\$2024.98	\$2094.84	\$2158.64	\$2335.62	\$2458.40	\$2640.10
	Upholstered	M2E1-1844	1846.84	1922.70	2002.14	2041.86	2076.76	2146.62	2210.42	2387.40	2510.18	2691.88
	Soft Black Vinyl	M2E1-1944	1846.84	1922.70	2002.14	2041.86	2076.76	2146.62	2210.42	2387.40	2510.18	2691.88
Upholstered	Standard	M2E1-2744	\$1920.27	\$1996.13	\$2075.57	\$2115.29	\$2150.19	\$2220.05	\$2283.85	\$2460.83	\$2811.16	\$2992.86
	Upholstered	M2E1-2844	1972.05	2047.91	2127.35	2167.07	2201.97	2271.83	2335.63	2512.61	2862.94	3044.64
	Soft Black Vinyl	M2E1-2944	1972.05	2047.91	2127.35	2167.07	2201.97	2271.83	2335.63	2512.61	2862.94	3044.64
Pneumatic Height Adjustment/Back-Lock with Adjustable Air Lumbar												
Polypropylene	Standard	M2E1-1743	\$1846.84	\$1922.70	\$2002.14	\$2041.86	\$2076.76	\$2146.62	\$2210.42	\$2387.40	\$2510.18	\$2691.88
	Upholstered	M2E1-1843	1898.62	1974.48	2053.92	2093.64	2128.54	2198.40	2262.20	2439.18	2561.96	2743.66
	Soft Black Vinyl	M2E1-1943	1898.62	1974.48	2053.92	2093.64	2128.54	2198.40	2262.20	2439.18	2561.96	2743.66
Upholstered	Standard	M2E1-2743	\$1972.05	\$2047.91	\$2127.35	\$2167.07	\$2201.97	\$2271.83	\$2335.63	\$2512.61	\$2862.94	\$3044.64
	Upholstered	M2E1-2843	2023.83	2099.69	2179.13	2218.85	2253.75	2323.61	2387.41	2564.39	2914.72	3096.42
	Soft Black Vinyl	M2E1-2943	2023.83	2099.69	2179.13	2218.85	2253.75	2323.61	2387.41	2564.39	2914.72	3096.42

The following options require modification of the product number.

Glides
Soft casters
Faux Leather upholstery
Leather upholstery
CAL 133
Stain repellent

To specify, change the 7th digit from a 4 to a 0; **Example:** M2E1-1702
To specify, change the 7th digit from a 4 to a 2; **Example:** M2E1-1722
To specify, change the 2nd digit from a 2 to a 3; **Example:** M3E1-1742
To specify, change the 2nd digit from a 2 to a 1; **Example:** M1E1-1742
To specify, add -F to the end of the product number; **Example:** M2E1-2842-F (add \$116.78 list)
To specify, add -P to the end of the product number; **Example:** M2E1-1744-P (add \$38.52 list)

NOTE: CAL 133 is available on all fully upholstered models and chairs with black (TR-F) polypropylene shells backs.

For available fabrics, refer to surfaces.haworth.com.

Improv Series

Improv H.E. Stool with Flipper Arms



M2E1-1H42

Dimensions

SH: 24" - 32"
(610mm - 813mm)
H: 42" - 54"
(1067mm - 1372mm)
D: 23" - 25 1/2"
(584mm - 648mm)
W: 26 1/2"(673mm)
SW: 19.2"(488mm)
SD: 18"(458mm)
AH: 6.2" - 11.3"
(157mm - 282mm)

Features

- Outer Shells: Polypropylene or upholstered.
- Arms: Standard, upholstered fabric or black vinyl arm caps.
- Arm Adjustment Controls: Fingertip activation.
- Arm Adjustment: 5"(127mm) height adjustment, 360° rotation.
- Standard with hard casters; or optional soft casters or glides.
- Mechanism: Swivel with synchronized-tilt.
- Height Adjustment: Pneumatic
- Optional Back-Lock: Lockable in two positions.
- Tilt tension.
- Optional Adjustable Air Lumbar: additional 1 1/2"(38mm) of lumbar support.
- Forward tilt not available on stools.
- Seat pan can be manually adjusted 3"(76mm).
- Foot ring adjustment: 6 1/2" - 15" (165mm - 381mm).
- Foot ring available in chrome only; ring support black only; base cover will match trim color.
- Fire retardant construction is available to comply with California Bulletin #133.
- COM yardage / COL square footage:
Polypropylene shell: 1.75/39
Upholstered shell: 2.25/45

To Order, Specify:

- 1) Product number.
- 2) Fabric surface and color. (NOTE: For leather upholstery, see page 221.)
- 3) Trim color for shell, arms and base.

* All measurements taken with the BIFMA chair measuring device.

Shells	Arms/Caps	Number	Fabric Grade		C	D	E	F	G	H	Leather Grade A	Leather Grade B
			A	B								
Pneumatic Height Adjustment												
Polypropylene	Standard	M2E1-1H42	\$1891.37	\$1967.23	\$2046.67	\$2086.39	\$2121.29	\$2191.15	\$2254.95	\$2431.93	\$2554.71	\$2736.41
	Vinyl Gel	M2E1-1G42	1957.58	2033.44	2112.88	2152.60	2187.50	2257.36	2321.16	2498.14	2620.92	2802.62
	Upholstered	M2E1-1U42	2004.54	2080.40	2159.84	2199.56	2234.46	2304.32	2368.12	2545.10	2667.88	2849.58
Upholstered	Standard	M2E1-2H42	\$2016.58	\$2092.44	\$2171.88	\$2211.60	\$2246.50	\$2316.36	\$2380.16	\$2557.14	\$2907.47	\$3089.17
	Vinyl Gel	M2E1-2G42	2082.79	2158.65	2238.09	2277.81	2312.71	2382.57	2446.37	2623.35	2973.68	3155.38
	Upholstered	M2E1-2U42	2129.75	2205.61	2285.05	2324.77	2359.67	2429.53	2493.33	2670.31	3020.64	3202.34
Pneumatic Height Adjustment/Back-Lock												
Polypropylene	Standard	M2E1-1H41	\$1943.15	\$2019.01	\$2098.45	\$2138.17	\$2173.07	\$2242.93	\$2306.73	\$2483.71	\$2606.49	\$2788.19
	Vinyl Gel	M2E1-1G41	2009.36	2085.22	2164.66	2204.38	2239.28	2309.14	2372.94	2549.92	2672.70	2854.40
	Upholstered	M2E1-1U41	2056.32	2132.18	2211.62	2251.34	2286.24	2356.10	2419.90	2596.88	2719.66	2901.36
Upholstered	Standard	M2E1-2H41	\$2068.36	\$2144.22	\$2223.66	\$2263.38	\$2298.28	\$2368.14	\$2431.94	\$2608.92	\$2959.25	\$3140.95
	Vinyl Gel	M2E1-2G41	2134.57	2210.43	2289.87	2329.59	2364.49	2434.35	2498.15	2675.13	3025.46	3207.16
	Upholstered	M2E1-2U41	2181.53	2257.39	2336.83	2376.55	2411.45	2481.31	2545.11	2722.09	3072.42	3254.12

Improv Series

Improv H.E. Stool with Flipper Arms

Shells	Arms/Caps	Number	Fabric Grade								Leather Grade A	Leather Grade B
			A	B	C	D	E	F	G	H		
Pneumatic Height Adjustment with Adjustable Air Lumbar												
Polypropylene	Standard	M2E1-1H44	\$2016.58	\$2092.44	\$2171.88	\$2211.60	\$2246.50	\$2316.36	\$2380.16	\$2557.14	\$2679.92	\$2861.62
	Vinyl Gel	M2E1-1G44	2082.79	2158.65	2238.09	2277.81	2312.71	2382.57	2446.37	2623.35	2746.13	2927.83
	Upholstered	M2E1-1U44	2129.75	2205.61	2285.05	2324.77	2359.67	2429.53	2493.33	2670.31	2793.09	2974.79
Upholstered	Standard	M2E1-2H44	\$2141.79	\$2217.65	\$2297.09	\$2336.81	\$2371.71	\$2441.57	\$2505.37	\$2682.35	\$3032.68	\$3214.38
	Vinyl Gel	M2E1-2G44	2208.00	2283.86	2363.30	2403.02	2437.92	2507.78	2571.58	2748.56	3098.89	3280.59
	Upholstered	M2E1-2U44	2254.96	2330.82	2410.26	2449.98	2484.88	2554.74	2618.54	2795.52	3145.85	3327.55
Pneumatic Height Adjustment/Back-Lock with Adjustable Air Lumbar												
Polypropylene	Standard	M2E1-1H43	\$2068.36	\$2144.22	\$2223.66	\$2263.38	\$2298.28	\$2368.14	\$2431.94	\$2608.92	\$2731.70	\$2913.40
	Vinyl Gel	M2E1-1G43	2134.57	2210.43	2289.87	2329.59	2364.49	2434.35	2498.15	2675.13	2797.91	2979.61
	Upholstered	M2E1-1U43	2181.53	2257.39	2336.83	2376.55	2411.45	2481.31	2545.11	2722.09	2844.87	3026.57
Upholstered	Standard	M2E1-2H43	\$2193.57	\$2269.43	\$2348.87	\$2388.59	\$2423.49	\$2493.35	\$2557.15	\$2734.13	\$3084.46	\$3266.16
	Vinyl Gel	M2E1-2G43	2259.78	2335.64	2415.08	2454.80	2489.70	2559.56	2623.36	2800.34	3150.67	3332.37
	Upholstered	M2E1-2U43	2306.74	2382.60	2462.04	2501.76	2536.66	2606.52	2670.32	2847.30	3197.63	3379.33

The following options require modification of the product number.

Glides
Soft casters
Faux Leather upholstery
Leather upholstery
CAL 133
Stain repellent

To specify, change the 7th digit from a 4 to a 0; **Example:** M2E1-1H02
To specify, change the 7th digit from a 4 to a 2; **Example:** M2E1-1H22
To specify, change the 2nd digit from a 2 to a 3; **Example:** M3E1-1H42
To specify, change the 2nd digit from a 2 to a 1; **Example:** M1E1-1H42
To specify, add -F to the end of the product number; **Example:** M2E1-2U42-F (add \$116.78 list)
To specify, add -P to the end of the product number; **Example:** M2E1-1H44-P (add \$38.52 list)

NOTE: CAL 133 is available on all fully upholstered models and chairs with black (TR-F) polypropylene shells backs.

For available fabrics, refer to surfaces.haworth.com.

Improv Series

Improv H.E. Stool with Height and Width Adjustable 3-D Arms



M2E1-1W42

Dimensions

SH: 24" - 32"
(610mm - 813mm)
H: 42" - 54"
(1067mm - 1372mm)
D: 23" - 25 1/2"
(584mm - 648mm)
W: 25"(635mm)
SW: 19.2"(488mm)
SD: 18"(458mm)
AH: 3 3/4" - 7 3/4"
(95mm - 197mm)
AW: 25 1/2" - 29 1/4"
(648mm - 743mm)

Features

- Outer Shells: Polypropylene or upholstered.
- Arms: Molded black vinyl arm caps.
- Standard with hard casters; or optional soft casters or glides, see below.
- Mechanism: Swivel with synchronized-tilt.
- Height Adjustment: Pneumatic
- Arm Adjustment: 5"(127mm) height adjustment.
- Arm Width Adjustment: 1 1/2"(38mm) each arm in-out adjustment.
- Arm Pad Rotation: 360°.
- Arm Adjustment Controls: Fingertip activation.
- Optional Back-Lock: Lockable in two positions.
- Tilt tension.
- Optional Adjustable Air Lumbar: additional 1 1/2"(38mm) of lumbar support.
- Forward tilt not available on stools.
- Seat pan can be manually adjusted 3"(76mm).
- Foot ring adjustment: 6 1/2" - 15"
(165mm- 381mm).
- Foot ring available in chrome only; ring support black only; base cover will match trim color.
- COM yardage / COL square footage:
Polypropylene shell: 1.75/39
Upholstered shell: 2.25/45

To Order, Specify:

- 1) Product number.
- 2) Fabric surface and color.
(NOTE: For leather upholstery, see below.)
- 3) Trim color for shell, arms and base.

* All measurements taken with the BIFMA chair measuring device.

Shells	Arms/Caps	Number	Fabric Grade								Leather Grade A	Leather Grade B
			A	B	C	D	E	F	G	H		
Pneumatic Height Adjustment												
Polypropylene	Molded Black Vinyl	M2E1-1W42	\$1803.48	\$1879.34	\$1958.78	\$1998.50	\$2033.40	\$2103.26	\$2167.06	\$2344.04	\$2466.82	\$2648.52
Upholstered	Molded Black Vinyl	M2E1-2W42	1928.69	2004.55	2083.99	2123.71	2158.61	2228.47	2292.27	2469.25	2819.58	3001.28
Pneumatic Height Adjustment/Back-Lock												
Polypropylene	Molded Black Vinyl	M2E1-1W41	\$1855.26	\$1931.12	\$2010.56	\$2050.28	\$2085.18	\$2155.04	\$2218.84	\$2395.82	\$2518.60	\$2700.30
Upholstered	Molded Black Vinyl	M2E1-2W41	1980.47	2056.33	2135.77	2175.49	2210.39	2280.25	2344.05	2521.03	2871.36	3053.06
Pneumatic Height Adjustment with Adjustable Air Lumbar												
Polypropylene	Molded Black Vinyl	M2E1-1W44	\$1928.69	\$2004.55	\$2083.99	\$2123.71	\$2158.61	\$2228.47	\$2292.27	\$2469.25	\$2592.03	\$2773.73
Upholstered	Molded Black Vinyl	M2E1-2W44	2053.90	2129.76	2209.20	2248.92	2283.82	2353.68	2417.48	2594.46	2944.79	3126.49
Pneumatic Height Adjustment/Back-Lock with Adjustable Air Lumbar												
Polypropylene	Molded Black Vinyl	M2E1-1W43	\$1980.47	\$2056.33	\$2135.77	\$2175.49	\$2210.39	\$2280.25	\$2344.05	\$2521.03	\$2643.81	\$2825.51
Upholstered	Molded Black Vinyl	M2E1-2W43	2105.68	2181.54	2260.98	2300.70	2335.60	2405.46	2469.26	2646.24	2996.57	3178.27

The following options require modification of the product number.

Glide

Soft casters

Faux Leather upholstery

Leather upholstery

CAL 133

Stain repellent

To specify, change the 7th digit from a 4 to a 0; **Example:** M2E1-1W02

To specify, change the 7th digit from a 4 to a 2; **Example:** M2E1-1W22

To specify, change the 2nd digit from a 2 to a 3; **Example:** M3E1-1W42

To specify, change the 2nd digit from a 2 to a 1; **Example:** M1E1-1W42

To specify, add -F to the end of the product number; **Example:** M2E1-2W42-F (add \$116.78 list)

To specify, add -P to the end of the product number; **Example:** M2E1-1W42-P (add \$38.52 list)

NOTE: CAL 133 is available on all fully upholstered models and chairs with black (TR-F) polypropylene shells backs.

For available fabrics, refer to surfaces.haworth.com.

Improv Series

Improv H.E. Stool without Arms

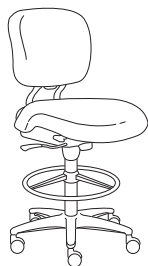

M2E1-1042

Dimensions

SH: 24" - 32"
(610mm - 813mm)
H: 42" - 54"
(1067mm - 1372mm)
D: 23" - 25 1/2"
(584mm - 648mm)
W: 21"(533mm)
SW: 19.2"(488mm)
SD: 18"(457mm)

Features

- Outer Shells: Polypropylene or upholstered.
- Standard with hard casters; or optional soft casters or glides, see below.
- Mechanism: Swivel with synchronized-tilt.
- Height Adjustment: Pneumatic
- Optional Back-Lock: Lockable in two positions.
- Tilt tension.
- Optional Adjustable Air Lumbar: additional 1 1/2"(38mm) of lumbar support.
- Forward tilt not available on stools.
- Seat pan can be manually adjusted 3"(76mm).
- Foot ring adjustment: 6 1/2" - 15"
(165mm - 381mm).
- Foot ring available in chrome only; ring support black only; base cover will match trim color.
- Fire retardant construction is available to comply with California Bulletin #133, see below.
- COM yardage / COL square footage:
Polypropylene shell: 1.75/39
Upholstered shell: 2.25/45

To Order, Specify:

- 1) Product number.
- 2) Fabric surface and color.
(NOTE: For leather upholstery, see below.)
- 3) Trim color for shell, arms and base.

* All measurements taken with the BIFMA chair measuring device.

Shells	Arms/Caps	Number	Fabric Grade		C	D	E	F	G	H	Leather Grade A	Leather Grade B
			A	B								
Pneumatic Height Adjustment												
Polypropylene		M2E1-1042	\$1460.36	\$1536.22	\$1615.66	\$1655.38	\$1690.28	\$1760.14	\$1823.94	\$2000.92	\$2123.70	\$2305.40
Upholstered		M2E1-2042	1585.57	1661.43	1740.87	1780.59	1815.49	1885.35	1949.15	2126.13	2476.46	2658.16
Pneumatic Height Adjustment/Back-Lock												
Polypropylene		M2E1-1041	\$1512.14	\$1588.00	\$1667.44	\$1707.16	\$1742.06	\$1811.92	\$1875.72	\$2052.70	\$2175.48	\$2357.18
Upholstered		M2E1-2041	1637.35	1713.21	1792.65	1832.37	1867.27	1937.13	2000.93	2177.91	2528.24	2709.94
Pneumatic Height Adjustment with Adjustable Air Lumbar												
Polypropylene		M2E1-1044	\$1585.57	\$1661.43	\$1740.87	\$1780.59	\$1815.49	\$1885.35	\$1949.15	\$2126.13	\$2248.91	\$2430.61
Upholstered		M2E1-2044	1710.78	1786.64	1866.08	1905.80	1940.70	2010.56	2074.36	2251.34	2601.67	2783.37
Pneumatic Height Adjustment/Back-Lock with Adjustable Air Lumbar												
Polypropylene		M2E1-1043	\$1637.35	\$1713.21	\$1792.65	\$1832.37	\$1867.27	\$1937.13	\$2000.93	\$2177.91	\$2300.69	\$2482.39
Upholstered		M2E1-2043	1762.56	1838.42	1917.86	1957.58	1992.48	2062.34	2126.14	2303.12	2653.45	2835.15

The following options require modification of the product number.

Glides
Soft casters
Faux Leather upholstery
Leather upholstery
CAL 133
Stain repellent

To specify, change the 7th digit from a 4 to a 0; **Example:** M2E1-1002
To specify, change the 7th digit from a 4 to a 2; **Example:** M2E1-1022
To specify, change the 2nd digit from a 2 to a 3; **Example:** M3E1-1042
To specify, change the 2nd digit from a 2 to a 1; **Example:** M1E1-1042
To specify, add **-F** to the end of the product number; **Example:** M2E1-2042-F (add \$116.78 list)
To specify, add **-P** to the end of the product number; **Example:** M2E1-1042-P (add \$38.52 list)

NOTE: CAL 133 is available on all fully upholstered models and chairs with black (TR-F) polypropylene shells backs.

For available fabrics, refer to surfaces.haworth.com.

Improv Series

Improv S.E. Mesh Back Chair without Arms

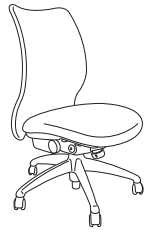

M235-3042



Square

Round

Dimensions*

SH: 16" - 21"
(406mm - 533mm)
H: 37" - 42"
(940mm-1067mm)
D: 25" - 27.5"
(635mm- 699mm)
W: 25"(635mm)
SW: 19.2"(488mm)
SD: 15.5" - 18"
(394mm - 457mm)

Two-stage seat height:
.7"(18mm) below
standard
1.9"(48mm) above
standard

Features

- Back: Soft mesh.
- Seat: Standard upholstered.
- Base: Five-star, high arc plastic base standard; optional steel base available.
- 3"(76mm) sliding seat pan.
- Casters: Standard with hard casters; or optional soft casters, see below.
- Mechanism: Swivel with synchronized-tilt.
- Height Adjustment: Pneumatic or pneumatic with two-stage or low-position seat height, see below.
- Optional Back-Lock: Lockable in 2 positions.
- Optional Lumbar provides 3"(76mm) of vertical and 1"(25mm) of depth adjustment, black trim only.
- Optional Forward Tilt: Lockable in 3 positions.
- Tilt tension.
- COM yardage / COL square footage:
Upholstered seat: 0.75/20
- Available on RUSH.

To Order, Specify:

- 1) Product number.
- 2) Fabric surface and color (seat).
- 3) Fabric surface and color (mesh back).
Black Mesh: WO-01
- 4) Trim color for base.

* All measurements taken with the BIFMA chair measuring device.

Seat	Back	Number	Fabric Grade								Leather Grade A	Leather Grade B
			A	B	C	D	E	F	G	H		
Pneumatic Height Adjustment												
Upholstered	Square Mesh	M235-3042 ■	\$ 984.82	\$1060.67	\$1130.50	\$1179.86	\$1214.77	\$1235.25	\$1288.21	\$1436.30	\$1648.18	\$1829.86
	Round Mesh	M235-4042 ■	984.82	1060.67	1130.50	1179.86	1214.77	1235.25	1288.21	1436.30	1648.18	1829.86
Pneumatic Height Adjustment/Back-Lock												
Upholstered	Square Mesh	M235-3041 ■	\$1036.60	\$1112.45	\$1182.28	\$1231.64	\$1266.55	\$1287.03	\$1339.99	\$1488.08	\$1699.96	\$1881.64
	Round Mesh	M235-4041 ■	1036.60	1112.45	1182.28	1231.64	1266.55	1287.03	1339.99	1488.08	1699.96	1881.64
Pneumatic Height Adjustment/Forward-Tilt												
Upholstered	Square Mesh	M245-3042 ■	\$1036.60	\$1112.45	\$1182.28	\$1231.64	\$1266.55	\$1287.03	\$1339.99	\$1488.08	\$1699.96	\$1881.64
	Round Mesh	M245-4042 ■	1036.60	1112.45	1182.28	1231.64	1266.55	1287.03	1339.99	1488.08	1699.96	1881.64
Pneumatic Height/Lumbar												
Upholstered	Square Mesh	M235-3044	\$1114.85	\$1190.70	\$1260.53	\$1309.89	\$1344.80	\$1365.28	\$1418.24	\$1566.33	\$1778.21	\$1959.89
	Round Mesh	M235-4044	1114.85	1190.70	1260.53	1309.89	1344.80	1365.28	1418.24	1566.33	1778.21	1959.89
Pneumatic Height/Back-Lock/Lumbar												
Upholstered	Square Mesh	M235-3043	\$1166.63	\$1242.48	\$1312.31	\$1361.67	\$1396.58	\$1417.06	\$1470.02	\$1618.11	\$1829.99	\$2011.67
	Round Mesh	M235-4043	1166.63	1242.48	1312.31	1361.67	1396.58	1417.06	1470.02	1618.11	1829.99	2011.67
Pneumatic Height/Forward-Tilt/Lumbar												
Upholstered	Round Mesh	M245-3044	\$1166.63	\$1242.48	\$1312.31	\$1361.67	\$1396.58	\$1417.06	\$1470.02	\$1618.11	\$1829.99	\$2011.67
	Square Mesh	M245-4044	1166.63	1242.48	1312.31	1361.67	1396.58	1417.06	1470.02	1618.11	1829.99	2011.67

The following options require modification of the product number.

- Low-position seat height - Plastic
- Pneumatic seat height - Plastic
- Two-stage seat height- HAB
- Steel base - Standard height
- Steel base - Low height
- Soft casters
- Faux Leather upholstery
- Leather upholstery
- Stain repellent

- To specify, change the 4th digit from a 5 to a 4; **Example:** M234-3042
- To specify, change the 4th digit from a 5 to a 1; **Example:** M231-3042
- To specify, change the 4th digit from a 5 to a 3; **Example:** M233-3042 (add \$102.33 list)
- To specify, change the 4th digit from a 5 to a 6; **Example:** M236-3042
- To specify, change the 4th digit from a 5 to a 7; **Example:** M237-3042
- To specify, change the 7th digit from a 4 to a 2; **Example:** M235-3022
- To specify, change the 2nd digit from a 2 to a 3; **Example:** M335-3042
- To specify, change the 2nd digit from a 2 to a 1; **Example:** M135-3042
- To specify, add -P to the end of the product number; **Example:** M235-3042-P (add \$38.52 list)

NOTE: Stain repellent on upholstered seat only.

For available fabrics, refer to surfaces.haworth.com.

This page intentionally blank

Improv Series

Improv S.E. Mesh-Back Chair with Task Arms



M235-3442

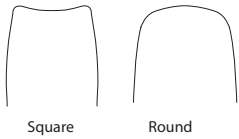

Dimensions*

- SH: 16" - 21"
(406mm - 533mm)
- H: 37" - 42"
(940mm-1067mm)
- D: 25" - 27.5"
(635mm- 699mm)
- W: 25"(635mm)
- SW: 19.2"(488mm)
- SD: 15.5" - 18"
(394mm - 457mm)
- AH: 6.2" - 11.1"
(157mm - 282mm)

Two-stage seat height:
.7"(18mm) below
standard
1.9"(48mm) above
standard

Features

- Back: Soft mesh.
- Seat: Standard upholstered.
- Base: Five-star, high arc plastic base standard; optional steel base available.
- Arms: Standard, upholstered fabric or optional vinyl arm caps.
- 3"(76mm) sliding seat pan.
- Casters: Standard with hard casters; or optional soft casters, see page 227.
- Mechanism: Swivel with synchronized-tilt.
- Height Adjustment: Pneumatic or pneumatic with two-stage or low-position seat height, see page 227.
- Optional Back-Lock: Lockable in 2 positions.
- Optional Forward Tilt: Lockable in 3 positions.
- Tilt tension.
- COM yardage / COL square footage:
Upholstered seat/arms: 0.75/20
- Available on RUSH.

To Order, Specify:

- 1) Product number.
- 2) Fabric surface and color (seat/arm caps).
- 3) Fabric surface and color (mesh back).
Black Mesh: WO-01
- 4) Trim color for base.

* All measurements taken with the BIFMA chair measuring device.

Seat	Back	Arms/Caps	Number	Fabric Grade								Leather Grade A	Leather Grade B
				A	B	C	D	E	F	G	H		
Pneumatic Height Adjustment													
Upholstered	Square Mesh	Standard	M235-3442	\$1084.75	\$1160.60	\$1230.43	\$1279.79	\$1314.70	\$1335.18	\$1388.14	\$1536.23	\$1748.11	\$1929.79
		Upholstered	M235-3542	1136.53	1212.38	1282.21	1331.57	1366.48	1386.96	1439.92	1588.01	1799.89	1981.57
		Soft Black Vinyl	M235-3642	1136.53	1212.38	1282.21	1331.57	1366.48	1386.96	1439.92	1588.01	1799.89	1981.57
Upholstered	Round Mesh	Standard	M235-4442	\$1084.75	\$1160.60	\$1230.43	\$1279.79	\$1314.70	\$1335.18	\$1388.14	\$1536.23	\$1748.11	\$1929.79
		Upholstered	M235-4542	1136.53	1212.38	1282.21	1331.57	1366.48	1386.96	1439.92	1588.01	1799.89	1981.57
		Soft Black Vinyl	M235-4642	1136.53	1212.38	1282.21	1331.57	1366.48	1386.96	1439.92	1588.01	1799.89	1981.57
Pneumatic Height Adjustment/Back-Lock													
Upholstered	Square Mesh	Standard	M235-3441	\$1136.53	\$1212.38	\$1282.21	\$1331.57	\$1366.48	\$1386.96	\$1439.92	\$1588.01	\$1799.89	\$1981.57
		Upholstered	M235-3541	1188.31	1264.16	1333.99	1383.35	1418.26	1438.74	1491.70	1639.79	1851.67	2033.35
		Soft Black Vinyl	M235-3641	1188.31	1264.16	1333.99	1383.35	1418.26	1438.74	1491.70	1639.79	1851.67	2033.35
Upholstered	Round Mesh	Standard	M235-4441	\$1136.53	\$1212.38	\$1282.21	\$1331.57	\$1366.48	\$1386.96	\$1439.92	\$1588.01	\$1799.89	\$1981.57
		Upholstered	M235-4541	1188.31	1264.16	1333.99	1383.35	1418.26	1438.74	1491.70	1639.79	1851.67	2033.35
		Soft Black Vinyl	M235-4641	1188.31	1264.16	1333.99	1383.35	1418.26	1438.74	1491.70	1639.79	1851.67	2033.35
Pneumatic Height Adjustment/Forward-Tilt													
Upholstered	Square Mesh	Standard	M245-3442	\$1136.53	\$1212.38	\$1282.21	\$1331.57	\$1366.48	\$1386.96	\$1439.92	\$1588.01	\$1799.89	\$1981.57
		Upholstered	M245-3542	1188.31	1264.16	1333.99	1383.35	1418.26	1438.74	1491.70	1639.79	1851.67	2033.35
		Soft Black Vinyl	M245-3642	1188.31	1264.16	1333.99	1383.35	1418.26	1438.74	1491.70	1639.79	1851.67	2033.35
Upholstered	Round Mesh	Standard	M245-4442	\$1136.53	\$1212.38	\$1282.21	\$1331.57	\$1366.48	\$1386.96	\$1439.92	\$1588.01	\$1799.89	\$1981.57
		Upholstered	M245-4542	1188.31	1264.16	1333.99	1383.35	1418.26	1438.74	1491.70	1639.79	1851.67	2033.35
		Soft Black Vinyl	M245-4642	1188.31	1264.16	1333.99	1383.35	1418.26	1438.74	1491.70	1639.79	1851.67	2033.35

Improv Series

Improv S.E. Mesh-Back Chair with Task Arms

Seat	Back	Arms/Caps	Number	Fabric Grade								Leather Grade A	Leather Grade B
				A	B	C	D	E	F	G	H		
Pneumatic Height/Lumbar													
Upholstered	Square Mesh	Standard	M235-3444	\$1214.78	\$1290.63	\$1360.46	\$1409.82	\$1444.73	\$1465.21	\$1518.17	\$1666.26	\$1878.14	\$2059.82
		Upholstered	M235-3544	1266.56	1342.41	1412.24	1461.60	1496.51	1516.99	1569.95	1718.04	1929.92	2111.60
		Soft Black Vinyl	M235-3644	1266.56	1342.41	1412.24	1461.60	1496.51	1516.99	1569.95	1718.04	1929.92	2111.60
Upholstered	Round Mesh	Standard	M235-4444	\$1214.78	\$1290.63	\$1360.46	\$1409.82	\$1444.73	\$1465.21	\$1518.17	\$1666.26	\$1878.14	\$2059.82
		Upholstered	M235-4544	1266.56	1342.41	1412.24	1461.60	1496.51	1516.99	1569.95	1718.04	1929.92	2111.60
		Soft Black Vinyl	M235-4644	1266.56	1342.41	1412.24	1461.60	1496.51	1516.99	1569.95	1718.04	1929.92	2111.60
Pneumatic Height/Back-Lock/Lumbar													
Upholstered	Square Mesh	Standard	M235-3443	\$1266.56	\$1342.41	\$1412.24	\$1461.60	\$1496.51	\$1516.99	\$1569.95	\$1718.04	\$1929.92	\$2111.60
		Upholstered	M235-3543	1318.34	1394.19	1464.02	1513.38	1548.29	1568.77	1621.73	1769.82	1981.70	2163.38
		Soft Black Vinyl	M235-3643	1318.34	1394.19	1464.02	1513.38	1548.29	1568.77	1621.73	1769.82	1981.70	2163.38
Upholstered	Round Mesh	Standard	M235-4443	\$1266.56	\$1342.41	\$1412.24	\$1461.60	\$1496.51	\$1516.99	\$1569.95	\$1718.04	\$1929.92	\$2111.60
		Upholstered	M235-4543	1318.34	1394.19	1464.02	1513.38	1548.29	1568.77	1621.73	1769.82	1981.70	2163.38
		Soft Black Vinyl	M235-4643	1318.34	1394.19	1464.02	1513.38	1548.29	1568.77	1621.73	1769.82	1981.70	2163.38
Pneumatic Height/Forward-Tilt/Lumbar													
Upholstered	Square Mesh	Standard	M245-3444	\$1266.56	\$1342.41	\$1412.24	\$1461.60	\$1496.51	\$1516.99	\$1569.95	\$1718.04	\$1929.92	\$2111.60
		Upholstered	M245-3544	1318.34	1394.19	1464.02	1513.38	1548.29	1568.77	1621.73	1769.82	1981.70	2163.38
		Soft Black Vinyl	M245-3644	1318.34	1394.19	1464.02	1513.38	1548.29	1568.77	1621.73	1769.82	1981.70	2163.38
Upholstered	Round Mesh	Standard	M245-4444	\$1266.56	\$1342.41	\$1412.24	\$1461.60	\$1496.51	\$1516.99	\$1569.95	\$1718.04	\$1929.92	\$2111.60
		Upholstered	M245-4544	1318.34	1394.19	1464.02	1513.38	1548.29	1568.77	1621.73	1769.82	1981.70	2163.38
		Soft Black Vinyl	M245-4644	1318.34	1394.19	1464.02	1513.38	1548.29	1568.77	1621.73	1769.82	1981.70	2163.38

The following options require modification of the product number.

Low-position seat height - Plastic	To specify, change the 4th digit from a 5 to a 4; Example: M234-3442
Pneumatic seat height - Plastic	To specify, change the 4th digit from a 5 to a 1; Example: M231-3442
Two-stage seat height- HAB	To specify, change the 4th digit from a 5 to a 3; Example: M233-3442 (add \$102.33 list)
Steel base - Standard height	To specify, change the 4th digit from a 5 to a 6; Example: M236-3442
Steel base - Low height	To specify, change the 4th digit from a 5 to a 7; Example: M237-3442
Soft casters	To specify, change the 7th digit from a 4 to a 2; Example: M235-3422
Faux Leather upholstery	To specify, change the 2nd digit from a 2 to a 3; Example: M335-3442
Leather upholstery	To specify, change the 2nd digit from a 2 to a 1; Example: M135-3442
Stain repellent	To specify, add -P to the end of the product number; Example: M235-3442-P (add \$38.52 list)

NOTE: Stain repellent on upholstered seat only.

For available fabrics, refer to surfaces.haworth.com.

Improv Series

Improv S.E. Mesh-Back Chair with Height Adjustable Task Arms



M235-3742

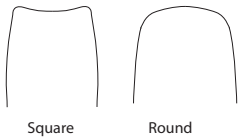

Dimensions*

- SH: 16" - 21"
(406mm - 533mm)
- H: 37" - 42"
(940mm-1067mm)
- D: 25" - 27.5"
(635mm- 699mm)
- W: 25"(635mm)
- SW: 19.2"(488mm)
- SD: 15.5" - 18"
(394mm - 457mm)
- AH: 6.2" - 11.1"
(157mm - 282mm)

Two-stage seat height:
.7"(18mm) below
standard
1.9"(48mm) above
standard

Features

- Back: Soft mesh.
- Seat: Standard upholstered.
- Base: Five-star, high arc plastic base standard; optional steel base available.
- Arms: Standard, upholstered fabric or optional vinyl arm caps.
- Arm Adjustment Controls: Fingertip activation.
- Arm Adjustment: 4"(102mm) height adjustment.
- 3"(76mm) sliding seat pan.
- Casters: Standard with hard casters; or optional soft casters, see page 229.
- Mechanism: Swivel with synchronized-tilt.
- Height Adjustment: Pneumatic or pneumatic with two-stage or low-position seat height, see page 229.
- Optional Back-Lock: Lockable in 2 positions.
- Optional Forward Tilt: Lockable in 3 positions.
- Tilt tension.
- COM yardage / COL square footage:
Upholstered seat: 0.75/20
- Available on RUSH.

To Order, Specify:

- 1) Product number.
- 2) Fabric surface and color (seat/arm caps).
- 3) Fabric surface and color (mesh back).
Black Mesh: WO-01
- 4) Trim color for base.

* All measurements taken with the BIFMA chair measuring device.

Seat	Back	Arms/Caps	Number	Fabric Grade						Leather Grade A	Leather Grade B		
				A	B	C	D	E	F			G	H
Pneumatic Height Adjustment													
Upholstered	Square Mesh	Standard	M235-3742	\$1195.51	\$1271.36	\$1341.19	\$1390.55	\$1425.46	\$1445.94	\$1498.90	\$1646.99	\$1858.87	\$2040.55
		Upholstered	M235-3842	1247.29	1323.14	1392.97	1442.33	1477.24	1497.72	1550.68	1698.77	1910.65	2092.33
		Soft Black Vinyl	M235-3942	1247.29	1323.14	1392.97	1442.33	1477.24	1497.72	1550.68	1698.77	1910.65	2092.33
Upholstered	Round Mesh	Standard	M235-4742	\$1195.51	\$1271.36	\$1341.19	\$1390.55	\$1425.46	\$1445.94	\$1498.90	\$1646.99	\$1858.87	\$2040.55
		Upholstered	M235-4842	1247.29	1323.14	1392.97	1442.33	1477.24	1497.72	1550.68	1698.77	1910.65	2092.33
		Soft Black Vinyl	M235-4942	1247.29	1323.14	1392.97	1442.33	1477.24	1497.72	1550.68	1698.77	1910.65	2092.33
Pneumatic Height Adjustment/Back-Lock													
Upholstered	Square Mesh	Standard	M235-3741	\$1247.29	\$1323.14	\$1392.97	\$1442.33	\$1477.24	\$1497.72	\$1550.68	\$1698.77	\$1910.65	\$2092.33
		Upholstered	M235-3841	1299.07	1374.92	1444.75	1494.11	1529.02	1549.50	1602.46	1750.55	1962.43	2144.11
		Soft Black Vinyl	M235-3941	1299.07	1374.92	1444.75	1494.11	1529.02	1549.50	1602.46	1750.55	1962.43	2144.11
Upholstered	Round Mesh	Standard	M235-4741	\$1247.29	\$1323.14	\$1392.97	\$1442.33	\$1477.24	\$1497.72	\$1550.68	\$1698.77	\$1910.65	\$2092.33
		Upholstered	M235-4841	1299.07	1374.92	1444.75	1494.11	1529.02	1549.50	1602.46	1750.55	1962.43	2144.11
		Soft Black Vinyl	M235-4941	1299.07	1374.92	1444.75	1494.11	1529.02	1549.50	1602.46	1750.55	1962.43	2144.11
Pneumatic Height Adjustment/Forward-Tilt													
Upholstered	Square Mesh	Standard	M245-3742	\$1247.29	\$1323.14	\$1392.97	\$1442.33	\$1477.24	\$1497.72	\$1550.68	\$1698.77	\$1910.65	\$2092.33
		Upholstered	M245-3842	1299.07	1374.92	1444.75	1494.11	1529.02	1549.50	1602.46	1750.55	1962.43	2144.11
		Soft Black Vinyl	M245-3942	1299.07	1374.92	1444.75	1494.11	1529.02	1549.50	1602.46	1750.55	1962.43	2144.11
Upholstered	Round Mesh	Standard	M245-4742	\$1247.29	\$1323.14	\$1392.97	\$1442.33	\$1477.24	\$1497.72	\$1550.68	\$1698.77	\$1910.65	\$2092.33
		Upholstered	M245-4842	1299.07	1374.92	1444.75	1494.11	1529.02	1549.50	1602.46	1750.55	1962.43	2144.11
		Soft Black Vinyl	M245-4942	1299.07	1374.92	1444.75	1494.11	1529.02	1549.50	1602.46	1750.55	1962.43	2144.11

Improv Series

Improv S.E. Mesh-Back Chair with Height Adjustable Task Arms

Seat	Back	Arms/Caps	Number	Fabric Grade								Leather Grade A	Leather Grade B
				A	B	C	D	E	F	G	H		
Pneumatic Height/Lumbar													
Upholstered	Square Mesh	Standard	M235-3744	\$1325.54	\$1401.39	\$1471.22	\$1520.58	\$1555.49	\$1575.97	\$1628.93	\$1777.02	\$1988.90	\$2170.58
		Upholstered	M235-3844	1377.32	1453.17	1523.00	1572.36	1607.27	1627.75	1680.71	1828.80	2040.68	2222.36
		Soft Black Vinyl	M235-3944	1377.32	1453.17	1523.00	1572.36	1607.27	1627.75	1680.71	1828.80	2040.68	2222.36
Upholstered	Round Mesh	Standard	M235-4744	\$1325.54	\$1401.39	\$1471.22	\$1520.58	\$1555.49	\$1575.97	\$1628.93	\$1777.02	\$1988.90	\$2170.58
		Upholstered	M235-4844	1377.32	1453.17	1523.00	1572.36	1607.27	1627.75	1680.71	1828.80	2040.68	2222.36
		Soft Black Vinyl	M235-4944	1377.32	1453.17	1523.00	1572.36	1607.27	1627.75	1680.71	1828.80	2040.68	2222.36
Pneumatic Height/Back-Lock/Lumbar													
Upholstered	Square Mesh	Standard	M235-3743	\$1377.32	\$1453.17	\$1523.00	\$1572.36	\$1607.27	\$1627.75	\$1680.71	\$1828.80	\$2040.68	\$2222.36
		Upholstered	M235-3843	1429.10	1504.95	1574.78	1624.14	1659.05	1679.53	1732.49	1880.58	2092.46	2274.14
		Soft Black Vinyl	M235-3943	1429.10	1504.95	1574.78	1624.14	1659.05	1679.53	1732.49	1880.58	2092.46	2274.14
Upholstered	Round Mesh	Standard	M235-4743	\$1377.32	\$1453.17	\$1523.00	\$1572.36	\$1607.27	\$1627.75	\$1680.71	\$1828.80	\$2040.68	\$2222.36
		Upholstered	M235-4843	1429.10	1504.95	1574.78	1624.14	1659.05	1679.53	1732.49	1880.58	2092.46	2274.14
		Soft Black Vinyl	M235-4943	1429.10	1504.95	1574.78	1624.14	1659.05	1679.53	1732.49	1880.58	2092.46	2274.14
Pneumatic Height/Forward-Tilt/Lumbar													
Upholstered	Square Mesh	Standard	M245-3744	\$1377.32	\$1453.17	\$1523.00	\$1572.36	\$1607.27	\$1627.75	\$1680.71	\$1828.80	\$2040.68	\$2222.36
		Upholstered	M245-3844	1429.10	1504.95	1574.78	1624.14	1659.05	1679.53	1732.49	1880.58	2092.46	2274.14
		Soft Black Vinyl	M245-3944	1429.10	1504.95	1574.78	1624.14	1659.05	1679.53	1732.49	1880.58	2092.46	2274.14
Upholstered	Round Mesh	Standard	M245-4744	\$1377.32	\$1453.17	\$1523.00	\$1572.36	\$1607.27	\$1627.75	\$1680.71	\$1828.80	\$2040.68	\$2222.36
		Upholstered	M245-4844	1429.10	1504.95	1574.78	1624.14	1659.05	1679.53	1732.49	1880.58	2092.46	2274.14
		Soft Black Vinyl	M245-4944	1429.10	1504.95	1574.78	1624.14	1659.05	1679.53	1732.49	1880.58	2092.46	2274.14

The following options require modification of the product number.

Low-position seat height - Plastic	To specify, change the 4th digit from a 5 to a 4; Example: M234-3742
Pneumatic seat height - Plastic	To specify, change the 4th digit from a 5 to a 1; Example: M231-3742
Two-stage seat height - HAB	To specify, change the 4th digit from a 5 to a 3; Example: M233-3742 (add \$102.33 list)
Steel base - Standard height	To specify, change the 4th digit from a 5 to a 6; Example: M236-3742
Steel base - Low height	To specify, change the 4th digit from a 5 to a 7; Example: M237-3742
Soft casters	To specify, change the 7th digit from a 4 to a 2; Example: M235-3722
Faux Leather upholstery	To specify, change the 2nd digit from a 2 to a 3; Example: M335-3742
Leather upholstery	To specify, change the 2nd digit from a 2 to a 1; Example: M135-3742
Stain repellent	To specify, add -P to the end of the product number; Example: M235-3742-P (add \$38.52 list)

NOTE: Stain repellent on upholstered seat only.

For available fabrics, refer to surfaces.haworth.com.

Improv Series

Improv S.E. Mesh-Back Chair with Flipper Arms



M235-3H42

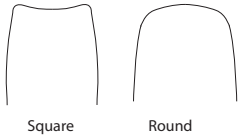

Dimensions*

- SH: 16" - 21"
(406mm - 533mm)
- H: 37" - 42"
(940mm-1067mm)
- D: 25" - 27.5"
(635mm- 699mm)
- W: 25"(635mm)
- SW: 19.2"(488mm)
- SD: 15.5" - 18"
(394mm - 457mm)
- AH: 6.2" - 11.1"
(157mm - 282mm)

Two-stage seat height:
.7"(18mm) below
standard
1.9"(48mm) above
standard

* All measurements
taken with the
BIFMA chair
measuring device.

Features

- Back: Soft mesh.
- Seat: Standard upholstered.
- Base: Five-star, high arc plastic base standard; optional steel base available.
- Arms: Standard, upholstered fabric or optional vinyl arm caps.
- Arm Adjustment Controls: Fingertip activation.
- Arm Adjustment: 5"(127mm) height adjustment.
- Arm Pad Rotation: 350°.
- 3"(76mm) sliding seat pan.
- Casters: Standard with hard casters; or optional soft casters, see page 231.
- Mechanism: Swivel with synchronized-tilt.
- Height Adjustment: Pneumatic or pneumatic with two-stage or low-position seat height, see page 231.
- Optional Back-Lock: Lockable in 2 positions.
- Optional Forward Tilt: Lockable in 3 positions.
- Tilt tension.
- COM yardage / COL square footage:
Upholstered seat: 0.75/20

■ Available on RUSH.

To Order, Specify:

- 1) Product number.
- 2) Fabric surface and color (seat/arm caps).
- 3) Fabric surface and color (mesh back).
Black Mesh: WO-01
- 4) Trim color for base.

Seat	Back	Arms/Caps	Number	Fabric Grade								Leather Grade A	Leather Grade B
				A	B	C	D	E	F	G	H		
Pneumatic Height Adjustment													
Upholstered	Square Mesh	Standard	M235-3H42	\$1414.62	\$1490.47	\$1560.30	\$1609.66	\$1644.57	\$1665.05	\$1718.01	\$1866.10	\$2077.98	\$2259.66
		Vinyl Gel	M235-3G42	1484.46	1560.31	1630.14	1679.50	1714.41	1734.89	1787.85	1935.94	2147.82	2329.50
		Upholstered	M235-3U42	1536.24	1612.09	1681.92	1731.28	1766.19	1786.67	1839.63	1987.72	2199.60	2381.28
Upholstered	Round Mesh	Standard	M235-4H42	\$1414.62	\$1490.47	\$1560.30	\$1609.66	\$1644.57	\$1665.05	\$1718.01	\$1866.10	\$2077.98	\$2259.66
		Vinyl Gel	M235-4G42	1484.46	1560.31	1630.14	1679.50	1714.41	1734.89	1787.85	1935.94	2147.82	2329.50
		Upholstered	M235-4U42	1536.24	1612.09	1681.92	1731.28	1766.19	1786.67	1839.63	1987.72	2199.60	2381.28
Pneumatic Height Adjustment/Back-Lock													
Upholstered	Square Mesh	Standard	M235-3H41	\$1466.40	\$1542.25	\$1612.08	\$1661.44	\$1696.35	\$1716.83	\$1769.79	\$1917.88	\$2129.76	\$2311.44
		Vinyl Gel	M235-3G41	1536.24	1612.09	1681.92	1731.28	1766.19	1786.67	1839.63	1987.72	2199.60	2381.28
		Upholstered	M235-3U41	1588.02	1663.87	1733.70	1783.06	1817.97	1838.45	1891.41	2039.50	2251.38	2433.06
Upholstered	Round Mesh	Standard	M235-4H41	\$1466.40	\$1542.25	\$1612.08	\$1661.44	\$1696.35	\$1716.83	\$1769.79	\$1917.88	\$2129.76	\$2311.44
		Vinyl Gel	M235-4G41	1536.24	1612.09	1681.92	1731.28	1766.19	1786.67	1839.63	1987.72	2199.60	2381.28
		Upholstered	M235-4U41	1588.02	1663.87	1733.70	1783.06	1817.97	1838.45	1891.41	2039.50	2251.38	2433.06
Pneumatic Height Adjustment/Forward-Tilt													
Upholstered	Square Mesh	Standard	M245-3H42	\$1466.40	\$1542.25	\$1612.08	\$1661.44	\$1696.35	\$1716.83	\$1769.79	\$1917.88	\$2129.76	\$2311.44
		Vinyl Gel	M245-3G42	1536.24	1612.09	1681.92	1731.28	1766.19	1786.67	1839.63	1987.72	2199.60	2381.28
		Upholstered	M245-3U42	1588.02	1663.87	1733.70	1783.06	1817.97	1838.45	1891.41	2039.50	2251.38	2433.06
Upholstered	Round Mesh	Standard	M245-4H42	\$1466.40	\$1542.25	\$1612.08	\$1661.44	\$1696.35	\$1716.83	\$1769.79	\$1917.88	\$2129.76	\$2311.44
		Vinyl Gel	M245-4G42	1536.24	1612.09	1681.92	1731.28	1766.19	1786.67	1839.63	1987.72	2199.60	2381.28
		Upholstered	M245-4U42	1588.02	1663.87	1733.70	1783.06	1817.97	1838.45	1891.41	2039.50	2251.38	2433.06

Improv Series

Improv S.E. Mesh-Back Chair with Flipper Arms

Seat	Back	Arms/Caps	Number	Fabric Grade								Leather Grade A	Leather Grade B
				A	B	C	D	E	F	G	H		
Pneumatic Height/Lumbar													
Upholstered	Square Mesh	Standard	M235-3H44	\$1544.65	\$1620.50	\$1690.33	\$1739.69	\$1774.60	\$1795.08	\$1848.04	\$1996.13	\$2208.01	\$2389.69
		Vinyl Gel	M235-3G44	1614.49	1690.34	1760.17	1809.53	1844.44	1864.92	1917.88	2065.97	2277.85	2459.53
		Upholstered	M235-3U44	1666.27	1742.12	1811.95	1861.31	1896.22	1916.70	1969.66	2117.75	2329.63	2511.31
Upholstered	Round Mesh	Standard	M235-4H44	\$1544.65	\$1620.50	\$1690.33	\$1739.69	\$1774.60	\$1795.08	\$1848.04	\$1996.13	\$2208.01	\$2389.69
		Vinyl Gel	M235-4G44	1614.49	1690.34	1760.17	1809.53	1844.44	1864.92	1917.88	2065.97	2277.85	2459.53
		Upholstered	M235-4U44	1666.27	1742.12	1811.95	1861.31	1896.22	1916.70	1969.66	2117.75	2329.63	2511.31
Pneumatic Height/Back-Lock/Lumbar													
Upholstered	Square Mesh	Standard	M235-3H43	\$1596.43	\$1672.28	\$1742.11	\$1791.47	\$1826.38	\$1846.86	\$1899.82	\$2047.91	\$2259.79	\$2441.47
		Vinyl Gel	M235-3G43	1666.27	1742.12	1811.95	1861.31	1896.22	1916.70	1969.66	2117.75	2329.63	2511.31
		Upholstered	M235-3U43	1718.05	1793.90	1863.73	1913.09	1948.00	1968.48	2021.44	2169.53	2381.41	2563.09
Upholstered	Round Mesh	Standard	M235-4H43	\$1596.43	\$1672.28	\$1742.11	\$1791.47	\$1826.38	\$1846.86	\$1899.82	\$2047.91	\$2259.79	\$2441.47
		Vinyl Gel	M235-4G43	1666.27	1742.12	1811.95	1861.31	1896.22	1916.70	1969.66	2117.75	2329.63	2511.31
		Upholstered	M235-4U43	1718.05	1793.90	1863.73	1913.09	1948.00	1968.48	2021.44	2169.53	2381.41	2563.09
Pneumatic Height/Forward-Tilt/Lumbar													
Upholstered	Square Mesh	Standard	M245-3H44	\$1596.43	\$1672.28	\$1742.11	\$1791.47	\$1826.38	\$1846.86	\$1899.82	\$2047.91	\$2259.79	\$2441.47
		Vinyl Gel	M245-3G44	1666.27	1742.12	1811.95	1861.31	1896.22	1916.70	1969.66	2117.75	2329.63	2511.31
		Upholstered	M245-3U44	1718.05	1793.90	1863.73	1913.09	1948.00	1968.48	2021.44	2169.53	2381.41	2563.09
Upholstered	Round Mesh	Standard	M245-4H44	\$1596.43	\$1672.28	\$1742.11	\$1791.47	\$1826.38	\$1846.86	\$1899.82	\$2047.91	\$2259.79	\$2441.47
		Vinyl Gel	M245-4G44	1666.27	1742.12	1811.95	1861.31	1896.22	1916.70	1969.66	2117.75	2329.63	2511.31
		Upholstered	M245-4U44	1718.05	1793.90	1863.73	1913.09	1948.00	1968.48	2021.44	2169.53	2381.41	2563.09

The following options require modification of the product number.

Low-position seat height - Plastic	To specify, change the 4th digit from a 5 to a 4; Example: M234-3H42
Pneumatic seat height - Plastic	To specify, change the 4th digit from a 5 to a 1; Example: M231-3H42
Two-stage seat height - HAB	To specify, change the 4th digit from a 5 to a 3; Example: M233-3H42 (add \$102.33 list)
Steel base - Standard height	To specify, change the 4th digit from a 5 to a 6; Example: M236-3H42
Steel base - Low height	To specify, change the 4th digit from a 5 to a 7; Example: M237-3H42
Soft casters	To specify, change the 7th digit from a 4 to a 2; Example: M235-3H22
Faux Leather upholstery	To specify, change the 2nd digit from a 2 to a 3; Example: M335-3H42
Leather upholstery	To specify, change the 2nd digit from a 2 to a 1; Example: M135-3H42
Stain repellent	To specify, add -P to the end of the product number; Example: M235-3H42-P (add \$38.52 list)

NOTE: Stain repellent on upholstered seat only.

For available fabrics, refer to surfaces.haworth.com.

Improv Series

Improv S.E. Mesh-Back Chair with Height and Width Adjustable 3-D Arms



M235-3W42

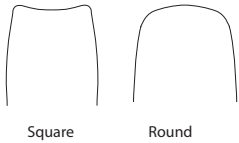

Dimensions*

- SH: 16" - 21"
(406mm - 533mm)
- H: 37" - 42"
(940mm-1067mm)
- D: 25" - 27.5"
(635mm- 699mm)
- W: 25"(635mm)
- SW: 19.2"(488mm)
- SD: 15.5" - 18"
(394mm - 457mm)
- AH: 6.2" - 11.1"
(157mm - 282mm)

Two-stage seat height:
.7"(18mm) below
standard
1.9"(48mm) above
standard

Features

- Back: Soft mesh.
- Seat: Standard upholstered.
- Base: Five-star, high arc plastic base standard; optional steel base available.
- Arms: Molded black vinyl arm caps.
- Arm Adjustment Controls: Fingertip activation.
- Arm Adjust: 4"(102mm) height adjustment.
- Arm Width Adjustment: 1 1/2"(38mm) each arm in-out adjustment.
- 3"(76mm) sliding seat pan.
- Casters: Standard with hard casters; or optional soft casters, see below.
- Mechanism: Swivel with synchronized-tilt.
- Height Adjustment: Pneumatic or pneumatic with two-stage or low-position seat height, see below.
- Optional Back-Lock: Lockable in 2 positions.
- Optional Forward Tilt: Lockable in 3 positions.
- Tilt tension.
- COM yardage / COL square footage:
Upholstered seat: 0.75/20

To Order, Specify:

- 1) Product number.
- 2) Fabric surface and color (seat).
- 3) Fabric surface and color (mesh back).
Black Mesh: WO-01
- 4) Trim color for base.

* All measurements taken with the BIFMA chair measuring device.

Seat	Back	Arms/Caps	Number	Fabric Grade								Leather Grade A	Leather Grade B
				A	B	C	D	E	F	G	H		
Pneumatic Height Adjustment													
Upholstered	Square Mesh	Molded Black Vinyl	M235-3W42	\$1332.76	\$1408.61	\$1478.44	\$1527.80	\$1562.71	\$1583.19	\$1636.15	\$1784.24	\$1996.12	\$2177.80
	Round Mesh	Molded Black Vinyl	M235-4W42	1332.76	1408.61	1478.44	1527.80	1562.71	1583.19	1636.15	1784.24	1996.12	2177.80
Pneumatic Height Adjustment/Back-Lock													
Upholstered	Square Mesh	Molded Black Vinyl	M235-3W41	\$1384.54	\$1460.39	\$1530.22	\$1579.58	\$1614.49	\$1634.97	\$1687.93	\$1836.02	\$2047.90	\$2229.58
	Round Mesh	Molded Black Vinyl	M235-4W41	1384.54	1460.39	1530.22	1579.58	1614.49	1634.97	1687.93	1836.02	2047.90	2229.58
Pneumatic Height Adjustment/Forward-Tilt													
Upholstered	Square Mesh	Molded Black Vinyl	M245-3W42	\$1384.54	\$1460.39	\$1530.22	\$1579.58	\$1614.49	\$1634.97	\$1687.93	\$1836.02	\$2047.90	\$2229.58
	Round Mesh	Molded Black Vinyl	M245-4W42	1384.54	1460.39	1530.22	1579.58	1614.49	1634.97	1687.93	1836.02	2047.90	2229.58
Pneumatic Height/Lumbar													
Upholstered	Square Mesh	Molded Black Vinyl	M235-3W44	\$1462.79	\$1538.64	\$1608.47	\$1657.83	\$1692.74	\$1713.22	\$1766.18	\$1914.27	\$2126.15	\$2307.83
	Round Mesh	Molded Black Vinyl	M235-4W44	1462.79	1538.64	1608.47	1657.83	1692.74	1713.22	1766.18	1914.27	2126.15	2307.83
Pneumatic Height/Back-Lock/Lumbar													
Upholstered	Square Mesh	Molded Black Vinyl	M235-3W43	\$1514.57	\$1590.42	\$1660.25	\$1709.61	\$1744.52	\$1765.00	\$1817.96	\$1966.05	\$2177.93	\$2359.61
	Round Mesh	Molded Black Vinyl	M235-4W43	1514.57	1590.42	1660.25	1709.61	1744.52	1765.00	1817.96	1966.05	2177.93	2359.61
Pneumatic Height/Forward-Tilt/Lumbar													
Upholstered	Square Mesh	Molded Black Vinyl	M245-3W44	\$1514.57	\$1590.42	\$1660.25	\$1709.61	\$1744.52	\$1765.00	\$1817.96	\$1966.05	\$2177.93	\$2359.61
	Round Mesh	Molded Black Vinyl	M245-4W44	1514.57	1590.42	1660.25	1709.61	1744.52	1765.00	1817.96	1966.05	2177.93	2359.61

The following options require modification of the product number.

- Low-position seat height - Plastic
- Pneumatic seat height - Plastic
- Two-stage seat height- HAB
- Steel base - Standard height
- Steel base - Low height
- Soft casters
- Faux Leather upholstery
- Leather upholstery
- Stain repellent

- To specify, change the 4th digit from a 5 to a 4; **Example:** M234-3W42
- To specify, change the 4th digit from a 5 to a 1; **Example:** M231-3W42
- To specify, change the 4th digit from a 5 to a 3; **Example:** M233-3W42 (add \$102.33 list)
- To specify, change the 4th digit from a 5 to a 6; **Example:** M236-3W42
- To specify, change the 4th digit from a 5 to a 7; **Example:** M237-3W42
- To specify, change the 7th digit from a 4 to a 2; **Example:** M235-3W22
- To specify, change the 2nd digit from a 2 to a 3; **Example:** M335-3W42
- To specify, change the 2nd digit from a 2 to a 1; **Example:** M135-3W42
- To specify, add -P to the end of the product number; **Example:** M235-3W42-P (add \$38.52 list)

NOTE: Stain repellent on upholstered seat only.

For available fabrics, refer to surfaces.haworth.com.

Improv Tag

General Specifications

Features and Options

All Improv Tag chairs feature:

- Molded-polyfoam contoured seat
- Mesh "form-fit" back
- Five-star plastic high arc base with black casters
- Hard dual-wheel casters (standard) or soft dual-wheel casters (optional)
- Pneumatic seat height adjustment
- Task arms, height-adjustable task arms, 3-D arms or armless
- Tilt tension
- Optional low-position seat height adjustment with steel base
- Optional back-lock
 - Back and seat recline at a 2:1 ration with no front seat rise
 - Back is lockable in two positions within tilt range
 - Back tilts backward 20 degrees from the upright position
 - Seat pan moves downward 10 degrees from the initial position
 - Back-lock and forward-tilt options cannot be specified on the same chair
- Optional forward-tilt
 - Both chair back and seat pan are lockable in three forward positions (1, 3 and 5 degrees)
 - Forward-tilt and back-lock options cannot be specified on the same chair
- Optional height and depth adjustable lumbar

COM & COL General Information

To order a COM fabric (Customer's Own Material), contact the Haworth Inquiry Center (1.800.426.8562), your local Haworth dealer, or go to haworth.com/surfaces > COM Library to find out if the COM you have selected has already been tested and approved. The surface collection site also has information on the Haworth+ alliance program with Carnegie, Luna Textiles, and Maharam as well as our industry-leading Pre-Approved COM program.

COM fabrics are placed into Grades based on the cost per linear yard. If a fabric's cost exceeds the range of our highest Grade it will be noted as Non-Graded. The product will be priced at Grade A; the COM fabric costs will appear as a separate line item. The fabric charge will be Haworth's purchase cost plus a 4% administrative fee (based on the cost of the fabric). Yardage calculations will include any applicable fabric repeat.

COM Leather products will be priced at a leather Grade A; COL costs will appear as a separate line item. The leather costs will be Haworth's purchase cost plus a 4% administrative fee (based on the cost of the leather).

General Guidelines for Product Specification

The alpha-numeric logic for an Improv Tag chair complete with fabric and finish codes is shown below:

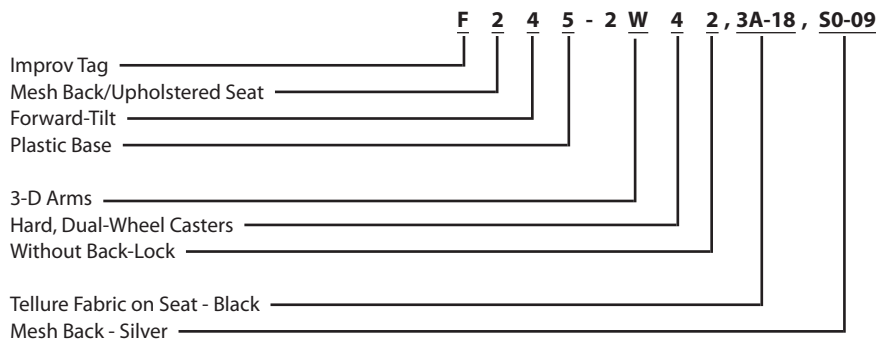

Improv Tag

Mesh Back without Arms



F235-2042

Dimensions

SH: 16" - 21"
(406mm-533mm)
H: 37" - 42"
(940mm-1067mm)
D: 25" - 27 1/2"
(635mm-699mm)
W: 25"(635mm)
SW: 20"(508mm)
SD: 15 1/2" - 18"
(394mm-457mm)

Features

- Soft mesh back.
- Upholstered seat.
- Pneumatic height adjustment.
- Sliding seat.
- Tilt tension.
- Standard with hard casters; optional soft casters available.
- Standard with five-star high arc plastic base; optional steel base available.
- Optional back-lock.
- Optional lumbar adjustment.
- Optional forward-tilt.
- Optional low-position seat height/steel base.
- COM yardage / COL square footage:
Upholstered Seat: 0.75/20.0
- Available on RUSH.

To Order, Specify:

- 1) Product number.
- 2) Seat fabric.
- 3) Mesh back fabric.
TR-F Black trim (no need to specify).

Description	Number	Fabric Grade								Leather Grade A	Leather Grade B
		A	B	C	D	E	F	G	H		
Pneumatic Height	F235-2042 ■	\$1065.48	\$1141.33	\$1211.16	\$1260.52	\$1295.43	\$1315.91	\$1368.87	\$1516.96	\$1728.84	\$1910.52
Pneumatic Height/Back-Lock	F235-2041 ■	1120.86	1196.71	1266.54	1315.90	1350.81	1371.29	1424.25	1572.34	1784.22	1965.90
Pneumatic Height/Back-Lock/Lumbar	F235-2043	1248.48	1324.33	1394.16	1443.52	1478.43	1498.91	1551.87	1699.96	1911.84	2093.52
Pneumatic Height/Lumbar	F235-2044	1193.10	1268.95	1338.78	1388.14	1423.05	1443.53	1496.49	1644.58	1856.46	2038.14
Pneumatic Height/Forward-Tilt	F245-2042 ■	1119.66	1195.51	1265.34	1314.70	1349.61	1370.09	1423.05	1571.14	1783.02	1964.70
Pneumatic Height/Forward-Tilt/Lumbar	F245-2044	1247.28	1323.13	1392.96	1442.32	1477.23	1497.71	1550.67	1698.76	1910.64	2092.32

The following options require modification of the product number.

Low position seat height/plastic base
Steel base - Low height
Soft casters
Faux Leather seat
Leather seat
CAL 133
Stain repellent

To specify, change the 4th digit from a 5 to a 4; **Example:** F234-2042

To specify, change the 4th digit from a 5 to a 7; **Example:** F237-2042

To specify, change the 7th digit from a 4 to a 2; **Example:** F235-2022

To specify, change the 2nd digit from a 2 to a 3; **Example:** F335-2042

To specify, change the 2nd digit from a 2 to a 1; **Example:** F135-2042

To specify, add **-F** to the end of the product number; **Example:** F235-2042-F (add \$116.78 list)

To specify, add **-P** to the end of the product number; **Example:** F235-2042-P (add \$38.52 list)

NOTE: Stain repellent on upholstered seat only.

For available fabrics, refer to surfaces.haworth.com.

Improv Tag

Mesh Back with Fixed-Height Task Arms



F235-2442

Dimensions

- SH: 16" - 21"
(406mm-533mm)
- H: 37" - 42"
(940mm-1067mm)
- D: 25" - 27 1/2"
(635mm-699mm)
- W: 25"(635mm)
- SW: 20"(508mm)
- SD: 15 1/2" - 18"
(394mm-457mm)

Features

- Soft mesh back.
- Upholstered seat.
- Pneumatic height adjustment.
- Fixed-height task arms.
- Sliding seat.
- Tilt tension.
- Standard with hard casters; optional soft casters available.
- Standard with five-star high arc plastic base; optional steel base available.
- Optional back-lock.
- Optional lumbar adjustment.
- Optional forward-tilt.
- Optional low position seat height/steel base.
- COM yardage / COL square footage:
Upholstered Seat: 0.75/20.0
- Available on RUSH.

To Order, Specify:

- 1) Product number.
- 2) Seat fabric.
- 3) Mesh back fabric.
TR-F Black trim (no need to specify).

Description	Arm Cap	Number	Fabric Grade		C	D	E	F	G	H	Leather Grade A	Leather Grade B
			A	B								
Pneumatic Height												
Standard		F235-2442 ■	\$1172.63	\$1248.48	\$1318.31	\$1367.67	\$1402.58	\$1423.06	\$1476.02	\$1624.11	\$1835.99	\$2017.67
Upholstered		F235-2542 ■	1230.42	1306.27	1376.10	1425.46	1460.37	1480.85	1533.81	1681.90	1893.78	2075.46
Vinyl		F235-2642 ■	1230.42	1306.27	1376.10	1425.46	1460.37	1480.85	1533.81	1681.90	1893.78	2075.46
Pneumatic Height/Back-Lock												
Standard		F235-2441 ■	\$1228.01	\$1303.86	\$1373.69	\$1423.05	\$1457.96	\$1478.44	\$1531.40	\$1679.49	\$1891.37	\$2073.05
Upholstered		F235-2541 ■	1285.80	1361.65	1431.48	1480.84	1515.75	1536.23	1589.19	1737.28	1949.16	2130.84
Vinyl		F235-2641 ■	1285.80	1361.65	1431.48	1480.84	1515.75	1536.23	1589.19	1737.28	1949.16	2130.84
Pneumatic Height/Back-Lock/Lumbar												
Standard		F235-2443	\$1355.63	\$1431.48	\$1501.31	\$1550.67	\$1585.58	\$1606.06	\$1659.02	\$1807.11	\$2018.99	\$2200.67
Upholstered		F235-2543	1413.42	1489.27	1559.10	1608.46	1643.37	1663.85	1716.81	1864.90	2076.78	2258.46
Vinyl		F235-2643	1413.42	1489.27	1559.10	1608.46	1643.37	1663.85	1716.81	1864.90	2076.78	2258.46
Pneumatic Height/Lumbar												
Standard		F235-2444	\$1300.25	\$1376.10	\$1445.93	\$1495.29	\$1530.20	\$1550.68	\$1603.64	\$1751.73	\$1963.61	\$2145.29
Upholstered		F235-2544	1358.04	1433.89	1503.72	1553.08	1587.99	1608.47	1661.43	1809.52	2021.40	2203.08
Vinyl		F235-2644	1358.04	1433.89	1503.72	1553.08	1587.99	1608.47	1661.43	1809.52	2021.40	2203.08
Pneumatic Height/Forward-Tilt												
Standard		F245-2442 ■	\$1226.81	\$1302.66	\$1372.49	\$1421.85	\$1456.76	\$1477.24	\$1530.20	\$1678.29	\$1890.17	\$2071.85
Upholstered		F245-2542 ■	1284.60	1360.45	1430.28	1479.64	1514.55	1535.03	1587.99	1736.08	1947.96	2129.64
Vinyl		F245-2642 ■	1284.60	1360.45	1430.28	1479.64	1514.55	1535.03	1587.99	1736.08	1947.96	2129.64
Pneumatic Height/Forward-Tilt/Lumbar												
Standard		F245-2444	\$1354.43	\$1430.28	\$1500.11	\$1549.47	\$1584.38	\$1604.86	\$1657.82	\$1805.91	\$2017.79	\$2199.47
Upholstered		F245-2544	1412.22	1488.07	1557.90	1607.26	1642.17	1662.65	1715.61	1863.70	2075.58	2257.26
Vinyl		F245-2644	1412.22	1488.07	1557.90	1607.26	1642.17	1662.65	1715.61	1863.70	2075.58	2257.26

The following options require modification of the product number.

- Low position seat height/plastic base To specify, change the 4th digit from a 5 to a 4; **Example:** F234-2543
- Steel base - Low height To specify, change the 4th digit from a 5 to a 7; **Example:** F237-2543
- Soft casters To specify, change the 7th digit from a 4 to a 2; **Example:** F235-2522
- Faux Leather seat To specify, change the 2nd digit from a 2 to a 3; **Example:** F345-2644
- Leather seat To specify, change the 2nd digit from a 2 to a 1; **Example:** F135-2544
- CAL 133 To specify, add -F to the end of the product number; **Example:** F235-2442-F (add \$116.78 list)
- Stain repellent To specify, add -P to the end of the product number; **Example:** F235-2442-P (add \$38.52 list)

NOTE: Stain repellent on upholstered seat only.

For available fabrics, refer to surfaces.haworth.com.

Improv Tag

Mesh Back with Height-Adjustable Task Arms



F235-2742

Dimensions

- SH: 16" - 21"
(406mm-533mm)
H: 37" - 42"
(940mm-1067mm)
D: 25" - 27 1/2"
(635mm-699mm)
W: 25"(635mm)
SW: 20"(508mm)
SD: 15 1/2" - 18"
(394mm-457mm)

Features

- Soft mesh back.
- Upholstered seat.
- Pneumatic height adjustment.
- Height-adjustable task arms.
- Sliding seat.
- Tilt tension.
- Standard with hard casters; optional soft casters available.
- Standard with five-star high arc plastic base; optional steel base available.
- Optional back-lock.
- Optional lumbar adjustment.
- Optional forward-tilt.
- Optional low position seat height/steel base.
- COM yardage / COL square footage:
Upholstered Seat: 0.75/20.0
- Available on RUSH.

To Order, Specify:

- 1) Product number.
- 2) Seat fabric.
- 3) Mesh back fabric.
TR-F Black trim (no need to specify).

Description	Arm Cap	Number	Fabric Grade		C	D	E	F	G	H	Leather Grade A	Leather Grade B
			A	B								
Pneumatic Height												
Standard		F235-2742	\$1291.83	\$1367.68	\$1437.51	\$1486.87	\$1521.78	\$1542.26	\$1595.22	\$1743.31	\$1955.19	\$2136.87
Upholstered		F235-2842	1349.62	1425.47	1495.30	1544.66	1579.57	1600.05	1653.01	1801.10	2012.98	2194.66
Vinyl		F235-2942	1349.62	1425.47	1495.30	1544.66	1579.57	1600.05	1653.01	1801.10	2012.98	2194.66
Pneumatic Height/Back-Lock												
Standard		F235-2741	\$1347.21	\$1423.06	\$1492.89	\$1542.25	\$1577.16	\$1597.64	\$1650.60	\$1798.69	\$2010.57	\$2192.25
Upholstered		F235-2841	1405.00	1480.85	1550.68	1600.04	1634.95	1655.43	1708.39	1856.48	2068.36	2250.04
Vinyl		F235-2941	1405.00	1480.85	1550.68	1600.04	1634.95	1655.43	1708.39	1856.48	2068.36	2250.04
Pneumatic Height/Back-Lock/Lumbar												
Standard		F235-2743	\$1474.83	\$1550.68	\$1620.51	\$1669.87	\$1704.78	\$1725.26	\$1778.22	\$1926.31	\$2138.19	\$2319.87
Upholstered		F235-2843	1532.62	1608.47	1678.30	1727.66	1762.57	1783.05	1836.01	1984.10	2195.98	2377.66
Vinyl		F235-2943	1532.62	1608.47	1678.30	1727.66	1762.57	1783.05	1836.01	1984.10	2195.98	2377.66
Pneumatic Height/Lumbar												
Standard		F235-2744	\$1419.45	\$1495.30	\$1565.13	\$1614.49	\$1649.40	\$1669.88	\$1722.84	\$1870.93	\$2082.81	\$2264.49
Upholstered		F235-2844	1477.24	1553.09	1622.92	1672.28	1707.19	1727.67	1780.63	1928.72	2140.60	2322.28
Vinyl		F235-2944	1477.24	1553.09	1622.92	1672.28	1707.19	1727.67	1780.63	1928.72	2140.60	2322.28
Pneumatic Height/Forward-Tilt												
Standard		F245-2742	\$1346.01	\$1421.86	\$1491.69	\$1541.05	\$1575.96	\$1596.44	\$1649.40	\$1797.49	\$2009.37	\$2191.05
Upholstered		F245-2842	1403.80	1479.65	1549.48	1598.84	1633.75	1654.23	1707.19	1855.28	2067.16	2248.84
Vinyl		F245-2942	1403.80	1479.65	1549.48	1598.84	1633.75	1654.23	1707.19	1855.28	2067.16	2248.84
Pneumatic Height/Forward-Tilt/Lumbar												
Standard		F245-2744	\$1473.63	\$1549.48	\$1619.31	\$1668.67	\$1703.58	\$1724.06	\$1777.02	\$1925.11	\$2136.99	\$2318.67
Upholstered		F245-2844	1531.42	1607.27	1677.10	1726.46	1761.37	1781.85	1834.81	1982.90	2194.78	2376.46
Vinyl		F245-2944	1531.42	1607.27	1677.10	1726.46	1761.37	1781.85	1834.81	1982.90	2194.78	2376.46

The following options require modification of the product number.

- | | |
|---------------------------------------|--|
| Low position seat height/plastic base | To specify, change the 4th digit from a 5 to a 4; Example: F234-2843 |
| Steel base - Low height | To specify, change the 4th digit from a 5 to a 7; Example: F237-2843 |
| Soft casters | To specify, change the 7th digit from a 4 to a 2; Example: F235-2822 |
| Faux Leather seat | To specify, change the 2nd digit from a 2 to a 3; Example: F345-2944 |
| Leather seat | To specify, change the 2nd digit from a 2 to a 1; Example: F135-2844 |
| CAL 133 | To specify, add -F to the end of the product number; Example: F235-2743-F (add \$116.78 list) |
| Stain repellent | To specify, add -P to the end of the product number; Example: F235-2742-P (add \$38.52 list) |

NOTE: Stain repellent on upholstered seat only.

For available fabrics, refer to surfaces.haworth.com.

Improv Tag

Mesh Back with Height- and Width-Adjustable 3-D Arms



F235-2W42

Dimensions

SH: 16" - 21"
(406mm-533mm)
H: 37" - 42"
(940mm-1067mm)
D: 25" - 27 1/2"
(635mm-699mm)
W: 25"(635mm)
SW: 20"(508mm)
SD: 15 1/2" - 18"
(394mm-457mm)

Features

- Soft mesh back.
- Upholstered seat.
- Pneumatic height adjustment.
- Height- and width-adjustable 3-D arms with molded black vinyl arm caps.
- Sliding seat.
- Tilt tension.
- Standard with hard casters; optional soft casters available.
- Standard with five-star high arc plastic base; optional steel base available.
- Optional back-lock.
- Optional lumbar adjustment.
- Optional forward-tilt.
- Optional low position seat height/steel base.
- COM yardage / COL square footage:
Upholstered Seat: 0.75/20.0

To Order, Specify:

- 1) Product number.
- 2) Seat fabric.
- 3) Mesh back fabric.
TR-F Black trim (no need to specify).

Description	Number	Fabric Grade								Leather Grade A	Leather Grade B
		A	B	C	D	E	F	G	H		
Pneumatic Height	F235-2W42	\$1438.70	\$1514.55	\$1584.38	\$1633.74	\$1668.65	\$1689.13	\$1742.09	\$1890.18	\$2102.06	\$2283.74
Pneumatic Height/Back-Lock	F235-2W41	1494.08	1569.93	1639.76	1689.12	1724.03	1744.51	1797.47	1945.56	2157.44	2339.12
Pneumatic Height/Back-Lock/Lumbar	F235-2W43	1621.70	1697.55	1767.38	1816.74	1851.65	1872.13	1925.09	2073.18	2285.06	2466.74
Pneumatic Height/Lumbar	F235-2W44	1566.32	1642.17	1712.00	1761.36	1796.27	1816.75	1869.71	2017.80	2229.68	2411.36
Pneumatic Height/Forward-Tilt	F245-2W42	1492.88	1568.73	1638.56	1687.92	1722.83	1743.31	1796.27	1944.36	2156.24	2337.92
Pneumatic Height/Forward-Tilt/Lumbar	F245-2W44	1620.50	1696.35	1766.18	1815.54	1850.45	1870.93	1923.89	2071.98	2283.86	2465.54

The following options require modification of the product number.

Low position seat height/plastic base	To specify, change the 4th digit from a 5 to a 4; Example: F234-2W42
Steel base - Low height	To specify, change the 4th digit from a 5 to a 7; Example: F237-2W42
Soft casters	To specify, change the 7th digit from a 4 to a 2; Example: F235-2W22
Faux Leather seat	To specify, change the 2nd digit from a 2 to a 3; Example: F345-2W42
Leather seat	To specify, change the 2nd digit from a 2 to a 1; Example: F135-2W42
CAL 133	To specify, add -F to the end of the product number; Example: F235-2W43-F (add \$116.78 list)
Stain repellent	To specify, add -P to the end of the product number; Example: F235-2W42-P (add \$38.52 list)

NOTE: Stain repellent on upholstered seat only.

For available fabrics, refer to surfaces.haworth.com.

Improv Series

Leg-Base Stacking Chairs

With Arms

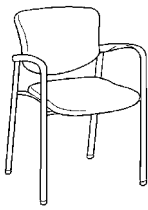

M600-2110

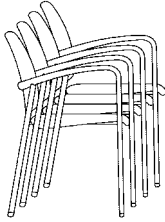

Dimensions

- H: 32"(813mm)
- W: 22"(559mm)
- D: 21 1/2"(546mm)
- SH: 18"(457mm)
- SD: 18"(457mm)
- SW: 19"(483mm)
- AH: 25 3/4"(654mm)

Features

- Optional: Full wood back.
- Optional: Legs with casters.
- Polypropylene or upholstered outer back shell.
- With glides, stacks 6-high (44"(1118mm)) on floor or 10-high (62"(1575mm)) on stacking dolly.
- With casters, stacks 5-high (42"(1067mm)) on floor or 6-high (50"(1270mm)) on dolly.
- Arms and molded floor glides match frame color except when ordering Metallic trim; molded components are available in black or smoke and must be specified.
- Non-ganging or ganging options. NOTE: An arm chair adjacent to a tablet arm cannot be ganged together.
- Optional book rack, see page 245.
- Fire retardant construction is available to comply with California Bulletin #133, see below.
- COM yardage/COL square footage:
Polypropylene back shell/upholstered seat: 0.75/15
Upholstered shell/seat: 1.25/28
Upholstered seat (wood back): 0.5

■ Available on RUSH.

To Order, Specify:

- 1) Product number.
- 2) Fabric surface and color.
- 3) Frame/arms trim color.
- 4) Arm and glide trim color for metallic frame black or smoke option only.

To Order Chair with Wood Back, Specify:

- 1) Product number.
- 2) Fabric surface and color (seat).
- 3) Frame trim color.
- 4) Arm and glide trim color for metallic frame black or smoke option only.
- 5) Wood back finish color.

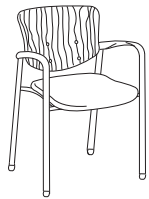

M600-2310

* All measurements taken with the BIFMA chair measuring device.

Outer/Inner Back Shell	Ganging	Number	Fabric Grade								Leather Grade A	Leather Grade B
			A	B	C	D	E	F	G	H		
Polypropylene/Upholstered	Non-ganging	M600-2110 ■	\$476.80	\$510.26	\$523.86	\$554.82	\$583.32	\$630.36	\$663.78	\$755.42	\$ 804.96	\$ 967.54
	Ganging	M600-2110-5	533.76	567.22	580.82	611.78	640.28	687.32	720.74	812.38	861.92	1024.50
Upholstered/Upholstered	Non-ganging	M600-2210 ■	\$543.66	\$588.27	\$617.97	\$661.32	\$707.14	\$754.19	\$792.56	\$908.98	\$ 991.95	\$1246.16
	Ganging	M600-2210-5	600.62	645.23	674.93	718.28	764.10	811.15	849.52	965.94	1048.91	1303.12
Wood Back	Non-ganging	M600-2310 ■	\$595.68	\$629.14	\$642.74	\$673.70	\$702.20	\$749.24	\$782.66	\$874.30	\$ 923.84	\$1086.42
	Ganging	M600-2310-5	652.64	686.10	699.70	730.66	759.16	806.20	839.62	931.26	980.80	1143.38

The following options require modification of the product number.

- Metallic trim color
- Hard casters
- Soft casters
- CAL 133
- Stain repellent
- Moisture barrier

To specify, add **-M** after the 8th digit; **Example:** M600-2110-**M**

To specify, change the 8th digit from a 0 to a 2; **Example:** M600-2112 (add **\$63.15** list)

To specify, change the 8th digit from a 0 to a 4; **Example:** M600-2114 (add **\$63.15** list)

To specify, add **-F** to the end of the product number; **Example:** M600-2210-**F** (add **\$63.15** list)

To specify, add **-P** to the end of the product number; **Example:** M600-2110-**P** (add **\$39.63** list)

To specify, add **-D** to the end of the product number; **Example:** M600-2110-**D** (add **\$52.00** list)

NOTE: CAL 133 is available on fully upholstered outer back and wood back chair models only.

Caster option chairs also available on RUSH.

Casters should not be used on thick pile carpet applications.

For available fabrics, refer to surfaces.haworth.com.

Improv Series

Leg-Base Stacking Chairs

Without Arms

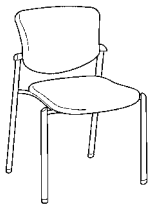

M600-2100

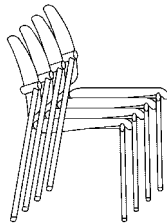

Dimensions

H: 32"(813mm)
 W: 22"(559mm)
 D: 21 1/2"(546mm)
 SH: 18"(457mm)
 SD: 18"(457mm)
 SW: 19"(483mm)

Features

- Optional: Full wood back.
- Polypropylene or upholstered outer back shell.
- Stacks 6-high (44"(1118mm)) on floor or 10-high (58"(1473mm)) on stacking dolly.
- High-density polyethylene leg caps and molded floor glides match frame color except when ordering Metallic trim; molded components are available in black or smoke and must be specified.
- Non-gangng or gangng options.
- Optional book rack, see page 245.
- Fire retardant construction is available to comply with California Bulletin #133, see below.
- COM yardage/COL square footage:
 Polypropylene back shell/upholstered seat: 0.75/15
 Upholstered shell/seat: 1.25/28
 Upholstered seat (wood back): 0.5

To Order, Specify:

- 1) Product number.
- 2) Fabric surface and color.
- 3) Frame trim color.
- 4) Leg caps and glides color for metallic frame black or smoke option only.

To Order Chair with Wood Back, Specify:

- 1) Product number.
- 2) Fabric surface and color (seat).
- 3) Frame trim color.
- 4) Leg caps and glides color for metallic frame black or smoke option only.
- 5) Wood back finish color.



M600-2300

Outer/Inner Back Shell	Gangng	Number	Fabric Grade								Leather Grade A	Leather Grade B
			A	B	C	D	E	F	G	H		
Polypropylene/Upholstered	Non-gangng	M600-2100	\$448.32	\$481.78	\$495.38	\$526.34	\$554.84	\$601.88	\$635.30	\$726.94	\$ 776.48	\$ 939.06
	Gangng	M600-2100-5	505.28	538.74	552.34	583.30	611.80	658.84	692.26	783.90	833.44	996.02
Upholstered/Upholstered	Non-gangng	M600-2200	\$515.18	\$559.79	\$589.49	\$632.84	\$678.66	\$725.71	\$764.08	\$880.50	\$ 963.47	\$1217.68
	Gangng	M600-2200-5	572.14	616.75	646.45	689.80	735.62	782.67	821.04	937.46	1020.43	1274.64
Wood Back	Non-gangng	M600-2300	\$567.20	\$600.66	\$614.26	\$645.22	\$673.72	\$720.76	\$754.18	\$845.82	\$ 895.36	\$1057.94
	Gangng	M600-2300-5	624.16	657.62	671.22	702.18	730.68	777.72	811.14	902.78	952.32	1114.90

The following options require modification of the product number.

Metallic trim color
 CAL 133
 Stain repellent
 Moisture barrier

To specify, add **-M** after the 8th digit; **Example:** M600-2100-**M**

To specify, add **-F** to the end of the product number; **Example:** M600-2200-**F** (add \$63.15 list)

To specify, add **-P** to the end of the product number; **Example:** M600-2100-**P** (add \$39.63 list)

To specify, add **-D** to the end of the product number; **Example:** M600-2100-**D** (add \$52.00 list)

NOTE: CAL 133 is available on fully upholstered outer back and wood back chair models only.

For available fabrics, refer to surfaces.haworth.com.

Improv Series

Leg-Base Stacking Chair with Tablet Arm

With Tablet Arm

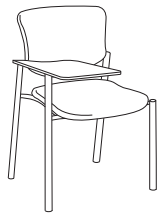

M600-2190
(Right-hand shown)

Dimensions

H: 32"(813mm)
W: 23 1/4"(591mm)
D: 26 3/4"(679mm)
SH: 18"(457mm)
SD: 18"(457mm)
SW: 19"(483mm)
AH: 27"(686mm)

Features

- Polypropylene or upholstered outer back shell.
- Leg caps, tablet arm and molded floor glides match frame color except when ordering Metallic trim; molded components are available in black or smoke and must be specified.
- Non-ganging or ganging options. NOTE: A tablet arm adjacent to another tablet arm or arm chair cannot be ganged together.
- Tablet is plywood core with high-pressure laminate surface and clear lacquered edge.
- Tablet flips up for easier access to seat.
- Optional book rack, see page 245.
- Fire retardant construction is available to comply with California Bulletin #133, see below.
- COM yardage/COL square footage:
Polypropylene back shell: 0.75/15
Upholstered back shell: 1.25/28

To Order, Specify:

- 1) Product number.
- 2) Fabric surface and color.
- 3) Frame trim color.
- 4) Leg caps, tablet arm and glides color for metallic frame black or smoke option only.
- 5) Tablet laminate surface color.

Outer Back Shell	Ganging	11"(279mm) Tablet		Fabric Grade								Leather Grade A	Leather Grade B
		Number		A	B	C	D	E	F	G	H		
Polypropylene	Non-ganging	Right-hand	M600-2190	\$655.12	\$688.58	\$702.18	\$733.14	\$761.64	\$808.68	\$ 842.10	\$ 933.74	\$ 983.28	\$1145.86
		Left-hand	M600-2180	655.12	688.58	702.18	733.14	761.64	808.68	842.10	933.74	983.28	1145.86
	Ganging	Right-hand	M600-2190-5	712.08	745.54	759.14	790.10	818.60	865.64	899.06	990.70	1040.24	1202.82
		Left-hand	M600-2180-5	712.08	745.54	759.14	790.10	818.60	865.64	899.06	990.70	1040.24	1202.82
Upholstered	Non-ganging	Right-hand	M600-2290	\$721.98	\$766.59	\$796.29	\$839.64	\$885.46	\$932.51	\$ 970.88	\$1087.30	\$1170.27	\$1424.48
		Left-hand	M600-2280	721.98	766.59	796.29	839.64	885.46	932.51	970.88	1087.30	1170.27	1424.48
	Ganging	Right-hand	M600-2290-5	778.94	823.55	853.25	896.60	942.42	989.47	1027.84	1144.26	1227.23	1481.44
		Left-hand	M600-2280-5	778.94	823.55	853.25	896.60	942.42	989.47	1027.84	1144.26	1227.23	1481.44

Outer Back Shell	Ganging	14"(356mm) Tablet		Fabric Grade								Leather Grade A	Leather Grade B
		Number		A	B	C	D	E	F	G	H		
Polypropylene	Non-ganging	Right-hand	M600-2170	\$686.07	\$719.53	\$733.13	\$764.09	\$792.59	\$ 839.63	\$ 873.05	\$ 964.69	\$1014.23	\$1176.81
		Left-hand	M600-2160	686.07	719.53	733.13	764.09	792.59	839.63	873.05	964.69	1014.23	1176.81
	Ganging	Right-hand	M600-2170-5	743.03	776.49	790.09	821.05	849.55	896.59	930.01	1021.65	1071.19	1233.77
		Left-hand	M600-2160-5	743.03	776.49	790.09	821.05	849.55	896.59	930.01	1021.65	1071.19	1233.77
Upholstered	Non-ganging	Right-hand	M600-2270	\$752.93	\$797.54	\$827.24	\$870.59	\$916.41	\$ 963.46	\$1001.83	\$1118.25	\$1201.22	\$1455.43
		Left-hand	M600-2260	752.93	797.54	827.24	870.59	916.41	963.46	1001.83	1118.25	1201.22	1455.43
	Ganging	Right-hand	M600-2270-5	809.89	854.50	884.20	927.55	973.37	1020.42	1058.79	1175.21	1258.18	1512.39
		Left-hand	M600-2260-5	809.89	854.50	884.20	927.55	973.37	1020.42	1058.79	1175.21	1258.18	1512.39

The following options require modification of the product number.

Metallic trim color
CAL 133

To specify, add **-M** after the 8th digit; **Example:** M600-2190-M

To specify, add **-F** to the end of the product number; **Example:** M600-2290-F (add \$63.15 list)

NOTE: CAL 133 is available on fully upholstered outer back and wood back chair models only.

Improv Series

Sled-Base Chairs

With Arms, Non-Stacking

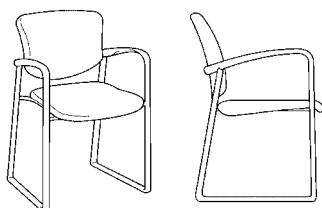

M601-2110

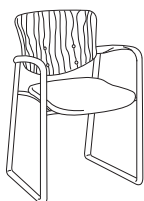

M601-2310

Dimensions

H: 32"(813mm)
 W: 22"(559mm)
 D: 21 1/2"(546mm)
 SH: 18"(457mm)
 SD: 18"(457mm)
 SW: 19"(483mm)
 AH: 25 3/4"(654mm)

Features

- Optional: Full wood back.
- Polypropylene or upholstered outer back shell.
- Non-stacking.
- Arms and nylon sled-base runners match frame color except when ordering Metallic trim; molded components are available black or smoke and must be specified.
- Non-ganging or ganging options. NOTE: An arm chair adjacent to a tablet arm cannot be ganged together.
- Optional book rack, see page 245.
- Fire retardant construction is available to comply with California Bulletin #133, see below.
- COM yardage/COL square footage:
 Polypropylene back shell/upholstered seat: 0.75/15
 Upholstered shell/seat: 1.25/28
 Upholstered seat (wood back): 0.5
- Available on RUSH.

To Order, Specify:

- 1) Product number.
- 2) Fabric surface and color.
- 3) Frame trim color.
- 4) Arm and sled base runners for metallic frame black or smoke option only.

To Order Chair with Wood Back, Specify:

- 1) Product number.
- 2) Fabric surface and color (seat).
- 3) Frame trim color.
- 4) Arm and sled base runners for metallic frame black or smoke option only.
- 5) Wood back finish color.

Outer/Inner Back Shell	Ganging	Number	Fabric Grade								Leather Grade A	Leather Grade B
			A	B	C	D	E	F	G	H		
Polypropylene/Upholstered	Non-ganging	M601-2110 ■	\$620.44	\$653.90	\$667.50	\$698.46	\$726.96	\$774.00	\$807.42	\$ 899.06	\$ 948.60	\$1111.18
	Ganging	M601-2110-5	677.40	710.86	724.46	755.42	783.92	830.96	864.38	956.02	1005.56	1168.14
Upholstered/Upholstered	Non-ganging	M601-2210 ■	\$687.30	\$731.91	\$761.61	\$804.96	\$850.78	\$897.83	\$936.20	\$1052.62	\$1135.59	\$1389.80
	Ganging	M601-2210-5	744.26	788.87	818.57	861.92	907.74	954.79	993.16	1109.58	1192.55	1446.76
Wood Back	Non-ganging	M601-2310 ■	\$739.32	\$772.78	\$786.38	\$817.34	\$845.84	\$892.88	\$926.30	\$1017.94	\$1067.48	\$1230.06
	Ganging	M601-2310-5	796.28	829.74	843.34	874.30	902.80	949.84	983.26	1074.90	1124.44	1287.02

The following options require modification of the product number.

Metallic trim color
 CAL 133
 Stain repellent
 Moisture barrier

To specify, add **-M** after the 8th digit; **Example:** M601-2110-**M**

To specify, add **-F** to the end of the product number; **Example:** M601-2210-**F** (add **\$63.15** list)

To specify, add **-P** to the end of the product number; **Example:** M601-2110-**P** (add **\$39.63** list)

To specify, add **-D** to the end of the product number; **Example:** M601-2110-**D** (add **\$52.00** list)

NOTE: CAL 133 is available on fully upholstered outer back and wood back chair models only.

For available fabrics, refer to surfaces.haworth.com.

Improv Series

Sled-Base Chairs

Without Arms, Non-Stacking

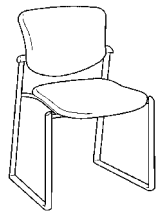

M601-2100

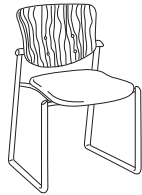
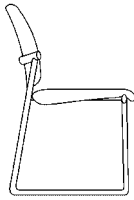

M601-2300

Dimensions

- H: 32"(813mm)
- W: 22"(559mm)
- D: 21 1/2"(546mm)
- SH: 18"(457mm)
- SD: 18"(457mm)
- SW: 19"(483mm)

Features

- Optional: Full wood back.
- Polypropylene or upholstered outer back shell.
- Non-stacking.
- High-density polyethylene leg caps and nylon sled-base runners match frame color except when ordering Metallic trim; molded components are available in black or smoke and must be specified.
- Wood back chairs have four color-matched bolts: black, graphite, smoke and Metallic trim chairs are standard with black bolts, and grey tone and stone chairs are standard with bronze bolts.
- Non-ganging or ganging options.
- Optional book rack, see page 245.
- Fire retardant construction is available to comply with California Bulletin #133, see below.
- COM yardage/COL square footage:
Polypropylene back shell/upholstered seat: 0.75/15
Upholstered back shell/seat: 1.25/28
Upholstered seat (wood back): 0.5

To Order, Specify:

- 1) Product number.
- 2) Fabric surface and color.
- 3) Frame trim color.
- 4) Leg caps and sled base runners color for metallic frame black or smoke option only.

To Order Chair with Wood Back, Specify:

- 1) Product number.
- 2) Fabric surface and color (seat).
- 3) Frame trim color.
- 4) Leg caps and sled base runners color for metallic frame black or smoke option only.
- 5) Wood back finish color.

Outer/Inner Back Shell	Ganging	Number	Fabric Grade								Leather Grade A	Leather Grade B
			A	B	C	D	E	F	G	H		
Polypropylene/Upholstered	Non-ganging	M601-2100	\$591.96	\$625.42	\$639.02	\$669.98	\$698.48	\$745.52	\$778.94	\$ 870.58	\$ 920.12	\$1082.70
	Ganging	M601-2100-5	648.92	682.38	695.98	726.94	755.44	802.48	835.90	927.54	977.08	1139.66
Upholstered/Upholstered	Non-ganging	M601-2200	\$658.82	\$703.43	\$733.13	\$776.48	\$822.30	\$869.35	\$907.72	\$1024.14	\$1107.11	\$1361.32
	Ganging	M601-2200-5	715.78	760.39	790.09	833.44	879.26	926.31	964.68	1081.10	1164.07	1418.28
Wood Back	Non-ganging	M601-2300	\$710.84	\$744.30	\$757.90	\$788.86	\$817.36	\$864.40	\$897.82	\$ 989.46	\$1039.00	\$1201.58
	Ganging	M601-2300-5	767.80	801.26	814.86	845.82	874.32	921.36	954.78	1046.42	1095.96	1258.54

The following options require modification of the product number.

- Metallic trim color
- CAL 133
- Stain repellent
- Moisture barrier

- To specify, add **-M** after the 8th digit; **Example:** M601-2100-**M**
- To specify, add **-F** to the end of the product number; **Example:** M601-2200-**F** (add **\$63.15** list)
- To specify, add **-P** to the end of the product number; **Example:** M601-2100-**P** (add **\$39.63** list)
- To specify, add **-D** to the end of the product number; **Example:** M601-2100-**D** (add **\$52.00** list)

NOTE: CAL 133 is available on fully upholstered outer back and wood back chair models only.

For available fabrics, refer to surfaces.haworth.com.

Improv Series

Sled-Base Chair with Tablet Arm

Non-Stacking

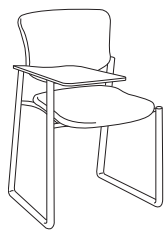

M601-2190
(Right-hand shown)

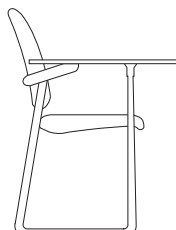

Dimensions

- H: 32"(813mm)
- W: 23 1/4"(591mm)
- D: 26 3/4"(679mm)
- H: 18"(457mm)
- SD: 18"(457mm)
- SW: 19"(483mm)
- AH: 27"(686mm)

Features

- Polypropylene or upholstered outer back shell.
- Non-stacking.
- High-density polyethylene leg caps, tablet arm and nylon sled-base runners match frame color except when ordering Metallic trim; molded components are available in black or smoke and must be specified.
- Non-ganging or ganging options. NOTE: A tablet arm adjacent to another tablet arm or arm chair cannot be ganged together.
- Tablet is plywood core with high-pressure laminate surface and clear lacquered edge.
- Tablet flips up for easier access to seat.
- Optional book rack, see page 245.
- Fire retardant construction is available to comply with California Bulletin #133, see below.
- COM yardage/COL square footage:
Polypropylene back shell: 0.75/15
Upholstered back shell: 1.25/28

To Order, Specify:

- 1) Product number.
- 2) Fabric surface and color.
- 3) Frame trim color.
- 4) Leg caps, tablet arm and steel base runners color for metallic frame black or smoke option only.
- 5) Tablet laminate surface color.

Outer Back Shell	Ganging	11"(279mm) Tablet	Number	Fabric Grade								Leather Grade A	Leather Grade B
				A	B	C	D	E	F	G	H		
Polypropylene	Non-ganging	Right-hand	M601-2190	\$798.76	\$832.22	\$845.82	\$ 876.78	\$ 905.28	\$ 952.32	\$ 985.74	\$1077.38	\$1126.92	\$1289.50
		Left-hand	M601-2180	798.76	832.22	845.82	876.78	905.28	952.32	985.74	1077.38	1126.92	1289.50
	Ganging	Right-hand	M601-2190-5	855.72	889.18	902.78	933.74	962.24	1009.28	1042.70	1134.34	1183.88	1346.46
		Left-hand	M601-2180-5	855.72	889.18	902.78	933.74	962.24	1009.28	1042.70	1134.34	1183.88	1346.46
Upholstered	Non-ganging	Right-hand	M601-2290	\$865.62	\$910.23	\$939.93	\$ 983.28	\$1029.10	\$1076.15	\$1114.52	\$1230.94	\$1313.91	\$1568.12
		Left-hand	M601-2280	865.62	910.23	939.93	983.28	1029.10	1076.15	1114.52	1230.94	1313.91	1568.12
	Ganging	Right-hand	M601-2290-5	922.58	967.19	996.89	1040.24	1086.06	1133.11	1171.48	1287.90	1370.87	1625.08
		Left-hand	M601-2280-5	922.58	967.19	996.89	1040.24	1086.06	1133.11	1171.48	1287.90	1370.87	1625.08

Outer Back Shell	Ganging	14"(356mm) Tablet	Number	Fabric Grade								Leather Grade A	Leather Grade B
				A	B	C	D	E	F	G	H		
Polypropylene	Non-ganging	Right-hand	M601-2170	\$829.71	\$863.17	\$ 876.77	\$ 907.73	\$ 936.23	\$ 983.27	\$1016.69	\$1108.33	\$1157.87	\$1320.45
		Left-hand	M601-2160	829.71	863.17	876.77	907.73	936.23	983.27	1016.69	1108.33	1157.87	1320.45
	Ganging	Right-hand	M601-2170-5	886.67	920.13	933.73	964.69	993.19	1040.23	1073.65	1165.29	1214.83	1377.41
		Left-hand	M601-2160-5	886.67	920.13	933.73	964.69	993.19	1040.23	1073.65	1165.29	1214.83	1377.41
Upholstered	Non-ganging	Right-hand	M601-2270	\$896.57	\$941.18	\$ 970.88	\$1014.23	\$1060.05	\$1107.10	\$1145.47	\$1261.89	\$1344.86	\$1599.07
		Left-hand	M601-2260	896.57	941.18	970.88	1014.23	1060.05	1107.10	1145.47	1261.89	1344.86	1599.07
	Ganging	Right-hand	M601-2270-5	953.53	998.14	1027.84	1071.19	1117.01	1164.06	1202.43	1318.85	1401.82	1656.03
		Left-hand	M601-2260-5	953.53	998.14	1027.84	1071.19	1117.01	1164.06	1202.43	1318.85	1401.82	1656.03

The following options require modification of the product number.

- Metallic trim color
- CAL 133
- Stain repellent
- Moisture barrier

To specify, add **-M** after the 8th digit; **Example:** M601-2190-**M**

To specify, add **-F** to the end of the product number; **Example:** M601-2290-**F** (add \$63.15 list)

To specify, add **-P** to the end of the product number; **Example:** M601-2190-**P** (add \$39.63 list)

To specify, add **-D** to the end of the product number; **Example:** M601-2190-**D** (add \$52.00 list)

NOTE: CAL 133 is available on fully upholstered outer back and wood back chair models only.

For available fabrics, refer to surfaces.haworth.com.

Improv Series

Stools

With Arms

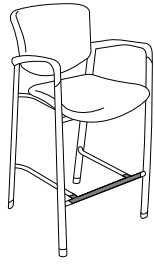

M600-8110



M600-8310

Dimensions

SH: 27 1/2"(699mm)
 H: 41 1/4"(1048mm)
 D: 23"(584mm)
 W: 22"(559mm)
 SW: 19"(483mm)
 SD: 18"(457mm)
 BW: 18 1/4"(464mm)
 AH: 35 1/2"(902mm)
 FH: 10 1/2"(267mm)

Features

- Optional: Full wood back.
- Polypropylene or upholstered outer back shell.
- Arms and molded floor glides match frame color except when ordering Metallic trim; molded components are available in black or smoke and must be specified.
- Wood back chairs have four color-matched bolts: black, graphite, smoke and Metallic trim chairs are standard with black bolts, and grey tone, stone and tan chairs are standard with blackened bronze bolts.
- Distance between the arms is 19 1/4"(489mm).
- Foot rest nylon cover is available in charcoal finish color only.
- Fire retardant construction is available to comply with California Bulletin #133, see below.
- COM yardage/COL square footage:
 Polypropylene shell: 0.75/15
 Upholstered shell: 1.25/28
 Upholstered seat (wood back): 0.5

■ Available on RUSH.

To Order, Specify:

- 1) Product number.
- 2) Fabric surface and color.
- 3) Frame trim color.
- 4) Arms and glides color for metallic frame black or smoke option only.

To Order Stool with Wood Back, Specify:

- 1) Product number.
- 2) Fabric surface and color (seat).
- 3) Frame trim color.
- 4) Arms and glides color for metallic frame black or smoke option only.
- 5) Wood back finish color.

Outer/Inner Back Shell	Number	Fabric Grade								Leather Grade A	Leather Grade B
		A	B	C	D	E	F	G	H		
Polypropylene/Upholstered	M600-8110 ■	\$837.15	\$870.61	\$ 884.21	\$ 915.17	\$ 943.67	\$ 990.71	\$1024.13	\$1115.77	\$1165.31	\$1327.89
Upholstered/Upholstered	M600-8210 ■	904.01	948.62	978.32	1021.67	1067.49	1114.54	1152.91	1269.33	1352.30	1606.51
Wood Back	M600-8310 ■	956.03	989.49	1003.09	1034.05	1062.55	1109.59	1143.01	1234.65	1284.19	1446.77

The following options require modification of the product number.

Metallic trim color
 CAL 133

To specify, add **-M** after the 8th digit; **Example:** M600-8110-**M**

To specify, add **-F** to the end of the product number; **Example:** M600-8210-**F** (add \$63.15 list)

NOTE: CAL 133 is available on fully upholstered outer back and wood back chair models only.

Without Arms

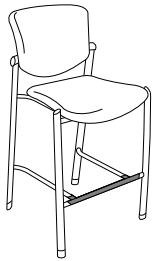

M600-8100

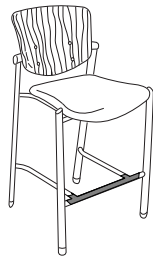

M600-8300

Dimensions

SH: 27 1/2"(699mm)
 H: 41 1/4"(1048mm)
 D: 23"(584mm)
 W: 22"(559mm)
 SW: 19"(483mm)
 SD: 18"(457mm)
 BW: 18 1/4"(464mm)
 FH: 10 1/2"(267mm)

Features

- Optional: Full wood back.
- Polypropylene or upholstered outer back shell.
- High-density polyethylene leg caps and molded floor glides match frame color except when ordering Metallic trim; molded components are available in black or smoke and must be specified.
- Wood back chairs have four color-matched bolts: black, graphite, smoke and Metallic trim chairs are standard with black bolts, and grey tone, stone and tan chairs are standard with blackened bronze bolts.
- Foot rest nylon cover is available in charcoal finish color only.
- Fire retardant construction is available to comply with California Bulletin #133, see below.
- COM yardage/COL square footage:
 Polypropylene shell: 0.75/15
 Upholstered shell: 1.25/28
 Upholstered seat (wood back): 0.5

■ Available on RUSH.

To Order, Specify:

- 1) Product number.
- 2) Fabric surface and color.
- 3) Frame trim color.
- 4) Leg caps and glides color for metallic frame black or smoke option only.

To Order Stool with Wood Back, Specify:

- 1) Product number.
- 2) Fabric surface and color (seat).
- 3) Frame trim color.
- 4) Leg caps and glides color for metallic frame black or smoke option only.
- 5) Wood back finish color.

Polypropylene/Upholstered	M600-8100 ■	\$808.67	\$842.13	\$855.73	\$ 886.69	\$ 915.19	\$ 962.23	\$ 995.65	\$1087.29	\$1136.83	\$1299.41
Upholstered/Upholstered	M600-8200 ■	875.53	920.14	949.84	993.19	1039.01	1086.06	1124.43	1240.85	1323.82	1578.03
Wood Back	M600-8300 ■	927.55	961.01	974.61	1005.57	1034.07	1081.11	1114.53	1206.17	1255.71	1418.29

The following options require modification of the product number.

Metallic trim color
 CAL 133
 Stain repellent
 Moisture barrier

To specify, add **-M** after the 8th digit; **Example:** M600-8100-**M**

To specify, add **-F** to the end of the product number; **Example:** M600-8200-**F** (add \$63.15 list)

To specify, add **-P** to the end of the product number; **Example:** M600-8100-**P** (add \$39.63 list)

To specify, add **-D** to the end of the product number; **Example:** M600-8100-**D** (add \$52.00 list)

NOTE: CAL 133 is available on fully upholstered outer back and wood back chair models only.

For available fabrics, refer to surfaces.haworth.com.

Improv Series

Accessories

	Height	Width	Depth	Number	Price
Stacking Dolly	15"(381mm)	24 1/4"(616mm)	28"(711mm)	MPRV-CART 	\$374.35

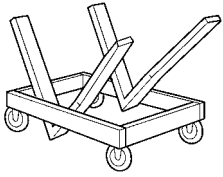

MPRV-CART

Features

- 3"(76mm) hard rubber casters.
- Recommended stacking limit is 10 chairs high (58"(1473mm) armless, 62"(1575mm) with arms, 6-high on casters (50"(1270mm)).
- Entire depth with chairs stacked is 39 3/4"(1009mm).
- Standard in black finish color only.
- Ships assembled.
-  Available on RUSH.

To Order, Specify:

- 1) Product number.
(No finish specification required.)

Book Rack	6 3/4"(159mm)	15 1/4"(387mm)	14 1/2"(368mm)	MPRV-RACK	\$66.51
------------------	---------------	----------------	----------------	-----------	----------------

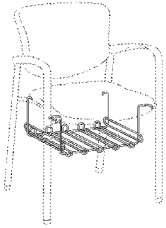

MPRV-RACK

Features

- Field attachable to an Improv leg-base or sled-base side chair.
- Standard in chrome finish only.

To Order, Specify:

- 1) Product number.
(No finish specification required.)

Improv Series

Tandem Seating and Tables

Specification and Ordering Information

Specify standard Improv Series chair models, tandem tables, and chair-to-chair connecting bars to create a continuous seating configuration.

Use the following guidelines when specifying and ordering Improv seating and tables for tandem configurations:

- 1) Specify the desired chair models from pages 238-243.
 - All chair models are designed to accept both table and chair-to-chair connecting bars.
 - NOTE: It is not necessary to order ganging chair models to create a tandem configuration.
- 2) Specify chair-to-chair connecting bars from page 248.
 - One set of connecting bars will join two chairs in tandem.
 - Exceptions:
 - Tablet arm cannot be connected adjacent to an arm chair.
 - Tablet arm cannot be connected adjacent to another tablet arm.
- 3) Specify tandem table models from page 248.
 - Select in-line or end-of-run tables based on desired configuration. Tandem table models include all table-to-chair connecting hardware.
 - Tandem tables cannot be connected to each other.

Specification Example

The following example illustrates a tandem seating and table configuration.

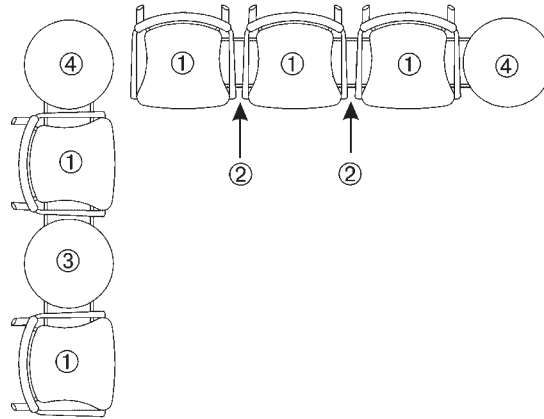

Item	Qty	Number	Description
1	5	M600-2210	Leg-Base Arm Chairs
2	2	MPRV-BARS	Chair-to-Chair Connecting Bars
3	1	MTI1-20	In-Line Tandem Table
4	2	MTE1-20	End-of-Run Tandem Tables

Improv Series

Tandem Seating and Tables

Calculating Tandem Seating Dimensions

Use the following dimensions to determine the footprint of an Improv Series tandem seating configuration.

- 1) All arm and armless chair models are 22" (559mm) wide and 21 1/2" (546mm) deep. Tablet arm chair models are 26 3/4" (679mm) deep. When a tablet arm chair ends a seating configuration, add 1 3/4" (44mm) to the total configuration width.

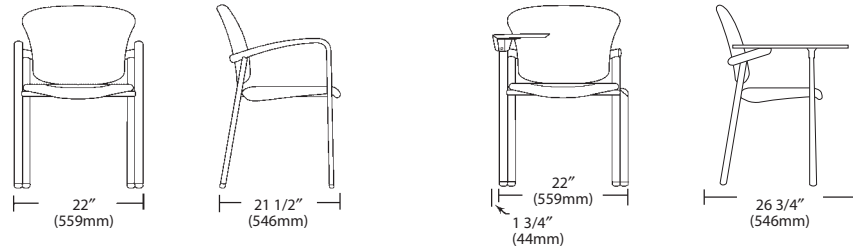

- 2) Add 1 1/4" (32mm) to the width of the seating run for every chair-to-chair connecting bar.

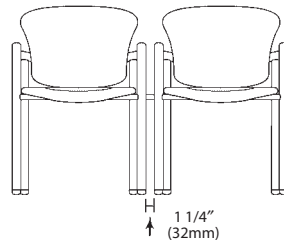

- 3) For every in-line table, add 18 3/4" (476mm) to the width of the seating run.

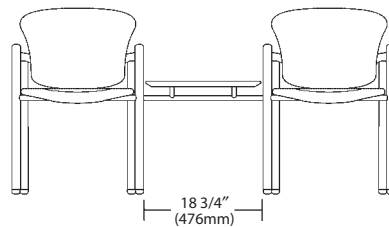

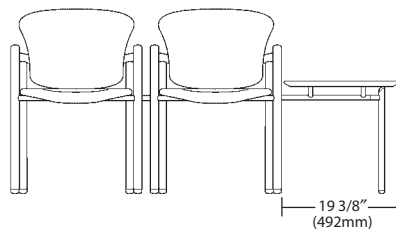

- 4) For every end-of-run table, add 19 3/8" (492mm) to the width of the seating run.

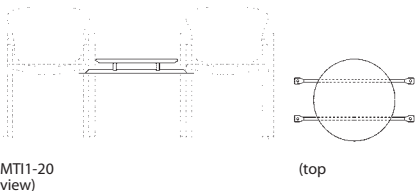
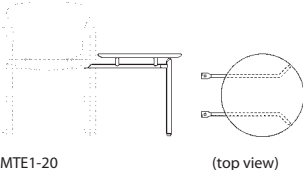

Improv Series

Tandem Tables and Connecting Bars

	Height	Width	Depth	Table Top/Edge	Number	Price
In-Line Table	20"(508mm)	18 3/4"(476mm)	20"(508mm)	Laminate/Bullnose PVC	MTI1-20	\$431.01
				Laminate/Chamfered Hardwood	MTI2-20	574.28
				Wood/Chamfered Hardwood	MTI3-20	636.88
 <p>MTI1-20 view)</p> <p>(top)</p>	Features <ul style="list-style-type: none"> • Table suspends between two Improv chairs in a tandem configuration. • Table top diameter is 20"(508mm). • Width shown is distance between front legs of adjoining chairs. • Price includes installation hardware. 		To Order, Specify: <ol style="list-style-type: none"> 1) Product number. 2) Laminate or wood surface color. 3) PVC or hardwood edge finish color. (Laminate table tops only.) 4) Support frame trim color. <p>To order table with Metallic trim color add -M after sixth digit.</p> <p>Example: MTI1-20-M</p>			
End-of-Run Table	20"(508mm)	19 3/8"(492mm)	20"(508mm)	Laminate/Bullnose PVC	MTE1-20	\$518.89
				Laminate/Chamfered Hardwood	MTE2-20	662.16
				Wood/Chamfered Hardwood	MTE3-20	722.36
 <p>MTE1-20</p> <p>(top view)</p>	Features <ul style="list-style-type: none"> • Table attaches to the end of an Improv chair in a tandem configuration. • Table top diameter is 20"(508mm). • Width shown is distance between front leg of adjoining chair to outermost edge of table. • Molded floor guides match frame color except when ordering Metallic trim; molded components are available in black or smoke and must be specified. • Price includes installation hardware. 		To Order, Specify: <ol style="list-style-type: none"> 1) Product number. 2) Laminate or wood surface color. 3) PVC or hardwood edge finish color. (Laminate table tops only.) 4) Support frame trim color. 5) Glides color for metallic frame black or smoke only. <p>To order table with Metallic trim color add -M after sixth digit.</p> <p>Example: MTE1-20-M</p>			
Chair-to-Chair Connecting Bars		1 1/4"(32mm)			MPRV-BARS	\$55.91
 <p>MPRV-BARS</p>	Features <ul style="list-style-type: none"> • Connects two Improv Series chairs side-by-side with the following exceptions: <ul style="list-style-type: none"> • A tablet arm adjacent to an arm chair. • A tablet arm adjacent to another tablet arm. • Width shown is distance between front legs of adjoining chairs. • Each chair-to-chair connection requires two connecting bars. • Price includes two (2) bars. 		To Order, Specify: <ol style="list-style-type: none"> 1) Product number. 2) Trim color. <p>To order connecting bars with Metallic trim color add -M after eighth digit.</p> <p>Example: MPRV-BARS-M</p>			

Improv Series

Occasional Tables

Height	Table Top/Edge	Number	Laminate		Wood Surface
			A	B	
16"(406mm)	Laminate/Bullnose PVC	MTR1-20-1	\$518.89	\$586.31	N/A
	Laminate/Chamfered Hardwood	MTR2-20-1	701.88	769.30	N/A
Wood only	Wood/Chamfered Hardwood	MTR3-20-1	N/A	N/A	722.34
20"(508mm)	Laminate/Bullnose PVC	MTR1-20-2	\$518.89	\$586.31	N/A
	Laminate/Chamfered Hardwood	MTR2-20-2	701.88	769.30	N/A
Wood only	Wood/Chamfered Hardwood	MTR3-20-2	N/A	N/A	722.34

Round Table

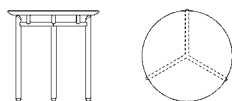

MTR1-20

(top view)

Features

- Table top diameter is 20"(508mm).
- Oval steel tube legs with color-matched high-density polyethylene floor glides and leg polypropylene caps except when ordering Metallic trim; molded components are available in black or smoke and must be specified.
- Shipped fully assembled.

NOTE: Due to the differences in the material properties, the MDF edge will display a darker stain in comparison with the veneer surface.

■ Available on RUSH.

To Order, Specify:

- 1) Product number.
- 2) Laminate or wood surface color.
- 3) PVC or hardwood edge finish color. (Laminate table tops only.)
- 4) Frame trim color.
- 5) Glides and leg caps for metallic frame; black or smoke option only.

To order table with Metallic trim color add **M** after seventh digit.

Example: MTR1-20-1M

Height	Width	Depth	Table Top/Edge	Number	Laminate		Wood Surface
					A	B	
16"(406mm)	20"(508mm)	48"(1219mm)	Laminate/Bullnose PVC	MTV1-2048-1	\$653.74	\$ 721.16	N/A
			Laminate/Chamfered Hardwood	MTV2-2048-1	970.38	1037.80	N/A
Wood only			Wood/Chamfered Hardwood	MTV3-2048-1	N/A	N/A	980.02
20"(508mm)	20"(508mm)	48"(1219mm)	Laminate/Bullnose PVC	MTV1-2048-2	\$653.74	\$ 721.16	N/A
			Laminate/Chamfered Hardwood	MTV2-2048-2	970.38	1037.80	N/A
Wood only			Wood/Chamfered Hardwood	MTV3-2048-2	N/A	N/A	980.02

Oval Table

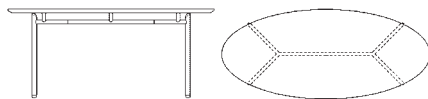

MTV1-2048

(top view)

Features

- Oval steel tube legs with color-matched high-density polyethylene glides and leg polypropylene caps except when ordering Metallic trim; molded components are available in black or smoke and must be specified.
- Shipped fully assembled.

NOTE: Due to the differences in the material properties, the MDF edge will display a darker stain in comparison with the veneer surface.

To Order, Specify:

- 1) Product number.
- 2) Laminate or wood surface color.
- 3) PVC or hardwood edge finish color. (Laminate table tops only.)
- 4) Frame trim color.
- 5) Glides and leg caps for metallic frame; black or smoke option only.

To order table with Metallic trim color add **M** after ninth digit.

Example: MTV1-2048-1M

Table Top Edge Details

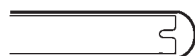

Bullnose PVC

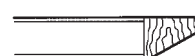

Chamfered Hardwood

This page intentionally blank

LOOK Seating

General Specifications

COM & COL
General Information

To order a COM fabric (Customer's Own Material), contact the Haworth Inquiry Center (1.800.426.8562), your local Haworth dealer, or go to haworth.com/surfaces > COM Library to find out if the COM you have selected has already been tested and approved. The surface collection site also has information on the Haworth+ alliance program with Carnegie, Luna Textiles, and Maharam as well as our industry-leading Pre-Approved COM program.

COM fabrics are placed into Grades based on the cost per linear yard. If a fabric's cost exceeds the range of our highest Grade it will be noted as Non-Graded. The product will be priced at Grade A; the COM fabric costs will appear as a separate line item. The fabric charge will be Haworth's purchase cost plus a 4% administrative fee (based on the cost of the fabric). Yardage calculations will include any applicable fabric repeat.

COM Leather products will be priced at a leather Grade A; COL costs will appear as a separate line item. The leather costs will be Haworth's purchase cost plus a 4% administrative fee (based on the cost of the leather).

General Guidelines for Product Specification

LOOK seating specification numbers are based on an alpha-numeric logic that identifies a product by model and certain characteristics.

For example, a product number that reads **Z841-1741** identifies the product as a Mid-Back LOOK chair with forward tilt, fabric upholstery, pneumatic height adjustment, upholstered shell, height adjustable arms, pivoting arm pads, hard dual casters, and back lock.

The alpha-numeric logic for this model complete with fabric and finish codes is shown below:

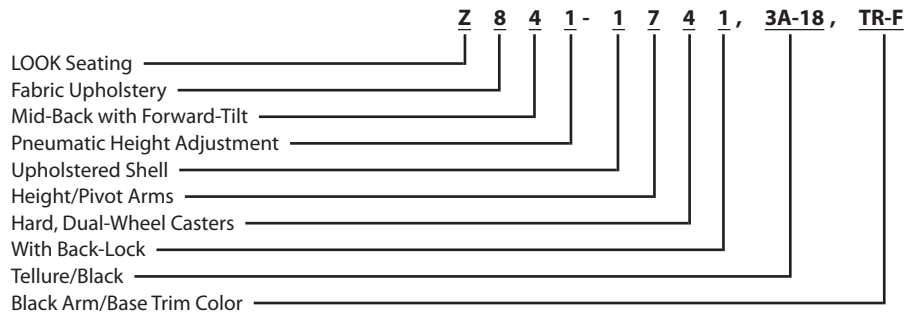

Replace second digit in product number with 7 for leather. Example: **Z741-1741**.

Beyond the printed product number, fabric and finish codes are required to complete an order specification. To communicate your order clearly, list the product number and fabric/finish codes in the sequence outlined on each price page.

Finishes and Fabrics

A complete listing of finishes and fabrics for LOOK seating can be found in the back of the price list.

Features and Options (High- and Mid-Back Chairs)

- LOOK chairs features:
- Molded-polyfoam, contoured seat and back cushions
 - Separate seat and back cushions
 - Five-star base with black casters only
 - Hard dual-wheel casters (standard) or soft dual-wheel casters (optional)
 - Pneumatic seat height adjustment
 - Width adjustable arms, height adjustable arms, fixed arms, armless
 - Tilt tension

LOOK Seating

General Specifications

Mobility and Adjustability (High- and Mid-Back Chairs)

The following features are available on LOOK chair models.

- Synchronized-tilt (standard)
- Back and seat recline at a 2:1 ratio with no front seat rise
- Back tilts backward 20° from the upright position
- Seat pan moves downward 10° from the initial position
- Synchronized-tilt with back-lock
- Back is lockable in four positions within tilt range
- Forward-tilt
- Both chair back and seat pan are lockable in one forward position (3°)
- Seat pan slides horizontally within a 2”(51mm) range
- Back adjusts vertically within a 3”(76mm) range
- Height adjustable arm adjust vertically within a 4”(102mm) range
- Adjustable arms rotate 360°
- Width adjustable arms adjust vertically within a 4”(102mm) range and rotate 360°, and go in/out 2”(51mm).

Features and Options (Side Chairs)

LOOK Series side chair models feature:

- 14-gauge round steel tubing legs
- Double shell seat and back construction
- Molded polyurethane seat and back foam
- Fully upholstered back shell, or full plastic back
- High-density polyethylene floor glides (leg-base models)
- All models available with caster option
- Powder coated frame: available in black and three metallic colors
- Side chair without arms models stack 6-high (44”(1118mm)) on the floor
- Side chair with arms models stack 4-high on the floor
- Side chair with casters stacks 4-high on the floor
- Lounge chair stacks 2-high on the floor

Arm chair models feature:

- Round tubing
- Optional plastic arm cap

Lounge models feature:

- Inner arm shell with foam and upholstery

LOOK series chairs meet or exceed ANSI/BIFMA durability standards for office seating.

LOOK Seating

High-Back Chair without Arms



Z851-1042

Dimensions*

- SH: 16" - 20.75"
(406mm - 527mm)
- H: 43.5" - 51.25"
(1105mm - 1302mm)
- D: 26.5"(673mm)
- W: 26.25"(667mm)
- SW: 18.5"(470mm)
- SD: 15" - 17"
(381mm - 432mm)

Features

- Outer Shell: Upholstered
- Casters: Standard with hard casters; or optional soft casters, see below.
- Mechanism: Swivel with synchronized-tilt.
- Height Adjustment: Pneumatic
- 2"(51mm) Seat depth adjustment.
- 3"(76mm) Back height adjustment.
- Optional Back-Lock: Lockable in four positions.
- Optional forward tilt is 3°.
- Tilt tension.
- User Instructions: Embossed on stainless steel inserts on levers. Instructions in braille on underside of levers.
- COM yardage / COL square footage: 2.0/30

To Order, Specify:

- 1) Product number.
- 2) Fabric surface and color.
- 3) Trim color for arms and base (TR-F Black only).

Leather Upholstery

Leather upholstery requires modification of the product number. Change the second digit in the product number from **8** to **7** and specify the leather surface and color.

Example: Z851-1042 = chair with fabric;
Z751-1042 = chair with leather

* All measurements taken with the BIFMA chair measuring device.

Outer Shell	Number	Fabric Grade								Leather Grade A	Leather Grade B
		A	B	C	D	E	F	G	H		
Pneumatic Height Adjustment											
Upholstered	Z851-1042	\$840.26	\$ 917.30	\$ 991.94	\$1023.24	\$1069.00	\$1245.96	\$1331.40	\$1570.98	\$1394.02	\$1567.10
Pneumatic Height Adjustment/Back-Lock/Forward Tilt											
Upholstered	Z861-1041	\$947.40	\$1024.44	\$1099.08	\$1130.38	\$1176.14	\$1353.10	\$1438.54	\$1678.12	\$1501.16	\$1674.24

Soft Caster Option

Soft caster option requires modification of the product number. Change the seventh digit in the product number from **4** to **2**.

Example: Z851-1022 = chair with soft casters

Stain Repellent Option

To specify add **-P** to end of the product number.

Example: Z851-1042-P (add \$38.52 list)

NOTE: For available fabrics, refer to surfaces.haworth.com.

LOOK Seating

High-Back Chair with Fixed Arms



Z851-1442

Dimensions*

- SH: 16" - 20.75"
(406mm - 527mm)
- H: 43.5" - 51.25"
(1105mm - 1302mm)
- D: 26.5"(673mm)
- W: 26.25"(667mm)
- SW: 18.5"(470mm)
- SD: 15" - 17"
(381mm - 432mm)
- AH: 9"(229mm)
- AW: 18.75"(476mm)

Features

- Outer Shell: Upholstered
- Arm Caps: Soft black vinyl.
- Casters: Standard with hard casters; or optional soft casters, see below.
- Mechanism: Swivel with synchronized-tilt.
- Height Adjustment: Pneumatic
- 2"(51mm) Seat depth adjustment.
- 3"(76mm) Back height adjustment.
- Optional Back-Lock: Lockable in four positions.
- Optional forward tilt is 3°.
- Tilt tension.
- User Instructions: Embossed on stainless steel inserts on levers. Instructions in braille on underside of levers.
- COM yardage / COL square footage: 2.0/30
- Available on RUSH.

To Order, Specify:

- 1) Product number.
- 2) Fabric surface and color.
- 3) Trim color for arms and base (TR-F Black only).

Leather Upholstery

Leather upholstery requires modification of the product number. Change the second digit in the product number from **8** to **7** and specify the leather surface and color.

Example: Z851-1442 = chair with fabric;
Z751-1442 = chair with leather

* All measurements taken with the BIFMA chair measuring device.

Outer Shell	Arm Cap	Number	Fabric Grade							Leather Grade A	Leather Grade B	
			A	B	C	D	E	F	G			H
Pneumatic Height Adjustment												
Upholstered	Soft Black Vinyl	Z851-1442	\$ 936.56	\$1013.60	\$1088.24	\$1119.54	\$1165.30	\$1342.26	\$1427.70	\$1667.28	\$1490.32	\$1663.40
Pneumatic Height Adjustment/Back-Lock/Forward Tilt												
Upholstered	Soft Black Vinyl	Z861-1441	\$1043.70	\$1120.74	\$1195.38	\$1226.68	\$1272.44	\$1449.40	\$1534.84	\$1774.42	\$1597.46	\$1770.54

Soft Caster Option

Soft caster option requires modification of the product number. Change the seventh digit in the product number from **4** to **2**.

Example: Z851-1422 = chair with soft casters

Stain Repellent Option

To specify add **-P** to end of the product number.

Example: Z851-1442-P (add \$38.52 list)

NOTE: For available fabrics, refer to surfaces.haworth.com.

LOOK Seating

High-Back Chair with Height Adjustable Arms



Z851-1742

Dimensions*

SH:	16" - 20.75" (406mm - 527mm)
H:	43.5" - 51.25" (1105mm - 1302mm)
D:	26.5"(673mm)
W:	26.25"(667mm)
SW:	18.5"(470mm)
SD:	15" - 17" (381mm - 432mm)
AH:	8" - 12" (203mm - 305mm)
AW:	18.75"(476mm)

Features

- Outer Shell: Upholstered
- Arm Caps: Soft black vinyl.
- Arm Height Adjustment: 4"(102mm) adjustment.
- Arm Adjustment Controls: Fingertip activation.
- Arm Pad Rotation: 360°
- Casters: Standard with hard casters; or optional soft casters, see below.
- Mechanism: Swivel with synchronized-tilt.
- Height Adjustment: Pneumatic
- 2"(51mm) Seat depth adjustment.
- 3"(76mm) Back height adjustment.
- Optional Back-Lock: Lockable in four positions.
- Optional forward tilt is 3°.
- Tilt tension.
- User Instructions: Embossed on stainless steel inserts on levers. Instructions in braille on underside of levers.
- COM yardage / COL square footage: 2.0/30
- Available on RUSH.

To Order, Specify:

- 1) Product number.
- 2) Fabric surface and color.
- 3) Trim color for arms and base (TR-F Black only).

Leather Upholstery

Leather upholstery requires modification of the product number. Change the second digit in the product number from **8** to **7** and specify the leather surface and color.

Example: Z851-1742 = chair with fabric;
Z751-1742 = chair with leather

* All measurements taken with the BIFMA chair measuring device.

Outer Shell	Arm Cap	Number	Fabric Grade		C	D	E	F	G	H	Leather Grade A	Leather Grade B
			A	B								
Pneumatic Height Adjustment												
Upholstered	Soft Black Vinyl	Z851-1742	\$1050.93	\$1127.97	\$1202.61	\$1233.91	\$1279.67	\$1456.63	\$1542.07	\$1781.65	\$1604.69	\$1777.77
Pneumatic Height Adjustment/Back-Lock/Forward Tilt												
Upholstered	Soft Black Vinyl	Z861-1741	\$1158.07	\$1235.11	\$1309.75	\$1341.05	\$1386.81	\$1563.77	\$1649.21	\$1888.79	\$1711.83	\$1884.91

Soft Caster Option

Soft caster option requires modification of the product number. Change the seventh digit in the product number from **4** to **2**.

Example: Z851-1722 = chair with soft casters

Stain Repellent Option

To specify add **-P** to end of the product number.

Example: Z851-1742-P (add \$38.52 list)

NOTE: For available fabrics, refer to surfaces.haworth.com.

LOOK Seating

High-Back Chair with Height and Width Adjustable Arms



Z851-1W42

Dimensions*

- SH: 16" - 20.75"
(406mm - 527mm)
- H: 43.5" - 51.25"
(1105mm - 1302mm)
- D: 26.5"(673mm)
- W: 26.25"(667mm)
- SW: 18.5"(470mm)
- SD: 15" - 17"
(381mm - 432mm)
- AH: 8" - 12"
(203mm - 305mm)
- AW: 18.5" - 20.5"
(470mm - 521mm)

Features

- Outer Shell: Upholstered
- Arm Caps: Soft black vinyl.
- Arm Height Adjustment: 4"(102mm) adjustment.
- Arm Width Adjustment: 2"(51mm) adjustment.
- Arm Adjustment Controls: Fingertip activation.
- Arm Pad Rotation: 360°
- Casters: Standard with hard casters; or optional soft casters, see below.
- Mechanism: Swivel with synchronized-tilt.
- Height Adjustment: Pneumatic
- 2"(51mm) Seat depth adjustment.
- 3"(76mm) Back height adjustment.
- Optional Back-Lock: Lockable in four positions.
- Optional forward tilt is 3°.
- Tilt tension.
- User Instructions: Embossed on stainless steel inserts on levers. Instructions in braille on underside of levers.
- COM yardage / COL square footage: 2.0/30

■ Available on RUSH.

* All measurements taken with the BIFMA chair measuring device.

To Order, Specify:

- 1) Product number.
- 2) Fabric surface and color.
- 3) Trim color for arms and base (TR-F Black only).

Leather Upholstery

Leather upholstery requires modification of the product number. Change the second digit in the product number from **8** to **7** and specify the leather surface and color.

Example: Z851-1W42 = chair with fabric;
Z751-1W42 = chair with leather

Outer Shell	Arm Cap	Number	Fabric Grade								Leather Grade A	Leather Grade B
			A	B	C	D	E	F	G	H		
Pneumatic Height Adjustment												
Upholstered	Soft Black Vinyl	Z851-1W42 ■	\$1085.84	\$1162.88	\$1237.52	\$1268.82	\$1314.58	\$1491.54	\$1576.98	\$1816.56	\$1639.60	\$1812.68
Pneumatic Height Adjustment/Back-Lock/Forward Tilt												
Upholstered	Soft Black Vinyl	Z861-1W41 ■	\$1192.98	\$1270.02	\$1344.66	\$1375.96	\$1421.72	\$1598.68	\$1684.12	\$1923.70	\$1746.74	\$1919.82

Soft Caster Option

Soft caster option requires modification of the product number. Change the seventh digit in the product number from **4** to **2**.

Example: Z851-1W22 = chair with soft casters

Stain Repellent Option

To specify add **-P** to end of the product number.

Example: Z851-1W42-P (add **\$38.52** list)

NOTE: For available fabrics, refer to surfaces.haworth.com.

LOOK Seating

Mid-Back Chair without Arms



Z831-1042

Dimensions*

- SH: 16" - 20.75"
(406mm - 527mm)
- H: 40" - 47.75"
(1016mm - 1213mm)
- D: 26.5"(673mm)
- W: 26.25"(667mm)
- SW: 18.5"(470mm)
- SD: 15" - 17"
(381mm - 432mm)

Features

- Outer Shell: Upholstered
- Casters: Standard with hard casters; or optional soft casters, see below.
- Mechanism: Swivel with synchronized-tilt.
- Height Adjustment: Pneumatic
- 2"(51mm) Seat depth adjustment.
- 3"(76mm) Back height adjustment.
- Optional Back-Lock: Lockable in four positions.
- Optional forward tilt is 3°.
- Tilt tension.
- User Instructions: Embossed on stainless steel inserts on levers. Instructions in braille on underside of levers.
- COM yardage / COL square footage: 1.5/30

■ Available on RUSH.

*All measurements taken with the BIFMA chair measuring device.

To Order, Specify:

- 1) Product number.
- 2) Fabric surface and color.
- 3) Trim color for arms and base (TR-F Black only).

Leather Upholstery

Leather upholstery requires modification of the product number. Change the second digit in the product number from **8** to **7** and specify the leather surface and color.

Example: Z831-1042 = chair with fabric;
Z731-1042 = chair with leather

Outer Shell	Number	Fabric Grade		C	D	E	F	G	H	Leather Grade A	Leather Grade B
		A	B								
Pneumatic Height Adjustment											
Upholstered	Z831-1042 ■	\$764.42	\$841.46	\$ 916.10	\$ 947.40	\$ 993.16	\$1065.38	\$1127.96	\$1306.14	\$1318.18	\$1491.26
Pneumatic Height Adjustment/Back-Lock/Forward Tilt											
Upholstered	Z841-1041 ■	\$871.56	\$948.60	\$1023.24	\$1054.54	\$1100.30	\$1172.52	\$1235.10	\$1413.28	\$1425.32	\$1598.40

Soft Caster Option

Soft caster option requires modification of the product number. Change the seventh digit in the product number from **4** to **2**.

Example: Z831-1022 = chair with soft casters

Stain Repellent Option

To specify add **-P** to end of the product number.

Example: Z831-1042-P (add \$38.52 list)

NOTE: For available fabrics, refer to surfaces.haworth.com.

LOOK Seating

Mid-Back Chair with Fixed Arms



Z831-1442

Dimensions*

- SH: 16" - 20.75"
(406mm - 527mm)
- H: 40" - 47.75"
(1016mm - 1213mm)
- D: 26.5"(673mm)
- W: 26.25"(667mm)
- SW: 18.5"(470mm)
- SD: 15" - 17"
(381mm - 432mm)
- AH: 9"(229mm)
- AW: 18.75"(476mm)

Features

- Outer Shell: Upholstered
- Arm Caps: Soft black vinyl.
- Casters: Standard with hard casters; or optional soft casters, see below.
- Mechanism: Swivel with synchronized-tilt.
- Height Adjustment: Pneumatic
- 2"(51mm) Seat depth adjustment.
- 3"(76mm) Back height adjustment.
- Optional Back-Lock: Lockable in four positions.
- Optional forward tilt is 3°.
- Tilt tension.
- User Instructions: Embossed on stainless steel inserts on levers. Instructions in braille on underside of levers.
- COM yardage / COL square footage: 1.5/30
- Available on RUSH.

To Order, Specify:

- 1) Product number.
- 2) Fabric surface and color.
- 3) Trim color for arms and base (TR-F Black only).

Leather Upholstery

Leather upholstery requires modification of the product number. Change the second digit in the product number from **8** to **7** and specify the leather surface and color.

Example: Z831-1442 = chair with fabric;
Z731-1442 = chair with leather

*All measurements taken with the BIFMA chair measuring device.

Outer Shell	Arm Cap	Number	Fabric Grade							Leather Grade A	Leather Grade B	
			A	B	C	D	E	F	G			H
Pneumatic Height Adjustment												
Upholstered	Soft Black Vinyl	Z831-1442	\$860.72	\$ 937.76	\$1012.40	\$1043.70	\$1089.46	\$1161.68	\$1224.26	\$1402.44	\$1414.48	\$1587.56
Pneumatic Height Adjustment/Back-Lock/Forward Tilt												
Upholstered	Soft Black Vinyl	Z841-1441	\$967.86	\$1044.90	\$1119.54	\$1150.84	\$1196.60	\$1268.82	\$1331.40	\$1509.58	\$1521.62	\$1694.70

Soft Caster Option

Soft caster option requires modification of the product number. Change the seventh digit in the product number from **4** to **2**.

Example: Z831-1422 = chair with soft casters

Stain Repellent Option

To specify add **-P** to end of the product number.

Example: Z831-1442-P (add \$38.52 list)

NOTE: For available fabrics, refer to surfaces.haworth.com.

LOOK Seating

Mid-Back Chair with Height Adjustable Arms



Z831-1742

Dimensions*

SH:	16" - 20.75" (406mm - 527mm)
H:	40" - 47.75" (1016mm - 1213mm)
D:	26.5"(673mm)
W:	26.25"(667mm)
SW:	18.5"(470mm)
SD:	15" - 17" (381mm - 432mm)
AH:	8" - 12" (203mm - 305mm)
AW:	18.75"(476mm)

Features

- Outer Shell: Upholstered
- Arm Caps: Soft black vinyl.
- Arm Height Adjustment: 4"(102mm) adjustment.
- Arm Adjustment Controls: Fingertip activation.
- Arm Pad Rotation: 360°
- Casters: Standard with hard casters; or optional soft casters, see below.
- Mechanism: Swivel with synchronized-tilt.
- Height Adjustment: Pneumatic
- 2"(51mm) Seat depth adjustment.
- 3"(76mm) Back height adjustment.
- Optional Back-Lock: Lockable in four positions.
- Optional forward tilt is 3°.
- Tilt tension.
- User Instructions: Embossed on stainless steel inserts on levers. Instructions in braille on underside of levers.
- COM yardage / COL square footage: 1.5/30
- Available on RUSH.

To Order, Specify:

- 1) Product number.
- 2) Fabric surface and color.
- 3) Trim color for arms and base (TR-F Black only).

Leather Upholstery

Leather upholstery requires modification of the product number. Change the second digit in the product number from **8** to **7** and specify the leather surface and color.

Example: Z831-1742 = chair with fabric;
Z731-1742 = chair with leather

*All measurements taken with the BIFMA chair measuring device.

Outer Shell	Arm Cap	Number	Fabric Grade		C	D	E	F	G	H	Leather Grade A	Leather Grade B
			A	B								
Pneumatic Height Adjustment												
Upholstered	Soft Black Vinyl	Z831-1742	\$ 975.09	\$1052.13	\$1126.77	\$1158.07	\$1203.83	\$1276.05	\$1338.63	\$1516.81	\$1528.85	\$1701.93
Pneumatic Height Adjustment/Back-Lock/Forward Tilt												
Upholstered	Soft Black Vinyl	Z841-1741	\$1082.23	\$1159.27	\$1233.91	\$1265.21	\$1310.97	\$1383.19	\$1445.77	\$1623.95	\$1635.99	\$1809.07

Soft Caster Option

Soft caster option requires modification of the product number. Change the seventh digit in the product number from **4** to **2**.

Example: Z831-1722 = chair with soft casters

Stain Repellent Option

To specify add **-P** to end of the product number.

Example: Z831-1742-P (add \$38.52 list)

NOTE: For available fabrics, refer to surfaces.haworth.com.

LOOK Seating

Mid-Back Chair with Height and Width Adjustable Arms



Z831-1W42

Dimensions*

- SH: 16" - 20.75"
(406mm - 527mm)
- H: 40" - 47.75"
(1016mm - 1213mm)
- D: 26.5"(673mm)
- W: 26.25"(667mm)
- SW: 18.5"(470mm)
- SD: 15" - 17"
(381mm - 432mm)
- AH: 8" - 12"
(203mm - 305mm)
- AW: 18.5"-20.5"
(470mm- 521mm)

Features

- Outer Shell: Upholstered
- Arm Caps: Soft black vinyl.
- Arm Height Adjustment: 4"(102mm) adjustment.
- Arm Width Adjustment: 2"(51mm) adjustment.
- Arm Adjustment Controls: Fingertip activation.
- Arm Pad Rotation: 360°
- Casters: Standard with hard casters; or optional soft casters, see below.
- Mechanism: Swivel with synchronized-tilt.
- Height Adjustment: Pneumatic
- 2"(51mm) Seat depth adjustment.
- 3"(76mm) Back height adjustment.
- Optional Back-Lock: Lockable in four positions.
- Optional forward tilt is 3°.
- Tilt tension.
- User Instructions: Embossed on stainless steel inserts on levers. Instructions in braille on underside of levers.
- COM yardage / COL square footage: 1.5/30

■ Available on RUSH.

*All measurements taken with the BIFMA chair measuring device.

To Order, Specify:

- 1) Product number.
- 2) Fabric surface and color.
- 3) Trim color for arms and base (TR-F Black only).

Leather Upholstery

Leather upholstery requires modification of the product number. Change the second digit in the product number from **8** to **7** and specify the leather surface and color.

Example: Z831-1W42 = chair with fabric;
Z731-1W42 = chair with leather

Outer Shell	Arm Cap	Number	Fabric Grade								Leather Grade A	Leather Grade B
			A	B	C	D	E	F	G	H		
Pneumatic Height Adjustment												
Upholstered	Soft Black Vinyl	Z831-1W42 ■	\$1010.00	\$1087.04	\$1161.68	\$1192.98	\$1238.74	\$1310.96	\$1373.54	\$1551.72	\$1563.76	\$1736.84
Pneumatic Height Adjustment/Back-Lock/Forward Tilt												
Upholstered	Soft Black Vinyl	Z841-1W41 ■	\$1117.14	\$1194.18	\$1268.82	\$1300.12	\$1345.88	\$1418.10	\$1480.68	\$1658.86	\$1670.90	\$1843.98

Soft Caster Option

Soft caster option requires modification of the product number. Change the seventh digit in the product number from **4** to **2**.

Example: Z831-1W22 = chair with soft casters

Stain Repellent Option

To specify add **-P** to end of the product number.

Example: Z831-1W42-P (add **\$38.52** list)

NOTE: For available fabrics, refer to surfaces.haworth.com.

LOOK Seating

Side Chairs

Without Arms

Z600-2100

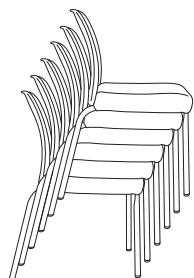
**Dimensions***

H: Upholstered:
33.75"(857mm)
Polypropylene:
32.25"(819mm)
W: 20.37"(517mm)
D: 24"(610mm)
SH: 18"(457mm)
SD: 18.25"(463mm)
SW: 18.75"(476mm)

Features

- Polypropylene or upholstered back shell.
- Optional: Legs with casters
- Stacks 6-high on floor.
- Back flex is 2"(51mm).
- Molded floor glides are standard in black
- COM Yardage/COL square footage:
Polypropylene Back Shell: 0.85/16
Upholstered Back Shell: 1.85/35

* All measurements taken with the BIFMA chair measuring device.

To Order, Specify:

- 1) Product number.
- 2) Back surface and color.
- 3) Frame trim color.

To Order Chair with Polypropylene Back, Specify:

- 1) Product number.
- 2) Fabric surface and color (seat).
- 3) Polypropylene back finish color.
- 4) Frame trim color.

Back	Number	Fabric Grade								Leather Grade A	Leather Grade B
		A	B	C	D	E	F	G	H		
Polypropylene	Z600-2100	\$350.02	\$394.42	\$436.23	\$454.50	\$481.93	\$535.47	\$573.36	\$ 683.06	\$ 667.39	\$ 836.10
Upholstered	Z600-2200	400.95	487.14	575.98	609.91	662.15	801.90	889.42	1123.19	1035.69	1373.11

Caster Option

Caster option requires modification of the product number.

Hard Caster Option

Hard caster option requires modification of the product number. Change the eighth digit in the product number from **0** to **4** and add **\$62.00** list.

Example: Z600-2104

Soft Caster Option

Soft caster option requires modification of the product number. Change the eighth digit in the product number from **0** to **2** and add **\$62.00** list.

Example: Z600-2102

Stain Repellent Option

To specify add **-P** to end of the product number.

Example: Z600-2100-**P** (add **\$38.16** list)

Moisture Barrier Option

To specify add **-D** to end of the product number.

Example: Z600-2100-**D** (add **\$50.01** list)

NOTE: For available fabrics, refer to surfaces.haworth.com.

LOOK Seating

Side Chairs

With Arms

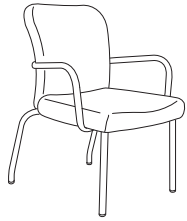

Z600-2210

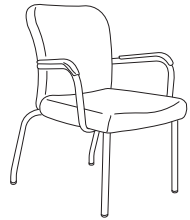

Z600-2230

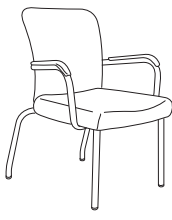

Z600-2130

Dimensions*

H: Upholstered:
33.75"(857mm)
Polypropylene:
32.25"(819mm)
W: 24"(610mm)
D: 24"(610mm)
SH: 18"(457mm)
SD: 18.25"(463mm)
SW: 18.75"(476mm)

Features

- Polypropylene or upholstered back shell.
- Optional: Legs with casters
- Chairs with arms and glides stack 6-high.
- Chairs with arms and casters stack 3-high.
- Back flex is 2"(51mm).
- Arms formed from steel tubular frame.
- Arm caps and molded floor glides are standard in black.
- COM Yardage/COL square footage:
Polypropylene Back Shell: 0.85/16
Upholstered Back Shell: 1.85/35

* All measurements taken with the BIFMA chair measuring device.

To Order, Specify:

- 1) Product number.
- 2) Back surface and color.
- 3) Frame/arm trim color.

To Order Chair with Polypropylene Back, Specify:

- 1) Product number.
- 2) Fabric surface and color (seat).
- 3) Polypropylene back finish color.
- 4) Frame/arm trim color.

Back	Arms	Number	Fabric Grade								Leather Grade A	Leather Grade B
			A	B	C	D	E	F	G	H		
Polypropylene	Standard	Z600-2110	\$393.12	\$437.52	\$479.33	\$497.60	\$525.03	\$578.57	\$616.46	\$ 726.16	\$ 710.49	\$ 879.20
	Arm Caps	Z600-2130	419.24	463.64	505.45	523.72	551.15	604.69	642.58	752.28	736.61	905.32
Upholstered	Standard	Z600-2210	\$444.05	\$530.24	\$619.08	\$653.01	\$705.25	\$845.00	\$932.52	\$1166.29	\$1078.79	\$1416.21
	Arm Caps	Z600-2230	470.17	556.36	645.20	679.13	731.37	871.12	958.64	1192.41	1104.91	1442.33

Caster Option

Caster option requires modification of the product number.

Hard Caster Option

Hard caster option requires modification of the product number. Change the eighth digit in the product number from **0** to **4** and add **\$62.00** list.
Example: Z600-2114

Soft Caster Option

Soft caster option requires modification of the product number. Change the eighth digit in the product number from **0** to **2** and add **\$62.00** list.
Example: Z600-2112

Stain Repellent Option

To specify add **-P** to end of the product number.
Example: Z600-2110-**P** (add **\$38.16** list)

Moisture Barrier Option

To specify add **-D** to end of the product number.
Example: Z600-2110-**D** (add **\$50.01** list)

NOTE: For available fabrics, refer to surfaces.haworth.com.

LOOK Seating

Lounge Chairs

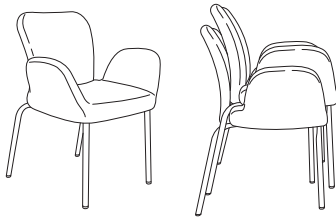
Lounge Chair

Z600-2440

Dimensions*

H: 33.75"(857mm)
 W: 25"(635mm)
 D: 24"(610mm)
 SH: 18"(457mm)
 SD: 18.25"(463mm)
 SW: 18.15"(461mm)

Features

- Fully upholstered inner and outer back.
- Optional: Legs with casters
- Stacks 2-high on floor.
- Back flex is 2"(51mm).
- Fully upholstered panel arms.
- Molded floor glides are standard in black.
- COM yardage / COL square footage:
2.35/48

* All measurements taken with the BIFMA chair measuring device.

To Order, Specify:

- 1) Product number.
- 2) Back surface and color.
- 3) Frame trim color.

Back	Arms	Number	Fabric Grade								Leather Grade A	Leather Grade B
			A	B	C	D	E	F	G	H		
Upholstered	Panel	Z600-2440	\$783.62	\$869.81	\$958.65	\$992.58	\$1044.82	\$1291.66	\$1402.69	\$1703.08	\$1418.36	\$1755.78

Caster Option

Caster option requires modification of the product number.

Hard Caster Option

Hard caster option requires modification of the product number. Change the eighth digit in the product number from **0** to **4** and add **\$62.00** list.

Example: Z600-2444

Soft Caster Option

Soft caster option requires modification of the product number. Change the eighth digit in the product number from **0** to **2** and add **\$62.00** list.

Example: Z600-2442

Stain Repellent Option

To specify add **-P** to end of the product number.

Example: Z600-2440-P (add **\$38.16** list)

Moisture Barrier Option

To specify add **-D** to end of the product number.

Example: Z600-2440-D (add **\$50.01** list)

NOTE: For available fabrics, refer to surfaces.haworth.com.

This page intentionally blank

Accolade Seating

General Specifications

**Features and Options
(Mid-Back and High-Back)**

Accolade models feature:

- Tilt-tension adjustment
- Double shell construction
- Slab polyurethane foam, contoured seat and back cushions
- Polypropylene or upholstered outer shell
- Five-star welded steel base with plastic cover
- Hard, dual-wheel casters for carpeted floors (black only)
- Soft, dual-wheel casters for resilient floor surfaces (black only)
- Standard hard arm caps, upholstered (fabric or leather) arm caps, or upholstered black vinyl arm caps

Accolade seating meets or exceeds all ANSI/BIFMA durability standards for office seating.

Pneumatic chair models comply with ANSI/HFS 100–1988 standards for Visual Display Terminal seating.

Mobility and Adjustability

High-back and Mid-back models feature:

- Pneumatic seat height adjustment
- Back height adjustment
- Synchronized-tilt mechanism
- Optional back-lock (six-position)
- Optional standard forward-tilt
- Optional cantilever arms
- Optional low-position seat height adjustment (1”(25mm) below standard)

Sled-base models feature:

- Fixed height
- Front stabilizer nylon glides (black finish only)

Accolade Seating

General Specifications

Mobility and Adjustability (continued)

The following features are available on Accolade seating models. Refer to the price pages for available options on a specific model.

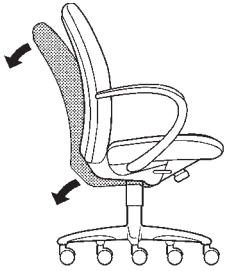

- ▶ Synchronized-tilt (standard)
 - Back and seat recline at a 2:1 ratio with no front seat rise
 - Back tilts backward 16° from the upright position
 - Seat pan moves downward 8° from the initial position

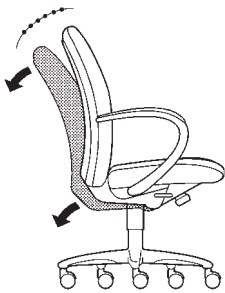

- ▶ Synchronized-tilt with back-lock
 - Back and seat recline at a 2:1 ratio with no front seat rise
 - Back is lockable in six positions within tilt range
 - Back tilts backward 16° from the upright position
 - Seat pan moves downward 8° from the initial position

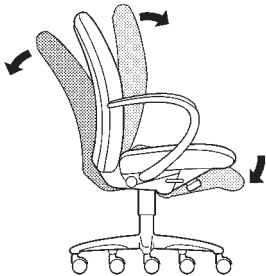

- ▶ Synchronized-tilt with standard forward-tilt
 - Back and seat recline at a 2:1 ratio with no front seat rise
 - Seat and back move forward by rotating knob adjustment
 - Seat pitch is 7° and back pitch is 15° forward from standard pitch
 - Back reclines in the forward-tilt mode
 - Back tilts backward 16° from the upright position

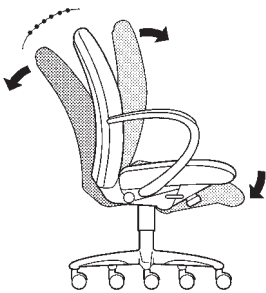

- ▶ Synchronized-tilt with standard forward-tilt and back-lock
 - Back and seat recline at a 2:1 ratio with no front seat rise
 - Back is lockable in six positions within tilt range
 - Seat and back move forward by rotating knob adjustment
 - Seat pitch is 7° and back pitch is 15° forward from standard pitch
 - Back reclines in the forward-tilt mode
 - Back tilts backward 16° from the upright position

Accolade Seating

General Specifications

COM & COL**General Information**

To order a COM fabric (Customer's Own Material), contact the Haworth Inquiry Center (1.800.426.8562), your local Haworth dealer, or go to haworth.com/surfaces > COM Library to find out if the COM you have selected has already been tested and approved. The surface collection site also has information on the Haworth+ alliance program with Carnegie, Luna Textiles, and Maharam as well as our industry-leading Pre-Approved COM program.

COM fabrics are placed into Grades based on the cost per linear yard. If a fabric's cost exceeds the range of our highest Grade it will be noted as Non-Graded. The product will be priced at Grade A; the COM fabric costs will appear as a separate line item. The fabric charge will be Haworth's purchase cost plus a 4% administrative fee (based on the cost of the fabric). Yardage calculations will include any applicable fabric repeat.

COM Leather products will be priced at a leather Grade A; COL costs will appear as a separate line item. The leather costs will be Haworth's purchase cost plus a 4% administrative fee (based on the cost of the leather).

Flammability Requirements

Accolade chair models are available with an optional fire retardant construction to comply with California Bulletin #133. Refer to the price pages for ordering information. Refer to Haworth.com/surfaces for a listing of the approved fabrics.

Environmental FactorsMaterial Off Gassing

In an effort to ensure air quality standards, all Accolade parts suppliers are required to provide Material Data Sheets and/or other documentation, verifying that their products do not emit volatile organic compounds (VOCs). In addition, the powder-coat paint process used in the manufacturing of Accolade seating is free of VOCs. Our manufacturing processes have also eliminated all use of chlorofluorocarbons (CFCs) and ozone depleting chemicals (ODCs) in the chair's construction.

Recycling

All fabric scraps are recycled, reducing the amount of material sent to landfills, and all chair components disassemble easily to increase the potential for recycling. In addition, Accolade's inner seat shell is constructed of 100% reprocessed polypropylene, and all raw materials used in its manufacturing can be recycled at the end of the useful life of the product.

Accolade Seating

General Specifications

General Guidelines for Product Specification

Accolade seating specification numbers are based on an alpha-numeric logic that identifies a product by model and certain characteristics.

For example, a product number that reads **A871-2142** identifies the product as an Accolade high-back chair fabric upholstery, pneumatic seat height adjustment, fully-upholstered shells, and hard dual-wheel casters.

The alpha-numeric logic for this model complete with fabric and finish codes is shown below:

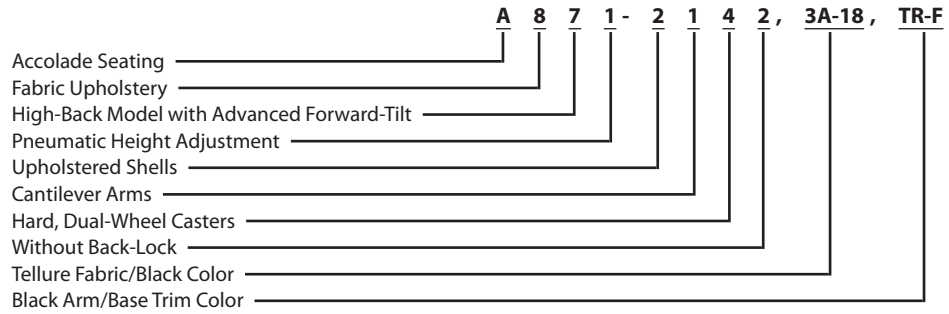

Replace second digit in product number with 7 for leather. Example: **A771-2142**.

A ninth digit suffix of the product number will indicate functional options, such as **-F** for CAL 133 option. There are exceptions to this logic; therefore, always refer to the price charts for product numbers rather than attempting to construct them. Product number modification instructions for additional options appear in footnoted copy for each applicable model.

Beyond the printed product number, fabric and finish codes are required to complete an order specification. To communicate your order clearly, list the product number and fabric/finish codes in the sequence outlined on each price page.

RUSH

Select Accolade seating models are marked with a **■** symbol to denote availability on the RUSH program. Refer to the fabric and finish options for each product.

Finishes and Fabrics

A complete listing of finishes and fabrics for Accolade seating can be found in the back of the price list.

Accolade Seating

High-Back Chair with Cantilever Arms

Synchronized-Tilt



A871-1142

Dimensions

SH: 16" - 21"*
(406mm-533mm)
H: 37 1/4" - 43 3/4"
(946mm-1111mm)
D: 24"(610mm)
W: 26 1/2"(673mm)
SW: 22 1/2"(572mm)
SD: 17"(432mm)
AH: 7.8"(198mm)

Forward seat pitch:
Standard forward tilt: 7°

*Some models may vary.

Standard forward tilt:
SH: 17 1/2" - 22"
(445mm-559mm)

Features

- Outer Shells: Polypropylene or upholstered.
- Arms: Standard, upholstered fabric or black vinyl arm caps.
- Base: Standard plastic base or optional steel base.
- Casters: Standard with hard casters; or optional soft casters.
- Mechanism: Swivel with synchronized-tilt.
- Height Adjustment: Pneumatic or pneumatic with low-position seat height option.
- Back height adjustment: 2 1/4"(57mm)
- Tilt tension.
- Fire retardant construction is available to comply with California Bulletin #133.
- COM yardage / COL square footage: Polypropylene shell: 2.0/40
Upholstered shell: 2.35/47

Available on RUSH with hard casters.

To Order, Specify:

- 1) Product number.
(NOTE: For leather upholstery, see below.)
- 2) Fabric surface and color.
- 3) Trim color for shell
(if applicable), arms and base.

Shells	Arms/Caps	Number	Fabric Grade		C	D	E	F	G	H	Leather Grade A	Leather Grade B
			A	B								
Pneumatic Height Adjustment												
Polypropylene	Standard	A871-1142	\$1456.99	\$1534.98	\$1615.44	\$1656.30	\$1692.19	\$1817.21	\$1892.73	\$2105.65	\$2134.11	\$2320.11
	Upholstered	A871-1242	1580.78	1658.77	1739.23	1780.09	1815.98	1941.00	2016.52	2229.44	2257.90	2443.90
	Upholstered Black Vinyl	A871-1342	1580.78	1658.77	1739.23	1780.09	1815.98	1941.00	2016.52	2229.44	2257.90	2443.90
Upholstered	Standard	A871-2142	\$1693.43	\$1792.46	\$1896.45	\$1950.91	\$1997.95	\$2156.41	\$2355.43	\$2527.77	\$2600.81	\$2802.99
	Upholstered	A871-2242	1817.22	1916.25	2020.24	2074.70	2121.74	2280.20	2379.22	2651.56	2724.60	2926.78
	Upholstered Black Vinyl	A871-2342	1817.22	1916.25	2020.24	2074.70	2121.74	2280.20	2379.22	2651.56	2724.60	2926.78
Pneumatic Height Adjustment/Back-Lock												
Polypropylene	Standard	A871-1141	\$1562.22	\$1640.21	\$1720.67	\$1761.53	\$1797.42	\$1922.44	\$1997.96	\$2210.88	\$2239.34	\$2425.34
	Upholstered	A871-1241	1686.01	1764.00	1844.46	1885.32	1921.21	2046.23	2121.75	2334.67	2363.13	2549.13
	Upholstered Black Vinyl	A871-1341	1686.01	1764.00	1844.46	1885.32	1921.21	2046.23	2121.75	2334.67	2363.13	2549.13
Upholstered	Standard	A871-2141	\$1798.66	\$1897.69	\$2001.68	\$2056.14	\$2103.18	\$2261.64	\$2360.66	\$2633.00	\$2706.04	\$2908.22
	Upholstered	A871-2241	1922.45	2021.48	2125.47	2179.93	2226.97	2385.43	2484.45	2756.79	2829.83	3032.01
	Upholstered Black Vinyl	A871-2341	1922.45	2021.48	2125.47	2179.93	2226.97	2385.43	2484.45	2756.79	2829.83	3032.01
Pneumatic Height Adjustment/Standard Forward-Tilt (Seat Height: 17 1/2"-22"(445mm-559mm))												
Polypropylene	Standard	A886-1142	\$1713.24	\$1791.23	\$1871.69	\$1912.55	\$1948.44	\$2073.46	\$2148.98	\$2361.90	\$2390.36	\$2576.36
	Upholstered	A886-1242	1837.03	1915.02	1995.48	2036.34	2072.23	2197.25	2272.77	2485.69	2514.15	2700.15
	Upholstered Black Vinyl	A886-1342	1837.03	1915.02	1995.48	2036.34	2072.23	2197.25	2272.77	2485.69	2514.15	2700.15
Upholstered	Standard	A886-2142	\$1949.68	\$2048.71	\$2152.70	\$2207.16	\$2254.20	\$2412.66	\$2511.68	\$2784.02	\$2857.06	\$3059.24
	Upholstered	A886-2242	2073.47	2172.50	2276.49	2330.95	2377.99	2536.45	2635.47	2907.81	2980.85	3183.03
	Upholstered Black Vinyl	A886-2342	2073.47	2172.50	2276.49	2330.95	2377.99	2536.45	2635.47	2907.81	2980.85	3183.03
Pneumatic Height Adjustment/Standard Forward-Tilt/Back-Lock (Seat Height: 17 1/2"-22"(445mm-559mm))												
Polypropylene	Standard	A886-1141	\$1818.47	\$1896.46	\$1976.92	\$2017.78	\$2053.67	\$2178.69	\$2254.21	\$2467.13	\$2495.59	\$2681.59
	Upholstered	A886-1241	1942.26	2020.25	2100.71	2141.57	2177.46	2302.48	2378.00	2590.92	2619.38	2805.38
	Upholstered Black Vinyl	A886-1341	1942.26	2020.25	2100.71	2141.57	2177.46	2302.48	2378.00	2590.92	2619.38	2805.38
Upholstered	Standard	A886-2141	\$2054.91	\$2153.94	\$2257.93	\$2312.39	\$2359.43	\$2517.89	\$2616.91	\$2889.25	\$2962.29	\$3164.47
	Upholstered	A886-2241	2178.70	2277.73	2381.72	2436.18	2483.22	2641.68	2740.70	3013.04	3086.08	3288.26
	Upholstered Black Vinyl	A886-2341	2178.70	2277.73	2381.72	2436.18	2483.22	2641.68	2740.70	3013.04	3086.08	3288.26

The following options require modification of the product number.

- Low-position seat height - Plastic
- Steel base - Standard height
- Steel base - Low height
- Soft casters
- CAL 133
- Leather Upholstery

- To specify, change the 4th digit from a 1 to a 4; **Example:** A874-1142
- To specify, change the 4th digit from a 1 to a 6; **Example:** A876-1142
- To specify, change the 4th digit from a 1 to a 7; **Example:** A877-1142
- To specify, change the 7th digit from a 4 to a 2; **Example:** A871-1122
- To specify, add -F to the product number; **Example:** A871-1142-F (add \$120.08 list)
- To specify, change the 2nd digit from an 8 to a 7 and specify the leather surface and color; **Examples:** A871-1142 = chair with fabric; A771-1142 = chair with leather

NOTE: Forward tilt available on steel base only, models: A746, A786, A846, A886.

Low-position seat height - plastic is not available on chairs with forward tilt.

Accolade Seating

High-Back Chair without Arms

Synchronized-Tilt



A871-1042

Dimensions

SH: 16" - 21"*
(406mm-533mm)
H: 37 1/4" - 43 3/4"
(946mm-1111mm)
D: 24"(610mm)
W: 26 1/2"(673mm)
SW: 22 1/2"(572mm)
SD: 17"(432mm)

Forward seat pitch:
Standard forward tilt: 7°
Advanced forward tilt: 5°

*Some models may vary.

Standard forward tilt:

SH: 17 1/2" - 22"
(445mm-559mm)

Features

- Outer Shells: Polypropylene or upholstered.
- Base: Standard plastic base or optional steel base.
- Casters: Standard with hard casters; or optional soft casters, see below.
- Mechanism: Swivel with synchronized-tilt.
- Height Adjustment: Pneumatic or pneumatic with low-position seat height option.
- Back height adjustment: 2 1/4"(57mm).
- Tilt tension.
- Fire retardant construction is available to comply with California Bulletin #133, see below.
- COM yardage / COL square footage:
Polypropylene shell: 2.0/40
Upholstered shell: 2.35/47

To Order, Specify:

- 1) Product number.
(NOTE: For leather upholstery, see below.)
- 2) Fabric surface and color.
- 3) Trim color for shell
(if applicable) and base.

Shell	Number	Fabric Grade								Leather Grade A	Leather Grade B
		A	B	C	D	E	F	G	H		
Pneumatic Height Adjustment											
Polypropylene	A871-1042	\$1270.07	\$1348.06	\$1428.52	\$1469.38	\$1505.27	\$1630.29	\$1705.81	\$1918.73	\$1947.19	\$2133.19
Upholstered	A871-2042	1506.51	1605.54	1709.53	1763.99	1811.03	1969.49	2068.51	2340.85	2413.89	2616.07
Pneumatic Height Adjustment/Back-Lock											
Polypropylene	A871-1041	\$1375.30	\$1453.29	\$1533.75	\$1574.61	\$1610.50	\$1735.52	\$1811.04	\$2023.96	\$2052.42	\$2238.42
Upholstered	A871-2041	1611.74	1710.77	1814.76	1869.22	1916.26	2074.72	2173.74	2446.08	2519.12	2721.30
Pneumatic Height Adjustment/Standard Forward-Tilt (Seat Height: 17 1/2" - 22"(445mm-559mm))											
Polypropylene	A886-1042	\$1526.32	\$1604.31	\$1684.77	\$1725.63	\$1761.52	\$1886.54	\$1962.06	\$2174.98	\$2203.44	\$2389.44
Upholstered	A886-2042	1762.76	1861.79	1965.78	2020.24	2067.28	2225.74	2324.76	2597.10	2670.14	2872.32
Pneumatic Height Adjustment/Standard Forward-Tilt/Back-Lock (Seat Height: 17 1/2" - 22"(445mm-559mm))											
Polypropylene	A886-1041	\$1631.55	\$1709.54	\$1790.00	\$1830.86	\$1866.75	\$1991.77	\$2067.29	\$2280.21	\$2308.67	\$2494.67
Upholstered	A886-2041	1867.99	1967.02	2071.01	2125.47	2172.51	2330.97	2429.99	2702.33	2775.37	2977.55

The following options require modification of the product number.

- Low-position seat height - Plastic
- Steel base - Standard height
- Steel base - Low height
- Soft casters
- CAL 133
- Leather Upholstery

- To specify, change the 4th digit from a 1 to a 4; **Example:** A874-1042
- To specify, change the 4th digit from a 1 to a 6; **Example:** A876-1042
- To specify, change the 4th digit from a 1 to a 7; **Example:** A877-1042
- To specify, change the 7th digit from a 4 to a 2; **Example:** A871-1022
- To specify, add -F to the product number; **Example:** A871-1042-F (add \$120.08 list)
- To specify, change the 2nd digit from an 8 to a 7 and specify the leather surface and color; **Examples:** A871-1042 = chair with fabric; A771-1042 = chair with leather

NOTE: Forward tilt available on steel base only, models: A746, A786, A846, A886.

Low-position seat height - plastic is not available on chairs with forward tilt.

Accolade Seating

Mid-Back Chair with Cantilever Arms

Synchronized-Tilt



A831-1142

Dimensions

SH: 16" - 21"*
(406mm-533mm)
H: 33 3/4" - 40 1/4"
(857mm-1022mm)
D: 24"(610mm)
W: 24 1/2"(622mm)
SW: 20 1/2"(521mm)
SD: 16 1/2"(419mm)
AH: 7.8"(198mm)

Forward seat pitch:
Standard forward tilt: 7°

*Some models may vary.

Standard forward tilt:

SH: 17 1/2" - 22"
(445mm-559mm)

Features

- Outer Shells: Polypropylene or upholstered.
- Arms: Standard, upholstered fabric or black vinyl arm caps.
- Casters: Standard with hard casters; or optional soft casters.
- Mechanism: Swivel with synchronized-tilt.
- Height Adjustment: Pneumatic or pneumatic with low-position seat height option.
- Back height adjustment: 2 1/4"(57mm).
- Tilt tension.
- Fire retardant construction is available to comply with California Bulletin #133.
- COM yardage / COL square footage:
Polypropylene shell: 1.75/35
Upholstered shell: 2.25/45

Available on RUSH with hard casters.

To Order, Specify:

- 1) Product number.
(NOTE: For leather upholstery, see below.)
- 2) Fabric surface and color.
- 3) Trim color for shell
(if applicable), arms and base.

Shell	Arms/Caps	Number	Fabric Grade								Leather Grade A	Leather Grade B
			A	B	C	D	E	F	G	H		
Pneumatic Height Adjustment												
Polypropylene	Standard	A831-1142	\$1328.26	\$1406.25	\$1486.71	\$1527.57	\$1563.46	\$1688.48	\$1764.00	\$1976.92	\$2005.38	\$2191.38
	Upholstered	A831-1242	1452.05	1530.04	1610.50	1651.36	1687.25	1812.27	1887.79	2100.71	2129.17	2315.17
	Upholstered Black Vinyl	A831-1342	1452.05	1530.04	1610.50	1651.36	1687.25	1812.27	1887.79	2100.71	2129.17	2315.17
Upholstered	Standard	A831-2142	\$1564.70	\$1663.73	\$1767.72	\$1822.18	\$1869.22	\$2027.68	\$2126.70	\$2399.04	\$2472.08	\$2674.26
	Upholstered	A831-2242	1688.49	1787.52	1891.51	1945.97	1993.01	2151.47	2250.49	2522.83	2595.87	2798.05
	Upholstered Black Vinyl	A831-2342	1688.49	1787.52	1891.51	1945.97	1993.01	2151.47	2250.49	2522.83	2595.87	2798.05
Pneumatic Height Adjustment/Back-Lock												
Polypropylene	Standard	A831-1141	\$1433.49	\$1511.48	\$1591.94	\$1632.80	\$1668.69	\$1793.71	\$1869.23	\$2082.15	\$2110.61	\$2296.61
	Upholstered	A831-1241	1557.28	1635.27	1715.73	1756.59	1792.48	1917.50	1993.02	2205.94	2234.40	2420.40
	Upholstered Black Vinyl	A831-1341	1557.28	1635.27	1715.73	1756.59	1792.48	1917.50	1993.02	2205.94	2234.40	2420.40
Upholstered	Standard	A831-2141	\$1669.93	\$1768.96	\$1872.95	\$1927.41	\$1974.45	\$2132.91	\$2231.93	\$2504.27	\$2577.31	\$2779.49
	Upholstered	A831-2241	1793.72	1892.75	1996.74	2051.20	2098.24	2256.70	2355.72	2628.06	2701.10	2903.28
	Upholstered Black Vinyl	A831-2341	1793.72	1892.75	1996.74	2051.20	2098.24	2256.70	2355.72	2628.06	2701.10	2903.28
Pneumatic Height Adjustment/Standard Forward-Tilt (Seat Height: 17 1/2" - 22"(445mm-559mm))												
Polypropylene	Standard	A846-1142	\$1584.51	\$1662.50	\$1742.96	\$1783.82	\$1819.71	\$1944.73	\$2020.25	\$2233.17	\$2261.63	\$2447.63
	Upholstered	A846-1242	1708.30	1786.29	1866.75	1907.61	1943.50	2068.52	2144.04	2356.96	2385.42	2571.42
	Upholstered Black Vinyl	A846-1342	1708.30	1786.29	1866.75	1907.61	1943.50	2068.52	2144.04	2356.96	2385.42	2571.42
Upholstered	Standard	A846-2142	\$1820.95	\$1919.98	\$2023.97	\$2078.43	\$2125.47	\$2283.93	\$2382.95	\$2655.29	\$2728.33	\$2930.51
	Upholstered	A846-2242	1944.74	2043.77	2147.76	2202.22	2249.26	2407.72	2506.74	2779.08	2852.12	3054.30
	Upholstered Black Vinyl	A846-2342	1944.74	2043.77	2147.76	2202.22	2249.26	2407.72	2506.74	2779.08	2852.12	3054.30
Pneumatic Height Adjustment/Standard Forward-Tilt/Back-Lock (Seat Height: 17 1/2" - 22"(445mm-559mm))												
Polypropylene	Standard	A846-1141	\$1689.74	\$1767.73	\$1848.19	\$1889.05	\$1924.94	\$2049.96	\$2125.48	\$2338.40	\$2366.86	\$2552.86
	Upholstered	A846-1241	1813.53	1891.52	1971.98	2012.84	2048.73	2173.75	2249.27	2462.19	2490.65	2676.65
	Upholstered Black Vinyl	A846-1341	1813.53	1891.52	1971.98	2012.84	2048.73	2173.75	2249.27	2462.19	2490.65	2676.65
Upholstered	Standard	A846-2141	\$1926.18	\$2025.21	\$2129.20	\$2183.66	\$2230.70	\$2389.16	\$2488.18	\$2760.52	\$2833.56	\$3035.74
	Upholstered	A846-2241	2049.97	2149.00	2252.99	2307.45	2354.49	2512.95	2611.97	2884.31	2957.35	3159.53
	Upholstered Black Vinyl	A846-2341	2049.97	2149.00	2252.99	2307.45	2354.49	2512.95	2611.97	2884.31	2957.35	3159.53

The following options require modification of the product number.

- Low-position seat height - Plastic
- Steel base - Standard height
- Steel base - Low height
- Soft casters
- CAL 133
- Leather Upholstery

To specify, change the 4th digit from a 1 to a 4; **Example:** A834-1142

To specify, change the 4th digit from a 1 to a 6; **Example:** A836-1142

To specify, change the 4th digit from a 1 to a 7; **Example:** A837-1142

To specify, change the 7th digit from a 4 to a 2; **Example:** A831-1122

To specify, add **-F** to the product number; **Example:** A831-1142-F (add \$120.08 list)

To specify, change the 2nd digit from an 8 to a 7 and specify the leather surface and color; **Examples:** A831-1142 = chair with fabric; A731-1142 = chair with leather

NOTE: Forward tilt available on steel base only, models: A746, A786, A846, A886.

Low-position seat height - plastic is not available on chairs with forward tilt.

Accolade Seating

Mid-Back Chair without Arms

Synchronized-Tilt



A831-1042

Dimensions

SH: 16" - 21"*
(406mm-533mm)
H: 33 3/4" - 40 1/4"
(845mm-1022mm)
D: 24"(610mm)
W: 24 1/2"(622mm)
SW: 20 1/2"(521mm)
SD: 16 1/2"(419mm)

Forward seat pitch:
Standard forward tilt: 7°

*Some models may vary.

Standard forward tilt:
SH: 17 1/2" - 22"
(445mm-559mm)

Features

- Outer Shells: Polypropylene or upholstered.
- Casters: Standard with hard casters; or optional soft casters, see below.
- Mechanism: Swivel with synchronized-tilt.
- Height Adjustment: Pneumatic or pneumatic with low-position seat height option.
- Back height adjustment: 2 1/4"(57mm).
- Tilt tension.
- Fire retardant construction is available to comply with California Bulletin #133, see below.
- COM yardage / COL square footage: Polypropylene shell: 1.75/35
Upholstered shell: 2.25/45

■ Available on RUSH with hard casters.

To Order, Specify:

- 1) Product number.
(NOTE: For leather upholstery, see below.)
- 2) Fabric surface and color.
- 3) Trim color for shell
(if applicable), and base.

Shell	Number	Fabric Grade								Leather Grade A	Leather Grade B
		A	B	C	D	E	F	G	H		
Pneumatic Height Adjustment											
Polypropylene	A831-1042 ■	\$1141.34	\$1219.33	\$1299.79	\$1340.65	\$1376.54	\$1501.56	\$1577.08	\$1790.00	\$1818.46	\$2004.46
Upholstered	A831-2042 ■	1377.78	1476.81	1580.80	1635.26	1682.30	1840.76	1939.78	2212.12	2285.16	2487.34
Pneumatic Height Adjustment/Back-Lock											
Polypropylene	A831-1041 ■	\$1246.57	\$1324.56	\$1405.02	\$1445.88	\$1481.77	\$1606.79	\$1682.31	\$1895.23	\$1923.69	\$2109.69
Upholstered	A831-2041 ■	1483.01	1582.04	1686.03	1740.49	1787.53	1945.99	2045.01	2317.35	2390.39	2592.57
Pneumatic Height Adjustment/Standard Forward-Tilt (Seat Height: 17 1/2" - 22"(445mm-559mm))											
Polypropylene	A846-1042	\$1397.59	\$1475.58	\$1556.04	\$1596.90	\$1632.79	\$1757.81	\$1833.33	\$2046.25	\$2074.71	\$2260.71
Upholstered	A846-2042	1634.03	1733.06	1837.05	1891.51	1938.55	2097.01	2196.03	2468.37	2541.41	2743.59
Pneumatic Height Adjustment/Standard Forward-Tilt/Back-Lock (Seat Height: 17 1/2" - 22"(445mm-559mm))											
Polypropylene	A846-1041	\$1502.82	\$1580.81	\$1661.27	\$1702.13	\$1738.02	\$1863.04	\$1938.56	\$2151.48	\$2179.94	\$2365.94
Upholstered	A846-2041	1739.26	1838.29	1942.28	1996.74	2043.78	2202.24	2301.26	2573.60	2646.64	2848.82

The following options require modification of the product number.

- Low-position seat height - Plastic
- Steel base - Standard height
- Steel base - Low height
- Soft casters
- CAL 133
- Leather Upholstery

To specify, change the 4th digit from a 1 to a 4; **Example:** A834-1042

To specify, change the 4th digit from a 1 to a 6; **Example:** A836-1042

To specify, change the 4th digit from a 1 to a 7; **Example:** A837-1042

To specify, change the 7th digit from a 4 to a 2; **Example:** A831-1022

To specify, add -F to the product number; **Example:** A831-1042-F (add \$120.08 list)

To specify, change the 2nd digit from an 8 to a 7 and specify the leather surface and color; **Examples:** A831-1042 = chair with fabric; A731-1042 = chair with leather

NOTE: Forward tilt available on steel base only, models: A746, A786, A846, A886.

Low-position seat height - plastic is not available on chairs with forward tilt.

Accolade Seating

Sled-Base Side Chair

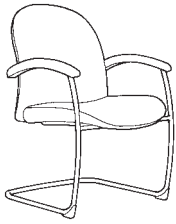

A802-3110

Dimensions

SH: 18 1/2"(470mm)
 H: 36 1/4"(921mm)
 D: 27"(686mm)
 W: 24"(610mm)
 SW: 20 1/2"(521mm)
 SD: 16 1/2"(419mm)
 AH: 26"(660mm)

Features

- Outer Shells: Polypropylene or upholstered.
 - Arms: Black polypropylene, upholstered fabric or black vinyl arm caps.
 - Black glides only.
 - COM yardage / COL square footage:
 Polypropylene shell: 2.0/40
 Upholstered shell: 2.25/45
- Available on RUSH.

To Order, Specify:

- 1) Product number.
(NOTE: For leather upholstery, see below.)
- 2) Fabric surface and color.
- 3) Trim color for shell
(if applicable), arms and base.

Leather Upholstery

Leather upholstery requires modification of the product number. Change the second digit from a **8** to **7** and specify the leather surface and color.

Examples: A802-3110 = chair with fabric;
 A702-3110 = chair with leather

Shell	Arms/Caps	Number	Fabric Grade								Leather Grade A	Leather Grade B
			A	B	C	D	E	F	G	H		
Polypropylene	Black Polypropylene	A802-3110 ■	\$ 943.27	\$1021.26	\$1101.72	\$1142.58	\$1178.47	\$1354.26	\$1442.14	\$1686.01	\$1620.39	\$1806.39
	Upholstered	A802-3210 ■	1067.06	1145.05	1225.51	1266.37	1302.26	1478.05	1565.93	1809.80	1744.18	1930.18
	Upholstered Black Vinyl	A802-3310 ■	1067.06	1145.05	1225.51	1266.37	1302.26	1478.05	1565.93	1809.80	1744.18	1930.18
Upholstered	Black Polypropylene	A802-4110 ■	\$1178.47	\$1277.50	\$1381.49	\$1435.95	\$1482.99	\$1641.45	\$1740.47	\$2012.81	\$2087.09	\$2289.27
	Upholstered	A802-4210 ■	1302.26	1401.29	1505.28	1559.74	1606.78	1765.24	1864.26	2136.60	2210.88	2413.06
	Upholstered Black Vinyl	A802-4310 ■	1302.26	1401.29	1505.28	1559.74	1606.78	1765.24	1864.26	2136.60	2210.88	2413.06

This page intentionally blank

Monaco

General Specifications

Design: 5D Studio

Features and Options

All Monaco models feature:

- Optional large or medium scales
- Fully-upholstered seat and back
- Five-star base
- Pneumatic height adjustment with 6-position back lock
- 3"(76mm) back height adjustment
- Optional adjustable lumbar support — 1 1/2"(38mm)

Mobility and Adjustability

Five-star base models feature:

- Cast aluminum base
- Molded-polyfoam contoured seat and back cushions
- Cast aluminum arms
- Hard, dual-wheel casters for carpeted floors
- Soft, dual-wheel casters for resilient floor surfaces
- Pneumatic height adjustment
- Synchronized tilt recline with tension control and 6-position back lock

Synchronized tilt

- Back reclines at a two-to-one ratio to the pitch of the seat
- Front-edge seat height maintained through tilt mode
- Lockable in six positions within the tilt range (back lock)

Value Packs

Monaco chairs are offered in 6, 8 and 10-Chair "Value Packs" for your convenience. Value packs allow you to order one part number for your entire conference room. Value packs are offered at a reduced list price.



6-Chair Value Pack for Monaco Large High-Back Chairs

Monaco

General Specifications

COM & COL General Information

To order a COM fabric (Customer's Own Material), contact the Haworth Inquiry Center (1.800.426.8562), your local Haworth dealer, or go to haworth.com/surfaces > COM Library to find out if the COM you have selected has already been tested and approved. The surface collection site also has information on the Haworth+ alliance program with Carnegie, Luna Textiles, and Maharam as well as our industry-leading Pre-Approved COM program.

COM fabrics are placed into Grades based on the cost per linear yard. If a fabric's cost exceeds the range of our highest Grade it will be noted as Non-Graded. The product will be priced at Grade A; the COM fabric costs will appear as a separate line item. The fabric charge will be Haworth's purchase cost plus a 4% administrative fee (based on the cost of the fabric). Yardage calculations will include any applicable fabric repeat.

COM Leather products will be priced at a leather Grade A; COL costs will appear as a separate line item. The leather costs will be Haworth's purchase cost plus a 4% administrative fee (based on the cost of the leather).

Flammability Requirements

Monaco chair models are available with an optional fire retardant construction to comply with California Bulletin #133. Refer to the price pages for ordering information. Refer to Haworth.com/surfaces for a listing of the approved fabrics.

General Guidelines for Product Specification

Monaco specification numbers are based on a numeric logic that identifies a product by model and certain characteristics.

For instance, a product number that reads **D811-2240** identifies the product as a Large High-Back Monaco Chair, with fabric upholstery, pneumatic height adjustment, open arms, hard casters, and without lumbar adjustment.

The numeric logic for this model with fabric and finish codes is shown below:

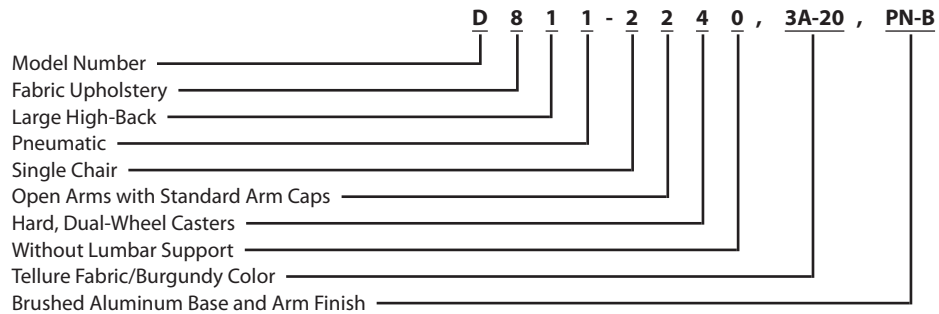

A ninth-digit suffix of the product number will indicate functional options, such as **-F** for CAL 133 option. There are exceptions to this logic; therefore, always refer to the price charts for product numbers rather than attempting to construct them. Product number modification instructions for additional options appear in footnoted copy for each applicable model.

Beyond the printed product number, fabric and finish codes are required to complete an order specification. To communicate your order clearly, list the product number and finish codes in the sequence outlined on each price page.

RUSH

Select Monaco seating models are marked with a  symbol to denote availability on the RUSH program. Refer to the fabric and finish options for each product.

Finishes and Fabrics

A complete listing of finishes and fabrics for Monaco seating is available in the back of the price list.

Monaco

Large High-Back Chair with Open Arms



D811-2240

Dimensions

SH: 16" - 20 1/2"
(406mm-521mm)
H: 48 1/2" - 56"
(1232mm-1422mm)
D: 26"(660mm)
W: 30"(762mm)
SW: 23 1/2"(597mm)
SD: 21 1/2"(546mm)
AH: 26 1/3" - 31 1/3"
(577mm-689mm)

Features

- Pneumatic height adjustment.
- Flexible headrest.
- Fully-upholstered shell.
- Standard with 6-position back lock.
- Five-star, cast aluminum base with dual-wheel casters.
- Casters and column standard in black finish color.
- Arms available with standard black soft or upholstered caps.
- Standard with 3"(76mm) of back height adjustment.
- COM yardage: 4.0
- COL square footage: 72.0
- Available on RUSH.

To Order, Specify:

- 1) Product number.
- 2) Fabric surface and color.
- 3) Base and arm trim color. Add **\$84.66** for Brushed Aluminum (PN-B) finish.

Leather Upholstery

Leather upholstery requires modification of the product number. Change the second digit in the product number from **8** to **7** and specify the leather surface and color.

Examples: D811-2240 = chair with fabric;
D711-2240 = chair with leather

NOTE:

CAD symbol for Value Packs shows one chair but represents quantity of chairs within Value Pack.

Arms/ Caps	Quantity	Number	Fabric Grade		C	D	E	F	G	H	Leather Grade A	Leather Grade B
			A	B								
Without Lumbar Support - Standard												
	1 chair	D811-2240 ■	\$ 3114.44	\$ 3225.32	\$ 3293.29	\$ 3472.15	\$ 3552.03	\$ 3889.47	\$ 4055.20	\$ 4515.46	\$ 4417.68	\$ 4968.22
	6-chair Value Pack	D811-A240	17571.77	18237.05	18644.87	19718.03	20197.31	22221.95	23216.33	25977.89	25391.21	28694.45
	8-chair Value Pack	D811-B240	23422.67	24309.71	24853.47	26284.35	26923.39	29622.91	30948.75	34630.83	33848.59	38252.91
	10-chair Value Pack	D811-C240	29606.24	30715.04	31394.74	33183.34	33982.14	37356.54	39013.84	43616.44	42638.64	48144.04
Without Lumbar Support - Upholstered												
	1 chair	D811-2340 ■	\$ 3190.74	\$ 3301.62	\$ 3369.59	\$ 3548.45	\$ 3628.33	\$ 3965.77	\$ 4131.50	\$ 4591.76	\$ 4493.98	\$ 5044.52
	6-chair Value Pack	D811-A340	18029.57	18694.85	19102.67	20175.83	20655.11	22679.75	23674.13	26435.69	25849.01	29152.25
	8-chair Value Pack	D811-B340	24033.07	24920.11	25463.87	26894.75	27533.79	30233.31	31559.15	35241.23	34458.99	38863.31
	10-chair Value Pack	D811-C340	30369.24	31478.04	32157.74	33946.34	34745.14	38119.54	39776.84	44379.44	43401.64	48907.04
With Lumbar Support - Standard												
	1 chair	D811-2241 ■	\$ 3296.88	\$ 3407.76	\$ 3475.73	\$ 3654.59	\$ 3734.47	\$ 4071.91	\$ 4237.64	\$ 4697.90	\$ 4600.12	\$ 5150.66
	6-chair Value Pack	D811-A241	18666.41	19331.69	19739.51	20812.67	21291.95	23316.59	24310.97	27072.53	25391.21	28694.45
	8-chair Value Pack	D811-B241	24882.19	25769.23	26312.99	27743.87	28382.91	31082.43	32408.27	36090.35	35308.11	39712.43
	10-chair Value Pack	D811-C241	31430.64	32539.44	33219.14	35007.74	35806.54	39180.94	40838.24	45440.84	44463.04	49968.44
With Lumbar Support - Upholstered												
	1 chair	D811-2341 ■	\$ 3373.18	\$ 3484.06	\$ 3552.03	\$ 3730.89	\$ 3810.77	\$ 4148.21	\$ 4313.94	\$ 4774.20	\$ 4676.42	\$ 5226.96
	6-chair Value Pack	D811-A341	19124.21	19789.49	20197.31	21270.47	21749.75	23774.39	24768.77	27530.33	26943.65	30246.89
	8-chair Value Pack	D811-B341	25492.59	26379.63	26923.39	28354.27	28993.31	31692.83	33018.67	36700.75	35918.51	40322.83
	10-chair Value Pack	D811-C341	32193.64	33302.44	33982.14	35770.74	36569.54	39943.94	41601.24	46203.84	45226.04	50731.44

Soft Caster Option

Soft caster option requires modification of the product number. Change the seventh digit in the product number from **4** to **2**.

Examples: D811-2240 = chair with hard casters;
D811-2220 = chair with soft casters

CAL 133 Option

CAL 133 option is available on all chair models in leather. To specify, add **-F** to the product number and add **\$606.90** list.

Stain Repellent Option

To specify, add **-P** to end of the product number and add **\$61.99** list.

Example: D811-2240-P

NOTE: Stain repellent is not available on leather.

For available fabrics, refer to surfaces.haworth.com.

Monaco

Large High-Back Chair with Enclosed Arms



D811-2640

Dimensions

SH: 16" - 20 1/2"
(406mm-521mm)
H: 48 1/2" - 56"
(1232mm-1422mm)
D: 26"(660mm)
W: 30"(762mm)
SW: 23 1/2"(597mm)
SD: 21 1/2"(546mm)
AH: 26 1/3" - 31 1/3"
(577mm-689mm)

Features

- Pneumatic height adjustment.
 - Flexible headrest.
 - Fully-upholstered shell.
 - Standard with 6-position back lock.
 - Five-star, cast aluminum base with dual-wheel casters.
 - Casters and column standard in black finish color.
 - Arms enclosed.
 - Standard with 3"(76mm) of back height adjustment.
 - COM yardage: 4.0
 - COL square footage: 72.0
- Available on RUSH.

To Order, Specify:

- 1) Product number.
- 2) Fabric surface and color.
- 3) Base trim color. Add **\$84.66** for Brushed Aluminum (PN-B) finish.

Leather Upholstery

Leather upholstery requires modification of the product number. Change the second digit in the product number from **8** to **7** and specify the leather surface and color.

Examples: D811-2640 = chair with fabric; D711-2640 = chair with leather

NOTE:

CAD symbol for Value Packs shows one chair but represents quantity of chairs within Value Pack.

Arms/ Caps	Quantity	Number	Fabric Grade		C	D	E	F	G	H	Leather Grade A	Leather Grade B
			A	B								
Without Lumbar Support - Standard												
	1 chair	D811-2640 ■	\$ 3114.44	\$ 3225.32	\$ 3293.29	\$ 3472.15	\$ 3552.03	\$ 3889.47	\$ 4055.20	\$ 4515.46	\$ 4417.68	\$ 4968.22
	6-chair Value Pack	D811-A640	17571.77	18237.05	18644.87	19718.03	20197.31	22221.95	23216.33	25977.89	25391.21	28694.45
	8-chair Value Pack	D811-B640	23422.67	24309.71	24853.47	26284.35	26923.39	29622.91	30948.75	34630.83	33848.59	38252.91
	10-chair Value Pack	D811-C640	29606.24	30715.04	31394.74	33183.34	33982.14	37356.54	39013.84	43616.44	42638.64	48144.04
With Lumbar Support - Standard												
	1 chair	D811-2641 ■	\$ 3296.88	\$ 3407.76	\$ 3475.73	\$ 3654.59	\$ 3734.47	\$ 4071.91	\$ 4237.64	\$ 4697.90	\$ 4600.12	\$ 5150.66
	6-chair Value Pack	D811-A641	18666.41	19331.69	19739.51	20812.67	21291.95	23316.59	24310.97	27072.53	26485.85	29789.09
	8-chair Value Pack	D811-B641	24882.19	25769.23	26312.99	27743.87	28382.91	31082.43	32408.27	36090.35	35308.11	39712.43
	10-chair Value Pack	D811-C641	31430.64	32539.44	33219.14	35007.74	35806.54	39180.94	40838.24	45440.84	44463.04	49968.44

Soft Caster Option

Soft caster option requires modification of the product number. Change the seventh digit in the product number from **4** to **2**.

Examples: D811-2640 = chair with hard casters; D811-2620 = chair with soft casters

CAL 133 Option

CAL 133 option is available on all chair models in leather. To specify, add **-F** to the product number and add **\$606.90** list.

Stain Repellent Option

To specify, add **-P** to end of the product number and add **\$61.99** list.

Example: D811-2640-P

NOTE: Stain repellent is not available on leather.

For available fabrics, refer to surfaces.haworth.com.

Monaco

Medium High-Back Chair with Open Arms



D821-2240

Dimensions

SH: 16" - 20 1/2"
(406mm-521mm)
H: 45" - 52 1/2"
(1143mm-1334mm)
D: 23 1/2"(597mm)
W: 26"(660mm)
SW: 22"(559mm)
SD: 20"(508mm)
AH: 26 1/3" - 31 1/3"
(577mm-689mm)

Features

- Pneumatic height adjustment.
- Flexible headrest.
- Fully-upholstered shell.
- Standard with 6-position back lock.
- Five-star, cast aluminum base with dual-wheel casters.
- Casters and column standard in black finish color.
- Arms available with standard black soft or upholstered caps.
- Standard with 3"(76mm) of back height adjustment.
- COM yardage: 3.75
- COL square footage: 67.5
- Available on RUSH.

To Order, Specify:

- 1) Product number.
- 2) Fabric surface and color.
- 3) Base and arm trim color. Add **\$84.66** for Brushed Aluminum (PN-B) finish.

Leather Upholstery

Leather upholstery requires modification of the product number. Change the second digit in the product number from **8** to **7** and specify the leather surface and color.

Examples: D821-2240 = chair with fabric;
D721-2240 = chair with leather

NOTE:

CAD symbol for Value Packs shows one chair but represents quantity of chairs within Value Pack.

Arms/ Caps	Quantity	Number	Fabric Grade		C	D	E	F	G	H	Leather Grade A	Leather Grade B
			A	B								
Without Lumbar Support - Standard												
	1 chair	D821-2240	\$ 3114.44	\$ 3225.32	\$ 3293.29	\$ 3472.15	\$ 3552.03	\$ 3889.47	\$ 4055.20	\$ 4515.46	\$ 4417.68	\$ 4968.22
	6-chair Value Pack	D821-A240	17571.77	18237.05	18644.87	19718.03	20197.31	22221.95	23216.33	25977.89	25391.21	28694.45
	8-chair Value Pack	D821-B240	23422.67	24309.71	24853.47	26284.35	26923.39	29622.91	30948.75	34630.83	33848.59	38252.91
	10-chair Value Pack	D821-C240	29606.24	30715.04	31394.74	33183.34	33982.14	37356.54	39013.84	43616.44	42638.64	48144.04
Without Lumbar Support - Upholstered												
	1 chair	D821-2340	\$ 3190.74	\$ 3301.62	\$ 3369.59	\$ 3548.45	\$ 3628.33	\$ 3965.77	\$ 4131.50	\$ 4591.76	\$ 4493.98	\$ 5044.52
	6-chair Value Pack	D821-A340	18029.57	18694.85	19102.67	20175.83	20655.11	22679.75	23674.13	26435.69	25849.01	29152.25
	8-chair Value Pack	D821-B340	24033.07	24920.11	25463.87	26894.75	27533.79	30233.31	31559.15	35241.23	34458.99	38863.31
	10-chair Value Pack	D821-C340	30369.24	31478.04	32157.74	33946.34	34745.14	38119.54	39776.84	44379.44	43401.64	48907.04
With Lumbar Support - Standard												
	1 chair	D821-2241	\$ 3296.88	\$ 3407.76	\$ 3475.73	\$ 3654.59	\$ 3734.47	\$ 4071.91	\$ 4237.64	\$ 4697.90	\$ 4600.12	\$ 5150.66
	6-chair Value Pack	D821-A241	18666.41	19331.69	19739.51	20812.67	21291.95	23316.59	24310.97	27072.53	26485.85	29789.09
	8-chair Value Pack	D821-B241	24882.19	25769.23	26312.99	27743.87	28382.91	31082.43	32408.27	36090.35	35308.11	39712.43
	10-chair Value Pack	D821-C241	31430.64	32539.44	33219.14	35007.74	35806.54	39180.94	40838.24	45440.84	44463.04	49968.44
With Lumbar Support - Upholstered												
	1 chair	D821-2341	\$ 3373.18	\$ 3484.06	\$ 3552.03	\$ 3730.89	\$ 3810.77	\$ 4148.21	\$ 4313.94	\$ 4774.20	\$ 4676.42	\$ 5226.96
	6-chair Value Pack	D821-A341	19124.21	19789.49	20197.31	21270.47	21749.75	23774.39	24768.77	27530.33	26943.65	30246.89
	8-chair Value Pack	D821-B341	25492.59	26379.63	26923.39	28354.27	28993.31	31692.83	33018.67	36700.75	35918.51	40322.83
	10-chair Value Pack	D821-C341	32193.64	33302.44	33982.14	35770.74	36569.54	39943.94	41601.24	46203.84	45226.04	50731.44

Soft Caster Option

Soft caster option requires modification of the product number. Change the seventh digit in the product number from **4** to **2**.

Examples: D821-2240 = chair with hard casters;
D821-2220 = chair with soft casters

CAL 133 Option

CAL 133 option is available on all chair models in leather. To specify, add **-F** to the product number and add **\$606.90** list.

Stain Repellent Option

To specify, add **-P** to end of the product number and add **\$61.99** list.

Example: D821-2240-P

NOTE: Stain repellent is not available on leather.

For available fabrics, refer to surfaces.haworth.com.

Monaco

Medium High-Back Chair with Enclosed Arms



D821-2640

Dimensions

SH: 16" - 20 1/2"
(406mm-521mm)
H: 45" - 52 1/2"
(1143mm-1334mm)
D: 23 1/2"(597mm)
W: 26"(660mm)
SW: 22"(559mm)
SD: 20"(508mm)
AH: 26 1/3" - 31 1/3"
(577mm-689mm)

Features

- Pneumatic height adjustment.
 - Flexible headrest.
 - Fully-upholstered shell.
 - Standard with 6-position back lock.
 - Five-star, cast aluminum base with dual-wheel casters.
 - Casters and column standard in black finish color.
 - Arms enclosed.
 - Standard with 3"(76mm) of back height adjustment.
 - COM yardage: 3.75
 - COL square footage: 67.5
- Available on RUSH.

To Order, Specify:

- 1) Product number.
- 2) Fabric surface and color.
- 3) Base trim color. Add **\$84.66** for Brushed Aluminum (PN-B) finish.

Leather Upholstery

Leather upholstery requires modification of the product number. Change the second digit in the product number from **8** to **7** and specify the leather surface and color.

Examples: D821-2640 = chair with fabric;
D721-2640 = chair with leather

NOTE:

CAD symbol for Value Packs shows one chair but represents quantity of chairs within Value Pack.

Arms/ Caps	Quantity	Number	Fabric Grade		C	D	E	F	G	H	Leather Grade A	Leather Grade B
			A	B								
Without Lumbar Support - Standard												
	1 chair	D821-2640 ■	\$ 3114.44	\$ 3225.32	\$ 3293.29	\$ 3472.15	\$ 3552.03	\$ 3889.47	\$ 4055.20	\$ 4515.46	\$ 4417.68	\$ 4968.22
	6-chair Value Pack	D821-A640	17571.77	18237.05	18644.87	19718.03	20197.31	22221.95	23216.33	25977.89	25391.21	28694.45
	8-chair Value Pack	D821-B640	23422.67	24309.71	24853.47	26284.35	26923.39	29622.91	30948.75	34630.83	33848.59	38252.91
	10-chair Value Pack	D821-C640	29606.24	30715.04	31394.74	33183.34	33982.14	37356.54	39013.84	43616.44	42638.64	48144.04
With Lumbar Support - Standard												
	1 chair	D821-2641 ■	\$ 3296.88	\$ 3407.76	\$ 3475.73	\$ 3654.59	\$ 3734.47	\$ 4071.91	\$ 4237.64	\$ 4697.90	\$ 4600.12	\$ 5150.66
	6-chair Value Pack	D821-A641	18666.41	19331.69	19739.51	20812.67	21291.95	23316.59	24310.97	27072.53	26485.85	29789.09
	8-chair Value Pack	D821-B641	24882.19	25769.23	26312.99	27743.87	28382.91	31082.43	32408.27	36090.35	35308.11	39712.43
	10-chair Value Pack	D821-C641	31430.64	32539.44	33219.14	35007.74	35806.54	39180.94	40838.24	45440.84	44463.04	49968.44

Soft Caster Option

Soft caster option requires modification of the product number. Change the seventh digit in the product number from **4** to **2**.

Examples: D821-2640 = chair with hard casters;
D821-2620 = chair with soft casters

CAL 133 Option

CAL 133 option is available on all chair models in leather. To specify, add **-F** to the product number and add **\$606.90** list.

Stain Repellent Option

To specify, add **-P** to end of the product number and add **\$61.99** list.

Example: D821-2640-P

NOTE: Stain repellent is not available on leather.

For available fabrics, refer to surfaces.haworth.com.

Monaco

Large Mid-Back Chair with Open Arms



D831-2240

NOTE:
CAD symbol for Value Packs shows one chair but represents quantity of chairs within Value Pack.

Dimensions

SH: 16" - 20 1/2"
(406mm-521mm)
H: 41 1/2" - 49 1/2"
(1054mm-1257mm)
D: 26"(660mm)
W: 30"(762mm)
SW: 23 1/2"(597mm)
SD: 21 1/2"(546mm)
AH: 26 1/3" - 31 1/3"
(577mm-689mm)

Features

- Pneumatic height adjustment.
 - Fully-upholstered shell.
 - Standard with 6-position back lock.
 - Five-star, cast aluminum base with dual-wheel casters.
 - Casters and column standard in black finish color.
 - Arms available with standard black soft or upholstered caps.
 - Standard with 3"(76mm) of back height adjustment.
 - COM yardage: 3.25
 - COL square footage: 58.5
- Available on RUSH.

To Order, Specify:

- 1) Product number.
- 2) Fabric surface and color.
- 3) Base and arm trim color. Add **\$84.66** for Brushed Aluminum (PN-B) finish.

Leather Upholstery

Leather upholstery requires modification of the product number. Change the second digit in the product number from **8** to **7** and specify the leather surface and color.
Examples: D831-2240 = chair with fabric; D731-2240 = chair with leather

Arms/ Caps	Quantity	Number	Fabric Grade								Leather Grade A	Leather Grade B
			A	B	C	D	E	F	G	H		
Without Lumbar Support - Standard												
	1 chair	D831-2240	\$ 2984.47	\$ 3085.82	\$ 3150.20	\$ 3314.74	\$ 3387.48	\$ 3614.03	\$ 3722.55	\$ 4123.17	\$ 4166.10	\$ 4707.76
	6-chair Value Pack	D831-A240	16791.95	17400.05	17786.33	18773.57	19210.01	20569.31	21220.43	23624.15	23881.73	27131.69
	8-chair Value Pack	D831-B240	22382.91	23193.71	23708.75	25025.07	25606.99	27419.39	28287.55	31492.51	31835.95	36169.23
	10-chair Value Pack	D831-C240	28306.54	29320.04	29963.84	31609.24	32336.64	34602.14	35687.34	39693.54	40122.84	45539.44
Without Lumbar Support - Upholstered												
	1 chair	D831-2340	\$ 3060.77	\$ 3162.12	\$ 3226.50	\$ 3391.04	\$ 3463.78	\$ 3690.33	\$ 3798.85	\$ 4199.47	\$ 4242.40	\$ 4784.06
	6-chair Value Pack	D831-A340	17249.75	17857.85	18244.13	19231.37	19667.81	21027.11	21678.23	24081.95	24339.53	27589.49
	8-chair Value Pack	D831-B340	22993.31	23804.11	24319.15	25635.47	26217.39	28029.79	28897.95	32102.91	32446.35	36779.63
	10-chair Value Pack	D831-C340	29069.54	30083.04	30726.84	32372.24	33099.64	35365.14	36450.34	40456.54	40885.84	46302.44
With Lumbar Support - Standard												
	1 chair	D831-2241	\$ 3166.91	\$ 3268.26	\$ 3332.64	\$ 3497.18	\$ 3569.92	\$ 3796.47	\$ 3904.99	\$ 4305.61	\$ 4348.54	\$ 4890.20
	6-chair Value Pack	D831-A241	17886.59	18494.69	18880.97	19868.21	20304.65	21663.95	22315.07	24718.79	24976.37	28226.33
	8-chair Value Pack	D831-B241	23842.43	24653.23	25168.27	26484.59	27066.51	28878.91	29747.07	32952.03	33295.47	37628.75
	10-chair Value Pack	D831-C241	30130.94	31144.44	31788.24	33433.64	34161.04	36426.54	37511.74	41517.94	41947.24	47363.84
With Lumbar Support - Upholstered												
	1 chair	D831-2341	\$ 3243.21	\$ 3344.56	\$ 3408.94	\$ 3573.48	\$ 3646.22	\$ 3872.77	\$ 3981.29	\$ 4381.91	\$ 4424.84	\$ 4966.06
	6-chair Value Pack	D831-A341	18344.39	18952.49	19338.77	20326.01	20762.45	22121.75	22772.87	25176.59	25434.17	28684.13
	8-chair Value Pack	D831-B341	24452.83	25263.63	25778.67	27094.99	27676.91	29489.31	30357.47	33562.43	33905.87	38239.15
	10-chair Value Pack	D831-C341	30893.94	31907.44	32551.24	34196.64	34924.04	37189.54	38274.74	42280.94	42710.24	48126.84

Soft Caster Option

Soft caster option requires modification of the product number. Change the seventh digit in the product number from **4** to **2**.

Examples: D831-2240 = chair with hard casters; D831-2220 = chair with soft casters

CAL 133 Option

CAL 133 option is available on all chair models in leather. To specify, add **-F** to the product number and add **\$606.90** list.

Stain Repellent Option

To specify, add **-P** to end of the product number and add **\$61.99** list.

Example: D831-2240-P

NOTE: Stain repellent is not available on leather.

For available fabrics, refer to surfaces.haworth.com.

Monaco

Large Mid-Back Chair with Enclosed Arms



D831-2640

Dimensions

SH: 16" - 20 1/2"
(406mm-521mm)
H: 41 1/2" - 49 1/2"
(1054mm-1257mm)
D: 26"(660mm)
W: 30"(762mm)
SW: 23 1/2"(597mm)
SD: 21 1/2"(546mm)
AH: 26 1/3" - 31 1/3"
(577mm-689mm)

Features

- Pneumatic height adjustment.
- Fully-upholstered shell.
- Standard with 6-position back lock.
- Five-star, cast aluminum base with dual-wheel casters.
- Casters and column standard in black finish color.
- Arms enclosed.
- Standard with 3"(76mm) of back height adjustment.
- COM yardage: 3.50
- COL square footage: 63.0
- Available on RUSH.

To Order, Specify:

- 1) Product number.
- 2) Fabric surface and color.
- 3) Base trim color. Add **\$84.66** for Brushed Aluminum (PN-B) finish.

Leather Upholstery

Leather upholstery requires modification of the product number. Change the second digit in the product number from **8** to **7** and specify the leather surface and color.

Examples: D831-2640 = chair with fabric; D731-2640 = chair with leather

NOTE:

CAD symbol for Value Packs shows one chair but represents quantity of chairs within Value Pack.

Arms/ Caps	Quantity	Number	Fabric Grade								Leather Grade A	Leather Grade B
			A	B	C	D	E	F	G	H		
Without Lumbar Support - Standard												
	1 chair	D831-2640 ■	\$ 2984.47	\$ 3085.82	\$ 3150.20	\$ 3314.74	\$ 3387.48	\$ 3614.03	\$ 3722.55	\$ 4123.17	\$ 4166.10	\$ 4707.76
	6-chair Value Pack	D831-A640	16791.95	17400.05	17786.33	18773.57	19210.01	20569.31	21220.43	23624.15	23881.73	27131.69
	8-chair Value Pack	D831-B640	22382.91	23193.71	23708.75	25025.07	25606.99	27419.39	28287.55	31492.51	31835.95	36169.23
	10-chair Value Pack	D831-C640	28306.54	29320.04	29963.84	31609.24	32336.64	34602.14	35687.34	39693.54	40122.84	45539.44
With Lumbar Support - Standard												
	1 chair	D831-2641 ■	\$ 3166.91	\$ 3268.26	\$ 3332.64	\$ 3497.18	\$ 3569.92	\$ 3796.47	\$ 3904.99	\$ 4305.61	\$ 4348.54	\$ 4890.20
	6-chair Value Pack	D831-A641	17886.59	18494.69	18880.97	19868.21	20304.65	21663.95	22315.07	24718.79	24976.37	28226.33
	8-chair Value Pack	D831-B641	23842.43	24653.23	25168.27	26484.59	27066.51	28878.91	29747.07	32952.03	33295.47	37628.75
	10-chair Value Pack	D831-C641	30130.94	31144.44	31788.24	33433.64	34161.04	36426.54	37511.74	41517.94	41947.24	47363.84

Soft Caster Option

Soft caster option requires modification of the product number. Change the seventh digit in the product number from **4** to **2**.

Examples: D831-2640 = chair with hard casters; D831-2620 = chair with soft casters

CAL 133 Option

CAL 133 option is available on all chair models in leather. To specify, add **-F** to the product number and add **\$606.90** list.

Stain Repellent Option

To specify, add **-P** to end of the product number and add **\$61.99** list.

Example: D831-2640-P

NOTE: Stain repellent is not available on leather.

For available fabrics, refer to surfaces.haworth.com.

Monaco

Medium Mid-Back Chair with Open Arms



D841-2240

NOTE:
CAD symbol for Value Packs shows one chair but represents quantity of chairs within Value Pack.

Dimensions

SH: 16" - 20 1/2"
(406mm-521mm)
H: 39" - 46 3/4"
(991mm-1187mm)
D: 23 1/2"(597mm)
W: 26"(660mm)
SW: 22"(559mm)
SD: 20"(508mm)
AH: 26 1/3" - 31 1/3"
(577mm-689mm)

Features

- Pneumatic height adjustment.
 - Fully-upholstered shell.
 - Standard with 6-position back lock.
 - Five-star, cast aluminum base with dual-wheel casters.
 - Casters and column standard in black finish color.
 - Arms available with standard black soft or upholstered caps.
 - Standard with 3"(76mm) of back height adjustment.
 - COM yardage: 3.00
 - COL square footage: 54.0
- Available on RUSH.

To Order, Specify:

- 1) Product number.
- 2) Fabric surface and color.
- 3) Base and arm trim color. Add **\$84.66** for Brushed Aluminum (PN-B) finish.

Leather Upholstery

Leather upholstery requires modification of the product number. Change the second digit in the product number from **8** to **7** and specify the leather surface and color.
Examples: D841-2240 = chair with fabric; D741-2240 = chair with leather

Arms/ Caps	Quantity	Number	Fabric Grade		C	D	E	F	G	H	Leather Grade A	Leather Grade B
			A	B								
Without Lumbar Support - Standard												
	1 chair	D841-2240	\$ 2984.47	\$ 3085.82	\$ 3150.20	\$ 3314.74	\$ 3387.48	\$ 3614.03	\$ 3722.55	\$ 4123.17	\$ 4166.10	\$ 4707.76
	6-chair Value Pack	D841-A240	16791.95	17400.05	17786.33	18773.57	19210.01	20569.31	21220.43	23624.15	23881.73	27131.69
	8-chair Value Pack	D841-B240	22382.91	23193.71	23708.75	25025.07	25606.99	27419.39	28287.55	31492.51	31835.95	36169.23
	10-chair Value Pack	D841-C240	28306.54	29320.04	29963.84	31609.24	32336.64	34602.14	35687.34	39693.54	40122.84	45539.44
Without Lumbar Support - Upholstered												
	1 chair	D841-2340	\$ 3060.77	\$ 3162.12	\$ 3226.50	\$ 3391.04	\$ 3463.78	\$ 3690.33	\$ 3798.85	\$ 4199.47	\$ 4242.40	\$ 4784.06
	6-chair Value Pack	D841-A340	17249.75	17857.85	18244.13	19231.37	19667.81	21027.11	21678.23	24081.95	24339.53	27589.49
	8-chair Value Pack	D841-B340	22993.31	23804.11	24319.15	25635.47	26217.39	28029.79	28897.95	32102.91	32446.35	36779.63
	10-chair Value Pack	D841-C340	29069.54	30083.04	30726.84	32372.24	33099.64	35365.14	36450.34	40456.54	40885.84	46302.44
With Lumbar Support - Standard												
	1 chair	D841-2241	\$ 3166.91	\$ 3268.26	\$ 3332.64	\$ 3497.18	\$ 3569.92	\$ 3796.47	\$ 3904.99	\$ 4305.61	\$ 4348.54	\$ 4890.20
	6-chair Value Pack	D841-A241	17886.59	18494.69	18880.97	19868.21	20304.65	21663.95	22315.07	24718.79	24976.37	28226.33
	8-chair Value Pack	D841-B241	23842.43	24653.23	25168.27	26484.59	27066.51	28878.91	29747.07	32952.03	33295.47	37628.75
	10-chair Value Pack	D841-C241	30130.94	31144.44	31788.24	33433.64	34161.04	36426.54	37511.74	41517.94	41947.24	47363.84
With Lumbar Support - Upholstered												
	1 chair	D841-2341	\$ 3243.21	\$ 3344.56	\$ 3408.94	\$ 3573.48	\$ 3646.22	\$ 3872.77	\$ 3981.29	\$ 4381.91	\$ 4424.84	\$ 4966.06
	6-chair Value Pack	D841-A341	18344.39	18952.49	19338.77	20326.01	20762.45	22121.75	22772.87	25176.59	25434.17	28684.13
	8-chair Value Pack	D841-B341	24452.83	25263.63	25778.67	27094.99	27676.91	29489.31	30357.47	33562.43	33905.87	38239.15
	10-chair Value Pack	D841-C341	30893.94	31907.44	32551.24	34196.64	34924.04	37189.54	38274.74	42280.94	42710.24	48126.84

Soft Caster Option

Soft caster option requires modification of the product number. Change the seventh digit in the product number from **4** to **2**.

Examples: D841-2240 = chair with hard casters; D841-2220 = chair with soft casters

CAL 133 Option

CAL 133 option is available on all chair models in leather. To specify, add **-F** to the product number and add **\$606.90** list.

Stain Repellent Option

To specify, add **-P** to end of the product number and add **\$61.99** list.

Example: D841-2240-P

NOTE: Stain repellent is not available on leather.

For available fabrics, refer to surfaces.haworth.com.

Monaco

Medium Mid-Back Chair with Enclosed Arms



D841-2640

Dimensions

SH: 16" - 20 1/2"
(406mm-521mm)
H: 39" - 46 3/4"
(991mm-1187mm)
D: 23 1/2"(597mm)
W: 26"(660mm)
SW: 22"(559mm)
SD: 20"(508mm)
AH: 26 1/3" - 31 1/3"
(577mm-689mm)

Features

- Pneumatic height adjustment.
- Fully-upholstered shell.
- Standard with 6-position back lock.
- Five-star, cast aluminum base with dual-wheel casters.
- Casters and column standard in black finish color.
- Arms enclosed.
- Standard with 3"(76mm) of back height adjustment.
- COM yardage: 3.25
- COL square footage: 58.5
- Available on RUSH.

To Order, Specify:

- 1) Product number.
- 2) Fabric surface and color.
- 3) Base trim color. Add **\$84.66** for Brushed Aluminum (PN-B) finish.

Leather Upholstery

Leather upholstery requires modification of the product number. Change the second digit in the product number from **8** to **7** and specify the leather surface and color.

Examples: D841-2640 = chair with fabric;
D741-2640 = chair with leather

NOTE:

CAD symbol for Value Packs shows one chair but represents quantity of chairs within Value Pack.

Arms/ Caps	Quantity	Number	Fabric Grade								Leather Grade A	Leather Grade B
			A	B	C	D	E	F	G	H		
Without Lumbar Support - Standard												
	1 chair	D841-2640 ■	\$ 2984.47	\$ 3085.82	\$ 3150.20	\$ 3314.74	\$ 3387.48	\$ 3614.03	\$ 3722.55	\$ 4123.17	\$ 4166.10	\$ 4707.76
	6-chair Value Pack	D841-A640	16791.95	17400.05	17786.33	18773.57	19210.01	20569.31	21220.43	23624.15	23881.73	27131.69
	8-chair Value Pack	D841-B640	22382.91	23193.71	23708.75	25025.07	25606.99	27419.39	28287.55	31492.51	31835.95	36169.23
	10-chair Value Pack	D841-C640	28306.54	29320.04	29963.84	31609.24	32336.64	34602.14	35687.34	39693.54	40122.84	45539.44
With Lumbar Support - Standard												
	1 chair	D841-2641 ■	\$ 3166.91	\$ 3268.26	\$ 3332.64	\$ 3497.18	\$ 3569.92	\$ 3796.47	\$ 3904.99	\$ 4305.61	\$ 4348.54	\$ 4890.20
	6-chair Value Pack	D841-A641	17886.59	18494.69	18880.97	19868.21	20304.65	21663.95	22315.07	24718.79	24976.37	28226.33
	8-chair Value Pack	D841-B641	23842.43	24653.23	25168.27	26484.59	27066.51	28878.91	29747.07	32952.03	33295.47	37628.75
	10-chair Value Pack	D841-C641	30130.94	31144.44	31788.24	33433.64	34161.04	36426.54	37511.74	41517.94	41947.24	47363.84

Soft Caster Option

Soft caster option requires modification of the product number. Change the seventh digit in the product number from **4** to **2**.

Examples: D841-2640 = chair with hard casters;
D841-2620 = chair with soft casters

CAL 133 Option

CAL 133 option is available on all chair models in leather. To specify, add **-F** to the product number and add **\$606.90** list.

Stain Repellent Option

To specify, add **-P** to end of the product number and add **\$61.99** list.



Example: D841-2640-P

NOTE: Stain repellent is not available on leather.

For available fabrics, refer to surfaces.haworth.com



Prescott Series

Swivel Seating

		Number	Fabric Grade							Leather Grade A	Leather Grade B	
			A	B	C	D	E	F	G			H
High-Back Chair, Fully-Upholstered Arm/Polypropylene Base 	Dimensions SH: 16" - 21" (406mm-533mm) H: 43 1/2" - 48" (1105mm-1219mm) D: 28"(711mm) W: 28"(711mm) AH: 25 1/4" - 29 3/4" (641mm-756mm) SW: 20 1/2"(521mm) SD: 17"(432mm)	5215-32	\$1960.62	\$2071.59	\$2139.21	\$2316.51	\$2396.88	\$2634.14	\$2779.54	\$3178.81	\$3407.14	\$4001.57
	Features <ul style="list-style-type: none"> • Seat and back panel curved, 8-Ply curved plywood. • Seat panel webbed with wide support webbing. • Seat contoured foam, back molded polyurethane foam. • Upholstered ABS outer shell. • Rigid molded urethane arms. • Five-star steel base with black polypropylene base cap. • Hard dual-wheel casters standard. • Synchronized-tilt (2:1 ratio) with 6-position back-lock. • Back height adjustment: 3"(76mm). • Pneumatic seat height adjustment. • COM yardage: 3.50 • COL square footage: 63.0 Available on RUSH.	To Order, Specify: <ol style="list-style-type: none"> 1) Product number. 2) Fabric surface and color. 3) Base cap finish color (NY-B). 										
High-Back Chair, Fully-Upholstered Arm with Wood Arm Trim/ Polypropylene Base 	SH: 16" - 21" (406mm-533mm) H: 43 1/2" - 48" (1105mm-1219mm) D: 28"(711mm) W: 28"(711mm) AH: 25 1/4" - 29 3/4" (641mm-756mm) SW: 20 1/2"(521mm) SD: 17"(432mm)	5210-32	\$2014.95	\$2125.92	\$2193.54	\$2370.84	\$2451.21	\$2688.47	\$2833.87	\$3233.14	\$3461.47	\$4055.90
	Features <ul style="list-style-type: none"> • Maple arm trim. • Seat and back panel curved, 8-Ply curved plywood. • Seat panel webbed with wide support webbing. • Seat contoured foam, back molded polyurethane foam. • Upholstered ABS outer shell. • Rigid molded urethane arms. • Five-star steel base with black polypropylene base cap. • Hard dual-wheel casters standard. • Synchronized-tilt (2:1 ratio) with 6-position back-lock. • Back height adjustment: 3"(76mm). • Pneumatic seat height adjustment. • COM yardage: 3.50 • COL square footage: 63.0 	To Order, Specify: <ol style="list-style-type: none"> 1) Product number. 2) Fabric surface and color. 3) Arm wood finish color. 4) Base cap finish color (NY-B). 										
High-Back Chair, Fully-Upholstered Arm/Wood Base 	SH: 16" - 21" (406mm-533mm) H: 43 1/2" - 48" (1105mm-1219mm) D: 28"(711mm) W: 28"(711mm) AH: 25 1/4" - 29 3/4" (641mm-756mm) SW: 20 1/2"(521mm) SD: 17"(432mm)	5215-32	\$2307.87	\$2418.84	\$2486.46	\$2663.76	\$2744.13	\$2981.39	\$3126.79	\$3526.06	\$3754.39	\$4348.82
	Features <ul style="list-style-type: none"> • Maple base. • Seat and back panel curved, 8-Ply curved plywood. • Seat panel webbed with wide support webbing. • Seat contoured foam, back molded polyurethane foam. • Upholstered ABS outer shell. • Rigid molded urethane arms. • Five-star steel base with wood base caps. • Hard dual-wheel casters standard. • Synchronized-tilt (2:1 ratio) with 6-position back lock. • Back height adjustment: 3"(76mm). • Pneumatic seat height adjustment. • COM yardage: 3.50 • COL square footage: 63.0 	To Order, Specify: <ol style="list-style-type: none"> 1) Product number. 2) Fabric surface and color. 3) Base wood finish color. <p>Stain Repellent Option To specify, add -P to end of the product number and add \$61.41 list. Example: 5215-32-P</p> <p>NOTE: Stain repellent is not available on leather. For available fabrics, refer to surfaces.haworth.com.</p>										



Prescott Series

Swivel Seating

	Dimensions	Number	Fabric Grade							Leather Grade A	Leather Grade B	
			A	B	C	D	E	F	G			H
High-Back Chair, Fully-Upholstered Arm with Wood Arm Trim/Wood Base 	SH: 16" - 21" (406mm-533mm)	5210-32	\$2362.20	\$2473.17	\$2540.79	\$2718.09	\$2798.46	\$3035.72	\$3181.12	\$3580.39	\$3808.72	\$4403.15
	H: 43 1/2" - 48" (1105mm-1219mm)											
	D: 28"(711mm)											
	W: 28"(711mm)											
	AH: 25 1/4" - 29 3/4" (641mm-756mm)											
	SW: 20 1/2"(521mm)											
	SD: 17"(432mm)											
	Features											
	<ul style="list-style-type: none"> Maple arm trim, maple base. Seat and back panel curved, 8-ply curved plywood. Seat panel webbed with wide support webbing. Seat contoured foam, back molded polyurethane foam. Upholstered ABS outer shell. Rigid molded urethane arms. Five-star steel base with wood base caps. Hard dual-wheel casters standard. Synchronized-tilt (2:1 ratio) with 6-position back-lock. Back height adjustment: 3"(76mm). Pneumatic seat height adjustment. COM yardage: 3.50 COL square footage: 63.0 											
	To Order, Specify:											
	<ol style="list-style-type: none"> Product number. Fabric surface and color. Arm/base wood finish color. 											
Mid-Back Chair, Fully-Upholstered Arm/Polypropylene Base 	SH: 16" - 21" (406mm-533mm)	5225-32	\$1866.14	\$1968.89	\$2031.50	\$2195.67	\$2270.08	\$2489.77	\$2624.40	\$2994.09	\$3205.51	\$3755.91
	H: 39 1/2" - 44" (1003mm-1118mm)											
	D: 28"(711mm)											
	W: 28"(711mm)											
	AH: 25 1/4" - 29 3/4" (641mm-756mm)											
	SW: 20 1/2"(521mm)											
	SD: 17"(432mm)											
	Features											
	<ul style="list-style-type: none"> Seat and back panel curved, 8-ply curved plywood. Seat panel webbed with wide support webbing. Seat contoured foam, back molded polyurethane foam. Upholstered ABS outer shell. Rigid molded urethane arms. Five-star steel base with black polypropylene base cap. Hard dual-wheel casters standard. Synchronized-tilt (2:1 ratio) with 6-position back-lock. Back height adjustment: 3"(76mm). Pneumatic seat height adjustment. COM yardage: 3.25 COL square footage: 58.5 											
	Available on RUSH.											
	To Order, Specify:											
	<ol style="list-style-type: none"> Product number. Fabric surface and color. Base cap finish color (NY-B). 											
Mid-Back Chair, Fully-Upholstered Arm with Wood Arm Trim/Polypropylene Base 	SH: 16" - 21" (406mm-533mm)	5220-32	\$1920.47	\$2023.22	\$2085.83	\$2250.00	\$2324.41	\$2544.10	\$2678.73	\$3048.42	\$3259.84	\$3810.24
	H: 39 1/2" - 44" (1003mm-1118mm)											
	D: 28"(711mm)											
	W: 28"(711mm)											
	AH: 25 1/4" - 29 3/4" (641mm-756mm)											
	SW: 20 1/2"(521mm)											
	SD: 17"(432mm)											
	Features											
	<ul style="list-style-type: none"> Maple arm trim. Seat and back panel curved, 8-ply curved plywood. Seat panel webbed with wide support webbing. Seat contoured foam, back molded polyurethane foam. Upholstered ABS outer shell. Rigid molded urethane arms. Five-star steel base with black polypropylene base cap. Hard dual-wheel casters standard. Synchronized-tilt (2:1 ratio) with 6-position back-lock. Back height adjustment: 3"(76mm). Pneumatic seat height adjustment. COM yardage: 3.25 COL square footage: 58.5 											
	To Order, Specify:											
	<ol style="list-style-type: none"> Product number. Fabric surface and color. Arm wood finish color. Base cap finish color (NY-B). 											
	Stain Repellent Option											
	To specify, add -P to end of the product number and add \$61.41 list.											
	Example: 5210-32-P											
	NOTE: Stain repellent is not available on leather.											
	For available fabrics, refer to surfaces.haworth.com .											

Prescott Series

Swivel Seating

		Number	Fabric Grade							Leather Grade A	Leather Grade B	
			A	B	C	D	E	F	G			H
Mid-Back Chair, Fully-Upholstered Arm/Wood Base  5225-32	Dimensions SH: 16" - 21" (406mm-533mm) H: 39 1/2" - 44" (1003mm-1118mm) D: 28"(711mm) W: 28"(711mm) AH: 25 1/4" - 29 3/4" (641mm-756mm) SW: 20 1/2"(521mm) SD: 17"(432mm)	5225-32	\$2213.39	\$2316.14	\$2378.75	\$2542.92	\$2617.33	\$2837.02	\$2971.65	\$3341.34	\$3552.76	\$4103.16
	Features <ul style="list-style-type: none"> Maple arm trim, maple base. Seat and back panel curved, 8-ply curved plywood. Seat panel webbed with wide support webbing. Seat contoured foam, back molded polyurethane foam. Upholstered ABS outer shell. Rigid molded urethane arms. Five-star steel base with wood base caps. Hard dual-wheel casters standard. Synchronized-tilt (2:1 ratio) with 6-position tilt lock. Back height adjustment: 3"(76mm). Pneumatic seat height adjustment. COM yardage: 3.25 COL square footage: 58.5 Available on RUSH.	To Order, Specify: <ol style="list-style-type: none"> Product number. Fabric surface and color. Base wood finish color. 										
Mid-Back Chair, Fully-Upholstered Arm with Wood Arm Trim/Wood Base  5220-32	Dimensions SH: 16" - 21" (406mm-533mm) H: 39 1/2" - 44" (1003mm-1118mm) D: 28"(711mm) W: 28"(711mm) AH: 25 1/4" - 29 3/4" (641mm-756mm) SW: 20 1/2"(521mm) SD: 17"(432mm)	5220-32	\$2267.72	\$2370.47	\$2433.08	\$2597.25	\$2671.66	\$2891.35	\$3025.98	\$3395.67	\$3607.09	\$4157.49
	Features <ul style="list-style-type: none"> Maple arm trim, maple base. Seat and back panel curved, 8-ply curved plywood. Seat panel webbed with wide support webbing. Seat contoured foam, back molded polyurethane foam. Upholstered ABS outer shell. Rigid molded urethane arms. Five-star steel base with wood base caps. Hard dual-wheel casters standard. Synchronized-tilt (2:1 ratio) with 6-position tilt lock. Back height adjustment: 3"(76mm). Pneumatic seat height adjustment. COM yardage: 3.25 COL square footage: 58.5 	To Order, Specify: <ol style="list-style-type: none"> Product number. Fabric surface and color. Arm/base wood finish color. Stain Repellent Option To specify, add -P to end of the product number and add \$61.41 list. Example: 5225-32- P NOTE: Stain repellent is not available on leather. For available fabrics, refer to surfaces.haworth.com .										

This page intentionally blank

System 12

General Specifications

Features and Options

- Armless and arm versions feature:
- 11mm solid steel frame
 - Textured injection-molded polypropylene seat and back
 - High impact nylon glides
 - Painted or chrome-finish frame
 - Stacking cart (40-high capacity)
 - Upholstered versions with 1/2”(13mm) foam pad on seat
 - Optional tablet board or book rack

- Chairs with arms feature:
- Black plastic arm caps

General Guidelines for Product Specification

System 12 specification numbers are based on a numeric logic that identifies a product by model and certain characteristics.

For instance, a product number that reads **1201-2110** identifies the product as a System 12 High-Density Stacking Chair, with arms, fixed height, polypropylene shell, and glides.

The numeric logic for this model with finish codes is shown below:

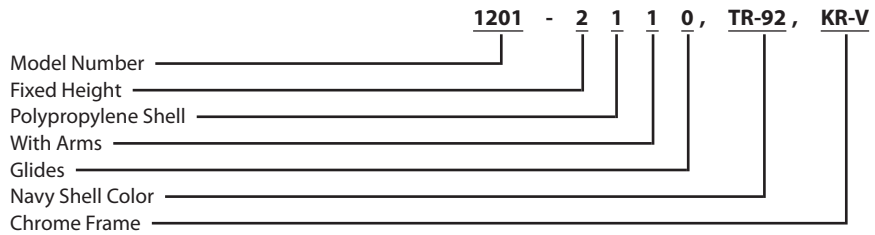

There are exceptions to this logic; therefore, always refer to the price charts for product numbers rather than attempting to construct them. Product number modification instructions for additional options appear in footnoted copy for each applicable model.

Beyond the printed product number, finish codes are required to complete an order specification. To communicate your order clearly, list the product number and finish codes in the sequence outlined on each price page.

COM & COL General Information

To order a COM fabric (Customer’s Own Material), contact the Haworth Inquiry Center (1.800.426.8562), your local Haworth dealer, or go to haworth.com/surfaces > COM Library to find out if the COM you have selected has already been tested and approved. The surface collection site also has information on the Haworth+ alliance program with Carnegie, Luna Textiles, and Maharam as well as our industry-leading Pre-Approved COM program.

COM fabrics are placed into Grades based on the cost per linear yard. If a fabric’s cost exceeds the range of our highest Grade it will be noted as Non-Graded. The product will be priced at Grade A; the COM fabric costs will appear as a separate line item. The fabric charge will be Haworth’s purchase cost plus a 4% administrative fee (based on the cost of the fabric). Yardage calculations will include any applicable fabric repeat.

COM Leather products will be priced at a leather Grade A; COL costs will appear as a separate line item. The leather costs will be Haworth’s purchase cost plus a 4% administrative fee (based on the cost of the leather).

RUSH

Select System 12 models are marked with a  symbol to denote availability on the RUSH program. Refer to the finish options for each product.

Finishes

A complete listing of fabrics and finishes for System 12 seating can be found in the back of the price list.

System 12

High-Density Stacking Chair

Designer: Steve Nemeth

With Arms

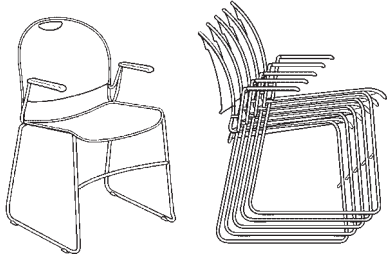

1201-2110

Dimensions

SH: 17"(432mm)
 H: 32"(813mm)
 W: 22"(559mm)
 D: 22 1/2"(572mm)
 SW: 17 1/2"(445mm)
 SD: 17 1/4"(438mm)
 AH: 24 3/4"(629mm)
 Between Arms:
 19"(483mm)

Features

- 11mm solid steel rod frame.
- Injection-molded textured polypropylene seat and back with upholstered option.
- Upholstered seat features 1/2"(13mm) foam pad.
- Integrated handle in back for easy mobility.
- Arms with black plastic caps.
- High impact nylon glides available with or without ganging option.
- Stackable 40-high with polypropylene shells; 69"(1753mm) high on stacking cart, or 22-high with upholstered shells; 66"(1676mm) high on stacking cart.
- Standard packaging - four per carton polypropylene and three per carton upholstered.
- Painted or chrome finish frame.
- Weight: 13.3 lbs.
- NOTE: Gang arm chairs only to armless chairs.
- COM yardage: 0.70
- Available on RUSH.

To Order, Specify:

- 1) Product number.
- 2) Fabric surface and color (if applicable).
- 3) Polypropylene shell color.
- 4) Frame trim color or chrome (KR-V).

Inside Shells	Ganging	Number	Price	Fabric Grade								
				A	B	C	D	E	F	G	H	
Polypropylene	Non-Ganging	1201-2110 ■	\$320.61	N/A	N/A	N/A	N/A	N/A	N/A	N/A	N/A	N/A
	Ganging Glides	1201-2111	330.83	N/A	N/A	N/A	N/A	N/A	N/A	N/A	N/A	N/A
Upholstered	Non-Ganging	1221-2110 ■	N/A	\$466.68	\$492.68	\$511.24	\$536.00	\$555.81	\$606.57	\$638.75	\$721.69	
	Ganging Glides	1221-2111	N/A	476.90	502.90	521.46	546.22	566.03	616.79	648.97	731.91	

Without Arms

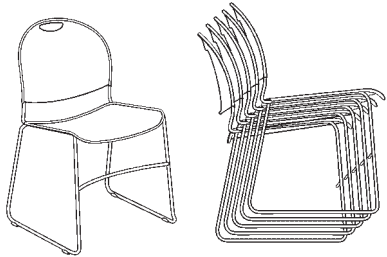

1200-2100

Dimensions

SH: 17"(432mm)
 H: 32"(813mm)
 W: 19 3/4"(502mm)
 D: 22 1/2"(572mm)
 SW: 17 1/2"(445mm)
 SD: 17 1/4"(438mm)

Features

- 11mm solid steel rod frame.
- Injection-molded textured polypropylene seat and back with upholstered option.
- Upholstered seat features 1/2"(13mm) foam pad.
- Integrated handle in back for easy mobility.
- High impact nylon glides available with or without ganging option.
- Stackable 40-high with polypropylene shells; 69"(1753mm) high on stacking cart, or 22-high with upholstered shells; 66"(1676mm) high on stacking cart.
- Standard packaging - four per carton polypropylene and three per carton upholstered.
- Painted or chrome finish frame.
- Weight: 10.8 lbs.
- NOTE: Gang armless chairs to either arm or armless chairs.
- COM yardage: 0.70
- Available on RUSH.

To Order, Specify:

- 1) Product number.
- 2) Fabric surface and color (if applicable).
- 3) Polypropylene shell color.
- 4) Frame trim color or chrome (KR-V).

Inside Shells	Ganging	Number	Price	Fabric Grade								
				A	B	C	D	E	F	G	H	
Polypropylene	Non-Ganging	1200-2100 ■	\$214.16	N/A	N/A	N/A	N/A	N/A	N/A	N/A	N/A	N/A
	Ganging Glides	1200-2101	224.38	N/A	N/A	N/A	N/A	N/A	N/A	N/A	N/A	N/A
Upholstered	Non-Ganging	1220-2100 ■	N/A	\$360.23	\$386.23	\$404.79	\$429.55	\$449.36	\$500.12	\$532.30	\$615.24	
	Ganging Glides	1220-2101	N/A	370.45	396.45	415.01	439.77	459.58	510.34	542.52	625.46	

System 12

Accessories

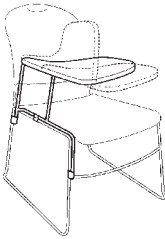
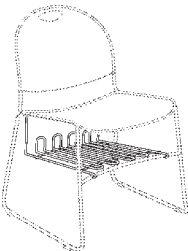
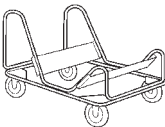
	Height	Width	Depth	Description	Number	Price
Tablet Board	9 3/8"(238mm)	11 5/8"(295mm)	20 1/2"(521mm)	Right-hand	TABR-12	\$177.02
				Left-hand	TABL-12	177.02
	Features			To Order, Specify:		
	<ul style="list-style-type: none"> • Retrofits to armless chairs only. • Particle board construction with high-pressure laminate top. • Price includes tablet board, support frame, and attachment clips. • Frame will be chrome finish only. • Flip up board does not articulate. • Cannot stack chairs with tablet boards attached. • Adds 1 1/2"(38mm) to chair width. 			<ol style="list-style-type: none"> 1) Product number. 2) Laminate finish color. <ul style="list-style-type: none"> H-34 Beige H-8J Charcoal H-3J Graphite 		
TABR-12 Class JA – SIN 711-18; Discount Group VIII						
Book Rack	5 1/4"(133mm)	16 1/2"(419mm)	13 7/8"(352mm)		BOOK-12	\$85.04
	Features			To Order, Specify:		
	<ul style="list-style-type: none"> • Retrofits to arm or armless chair. • Standard in chrome finish only. • Cannot stack chairs with book rack attached. 			<ol style="list-style-type: none"> 1) Product number. (No finish specification required.) 		
BOOK-12 Class JA – SIN 711-18; Discount Group VIII						
Stacking Cart	21 1/4"(540mm)	21 1/4"(540mm)	28 1/2"(724mm)	Non-upholstered chairs only	CART-12 ■	\$522.39
				Upholstered chairs only	CART-12U ■	522.39
	Features			To Order, Specify:		
	<ul style="list-style-type: none"> • CART-12 permits stacking 40-high (69"(1753mm)) and provides mobility. • CART-12U permits stacking 22-high (66"(1676mm)) and provides mobility. • Standard in black finish color only. 			<ol style="list-style-type: none"> 1) Product number. (No color specification required.) 		
CART-12 Class JA – SIN 711-19; Discount Group VIII	■ Available on RUSH.					

This page intentionally blank

Wood Seating

General Specifications

Features and Options	<p>Guest, occasional, and lounge models feature frames constructed solid hardwood, laminated plywood, laminated hardwood core and premium veneers, or rigid polyurethane.</p> <p>Office seating models feature an inner frame construction of tubular steel or solid hardwood or laminated plywood or molded plywood. Swivel bases are standard with hard dual-wheel casters.</p> <p>Exposed wood surfaces are finished with two top coats of pre-catalyst nitrocellulose lacquer for a durable finish.</p> <p>Refer to the appropriate seating model for applicable features and options.</p>
COM & COL General Information	<p>To order a COM fabric (Customer's Own Material), contact the Haworth Inquiry Center (1.800.426.8562), your local Haworth dealer, or go to haworth.com/surfaces > COM Library to find out if the COM you have selected has already been tested and approved. The surface collection site also has information on the Haworth + alliance program with Carnegie, Luna Textiles, and Maharam as well as our industry-leading Pre-Approved COM program.</p> <p>COM fabrics are placed into Grades based on the cost per linear yard. If a fabric's cost exceeds the range of our highest Grade it will be noted as Non-Graded. The product will be priced at Grade A; the COM fabric costs will appear as a separate line item. The fabric charge will be Haworth's purchase cost plus a 4% administrative fee (based on the cost of the fabric). Yardage calculations will include any applicable fabric repeat.</p> <p>COM Leather products will be priced at a leather Grade A; COL costs will appear as a separate line item. The leather costs will be Haworth's purchase cost plus a 4% administrative fee (based on the cost of the leather).</p>
Flammability Requirements	<p>Select chair models meet CAL 133 Standard and are available with an optional fire-retardant construction to comply with California Bulletin #133. Refer to the price pages for ordering information. Refer to Haworth.com/surfaces for a listing of the approved fabrics.</p>
General Guidelines for Product Specification	<p>Seating specification numbers are based on a numeric logic that identifies a product by model and certain characteristics.</p> <p>For instance, a product number that reads SAS-22-A1B identifies the product as a Candor Classic Seating with fully upholstered seat and back.</p> <p>The numeric logic for this model with finish codes is shown below:</p> <div style="text-align: center; margin: 10px 0;"> <p>SAS-22, A1B, 3A, 3A-06, M3-CA1</p> </div> <p>A ninth-digit suffix of the product code will indicate functional options, such as -F for CAL 133 option. There are exceptions to this logic; therefore, always refer to the price charts for product numbers rather than attempting to construct them. Product number modification instructions for additional options appear in footnoted copy for each applicable model.</p> <p>Beyond the printed product number, fabric and finish codes are required to complete an order specification. To communicate your order clearly, list the product number and finish codes in the sequence outlined on each price page.</p>
RUSH	<p>Select seating models are marked with a symbol to denote availability on the RUSH program. Refer to the fabric and finish options for each model. A maximum order quantity of 25 units applies to all contemporary RUSH seating models. Refer to the RUSH price book for further details.</p>
Finishes and Fabrics	<p>A complete listing of finishes/fabrics can be found in the back of the price list.</p>

Candor Classic Seating

Number ①②	Fabric Grade		C	D	E	F	G	H	Leather Grade A	Leather Grade B
	A	B								
SAS- ■ ■ -A1B ■	\$879.93	\$903.55	\$913.01	\$936.63	\$950.79	\$1113.79	\$1161.05	\$1302.77	\$1196.47	\$1478.37

Fully Upholstered
Seat and Back

SAS-22-A1B

Dimensions

SH: 17.8"(452mm)
H: 32.75"(832mm)
D: 23.25"(591mm)
W: 21"(533mm)
AH: 25"(635mm)
SW: 17.8"(452mm)
SD: 17.15"(436mm)

Features

- Open arms.
- Upholstered seat and back.
- Steamed beech hardwood frame. Seat frame rails are mortise and tenoned, cross locked with dowels, reinforced with corner blocks.
- Seat is HR foam over a webbed panel.
- The upholstered back frame insert is padded with foam.
- COM yardage: 1.5
- COL square footage: 27.0

■ Available on RUSH with matching seat and back upholstery.

Cal 133 Option: Add -F to product number and add \$112.21 list.

To Order, Specify:

1) Product number, including:

① Seat Option:

- 1 Leather
- 2 Fabric
- 3 Faux Leather

② Back Option:

- 1 Leather
- 2 Fabric
- 3 Faux Leather

- 2) Fabric surface and color (seat).
- 3) Fabric surface and color (back).
- 4) Arm/frame finish color.

SAS- ■ ■ -A2B ■	\$879.93	\$903.55	\$913.01	\$936.63	\$950.79	\$1113.79	\$1161.05	\$1302.77	\$1196.47	\$1478.37
-----------------	----------	----------	----------	----------	----------	-----------	-----------	-----------	-----------	-----------

Fully Upholstered
Seat and 3/4 Back

SAS-22-A2B

Dimensions

SH: 17.8"(452mm)
H: 32.50"(826mm)
D: 23.50"(597mm)
W: 21"(533mm)
AH: 25"(635mm)
SW: 17.8"(452mm)
SD: 17.15"(436mm)

Features

- Open arms.
- Upholstered seat and back.
- Steamed beech hardwood frame. Seat frame rails are mortise and tenoned, cross locked with dowels, reinforced with corner blocks.
- Seat is HR foam over a webbed panel.
- The upholstered back frame insert is padded with foam.
- COM yardage: 1.38
- COL square footage: 25.0

■ Available on RUSH with matching seat and back upholstery.

Cal 133 Option: Add -F to product number and add \$112.21 list.

To Order, Specify:

1) Product number, including:

① Seat Option:

- 1 Leather
- 2 Fabric
- 3 Faux Leather

② Back Option:

- 1 Leather
- 2 Fabric
- 3 Faux Leather

- 2) Fabric surface and color (seat).
- 3) Fabric surface and color (back).
- 4) Arm/frame finish color.

SAS- ■ W-A4B ■	\$822.05	\$833.86	\$838.59	\$850.40	\$857.48	\$938.98	\$962.61	\$1033.47	\$980.32	\$1121.27
----------------	----------	----------	----------	----------	----------	----------	----------	-----------	----------	-----------

Fully Upholstered
Seat and Slat Back

SAS-2W-A4B

Dimensions

SH: 17.8"(452mm)
H: 32.50"(826mm)
D: 23.50"(597mm)
W: 21"(533mm)
AH: 25"(635mm)
SW: 17.8"(452mm)
SD: 19"(483mm)

Features

- Open arms.
- Upholstered seat.
- Steamed beech hardwood frame. Seat frame rails are mortise and tenoned, cross locked with dowels, reinforced with corner blocks.
- Seat is HR foam over a webbed panel.
- COM yardage: 0.88
- COL square footage: 16.0

■ Available on RUSH with matching seat and back upholstery.

Cal 133 Option: Add -F to product number and add \$112.21 list.

Stain Repellent Option: To specify, add -P to end of the product number and add \$36.61 list.

Example: SAS-2W-A4B-P

Moisture Barrier Option: To specify add -D to end of the product number and add \$48.42 list.

Example: SAS-22-A1B-D

NOTE: Stain repellent and moisture barrier are not available on leather or faux leather.

For available fabrics, refer to surfaces.haworth.com.

To Order, Specify:

1) Product number, including:

① Seat Option:

- 1 Leather
- 2 Fabric
- 3 Faux Leather

② Back Option:

- W Wood

- 2) Fabric surface and color.
- 3) Arm/frame finish color.

Candor Modern Seating

Number 1 2	Fabric Grade		C	D	E	F	G	H	Leather	Leather
	A	B							Grade A	Grade B
SAS- -A1A	\$879.93	\$903.55	\$913.01	\$936.63	\$950.79	\$1113.79	\$1161.05	\$1302.77	\$1196.47	\$1478.37

Fully Upholstered Seat and Back



SAS-22-A1A

Dimensions

- SH: 17.8"(452mm)
- H: 32.75"(832mm)
- D: 23.50"(597mm)
- W: 21"(533mm)
- AH: 25"(635mm)
- SW: 17.8"(452mm)
- SD: 17"(432mm)

Features

- Open arms.
- Upholstered seat and back.
- Steamed beech hardwood frame. Seat frame rails are mortise and tenoned, cross locked with dowels, reinforced with corner blocks.
- Seat is HR foam over a webbed panel.
- The upholstered back frame insert is padded with foam.
- COM yardage: 1.5
- COL square footage: 27.0
- Available on RUSH with matching seat and back upholstery.

Cal 133 Option: Add -F to product number and add \$112.21 list.

To Order, Specify:

- 1) Product number, including:

1 Seat Option:

- 1 Leather
- 2 Fabric
- 3 Faux Leather

2 Back Option:

- 1 Leather
- 2 Fabric
- 3 Faux Leather

- 2) Fabric surface and color (seat).
- 3) Fabric surface and color (back).
- 4) Arm/frame finish color.

SAS- -A3A	\$879.93	\$903.55	\$913.01	\$936.63	\$950.79	\$1113.79	\$1161.05	\$1302.77	\$1196.47	\$1478.37
------------	----------	----------	----------	----------	----------	-----------	-----------	-----------	-----------	-----------

Fully Upholstered Seat and 1/2 Back



SAS-22-A3A

Dimensions

- SH: 17.8"(452mm)
- H: 32.50"(826mm)
- D: 23"(584mm)
- W: 21"(533mm)
- AH: 25"(635mm)
- SW: 17.8"(452mm)
- SD: 17"(432mm)

Features

- Open arms.
- Upholstered seat and back.
- Steamed beech hardwood frame. Seat frame rails are mortise and tenoned, cross locked with dowels, reinforced with corner blocks.
- Seat is HR foam over a webbed panel.
- The upholstered back frame insert is padded with foam.
- COM yardage: 1.25
- COL square footage: 22.5
- Available on RUSH with matching seat and back upholstery.

Cal 133 Option: Add -F to product number and add \$112.21 list.

To Order, Specify:

- 1) Product number, including:

1 Seat Option:

- 1 Leather
- 2 Fabric
- 3 Faux Leather

2 Back Option:

- 1 Leather
- 2 Fabric
- 3 Faux Leather

- 2) Fabric surface and color (seat).
- 3) Fabric surface and color (back).
- 4) Arm/frame finish color.

SAS- W-A4A	\$822.05	\$833.86	\$838.59	\$850.40	\$857.48	\$938.98	\$962.61	\$1033.47	\$980.32	\$1121.27
-------------	----------	----------	----------	----------	----------	----------	----------	-----------	----------	-----------

Fully Upholstered Seat and Slat Back



SAS-2W-A4A

Dimensions

- SH: 17.8"(452mm)
- H: 32.50"(826mm)
- D: 23"(584mm)
- W: 21"(533mm)
- AH: 25"(635mm)
- SW: 17.8"(452mm)
- SD: 19"(483mm)

Features

- Open arms.
- Upholstered seat.
- Steamed beech hardwood frame. Seat frame rails are mortise and tenoned, cross locked with dowels, reinforced with corner blocks.
- Seat is HR foam over a webbed panel.
- COM yardage: 0.88
- COL square footage: 16.0
- Available on RUSH with matching seat and back upholstery.

Cal 133 Option: Add -F to product number and add \$112.21 list.

Stain Repellent Option: To specify, add -P to end of the product number and add \$36.61 list.
Example: SAS-2W-A4A-P

Moisture Barrier Option: To specify add -D to end of the product number and add \$48.42 list.
Example: SAS-22-A1A-D

NOTE: Stain repellent and moisture barrier are not available on leather or faux leather.
For available fabrics, refer to surfaces.haworth.com.

To Order, Specify:

- 1) Product number, including:

1 Seat Option:

- 1 Leather
- 2 Fabric
- 3 Faux Leather

2 Back Option:

- W Wood

- 2) Fabric surface and color.
- 3) Arm/frame finish color.

Composites Seating Series

Guest/Occasional Seating

Base/ Frame	Number	Fabric Grade		C	D	E	F	G	H	Leather Grade A	Leather Grade B
		A	B								
Maple	4045-00	\$1124.41	\$1163.39	\$1198.82	\$1257.87	\$1293.30	\$1315.74	\$1357.08	\$1471.65	\$1890.95	\$2074.92

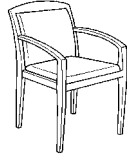
**Arc Arm,
Upholstered Back**

4045-00

Dimensions

SH: 18 1/2"(470mm)

H: 33 3/4"(857mm)

D: 23"(584mm)

W: 22 3/8"(568mm)

AH: 24" - 26"
(610mm-660mm)

SW: 19 1/2"(495mm)

SD: 18"(457mm)

Features

- Open arms.
- Upholstered seat and back.
- Maple hardwood frame. Seat frame rails are mortise and tenoned, cross locked with dowels, reinforced with corner blocks.
- Seat is HR foam over a webbed panel.
- The upholstered back frame insert is webbed and padded with foam.
- Available with fire-retardant construction to comply with California Bulletin #133.
- COM yardage: 1.25
- COL square footage: 22.5

■ Available on RUSH.

To Order, Specify:

- 1) Product number.
- 2) Fabric surface and color.
- 3) Arm/frame finish color.

CAL 133 Option:

Add -F to the product number, and add \$115.75 list.

Maple	4145-00	\$1124.41	\$1148.03	\$1157.48	\$1183.46	\$1198.82	\$1250.78	\$1279.13	\$1353.54	\$1466.93	\$1622.73
-------	---------	-----------	-----------	-----------	-----------	-----------	-----------	-----------	-----------	-----------	-----------

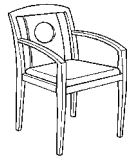
**Arc Arm,
Circle Back**

4145-00

Dimensions

SH: 18 1/2"(470mm)

H: 33 3/4"(857mm)

D: 23"(584mm)

W: 22 3/8"(568mm)

AH: 24" - 26"
(610mm-660mm)

SW: 19 1/2"(495mm)

SD: 18"(457mm)

Features

- Open arms.
- Upholstered seat.
- Maple hardwood frame. Seat frame rails are mortise and tenoned, cross locked with dowels, reinforced with corner blocks.
- Seat is HR foam over a webbed panel.
- Available with fire-retardant construction to comply with California Bulletin #133.
- COM yardage: 0.66
- COL square footage: 12.0

■ Available on RUSH.

To Order, Specify:

- 1) Product number.
- 2) Fabric surface and color.
- 3) Arm/frame finish color.

CAL 133 Option:

Add -F to the product number, and add \$115.75 list.

Maple	4245-00	\$1124.41	\$1148.03	\$1157.48	\$1183.46	\$1198.82	\$1250.78	\$1279.13	\$1353.54	\$1466.93	\$1622.73
-------	---------	-----------	-----------	-----------	-----------	-----------	-----------	-----------	-----------	-----------	-----------

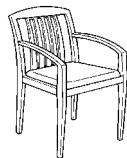
**Arc Arm,
Slat Back**

4245-00

Dimensions

SH: 18 1/2"(470mm)

H: 33 3/4"(857mm)

D: 23"(584mm)

W: 22 3/8"(568mm)

AH: 24" - 26"
(610mm-660mm)

SW: 19 1/2"(495mm)

SD: 18"(457mm)

Features

- Open arms.
- Upholstered seat.
- Maple hardwood frame. Seat frame rails are mortise and tenoned, cross locked with dowels, reinforced with corner blocks.
- Seat is HR foam over a webbed panel.
- Available with fire-retardant construction to comply with California Bulletin #133.
- COM yardage: 0.66
- COL square footage: 12.0

■ Available on RUSH.

To Order, Specify:

- 1) Product number.
- 2) Fabric surface and color.
- 3) Arm/frame finish color.

CAL 133 Option:

Add -F to the product number, and add \$115.75 list.

Stain Repellent Option: To specify, add -P to end of the product number and add \$36.61 list.**Example:** 4245-00-P**Moisture Barrier Option:** To specify add -D to end of the product number and add \$48.42 list.**Example:** 4245-00-D**NOTE:** Stain repellent and moisture barrier are not available on leather or faux leather.For available fabrics, refer to surfaces.haworth.com.

Composites Seating Series

Guest/Occasional Seating

Base/ Frame	Number	Fabric Grade		C	D	E	F	G	H	Leather Grade A	Leather Grade B
		A	B								
Maple	4046-00	\$1124.41	\$1163.39	\$1198.82	\$1257.87	\$1293.30	\$1315.74	\$1357.08	\$1471.65	\$1890.95	\$2074.92

**Repose Arm,
Upholstered Back**

4046-00

Dimensions

SH: 18 1/2"(470mm)
H: 33 3/4"(857mm)
D: 23"(584mm)
W: 22 3/8"(568mm)
AH: 25 1/2"(648mm)
SW: 19 1/2"(495mm)
SD: 18"(457mm)

Features

- Open arms.
- Upholstered seat and back.
- Maple hardwood frame. Seat frame rails are mortise and tenoned, cross locked with dowels, reinforced with corner blocks.
- Seat is HR foam over a webbed panel.
- The upholstered back frame insert is webbed and padded with foam.
- Available with fire-retardant construction to comply with California Bulletin #133.
- COM yardage: 1.25
- COL square footage: 22.5
- Available on RUSH.

To Order, Specify:

- 1) Product number.
- 2) Fabric surface and color.
- 3) Arm/frame finish color.

CAL 133 Option:

Add -F to the product number, and add \$115.75 list.

Maple	4146-00	\$1124.41	\$1148.03	\$1157.48	\$1183.46	\$1198.82	\$1250.78	\$1279.13	\$1353.54	\$1466.93	\$1622.73
-------	---------	-----------	-----------	-----------	-----------	-----------	-----------	-----------	-----------	-----------	-----------

**Repose Arm,
Houglass Back**

4146-00

Dimensions

SH: 18 1/2"(470mm)
H: 33 3/4"(857mm)
D: 23"(584mm)
W: 22 3/8"(568mm)
AH: 25 1/2"(648mm)
SW: 19 1/2"(495mm)
SD: 18"(457mm)

Features

- Open arms.
- Upholstered seat.
- Maple hardwood frame. Seat frame rails are mortise and tenoned, cross locked with dowels, reinforced with corner blocks.
- Seat is HR foam over a webbed panel.
- Available with fire-retardant construction to comply with California Bulletin #133.
- COM yardage: 0.66
- COL square footage: 12.0
- Available on RUSH.

To Order, Specify:

- 1) Product number.
- 2) Fabric surface and color.
- 3) Arm/frame finish color.

CAL 133 Option:

Add -F to the product number, and add \$115.75 list.

Maple	4246-00	\$1124.41	\$1148.03	\$1157.48	\$1183.46	\$1198.82	\$1250.78	\$1279.13	\$1353.54	\$1466.93	\$1622.73
-------	---------	-----------	-----------	-----------	-----------	-----------	-----------	-----------	-----------	-----------	-----------

**Repose Arm,
Cross Back**

4246-00

Dimensions

SH: 18 1/2"(470mm)
H: 33 3/4"(857mm)
D: 23"(584mm)
W: 22 3/8"(568mm)
AH: 25 1/2"(648mm)
SW: 19 1/2"(495mm)
SD: 18"(457mm)

Features

- Open arms.
- Upholstered seat.
- Maple hardwood frame. Seat frame rails are mortise and tenoned, cross locked with dowels, reinforced with corner blocks.
- Seat is HR foam over a webbed panel.
- Available with fire-retardant construction to comply with California Bulletin #133.
- COM yardage: 0.66
- COL square footage: 12.0
- Available on RUSH.

To Order, Specify:

- 1) Product number.
- 2) Fabric surface and color.
- 3) Arm/frame finish color.

CAL 133 Option:

Add -F to the product number, and add \$115.75 list.

Stain Repellent Option: To specify, add -P to end of the product number and add \$36.61 list.

Example: 4046-00-P

Moisture Barrier Option: To specify add -D to end of the product number and add \$48.42 list.

Example: 4046-00-D

NOTE: Stain repellent and moisture barrier are not available on leather or faux leather.

For available fabrics, refer to surfaces.haworth.com.

Composites Seating Series

Guest/Occasional Seating

Base/ Frame	Number	Fabric Grade		C	D	E	F	G	H	Leather Grade A	Leather Grade B
		A	B								
Maple	4047-00	\$1124.41	\$1163.39	\$1198.82	\$1257.87	\$1293.30	\$1315.74	\$1357.08	\$1471.65	\$1890.95	\$2074.92

Cascade Arm, Upholstered Back

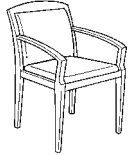

4047-00

Dimensions

SH: 18 1/2"(470mm)
 H: 33 3/4"(857mm)
 D: 23"(584mm)
 W: 22 3/8"(568mm)
 AH: 22 1/2" - 26 1/4"
 (572mm-667mm)
 SW: 19 1/2"(495mm)
 SD: 18"(457mm)

Features

- Open arms.
- Upholstered seat and back.
- Maple hardwood frame. Seat frame rails are mortise and tenoned, cross locked with dowels, reinforced with corner blocks.
- Seat is HR foam over a webbed panel.
- The upholstered back frame insert is webbed and padded with foam.
- Available with fire-retardant construction to comply with California Bulletin #133.
- COM yardage: 1.25
- COL square footage: 22.5
- Available on RUSH.

To Order, Specify:

- 1) Product number.
- 2) Fabric surface and color.
- 3) Arm/frame finish color.

CAL 133 Option:

Add -F to the product number, and add \$115.75 list.

Maple	4147-00	\$1124.41	\$1148.03	\$1157.48	\$1183.46	\$1198.82	\$1250.78	\$1279.13	\$1353.54	\$1466.93	\$1622.73
-------	---------	-----------	-----------	-----------	-----------	-----------	-----------	-----------	-----------	-----------	-----------

Cascade Arm, Circle Back

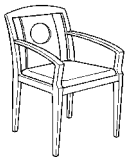

4147-00

Dimensions

SH: 18 1/2"(470mm)
 H: 33 3/4"(857mm)
 D: 23"(584mm)
 W: 22 3/8"(568mm)
 AH: 22 1/2" - 26 1/4"
 (572mm-667mm)
 SW: 19 1/2"(495mm)
 SD: 18"(457mm)

Features

- Open arms.
- Upholstered seat.
- Maple hardwood frame. Seat frame rails are mortise and tenoned, cross locked with dowels, reinforced with corner blocks.
- Seat is HR foam over a webbed panel.
- Available with fire-retardant construction to comply with California Bulletin #133.
- COM yardage: 0.66
- COL square footage: 12.0
- Available on RUSH.

To Order, Specify:

- 1) Product number.
- 2) Fabric surface and color.
- 3) Arm/frame finish color.

CAL 133 Option:

Add -F to the product number, and add \$115.75 list.

Maple	4247-00	\$1124.41	\$1148.03	\$1157.48	\$1183.46	\$1198.82	\$1250.78	\$1279.13	\$1353.54	\$1466.93	\$1622.73
-------	---------	-----------	-----------	-----------	-----------	-----------	-----------	-----------	-----------	-----------	-----------

Cascade Arm, Slat Back

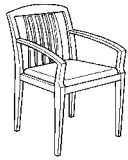

4247-00

Dimensions

SH: 18 1/2"(470mm)
 H: 33 3/4"(857mm)
 D: 23"(584mm)
 W: 22 3/8"(568mm)
 AH: 22 1/2" - 26 1/4"
 (572mm-667mm)
 SW: 19 1/2"(495mm)
 SD: 18"(457mm)

Features

- Open arms.
- Upholstered seat.
- Maple hardwood frame. Seat frame rails are mortise and tenoned, cross locked with dowels, reinforced with corner blocks.
- Seat is HR foam over a webbed panel.
- Available with fire-retardant construction to comply with California Bulletin #133.
- COM yardage: 0.66
- COL square footage: 12.0
- Available on RUSH.

To Order, Specify:

- 1) Product number.
- 2) Fabric surface and color.
- 3) Arm/frame finish color.

CAL 133 Option:

Add -F to the product number, and add \$115.75 list.

Stain Repellent Option: To specify, add -P to end of the product number and add \$36.61 list.

Example: 4047-00-P

Moisture Barrier Option: To specify add -D to end of the product number and add \$48.42 list.

Example: 4047-00-D

NOTE: Stain repellent and moisture barrier are not available on leather or faux leather.

For available fabrics, refer to surfaces.haworth.com.

Composites Seating Series

Guest/Occasional Seating

Base/ Frame	Number	Fabric Grade		C	D	E	F	G	H	Leather Grade A	Leather Grade B
		A	B								
Maple	4048-00	\$1124.41	\$1163.39	\$1198.82	\$1257.87	\$1293.30	\$1315.74	\$1357.08	\$1471.65	\$1890.95	\$2074.92

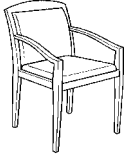
**Contour Arm,
Upholstered Back**

4048-00

Dimensions

SH: 18 1/2"(470mm)
H: 33 3/4"(857mm)
D: 23"(584mm)
W: 22 3/8"(568mm)
AH: 22 7/8"-26-3/8"
(581mm-670mm)
SW: 19 1/2"(495mm)
SD: 18"(457mm)

Features

- Open arms.
- Upholstered seat and back.
- Maple hardwood frame. Seat frame rails are mortise and tenoned, cross locked with dowels, reinforced with corner blocks.
- Seat is HR foam over a webbed panel.
- The upholstered back frame insert is webbed and padded with foam.
- Available with fire-retardant construction to comply with California Bulletin #133.
- COM yardage: 1.25
- COL square footage: 22.5
- Available on RUSH.

To Order, Specify:

- 1) Product number.
- 2) Fabric surface and color.
- 3) Arm/frame finish color.

CAL 133 Option:

Add -F to the product number, and add \$115.75 list.

Maple	4148-00	\$1124.41	\$1148.03	\$1157.48	\$1183.46	\$1198.82	\$1250.78	\$1279.13	\$1353.54	\$1466.93	\$1622.73
-------	---------	-----------	-----------	-----------	-----------	-----------	-----------	-----------	-----------	-----------	-----------

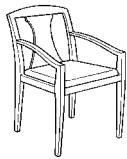
**Contour Arm,
Houglass Back**

4148-00

Dimensions

SH: 18 1/2"(470mm)
H: 33 3/4"(857mm)
D: 23"(584mm)
W: 22 3/8"(568mm)
AH: 22 7/8"-26-3/8"
(581mm-670mm)
SW: 19 1/2"(495mm)
SD: 18"(457mm)

Features

- Open arms.
- Upholstered seat.
- Maple hardwood frame. Seat frame rails are mortise and tenoned, cross locked with dowels, reinforced with corner blocks.
- Seat is HR foam over a webbed panel.
- Available with fire-retardant construction to comply with California Bulletin #133.
- COM yardage: 0.66
- COL square footage: 12.0
- Available on RUSH.

To Order, Specify:

- 1) Product number.
- 2) Fabric surface and color.
- 3) Arm/frame finish color.

CAL 133 Option:

Add -F to the product number, and add \$115.75 list.

Maple	4248-00	\$1124.41	\$1148.03	\$1157.48	\$1183.46	\$1198.82	\$1250.78	\$1279.13	\$1353.54	\$1466.93	\$1622.73
-------	---------	-----------	-----------	-----------	-----------	-----------	-----------	-----------	-----------	-----------	-----------

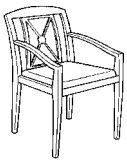
**Contour Arm,
Cross Back**

4248-00

Dimensions

SH: 18 1/2"(470mm)
H: 33 3/4"(857mm)
D: 23"(584mm)
W: 22 3/8"(568mm)
AH: 22 7/8"-26-3/8"
(581mm-670mm)
SW: 19 1/2"(495mm)
SD: 18"(457mm)

Features

- Open arms.
- Upholstered seat.
- Maple hardwood frame. Seat frame rails are mortise and tenoned, cross locked with dowels, reinforced with corner blocks.
- Seat is HR foam over a webbed panel.
- Available with fire-retardant construction to comply with California Bulletin #133.
- COM yardage: 0.66
- COL square footage: 12.0
- Available on RUSH.

To Order, Specify:

- 1) Product number.
- 2) Fabric surface and color.
- 3) Arm/frame finish color.

CAL 133 Option:

Add -F to the product number, and add \$115.75 list.

Stain Repellent Option: To specify, add -P to end of the product number and add \$36.61 list.

Example: 4048-00-P

Moisture Barrier Option: To specify add -D to end of the product number and add \$48.42 list.

Example: 4048-00-D

NOTE: Stain repellent and moisture barrier are not available on leather or faux leather.

For available fabrics, refer to surfaces.haworth.com.

Composites Seating Series

Guest/Occasional Seating

Base/ Frame	Number	Fabric Grade		C	D	E	F	G	H	Leather Grade A	Leather Grade B
		A	B								
Maple	4043-00	\$1124.41	\$1163.39	\$1198.82	\$1257.87	\$1293.30	\$1315.74	\$1357.08	\$1471.65	\$1890.95	\$2074.92

Stacking Chair, Arc Arm, Upholstered Back

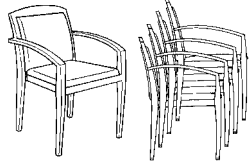

4043-00

Dimensions

SH: 18 1/2"(470mm)
 H: 33 5/8"(854mm)
 D: 21 3/4"(552mm)
 W: 22 1/4"(565mm)
 SW: 18"(457mm)
 SD: 18"(457mm)
 AH: 25 7/8"(657mm)

Features

- Open arms.
- Upholstered seat and back.
- Maple hardwood frame. Seat frame rails are mortise and tenoned, cross locked with dowels, reinforced with corner blocks.
- Seat is HR foam over a webbed panel.
- The upholstered back frame insert is webbed and padded with foam.
- Recommended stacking limit is 4 chairs high.
- Available with fire-retardant construction to comply with California Bulletin #133.
- COM yardage: 1.13
- COL square footage: 20.3

To Order, Specify:

- 1) Product number.
- 2) Fabric surface and color.
- 3) Frame finish color.

CAL 133 Option:

Add **-F** to the product number, and add **\$115.75** list.

Maple	4243-00	\$1124.41	\$1148.03	\$1157.48	\$1183.46	\$1198.82	\$1250.78	\$1279.13	\$1353.54	\$1466.93	\$1622.73
-------	---------	-----------	-----------	-----------	-----------	-----------	-----------	-----------	-----------	-----------	-----------

Stacking Chair, Arc Arm, Slat Back

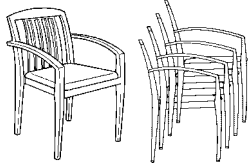

4243-00

Dimensions

SH: 18 1/2" (470mm)
 H: 33 5/8" (854mm)
 D: 21 3/4"(552mm)
 W: 22 1/4" (565mm)
 SW: 18"(457mm)
 SD: 18"(457mm)
 AH: 25 7/8" (657mm)

Features

- Open arms.
- Upholstered seat.
- Maple hardwood frame. Seat frame rails are mortise and tenoned, cross locked with dowels, reinforced with corner blocks.
- Seat is HR foam over a webbed panel.
- Recommended stacking limit is 4 chairs high.
- Available with fire-retardant construction to comply with California Bulletin #133.
- COM yardage: 0.66
- COL square footage: 12.0

To Order, Specify:

- 1) Product number.
- 2) Fabric surface and color.
- 3) Frame finish color.

CAL 133 Option:

Add **-F** to the product number, and add **\$115.75** list.

Stain Repellent Option: To specify, add **-P** to end of the product number and add **\$36.61** list.

Example: 4043-00-**P**

Moisture Barrier Option: To specify add **-D** to end of the product number and add **\$48.42** list.

Example: 4043-00-**D**

NOTE: Stain repellent and moisture barrier are not available on leather or faux leather.

For available fabrics, refer to surfaces.haworth.com.

Composites Seating Series

Occasional Seating

Base/ Frame	Number	Fabric Grade		C	D	E	F	G	H	Leather Grade A	Leather Grade B
		A	B								
Maple	4049-00	\$1124.41	\$1163.39	\$1198.82	\$1257.87	\$1293.30	\$1315.74	\$1357.08	\$1471.65	\$1890.95	\$2074.92

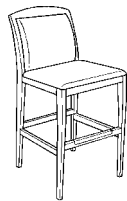
**Stool, Armless,
Upholstered Back**

4049-00

Dimensions

SH: 28"(711mm)
H: 41 1/8"(1045mm)
D: 19 7/8"(505mm)
W: 18 1/2"(470mm)
SW: 18 1/2"(470mm)
SD: 15 1/4"(387mm)

Features

- Upholstered seat and back.
- Maple hardwood frame. Seat frame rails are mortise and tenoned, cross locked with dowels, reinforced with corner blocks.
- Seat is HR foam over a webbed panel.
- The upholstered back frame insert is webbed and padded with foam.
- Standard with brass kick plate. No finish specification required.
- Available with fire-retardant construction to comply with California Bulletin #133.
- COM yardage: 1.00
- COL square footage: 18.0

To Order, Specify:

- 1) Product number.
- 2) Fabric surface and color.
- 3) Frame finish color.

CAL 133 Option:

Add **-F** to the product number, and add **\$115.75** list.

Maple	4249-00	\$1124.41	\$1148.03	\$1157.48	\$1183.46	\$1198.82	\$1250.78	\$1279.13	\$1353.54	\$1466.93	\$1622.73
-------	---------	-----------	-----------	-----------	-----------	-----------	-----------	-----------	-----------	-----------	-----------

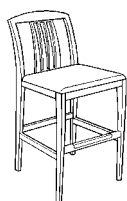
**Stool, Armless,
Slat Back**

4249-00

Dimensions

SH: 28"(711mm)
H: 41 1/8"(1045mm)
D: 19 7/8"(505mm)
W: 18 1/2"(470mm)
SW: 18 1/2"(470mm)
SD: 15 1/4"(387mm)

Features

- Upholstered seat.
- Maple hardwood frame. Seat frame rails are mortise and tenoned, cross locked with dowels, reinforced with corner blocks.
- Seat is HR foam over a webbed panel.
- Standard with brass kick plate. No finish specification required.
- Available with fire-retardant construction to comply with California Bulletin #133.
- COM yardage: 0.66
- COL square footage: 12.0

To Order, Specify:

- 1) Product number.
- 2) Fabric surface and color.
- 3) Frame finish color.

CAL 133 Option:

Add **-F** to the product number, and add **\$115.75** list.

Stain Repellent Option: To specify, add **-P** to end of the product number and add **\$36.61** list.
Example: 4049-00-**P**

Moisture Barrier Option: To specify add **-D** to end of the product number and add **\$48.42** list.
Example: 4049-00-**D**

NOTE: Stain repellent and moisture barrier are not available on leather or faux leather.

For available fabrics, refer to surfaces.haworth.com.

Forenze Seating

Guest/Occasional Seating

Base/ Frame	Number	Fabric Grade		C	D	E	F	G	H	Leather Grade A	Leather Grade B
		A	B								
Maple	8381-00	\$1207.09	\$1229.53	\$1238.98	\$1262.59	\$1279.13	\$1398.43	\$1439.76	\$1554.34	\$1530.72	\$1684.03

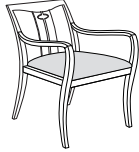
**Serpentine Arm,
Ellipse Back**

8381-00

Dimensions

SH: 18 1/4"(464mm)
H: 32 5/8"(829mm)
D: 22 3/4"(578mm)
W: 22 3/4"(578mm)
AH: 26 1/2"(673mm)
SW: 19 1/2"(495mm)
SD: 18 5/8"(473mm)

Features

- Open arms.
- Upholstered seat.
- Maple hardwood frame. Seat frame rails are mortise and tenoned, cross locked with dowels.
- Seat is 1 3/4"(45mm) HR foam over a webbed panel.
- COM yardage: 0.75
- COL square footage: 13.5
- Available on RUSH.

To Order, Specify:

- 1) Product number.
- 2) Fabric surface and color.
- 3) Wood finish color.

CAL 133 Option:

Add -F to the product number, and add \$106.30 list.

Maple	8281-00	\$1207.09	\$1229.53	\$1238.98	\$1262.59	\$1279.13	\$1398.43	\$1439.76	\$1554.34	\$1530.72	\$1684.03
-------	---------	-----------	-----------	-----------	-----------	-----------	-----------	-----------	-----------	-----------	-----------

**Serpentine Arm,
Wave Back**

8281-00

Dimensions

SH: 18 1/4"(464mm)
H: 32 5/8"(829mm)
D: 22 3/4"(578mm)
W: 22 3/4"(578mm)
AH: 26 1/2"(673mm)
SW: 19 1/2"(495mm)
SD: 18 5/8"(473mm)

Features

- Open arms.
- Upholstered seat.
- Maple hardwood frame. Seat frame rails are mortise and tenoned, cross locked with dowels.
- Seat is 1 3/4"(45mm) HR foam over a webbed panel.
- COM yardage: 0.75
- COL square footage: 13.5

To Order, Specify:

- 1) Product number.
- 2) Fabric surface and color.
- 3) Arm/frame finish color.

CAL 133 Option:

Add -F to the product number, and add \$106.30 list.

Maple	8181-00	\$1207.09	\$1244.89	\$1279.14	\$1334.63	\$1370.07	\$1448.03	\$1498.81	\$1641.74	\$1937.03	\$2132.85
-------	---------	-----------	-----------	-----------	-----------	-----------	-----------	-----------	-----------	-----------	-----------

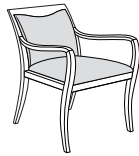
**Serpentine Arm,
Upholstered Back**

8181-00

Dimensions

SH: 18 1/4"(464mm)
H: 32 5/8"(829mm)
D: 23 1/4"(591mm)
W: 22 3/4"(578mm)
AH: 26 1/2"(673mm)
SW: 19 1/2"(495mm)
SD: 18 1/4"(464mm)

Features

- Open arms.
- Upholstered seat and back.
- Maple hardwood frame. Seat frame rails are mortise and tenoned, cross locked with dowels.
- Seat is 1 3/4"(45mm) HR foam over a webbed panel.
- The upholstered back frame insert is webbed and padded with 1"(25mm) thick foam.
- COM yardage: 1.25
- COL square footage: 22.5
- Available on RUSH.

To Order, Specify:

- 1) Product number.
- 2) Fabric surface and color.
- 3) Wood finish color.

CAL 133 Option:

Add -F to the product number, and add \$106.30 list.

Stain Repellent Option: To specify, add -P to end of the product number and add \$36.61 list.

Example: 8381-00-P

Moisture Barrier Option: To specify add -D to end of the product number and add \$48.42 list.

Example: 8381-00-D

NOTE: Stain repellent and moisture barrier are not available on leather or faux leather.

For available fabrics, refer to surfaces.haworth.com.

Forenze Seating

Guest/Occasional Seating

Base/ Frame	Number	Fabric Grade		C	D	E	F	G	H	Leather Grade A	Leather Grade B
		A	B								
Maple	8382-00	\$1207.09	\$1229.53	\$1238.98	\$1262.59	\$1279.13	\$1398.43	\$1439.76	\$1554.34	\$1530.72	\$1684.03

**Curve Arm,
Ellipse Back**

8382-00

Dimensions

SH: 18 1/4"(464mm)
H: 32 5/8"(829mm)
D: 22 3/4"(578mm)
W: 22 3/4"(578mm)
AH: 26 3/8"(670mm)
SW: 19 1/2"(495mm)
SD: 18 5/8"(473mm)

Features

- Open arms.
- Upholstered seat.
- Maple hardwood frame. Seat frame rails are mortise and tenoned, cross locked with dowels.
- Seat is 1 3/4"(45mm) HR foam over a webbed panel.
- COM yardage: 0.75
- COL square footage: 13.5
- Available on RUSH.

To Order, Specify:

- 1) Product number.
- 2) Fabric surface and color.
- 3) Wood finish color.

CAL 133 Option:

Add -F to the product number, and add \$106.30 list.

Maple	8282-00	\$1207.09	\$1229.53	\$1238.98	\$1262.59	\$1279.13	\$1398.43	\$1439.76	\$1554.34	\$1530.72	\$1684.03
-------	---------	-----------	-----------	-----------	-----------	-----------	-----------	-----------	-----------	-----------	-----------

**Curve Arm,
Wave Back**

8282-00

Dimensions

SH: 18 1/4"(464mm)
H: 32 5/8"(829mm)
D: 22 3/4"(578mm)
W: 22 3/4"(578mm)
AH: 26 3/8"(670mm)
SW: 19 1/2"(495mm)
SD: 18 5/8"(473mm)

Features

- Open arms.
- Upholstered seat.
- Maple hardwood frame. Seat frame rails are mortise and tenoned, cross locked with dowels.
- Seat is 1 3/4"(45mm) HR foam over a webbed panel.
- COM yardage: 0.75
- COL square footage: 13.5

To Order, Specify:

- 1) Product number.
- 2) Fabric surface and color.
- 3) Wood finish color.

CAL 133 Option:

Add -F to the product number, and add \$106.30 list.

Maple	8182-00	\$1207.09	\$1244.89	\$1279.14	\$1334.63	\$1370.07	\$1448.03	\$1498.81	\$1641.74	\$1937.03	\$2132.85
-------	---------	-----------	-----------	-----------	-----------	-----------	-----------	-----------	-----------	-----------	-----------

**Curve Arm,
Upholstered Back**

8182-00

Dimensions

SH: 18 1/4"(464mm)
H: 32 5/8"(829mm)
D: 23 1/4"(591mm)
W: 22 3/4"(578mm)
AH: 26 3/8"(670mm)
SW: 19 1/2"(495mm)
SD: 18 1/4"(464mm)

Features

- Open arms.
- Upholstered seat and back.
- Maple hardwood frame. Seat frame rails are mortise and tenoned, cross locked with dowels.
- Seat is 1 3/4"(45mm) HR foam over a webbed panel.
- The upholstered back frame insert is webbed and padded with 1"(25mm) thick foam.
- COM yardage: 1.25
- COL square footage: 22.5
- Available on RUSH.

To Order, Specify:

- 1) Product number.
- 2) Fabric surface and color.
- 3) Wood finish color.

CAL 133 Option:

Add -F to the product number, and add \$106.30 list.

Stain Repellent Option: To specify, add -P to end of the product number and add \$36.61 list.

Example: 8382-00-P

Moisture Barrier Option: To specify add -D to end of the product number and add \$48.42 list.

Example: 8382-00-D

NOTE: Stain repellent and moisture barrier are not available on leather or faux leather.

For available fabrics, refer to surfaces.haworth.com.

Forenze Seating

Guest/Occasional Seating

Base/ Frame	Number	Fabric Grade		C	D	E	F	G	H	Leather Grade A	Leather Grade B
		A	B								
Maple	8583-00	\$1207.09	\$1229.53	\$1238.98	\$1262.59	\$1279.13	\$1398.43	\$1439.76	\$1554.34	\$1530.72	\$1684.03

**Scroll Arm,
Star Back**

8583-00

Dimensions

SH: 18 1/4"(464mm)
H: 32 5/8"(829mm)
D: 22 3/4"(578mm)
W: 22 3/4"(578mm)
AH: 26 3/8"(670mm)
SW: 19 1/2"(495mm)
SD: 18 5/8"(473mm)

Features

- Open arms.
- Upholstered seat.
- Maple hardwood frame. Seat frame rails are mortise and tenoned, cross locked with dowels.
- Seat is 1 3/4"(45mm) HR foam over a webbed panel.
- COM yardage: 0.75
- COL square footage: 13.5
- Available on RUSH.

To Order, Specify:

- 1) Product number.
- 2) Fabric surface and color.
- 3) Wood finish color.

CAL 133 Option:

Add -F to the product number, and add \$106.30 list.

Maple	8483-00	\$1207.09	\$1229.53	\$1238.98	\$1262.59	\$1279.13	\$1398.43	\$1439.76	\$1554.34	\$1530.72	\$1684.03
-------	---------	-----------	-----------	-----------	-----------	-----------	-----------	-----------	-----------	-----------	-----------

**Scroll Arm,
Slat Back**

8483-00

Dimensions

SH: 18 1/4"(464mm)
H: 32 5/8"(829mm)
D: 22 3/4"(578mm)
W: 22 3/4"(578mm)
AH: 26 3/8"(670mm)
SW: 19 1/2"(495mm)
SD: 18 5/8"(473mm)

Features

- Open arms.
- Upholstered seat.
- Maple hardwood frame. Seat frame rails are mortise and tenoned, cross locked with dowels.
- Seat is 1 3/4"(45mm) HR foam over a webbed panel.
- COM yardage: 0.75
- COL square footage: 13.5

To Order, Specify:

- 1) Product number.
- 2) Fabric surface and color.
- 3) Wood finish color

CAL 133 Option:

Add -F to the product number, and add \$106.30 list.

Maple	8183-00	\$1207.09	\$1244.89	\$1279.14	\$1334.63	\$1370.07	\$1448.03	\$1498.81	\$1641.74	\$1937.03	\$2132.85
-------	---------	-----------	-----------	-----------	-----------	-----------	-----------	-----------	-----------	-----------	-----------

**Scroll Arm,
Upholstered Back**

8183-00

Dimensions

SH: 18 1/4"(464mm)
H: 32 5/8"(829mm)
D: 23 1/4"(591mm)
W: 22 3/4"(578mm)
AH: 26 3/8"(670mm)
SW: 19 1/2"(495mm)
SD: 18 1/4"(464mm)

Features

- Open arms.
- Upholstered seat and back.
- Maple hardwood frame. Seat frame rails are mortise and tenoned, cross locked with dowels.
- Seat is 1 3/4"(45mm) HR foam over a webbed panel.
- The upholstered back frame insert is webbed and padded with 1"(25mm) thick foam.
- COM yardage: 1.25
- COL square footage: 22.5
- Available on RUSH.

To Order, Specify:

- 1) Product number.
- 2) Fabric surface and color.
- 3) Wood finish color.

CAL 133 Option:

Add -F to the product number, and add \$106.30 list.

Stain Repellent Option: To specify, add -P to end of the product number and add \$36.61 list.

Example: 8583-00-P

Moisture Barrier Option: To specify add -D to end of the product number and add \$48.42 list.

Example: 8583-00-D

NOTE: Stain repellent and moisture barrier are not available on leather or faux leather.

For available fabrics, refer to surfaces.haworth.com.

Forenze Seating

Guest/Occasional Seating

Base/ Frame	Number	Fabric Grade		C	D	E	F	G	H	Leather Grade A	Leather Grade B
		A	B								
Maple	8584-00	\$1207.09	\$1229.53	\$1238.98	\$1262.59	\$1279.13	\$1398.43	\$1439.76	\$1554.34	\$1530.72	\$1684.03

**Cabriole Arm,
Star Back**

8584-00

Dimensions

SH: 18 1/4"(464mm)
H: 32 5/8"(829mm)
D: 22 3/4"(578mm)
W: 22 3/4"(578mm)
AH: 26 1/2"(673mm)
SW: 19 1/2"(495mm)
SD: 18 5/8"(473mm)

Features

- Open arms.
- Upholstered seat.
- Maple hardwood frame. Seat frame rails are mortise and tenoned, cross locked with dowels.
- Seat is 1 3/4"(45mm) HR foam over a webbed panel.
- COM yardage: 0.75
- COL square footage: 13.5
- Available on RUSH.

To Order, Specify:

- 1) Product number.
- 2) Fabric surface and color.
- 3) Wood finish color.

CAL 133 Option:

Add -F to the product number, and add \$106.30 list.

Maple	8484-00	\$1207.09	\$1229.53	\$1238.98	\$1262.59	\$1279.13	\$1398.43	\$1439.76	\$1554.34	\$1530.72	\$1684.03
-------	---------	-----------	-----------	-----------	-----------	-----------	-----------	-----------	-----------	-----------	-----------

**Cabriole Arm,
Slat Back**

8484-00

Dimensions

SH: 18 1/4"(464mm)
H: 32 5/8"(829mm)
D: 22 3/4"(578mm)
W: 22 3/4"(578mm)
AH: 26 1/2"(673mm)
SW: 19 1/2"(495mm)
SD: 18 5/8"(473mm)

Features

- Open arms.
- Upholstered seat.
- Maple hardwood frame. Seat frame rails are mortise and tenoned, cross locked with dowels.
- Seat is 1 3/4"(45mm) HR foam over a webbed panel.
- COM yardage: 0.75
- COL square footage: 13.5

To Order, Specify:

- 1) Product number.
- 2) Fabric surface and color.
- 3) Wood finish color.

CAL 133 Option:

Add -F to the product number, and add \$106.30 list.

Maple	8184-00	\$1207.09	\$1244.89	\$1279.14	\$1334.63	\$1370.07	\$1448.03	\$1498.81	\$1641.74	\$1937.03	\$2132.85
-------	---------	-----------	-----------	-----------	-----------	-----------	-----------	-----------	-----------	-----------	-----------

**Cabriole Arm,
Upholstered Back**

8184-00

Dimensions

SH: 18 1/4"(464mm)
H: 32 5/8"(829mm)
D: 23 1/4"(591mm)
W: 22 3/4"(578mm)
AH: 26 1/2"(673mm)
SW: 19 1/2"(495mm)
SD: 18 1/4"(464mm)

Features

- Open arms.
- Upholstered seat and back.
- Maple hardwood frame. Seat frame rails are mortise and tenoned, cross locked with dowels.
- Seat is 1 3/4"(45mm) HR foam over a webbed panel.
- The upholstered back frame insert is webbed and padded with 1"(25mm) thick foam.
- COM yardage: 1.25
- COL square footage: 22.5
- Available on RUSH.

To Order, Specify:

- 1) Product number.
- 2) Fabric surface and color.
- 3) Wood finish color.

CAL 133 Option:

Add -F to the product number, and add \$106.30 list.

Stain Repellent Option: To specify, add -P to end of the product number and add \$36.61 list.

Example: 8584-00-P

Moisture Barrier Option: To specify add -D to end of the product number and add \$48.42 list.

Example: 8584-00-D

NOTE: Stain repellent and moisture barrier are not available on leather or faux leather.

For available fabrics, refer to surfaces.haworth.com.

Openest Collection

Plume Screens

Plume 3

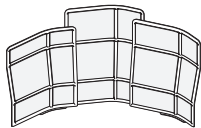

SON-3

Dimensions

H: 65"(1651mm)
 D: 34.5"(876mm)
 W: 125.75"(3194mm)
 (Outside)
 113.5"(2883mm)
 (Inside)

Features

- Includes:
 - (1) 57"(1448mm)H x 50"(1270mm)W screen,
 - (1) 65"(1651mm)H x 50"(1270mm)W screen,
 - (1) 61"(1549mm)H x 50"(1270mm)W screen.
- All screens are connected together, not interchangeable.
- Available in King, Class and Maya fabrics only; COM not available.
- Floor support and screen connectors in same color.

To Order, Specify:

- Product number.
- Inner material.
- Outer Material.
- Trim color.

Number	Fabric Grade C	D
SON-3	\$8112.00	\$9360.00

Plume 6

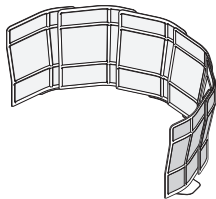

SON-6

Dimensions

H: 57"(1448mm)
 D: 84"(2134mm)
 W: 143.75"(3651mm)
 (Outside)
 132"(3353mm)
 (Inside)

Features

- Includes:
 - (6) 57"(1448mm)H x 50"(1270mm)W screens.
- All screens are connected together, not interchangeable.
- Available in King, Class and Maya fabrics only; COM not available.
- Floor support and screen connectors in same color.

To Order, Specify:

- Product number.
- Inner material.
- Outer Material.
- Trim color.

SON-6	\$15600.00	\$17680.00
-------	------------	------------

Plume 9

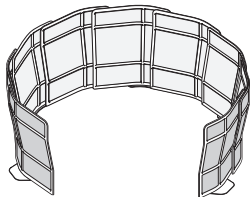

SON-9

Dimensions

H: 57"(1448mm)
 D: 128.5"(3264mm)
 W: 146.75"(3727mm)
 (Outside)
 131.25"(3334mm)
 (Inside)

Features

- Includes:
 - (9) 57"(1448mm)H x 50"(1270mm)W screens.
- All screens are connected together, not interchangeable.
- Available in King, Class and Maya fabrics only; COM not available.
- Floor support and screen connectors in same color.

To Order, Specify:

- Product number.
- Inner material.
- Outer Material.
- Trim color.

SON-9	\$23400.00	\$26000.00
-------	------------	------------

Note: For mixed grade fabric surfaces, pricing will be determined by the sum of the upcharges. Please refer to the electronic design and specification tools for these prices.

Note: The Openest Plume screen is made with polyester fabric adhered to a polyester core. The screen is compliant with UL-1286 flammability requirements and California Technical Bulletin TB-117-2013 requirements. The fabric covering is compliant with NFPA 701 requirements. Consult your local code authority to assure that screens are compliant prior to installation.

Note: For additional Openest products, details and specifications please refer to the Openest Price List.

Openest Collection

Feather Sofa

Feather – Symmetrical

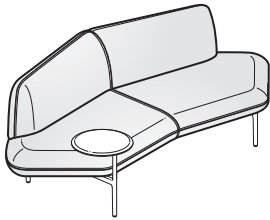

SOSS-1-RW

Dimensions

Sofa

SH: 16.5"(419mm)
 TH: 30.25"(768mm)
 SD: 25"(635mm)
 TD: 37"(940mm)
 W: 87"(2210mm)

Table

H: 19.5"(495mm)
 D: 15.75"(400mm)

Features

- Includes: Sofa with specifiable top-stitch thread and optional side mount table.
- Legs: Painted cast aluminum.
- Optional table:
 - Can be right-side or left-side mounted.
 - Rotates 360°
 - Available in Black, Polar, Stormy or Vapor painted MDF or planked wood in White Oak or Walnut.
 - Planked wood tops are designed to be unique, using solid wood planks with a clear, low-gloss finish showing natural variation.
- COM yardage: 6.5

To Order, Specify:

1) Product number, including:

1 Surface Material:

- 1 Leather
- 2 Fabric
- 3 Faux Leather

2 Table Option:

- N No Table
- R Right Hand Table
- L Left Hand Table

- 2) Surface color.
- 3) Thread color.
- 4) Leg color.
- 5) Table finish (if applicable).

Specification Tips

- Fabric will be applied railroaded.
- Linear or patterned fabric is not recommended due to the manner in which fabric is applied.

Description	Number 1 2	Fabric Grade		C	D	E	F	G	H	Leather Grade A	Leather Grade B
		A	B								
Without Table	SOSS- -N	\$3120.00	\$3296.80	\$3494.40	\$3640.00	\$3952.00	\$4108.00	\$4446.00	\$4550.00	\$6162.00	\$7410.00
With Painted MDF Table	SOSS- -P	3733.60	3910.40	4108.00	4253.60	4565.60	4721.60	5059.60	5163.60	6775.60	8023.60
With Wood Table - White Oak	SOSS- -W	4316.00	4492.80	4690.40	4836.00	5148.00	5304.00	5642.00	5746.00	7358.00	8606.00
With Wood Table - Walnut	SOSS- -W	4394.00	4570.80	4768.40	4914.00	5226.00	5382.00	5720.00	5824.00	7436.00	8684.00

Feather – Asymmetrical

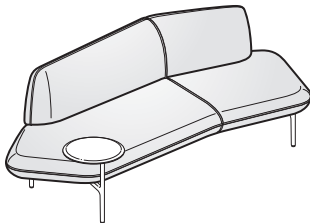

SOSR-1-RW

Dimensions

Sofa

SH: 16.5"(419mm)
 TH: 30.25"(768mm)
 SD: 25"(635mm)
 TD: 37"(940mm)
 W: 92"(2337mm)

Table

H: 19.5"(495mm)
 D: 15.75"(400mm)

Features

- Includes: Sofa with specifiable top-stitch thread and optional side mount table.
- Legs: Painted cast aluminum.
- Optional table:
 - Can be right-side or left-side mounted.
 - Rotates 360°
 - Available in Black, Polar, Stormy or Vapor painted MDF or planked wood in White Oak or Walnut.
 - Planked wood tops are designed to be unique, using solid wood planks with a clear, low-gloss finish showing natural variation.
- COM yardage: 6.75

To Order, Specify:

1) Product number, including:

1 Handedness:

- R Right hand
- L Left hand

2 Surface Material:

- 1 Leather
- 2 Fabric
- 3 Faux Leather

3 Table Option:

- N No Table
- R Right Hand Table
- L Left Hand Table

- 2) Surface color.
- 3) Thread color.
- 4) Leg color.
- 5) Table finish (if applicable).

Specification Tips

- Fabric will be applied railroaded.
- Linear or patterned fabric is not recommended due to the manner in which fabric is applied.
- Handedness determined when seated on sofa.

Description	Number 1 2 3	Fabric Grade		C	D	E	F	G	H	Leather Grade A	Leather Grade B
		A	B								
Without Table	SOS - -N	\$3172.00	\$3359.20	\$3562.00	\$3770.00	\$4082.00	\$4264.00	\$4628.00	\$4706.00	\$6208.80	\$7488.00
With Painted MDF Table	SOS - -P	3785.60	3972.80	4175.60	4383.60	4695.60	4877.60	5241.60	5319.60	6822.40	8101.60
With Wood Table - White Oak	SOS - -W	4368.00	4555.20	4758.00	4966.00	5278.00	5460.00	5824.00	5902.00	7404.80	8684.00
With Wood Table - Walnut	SOS - -W	4446.00	4633.20	4836.00	5044.00	5356.00	5538.00	5902.00	5980.00	7482.80	8762.00

Note: For additional Openest products, details and specifications please refer to the Openest Price List.

Openest Collection

Chick Pouf

Chick Pouf with Back

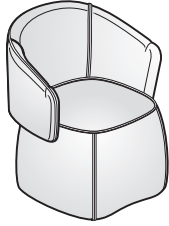

SOPB-22

Dimensions

SH: 18"(457mm)
 TH: 37.75"(959mm)
 SD: 18.75"(476mm)
 TD: 25.2"(640mm)
 W: 26"(660mm)

Features

- Includes: Seat and back with specifiable top-stitch thread and puck colors.
- Seat back flips up and down.
- Pull tab to flip back up or down available in orange only.
- COM yardage:
 Inner/Outer surfaces matching: 3.5
 Inner Back and Seat only: 1.5
 Outer Back and Base only: 2.0

Specification Tip

- Linear or patterned fabric is not recommended due to the manner in which fabric is applied.

To Order, Specify:

1) Product number, including:

1 Inner Surface Material:

- 1 Leather
- 2 Fabric
- 3 Faux Leather

2 Outer Surface Material:

- 1 Leather
- 2 Fabric
- 3 Faux Leather

- 2) Inner Surface Color (Seat, inside back).
- 3) Outer Surface Color (Base, outer back).
- 4) Thread color.
- 5) Puck color.

Number 1 2	Fabric Grade		C	D	E	F	G	H	Leather Grade A	Leather Grade B
	A	B								
SOPB-■ ■	\$1820.00	\$1924.00	\$2064.40	\$2194.40	\$2402.40	\$2511.60	\$2756.00	\$2834.00	\$3432.01	\$4082.01

Chick Pouf without Back

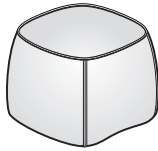

SOPN-22

Dimensions

H: 18"(457mm)
 D: 22.5"(572mm)
 W: 23.25"(591mm)

Features

- Includes: Seat/Base only with specifiable top-stitch thread color.
- COM yardage:
 Seat and Base matching: 2.0
 Seat only: .75
 Base only: 2.0

Specification Tip

- Linear or patterned fabric is not recommended due to the manner in which fabric is applied.

To Order, Specify:

1) Product number, including:

1 Inner Surface Material:

- 1 Leather
- 2 Fabric
- 3 Faux Leather

2 Outer Surface Material:

- 1 Leather
- 2 Fabric
- 3 Faux Leather

- 2) Inner Surface Color (Seat).
- 3) Outer Surface Color (Base).
- 4) Thread color.

Number 1 2	Fabric Grade		C	D	E	F	G	H	Leather Grade A	Leather Grade B
	A	B								
SOPN-■ ■	\$878.80	\$936.00	\$1024.40	\$1118.00	\$1242.80	\$1314.56	\$1482.00	\$1523.60	\$2027.29	\$2520.25

Note: For different fabric grades on seat/inner back and the base/outer back, pricing will be determined by the sum of the upcharges. (ie. When choosing a Grade B fabric for the seat (and inner back) and a Grade C for the base (and outer back), the final price will reflect the upcharge for a Grade B seat plus the upcharge for a Grade D base.)

Note: For additional Openest products, details and specifications please refer to the Openest Price List.

Openest Collection

Sprig Tables

Rectangle

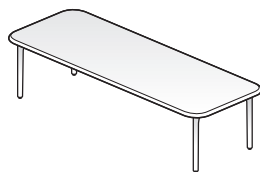

SORA-5320-P

Features

- Includes: Table top and legs.
- Top available in Black, Polar, Stormy or Vapor painted MDF or planked wood in White Oak or Walnut.
- Planked wood tops are designed to be unique, using solid wood planks with a clear, low-gloss finish showing natural variation.
- Legs: Painted cast aluminum.

To Order, Specify:

1) Product number, including:

① Surface Material:

P Painted MDF

W Planked Wood

2) Top color.

3) Leg color.

Height	Depth	Width	Number ①	Painted	White Oak	Walnut
12"(305mm)	20"(508mm)	53"(1346mm)	SORA-5320-■	\$863.20	\$2158.00	\$2626.00

Round



SODC-1616-P



SODB-2424-P

Features

- Includes: Table top and legs.
- Top available in Black, Polar, Stormy, or Vapor painted MDF or planked wood in White Oak or Walnut.
- Planked wood tops are designed to be unique, using solid wood planks with a clear, low-gloss finish showing natural variation.
- Legs: Painted cast aluminum.

To Order, Specify:

1) Product number, including:

① Surface Material:

P Painted MDF

W Planked Wood

2) Top color.

3) Leg color.

Height	Diameter	Number ①	Painted	White Oak	Walnut
17"(432mm)	16"(406mm)	SODC-1616-■	\$613.60	\$1248.00	\$1352.00
14"(356mm)	24"(610mm)	SODB-2424-■	676.00	1674.40	1924.00

Note: For additional Openest products, details and specifications please refer to the Openest Price List.

This page intentionally blank

Poppy-At-A-Glance

Designer Patricia Urquiola

Fabric Linear or patterned fabric not recommended due to the manner in which the material is applied. Because of the nature of the chair, materials that have more fibers or woolen spun yarn construction, such as Cotswold, King, Class and Maya, tend to upholster well on Poppy. Synthetic fibers, or textiles with heavy back coatings, tend to be more difficult to upholster and consequently may restrict some COMs.

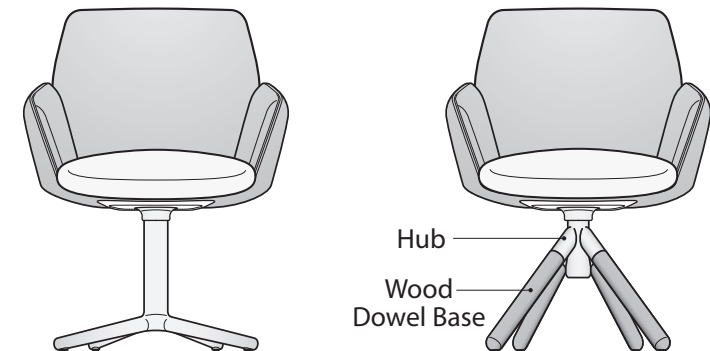

Poppy

Designer: Patricia Urquiola

Four Star Base with Glides



SPG-11-4

Dimensions

SH: 18"(457mm)
 H: 33"(838mm)
 D: 26.75"(679mm)
 W: 26.75"(679mm)
 SW: 18"(457mm)
 SD: 18"(457mm)
 AH: 25"(635mm)

Features

- Back and arms: Upholstered in matching upholstery.
- Seat: Standard upholstered. Upholstery can match or complement back and arms.
- Base: Four star aluminum base.
 –Standard with glides; felt pads included
 –Available in Black (TR-F) or Smooth Plaster (TR-PLS)
- Seat swivels 360°.
- COM yardage / COL square footage: 2.0/55
 Back/Arms: 1.5/40
 Seat: 0.5/15

Specification Tip

- Linear or patterned fabric is not recommended due to the manner in which fabric is applied.

To Order, Specify:

- 1) Product number, including;

1 Seat Upholstery:

- 1 Leather
- 2 Fabric
- 3 Faux Leather

2 Back/Arm Upholstery:

- 1 Leather
- 2 Fabric
- 3 Faux Leather

- 2) Seat surface and color.
- 3) Back/arm surface and color.
- 4) Trim color.
 TR-F Black
 TR-PLS Smooth Plaster, add **\$55.00** list.

Number 1 2	Fabric Grade		C	D	E	F	G	H	Leather Grade A	Leather Grade B
	A	B								
SPG-■ ■ -4	\$1560.00	\$1630.00	\$1690.00	\$1775.00	\$1875.00	\$1925.00	\$1950.00	\$2000.00	\$1965.00	\$2075.00

Five Star Base with Casters



SPG-11-5

Dimensions

SH: 16"-21"
 (406mm-533mm)
 H: 31"-36"
 (787mm-914mm)
 D: 26.75"(679mm)
 W: 26.75"(679mm)
 SW: 18"(457mm)
 SD: 18"(457mm)
 AH: 23"-28"
 (584mm-711mm)

Features

- Back and arms: Upholstered in matching upholstery.
- Seat: Standard upholstered. Upholstery can match or complement back and arms.
- Base: Five star aluminum base.
 –Available in Black (TR-F) or Smooth Plaster (TR-PLS)
 –Casters match base color; Smooth Plaster casters are two-tone with graphite tread.
- Soft casters available in black only, add **\$25.00** list.
- Seat swivels 360°.
- Pneumatic height adjustment of 5"(127mm).
- COM yardage / COL square footage: 2.0/55
 Back/Arms: 1.5/40
 Seat: 0.5/15

Specification Tip

- Linear or patterned fabric is not recommended due to the manner in which fabric is applied.

To Order, Specify:

- 1) Product number, including;

1 Seat Upholstery:

- 1 Leather
- 2 Fabric
- 3 Faux Leather

2 Back/Arm Upholstery:

- 1 Leather
- 2 Fabric
- 3 Faux Leather

- 2) Seat surface and color.
- 3) Back/arm surface and color.
- 4) Trim color.
 TR-F Black
 TR-PLS Smooth Plaster, add **\$55.00** list.

Soft Casters:

Change the 6th digit in the product number to **6**, and add **\$25.00** list.
Example: SPG-22-6

Number 1 2	Fabric Grade		C	D	E	F	G	H	Leather Grade A	Leather Grade B
	A	B								
SPG-■ ■ -5	\$1650.00	\$1720.00	\$1780.00	\$1865.00	\$1965.00	\$2015.00	\$2040.00	\$2090.00	\$2055.00	\$2165.00

Poppy

Designer: Patricia Urquiola

Wood Base



SPG-11-W

Dimensions

- SH: 18"(457mm)
- H: 33"(838mm)
- D: 24.25"(616mm)
- W: 24.25"(616mm)
- SW: 18"(457mm)
- SD: 18"(457mm)
- AH: 25"(635mm)

Features

- Back and arms: Upholstered in matching upholstery.
- Seat: Standard upholstered. Upholstery can match or complement back and arms.
- Base: Wooden dowel legs with painted aluminum hub.
 - Wooden legs available in Clear on Oak (M5-W35), Clear on Walnut (M6-W35) and Ink on Ash (M7-W43)
 - Wooden legs standard with glides; felt pads included
 - Hub available in Black (TR-F) or Smooth Plaster (TR-PLS)
- Seat swivels 360°.
- COM yardage / COL square footage: 2.0/55
 - Back/Arms: 1.5/40
 - Seat: 0.5/15

Specification Tip

- Linear or patterned fabric is not recommended due to the manner in which fabric is applied.

To Order, Specify:

- 1) Product number, including;

1 Seat Upholstery:

- 1 Leather
- 2 Fabric
- 3 Faux Leather

2 Back/Arm Upholstery:

- 1 Leather
- 2 Fabric
- 3 Faux Leather

- 2) Seat surface and color.
- 3) Back/arm surface and color.
- 4) Trim color.
 - TR-F Black
 - TR-PLS Smooth Plaster, add **\$40.00** list.
- 5) Wood finish.

Description	Number 1 2	A	B	C	D	E	F	G	H	Leather	Leather
										Grade A	Grade B
Ink on Ash	SPG-■ ■ -W	\$2025.00	\$2095.00	\$2155.00	\$2240.00	\$2340.00	\$2390.00	\$2415.00	\$2465.00	\$2430.00	\$2540.00
Clear on Oak	SPG-■ ■ -W	2055.00	2125.00	2185.00	2270.00	2370.00	2420.00	2445.00	2495.00	2460.00	2570.00
Clear on Walnut	SPG-■ ■ -W	2065.00	2135.00	2195.00	2280.00	2380.00	2430.00	2455.00	2505.00	2470.00	2580.00

This page intentionally blank

Harbor Work Lounge At-A-Glance

Designer

Nicolai Czumaj-Bront of the Haworth Design Studio

Awards/Achievements

Best of Neocon 2013: Silver - Seating/Collaborative Work
 Good Design Award 2013 - Furniture

Inner Shell
 (Upholstered Only)

Outer Shell
 (Upholstered,
 Laminate, Wood Veneer)

Caster Options:

- Hard or Soft (Black)
- Hard (Fog & Gray)
- Glide

Fully Upholstered

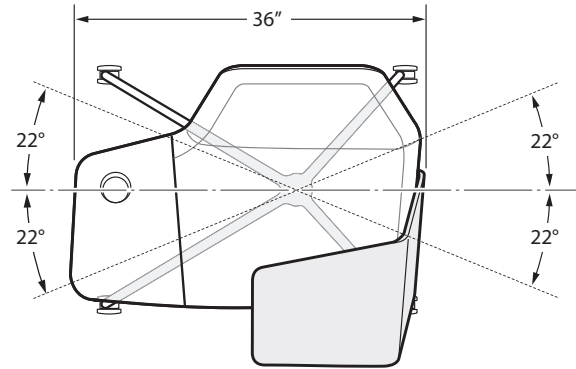
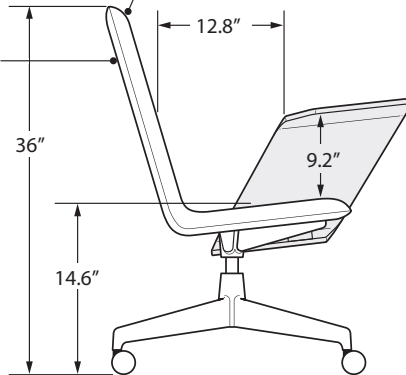

Cup Holder Fully Upholstered

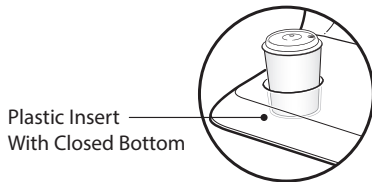

Cup Holder Partially Upholstered

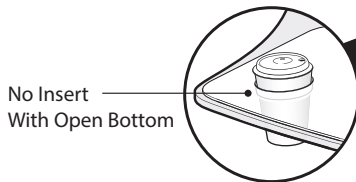

Partially Upholstered

Wing:
 Available as Left
 or Right handed.
 Noble Fabric Only

Tablet:
 Laminate or Wood

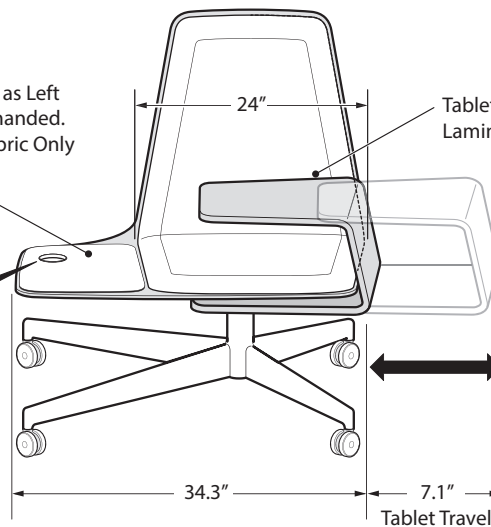

Harbor Work Lounge

Fully Upholstered, Cast Aluminum Base

Lounge Chair



SHL-22-1R10



SHL-22-1R12

Dimensions

SH: 14.6" (371mm)
 H: 36" (9147mm)
 W: 35.3" (897mm) w/o tablet
 36" (914mm) w/tablet
 SD: 16" (406mm)
 SW: 24" (610mm)

Features

- Includes: Upholstered outer and inner shell, right or left wing with cup holder, optional tablet arm and cast aluminum base.
- Fully upholstered lounge chair will be completely upholstered (No laminate or wood veneer visible). Upholstery must be the same material type for inner and outer shell.
- Outer Shell: Upholstered one-piece molded plywood shell.
- Inner Shell: Upholstered molded foam 1.25"(31.75mm) thick.
- Base: Cast-aluminum.
 - Standard painted in Black, Accent Orange, Smooth Plaster or with optional polished aluminum.
 - Swivels 22° in each direction and features a self-returning mechanism.
- Casters: Available with hard black, soft black or hard two-tone.
- Glides: Optional glides ship with plastic and felt tips.
- Seat Wing: Upholstered in Noble performance suede only. Handedness determined by seated position.
- Cup Holder: Available in Chalk or Black plastic.
- Tablet Arm: Optional tablet arm is a one-piece molded plywood form, available in laminate or wood veneer.
 - Laminate finishes include Linen, Putty or Charcoal.
 - Wood veneer finishes include Rift-Cut White Oak or Walnut.
 - Tablet slides 7.1"(180.3mm) to the side.
 - Available in right or left-hand configuration (opposite of seat wing specification).
- COM Yardage / COL square footage
 Inner/Outer Shell: 2.0/28

To Order, Specify:

1) Product number, including:

1 Base Option:

- 1** Hard Caster
- 2** Soft Caster
- T** Two-Tone
- G** Glides, add **\$150.80** list

2 Wing Option:

- R** Right Wing
- L** Left Wing

3 Tablet Option:

- 0** No Tablet
- 1** Wood Tablet, add **\$1435.20** list
- 2** Laminate Tablet, add **\$1435.20** list

2) Inner shell material.

3) Outer shell material.

4) Base color
 Polished aluminum, add **\$78.00** list.

5) Wing surface and color.

6) Cup holder color.

7) Tablet surface and color.

	Number	Fabric Grade									Leather Grade A	Leather Grade B		
		1	2	3	A	B	C	D	E	F			G	H
Leather	SHL-11-	■	■	1 ■	N/A	N/A	N/A	N/A	N/A	N/A	N/A	N/A	\$3234.40	\$3510.00
Fabric	SHL-22-	■	■	1 ■	\$2116.40	\$2187.12	\$2260.96	\$2336.88	\$2450.24	\$2568.80	\$2692.56	\$2823.60	N/A	N/A
Faux Leather	SHL-33-	■	■	1 ■	\$2116.40	\$2187.12	\$2260.96	\$2336.88	\$2450.24	\$2568.80	\$2692.56	\$2823.60	N/A	N/A

The following options require modification of the product number.

CAL 133

To specify, add **F** to the end of the product number; **Example:** SHL-22-1R10F (add **\$353.60** list)

NOTE: For available fabrics please refer to surfaces.haworth.com.

Harbor Work Lounge

Fully Upholstered, Cast Aluminum Base

Ottoman



SHO-22-G

Dimensions

H: 16.5"-19.5"
(419mm-495mm)
D: 17.9" (455mm)
W: 24.9" (632mm)

Features

- Includes: Fully upholstered surface, cup holder and cast aluminum base.
- Fully upholstered ottoman will be completely upholstered (no laminate or wood veneer visible).
- Surface: Upholstered one-piece molded plywood.
- Cushion: Upholstered molded foam 1.25"(31.75mm) thick.
- Cast Aluminum Base: Features 3.0"(76.2mm) height adjustment.
-Standard painted in Black, Accent Orange, Smooth Plaster or with optional polished aluminum.
- Cup holder: Swing out open hole cup holder standard in polished aluminum.
- Casters: Available with hard black, soft black or hard two-tone.
- Glides: Optional glides ship with plastic and felt tips.
- COM Yardage / COL square footage: 1.0/12

To Order, Specify:

- 1) Product number, including:
 - 1** Base Option:
 - 1** Hard Caster
 - 2** Soft Caster
 - T** Two-Tone
 - G** Glides, add **\$150.80** list
- 2) Surface material.
- 3) Base color
Polished aluminum, add **\$78.00** list.

	Number ①	Fabric Grade								Leather Grade A	Leather Grade B
		A	B	C	D	E	F	G	H		
Leather	SHO-11-■	N/A	N/A	N/A	N/A	N/A	N/A	N/A	N/A	\$2144.48	\$2323.36
Fabric	SHO-22-■	\$1414.40	\$1461.20	\$1509.04	\$1558.96	\$1632.80	\$1709.76	\$1790.88	\$1876.16	N/A	N/A
Faux Leather	SHO-33-■	\$1414.40	\$1461.20	\$1509.04	\$1558.96	\$1632.80	\$1709.76	\$1790.88	\$1876.16	N/A	N/A

The following options require modification of the product number.

CAL 133

To specify, add **F** to the end of the product number; **Example:** SHO-22-1F (add **\$135.20** list)

NOTE: For available fabrics please refer to surfaces.haworth.com.

Harbor Work Lounge

Partially Upholstered, Cast Aluminum Base

Lounge Chair



SHL-25-1L10



SHL-25-1L12

Dimensions

SH: 14.4" (366mm)
 H: 35.5" (902mm)
 W: 34.3" (8714mm) w/o tablet
 35.5" (902mm) w/tablet
 SD: 16" (406mm)
 SW: 24" (610mm)

Features

- Includes: Laminate or wood veneer outer shell, fabric inner shell, right or left wing with cup holder, optional tablet arm and cast aluminum base.
- Outer Shell: One-piece molded plywood shell with exposed laminate or wood veneer.
- Inner Shell: Upholstered molded foam 1" (25.4 mm) thick with exposed laminate or wood veneer perimeter.
- Base: Cast-aluminum.
 - Standard painted in Black, Accent Orange, Smooth Plaster or with optional polished aluminum.
 - Swivels 22° in each direction and features a self-returning mechanism.
- Casters: Available with hard black, soft black or hard two-tone.
- Glides: Optional glides ship with plastic and felt tips.
- Seat Wing: Upholstered in Noble performance suede only. Handedness determined by seated position.
- Cup Holder: Open hole - no finish options.
- Tablet Arm: Optional tablet arm is a one-piece molded plywood form, available in laminate or wood veneer.
 - Laminate finishes include Linen, Putty or Charcoal.
 - Wood veneer finishes include Rift-Cut White Oak or Walnut.
 - Tablet slides 7.1" (180.3mm) to the side.
 - Available in right or left-hand configuration (opposite of seat wing specification).
- COM Yardage / COL square footage
 Inner Shell: 1.25/22

To Order, Specify:

1) Product number, including:

1 Base Option:

- 1** Hard Caster
- 2** Soft Caster
- T** Two-Tone
- G** Glides, add **\$150.80** list

2 Wing Option:

- R** Right Wing
- L** Left Wing

3 Tablet Option:

- 0** No Tablet
- 1** Wood Tablet, add **\$1435.20** list
- 2** Laminate Tablet, add **\$1435.20** list

- 2) Inner shell material.
- 3) Outer shell material.
- 4) Base color
Polished aluminum, add **\$78.00** list.
- 5) Wing surface and color.
- 6) Tablet surface and color.

	Number	Laminate Grade A Fabric Grade								Leather Grade A	Leather Grade B			
		1	2	3	A	B	C	D	E			F	G	H
Leather	SHL-15-	■	■	1 ■	N/A	N/A	N/A	N/A	N/A	N/A	N/A	N/A	\$3907.28	\$4182.88
Fabric	SHL-25-	■	■	1 ■	\$2789.28	\$2860.00	\$2933.84	\$3009.76	\$3123.12	\$3241.68	\$3365.44	\$3496.48	N/A	N/A
Faux Leather	SHL-35-	■	■	1 ■	\$2789.28	\$2860.00	\$2933.84	\$3009.76	\$3123.12	\$3241.68	\$3365.44	\$3496.48	N/A	N/A

	Number	Wood Fabric Grade								Leather Grade A	Leather Grade B			
		1	2	3	A	B	C	D	E			F	G	H
Leather	SHL-14-	■	■	1 ■	N/A	N/A	N/A	N/A	N/A	N/A	N/A	N/A	\$3950.96	\$4226.56
Fabric	SHL-24-	■	■	1 ■	\$2832.96	\$2903.68	\$2977.52	\$3053.44	\$3166.80	\$3285.36	\$3409.12	\$3540.16	N/A	N/A
Faux Leather	SHL-34-	■	■	1 ■	\$2832.96	\$2903.68	\$2977.52	\$3053.44	\$3166.80	\$3285.36	\$3409.12	\$3540.16	N/A	N/A

The following options require modification of the product number.

CAL 133

To specify, add **F** to the end of the product number; **Example:** SHL-25-1R10**F** (add **\$208.00** list)

NOTE: For available fabrics please refer to surfaces.haworth.com.

Harbor Work Lounge

Partially Upholstered, Cast Aluminum Base

Ottoman



SHO-25-G

Dimensions

H: 16.25"-19.25"
(413mm-489mm)
D: 17.9" (455mm)
W: 24.9" (632mm)

Features

- Includes: Laminate or wood veneer surface, fabric cushion, cup holder and cast aluminum base.
- Upholstered one-piece molded plywood.
- Cushion: Upholstered molded foam 1"(25.4mm) thick with exposed laminate or wood veneer perimeter.
- Cast Aluminum Base: Features 3.0"(76.2mm) height adjustment.
 - Standard painted in Black, Accent Orange, Smooth Plaster or with optional polished aluminum.
- Cup holder: Swing out open hole cup holder standard in polished aluminum.
- Casters: Available with hard black, soft black or hard two-tone.
- Glides: Optional glides ship with plastic and felt tips.
- COM Yardage / COL square footage: 1.0/10

To Order, Specify:

1) Product number, including:

1 Base Option:

- 1** Hard Caster
- 2** Soft Caster
- T** Two-Tone
- G** Glides, add **\$150.80** list

2) Inner surface material.

3) Outer surface material.

4) Base color
Polished aluminum, add **\$78.00** list.

	Number ①	Laminate Grade A Fabric Grade								Leather Grade A	Leather Grade B
		A	B	C	D	E	F	G	H		
Leather	SHO-15-■	N/A	N/A	N/A	N/A	N/A	N/A	N/A	N/A	\$2311.92	\$2490.80
Fabric	SHO-25-■	\$1581.84	\$1628.64	\$1676.48	\$1726.40	\$1800.24	\$1877.20	\$1958.32	\$2043.60	N/A	N/A
Faux Leather	SHO-35-■	\$1581.84	\$1628.64	\$1676.48	\$1726.40	\$1800.24	\$1877.20	\$1958.32	\$2043.60	N/A	N/A

	Number ①	Wood Fabric Grade								Leather Grade A	Leather Grade B
		A	B	C	D	E	F	G	H		
Leather	SHO-14-■	N/A	N/A	N/A	N/A	N/A	N/A	N/A	N/A	\$2336.88	\$2515.76
Fabric	SHO-24-■	\$1606.80	\$1653.60	\$1701.44	\$1751.36	\$1825.20	\$1902.16	\$1983.28	\$2068.56	N/A	N/A
Faux Leather	SHO-34-■	\$1606.80	\$1653.60	\$1701.44	\$1751.36	\$1825.20	\$1902.16	\$1983.28	\$2068.56	N/A	N/A

The following options require modification of the product number.

CAL 133

To specify, add **F** to the end of the product number; **Example:** SHO-25-1F (add **\$135.20** list)

NOTE: For available fabrics please refer to surfaces.haworth.com.

Hello Seating

Lounge with Legs

Standard Arm

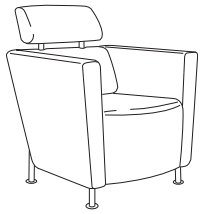

4854-0011

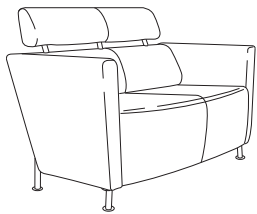

4854-0012

Dimensions

Lounge Chair

SH: 17 1/2"(445mm)
 H: 35"(889mm)
 D: 30 1/4"(768mm)
 W: 30 1/2"(775mm)
 AH: 9 1/2"(241mm)
 SW: 21 1/4"(540mm)
 SD: 20 1/4"(514mm)

Settee

SH: 17 1/2"(445mm)
 H: 35"(889mm)
 D: 30 1/4"(768mm)
 W: 56 1/2"(1435mm)
 AH: 9 1/2"(241mm)
 SW: 46 3/4"(1187mm)
 SD: 20 1/4"(514mm)

Features

- Available as single cushion lounge chair or double cushion settee.
 - Upholstered back/seat.
 - Passive lumbar back support.
 - Interior frame has glued and doweled joints, reinforced with screws and cleats.
 - Exposed metal legs.
 - Optional two fabrics/one fabric two colors available on seat and back.
 - Optional grommets available in both arms to accommodate accessories.
 - Optional accessories include cup holder and tablet arm.
 - Legs, back support uprights and optional grommets are available in TR-LE Metallic Silver only.
 - Settee in leather requires a vertical seam.
 - COM yardage / COL square footage:
 One Seat Lounge: 4.25/76.5
 Seat: 1.0/18.0
 Back and Arms: 3.25/58.7
 Two Seat Lounge: 7.0/126.0
 Seat: 1.75/31.5
 Back and Arms: 5.25/94.5
- Available on RUSH.

To Order, Specify:

- 1) Product number.
- 2) Fabric surface and color.
 or 2a. Fabric surface and color for seat.
 2b. Fabric surface and color for back and arms
- 3) Trim color for legs, back support uprights (grommets)
(Available in TR-LE Metallic Silver Only)

Leather Upholstery

Leather upholstery requires modification of the product number. Change the second digit to **7** and specify leather surface and color.
Example: 4754-0011

Description	Number	Fabric Grade								Leather Grade A	Leather Grade B
		A	B	C	D	E	F	G	H		
Lounge chair w/o grommets	4854-0011 ■	\$1880.32	\$2040.95	\$2177.96	\$2482.69	\$2570.09	\$2696.46	\$2871.27	\$3354.34	\$5024.43	\$ 6757.73
Lounge chair with grommets	4854-0011-G	1968.91	2129.54	2266.55	2571.28	2658.68	2785.05	2959.86	3442.93	5113.02	6846.32
Lounge chair with two fabrics/colors	4854-0011-T ■	1880.32	2201.58	2475.60	3085.06	3259.86	3512.60	3862.22	4828.36	8168.54	11635.14
Lounge chair with grommets/ two fabrics/two colors of same fabric	4854-0011-GT	1968.91	2290.17	2564.19	3173.65	3348.45	3601.19	3950.81	4916.95	8257.13	11723.73
Settee w/o grommets	4854-0012 ■	\$2684.66	\$2845.29	\$2982.30	\$3287.03	\$3374.43	\$4029.94	\$4319.31	\$5113.02	\$5828.77	\$ 7562.07
Settee with grommets	4854-0012-G	2773.25	2933.88	3070.89	3375.62	3463.02	4118.53	4407.90	5201.61	5917.36	7650.66
Settee with two fabrics/colors	4854-0012-T ■	2684.66	3005.92	3279.94	3889.40	4064.20	5375.22	5953.96	7541.38	8972.88	12439.48
Settee with grommets/ two fabrics/ two colors of same fabrics	4854-0012-GT	2773.25	3094.51	3368.53	3977.99	4152.79	5463.81	6042.55	7629.97	9061.47	12528.07

Stain Repellent Option

To specify, add **-P** to end of the product number and add **\$61.41** list.

Example: 4854-0011-P

Moisture Barrier Option

To specify, add **-D** to end of the product number and add **\$96.84** list.

Example: 4854-0011-D

NOTE: Stain repellent and moisture barrier are not available on leather or faux leather.

For available fabrics, refer to surfaces.haworth.com.

Hello Seating

Mobile Lounge

Standard Arm

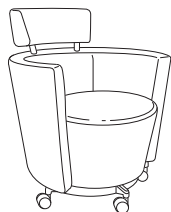

4855-0043

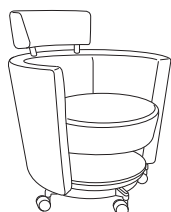

4855-0043-S



4855-0043-GSX

Dimensions

- SH: 17 1/4"(438mm)
- H: 34 3/4"(883mm)
- D: 26"(660mm)
- W: 30 3/4"(781mm)
- AH: 9 1/2"(241mm)
- SW: 18 3/4"(476mm)
- SD: 19 1/2"(495mm)

Features

- Upholstered back/seat.
 - 360° swivel base standard.
 - Passive lumbar back support.
 - Casters: Standard with two-tone hard casters.
 - Optional two-tone soft casters.
 - Optional two fabrics/two colors of same fabric available on seat and back.
 - Optional grommets to accommodate cup holder or tablet arm.
 - Optional shelf model available with lower molded plywood storage shelf.
 - Optional fully-loaded mobile lounge includes accessories as listed below.
 - Optional accessories include cup holder and tablet arm.
 - Swivel base, back support uprights and optional grommets are available in TR-LE Metallic Silver only.
 - COM yardage / COL square footage:
Lounge: 4.0/72.0
Seat: 1.0/18.0
Back and Arms: 3.75/67.5
 - Lounge w/Shelf: 4.0/72.0
Seat: 1.0/18.0
Back and Arms: 3.75/67.5
- Available on RUSH.

To Order, Specify:

- 1) Product number.
- 2) Fabric surface and color.
or 2a. Fabric surface and color for seat.
2b. Fabric surface and color for back and arms.
- 3) Trim color for base (grommets, cup holder).
(Available in TR-LE Metallic Silver Only)
- 4) Wood finish color for shelf (tablet arm/cup holder).

Leather Upholstery

Leather upholstery requires modification of the product number. Change the second digit to **7** and specify leather surface and color.
Example: 4755-0043

Description	Number	Fabric Grade								Leather Grade A	Leather Grade B
		A	B	C	D	E	F	G	H		
Upholstered/One Fabric and Color											
Upholstered	4855-0043	\$1853.16	\$1979.53	\$2089.39	\$2109.46	\$2129.54	\$2620.88	\$2785.05	\$3240.96	\$2645.68	\$3081.51
Upholstered/grommet	4855-0043-G	1941.75	2068.12	2177.98	2198.05	2218.13	2709.47	2873.64	3329.55	2734.27	3170.10
Upholstered/shelf	4855-0043-S	2071.66	2198.03	2307.89	2327.96	2348.04	2839.38	3003.55	3459.46	2864.18	3300.01
Upholstered/grommet/shelf	4855-0043-GS	2160.25	2286.62	2396.48	2416.55	2436.63	2927.97	3092.14	3548.05	2952.77	3388.60
Upholstered/Two Fabrics or One Fabric, Two Colors											
Upholstered	4855-0043-T	\$1853.16	\$2105.90	\$2325.62	\$2365.76	\$2405.92	\$3388.60	\$3716.94	\$4628.76	\$3438.20	\$4309.86
Upholstered/grommet	4855-0043-GT	1941.75	2194.49	2414.21	2454.35	2494.51	3477.19	3805.53	4717.35	3526.79	4398.45
Upholstered/shelf	4855-0043-ST	2071.66	2324.40	2544.12	2584.26	2624.42	3607.10	3935.44	4847.26	3656.70	4528.36
Upholstered/grommet/shelf	4855-0043-GST	2160.25	2412.99	2632.71	2672.85	2713.01	3695.69	4024.03	4935.85	3745.29	4616.95
Fully-Loaded Mobile Lounge											
Includes grommet, tablet arm, cup holder	4855-0043-GX	\$2285.45	\$2411.82	\$2521.68	\$2541.75	\$2561.83	\$3053.17	\$3217.34	\$3673.25	\$3077.97	\$3513.80
Includes grommet, shelf, tablet arm and cup holder	4855-0043-GSX	2503.95	2630.32	2740.18	2760.25	2780.33	3271.67	3435.84	3891.75	3296.47	3732.30
Includes grommet, tablet arm, cup holder in two fabrics/two colors	4855-0043-GTX	2285.45	2538.19	2757.91	2798.05	2838.21	3820.89	4149.23	5061.05	3870.49	4742.15
Includes grommet, shelf, tablet arm and cup holder in two fabrics/two colors of same fabric	4855-0043-GSTX	2503.95	2756.69	2976.41	3016.55	3056.71	4039.39	4367.73	5279.55	4088.99	4960.65

Soft Caster Option

Soft caster option requires modification of the product number. To specify, add **-2** to the product code.

Example: 4855-0043-2GST

Fully-Loaded Option*

Fully-Loaded Model Option requires modification of the product number.

To specify, add **-X** to the product code.

Example: 4855-0043-GX

Stain Repellent Option

To specify, add **-P** to end of the product number and add **\$61.41** list.

Example: 4855-0043-SP

Moisture Barrier Option

To specify, add **-D** to end of the product number and add **\$96.84** list.

Example: 4855-0043-SD

NOTE: Stain repellent and moisture barrier are not available on leather or faux leather.

For available fabrics, refer to surfaces.haworth.com.

Hello Seating

Accessories



4858-0001
(Tablet Arm)

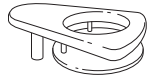

4858-0002
(Cup Holder)

Dimensions

Tablet Arm:
W: 12.68"(322.1mm)
L: 15"(381mm)

Cup Holder:
W: 5.47"(138.94mm)
L: 7.47"(189.61mm)

Features

- Plywood construction.
- Accessories are non-handed.
- Tablet arm and cup holder supports are available in TR-LE Metallic Silver only.
- Available on RUSH.

To Order, Specify:

- 1) Product number.
- 2) Wood finish color.
- 3) Trim color for metal trim.
(Available in TR-LE Metallic Silver Only)

Description	Number	Price
Fold Away Tablet Arm	4858-0001 ■	\$240.95
Cup Holder	4858-0002 ■	137.01

Mini-mobile

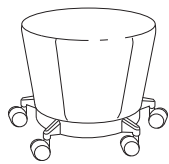

4856-0043

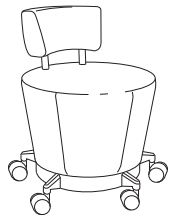

4856-0043-A

Dimensions

SH: 17 1/2"(445mm)
SD: 19 1/2"(495mm)

H: 26 3/4"(679mm)
AH: 9 1/4"(235mm)
OH: 26"(660mm)

Features

- Available as single upholstered seat or seat with arm bolster.
- Casters: Standard with two-tone hard casters.
- Optional two-tone soft casters.
- Optional arm bolster.
- Optional two fabrics / colors of same fabric available on arm bolster and seat.
- COM yardage / COL square footage:
Mini-mobile: 1.0/18.0
Mini w/ Arm Bolster: 1.5/27.0
Arm Bolster: 0.5/9.0
- Available on RUSH.

To Order, Specify:

- 1) Product number.
- 2) Fabric surface and color.
or 2a. Fabric surface and color for seat.
2b. Fabric surface and color for arm bolster.
- 3) Trim color for base.
(Available in TR-LE Metallic Silver Only)

Leather Upholstery

Leather upholstery requires modification of the product number. Change the second digit to **7** and specify leather surface and color.
Example: 4756-0043

Description	Number	Fabric Grade								Leather Grade A	Leather Grade B
		A	B	C	D	E	F	G	H		
Upholstered/One Fabric and Color											
Armless	4856-0043 ■	\$ 823.22	\$ 949.59	\$1059.45	\$1079.52	\$1099.60	\$1111.41	\$1174.00	\$1344.08	\$1615.74	\$2051.57
Includes Arm Bolster	4856-0043-A ■	1072.44	1198.81	1308.67	1328.74	1348.82	1360.63	1423.22	1593.30	1864.96	2300.79
Upholstered/Two Fabrics or One Fabric, Two Colors											
Includes Arm Bolster	4856-0043-AT	1072.44	1325.18	1544.90	1585.04	1625.20	1648.82	1774.00	2114.16	2657.48	3529.14

Soft Caster Option

Soft caster option requires modification of the product number. To specify, add **-2** to the product code.

Example: 4856-0043-2A

Stain Repellent Option

To specify, add **-P** to end of the product number and add **\$36.61** list.

Example: 4856-0043-AP

Moisture Barrier Option

To specify, add **-D** to end of the product number and add **\$48.42** list.

Example: 4856-0043-AD

NOTE: Stain repellent and moisture barrier are not available on leather or faux leather.

For available fabrics, refer to surfaces.haworth.com.

Hello Seating

Guest Seating

Fixed Arm, Wood Legs



4851-0011-W

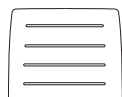

4851-0012-W

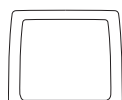

4851-0013-W

Dimensions

- SH: 18 1/4"(464mm)
- H: 33"(838mm)
- D: 20 1/2"(521mm)
- W: 22"(559mm)
- AH: 8"(203mm)
- SW: 18"(457mm)
- SD: 17 1/4"(438mm)

Features

- Wood or upholstered back.
- Wood legs.
- Upholstered seat.
- Non-stacking.
- Maple frame construction.
- Metal back arm attachment.
- Open arms.
- Back Options include wood slat, wood perforated or upholstered.
- COM yardage / COL square footage:
Upholstered seat or upholstered seat/back: 0.75/13.5

■ Available on RUSH.

To Order Chair with Wood Back, Specify:

- 1) Product number.
- 2) Fabric surface and color (seat).
- 3) Wood finish color (back and legs).
- 4) Trim color for back attachment. **(Available in TR-LE Metallic Silver Only)**

To Order Chair with Upholstered Back, Specify:

- 1) Product number.
- 2) Fabric surface and color.
- 3) Wood finish color (back and legs).
- 4) Trim color for back attachment. **(Available in TR-LE Metallic Silver Only)**

Leather Upholstery

Leather upholstery requires modification of the product number. Change the second digit to **7** and specify leather surface and color.

Example: 4751-0011-W

CAL 133 Option:

Add **-F** to the product number, and add **\$103.94** list.

Description	Number	Fabric Grade								Leather Grade A	Leather Grade B
		A	B	C	D	E	F	G	H		
Wood Perforated Back	4851-0011-W ■	\$1201.18	\$1223.62	\$1233.07	\$1256.68	\$1273.22	\$1442.13	\$1492.91	\$1635.83	\$1524.81	\$1704.00
Wood Slat Back	4851-0012-W ■	1201.18	1223.62	1233.07	1256.68	1273.22	1442.13	1492.91	1635.83	1524.81	1704.00
Upholstered Back	4851-0013-W	1494.10	1516.54	1525.99	1549.60	1566.14	1735.05	1785.83	1928.75	1817.73	1996.92

Stain Repellent Option

To specify, add **-P** to end of the product number and add **\$36.61** list.

Example: 4851-0011-W-P

Moisture Barrier Option

To specify add **-D** to end of the product number and add **\$48.42** list.

Example: 4851-0011-W-D

NOTE: Stain repellent and moisture barrier are not available on leather or faux leather.

For available fabrics, refer to surfaces.haworth.com.

Hello Seating

Guest Seating

Fixed Arm, Metal Legs



4851-0011

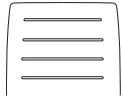

4851-0012

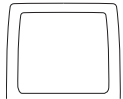

4851-0013

Dimensions

SH: 18 1/4"(464mm)
 H: 33"(838mm)
 D: 20 1/2"(521mm)
 W: 22"(559mm)
 AH: 8"(203mm)
 SW: 18"(457mm)
 SD: 17 1/4"(438mm)

Features

- Wood or upholstered back.
 - Wood front legs with metal rear legs.
 - Upholstered seat.
 - Non-stacking.
 - Maple frame construction.
 - Metal back arm attachment.
 - Open arms.
 - Back Options include wood slat, wood perforated or upholstered.
 - COM yardage / COL square footage:
 Upholstered seat / back: 0.75/13.5
- Available on RUSH.

To Order Chair with Wood Back, Specify:

- 1) Product number.
- 2) Fabric surface and color (seat).
- 3) Wood finish color for back, arms, and front legs.
- 4) Trim color for rear legs and back attachment.
(Available in TR-LE Metallic Silver Only)

To Order Chair with Upholstered Back, Specify:

- 1) Product number.
- 2) Fabric surface and color.
- 3) Wood finish color for back, arms, and front legs.
- 4) Trim color for rear legs and back attachment.
(Available in TR-LE Metallic Silver Only)

Leather Upholstery

Leather upholstery requires modification of the product number. Change the second digit to **7** and specify leather surface and color.

Example: 4751-0011

CAL 133 Option:

Add **-F** to the product number, and add **\$103.94** list.

Description	Number	Fabric Grade								Leather Grade A	Leather Grade B
		A	B	C	D	E	F	G	H		
Wood Perforated Back	4851-0011 ■	\$1093.71	\$1116.15	\$1125.60	\$1149.21	\$1165.75	\$1334.66	\$1385.44	\$1528.36	\$1417.34	\$1596.53
Wood Slat Back	4851-0012 ■	1093.71	1116.15	1125.60	1149.21	1165.75	1334.66	1385.44	1528.36	1417.34	1596.53
Upholstered Back	4851-0013	1386.63	1409.07	1418.52	1442.13	1458.67	1627.58	1678.36	1821.28	1710.26	1889.45

Stain Repellent Option

To specify, add **-P** to end of the product number and add **\$36.61** list.

Example: 4851-0011-P

Moisture Barrier Option

To specify add **-D** to end of the product number and add **\$48.42** list.

Example: 4851-0011-D

NOTE: Stain repellent and moisture barrier are not available on leather or faux leather.

For available fabrics, refer to surfaces.haworth.com.

Hello Seating

Stools

Fixed Arm, Metal Legs

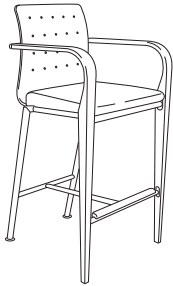

4852-0011

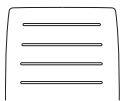

4852-0012

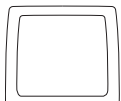

4852-0013

Dimensions

- SH: 28 1/2"(724mm)
- H: 44"(1118mm)
- D: 21"(533mm)
- W: 20 3/4"(527mm)
- AH: 8 1/2"(216mm)
- SW: 17 1/4"(438mm)
- SD: 17 1/4"(438mm)

Features

- Wood or upholstered back.
- Upholstered seat.
- Maple frame construction.
- Metal back leg construction.
- Open arms.
- Metal back arm attachment.
- Foot rest nylon cover available in black only.
- Back Options include wood slat, wood perforated or upholstered.
- COM yardage / COL square footage: Upholstered seat or upholstered seat/back: 0.75/13.5
- Available on RUSH.

To Order Chair with Wood Back, Specify:

- 1) Product number.
- 2) Fabric surface and color (seat).
- 3) Wood finish color for back, arms, and front legs.
- 4) Trim color for rear legs and back attachment.
(Available in TR-LE Metallic Silver Only)

To Order Chair with Upholstered Back, Specify:

- 1) Product number.
- 2) Fabric surface and color.
- 3) Wood finish color for back, arms, and front legs.
- 4) Trim color for rear legs and back attachment.
(Available in TR-LE Metallic Silver Only)

Leather Upholstery

Leather upholstery requires modification of the product number. Change the second digit to **7** and specify leather surface and color.

Example: 4752-0011

CAL 133 Option:

Add **-F** to the product number, and add **\$103.94** list.

Description	Number	Fabric Grade								Leather Grade A	Leather Grade B
		A	B	C	D	E	F	G	H		
Wood Perforated Back	4852-0011 ■	\$1399.62	\$1422.06	\$1431.51	\$1455.12	\$1471.66	\$1640.57	\$1691.35	\$1834.27	\$1723.25	\$1902.44
Wood Slat Back	4852-0012 ■	1399.62	1422.06	1431.51	1455.12	1471.66	1640.57	1691.35	1834.27	1723.25	1902.44
Upholstered Back	4852-0013	1692.54	1714.98	1724.43	1748.04	1764.58	1933.49	1984.27	2127.19	2016.17	2195.36

Stain Repellent Option

To specify, add **-P** to end of the product number and add **\$36.61** list.

Example: 4852-0011-P

Moisture Barrier Option

To specify add **-D** to end of the product number and add **\$48.42** list.

Example: 4852-0011-D

NOTE: Stain repellent and moisture barrier are not available on leather or faux leather.

For available fabrics, refer to surfaces.haworth.com.

ToDo

General Specifications

Features and Options**Frame**

- Combination of hardwood rails, premium grade plywood and engineering grade oriented strand board
- The seat, back and arms use a box construction method. Each box is then fastened together using metal T-nuts.
- Optional back handle (single seat only)

Cushioning

- High-density foam
- Webbed seat and back

Upholstery

- One Fabric
- Two Fabrics (first fabric on seat, back and ottoman; second fabric on arm structures)
- Faux Leather
- Leather

Seat Options

- Single
- Double
- Triple

Base Options

- Stationary
 - 2 metal legs front and rear
- Mobile (single seat only)
 - 2 twin-wheel casters front, 2 metal legs rear

Accessory Options

- Tablet
- Cup holder
- Grommet cover

Grommet Options

- None (no cut-outs in arms)
- Right Arm (as seated)
- Left Arm (as seated)
- Both Arms

Ottoman or Shelf Option

- Open compartment (standard)
- Painted or Wood Veneer Shelf
 - chairs with a shelf will not accept an ottoman
- Painted or Wood Veneer Mobile Ottoman
 - Upholstered
 - Non-upholstered wood top
 - 4 twin-wheel casters
 - chairs with an ottoman will not accept a shelf
 - ottoman nests under single seat with open compartment only

COM & COL General Information

To order a COM fabric (Customer's Own Material), contact the Haworth Inquiry Center (1.800.426.8562), your local Haworth dealer, or go to haworth.com/surfaces > COM Library to find out if the COM you have selected has already been tested and approved. The surface collection site also has information on the Haworth + alliance program with Carnegie, Luna Textiles, and Maharam as well as our industry-leading Pre-Approved COM program.

COM fabrics are placed into Grades based on the cost per linear yard. If a fabric's cost exceeds the range of our highest Grade it will be noted as Non-Graded. The product will be priced at Grade A; the COM fabric costs will appear as a separate line item. The fabric charge will be Haworth's purchase cost plus a 4% administrative fee (based on the cost of the fabric). Yardage calculations will include any applicable fabric repeat.

COM Leather products will be priced at a leather Grade A; COL costs will appear as a separate line item. The leather costs will be Haworth's purchase cost plus a 4% administrative fee (based on the cost of the leather).

Specification Guidelines

- When more than two fabrics are specified on a ToDo chair contact Haworth Specials for pricing and lead time.
- Mixing of materials such as vinyl and fabric on chair contact specials for pricing.
- When ordering a chair with both the two fabric option and an upholstered ottoman, the fabric on the ottoman will match the fabric on the chair seat and back indicated in the first fabric code. The chair arms will be upholstered in the second fabric code.
- If an upholstered ottoman fabric must match the chair arms or is a third fabric choice, the ottoman must be ordered separately.
- Chairs with a shelf will not accept an ottoman.
- Chairs with an ottoman will not accept a shelf.
- **A grommet option (suffix -R, -L or -B) must be included in the ToDo chair specification in order to accept tablet arms or cup holders.**
- Tablet arms and cup holders must be ordered separately.

To insure order accuracy and acceptance, features and options must be specified in the following order (top-down):

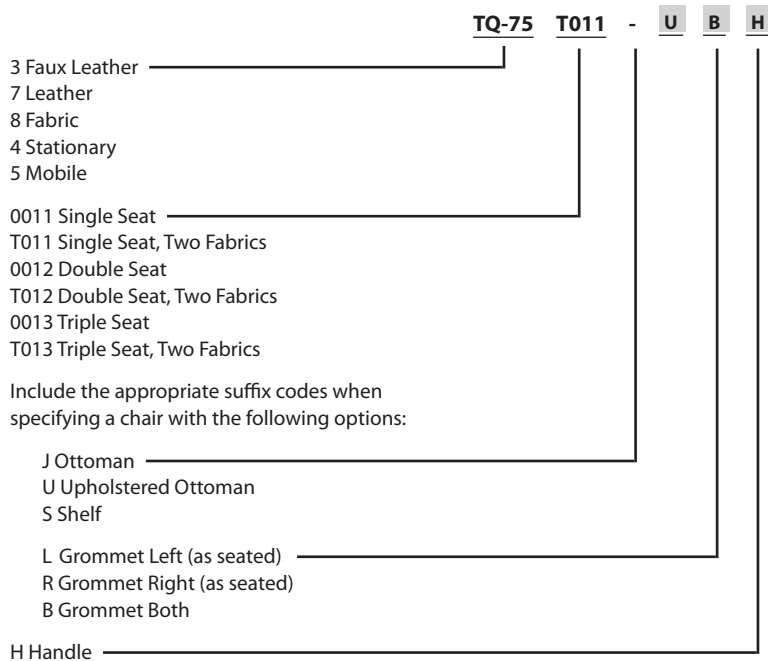

- ToDo Leather, Mobile, Single Seat with two fabrics, Upholstered Ottoman, Grommet Both, Handle

Examples:

TQ84-0012-SL, NQ-8, TR-M01, H3-1

ToDo Fabric, Stationary, Double Seat, Shelf, Grommet Left
 Moodring Fabric Joy
 Switch Silver trim on feet
 Lameer™ Snow on Shelf

TQ85-0011-BHF, ED-99, TR-F

ToDo Fabric, Mobile, Single Seat, Grommet Both, Handle
 Novial fabric Black
 Black trim on feet, grommets and handle
 CAL 133 required (when -F is specified, always verify fabric selected is CAL 133 approved.)

ToDo

Single, Stationary

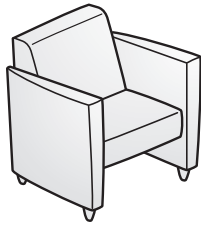

TQ84-0011

Dimensions

Overall:

H	31 1/4"(794mm)
W	30"(762mm)
D	29 1/4"(743mm)

Seat:

H	17 1/2"(445mm)
W	21 1/2"(546mm)
D	19"(483mm)

Arm:

H	24 1/8"(613mm)
---	----------------

Features

- Standard without grommets.
- COM yardage / COL square footage:
ToDo Single: 5.0/96.0
Seat and Back: 4.0/72.0
Arms Only: 3.0/54.0
Ottoman: 0.5/11.0

Specification Tips

- For help in specifying multiple options, refer to page 327.
- When specifying mixed grade fabrics, list price will not exceed the highest grade fabric specified.
- Chairs with a shelf will not accept an ottoman, and chairs with an ottoman will not accept a shelf.
- **A grommet option (suffix -R, -L or -B) must be included in the ToDo chair specification in order to accept tablet arms or cup holders.**
- Cup holders and tablet must be ordered separately. To specify, refer to page 332.
- Available on RUSH.

To Order, Specify:

- 1) Product number.
- 2) Fabric or
a. Fabric for seat, back and upholstered ottoman.
b. Fabric for arms.
- 3) Trim color for feet, grommets and handle.
- 4) Wood Veneer finish color for shelf or ottoman.

Description	Number	Fabric Grade								Leather Grade A	Leather Grade B
		A	B	C	D	E	F	G	H		
One Fabric											
Standard	TQ84-0011 ■	\$2344.49	\$2420.07	\$2542.93	\$2625.61	\$2913.79	\$3303.53	\$3506.69	\$4076.01	\$3662.61	\$4391.75
With Ottoman	TQ84-0011-J	3062.61	3138.19	3261.05	3343.73	3631.91	4021.65	4224.81	4794.13	4380.73	5109.87
With Upholstered Ottoman	TQ84-0011-U	3201.98	3277.56	3400.42	3483.10	3771.28	4161.02	4364.18	4933.50	4520.10	5249.24
With Shelf	TQ84-0011-S	2527.56	2603.14	2726.00	2808.68	3096.86	3486.60	3689.76	4259.08	3845.68	4574.82
With Grommet Right	TQ84-0011-R ■	2379.92	2455.50	2578.36	2661.04	2949.22	3338.96	3542.12	4111.44	3698.04	4427.18
With Grommet Left	TQ84-0011-L ■	2379.92	2455.50	2578.36	2661.04	2949.22	3338.96	3542.12	4111.44	3698.04	4427.18
With Grommet Both	TQ84-0011-B ■	2415.35	2490.93	2613.79	2696.47	2984.65	3374.39	3577.55	4146.87	3733.47	4462.61
With Handle	TQ84-0011-H ■	2418.90	2494.48	2617.34	2700.02	2988.20	3377.94	3581.10	4150.42	3737.02	4466.16
Two Fabrics											
Standard	TQ84-T011	\$2424.81	\$2500.39	\$2623.25	\$2705.93	\$2994.11	\$3383.85	\$3587.01	\$4156.33	\$3742.93	\$4472.07
With Ottoman	TQ84-T011-J	3142.93	3218.51	3341.37	3424.05	3712.23	4101.97	4305.13	4874.45	4461.05	5190.19
With Upholstered Ottoman	TQ84-T011-U	3282.30	3357.88	3480.74	3563.42	3851.60	4241.34	4444.50	5013.82	4600.42	5329.56
With Shelf	TQ84-T011-S	2607.88	2683.46	2806.32	2889.00	3177.18	3566.92	3770.08	4339.40	3926.00	4655.14
With Grommet Right	TQ84-T011-R	2460.24	2535.82	2658.68	2741.36	3029.54	3419.28	3622.44	4191.76	3778.36	4507.50
With Grommet Left	TQ84-T011-L	2460.24	2535.82	2658.68	2741.36	3029.54	3419.28	3622.44	4191.76	3778.36	4507.50
With Grommet Both	TQ84-T011-B	2495.67	2571.25	2694.11	2776.79	3064.97	3454.71	3657.87	4227.19	3813.79	4542.93
With Handle	TQ84-T011-H	2499.22	2574.80	2697.66	2780.34	3068.52	3458.26	3661.42	4230.74	3817.34	4546.48

The following options require modification of the product number.

- | | |
|------------------|---|
| Faux Leather | To specify, change the 3rd digit from an 8 to a 3; Example: TQ34-0011 |
| Leather | To specify, change the 3rd digit from an 8 to a 7; Example: TQ74-0011 |
| Stain repellent | To specify, add -P to the end of the product number; Example: TQ84-0011-P (add \$61.41 list) |
| Moisture barrier | To specify, add -D to the end of the product number; Example: TQ84-0011-D (add \$96.84 list) |

For available fabrics, refer to surfaces.haworth.com.

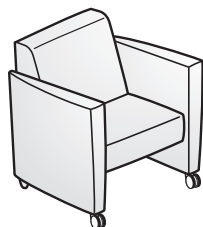

TQ85-0011

Dimensions

Overall:
 H 31 1/4"(794mm)
 W 30"(762mm)
 D 29 1/4"(743mm)
 Seat:
 H 17 1/2"(445mm)
 W 21 1/2"(546mm)
 D 19"(483mm)
 Arm:
 H 24 1/4"(613mm)

Features

- Standard without grommets.
- COM yardage / COL square footage:
 ToDo Single: 5.0/96.0
 Seat and Back: 4.0/72.0
 Arms Only: 3.0/54.0
 Ottoman: 0.5/11.0

To Order, Specify:

- 1) Product number.
- 2) Fabric or
 a. Fabric for seat, back and upholstered ottoman.
 b. Fabric for arms.
- 3) Trim color for feet, grommets and handle.
- 4) Wood Veneer finish color for shelf or ottoman.

Specification Tips

- For help in specifying multiple options, refer to page 327.
- When specifying mixed grade fabrics, list price will not exceed the highest grade fabric specified.
- Chairs with a shelf will not accept an ottoman, and chairs with an ottoman will not accept a shelf.
- **A grommet option (suffix -R, -L or -B) must be included in the ToDo chair specification in order to accept tablet arms or cup holders.**
- Cup holders and tablet must be ordered separately. To specify, refer to page 332.
- Available on RUSH.

Description	Number	Fabric Grade								Leather Grade A	Leather Grade B
		A	B	C	D	E	F	G	H		
One Fabric											
Standard	TQ85-0011 ■	\$2344.49	\$2420.07	\$2546.45	\$2630.33	\$2913.79	\$3303.53	\$3511.43	\$4079.55	\$3663.81	\$4389.49
With Ottoman	TQ85-0011-J	3198.43	3274.01	3400.39	3484.27	3767.73	4157.47	4365.37	4933.49	4517.75	5243.43
With Upholstered Ottoman	TQ85-0011-U	3201.97	3277.55	3403.93	3487.81	3771.27	4161.01	4368.91	4937.03	4521.29	5246.97
With Shelf	TQ85-0011-S	2527.56	2603.14	2729.52	2813.40	3096.86	3486.60	3694.50	4262.62	3846.88	4572.56
With Grommet Right	TQ85-0011-R ■	2379.92	2455.50	2581.88	2665.76	2949.22	3338.96	3546.86	4114.98	3699.24	4424.92
With Grommet Left	TQ85-0011-L ■	2379.92	2455.50	2581.88	2665.76	2949.22	3338.96	3546.86	4114.98	3699.24	4424.92
With Grommet Both	TQ85-0011-B ■	2415.36	2490.94	2617.32	2701.20	2984.66	3374.40	3582.30	4150.42	3734.68	4460.36
With Handle	TQ85-0011-H ■	2418.90	2494.48	2620.86	2704.74	2988.20	3377.94	3585.84	4153.96	3738.22	4463.90
Two Fabrics											
Standard	TQ85-T011	\$2424.81	\$2500.39	\$2626.77	\$2710.65	\$2994.11	\$3383.85	\$3591.75	\$4159.87	\$3744.13	\$4469.81
With Ottoman	TQ85-T011-J	3278.75	3354.33	3480.71	3564.59	3848.05	4237.79	4445.69	5013.81	4598.07	5323.75
With Upholstered Ottoman	TQ85-T011-U	3282.29	3357.87	3484.25	3568.13	3851.59	4241.33	4449.23	5017.35	4601.61	5327.29
With Shelf	TQ85-T011-S	2607.88	2683.46	2809.84	2893.72	3177.18	3566.92	3774.82	4342.94	3927.20	4652.88
With Grommet Right	TQ85-T011-R	2460.24	2535.82	2662.20	2746.08	3029.54	3419.28	3627.18	4195.30	3779.56	4505.24
With Grommet Left	TQ85-T011-L	2460.24	2535.82	2662.20	2746.08	3029.54	3419.28	3627.18	4195.30	3779.56	4505.24
With Grommet Both	TQ85-T011-B	2495.68	2571.26	2697.64	2781.52	3064.98	3454.72	3662.62	4230.74	3815.00	4540.68
With Handle	TQ85-T011-H	2499.22	2574.80	2701.18	2785.06	3068.52	3458.26	3666.16	4234.28	3818.54	4544.22

The following options require modification of the product number.

- Faux Leather To specify, change the 3rd digit from an 8 to a 3; **Example:** TQ35-0011
 - Leather To specify, change the 3rd digit from an 8 to a 7; **Example:** TQ75-0011
 - Stain repellent To specify, add **-P** to the end of the product number; **Example:** TQ85-0011-P (\$61.41 list)
 - Moisture barrier To specify, add **-D** to the end of the product number; **Example:** TQ85-0011-D (add \$96.84 list)
- For available fabrics, refer to surfaces.haworth.com.

ToDo

Double, Stationary

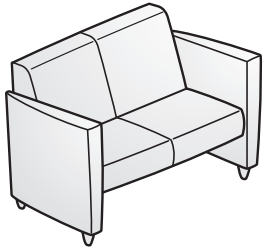

TQ84-0012

Dimensions**Overall:**

H 31 1/4"(794mm)
W 51"(1295mm)
D 30 3/4"(781mm)

Seat:

H 17 1/2"(445mm)
W 42 1/2"(1080mm)
D 20 1/2"(521mm)

Arm:

H 24 1/8"(613mm)

Features

- Standard without grommets.
- COM yardage / COL square footage:
ToDo Double: 8.0/144.0
Seat and Back: 7.0/126.0
Arms Only: 3.0/54.0

Specification Tips

- For help in specifying multiple options, refer to page 327.
 - When specifying mixed grade fabrics, list price will not exceed the highest grade fabric specified.
 - **A grommet option (suffix -R, -L or -B) must be included in the ToDo chair specification in order to accept tablet arms or cup holders.**
 - Cup holders and tablet must be ordered separately. To specify, refer to page 332.
 - Handle and ottoman options are not available on the ToDo Double.
- Available on RUSH.

To Order, Specify:

- 1) Product number.
- 2) Fabric or
 - a. Fabric for seat and back.
 - b. Fabric for arms.
- 3) Trim color for feet and grommets.
- 4) Wood Veneer finish color for shelf.

Description	Number	Fabric Grade		C	D	E	F	G	H	Leather Grade A	Leather Grade B
		A	B								
One Fabric											
Standard	TQ84-0012 ■	\$3440.57	\$3561.05	\$3764.17	\$3898.83	\$4347.65	\$4976.01	\$5306.73	\$6216.17	\$5550.05	\$6713.93
With Shelf	TQ84-0012-S	3623.64	3744.12	3947.24	4081.90	4530.72	5159.08	5489.80	6399.24	5733.12	6897.00
With Grommet Right	TQ84-0012-R ■	3476.00	3596.48	3799.60	3934.26	4383.08	5011.44	5342.16	6251.60	5585.48	6749.36
With Grommet Left	TQ84-0012-L ■	3476.00	3596.48	3799.60	3934.26	4383.08	5011.44	5342.16	6251.60	5585.48	6749.36
With Grommet Both	TQ84-0012-B ■	3511.43	3631.91	3835.03	3969.69	4418.51	5046.87	5377.59	6287.03	5620.91	6784.79
Two Fabrics											
Standard	TQ84-T012	\$3570.49	\$3690.97	\$3894.09	\$4028.75	\$4477.57	\$5105.93	\$5436.65	\$6346.09	\$5679.97	\$6843.85
With Shelf	TQ84-T012-S	3753.56	3874.04	4077.16	4211.82	4660.64	5289.00	5619.72	6529.16	5863.04	7026.92
With Grommet Right	TQ84-T012-R	3605.92	3726.40	3929.52	4064.18	4513.00	5141.36	5472.08	6381.52	5715.40	6879.28
With Grommet Left	TQ84-T012-L	3605.92	3726.40	3929.52	4064.18	4513.00	5141.36	5472.08	6381.52	5715.40	6879.28
With Grommet Both	TQ84-T012-B	3641.35	3761.83	3964.95	4099.61	4548.43	5176.79	5507.51	6416.95	5750.83	6914.71

The following options require modification of the product number.

Faux Leather	To specify, change the 3rd digit from an 8 to a 3; Example: TQ34-0012
Leather	To specify, change the 3rd digit from an 8 to a 7; Example: TQ74-0012
Stain repellent	To specify, add -P to the end of the product number; Example: TQ84-0012-P (add \$122.82 list)
Moisture barrier	To specify, add -D to the end of the product number; Example: TQ84-0012-D (add \$193.69 list)
	For available fabrics, refer to surfaces.haworth.com .

ToDo

Triple, Stationary

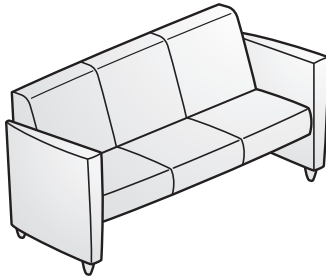

TQ84-0013

Dimensions

Overall:

H 31 1/4"(794mm)
W 73"(1854mm)
D 30 3/4"(781mm)

Seat:

H 17 1/2"(445mm)
W 64 1/2"(1638mm)
D 20 1/2"(521mm)

Arm:

H 24 1/8"(613mm)

Features

- Standard without grommets.
- COM yardage / COL square footage:
ToDo Triple: 11.0/198.0
Seat and Back: 9.0/162.0
Arms Only: 3.0/54.0

Specification Tips

- For help in specifying multiple options, refer to page 327.
- When specifying mixed grade fabrics, list price will not exceed the highest grade fabric specified.
- **A grommet option (suffix -R, -L or -B) must be included in the ToDo chair specification in order to accept tablet arms or cup holders.**
- Cup holders and tablet must be ordered separately. To specify, refer to page 332.
- Handle and ottoman options are not available on the ToDo Triple.
- Available on RUSH.

To Order, Specify:

- 1) Product number.
- 2) Fabric or
 - a. Fabric for seat and back.
 - b. Fabric for arms.
- 3) Trim color for feet and grommets.
- 4) Wood Veneer finish color for shelf.

Description	Number	Fabric Grade		C	D	E	F	G	H	Leather Grade A	Leather Grade B
		A	B								
One Fabric											
Standard	TQ84-0013 ■	\$4238.99	\$4390.19	\$4638.21	\$4810.63	\$5377.57	\$6353.17	\$6804.35	\$8160.27	\$6877.57	\$8331.25
With Shelf	TQ84-0013-S	4422.06	4573.26	4821.28	4993.70	5560.64	6536.24	6987.42	8343.34	7060.64	8514.32
With Grommet Right	TQ84-0013-R ■	4274.42	4425.62	4673.64	4846.06	5413.00	6388.60	6839.78	8195.70	6913.00	8366.68
With Grommet Left	TQ84-0013-L ■	4274.42	4425.62	4673.64	4846.06	5413.00	6388.60	6839.78	8195.70	6913.00	8366.68
With Grommet Both	TQ84-0013-B ■	4309.85	4461.05	4709.07	4881.49	5448.43	6424.03	6875.21	8231.13	6948.43	8402.11
Two Fabrics											
Standard	TQ84-T013	\$4407.90	\$4559.10	\$4807.12	\$4979.54	\$5546.48	\$6522.08	\$6973.26	\$8329.18	\$7046.48	\$8500.16
With Shelf	TQ84-T013-S	4590.97	4742.17	4990.19	5162.61	5729.55	6705.15	7156.33	8512.25	7229.55	8683.23
With Grommet Right	TQ84-T013-R	4443.33	4594.53	4842.55	5014.97	5581.91	6557.51	7008.69	8364.61	7081.91	8535.59
With Grommet Left	TQ84-T013-L	4443.33	4594.53	4842.55	5014.97	5581.91	6557.51	7008.69	8364.61	7081.91	8535.59
With Grommet Both	TQ84-T013-B	4478.76	4629.96	4877.98	5050.40	5617.34	6592.94	7044.12	8400.04	7117.34	8571.02

The following options require modification of the product number.

Faux Leather	To specify, change the 3rd digit from an 8 to a 3; Example: TQ34-0013
Leather	To specify, change the 3rd digit from an 8 to a 7; Example: TQ74-0013
Stain repellent	To specify, add -P to the end of the product number; Example: TQ84-0013-P (add \$121.84 list)
Moisture barrier	To specify, add -D to the end of the product number; Example: TQ84-0013-D (add \$290.53 list)
For available fabrics, refer to surfaces.haworth.com .	

ToDo

Accessories

Important! Specify for a ToDo chair with grommets. Product number suffix must include R, L or B.

Wood Tablet with Arm

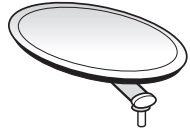

TQ90-0001

Dimensions
 W 11 1/2"(292mm)
 L 19 1/2"(495mm)

Available on RUSH.

To Order, Specify:

- 1) Product number.
- 2) Trim color for arm assembly.
- 3) Wood finish color.

Description	Number	Wood Finish Price
Wood Tablet with Arm	TQ90-0001	\$279.92

Cup Holder

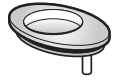

TQ90-0003

Dimensions
 W 4 1/2"(114mm)
 L 7"(178mm)

Available on RUSH.

To Order, Specify:

- 1) Product number.
- 2) Trim color for arm assembly.
- 3) Wood finish color.

Description	Number	Wood Finish Price
Cup Holder	TQ90-0003	\$100.39

Grommet Cover



TQ90-0006

Available on RUSH.

To Order, Specify:

- 1) Product number.
- 2) Trim color.

Description	Number	Painted Price
Grommet Cover	TQ90-0006	\$57.88

Specification Tip:

- A grommet option (suffix -R, -L or -B) must be included in the ToDo chair specification in order to accept tablet arms or cup holders.
 Example: TQ85-0011-JR will accept an accessory on the right arm.

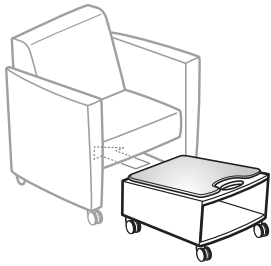

TQ90-0004

Dimensions

W 20"(508mm)
L 21"(533mm)
H 11"(279mm)

Specification Tip

• Chairs with a shelf will not accept an ottoman.

To Order, Specify:

- 1) Product number.
- 2) Fabric.
- 3) Trim color.
- 4) Wood Veneer finish color.

Description	Number	Painted	Fabric Grade		C	D	E	F	G	H	Leather Grade A	Leather Grade B
			A	B								
Non-Upholstered	TQ90-0004	\$718.12										
Upholstered	TQ80-0005		\$857.49	\$895.28	\$935.44	\$974.42	\$1011.04	\$1042.92	\$1078.35	\$1114.97	\$1210.64	\$1406.42

The following options require modification of the product number.

Faux Leather	To specify, change the 3rd digit from an 8 to a 3 ; Example: TQ30-0005
Leather	To specify, change the 3rd digit from an 8 to a 7 ; Example: TQ70-0005

Tempo Series

Lounge Seating

Description	Number	Fabric Grade								Leather Grade A	Leather Grade B
		A	B	C	D	E	F	G	H		
Without Arms	KL01-7200	\$ 891.74	\$ 999.21	\$1080.72	\$1113.79	\$1130.32	\$1228.36	\$1299.22	\$1498.83	\$1563.79	\$1933.36
Black Urethane Arms	KL01-7210	1073.64	1181.11	1262.62	1295.69	1312.22	1410.26	1481.12	1680.73	1745.69	2115.26
Wood Arms	KL01-7220	1483.47	1590.94	1672.45	1705.52	1722.05	1820.09	1890.95	2090.56	2155.52	2525.09

Open Frame Lounge — One Seat



KL01-7200



KL01-7210

Dimensions

SH: 17 1/2"(445mm)
 H: 33 3/4"(857mm)
 D: 25 1/2"(648mm)
 W: 23"(584mm)
 - Without arms
 24 1/2"(622mm)
 - With arms
 AH: 26 1/4"(667mm)

Features

- Available without arms, or with black integral skinned urethane arms or maple ply arms.
- Available with fire-retardant construction to comply with California Bulletin #133.
- Shipped assembled.
- Carton weight / size:
 KL01-7200: 37 lbs./13 cubic ft.
 KL01-7210: 44 lbs./13 cubic ft.
 KL01-7220: 39 lbs./13 cubic ft.
- COM yardage: 1.75
- COL square footage: 43.0
- Available on RUSH.

To Order, Specify:

- 1) Product number.
- 2) Fabric surface and color.
- 3) Frame finish color.
- 4) Arm wood finish color, if specified.

CAL 133 Option:

Add **-F** to the product number, and add **\$56.70** list.

Stain Repellent Option:

To specify, add **-P** to the end of the product number and add **\$36.61** list.
Example: KL01-7200-P

Moisture Barrier Option:

To specify, add **-D** to the end of the product number and add **\$48.42** list.
Example: KL01-7200-D

For available fabrics, refer to surfaces.haworth.com.

Without Arms	KL02-7200	\$1828.36	\$2048.04	\$2207.49	\$2273.64	\$2309.07	\$2500.41	\$2644.50	\$3034.27	\$3170.10	\$3909.36
Black Urethane Arms	KL02-7210	2010.26	2229.94	2389.39	2455.54	2490.97	2682.31	2826.40	3216.17	3352.00	4091.26
Wood Arms	KL02-7220	2420.09	2639.77	2799.22	2865.37	2900.80	3092.14	3236.23	3626.00	3761.83	4501.09

Open Frame Lounge — Two Seats



KL02-7200

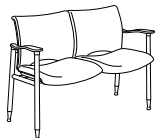

KL02-7210

Dimensions

SH: 17 1/2"(445mm)
 H: 33 3/4"(857mm)
 D: 25 1/2"(648mm)
 W: 43"(1092mm)
 - Without arms
 44 1/2"(1130mm)
 - With arms
 AH: 26 1/4"(667mm)

Features

- Available without arms, or with black integral skinned urethane arms or maple ply arms.
- Available with fire-retardant construction to comply with California Bulletin #133.
- Shipped assembled.
- Carton weight / size:
 KL02-7200: 71 lbs./24 cubic ft.
 KL02-7210: 78 lbs./24 cubic ft.
 KL02-7220: 73 lbs./24 cubic ft.
- COM yardage: 3.5
- COL square footage: 86.0
- Available on RUSH.

To Order, Specify:

- 1) Product number.
- 2) Fabric surface and color.
- 3) Frame finish color.
- 4) Arm wood finish color, if specified.

CAL 133 Option:

Add **-F** to the product number, and add **\$113.40** list.

Stain Repellent Option:

To specify, add **-P** to the end of the product number and add **\$73.23** list.
Example: KL02-7200-P

Moisture Barrier Option:

To specify, add **-D** to the end of the product number and add **\$96.84** list.
Example: KL02-7200-D

For available fabrics, refer to surfaces.haworth.com.

Tempo Series

Lounge Seating and Tables

Description	Number	Fabric Grade		C	D	E	F	G	H	Leather Grade A	Leather Grade B
		A	B								
One Seat	KLU1-7220	\$2173.24	\$2438.99	\$2633.88	\$2716.55	\$2755.53	\$3086.24	\$3282.31	\$3822.07	\$4964.20	\$ 6502.84
Two Seats	KLU2-7220	3270.49	3646.09	3921.28	4035.85	4092.54	4758.69	5078.76	5958.69	6597.67	8433.61
Three Seats	KLU3-7220	4282.69	4766.95	5123.63	5268.91	5344.51	6154.74	6557.50	7665.38	8775.63	11253.48

Fully Upholstered



KLU1-7220



KLU2-7220

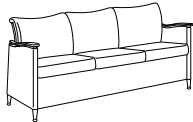

KLU3-7220

Class TA – SIN 711-17;
Discount Group X

Dimensions

SH: 17 1/2"(445mm)
H: 33 3/4"(857mm)
D: 29 1/2"(749mm)
W: 30 1/4"(768mm)
- One seat
52 1/4"(1327mm)
- Two seats
74 1/4"(1886mm)
- Three seats
AH: 26 1/2"(673mm)
SW: 21 3/4"(552mm)
- One seat
43 3/4"(1111mm)
- Two seats
65 3/4"(1670mm)
- Three seats

Features

- Fully-upholstered arms with maple arm rests.
- Available with fire-retardant construction to comply with California Bulletin #133.
- Shipped assembled.
- Carton weight / size:
KLU1-7220: 68 lbs./15 cubic ft.
KLU2-7220: 98 lbs./28 cubic ft.
KLU3-7220: 113 lbs./41 cubic ft.
- COM yardage: 4.75 (one seat), 7.75 (two seats), 9.75 (three seats)
- COL square footage: 117.0 (one seat), 191.0 (two seats), 240.0 (three seats)

To Order, Specify:

- 1) Product number.
- 2) Fabric surface and color.
- 3) Arm wood finish color.

CAL 133 Option:

Add **-F** to the product number, and add the following upcharge:

\$160.63 list for one seat lounge
\$253.94 list for two seat lounge
\$372.05 list for three seat lounge

Stain Repellent Option:

To specify, add **-P** to the end of the product number and add:

\$61.41 list for one seat lounge
\$122.83 list for two seat lounge
\$124.25 list for three seat lounge

Example: KLU1-7220-P

Moisture Barrier Option:

To specify, add **-D** to the end of the product number and add:

\$96.84 list for one seat lounge
\$193.70 list for two seat lounge
\$290.56 list for three seat lounge

Example: KLU1-7220-D

For available fabrics, refer to surfaces.haworth.com.

End Table



KLT8-1818

Class TA – SIN 711-11;
Discount Group X

Height	Depth	Width	Number	Laminate		Wood
				A	B	Surface
23"(584mm)	18"(457mm)	18"(457mm)	KLT8-1818	\$1077.17	\$1143.31	\$1243.71
	22"(559mm)	22"(559mm)	KLT8-2222	1142.13	1208.27	1308.67

Features

- Available in laminate top with black PVC edge or veneer top with color-matched wood edge.
- Shipped assembled.
- Carton weight / size:
KLT8-1818: 13 lbs./5 cubic ft.
KLT8-2222: 18 lbs./8 cubic ft.

To Order, Specify:

- 1) Product number.
- 2) Laminate color or maple wood finish.
- 3) Leg/frame finish color.

Coffee Table

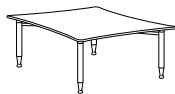

KLT1-3030

Class TA – SIN 711-11;
Discount Group X

15"(381mm)	30"(762mm)	30"(762mm)	KLT1-3030	\$1208.27	\$1274.41	\$1374.81
	36"(914mm)	36"(914mm)	KLT1-3636	1269.68	1335.82	1436.22

Features

- Available in laminate top with black PVC edge or veneer top with color-matched wood edge.
- Shipped assembled.
- Carton weight / size:
KLT1-3030: 30 lbs./11 cubic ft.
KLT1-3636: 40 lbs./13 cubic ft.

To Order, Specify:

- 1) Product number.
- 2) Laminate color or maple wood finish.
- 3) Leg/frame finish color.

Tempo Series

Preconfigured Seating

Description	Number	Fabric Grade		C	D	E	F	G	H	Leather Grade A	Leather Grade B
		A	B								
Urethane Arms	KLP2-7210	\$2312.62	\$2521.67	\$2671.68	\$2734.27	\$2768.52	\$2984.67	\$3128.76	\$3526.80	\$3657.90	\$4400.37
Wood Arms	KLP2-7220	2900.81	3109.86	3259.87	3322.46	3356.71	3572.86	3716.95	4114.99	4246.09	4988.56

Seat, Seat



KLP2-7210

Dimensions
 SH: 17 1/2"(445mm)
 H: 33 3/4"(857mm)
 D: 25 1/2"(648mm)
 W: 46"(1168mm)
 AH: 26 1/4"(667mm)
 SW: 19 1/2"(495mm)

Features

- Configuration includes two (2) seats and three (3) arms.
- Arms are available in a black integral skinned urethane or maple ply.
- Available with fire-retardant construction to comply with California Bulletin #133.
- Some assembly required.
- Carton weight / size:
 KLP2-7210: 80 lbs./24 cubic ft.
 KLP2-7220: 83 lbs./24 cubic ft.
- COM yardage: 3.5
- COL square footage: 86.0

To Order, Specify:

- 1) Product number.
- 2) Fabric surface and color.
- 3) Frame finish color.
- 4) Arm wood finish color, if specified.

CAL 133 Option:
 Add -F to the product number, and add \$113.40 list.

NOTE:
 This configuration can be field reconfigured using modular components, see page 340.

Urethane Arms	KLP3-7210	\$3315.38	\$3628.96	\$3853.97	\$3947.86	\$3999.23	\$4323.46	\$4539.59	\$5136.65	\$5333.30	\$6447.01
Wood Arms	KLP3-7220	4093.74	4407.32	4632.33	4726.22	4777.59	5101.82	5317.95	5915.01	6111.66	7225.37

Seat, Seat, Seat



KLP3-7210

Dimensions
 SH: 17 1/2"(445mm)
 H: 33 3/4"(857mm)
 D: 25 1/2"(648mm)
 W: 67 5/8"(1718mm)
 AH: 26 1/4"(667mm)
 SW: 19 1/2"(495mm)

Features

- Configuration includes three (3) seats and four (4) arms.
- Arms are available in a black integral skinned urethane or maple ply.
- Available with fire-retardant construction to comply with California Bulletin #133.
- Some assembly required.
- Carton weight / size:
 KLP3-7210: 102 lbs./34 cubic ft.
 KLP3-7220: 105 lbs./34 cubic ft.
- COM yardage: 5.25
- COL square footage: 129.0

To Order, Specify:

- 1) Product number.
- 2) Fabric surface and color.
- 3) Frame finish color.
- 4) Arm wood finish color, if specified.

CAL 133 Option:
 Add -F to the product number, and add \$170.10 list.

NOTE:
 This configuration can be field reconfigured using modular components, see page 340.

Urethane Arms/ Laminate Top	KLPJ-7210	\$3352.00	\$3561.05	\$3711.06	\$3773.65	\$3807.90	\$4024.05	\$4168.14	\$4566.18	\$4697.28	\$5439.75
Wood Arms/ Wood Top	KLPJ-7220	4288.62	4497.67	4647.68	4710.27	4744.52	4960.67	5104.76	5502.80	5633.90	6376.37

Seat, Table, Seat



KLPJ-7210

Dimensions
 SH: 17 1/2"(445mm)
 H: 33 3/4"(857mm)
 D: 25 1/2"(648mm)
 W: 67 5/8"(1718mm)
 AH: 26 1/4"(667mm)
 SW: 19 1/2"(495mm)

Features

- Configuration includes two (2) seats, four (4) arms and an in-line table.
- Arms are available in a black integral skinned urethane or maple ply.
- Table is available in laminate top with black PVC edge or veneer top with color-matched wood edge.
- Available with fire-retardant construction to comply with California Bulletin #133.
- Some assembly required.
- Carton weight / size:
 KLPJ-7210: 95 lbs./34 cubic ft.
 KLPJ-7220: 90 lbs./34 cubic ft.
- COM yardage: 3.5
- COL square footage: 86.0

To Order, Specify:

- 1) Product number.
- 2) Fabric surface and color.
- 3) Frame finish color.
- 4) Table laminate color or arm/table wood finish color.

CAL 133 Option:
 Add -F to the product number, and add \$113.40 list.

Stain Repellent Option:
 To specify, add -P to the end of the product number and add:
 \$73.23 list for two seat
 \$109.83 list for three seat
Example: KLP2-7210-P

Moisture Barrier Option:
 To specify, add -D to the end of the product number and add:
 \$96.84 list for two seat
 \$145.27 list for three seat
Example: KLP2-7210-D

For available fabrics, refer to surfaces.haworth.com.

NOTE:
 This configuration can be field reconfigured using modular components, see page 340.

Tempo Series

Preconfigured Seating

Description	Number	Fabric Grade		C	D	E	F	G	H	Leather Grade A	Leather Grade B
		A	B								
Urethane Arms/ Laminate Top	KLPK-7210	\$3179.55	\$3388.60	\$3538.61	\$3601.20	\$3635.45	\$3851.60	\$3995.69	\$4393.73	\$4524.83	\$5267.30
Wood Arms/ Wood Top	KLPK-7220	3921.29	4130.34	4280.35	4342.94	4377.19	4593.34	4737.43	5135.47	5266.57	6009.04

Table, Seat, Seat

KLPK-7210

NOTE:

This configuration can be field reconfigured using modular components, see page 340.

Dimensions

SH: 17 1/2"(445mm)
H: 33 3/4"(857mm)
D: 25 1/2"(648mm)
W: 68"(1727mm)
AH: 26 1/4"(667mm)
SW: 19 1/2"(495mm)

Features

- Configuration includes two (2) seats, three arms and left end table.
- Arms are available in a black integral skinned urethane or maple ply.
- Table is available in laminate top with black PVC edge or veneer top with color-matched wood edge.
- Available with fire-retardant construction to comply with California Bulletin #133.
- Some assembly required.
- Carton weight / size:
KLPK-7210: 95 lbs./34 cubic ft.
KLPK-7220: 90 lbs./34 cubic ft.
- COM yardage: 3.5
- COL square footage: 86.0

To Order, Specify:

- 1) Product number.
- 2) Fabric surface and color.
- 3) Frame finish color.
- 4) Table laminate color *or* arm/table wood finish color.

CAL 133 Option:

Add **-F** to the product number, and add **\$113.40** list.

Urethane Arms/ Laminate Top	KLPL-7210	\$3179.55	\$3388.60	\$3538.61	\$3601.20	\$3635.45	\$3851.60	\$3995.69	\$4393.73	\$4524.83	\$5267.30
Wood Arms/ Wood Top	KLPL-7220	3921.29	4130.34	4280.35	4342.94	4377.19	4593.34	4737.43	5135.47	5266.57	6009.04

Seat, Seat, Table

KLPL-7210

NOTE:

This configuration can be field reconfigured using modular components, see page 340.

Dimensions

SH: 17 1/2"(445mm)
H: 33 3/4"(857mm)
D: 25 1/2"(648mm)
W: 68"(1727mm)
AH: 26 1/4"(667mm)
SW: 19 1/2"(495mm)

Features

- Configuration includes two (2) seats, three (3) arms and right end table.
- Arms are available in a black integral skinned urethane or maple ply.
- Table is available in laminate top with black PVC edge or veneer top with color-matched wood edge.
- Available with fire-retardant construction to comply with California Bulletin #133.
- Some assembly required.
- Carton weight / size:
KLPL-7210: 95 lbs./34 cubic ft.
KLPL-7220: 90 lbs./34 cubic ft.
- COM yardage: 3.5
- COL square footage: 86.0

To Order, Specify:

- 1) Product number.
- 2) Fabric surface and color.
- 3) Frame finish color.
- 4) Table laminate color *or* arm/table wood finish color.

CAL 133 Option:

Add **-F** to the product number, and add **\$113.40** list.

Stain Repellent Option:

To specify, add **-P** to the end of the product number and add **\$73.23** list.
Example: KLPK-7210-**P**

Moisture Barrier Option:

To specify, add **-D** to the end of the product number and add **\$96.84** list.
Example: KLPK-7210-**D**

For available fabrics, refer to surfaces.haworth.com.

Tempo Series

Preconfigured Seating

Description	Number	Fabric Grade		C	D	E	F	G	H	Leather Grade A	Leather Grade B
		A	B								
Urethane Arms	KLP4-7210	\$4319.32	\$4737.42	\$5037.44	\$5162.62	\$5231.12	\$5663.42	\$5951.60	\$6747.68	\$7009.88	\$8494.82
Wood Arms	KLP4-7220	\$292.55	\$710.65	\$6010.67	\$6135.85	\$6204.35	\$6636.65	\$6924.83	\$7720.91	\$7983.11	\$9468.05

Seat, Seat, Seat, Seat

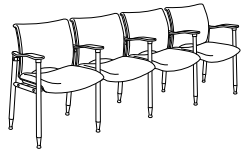

KLP4-7210

NOTE:

This configuration can be field reconfigured using modular components, see page 340.

Dimensions

SH: 17 1/2"(445mm)
 H: 33 3/4"(857mm)
 D: 25 1/2"(648mm)
 W: 89"(2261mm)
 AH: 26 1/4"(667mm)
 SW: 19 1/2"(495mm)

Features

- Configuration includes four (4) seats and five (5) arms.
- Arms are available in a black integral skinned urethane or maple ply.
- Available with fire-retardant construction to comply with California Bulletin #133.
- Some assembly required.
- Carton weight / size:
 KLP4-7210: 127 lbs./45 cubic ft.
 KLP4-7220: 124 lbs./45 cubic ft.
- COM yardage: 7.0
- COL square footage: 173.0

To Order, Specify:

- 1) Product number.
- 2) Fabric surface and color.
- 3) Frame finish color.
- 4) Arm wood finish color, if specified.

CAL 133 Option:

Add **-F** to the product number, and add **\$226.80** list.

Urethane Arms/ Laminate Top	KLPM-7210	\$4354.75	\$4668.33	\$4893.34	\$4987.23	\$5038.60	\$5362.83	\$5578.96	\$6176.02	\$6372.67	\$7486.38
Wood Arms/ Wood Top	KLPM-7220	\$482.70	\$796.28	\$6021.29	\$6115.18	\$6166.55	\$6490.78	\$6706.91	\$7303.97	\$7500.62	\$8614.33

Seat, Table, Seat, Seat

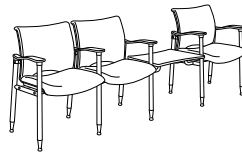

KLPM-7210

NOTE:

This configuration can be field reconfigured using modular components, see page 340.

Dimensions

SH: 17 1/2"(445mm)
 H: 33 3/4"(857mm)
 D: 25 1/2"(648mm)
 W: 89"(2261mm)
 AH: 26 1/4"(667mm)
 SW: 19 1/2"(495mm)

Features

- Configuration includes three (3) seats, five (5) arms and an in-line table.
- Arms are available in a black integral skinned urethane or maple ply.
- Table is available in laminate top with black PVC edge or veneer top with color-matched wood edge.
- Available with fire-retardant construction to comply with California Bulletin #133.
- Some assembly required.
- Carton weight / size:
 KLPM-7210: 121 lbs./45 cubic ft.
 KLPM-7220: 114 lbs./45 cubic ft.
- COM yardage: 5.25
- COL square footage: 129.0

To Order, Specify:

- 1) Product number.
- 2) Fabric surface and color.
- 3) Frame finish color.
- 4) Table laminate color *or* arm/table wood finish color.

CAL 133 Option:

Add **-F** to the product number, and add **\$170.10** list.

Urethane Arms/ Laminate Top	KLPN-7210	\$4354.75	\$4668.33	\$4893.34	\$4987.23	\$5038.60	\$5362.83	\$5578.96	\$6176.02	\$6372.67	\$7486.38
Wood Arms/ Wood Top	KLPN-7220	\$482.70	\$796.28	\$6021.29	\$6115.18	\$6166.55	\$6490.78	\$6706.91	\$7303.97	\$7500.62	\$8614.33

Seat, Seat, Table, Seat

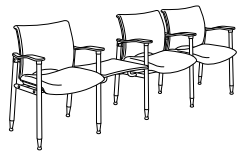

KLPN-7210

NOTE:

This configuration can be field reconfigured using modular components, see page 340.

Dimensions

SH: 17 1/2"(445mm)
 H: 33 3/4"(857mm)
 D: 25 1/2"(648mm)
 W: 89"(2261mm)
 AH: 26 1/4"(667mm)
 SW: 19 1/2"(495mm)

Features

- Configuration includes three (3) seats, five (5) arms and an in-line table.
- Arms are available in a black integral skinned urethane or maple ply.
- Table is available in laminate top with black PVC edge or veneer top with color-matched wood edge.
- Available with fire-retardant construction to comply with California Bulletin #133.
- Some assembly required.
- Carton weight / size:
 KLPN-7210: 121 lbs./45 cubic ft.
 KLPN-7220: 114 lbs./45 cubic ft.
- COM yardage: 5.25
- COL square footage: 129.0

To Order, Specify:

- 1) Product number.
- 2) Fabric surface and color.
- 3) Frame finish color.
- 4) Table laminate color *or* arm/table wood finish color.

CAL 133 Option:

Add **-F** to the product number, and add **\$170.10** list.

Stain Repellent Option:

To specify, add **-P** to the end of the product number and add:

- \$109.83 list for three seat
- \$146.45 list for four seat

Example: KLP4-7210-P

Moisture Barrier Option:

To specify, add **-D** to the end of the product number and add:

- \$145.27 list for three seat
- \$193.69 list for four seat

Example: KLP4-7210-D

For available fabrics, refer to surfaces.haworth.com.

Tempo Series

Preconfigured Seating

Description	Number	Fabric Grade		C	D	E	F	G	H	Leather Grade A	Leather Grade B
		A	B								
Urethane Arms/ Laminate Top	KLPP-7210	\$4183.50	\$4497.08	\$4722.09	\$4815.98	\$4867.35	\$5191.58	\$5407.71	\$6004.77	\$6201.42	\$7315.13
Wood Arms/ Wood Top	KLPP-7220	5118.93	5432.51	5657.52	5751.41	5802.78	6127.01	6343.14	6940.20	7136.85	8250.56

Table, Seat, Seat, Seat

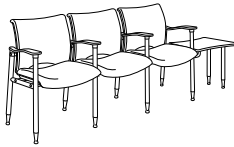

KLPP-7210

NOTE:
This configuration can be field reconfigured using modular components, see page 340.

Dimensions

- SH: 17 1/2"(445mm)
- H: 33 3/4"(857mm)
- D: 25 1/2"(648mm)
- W: 89 1/2"(2273mm)
- AH: 26 1/4"(667mm)
- SW: 19 1/2"(495mm)

Features

- Configuration includes three (3) seats, four (4) arms and left end table.
- Arms are available in a black integral skinned urethane or maple ply.
- Table is available in laminate top with black PVC edge or veneer top with color-matched wood edge.
- Available with fire-retardant construction to comply with California Bulletin #133.
- Some assembly required.
- Carton weight / size:
KLPP-7210: 121 lbs./45 cubic ft.
KLPP-7220: 114 lbs./45 cubic ft.
- COM yardage: 5.25
- COL square footage: 129

To Order, Specify:

- 1) Product number.
- 2) Fabric surface and color.
- 3) Frame finish color.
- 4) Table laminate color *or* arm/table wood finish color.

CAL 133 Option:

Add -F to the product number, and add **\$170.10** list.

Urethane Arms/ Laminate Top	KLPQ-7210	\$4183.50	\$4497.08	\$4722.09	\$4815.98	\$4867.35	\$5191.58	\$5407.71	\$6004.77	\$6201.42	\$7315.13
Wood Arms/ Wood Top	KLPQ-7220	5118.93	5432.51	5657.52	5751.41	5802.78	6127.01	6343.14	6940.20	7136.85	8250.56

Seat, Seat, Seat, Table



KLPQ-7210

NOTE:
This configuration can be field reconfigured using modular components, see page 340.

Dimensions

- SH: 17 1/2"(445mm)
- H: 33 3/4"(857mm)
- D: 25 1/2"(648mm)
- W: 89 1/2"(2273mm)
- AH: 26 1/4"(667mm)
- SW: 19 1/2"(495mm)

Features

- Configuration includes three (3) seats, four (4) arms and right end table.
- Arms are available in a black integral skinned urethane or maple ply.
- Table is available in laminate top with black PVC edge or veneer top with color-matched wood edge.
- Available with fire-retardant construction to comply with California Bulletin #133.
- Some assembly required.
- Carton weight / size:
KLPQ-7210: 121 lbs./45 cubic ft.
KLPQ-7220: 114 lbs./45 cubic ft.
- COM yardage: 5.25
- COL square footage: 129

To Order, Specify:

- 1) Product number.
- 2) Fabric surface and color.
- 3) Frame finish color.
- 4) Table laminate color *or* arm/table wood finish color.

CAL 133 Option:

Add -F to the product number, and add **\$170.10** list.

Stain Repellent Option:

To specify, add -P to the end of the product number and add **\$109.83** list.
Example: KLPP-7210-P

Moisture Barrier Option:

To specify, add -D to the end of the product number and add **\$145.27** list.
Example: KLPP-7210-D

For available fabrics, refer to surfaces.haworth.com.

Tempo Series

Modular Seating Specifications

Specification and Ordering Information

Tempo Series modular seating components are divided into two groups; *starter components* and *add-on components*.

- Starter Components include seats and end tables. Starter seats have four (4) legs and provide a starting point for a configuration and support one end of an in-line table, corner table or end table.
- Add-on Components include seats and in-line tables. Add-on seats have two (2) legs on the right side (as you sit in the seat) and connect to starter seats or other add-on components.

Specification Tip: *Modular components can be added to existing preconfigured seating units to create unique configurations. See pages 342-346.*

- 1) Develop a layout drawing (plan view) of each seating configuration. Label each component with the corresponding product number, see example below.

NOTE: Your labeled drawing is not required with the purchase order; however, it is essential for on-site assembly of the components.

- 2) Working left-to-right **as you sit in the seating configuration**, specify a starter seat or table.
- 3) Continue your configuration with add-on seats, in-line tables, corner tables and starter seats for support of tables. Possible options include arm and armless combinations.
- 4) Complete your configuration with a starter seat, right end table or add-on seat.
- 5) Specify the appropriate fabric surface/color code, frame finish color code, table top finish code, and wood arm finish.

Configuration Example

The following example illustrates a modular seating configuration:

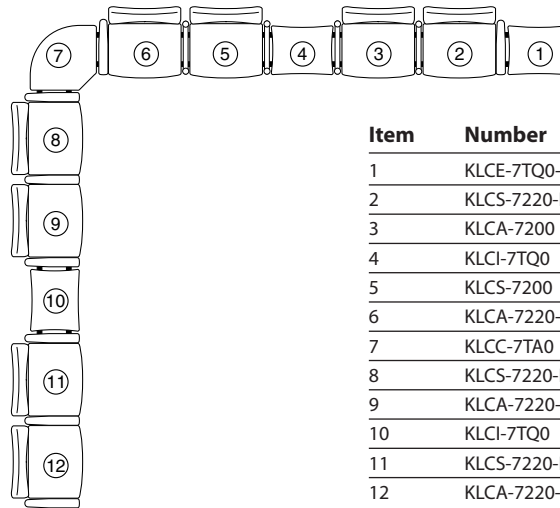

Item	Number	Description
1	KLCE-7TQ0-L	Starter end table, left-hand
2	KLCS-7220-L	Starter seat with left arm
3	KLCA-7200	Add-on seat without arm
4	KLCC-7TQ0	Add-on in-line table
5	KLCS-7200	Starter seat without arms
6	KLCA-7220-R	Add-on seat with right arm
7	KLCC-7TA0	Add-on corner table
8	KLCS-7220-B	Starter seat with left and right arms
9	KLCA-7220-R	Add-on seat with right arm
10	KLCC-7TQ0	Add-on in-line table
11	KLCS-7220-B	Starter seat with left and right arms
12	KLCA-7220-R	Add-on seat with right arm

Specification Tip: *Use a combination of preconfigured and modular components to reduce the number of specified products.*

Specification Tips

The following additional tips should be considered when planning and specifying Tempo modular seating:

- There is no restriction on the number of seats and tables connected in a row.
- Place an in-line table between two seats. Two (2) in-line tables cannot be connected side-by-side.
- Alternating arm and armless seats can be specified within a configuration. Two starter seats with arms cannot be connected.
- All seats must face the same direction within a configuration.
- Corner tables require the support of a seat on either end. It is recommended that square corner tables (KLCC-7TQ0) be placed in the corner of a room or a protected area to reduce or prevent contact with the 90° table edge.
- Tempo modular seating components are manufactured and shipped in one-seat units to be field attached. NOTE: Tempo preconfigured seating requires some assembly.
- Detailed assembly instructions are included with individual units.
- Final product configuration drawings are the responsibility of the customer/specifier, but are not required for placement of the order.
- Tempo modular components may be knocked down for reconfiguration or repair in the field.

Tempo Series

Modular Seating Dimensions

Calculating Modular Seating Dimensions

Use the following dimensions to determine the footprint of a Tempo Series modular seating configuration.

- 1) All arm and armless seating models are 25 1/2" (648mm) deep. For seat widths refer to the individual starter and add-on seats.

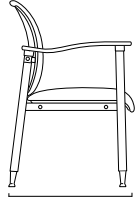

25 1/2" (648mm)

- 2) For every in-line table, add 20" (508mm) to the width of the seating run.

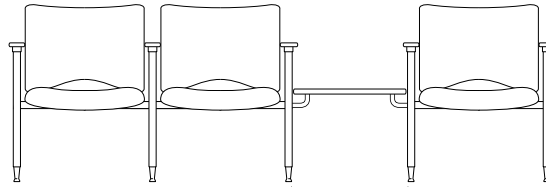

20" (508mm)

- 3) For every end table, add 23 1/2" (597mm) to the width of the seating run.

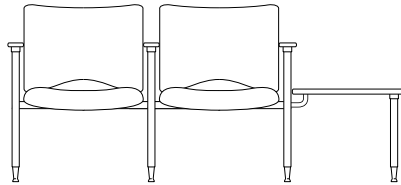

23 1/2" (597mm)

- 4) For every corner table, add 35" (889mm) to the width of the seating run in both directions.

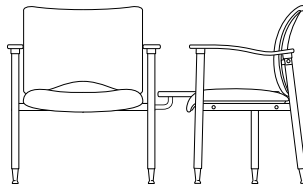

35" (889mm)

Tempo Series

Modular Starter Seating

Description	Number	Fabric Grade		C	D	E	F	G	H	Leather Grade A	Leather Grade B
		A	B								
Urethane Arm	KLCS-7210-R	\$1136.22	\$1243.69	\$1325.20	\$1358.27	\$1374.80	\$1472.84	\$1543.70	\$1743.31	\$1808.27	\$2177.84
Wood Arm	KLCS-7220-R	1340.56	1448.03	1529.54	1562.61	1579.14	1677.18	1748.04	1947.65	2012.61	2382.18

Starter Seat with Right Arm



KLCS-7210-R

Dimensions

SH: 17 1/2"(445mm)
H: 33 3/4"(857mm)
D: 25 1/2"(648mm)
W: 24 1/8"(616mm)
AH: 26 1/4"(667mm)
SW: 19 1/2"(495mm)

Features

- Includes a seat, back, right arm (from seated position) and support framework.
- Accepts add-on components (tables, arm and armless seats).
- Arm is available in a black integral skinned urethane or maple ply.
- Available with fire-retardant construction to comply with California Bulletin #133.
- Shipped assembled as a one-seat unit.
- Carton weight / size:
KLCS-7210-R: 43 lbs./13 cubic ft.
KLCS-7220-R: 38 lbs./13 cubic ft.
- COM yardage: 1.75
- COL square footage: 43.0

To Order, Specify:

- 1) Product number.
- 2) Fabric surface and color.
- 3) Frame finish color.
- 4) Wood finish color, if specified.

CAL 133 Option:

Add **F** to the end of the product number, and add **\$56.70** list.

Urethane Arm	KLCS-7210-L	\$1136.22	\$1243.69	\$1325.20	\$1358.27	\$1374.80	\$1472.84	\$1543.70	\$1743.31	\$1808.27	\$2177.84
Wood Arm	KLCS-7220-L	1340.56	1448.03	1529.54	1562.61	1579.14	1677.18	1748.04	1947.65	2012.61	2382.18

Starter Seat with Left Arm



KLCS-7210-L

Dimensions

SH: 17 1/2"(445mm)
H: 33 3/4"(857mm)
D: 25 1/2"(648mm)
W: 24 1/8"(616mm)
AH: 26 1/4"(667mm)
SW: 19 1/2"(495mm)

Features

- Includes a seat, back, left arm (from seated position) and support framework.
- Accepts add-on components (tables, arm and armless seats).
- Arm is available in a black integral skinned urethane or maple ply.
- Available with fire-retardant construction to comply with California Bulletin #133.
- Shipped assembled as a one-seat unit.
- Carton weight / size:
KLCS-7210-L: 43 lbs./13 cubic ft.
KLCS-7220-L: 38 lbs./13 cubic ft.
- COM yardage: 1.75
- COL square footage: 43.0

To Order, Specify:

- 1) Product number.
- 2) Fabric surface and color.
- 3) Frame finish color.
- 4) Wood finish color, if specified.

CAL 133 Option:

Add **F** to the end of the product number, and add **\$56.70** list.

Urethane Arms	KLCS-7210-B	\$1371.26	\$1478.73	\$1560.24	\$1593.31	\$1609.84	\$1707.88	\$1778.74	\$1978.35	\$2043.31	\$2412.88
Wood Arms	KLCS-7220-B	1776.38	1883.85	1965.36	1998.43	2014.96	2113.00	2183.86	2383.47	2448.43	2818.00

Starter Seat with Right and Left Arms



KLCS-7210-B

Dimensions

SH: 17 1/2"(445mm)
H: 33 3/4"(857mm)
D: 25 1/2"(648mm)
W: 24 3/4"(629mm)
AH: 26 1/4"(667mm)
SW: 19 1/2"(495mm)

Features

- Includes a seat, back, left and right arms and support framework.
- Accepts add-on components (tables, arm and armless seats).
- Arms are available in a black integral skinned urethane or maple ply.
- Available with fire-retardant construction to comply with California Bulletin #133.
- Shipped assembled as a one-seat unit.
- Carton weight / size:
KLCS-7210-B: 46 lbs./13 cubic ft.
KLCS-7220-B: 41 lbs./13 cubic ft.
- COM yardage: 1.75
- COL square footage: 43.0

To Order, Specify:

- 1) Product number.
- 2) Fabric surface and color.
- 3) Frame finish color.
- 4) Wood finish color, if specified.

CAL 133 Option:

Add **F** to the end of the product number, and add **\$56.70** list.

Stain Repellent Option:

To specify, add **P** to the end of the product number and add **\$36.61** list.

Example: KLCS-7210-RP

Moisture Barrier Option:

To specify, add **D** to the end of the product number and add **\$48.42** list.

Example: KLCS-7210-RD

For available fabrics, refer to surfaces.haworth.com.

Tempo Series

Modular Starter Seating

Description	Number	Fabric Grade		C	D	E	F	G	H	Leather	Leather
		A	B							Grade A	Grade B
Without Arms	KLCS-7200-N	\$1046.46	\$1153.93	\$1235.44	\$1268.51	\$1285.04	\$1383.08	\$1453.94	\$1653.55	\$1718.51	\$2088.08

**Starter Seat
without Arms**

KLCS-7200-N

Dimensions

SH: 17 1/2" (445mm)

H: 33 3/4" (857mm)

D: 25 1/2" (648mm)

W: 23 1/4" (590mm)

SW: 19 1/2" (495mm)

Features

- Includes seat, back and support framework.
- Accepts add-on components (tables, arm and armless seats).
- Available with fire-retardant construction to comply with California Bulletin #133.
- Shipped assembled as a one-seat unit.
- Carton weight/size: 39 lbs./13 cubic ft.
- COM yardage: 1.75
- COL square footage: 43.0

To Order, Specify:

- 1) Product number.
- 2) Fabric surface and color.
- 3) Frame finish color.

CAL 133 Option:

Add **F** to the end of the product number, and add **\$56.70** list.

Stain Repellent Option:

To specify, add **P** to the end of the product number and add **\$36.61** list.

Example: KLCS-7200-NP

Moisture Barrier Option:

To specify, add **D** to the end of the product number and add **\$48.42** list.

Example: KLCS-7200-ND

For available fabrics, refer to surfaces.haworth.com.

Tempo Series

Modular Add-on Seating

Description	Number	Fabric Grade		C	D	E	F	G	H	Leather Grade A	Leather Grade B
		A	B								
Urethane Arm	KLCA-7210-R	\$1054.72	\$1162.19	\$1243.70	\$1276.77	\$1293.30	\$1391.34	\$1462.20	\$1661.81	\$1726.77	\$2096.34
Wood Arm	KLCA-7220-R	1260.24	1367.71	1449.22	1482.29	1498.82	1596.86	1667.72	1867.33	1932.29	2301.86

Add-on Seat with Right Arm



KLCA-7210-R

Dimensions

SH: 17 1/2"(445mm)
H: 33 3/4"(857mm)
D: 25 1/2"(648mm)
W: 22 7/8"(581mm)
AH: 26 1/4"(667mm)
SW: 19 1/2"(495mm)

Features

- Includes a seat, back, right arm (from seated position) and support framework.
- Requires the support of add-on or starter components.
- Arm is available in a black integral skinned urethane or maple ply.
- Available with fire-retardant construction to comply with California Bulletin #133.
- Shipped assembled as a one-seat unit.
- Carton weight / size:
KLCA-7210-R: 34 lbs./13 cubic ft.
KLCA-7220-R: 31 lbs./13 cubic ft.
- COM yardage: 1.75
- COL square footage: 43.0

To Order, Specify:

- 1) Product number.
- 2) Fabric surface and color.
- 3) Frame finish color.
- 4) Wood finish color, if specified.

CAL 133 Option:

Add **F** to the end of the product number, and add **\$56.70** list.

Without Arm	KLCA-7200-N	\$882.28	\$989.75	\$1071.26	\$1104.33	\$1120.86	\$1218.90	\$1289.76	\$1489.37	\$1554.33	\$1923.90
-------------	-------------	----------	----------	-----------	-----------	-----------	-----------	-----------	-----------	-----------	-----------

Add-on Seat without Arm



KLCA-7200-N

Dimensions

SH: 17 1/2"(445mm)
H: 33 3/4"(857mm)
D: 25 1/2"(648mm)
W: 22 1/4"(565mm)
SW: 19 1/2"(495mm)

Features

- Includes a seat, back, and support framework.
- Requires the support of add-on or starter components.
- Available with fire-retardant construction to comply with California Bulletin #133.
- Shipped assembled as a one-seat unit.
- Carton weight/size: 29 lbs./13 cubic ft.
- COM yardage: 1.75
- COL square footage: 43.0

To Order, Specify:

- 1) Product number.
- 2) Fabric surface and color.
- 3) Frame finish color.

CAL 133 Option:

Add **F** to the end of the product number, and add **\$56.70** list.

Stain Repellent Option:

To specify, add **P** to the end of the product number and add **\$36.61** list.

Example: KLCA-7210-NP

Moisture Barrier Option:

To specify, add **-D** to the end of the product number and add **\$48.42** list.

Example: KLCA-7210-ND

For available fabrics, refer to surfaces.haworth.com.

Tempo Series

Modular Starter Tables

		Description	Number	Laminate Surface	Veneer Surface
Right End Table	Dimensions	Right-hand	KLCE-7TQ0-R	\$910.63	\$910.63
 KLCE-7TQ0-R	H: 18"(457mm)	Features			
	D: 21 1/4"(540mm) - Table top				
	W: 22 5/8"(575mm) - Table top	To Order, Specify:			
		<ol style="list-style-type: none"> Product number. Laminate color or wood finish. Frame finish color. 			

NOTE:

This table can be added to a preconfigured seating unit.



		Description	Number	Laminate Surface	Veneer Surface
Left End Table	Dimensions	Left-hand	KLCE-7TQ0-L	\$910.63	\$910.63
 KLCE-7TQ0-L	H: 18"(457mm)	Features			
	D: 21 1/4"(540mm) - Table top				
	W: 22 5/8"(575mm) - Table top	To Order, Specify:			
		<ol style="list-style-type: none"> Product number. Laminate color or wood finish. Frame finish color. 			

NOTE:

This table can be added to a preconfigured seating unit.

Tempo Series

Modular Add-on Tables

		Description	Number	Laminate Surface	Veneer Surface
In-Line Table  KLCC-7TQ0	Dimensions H: 18"(457mm) D: 21 1/4"(540mm) - Table top W: 19 3/4"(502mm) - Table top	In-Line Table	KLCC-7TQ0	\$767.72	\$767.72
	Features <ul style="list-style-type: none"> • Includes table top and support framework. • Available in laminate top with black PVC edge or veneer top with color-matched wood edge. • Requires the support of two (2) starter seats or one (1) starter seat and one (1) add-on seat. • Shipped assembled. • Carton weight/size: 14 lbs./2.5 cubic ft. 	To Order, Specify: <ol style="list-style-type: none"> 1) Product number. 2) Laminate color or wood finish. 3) Frame finish color. 			
NOTE: This table can be added between two preconfigured seating units.					
Square Corner Table  KLCC-7TQ0	Dimensions H: 18"(457mm) D: 32"(813mm) - Table top W: 32"(813mm) - Table top	Corner Table	KLCC-7TQ0	\$1021.66	\$1021.66
	Features <ul style="list-style-type: none"> • Includes table top, support leg and framework. • Available in laminate top with black PVC edge or veneer top with color-matched wood edge. • Requires the support of two (2) starter seats or one (1) starter seat and one (1) add-on seat. • Table top and framework shipped assembled. Leg requires field assembly. • Carton weight/size: 25 lbs./4 cubic ft. 	To Order, Specify: <ol style="list-style-type: none"> 1) Product number. 2) Laminate color or wood finish. 3) Frame finish color. 			
NOTE: This table can be added between two preconfigured seating units.					
Radius Corner Table  KLCC-7TA0	Dimensions H: 18"(457mm) D: 32"(813mm) - Table top W: 32"(813mm) - Table top	Corner Table	KLCC-7TA0	\$1021.66	\$1021.66
	Features <ul style="list-style-type: none"> • Includes table top, support leg and framework. • Available in laminate top with black PVC edge or veneer top with color-matched wood edge. • Requires the support of two (2) starter seats or one (1) starter seat and one (1) add-on seat. • Table top and framework shipped assembled. Leg requires field assembly. • Carton weight/size: 21 lbs./4 cubic ft. 	To Order, Specify: <ol style="list-style-type: none"> 1) Product number. 2) Laminate color or wood finish. 3) Frame finish color. 			
NOTE: This table can be added between two preconfigured seating units.					

Tempo Series

Bariatric Lounge Seating

Description	Number	Fabric Grade								Leather	
		A	B	C	D	E	F	G	H	Grade A	Grade B
Without Arms	KLB1-7200	\$1703.16	\$1941.74	\$2115.36	\$2190.96	\$2226.39	\$2520.49	\$2697.65	\$3179.54	\$3233.87	\$4077.75
Black Urethane Arms	KLB1-7210	1946.47	2185.05	2358.67	2434.27	2469.70	2763.80	2940.96	3422.85	3477.18	4321.06
Wood Arms	KLB1-7220	1946.47	2185.05	2358.67	2434.27	2469.70	2763.80	2940.96	3422.85	3477.18	4321.06

Open Frame Lounge — One Seat



KLB1-7200



KLB1-7220

Dimensions

SH: 18 1/4"(464mm)
 H: 34 1/2"(876mm)
 D: 26"(660mm)
 W: 40 1/4"(1022mm)
 with arms
 36" (914mm)
 without arms
 AH: 26 1/4"(667mm)
 SW: 31"(787mm)
 SD: 18 3/4"(476mm)

Features

- Available without arms, black integral skinned urethane or maple ply arms.
- Tested to 750 pounds weight capacity.
- Shipped assembled.
- Carton weight/size:
 KLB1-7200: 81 lbs./24 cubic ft.
 KLB1-7220: 88 lbs./24 cubic ft.
- COM yardage: 3.5
- COL square footage: 86.0
- COL option is priced at Grade C price.

To Order, Specify:

- 1) Product number.
- 2) Fabric surface and color.
- 3) Frame finish color.
- 4) Arm wood finish color, if specified.

Stain Repellent Option:

Add **-P** to the product number, and add **\$61.41** list.

Moisture Barrier Option:











Add **-D** to the product number, and add **\$96.84** list.

Stain repellent and moisture barrier options not available on leather, faux leather or Haworth+ upholstery options.

For available fabrics, refer to surfaces.haworth.com.

Galerie Collection

Lounge Seating

Base/ Frame	Number	Fabric Grade		C	D	E	F	G	H	Leather Grade A	Leather Grade B
		A	B								
Maple	4080-00 	\$1813.00	\$1906.31	\$1985.44	\$2316.15	\$2392.92	\$2485.05	\$2629.14	\$3027.18	\$3655.53	\$5048.11
Leg-Base Chair, Fully Upholstered  4080-00		Dimensions SH: 18 1/2"(470mm) H: 33 3/4"(857mm) D: 26"(660mm) W: 27"(686mm) AH: 26 1/2"(673mm) SW: 18"(457mm) SD: 18"(457mm)		Features <ul style="list-style-type: none"> • Upholstered arm panels, seat and back. • Seat frame rails are doweled and reinforced with corner blocks. • Upholstered seat and back, polyester fiber and foam over wide support webbing. • COM yardage: 3.5 • COL square footage: 63.0  Available on RUSH.		To Order, Specify: <ol style="list-style-type: none"> 1) Product number. 2) Fabric surface and color. 3) Frame finish color. CAL 133 Option: Add -F to the product number, and add \$115.75 list.					
Maple	180-0028 	\$2309.06	\$2469.69	\$2606.70	\$2911.43	\$2998.83	\$3268.12	\$3476.00	\$4044.11	\$5453.17	\$7186.47
Lounge Chair  180-0028		Dimensions SH: 18 1/2"(470mm) H: 32 3/4"(832mm) D: 28 1/4"(718mm) W: 29 1/2"(749mm) AH: 25 3/4"(654mm) SW: 21"(533mm) SD: 18 1/2"(470mm)		Features <ul style="list-style-type: none"> • Interior frame has glued and doweled joints, reinforced with screws and cleats. • Foam core seat and back cushions with spun polyester batting. • Upholstered back cushions, loose reversible seat cushions over strip webbing. • Exposed hard maple legs. • COM yardage: 5.0 • COL square footage: 90.0  Available on RUSH.		To Order, Specify: <ol style="list-style-type: none"> 1) Product number. 2) Fabric surface and color. 3) Arm/leg finish color. Stain Repellent Option: To specify, add -P to the end of the product number and add \$61.41 list. Example: 180-0028-P					
		Moisture Barrier Option: To specify, add -D to the end of the product number and add \$96.84 list. Example: 180-0028-D For available fabrics, refer to surfaces.haworth.com .									
Maple	180-0053 	\$3072.06	\$3291.74	\$3481.90	\$3804.34	\$3955.53	\$4654.74	\$4996.08	\$5933.89	\$7253.18	\$9560.28
Settee  180-0053		Dimensions SH: 18 1/2"(470mm) H: 32 3/4"(832mm) D: 28 1/2"(724mm) W: 54 1/2"(1384mm) AH: 25 3/4"(654mm) SW: 45 1/4"(1149mm) SD: 18 1/2"(470mm)		Features <ul style="list-style-type: none"> • Interior frame has glued and doweled joints, reinforced with screws and cleats. • Foam core seat and back cushions with spun polyester batting. • Upholstered back cushions, loose reversible seat cushions over strip webbing. • Exposed hard maple legs. • COM yardage: 8.25 • COL square footage: 148.50  Available on RUSH.		To Order, Specify: <ol style="list-style-type: none"> 1) Product number. 2) Fabric surface and color. 3) Arm/leg finish color. Stain Repellent Option: To specify, add -P to the end of the product number and add \$121.66 list. Example: 180-0053-P					
		Moisture Barrier Option: To specify, add -D to the end of the product number and add \$194.89 list. Example: 180-0053-D For available fabrics, refer to surfaces.haworth.com .									
Maple	180-0075	\$3450.00	\$3705.11	\$3923.63	\$4292.13	\$4657.09	\$5274.82	\$5668.12	\$6745.29	\$8696.48	\$11591.76
Sofa  180-0075		Dimensions SH: 18 1/2"(470mm) H: 32 3/4"(832mm) D: 28 1/2"(724mm) W: 76 1/2"(1943mm) AH: 25 3/4"(654mm) SW: 67 1/4"(1708mm) SD: 18 1/2"(470mm)		Features <ul style="list-style-type: none"> • Interior frame has glued and doweled joints, reinforced with screws and cleats. • Foam core seat and back cushions with spun polyester batting. • Upholstered back cushions, loose reversible seat cushions over strip webbing. • Exposed hard maple legs. • COM yardage: 9.50 • COL square footage: 171.0 		To Order, Specify: <ol style="list-style-type: none"> 1) Product number. 2) Fabric surface and color. 3) Arm/leg finish color. Stain Repellent Option: To specify, add -P to the end of the product number and add \$880.15 list. Example: 180-0075-P					
		Moisture Barrier Option: To specify, add -D to the end of the product number and add \$291.73 list. Example: 180-0075-D For available fabrics, refer to surfaces.haworth.com .									

Galerie Collection

Occasional Tables

	Height	Depth	Width	Number	Wood Price	Glass Top Inset Price
5800 Series Tables	16"(406mm)	18"(457mm)	18"(457mm)	5818-1816	\$1665.36	1914.58
	22"(559mm)	18"(457mm)	18"(457mm)	5818-1822	1684.26	1933.48
	16"(406mm)	26"(660mm)	26"(660mm)	5826-2616	1763.40	2036.23
	22"(559mm)	26"(660mm)	26"(660mm)	5826-2622	1782.30	2055.13

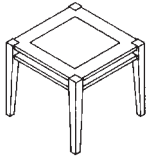

5818-1816

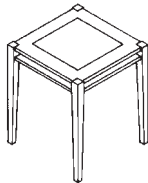

5818-1822

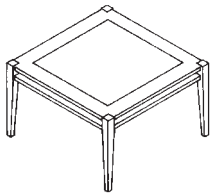

5826-2616

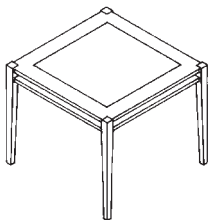

5826-2622

Features

- Square tables feature a reverse-diamond veneer pattern inset.
- Glass inset option is 3/8"(10mm)-thick frosted glass with a green tint.
- Standard with maple veneer insets and maple solids.

To Order, Specify:

- 1) Product number.
- 2) Wood finish color.

Glass Option:

To specify glass top inset add **-G** suffix to the product number and refer to pricing listed above.

Wood Finishes	
Maple	
Amber	M2-CA1
American	M2-W23
Beech	M2-W04
Caramel	M2-W33
Cordovan	M2-W13
Crown	M2-W24
Espresso	M2-W15
Golden	M2-W08
Heritage	M2-W30
Light Anegre	M2-W07
Mahogany Satin	M2-W21
Natural	M2-N
Pacific	M2-W32
Retro	M2-W31
Sand	M2-AD

Galerie Collection

Occasional Tables

	Height	Depth	Width	Number	Wood Price	Glass Top Inset Price
5900 Series Tables	16"(406mm)	18"(457mm)	18"(457mm)	5918-1816	\$1551.98	\$1783.47
	22"(559mm)	18"(457mm)	18"(457mm)	5918-1822	1570.88	1802.37
	16"(406mm)	26"(660mm)	26"(660mm)	5926-2616	1698.44	1955.92
	22"(559mm)	26"(660mm)	26"(660mm)	5926-2622	1717.34	1974.82

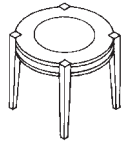

5918-1816

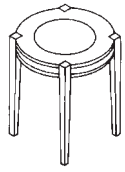

5918-1822

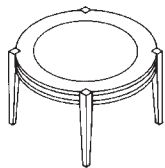

5926-2616

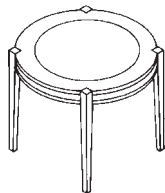

5926-2622

Features

- Round tables feature a straight-grain veneer pattern inset.
- Glass inset option is 3/8"(10mm)-thick frosted glass with a green tint.
- Standard with maple veneer insets and maple solids.

To Order, Specify:

- 1) Product number.
- 2) Wood finish color.

Glass Option:

To specify glass top inset add **-G** suffix to the product number and refer to pricing listed above.

Wood Finishes	
Maple	
Amber	M2-CA1
American	M2-W23
Beech	M2-W04
Caramel	M2-W33
Cordovan	M2-W13
Crown	M2-W24
Espresso	M2-W15
Golden	M2-W08
Heritage	M2-W30
Light Anegre	M2-W07
Mahogany Satin	M2-W21
Natural	M2-N
Pacific	M2-W32
Retro	M2-W31
Sand	M2-AD

Tuxedo Series

Lounge Seating

Base/ Frame	Number	Fabric Grade		C	D	E	F	G	H	Leather Grade A	Leather Grade B
		A	B								
Fully upholstered	2006-0031	\$3296.47	\$3518.52	\$3709.86	\$4032.30	\$4239.00	\$4544.90	\$4813.02	\$5551.21	\$7529.56	\$9864.55

Lounge Chair

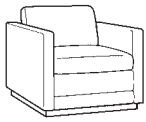

2006-0031

Dimensions

SH: 18"(457mm)
 H: 29"(737mm)
 D: 34"(864mm)
 W: 32"(813mm)
 AH: 24"(610mm)
 SW: 24 1/2"(622mm)
 SD: 23"(584mm)

Features

- 2"(51mm) black plinth base.
- Interior frame has glued and doweled joints, reinforced with screws and cleats.
- Reversible seat and back cushions.
- Cushions are foam core wrapped in spun-polyester fiber over 3"(76mm) strip webbing.
- Back is foam over wide support webbing.
- COM yardage: 6.50
- COL square footage: 117.0

To Order, Specify:

- 1) Product number.
- 2) Fabric surface and color.

Stain Repellent Option:

To specify, add **-P** to the end of the product number and add **\$61.41** list.
Example: 2006-0031-**P**

Moisture Barrier Option:

To specify, add **-D** to the end of the product number and add **\$96.84** list.
Example: 2006-0031-**D**

For available fabrics, refer to surfaces.haworth.com.

Fully upholstered	2006-0056	\$4423.25	\$4717.35	\$5036.25	\$5263.02	\$5374.04	\$6153.57	\$6523.26	\$7546.10	\$10070.12	\$13184.81
-------------------	-----------	------------------	------------------	------------------	------------------	------------------	------------------	------------------	------------------	-------------------	-------------------

Settee

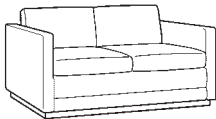

2006-0056

Dimensions

SH: 18"(457mm)
 H: 29"(737mm)
 D: 34"(864mm)
 W: 57"(1448mm)
 AH: 24"(610mm)
 SW: 49"(1245mm)
 SD: 23"(584mm)

Features

- 2"(51mm) black plinth base.
- Interior frame has glued and doweled joints, reinforced with screws and cleats.
- Reversible seat and back cushions.
- Cushions are foam core wrapped in spun-polyester fiber over 3"(76mm) strip webbing.
- Back is foam over wide support webbing.
- COM yardage: 9.0
- COL square footage: 162.0

To Order, Specify:

- 1) Product number.
- 2) Fabric surface and color.

Stain Repellent Option:

To specify, add **-P** to the end of the product number and add **\$122.83** list.
Example: 2006-0056-**P**

Moisture Barrier Option:

To specify, add **-D** to the end of the product number and add **\$193.70** list.
Example: 2006-0056-**D**

For available fabrics, refer to surfaces.haworth.com.

Fully upholstered	2006-0072	\$5368.13	\$5691.76	\$6010.65	\$6548.06	\$6607.11	\$7575.62	\$8051.60	\$9356.73	\$12425.25	\$16316.43
-------------------	-----------	------------------	------------------	------------------	------------------	------------------	------------------	------------------	------------------	-------------------	-------------------

Sofa



2006-0072

Dimensions

SH: 18"(457mm)
 H: 29"(737mm)
 D: 34"(864mm)
 W: 73"(1854mm)
 AH: 24"(610mm)
 SW: 65"(1651mm)
 SD: 23"(584mm)

Features

- 2"(51mm) black plinth base.
- Interior frame has glued and doweled joints, reinforced with screws and cleats.
- Reversible seat and back cushions.
- Cushions are foam core wrapped in spun-polyester fiber over 3"(76mm) strip webbing.
- Back is foam over wide support webbing.
- COM yardage: 11.50
- COL square footage: 207.0

To Order, Specify:

- 1) Product number.
- 2) Fabric surface and color.

Stain Repellent Option:

To specify, add **-P** to the end of the product number and add **\$184.25** list.
Example: 2006-0072-**P**

Moisture Barrier Option:

To specify, add **-D** to the end of the product number and add **\$290.56** list.
Example: 2006-0072-**D**

For available fabrics, refer to surfaces.haworth.com.

K100 Series and Scamps

Features and Options

Seating models feature:

Tubular steel frames available in full range of powder paint finish colors, including a polished chrome option. Frame sizes range from 1"(25mm) to 2 1/2"(64mm) outside diameter.

All products meet or exceed ANSI/BIFMA standards.

Seat and Back Options:

- Fully-upholstered seats and backs feature a molded polyurethane foam cushion supported by an inner steel armature, or a molded plywood shell. Selected seating models feature a zippered seat cover for easy field replacement of upholstery.
- Scamps Series features laminate seats and backs with PVC edges.

Base Options:

- Sled base models standard with floor glides.
- Leg base models standard with floor glides.
- 8"(203mm) x 8"(203mm) steel floor mounting plate for permanent attachment to the floor surface, available on select seating models.
- K100 Series public seating models available with three base styles: floor-mount steel base, cast aluminum base, or tubular steel base.

K100 Series and Scamps

General Specifications

COM & COL General Information

To order a COM fabric (Customer's Own Material), contact the Haworth Inquiry Center (1.800.426.8562), your local Haworth dealer, or go to haworth.com/surfaces > COM Library to find out if the COM you have selected has already been tested and approved. The surface collection site also has information on the Haworth + alliance program with Carnegie, Luna Textiles, and Maharam as well as our industry-leading Pre-Approved COM program.

COM fabrics are placed into Grades based on the cost per linear yard. If a fabric's cost exceeds the range of our highest Grade it will be noted as Non-Graded. The product will be priced at Grade A; the COM fabric costs will appear as a separate line item. The fabric charge will be Haworth's purchase cost plus a 4% administrative fee (based on the cost of the fabric). Yardage calculations will include any applicable fabric repeat.

COM Leather products will be priced at a leather Grade A; COL costs will appear as a separate line item. The leather costs will be Haworth's purchase cost plus a 4% administrative fee (based on the cost of the leather).

Flammability Requirements

Flammability standards met by seating fabrics are identified on the fabric selection color cards. Upholstery foam is compounded to meet specifications of Federal Motor Vehicle Safety Standard 302 and California 117.

Select seating models are available with an optional fire retardant construction for compliance with California Bulletin #133 and the City of Boston Fire Code. Refer to the price charts for ordering information.

Environmental Factors**Material Off Gassing**

In an effort to ensure air quality standards, all parts suppliers are required to provide Material Data Sheets and/or other documentation, verifying that their products do not emit volatile organic components (VOC). In addition, the powder-coat paint process used in the manufacturing of seating is free of VOCs. Our manufacturing processes have also eliminated all use of chlorofluorocarbons (CFCs) and ozone depleting chemicals (ODCs) in the product's construction.

Recycling

All fabric scraps are recycled, reducing the amount of material sent to landfills, and all components disassemble easily to increase the potential for recycling. Recycled parts are identified with the recycle symbol where practical.

General Guidelines for Product Specification

Seating specification numbers are based on an alpha-numeric logic that identifies a product by model and certain characteristics.

The following identifies the alpha-numeric logic for Tempo Series lounge seating models. Beyond the printed product number, fabric and finish codes are required to complete an order specification.

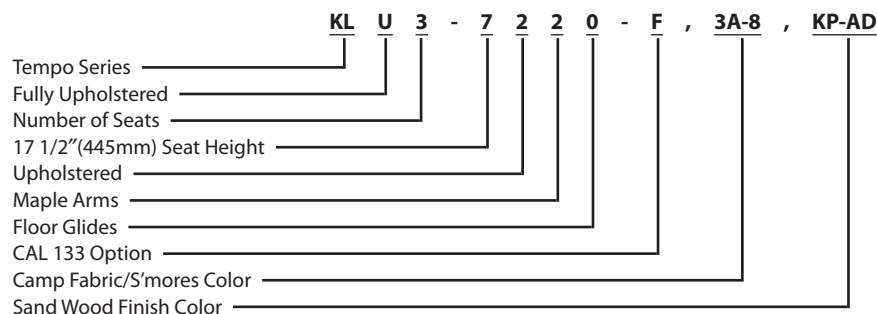

A ninth-digit suffix of the product code will indicate functional options, such as -F for CAL 133 option. There are exceptions to this logic; therefore, always refer to the price charts for product numbers rather than attempting to construct them. Product number modification instructions for additional options appear in footnoted copy for each applicable model.

Beyond the printed product number, fabric and finish codes are required to complete an order specification. To communicate your order clearly, list the product number and finish codes in the sequence outlined on each price page.

RUSH

Select seating models are marked with a  symbol to denote availability on the RUSH program. Refer to the fabric and finish options for each model.

Finishes and Fabrics

A complete listing of finishes/fabrics for seating can be found in the back of the price list.

K120 Series

Guest/Occasional Seating

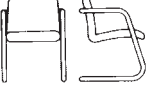
	Number	Fabric Grade							
		A	B	C	D	E	F	G	H
K120 Series	K120-2210	\$576.63	\$660.90	\$723.49	\$749.99	\$763.22	\$771.65	\$813.78	\$930.56
<i>Sled Base with Arms</i> <i>Open-Frame Base</i>	Dimensions	Features							
	SH: 18"(457mm) (fabric)	<ul style="list-style-type: none"> • Frame dimension is 1 1/2"(38mm) O.D. tubular steel. • Fully-upholstered seat and back. • Chairs are standard with glides. • Ganging clips available. See below. • Available with fire-retardant construction to comply with California Bulletin #133. • Carton weight/size: 31 lbs./10.5 cubic ft. • COM yardage: 1.25 							
	H: 30"(762mm)								
	D: 23"(584mm)								
	W: 22"(559mm)								
	AH: 25 1/2"(648mm)								
K120-2210 (Formerly 100/200)	To Order, Specify:								
		<ol style="list-style-type: none"> 1) Product number. 2) Fabric surface and color. 3) Kinkote frame trim color or Chrome (KR-V). Add \$128.81 list for Chrome finish. 							
		CAL 133 Option:							
		Add -F to the product number, and add \$62.60 list.							

Ganging Clip

KGNG-150

Number	Price
KGNG-150	\$18.06
Features	To Order, Specify:
<ul style="list-style-type: none"> • Row seating ganging clip for 1 1/2"(38mm) O.D. frame. • Two recommended per connection. • Standard in Kintone (flat black) color only. 	<ol style="list-style-type: none"> 1) Product number. (No finish specification required.)

K100 Series

Public Seating

Specification and Ordering Information

Use the following guidelines when specifying and ordering K100 Public Seating. A sketch of the product layout is not required to process an order for K100 products.

1. K100 Series seats mount to K100 Series beams.
2. In K100 series, seats and in-line tables occupy one position on the beam. Calculate the total of these units to ensure they match the number of beam positions specified, as indicated in the beam model number. For example, K153-3 includes three mounting positions and requires a combination of three seats and/or in-line tables.
3. Corner tables have their own support beam and hardware and do not occupy a position on the beam. The tables connect two beams together at right angles, and are not available for the freestanding end of the beam. Refer to page 357 for corner table models and their proper applications.
4. Public seating configurations can also include corners created by specifying either a 45° corner beam, which accommodates one seat, or an in-line table.
5. Although a drawing is not required to process an order, Haworth recommends ordering from a layout drawing to ensure accuracy in seat-count and corner table selection.

K100 Series Layout

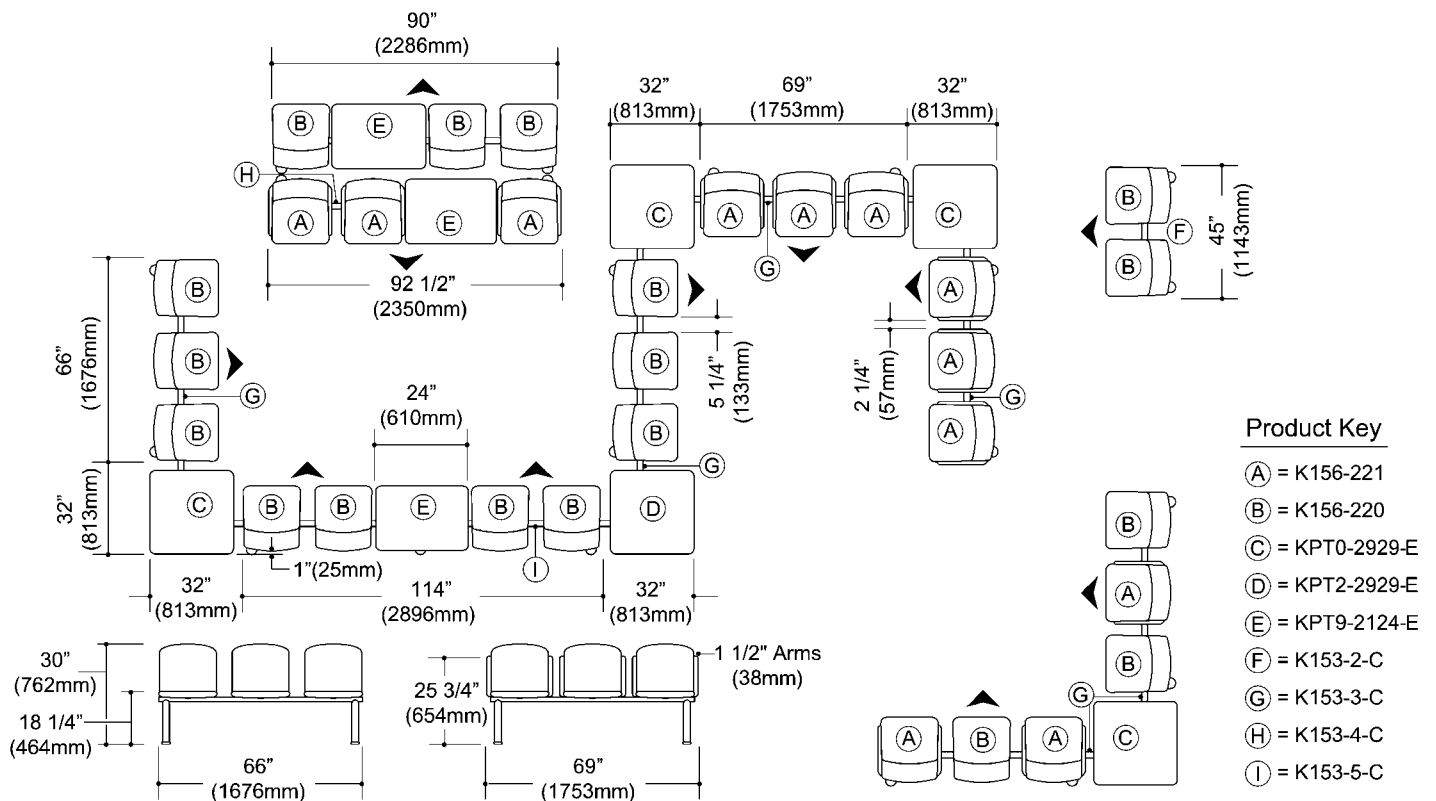

K100 Series

Public Seating — Beam Mounted Components

	Dimensions	Number	Fabric Grade							
			A	B	C	D	E	F	G	H
K100 Series <i>Seat with Arms</i>	SH: 18"(457mm) H: 30"(762mm) D: 25"(635mm) W: 22"(559mm)	K156-221	\$606.73	\$691.00	\$753.59	\$780.09	\$905.28	\$801.75	\$843.88	\$960.66
 K156-221 (Formerly 100/506)		Features								To Order, Specify:
		<ul style="list-style-type: none"> • Connecting plate for beam mount standard in black finish color. • Fully-upholstered seat and back. • Available with fire retardant construction to comply with California Bulletin #133. • Carton weight/size: 20 lbs./6.3 cubic ft. • COM yardage: 1.25 								<ol style="list-style-type: none"> 1) Product number. 2) Fabric surface and color. 3) Kinkote arm trim color or Chrome (KR-V). Add \$111.96 list for Chrome finish.
										CAL 133 Option:
										Add -F to the product number, and add \$62.60 list to each seat.

	Dimensions	Number	Fabric Grade							
			A	B	C	D	E	F	G	H
K100 Series <i>Armless Seat</i>	SH: 18"(457mm) H: 30"(762mm) D: 23"(584mm) W: 19"(483mm)	K156-220	\$465.88	\$550.15	\$612.74	\$639.24	\$652.47	\$660.90	\$703.03	\$819.81
 K156-220 (Formerly 100/505)		Features								To Order, Specify:
		<ul style="list-style-type: none"> • Connecting plate for beam mount standard in black finish color. • Fully-upholstered seat and back. • Available with fire retardant construction to comply with California Bulletin #133. • Carton weight/size: 15 lbs./6.3 cubic ft. • COM yardage: 1.25 								<ol style="list-style-type: none"> 1) Product number. 2) Fabric surface and color.
										CAL 133 Option:
										Add -F to the product number, and add \$62.60 list to each seat.

	Dimensions	Table Edge		Number	Laminate Surface	
K100 Series <i>In-Line Table</i>	D: 21"(533mm) W: 24"(610mm)	Bullnose PVC		KPT9-2124-E	\$290.12	
 KPT9-2124 (Formerly 100/508)		1/4"(6mm)-thick PVC		KPT9-2124-F	290.12	
		Features				To Order, Specify:
		<ul style="list-style-type: none"> • For use with K100 seating and beams. • Connecting plate for beam mount standard in black finish color. • Interchangeable with seat unit at any mounting location along the support beam. • 1/4"(6mm)-thick PVC edge standard in Kintone (flat black) color only. 				<ol style="list-style-type: none"> 1) Product number. 2) Table surface laminate color. 3) PVC edge color (optional).

K100 Series

Public Seating

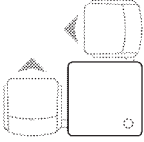
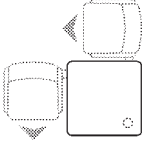
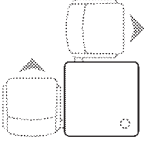
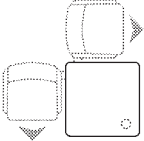
		Table Edge	Number	Laminate Surface
K100 Series Corner Connecting Table, Configuration #1	Dimensions D: 29"(737mm) W: 29"(737mm)	Bullnose PVC	KPT0-2929-E	\$580.24
		1/4"(6mm)-thick PVC	KPT0-2929-F	580.24
 <p>KPT0-2929 (Formerly 100/510)</p>		Features	To Order, Specify:	
		<ul style="list-style-type: none"> Used to join a variety of right-angle seating configurations. Connects to the ends of two beams, page 358. List price includes support structure and beam connectors. Arrows alongside illustration indicate seat direction. 1/4"(6mm)-thick PVC edge standard in Kintone (flat black) color only. 	<ol style="list-style-type: none"> Product number. Table surface laminate color. PVC edge color (optional). Kinkote support structure trim color. 	
K100 Series Corner Connecting Table, Configuration #2	Dimensions D: 29"(737mm) W: 29"(737mm)	Bullnose PVC	KPT1-2929-E	\$580.24
		1/4"(6mm)-thick PVC	KPT1-2929-F	580.24
 <p>KPT1-2929 (Formerly 100/511)</p>		Features	To Order, Specify:	
		<ul style="list-style-type: none"> Used to join a variety of right-angle seating configurations. Connects to the ends of two beams, page 358. List price includes support structure and beam connectors. Arrows alongside illustration indicate seat direction. 1/4"(6mm)-thick PVC edge standard in Kintone (flat black) color only. 	<ol style="list-style-type: none"> Product number. Table surface laminate color. PVC edge color (optional). Kinkote support structure trim color. 	
K100 Series Corner Connecting Table, Configuration #3	Dimensions D: 29"(737mm) W: 29"(737mm)	Bullnose PVC	KPT2-2929-E	\$580.24
		1/4"(6mm)-thick PVC	KPT2-2929-F	580.24
 <p>KPT2-2929 (Formerly 100/512)</p>		Features	To Order, Specify:	
		<ul style="list-style-type: none"> Used to join a variety of right-angle seating configurations. Connects to the ends of two beams, page 358. List price includes support structure and beam connectors. Arrows alongside illustration indicate seat direction. 1/4"(6mm)-thick PVC edge standard in Kintone (flat black) color only. 	<ol style="list-style-type: none"> Product number. Table surface laminate color. PVC edge color (optional). Kinkote support structure trim color. 	
K100 Series Corner Connecting Table, Configuration #4	Dimensions D: 29"(737mm) W: 29"(737mm)	Bullnose PVC	KPT3-2929-E	\$580.24
		1/4"(6mm)-thick PVC	KPT3-2929-F	580.24
 <p>KPT3-2929 (Formerly 100/513)</p>		Features	To Order, Specify:	
		<ul style="list-style-type: none"> Used to join a variety of right-angle seating configurations. Connects to the ends of two beams, page 358. List price includes support structure and beam connectors. Arrows alongside illustration indicate seat direction. 1/4"(6mm)-thick PVC edge standard in Kintone (flat black) color only. 	<ol style="list-style-type: none"> Product number. Table surface laminate color. PVC edge color (optional). Kinkote support structure trim color. 	

K100 Series

Public Seating

		Number	Base	Price
Two Seat Beam  K153-2	Dimensions H: 16"(406mm) D: 23"(584mm) W: 42"(1067mm)	K153-2-C	Cast Base	\$805.37
		K153-2-T	Tube Base	776.46
		K153-2-F	Floor Mount Base	745.17

Three Seat Beam  K153-3	Dimensions H: 16"(406mm) D: 23"(584mm) W: 66"(1676mm)	K153-3-C	Cast Base	\$875.20
		K153-3-T	Tube Base	846.29
		K153-3-F	Floor Mount Base	815.00

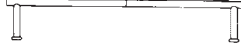
Four Seat Beam  K153-4	Dimensions H: 16"(406mm) D: 23"(584mm) W: 90"(2286mm)	K153-4-C	Cast Base	\$969.10
		K153-4-T	Tube Base	940.19
		K153-4-F	Floor Mount Base	908.90

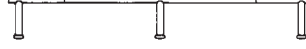
Five Seat Beam  K153-5	Dimensions H: 16"(406mm) D: 23"(584mm) W: 114"(2896mm)	K153-5-C	Cast Base	\$1342.26
		K153-5-T	Tube Base	1290.49
		K153-5-F	Floor Mount Base	1248.36

Six Seat Beam  K153-6	Dimensions H: 16"(406mm) D: 23"(584mm) W: 138"(3505mm)	K153-6-C	Cast Base	\$1443.38
		K153-6-T	Tube Base	1391.61
		K153-6-F	Floor Mount Base	1349.48

Seven Seat Beam  K153-7	Dimensions H: 16"(406mm) D: 23"(584mm) W: 162"(4115mm)	K153-7-C	Cast Base	\$1508.39
		K153-7-T	Tube Base	1456.62
		K153-7-F	Floor Mount Base	1414.49

Eight Seat Beam  K153-8	Dimensions H: 16"(406mm) D: 23"(584mm) W: 186"(4724mm)	K153-8-C	Cast Base	\$1875.57
		K153-8-T	Tube Base	1809.36
		K153-8-F	Floor Mount Base	1751.57

Base Options

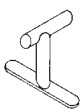

Cast Base (-C)
Chrome foot only

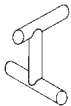

Tube Base(-T)



Floor Mount Base (-F)
Base mounting plate is 8"(203mm) x 8"(203mm).

To Order, Specify:

- 1) Product number.
- 2) Kinkote beam and base trim color.

K100 Series

Public Seating

	Number	Base	Price
Nine Seat Beam  K153-9	Dimensions		
	K153-9-C	Cast Base	\$1956.22
	K153-9-T	Tube Base	1890.01
	K153-9-F	Floor Mount Base	1832.22

Ten Seat Beam  K153-10	Dimensions		
	K153-10-C	Cast Base	\$2038.08
	K153-10-T	Tube Base	1971.87
	K153-10-F	Floor Mount Base	1914.08

45° Corner Beam  K153-45	Dimensions		
	K153-45-C	Cast Base	\$855.92
	K153-45-T	Tube Base	845.08
	K153-45-F	Floor Mount Base	823.42

Seating configuration represents the location of the chairs only. Suspended corner bar accepts one seat only.

Base Options

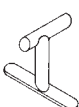

Cast Base (-C)
Chrome foot only

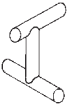

Tube Base (-T)





Floor Mount Base (-F)
Base mounting plate is 8"(203mm) x 8"(203mm).

To Order, Specify:

- 1) Product number.
- 2) Kinkote beam and base trim color.

Scamps Series

Children's Furniture

		Number	Price
Chair with Arms	Dimensions	KSCP-5110	\$522.45
	SH: 14"(356mm) H: 25"(635mm) D: 19"(483mm) W: 15 3/4"(400mm) AH: 20"(508mm)	Features	To Order, Specify:
KSCP-5110 (Formerly 700/201)		<ul style="list-style-type: none"> Recommended for ages 4 to 7. Frame dimension is 1 1/8"(29mm) O.D. tubular steel. Back and seat are laminate construction with PVC edges. (Available in standard laminates only.) Feet are capped with integral skinned urethane glides in black only. Carton weight/size: 22 lbs./5.8 cubic ft. 	<ol style="list-style-type: none"> Product number. Laminate color. PVC edge color. Kinkote frame trim color.
Scamps Series	Dimensions	KSTR-24	\$598.29
Round Table	H: 24"(610mm) D: 24"(610mm) W: 24"(610mm)	Features	To Order, Specify:
		<ul style="list-style-type: none"> Shipped K.D. Frame dimension is 1 1/8"(29mm) O.D. tubular steel. Table surface is laminate construction with PVC edge. (Available in standard laminates only.) Feet are capped with nylon glides in black only. Carton weight/size: 30 lbs./6.8 cubic ft. 	<ol style="list-style-type: none"> Product number. Laminate color. PVC edge color. Kinkote frame trim color.
KSTR-24 (Formerly 700/300)			

Tilt
Stool

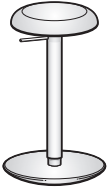
	Number	Price
 <p>STS-1</p> <p>Dimensions SH: 23.5"-34.75" (597mm-883mm) Seat: 12"(305mm) Diameter Base: 14"(356mm) Diameter Col.: 2"(51mm) Diameter</p>	<p>STS-1</p> <p>Features</p> <ul style="list-style-type: none"> • Base: Overmolded structural urethane covered with steel. • Base is rounded to allow movement and allow user to lean on stool. • Seat: Urethane with an MDF substrate. • Seat available in black only. • Steel column with pneumatic height adjustment. • Available in four trim colors. Black (TR-F), Graphite (TR-J), Accent Orange (TR-1E) or Smooth Plaster (TR-PLS). <p>Specification Tips</p> <ul style="list-style-type: none"> • Plant feet firmly on the floor while leaning on the seat. • Rounded base allows movement in any direction. 	<p>To Order, Specify:</p> <ol style="list-style-type: none"> 1) Product number. 2) Trim color. <p>\$1325.33</p>

Finish/Color Legends

Accolade Seating

Trim Colors

TR-F	Black
TR-J	Graphite
TR-G	Gray Tone

Fern

Trim Colors

TR-F	Black
TR-7	Fog
TR-UFM	Snow

Aluminum Colors

TR-MC	Metallic Champagne
TR-LE	Metallic Silver
TR-TF	Pitch
PM-P	Polished Aluminum

Harbor Work Lounge

Base

Trim Colors

TR-PLS	Smooth Plaster
TR-F	Black
TR-1E	Accent Orange
PM-P	Polished Aluminum

Cup Holder

Trim Colors

TR-AK	Chalk
TR-F	Black

Tablet Arms

Laminate

H-WL	Linen
H-AA	Putty
H-8J	Charcoal

Veneer

VR-W35	Clear on Walnut
NR-W35	Clear on Rift Cut White Oak

Noble Wing Material

JA-AR	Arctic	JA-FL	Flagstone
JA-BE	Bird's Egg	JA-FG	Fresh Green
JA-CA	Carbon	JA-LG	Light Gray
JA-CT	Citrus	JA-MA	Marinara
JA-CW	Cornwall	JA-GR	Oxford Gray
JA-EM	Ember	JA-PA	Pachyderm
JA-FA	Fawn		

Hello Seating

Trim Colors

TR-LE	Metallic Silver
-------	-----------------

Improv Series Desk Chairs/Improv H.E. Chairs/Improv H.E. Stool

Trim Colors

TR-F	Black
TR-J	Graphite
TR-G	Gray Tone

Note: Improv Desk and Improv H.E. Chairs with optional high arc base are available in TR-F (Black) trim only.

Improv S.E. and Improv Tag Chairs

Trim Color

TR-F	Black
------	-------

Improv Series Leg-Base/Sled-Base Chairs, Stools and Tables

Trim Colors

TR-F	Black
TR-J	Graphite
TR-G	Gray Tone
TR-E	Smoke

Metallic Trim Colors

TR-MC	Champagne
TR-LE	Silver

Grade A Solid Color Laminates

H-34	Beige
H-AK	Chalk
H-8J	Charcoal
H-3J	Graphite
H-62	Gray Tone
H-WL	Linen
H-3P	Platinum
H-AA	Putty
H-3E	Smoke
H-LC	White Sand

Grade A Wood Grain Laminates

H-AE	Maple
------	-------

Grade B Wood Grain Laminates

H-KA	Brazilwood
H-KG	Columbian Walnut
H-KP	Field Elm
H-KN	Grey Elm
H-KM	Landmark Wood
H-KC	New Age Oak
H-KL	Neo Walnut
H-KR	Phantum Ecru
H-KS	Phantum Pearl
H-KD	River Cherry
H-KE	Sanara
H-KF	Williamsburg Cherry

PVC Colors

TR-K0	Black
TR-J	Graphite
TR-G	Gray Tone
TR-E	Smoke

Wood Finish Colors

Maple	
M2-CA1	Amber
M2-W23	American
M2-W04	Beech
M2-W33	Carmel
M2-W15	Espresso
M2-W08	Golden Anegre
M2-W07	Light Anegre
M2-N	Natural
M2-W32	Pacific
M2-W31	Retro
M2-AD	Sand

ALERT: These materials are current, however they are being considered for future obsolescence due to low volume.

Metallic Trim Colors

TR-MG	Gunmetal
-------	----------

Grade A Patterned Laminates

H-DH	Barley Grain
H-22	Grey Spex
H-DA	Oats Grain
H-EK	Owl Nest
H-EC	Quail Nest
H-ED	Rhea Nest
H-EA	Robins Nest
H-DE	Wheat Grain
H-21	White Spex

Grade A Wood Grain Laminates

Medium Cherry	H-AD
---------------	------

Wood Finish Colors

Naturally Walnut	M2-W12
------------------	--------

- Note:**
- Specifying a common stain color for casegoods, wood seating, and wood occasional tables will result in a suite of furniture which has a commercially acceptable finish match.
 - Different wood species are offered on the various casegoods, chairs, and tables. Each species offer unique texture, grain, and color of raw wood and veneer. Minor variations in finish color and texture may occur due to these natural characteristics of wood. This is part of the natural beauty of wood and is not considered to be a defect.

■ Available on RUSH.

Finish/Color Legends

K100 Series Seating and Tables / Tempo Lounge / Scamps Series

Metal Finish/Color Legend

Grey Values

TR-F	Black (gloss level 25)
TR-K	Charcoal (gloss level 25)
TR-J	Graphite (gloss level 25)
TR-E	Smoke (gloss level 25)

Taupe Values (gloss level 25)

TR-G	Gray Tone
TR-AA	Putty

Metallic

TR-MC	Metallic Champagne
TR-LE	Metallic Silver

ALERT: These materials are current, however they are being considered for future obsolescence due to low volume.

Laminate/Color Legend

Grade A

Solid Color Laminates

H-34	Beige
H-AK	Chalk
H-8J	Charcoal
H-3J	Graphite
H-62	Gray Tone
H-WL	Linen
H-3P	Platinum
H-AA	Putty
H-3E	Smoke

Grade A

Wood Grain Laminates

H-AE	Maple
H-AM	Amber Cherry

Grade B

Wood Grain Laminates

H-KA	Brazilwood
H-KG	Columbian Walnut
H-KP	Field Elm
H-KN	Grey Elm
H-KM	Landmark Wood
H-KC	New Age Oak
H-KR	Phantum Ecu
H-KS	Phantum Pearl
H-KC	New Age Oak
H-KL	Neo Walnut
H-KD	River Cherry
H-KE	Sanara
H-KF	Williamsburg Cherry

Plastic Edge Color Legend

TR-R	Beige
TR-AK	Chalk
TR-K	Charcoal
TR-J	Graphite
TR-G	Gray Tone
TR-AA	Putty
TR-E	Smoke

Veneer/Color Legend

Maple

M2-CA1	Amber**
M2-W23	American**
M2-W15	Espresso
M2-N	Natural
M2-AD	Sand

**Available only on Tempo Series.

Metallic

TR-MG Gunmetal

Grade A

Wood Grain Laminates
Medium Cherry H-AD

Grade A

Patterned Laminates

H-DH	Barley Grain
H-22	Grey Spex
H-DA	Oats Grain
H-EK	Owl Nest
H-EC	Quail Nest
H-ED	Rhea Nest
H-EA	Robins Nest
H-DE	Wheat Grain
H-21	White Spex

- Note:**
- Specifying a common stain color for casegoods, wood seating, and wood occasional tables will result in a suite of furniture which has a commercially acceptable finish match.
 - Different wood species are offered on the various casegoods, chairs, and tables. Each species offer unique texture, grain, and color of raw wood and veneer. Minor variations in finish color and texture may occur due to these natural characteristics of wood. This is part of the natural beauty of wood and is not considered to be a defect.

Lively

Trim Colors

TR-F	Black
------	-------

LOOK Side Chair

Polypropylene Shell Colors

TR-F	Black
TR-W	White

Trim Colors

TR-F	Black
TR-MC	Metallic Champagne
TR-LE	Metallic Silver

ALERT: These materials are current, however they are being considered for future obsolescence due to low volume.

Trim Colors

TR-MG Gunmetal

Monaco Seating

Trim Colors

TR-F	Black
PN-B	Brushed Aluminum

Openest

Trim Colors

TR-1E	Accent Orange
TR-F	Black
TR-PLS	Smooth Plaster
TR-RR	Rusty Red

Thread Colors

NS-1E	Accent Orange
NS-F	Black
NS-PLS	Plaster
NS-RR	Rusty Red

Table Surfaces - Painted

PW-F	Black
PW-PL	Polar
PW-SY	Stormy
PW-VA	Vapor

Sprig Table Surfaces - Wood

VB-W35	Plank Wood
VH-W35	Plank Walnut

Poppy

Trim Colors

TR-F	Black
TR-PLS	Smooth Plaster

Wood Finishes

M5-W35	Clear on Oak
M6-W35	Clear on Walnut
M7-W43	Ink on Ash

System 12

Trim Colors

TR-F	Black
KR-V	Chrome
TR-15	Light Gray
TR-3	Pebble Gray

Polypropylene Shell Colors

TR-F	Black
TR-94	Burgundy
TR-110	Jupiter Green
TR-15	Light Gray
TR-108	Mars Red
TR-92	Navy
TR-106	Neptune Blue
TR-3	Pebble Gray
TR-109	Saturn Orange

Available on RUSH.

Finish/Color Legends

ToDo Seating

Trim Colors

TR-F	Black
TR-M01	Switch Silver

Maple Veneer Finish

M2-CA1	Amber
M2-W23	American
M2-W04	Beech
M2-W33	Carmel
M2-W15	Espresso
M2-W08	Golden Anegre
M2-W30	Heritage
M2-W07	Light Anegre
M2-W21	Mahogany Satin
M2-N	Natural
M2-W32	Pacific
M2-W31	Retro
M2-AD	Sand

ALERT: These materials are current, however they are being considered for future obsolescence due to low volume.

Maple Veneer Finish

M2-W12	Naturally Walnut
--------	------------------

X99

Trim Colors

TR-F	Black
KR-V	Chrome*

Metallic Trim Colors

TR-LE	Silver
-------	--------

*Refer to price pages for chrome specification information and upcharge.

Zody

Base and Arm Uprights

Paint Colors

TR-F	Black
TR-RR	Rusty Red
TR-1M	Sable
TR-LE	Metallic Silver
TR-MC	Metallic Champagne
PM-P	Polished Aluminum
KR-V	Trivalent Chrome*

Trim Color

TR-F	Black
TR-E	Smoke
TR-RR	Rusty Red
TR-1M	Sable
TR-UFM	Snow

Wood Back Finish Color

VT-W04	Beech
--------	-------

*Trivalent chrome available on Zody guest chair only. Refer to price pages for specification information and upcharge.

Very Perforated and Tetro Back

Polymer Colors

TR-F	Black
TR-FL	Canvas
TR-FK	Cocoa
TR-CF	Coffee (Perforated Back only)
TR-7	Fog
TR-HR	Heron (Perforated Back only)
TR-KL	Kale (Perforated Back only)
TR-FJ	Slate
TR-FM	Snow
TR-FA	Tomato

Trim Color

TR-F	Black
TR-7	Fog

Base Colors - Painted

TR-F	Black
TR-MC	Metallic Champagne
TR-LE	Metallic Silver
PM-P	Polished Aluminum (conference chair only)
KR-V	Trivalent Chrome (wire stacker, side and seminar)

Base Colors - Plastic (conference chair only)

TR-F	Black
TR-7	Fog

Laminate /Color Legend

Grade A

Solid Color Laminates

H-AA	Putty
H-AK	Chalk
H-WL	Linen
H-3E	Smoke
H-3J	Graphite
H-3P	Platinum
H-34	Beige
H-62	Gray Tone
H-8J	Charcoal

Grade A

Wood Grain Laminate

H-AE	Maple
H-AM	Amber Cherry

Very Task

Plastic Trim Color

TR-F	Black
TR-7	Fog
TR-UFM	Snow (arm caps and adjustable levers default to Fog)

Plastic Base

TR-F	Black
TR-7	Fog

Aluminum Base

PM-P	Polished Aluminum
TR-F	Black
TR-MC	Metallic Champagne
TR-LE	Metallic Silver

Aluminum Frame Colors

TR-F	Black
TR-MC	Metallic Champagne
TR-LE	Metallic Silver
TR-FS	Snowfall
PM-P	Polished Aluminum

■ Available on RUSH.

Wood Seating — pages 285-287, 296-305, 328-333 The following matrix shows the standard finish offering for each seating product line. Because of the natural properties of wood, variations of grain pattern and finish color can be expected. Haworth carefully selects materials used in the manufacturing of products to promote consistent and acceptable color. Wood is susceptible to color change from exposure to UV rays. Haworth finishes include a UV stabilizer to reduce these effects. Natural finish on Maple is a clear coat only and will show all the characteristics of the wood.	Wood Seating					
	Composites	Forenze	Galerie	Hello	Prescott	ToDo
Maple						
Amber (M2-CA1)*	●	●	●	●	●	●
American (M2-W23)	●	●	●	●	●	●
Beech (M2-W04)*	●	●	●	●	●	●
Caramel (M2-W33)	●	●	●	●	●	●
Espresso (M2-W15)*	●	●	●	●	●	●
Golden Anegre (M2-W08)	●	●	●	●	●	●
Heritage (M2-W30)	●	●	●	●	●	●
Light Anegre (M2-W07)	●	●	●	●	●	●
Mahogany Satin (M2-W21)*	●	●	●	●	●	●
Natural (M2-N)	●	●	●	●	●	●
Pacific (M2-W32)	●	●	●	●	●	●
Retro (M2-W31)*	●	●	●	●	●	●
Sand (M2-AD)*	●	●	●	●	●	●

*Compatible wood finish color will complement wood caseworks finish color, not necessarily wood species characteristics.

◆ Available on RUSH. Refer to price pages for available models.

Wood Seating — pages 294-295 Because of the natural properties of wood, variations of grain pattern and finish color can be expected. Haworth carefully selects materials used in the manufacturing of products to promote consistent and acceptable color. Wood is susceptible to color change from exposure to UV rays. Haworth finishes include a UV stabilizer to reduce these effects.	Wood Seating
	Candor
Beech	
Amber (M3-CA1) ◆	●
American (M3-W23) ◆	●
Caramel (M3-W33)	●
Ebony (M3-RE)	●
Espresso (M3-W15) ◆	●
Golden Anegre (M3-W08)	●
Heritage (M3-W30)	●
Light Anegre (M3-W07)	●
Mahogany Satin (M3-W21) ◆	●
Natural (M3-W04)	●
Pacific (M3-W32)	●
Retro (M3-W31) ◆	●
Sand (M3-AD) ◆	●
Sorrel (M3-RC) ◆	●
Wenge (M3-RW) ◆	●

*Compatible wood finish color will complement wood caseworks finish color, not necessarily wood species characteristics.

◆ Available on RUSH. Refer to price pages for available models.

ALERT: These materials are current, however they are being considered for future obsolescence due to low volume.

Maple
Naturally Walnut M2-W12

Beech
Natural Walnut M3-W12

Fabric Pattern Usage

Haworth seating models are restricted to fabric patterns that meet applicability standards for tailoring. A dot in the matrix below indicates fabric acceptability on seating series or specific models listed. Fabrics are listed alphabetically by grades.

Grade: Pattern (Surface Code)	Series/ Model																									
	Accolade	Fern	Harbor Work Lounge	Hello	Improv H.E./S.E.	Improv Tag	Improv Desk Chair	Improv Leg-Base/Slec-Base Stool - Upholstered Back	Improv Leg-Base/Slec-Base Stool - Plastic Back	K100 Series (All Other Models)	Lively	LOOK	Monaco	Openest	Poppy	System 12	Tempo	ToDo	Very/Very Task	X99	Zody	Zody Guest	Wood (Candor)	Wood (Prescott)	Wood (All Other Models)	
Haworth Fabrics																										
A: Barque (7)	•	•	•	•	•	•	•	•	•	•	•	•	•	•	•	•	•	•	•	•	•	•	•	•	•	•
A: Blanket (4H)	•	•	•	•	•	•	•	•	•	•	•	•	•	•	•	•	•	•	•	•	•	•	•	•	•	•
A: Dottie (ME)	•	•	•	•	•	•	•	•	•	•	•	•	•	•	•	•	•	•	•	•	•	•	•	•	•	•
A: Gauge (1X)	•	•	•	•	•	•	•	•	•	•	•	•	•	•	•	•	•	•	•	•	•	•	•	•	•	•
A: Horizon (1N)	•	•	•	•	•	•	•	•	•	•	•	•	•	•	•	•	•	•	•	•	•	•	•	•	•	•
A: Morse (4J)	•	•	•	•	•	•	•	•	•	•	•	•	•	•	•	•	•	•	•	•	•	•	•	•	•	•
A: Pixel (2A)	•	•	•	•	•	•	•	•	•	•	•	•	•	•	•	•	•	•	•	•	•	•	•	•	•	•
A: Tellure (3A)	•	•	•	•	•	•	•	•	•	•	•	•	•	•	•	•	•	•	•	•	•	•	•	•	•	•
A: Twist (MM)	•	•	•	•	•	•	•	•	•	•	•	•	•	•	•	•	•	•	•	•	•	•	•	•	•	•
A: Wellington Faux Leather (XJ)	•	•	•	•	•	•	•	•	•	•	•	•	•	•	•	•	•	•	•	•	•	•	•	•	•	•
A: Zinger (NI)	•	•	•	•	•	•	•	•	•	•	•	•	•	•	•	•	•	•	•	•	•	•	•	•	•	•
B:																										
B: Align (4F)	•	•	•	•	•	•	•	•	•	•	•	•	•	•	•	•	•	•	•	•	•	•	•	•	•	•
B: Cocktail (1W)	•	•	•	•	•	•	•	•	•	•	•	•	•	•	•	•	•	•	•	•	•	•	•	•	•	•
B: Diagonale (4N)	•	•	•	•	•	•	•	•	•	•	•	•	•	•	•	•	•	•	•	•	•	•	•	•	•	•
B: English Tweed (4E)	•	•	•	•	•	•	•	•	•	•	•	•	•	•	•	•	•	•	•	•	•	•	•	•	•	•
B: Jewel (MN)	•	•	•	•	•	•	•	•	•	•	•	•	•	•	•	•	•	•	•	•	•	•	•	•	•	•
B: Leef (ML)	•	•	•	•	•	•	•	•	•	•	•	•	•	•	•	•	•	•	•	•	•	•	•	•	•	•
B: Ramie (4V)	•	•	•	•	•	•	•	•	•	•	•	•	•	•	•	•	•	•	•	•	•	•	•	•	•	•
B: Tech (MV)	•	•	•	•	•	•	•	•	•	•	•	•	•	•	•	•	•	•	•	•	•	•	•	•	•	•
C:																										
C: Small Arrow (4L)	•	•	•	•	•	•	•	•	•	•	•	•	•	•	•	•	•	•	•	•	•	•	•	•	•	•
C: King (LH)	•	•	•	•	•	•	•	•	•	•	•	•	•	•	•	•	•	•	•	•	•	•	•	•	•	•
C: Maya (LM)	•	•	•	•	•	•	•	•	•	•	•	•	•	•	•	•	•	•	•	•	•	•	•	•	•	•
D:																										
D: Big Arrow (4D)	•	•	•	•	•	•	•	•	•	•	•	•	•	•	•	•	•	•	•	•	•	•	•	•	•	•
D: Class (LE)	•	•	•	•	•	•	•	•	•	•	•	•	•	•	•	•	•	•	•	•	•	•	•	•	•	•
D: Cotswold (JB)	•	•	•	•	•	•	•	•	•	•	•	•	•	•	•	•	•	•	•	•	•	•	•	•	•	•
D: Notable (4K)	•	•	•	•	•	•	•	•	•	•	•	•	•	•	•	•	•	•	•	•	•	•	•	•	•	•
D: Tangram (LV)	•	•	•	•	•	•	•	•	•	•	•	•	•	•	•	•	•	•	•	•	•	•	•	•	•	•
E:																										
E: Brisa Faux Leather (XG)	•	•	•	•	•	•	•	•	•	•	•	•	•	•	•	•	•	•	•	•	•	•	•	•	•	•
Leathers																										
A: Plains Leather (XP)	•	•	•	•	•	•	•	•	•	•	•	•	•	•	•	•	•	•	•	•	•	•	•	•	•	•
B: Nature Leather (XE)	•	•	•	•	•	•	•	•	•	•	•	•	•	•	•	•	•	•	•	•	•	•	•	•	•	•



Haworth Fabrics/Color Legend

• The following fabrics are available on select Haworth upholstered seating models. Refer to the fabric pattern usage matrix, page 366.





• The  symbol denotes a fabric/color available on RUSH for all selected models.

(d) = Directional fabric

Fern Mesh 100% Polyester	
MB-BE	Beach
MB-CF	Cornflower
MB-LM	Loam
MB-MF	Moon Flower
MB-MU	Mulch
MB-MR	Mushroom
MB-PM	Peat Moss
MB-RR	River Rock
MB-SE	Sedum
MB-SL	Silver Leaf
MB-SU	Sunflower

Improv Tag Back Mesh 53%Elastomeric 47%Polyester	
S0-25	Amber
S0-22	Fire
S0-24	Lava  (Black)
S0-13	Leaf
S0-09	Silver 
S0-20	Sky

Lively Tension Back 100%Polyester	
3T-18	Black
3T-40	Chocolate
3T-54	Goose
3T-33	Miami
3T-6	Nickel
3T-46	Parrot
3T-50	Peel
3T-48	Sprout
3T-43	Tomato

Very Task Mesh 100%Polyester	
MS-F	Black 
MS-FK	Cocoa
MS-7	Fog 
MS-HR	Heron
MS-KL	Kale 
MS-FJ	Slate 
MS-FM	Snow





X99 Soft Mesh 86%Polyester 14%Polyamide	
M0-BE	Beach
M0-BL	Black
M0-CA	Camel
M0-FG	Fog
M0-ST	Storm

Zody Back Mesh 100%Polyester	
MA-9	Calm
MA-2	Comfort
MA-5	Gusto
MA-10	Hush
MA-11	Joy
MA-4	Relax 
MA-1	Support 
MA-12	Tranquil
MA-3	Wellness
MA-13	Zen

Fabric Grade: A (d) BARQUE 69%Polyester, 31%Recycled Polyester (31%REPREVE®)	
07-AH	Ash
07-AS	Aspen
07-BR	Birch
07-BW	Black Walnut
07-CN	Chestnut
07-GO	Golden Oak
07-RB	Redbud
07-WL	Willow









Fabric Grade: A (d) BLANKET 50%Post Consumer Recycled Polyester, 50%Virgin Polyester	
4H-BE	Beach
4H-BD	Bindle
4H-CL	Cloak
4H-FE	Feather
4H-FW	Firewheel
4H-FT	Fort
4H-GR	Grass
4H-HD	Hood
4H-MA	Mackinaw
4H-MT	Manta
4H-PN	Picnic
4H-PC	Poncho
4H-SW	Swag
4H-SP	Sweep
4H-TK	Tuck
4H-YA	Yawn



Fabric Grade: A (d) DOTTIE 89%Post Industrial Recycled Polyester, 11%Post Consumer Recycled Polyester	
ME-CA	Calico
ME-C	Chads
ME-DD	Dew Drops
ME-F	Flecks
ME-M	Morse
ME-P	Pip
ME-PD	Polka Dots
ME-R	Roulette
ME-T	Tabby
ME-Y	Yahtzee









Fabric Grade: A (d) HORIZON 100%Polyester	
1N-001	Beeline
1N-004	Birdseye
1N-003	Border 
1N-002	Compass 
1N-005	Panorama
1N-008	Skyline 
1N-006	Sweep
1N-007	Vista 

Fabric Grade: A (d) MORSE 100%Polyester	
4J-BP	Blip
4J-CA	Cable
4J-CD	Code
4J-DA	Dash
4J-DT	Dot
4J-MA	Marconi
4J-RA	Radio
4J-SS	S.O.S.
4J-SC	Scribe
4J-TA	Tap
4J-TE	Telegraph
4J-TR	Transmit
4J-WL	Wireless

Fabric Grade: A (d) PIXEL 51%Polyester, 32%Post Industrial Recycled Polyester, 17%Post Consumer Recycled Polyester	
2A-BY	Byte
2A-DC	Dice
2A-DT	Dot
2A-EA	Easel
2A-FT	Flaunt
2A-FC	Focus
2A-FL	Folio
2A-HM	Home
2A-IK	Ikona
2A-IM	Imagine
2A-ND	Node
2A-PM	Pomp
2A-RA	Raster
2A-SP	Spectral
2A-TA	Tab
2A-VE	Vertex

Fabric Grade: A TELLURE 100%Polyester	
3A-31	Aegean
3A-18	Black 
3A-45	Buff 
3A-20	Burgundy 
3A-53	Cayenne
3A-40	Chocolate
3A-49	Dove
3A-28	Dynamo 
3A-22	Galaxy 
3A-54	Goose
3A-35	Ivory
3A-23	Jodhpurs 
3A-33	Miami
3A-19	Navy 
3A-06	Nickel 
3A-34	Ocean
3A-46	Parrot
3A-50	Peel
3A-47	Pumpkin
3A-44	Roan
3A-51	Rust
3A-32	Sky
3A-37	Spring
3A-48	Sprout
3A-52	Sunset
3A-43	Tomato

Fabric Grade: A (d) TWIST 80%Post Consumer Recycled Polyester, 20%from Rayon Bamboo	
MM-AS	And Shout
MM-C	Coil 
MM-CS	Corkscrew 
MM-CU	Curl
MM-D	DNA
MM-I	Ivy
MM-P	Plot
MM-SW	Sidewinder
MM-S	Snail 
MM-SP	Spire
MM-WH	Whirlpool
MM-W	Winding

Fabric Grade: A WELLINGTON FAUX LEATHER 100%Polyurethane	
XJ-BL	Black 
XJ-BU	Buff 
XJ-EL	Elephant 
XJ-JA	Java 
XJ-PA	Pacific 
XJ-SA	Sage 
XJ-ST	Storm 
XJ-TA	Tangelo 
XJ-WI	Wine 

Fabric Grade: B ALIGN 95%Post Industrial Recycled Nylon, 5%Post Consumer Recycled Nylon	
4F-AR	Array
4F-FC	Focus
4F-LM	Limerick
4F-OR	Orient
4F-PK	Picket
4F-RT	Root
4F-SC	Scrimmage
4F-SP	Spring
4F-TA	Tangent
4F-TL	Tree Line
4F-WR	Wire

Fabric Grade: D (d) DIAGONALE 15.76%Nylon, 84.24%Polyester	
4N-AC	Across
4N-BA	Bias
4N-CH	Chevron
4N-CR	Crosscut
4N-DA	Diamond
4N-FE	Featherstitch
4N-HT	Half Timber
4N-KC	Kitty Corner
4N-MA	Matrix
4N-OB	Oblique
4N-SE	Serge
4N-ST	Slant
4N-SH	Slash
4N-SL	Slope
4N-WC	Whipcord
4N-ZZ	Zig Zag

Fabric Grade: B (d) ENGLISH TWEED 92%Polyester, 5%Post Industrial Recycled Polyester, 3%Post Consumer Recycled Polyester	
4E-BS	Biscuit
4E-BL	Blimey
4E-BN	Bonnet
4E-CT	Cottage
4E-DW	Doctor Who
4E-FX	Fox
4E-ML	My Lady
4E-XD	Oxford
4E-PE	Pipe
4E-SH	Sherry
4E-SN	Stilton
4E-ST	Stout
4E-TE	Tea
4E-TU	Tudor

Fabric Grade: B (d) JEWEL 77%Post Industrial Recycled Polyester, 23%Post Consumer Recycled Polyester	
MN-AM	Amber
MN-A	Aquamarine
MN-C	Citrine
MN-E	Emerald
MN-G	Garnet
MN-J	Jade
MN-M	Malachite
MN-R	Ruby
MN-S	Sapphire
MN-TE	Tiger's Eye

Fabric Grade: B (d) LEEF 49%Post Industrial Recycled Polyester 51%Post Consumer Recycled Polyester	
ML-A	Aspen
ML-B	Beet
ML-C	Coca
ML-CN	Coconut
ML-F	Fennel
ML-HE	Henna
ML-H	Hosta
ML-HY	Hydrangea
ML-M	Moonflower
ML-PE	Petunia
ML-P	Pumpkin
ML-S	Sunflower
ML-V	Violet

Haworth Fabrics/Color Legend

Fabric Grade: B (d)

RAMIE

62% Polyester,
25% Post Industrial
Recycled Polyester,
13% Post Consumer

Recycled Polyester

- 4V-B5 Basket
- 4V-BT Bast
- 4V-FX Foxtail
- 4V-GN Gunnie
- 4V-HY Hay
- 4V-MC Macrame
- 4V-ML Millet
- 4V-MB Mulberry
- 4V-RN Rain
- 4V-RD Reed
- 4V-RT Root
- 4V-SC Sack Cloth
- 4V-SS Sisal
- 4V-TH Thatch
- 4V-WT Water
- 4V-WD Weed

Fabric Grade: B (d)

TECH

100% Post Consumer

Recycled Polyester

- MV-AI A.I.
- MV-AN Anatomy
- MV-A Aviation
- MV-B Bionics
- MV-C Cosmos
- MV-D Disc
- MV-E Electric
- MV-F Forestry
- MV-L Logic
- MV-P Optics
- MV-RA Radio
- MV-R Rocket
- MV-SF Sci-Fi
- MV-S Skill
- MV-T Theory
- MV-Z Zoology

Fabric Grade: C (d)

KING

100% Polyester

- LH-BE Beige
- LH-DB Dark Blue
- LH-DG Dark Green
- LH-DM Dark Mustard
- LH-GD Gold
- LH-GL Light Green
- LH-LG Light Grey
- LH-MB Medium Blue
- LH-MG Medium Grey
- LH-RD Red
- LH-RG Orange
- LH-WG Warm Grey

Fabric Grade: C (d)

MAYA

100% Polyester

- LM-DB Dark Blue
- LM-GR Green
- LM-GY Golden Yellow
- LM-MG Medium Cool Grey
- LM-WG Medium Warm Grey
- LM-RG Orange

Fabric Grade: C (d)

SMALL ARROW

45.7% Virgin Nylon,
54.3% Post Industrial

Recycled Nylon

- 4L-AR Archer
- 4L-BA Barb
- 4L-CR Crossbow
- 4L-DA Dart
- 4L-FL Fletcher
- 4L-MA Mark
- 4L-NK Nock
- 4L-QU Quiver
- 4L-RE Reed
- 4L-RL Release
- 4L-ST Shaft
- 4L-SH Sharp
- 4L-TA Target

Fabric Grade: D (d)

BIG ARROW

100% Post Consumer
Recycled Polyester

- 4D-B5 Bisque
- 4D-BL Blue
- 4D-CN Cool Neutral
- 4D-DB Dark Blue
- 4D-GD Gold
- 4D-GR Green
- 4D-MG Medium Grey
- 4D-RE Red
- 4D-SA Salmon
- 4D-WN Warm Neutral

Fabric Grade: D (d)

CLASS

100% Polyester

- LE-DG Dark Grey
- LE-GM Green Multi
- LE-GR Green
- LE-LN Light Cool Neutral
- LE-MB Medium Blue
- LE-MN Medium Warm Neutral
- LE-RR Reddish Orange

Fabric Grade D

COTSWOLD

100% Wool

- JB-AN Anquilla
- JB-BR Bottleglass
- JB-CA Camp
- JB-DN Dandelion
- JB-ED Editor Blue
- JB-GS Goldfish
- JB-HA Heart
- JB-KE Kokanee
- JB-NE Nettle Bellflower
- JB-PL Pickeral Weed
- JB-SA Sand
- JB-SD Silver Dollar
- JB-SU Silverbush
- JB-SC Soft Charcoal
- JB-TR Tree
- JB-WE Wheaton

Fabric Grade: D (d)

NOTABLE

28.1% Virgin Nylon,
71.9% Post Industrial

Recycled Nylon

- 4K-BR Bravo
- 4K-CT Concert
- 4K-DR Dramatic
- 4K-EN Entertain
- 4K-MA Magic
- 4K-MT Matinee
- 4K-PA Pantomime
- 4K-PE Perform
- 4K-PL Play
- 4K-PT Plot
- 4K-PR Practice
- 4K-SC Script
- 4K-SH Show
- 4K-SK Skit
- 4K-ST Star
- 4K-TH Theatrical

Fabric Grade: D (d)

TANGRAM

57% Polyester,
28% Post Industrial

Recycled Polyester

- LV-CL Clue
- LV-EN Enigma
- LV-GU Guess
- LV-MA Maze
- LV-MU Muse
- LV-MT Mystery
- LV-MY Mystify
- LV-UT Outline
- LV-PE Perplex
- LV-PC Pieces
- LV-PU Puzzle
- LV-RD Riddle
- LV-SC Scrabble
- LV-SL Solve
- LV-TE Teaser
- LV-TR Trick

Fabric Grade: E (d)

BRISA FAUX LEATHER

100% Polyurethane face,
65% Polyester,

35% Rayon Backing

- XG-23 Apple Green
- XG-22 Ash
- XG-3 Aztec
- XG-28 Birch
- XG-12 Black Onxy
- XG-25 Blossom
- XG-5 Cambridge Blue
- XG-26 Coffee Bean
- XG-20 New Sand
- XG-18 Night Navy
- XG-21 Pompeian Red
- XG-1 Salsa
- XG-27 Shitake
- XG-24 Skyway
- XG-17 Sterling Blue
- XG-13 White

Leather Grade: A

PLAIN LEATHER

- XP-0KX Atlantis
- XP-0KC Black
- XP-0KY Brown
- XP-0KZ Smoke
- XP-0KW Storm

Leather Grade: B

NATURE LEATHER

- XE-0AS Bark
- XE-0AR Bittersweet
- XE-0AP Chocolate
- XE-0AJ Cream
- XE-0AH Flint
- XE-0AK Ink
- XE-0AX Oats
- XE-0AT Saddle
- XE-0AM Seal
- XE-0AL Shadow
- XE-0AW Truffle
- XE-0AN White

ALERT: These materials are current, however they are being considered for future obsolescence due to low volume.

Fabric Grade: A (d)

GAUGE

100% Recycled Polyester

- 1X-05 Depth
- 1X-04 Gas
- 1X-11 Narrow
- 1X-08 Pressure
- 1X-02 Rain
- 1X-12 Sea
- 1X-13 Standard
- 1X-10 Test
- 1X-03 Time
- 1X-09 Water
- 1X-06 Weather
- 1X-01 Wind
- 1X-07 Wire

Fabric Grade: A (d)

ZINGER

37% Recycled Polyester,
63% Polyester

(13% REPREVE)

- NI-2 BBQ
- NI-17 Beluga
- NI-10 Bluegill
- NI-8 Chips
- NI-11 Classic
- NI-16 Concord
- NI-13 Frog
- NI-15 Glade
- NI-9 Grain
- NI-12 Granny
- NI-4 Gravel
- NI-18 Kiwi
- NI-20 Mulberry
- NI-3 Onion
- NI-6 Pacific
- NI-1 Roan
- NI-21 Tar
- NI-7 Wagon
- NI-19 Wicker
- NI-5 Wolf

Fabric Grade: B (d)

COCKTAIL

100% Eco-Intelligent[®]
Polyester

MBDC Cradle to Cradle Gold

- 1W-12 Black Cow
- 1W-08 Blue Moon
- 1W-13 Boilermaker
- 1W-01 Bubbly
- 1W-03 Gibson
- 1W-04 Grasshopper
- 1W-07 Lounge
- 1W-16 Margarita
- 1W-10 Martini
- 1W-14 Mojito
- 1W-11 Old Fashion
- 1W-06 Pink Squirrel
- 1W-15 Sidecar
- 1W-09 Stinger
- 1W-02 Stout
- 1W-05 Swizzle

Haworth Fabrics/Color Legend

Seating COM Pattern Repeat Information

Haworth will calculate and order COM yardage as needed for seating; however, for bid/quote purposes, please refer to the COM yardage requirements listed by each chair model. These numbers are based on solid or very small scale (under 1" repeat) fabrics.

For fabrics with repeats listed below, additional yardage should be included in your calculations. The additional yardage allows for matching of patterns on the seating.

REPEAT SIZE	ADD ADDITIONAL YARDAGE TO YOUR CALCULATIONS
1"-4"	Add 5%
5"-7"	Add 10%
8"-14"	Add 20%
15"-19"	Add 25%
20"-27"	Add 30%
28"-36"	Add 50%

Haworth+

For information on the Haworth+ alliance program, including images and product availability, please refer to:
[Haworth.com > Surface Collection > Haworth+ Library](#)

Customer's Own Material (COM)

For general Customer's Own Material (COM) information including processes and forms, please refer to:
[Haworth.com > Surface Collection > Resources > COM](#)

For information on approved COM's, please refer to:
[Haworth.com > Surface Collection > COM Library](#)

COM Yardage Requirements

Procedure

To determine if a COM fabric has been approved for use on Haworth product, contact the Haworth Inquiry Center (1.800.426.8562), your local Haworth dealer, or go to Haworth.com/surfaces > COM Library. Haworth will calculate and order fabric unless instructed otherwise. If the dealer is to provide the fabric, they will calculate the yardage needed themselves.

If the fabric is approved, and the directional orientation (directional rightway, directional railroad, or non-directional) of the tested fabric has been confirmed, then refer to the appropriate price page for yardage requirements.

COM Fabric Requirements

The fabric yardage requirements for COMs given for each model are in lineal yards and are based on 54"(1372mm) usable fabric widths. Approximate yardage requirements are shown for each model within the price pages.

For fabrics already approved, with a COM order entry code assigned, Haworth will determine and purchase the yardage needed. If the fabric will be provided by the dealer, and the pattern has a large repeat or stripes, additional yardage will be needed; see the COM Yardage Requirements at the end of this price guide OR contact the COM Department for more information.

COL Leather Requirements

The leather requirements for COL (Customer's Own Leather) will vary depending on the hide size and are based on square footage. Haworth will determine and purchase the leather needed.

Find total number of linear yards required for the order. Add the appropriate percentage shown below to the total yardage to accommodate fabric flaws, wrinkles and other imperfections.

Up to 500 yards	Add 10%
501 to 1000 yards	Add 5%
More than 1000 yards	Add 3%

Directional Rightway:

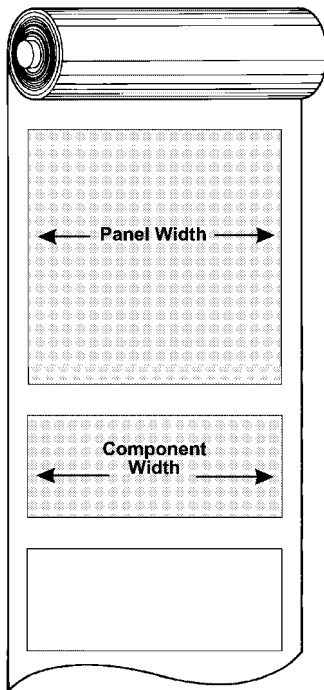
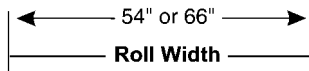

Directional Railroad:

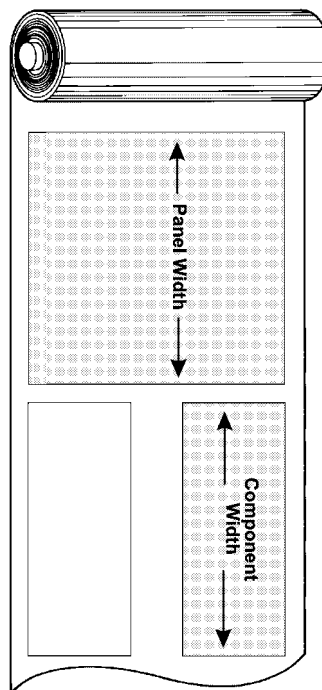
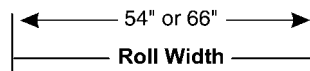

Non-Directional:

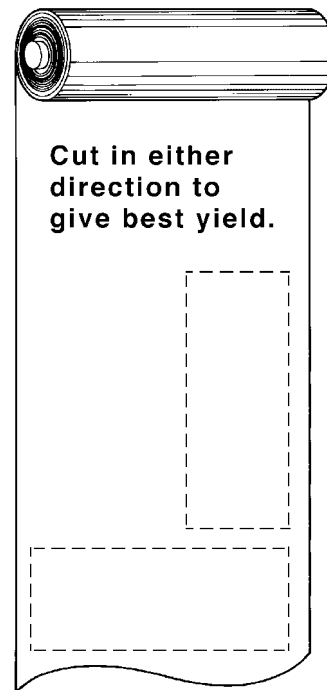
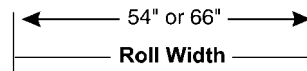

North American Terms of Sale

These Terms of Sale are part of a quotation, bid response, or other sales document issued by Haworth, Inc., Haworth, Ltd. ("Haworth").

These Terms of Sale do not cover products manufactured in North America shipping to non-North American countries nor do they cover products manufactured in non-North American countries shipping to North America. For those terms of sale, please contact Haworth's Global Trade and Compliance Department at 616.393.3000 or through Haworth.com.

A. Ordering Information

Haworth sells its products on the terms set forth in these standard Terms of Sale:

ORDERS MUST BE SUBMITTED IN WRITING OR ELECTRONICALLY (Lynx) AS REPRESENTED BY A VALID PURCHASE ORDER, WHICH INCLUDES PRODUCT TOTAL.

An order is not binding upon Haworth until Haworth issues an order acknowledgment to the customer (the "Customer"), which will include price information and an anticipated delivery date.

1. Order Changes/Cancellations

For Specials, Customer's Own Material (C.O.M.), finish matches, custom colors, custom products, Master lock and key orders, and RUSH orders, no changes or cancellations are allowed 24 hours after order placement. All other products require approval for changes or cancellations. A change/cancellation fee may apply. Contact Order Services for applicable charges.

Ship-to addresses changed within five (5) business days of delivery will incur fees to cover administrative costs due to re-labeling of product and/or reconsignment fees with the carrier.

Order cancellations are complete annulments of orders. Order changes are the deletion of line items or a change in size, color, quantity, ship-to address, or scope of work. There is no penalty for additions; however, any change may cause the order or the line items affected to be rescheduled. Order changes involving additional product and services which increase the value must be accompanied by an amended Purchase Order or other document as agreed.

ALL CHANGES MUST BE IN WRITING, REGARDLESS OF THE (DOLLAR) VALUE. CHANGES ARE NOT BINDING UPON HAWORTH UNTIL HAWORTH ISSUES AN ACKNOWLEDGMENT OF THE CHANGE.

2. C.O.M. (Customer's Own Material)

A Customer who requests a fabric, surface or finish material (C.O.M.) not in Haworth's standard finish offering must first confirm approval of or request new approval for the C.O.M.

Haworth will determine feasibility of the material for manufacturability. For a description of the procedure to submit C.O.M. samples, contact Haworth's Order Services department. For testing information, see the C.O.M. section of the catalog, or call Haworth Order Services.

If Haworth agrees to use the C.O.M., (1) Haworth shall have no responsibility for the condition, quality, value, performance, physical properties, or any other aspect of the C.O.M.; and (2) Haworth shall have no liability for any damages, injuries, or losses to the Customer or to any third party that shall be caused by any C.O.M., and the Customer shall hold Haworth harmless for all such liability.

3. Valid/Complete Purchase Order

The following information is required in order to process an order with Haworth:

a. Customer Information

- i. **Sold To:** Legal name, complete address (if Haworth is to bill the end user, provide end user Purchase Order made out to Haworth, Inc., Haworth, Ltd.) and phone and fax number.
- ii. **Ship To:** Legal name and address.
- iii. **Purchase Order Number:** From the party Haworth will be billing.
- iv. **Authorized Signature:** All Purchase Orders must be signed by a duly authorized representative if a signature line is present. Electronically transmitted Purchase Orders will be accepted without a signature if dealer billed and the dealer has an electronic purchase payment agreement on file.
- v. **Contact Name and Phone Number:** Person Haworth should contact with any questions regarding the order.
- vi. **Shipping Contact:** Name and phone number of person to be contacted regarding shipping and delivery matters.
- vii. **Tagging Instructions:** This information will appear on all documentation received from Haworth including: cartons, acknowledgments, and invoices.
- viii. **Price Agreement or National Sales Agreement Number**
- ix. **Product Total:** Net dollars.
- x. **Installation, Design, Project Management, and/or Service Fees**

b. Product Information

- i. **Quantity**
- ii. **Product Numbers**
- iii. **Colors**
- iv. **Specials:** Specify special part number for new special products.
- v. **Customer's Own Material:** Order entry code, manufacturer, pattern, and color.

- vi. **Approval Drawings:** An authorized signature by a duly authorized representative is required for shop drawings when applicable.
- vii. A deposit may be required for custom materials.

c. Order Confirmation

All orders will be acknowledged.

B. Pricing Policies

1. Terms of Payment

Terms of payment and credit limits will be established based on financial information. Standard payment terms on open credit are net thirty (30) days from invoice date. Advance payments or other payment security may be required by Haworth. The account balance must be at or below the credit limit and current at all times (no past-due balances). Haworth reserves the right to delay or cancel any delivery to a Customer whose Haworth account balance is over the credit limit and/or past due. For walls and floors a deposit will be required.

2. Terms of Credit

Customer hereby authorizes Haworth to obtain such credit reports, financial information or other information as Haworth may request, including, without limitation, credit information from any financial institutions or others having a business relationship with the Customer. Customer hereby authorizes any credit references to answer Haworth's inquiries and provide such credit information and documentation as Haworth may request.

The Customer hereby releases and holds Haworth harmless for any inconvenience whatsoever, caused by any temporary or permanent withdrawal or restriction of credit privileges hereunder, or the enforcement of any of the provisions contained in this paragraph.

3. Past-Due Charges

Past-due balances will be increased by a maximum of 1.5% per month, or 18% annually, without forfeit of Haworth's right to immediate payment.

4. Applicable Prices

The price of any product sold to Customer by Haworth will be based upon the North American Price List (Catalog).

Prices and discounts are subject to change without notice or approval. In the event of an adjustment to pricing, National Sales Agreement (NSA) Customers will be notified in advance according to the terms of the NSA.

Applicable prices and currency exchange rates are those in effect at the time of the RECEIPT of an ORDER; Haworth reserves the right to use the published pricing effective at the time of shipment, if the requested delivery date is more than 120 days after the order receipt date.

North American Terms of Sale

Haworth Flooring products are sold using the North American price list in US dollars. Currency exchange rates at the time of the transaction will be used to convert the USD amount into the alternate currency. Should the currency exchange rate between the USD and alternate currency change between a quote and the receipt of an order, the alternate currency amount will also change to equal the current, equivalent USD amount.

5. C.O.M. (Customer's Own Material) Charges

Refer to appropriate Customer's Own Material (C.O.M.) form for applicable surface material charges.

6. Taxes

Haworth prices do not include customs duty, sales, use, value added or similar taxes. Any federal, state/provincial or other taxes or assessments based upon the sale or delivery of products or services sold applicable to the customer at present or later imposed by federal, state/provincial or municipal agencies, shall be added and paid by the customer. Customer is responsible for all such taxes.

NOTE: For all countries a valid sales tax exemption certificate must be approved by and on file with Haworth prior to product shipment. Otherwise, sales tax will be due and payable to Haworth when such tax is invoiced to Customer.

7. Services

If, as a result of Customer request, the Haworth dealer or Haworth subsidiary provides planning/design services, storage, project management, special handling, set-up, installation and/or other services, the Customer will be charged at the local Haworth dealer/subsidiary's prevailing rates.

8. Termination by Haworth

Haworth may immediately terminate an order upon written notice in the event bankruptcy or insolvency proceedings are instituted by or against the Customer, or the Customer is adjudicated as bankrupt, becomes insolvent, makes an assignment for the benefit of creditors, or proposes or makes any arrangements for the liquidation of its debts, or a receiver or receiver and manager is appointed with respect to all or any part of the assets of the Customer.

C. Shipping and Delivery

Haworth will have the right to determine the method of shipment and routing of product.

This section does not apply to any of Haworth's Flooring products. All Haworth Flooring products are sold freight collect.

If, for any reason, a delivery has to be made to an intermediate location (i.e. a location other than the "Ship To" location noted on the order or ultimate end user location), all handling and re-delivery costs incurred would be at the Customer's expense.

1. U.S.A. - Contiguous

All deliveries will be CPT (Carriage Paid To) (ICC Incoterms 2010) Haworth's manufacturing facilities or distribution centers. Freight charges will be prepaid by Haworth on all orders to locations within the continental United States. Customer bears all risk of loss or damage to the goods when they are placed on Haworth's means of transport.

2. U.S.A. - Non-contiguous (Alaska, Hawaii and Puerto Rico)

All deliveries will be CIF (Cost, Insurance and Freight) (ICC Incoterms 2010). Haworth's catalog prices include ocean freight and insurance to the port of the final destination. Haworth has the right to determine the carrier, method of shipment and routing. Haworth will contract with the insurer and provide minimal insurance coverage (CIF @ 110%) made payable to the Customer. Customer is responsible to obtain greater insurance if so desired.

Customer bears all risk of loss or damage to the goods when the goods are effectively at the disposal of the Customer on board the vessel at the named port of destination. Proof of delivery is a clean on board bill of lading. Customer will be responsible for all on-carriage from the receiving port to the final destination.

3. Canada

All deliveries will be DDP (Delivered Duty Paid) (ICC Incoterms 2010). Haworth's catalog prices include delivery to Customer's named place, not unloaded from any arriving means of transport. Customer bears all risk of loss or damage to the goods when they are delivered to the Customer's named facility not unloaded. Haworth will assume responsibility to file all freight claims with the carrier for any loss/damage which may occur while product is in transit, and will promptly repair or replace any damaged or lost product. Haworth requires the Customer to report all freight damage and/or loss to both the carrier and to Haworth.

NOTE: Under all delivery terms (U.S.A. and Canada), any additional expense resulting from Customer's request for expedited transportation, special services, packaging, handling, routing, and/or shipping method will be billed to Customer.

4. Mexico

All deliveries will be DAP (Delivered to Place) (ICC Incoterms 2010). Haworth's catalog prices include freight charges for normal surface transportation to a United States point of exportation within the 48

contiguous states. Haworth has the right to determine the carrier, method of shipment and routing.

Customer bears all risk of loss or damage to the goods when the goods are delivered to the named United States point of exportation. Haworth will provide customs clearance facilitation and arrangement of local delivery through an Authorized Dealer in Mexico, on a separately negotiated basis. Otherwise the Customer will be responsible for all customs clearance formalities and on-carriage from the United States point of exportation to the final destination in Mexico.

5. Delivery Dates and Delay

If Haworth cannot deliver products as scheduled due to causes beyond its reasonable control (such as casualty, labor disputes, or accident; inability to obtain necessary labor, material or transportation; or changes requested by the Customer), the delivery date will be extended to compensate for the delay as determined by Haworth.

6. Delivery Shortages and Damage

Product shortages and damage must be noted on delivery receipts at the time of delivery and reported to the carrier for correction.

Claims against Haworth for shortages, errors, or damage must be made within ten (10) days of the date of delivery or the Customer waives the right to make such a claim. Signed Bill of Ladings or Delivery Receipt must be sent in with claims. See the Haworth/Haworth Dealers Roles and Responsibilities document for further details.

7. Storage

Haworth may transfer product to storage at the Customer's risk and expense if the Customer is unable or unwilling to take delivery of product as originally scheduled. Upon such transfer to storage, the Customer assumes risk of loss. Haworth will invoice the Customer for storage fees and the Customer will make payments in accordance with Haworth's standard payment terms.

North American Terms of Sale

D. General Terms

1. Governing Law

For products purchased for delivery in the U.S. pursuant hereto, this Agreement shall be governed by and construed according to the laws of the State of Michigan. Where Products are purchased for delivery in Canada pursuant hereto, this Agreement shall be governed by and construed according to the laws of the Province of Alberta. In either case, the parties attorn to the exclusive jurisdiction of the courts of Michigan and Alberta, respectively for the purpose of hearing any disputes arising under this Agreement or with respect to any Products sold pursuant hereto, and agree that the provisions of the United Nations Convention on Contracts for the International Sale of Goods and any other provision or law which would have the effect of applying the laws of any jurisdiction other than Michigan or Alberta, as the case may be, shall be excluded.

2. Force Majeure

In the event that the performance of Customer or Haworth or its participating dealer assignee(s) would be prevented, restricted, interfered with or rendered commercially impracticable by reason of Force Majeure, then upon the giving of notice to the other parties, the party affected by the Force Majeure shall be excused from performing hereunder until the Force Majeure no longer prevents, restricts, interferes with, or renders such performance commercially impracticable.

"Force Majeure" shall mean: fire, explosion, breakdown of plant, epidemic, hailstorm, snow/ice storms en route, hurricane, tornado, cyclone, flood or power failure; war, revolution, civil or military disturbances, acts of public enemies, acts of terrorism, blockade or embargo; any law, order, proclamation, regulation, ordinance, demand or requirement of any applicable governmental authority or any subdivision, authority, or representative of any such government; labor difficulties, including without limitation, strikes, slowdowns, picketing or boycotts; or difficulties beyond Haworth's reasonable control in obtaining necessary raw materials, labor, fuels and electric power, components or facilities, and any other circumstances beyond the control of the party affected.

3. Delays by Customer

Where Haworth has not received adequate site dimensions, Product specifications, shipping information, installation particulars or other information required by Haworth to permit the efficient manufacture of any Products, or where site conditions are not in accordance with the Installation Requirements set forth, or are not otherwise suitable to permit effective and efficient installation, the manufacture and/or delivery of Products may be delayed, and such event shall constitute a delay by the Customer. When manufacture, delivery or installation is delayed by the Customer or at the Customer's request: (i) Haworth may, at its option, present the invoice for the full price of the Products to the Customer as then due and payable; (ii) the Customer shall pay to

Haworth all reasonable storage, handling and other reasonable incidental expenses incurred by Haworth in connection with such delay; and (iii) the Customer shall bear all risk of loss or damage to the Products being held by Haworth for the Customer.

4. Use and Installation of Products

Haworth recommends that its products be installed by certified, qualified and approved installers according to Haworth's written installation procedures. The Customer agrees to use Haworth products properly; not to remove or alter safety devices, warnings, or operation instructions placed on products by Haworth, and to instruct employees as to the proper care and use of the products according to printed instructions.

5. Warranty

Haworth's standard North American Warranty will apply as appropriate. All product line warranty specifics are available in each catalog or upon request.

E. Services

Service requests for design, installation, relocation, storage, etc. are handled by the local Haworth dealer on a separately negotiated basis. Contact the local Haworth dealer, affiliate or area sales office for more details.

Scope of Work - Design

Customer acknowledges that the Products to be manufactured or procured by Haworth in connection with the order are or may be custom manufactured for the Customer and that Haworth may be required to perform extensive work in relation to the design and specification of such Products. Where Customer requests that Haworth create as-built drawings or make more than two material revisions to any particular Product design or specification, Customer agrees that Haworth shall be entitled to invoice Customer with respect to such additional work on the basis of Haworth's then prevailing rates for related design and specification services.

Installation Requirements

Where installation services are to be provided by Haworth, its authorized dealer or subcontractor, a document will be provided setting forth the scope of installation work to be performed (the "Scope of Work") and the price to be charged therefore. Unless otherwise specified in the scope of work, Haworth's installation services are limited to products sold by Haworth with the exception of lighting, under floor electrical and data.

General Conditions

(a) Sufficient time shall be allocated by the Customer following delivery of Products and prior to Customer's occupation of the premises to allow the installation of all Products during conventional working hours, Monday through Friday, 7:30 a.m. to 4:30 p.m. Where sufficient time is not allocated and Haworth is required or requested to perform installation work outside of such times, overtime charges shall be charged at Haworth's then prevailing rates. (b) Haworth shall be given free and exclusive access to; (i) a loading dock within 150' of the freight elevator or hoist, which loading dock shall be of sufficient size to enable full-size tractor-trailer deliveries to the premises (where required by Haworth); (ii) a freight elevator or hoist of sufficient size and capacity to allow the efficient movement of the Products; (iii) an unobstructed and safe pathway to the area where Products are to be stored or staged; (iv) a secure storage / staging area; (v) convenient trash facilities; (vi) adequate lighting; (vii) a work site that complies with applicable health and safety legislation. Where such areas and facilities are not available, Haworth shall be entitled to bill Customer for all amounts incurred by Haworth for double-handling, product movement, lifting, hoisting, trash removal and any other resulting charges. (c) The installation site shall be free and clear of existing furniture, debris, or other obstructions (including construction in progress) and shall otherwise be in the reasonable opinion of Haworth ready for installation of the Products. Any building where Products are to be installed shall be fully closed in, dry and protected from the natural elements, with temperatures between 40°F and 90°F (4°C and 32°C) and relative humidity not to exceed 70% at all times including receipt of products, during and after installation and shall be adequately heated and/or air-conditioned. Where unusual site conditions exist which impede or prevent the normal installation of any Products, applicable extra charges shall apply at prevailing rates. (d) Haworth's installation pricing is based upon the installation occurring as one continuous delivery and installation project. Phased installation pricing shall be provided by Haworth on a case by case basis. (e) Electrical hardwiring, plumbing and mechanical work is not included and shall be the responsibility of the Customer. (f) Except as may be otherwise specifically indicated, installation pricing does not apply to projects where union labor is required. Where Haworth has provided installation pricing on the basis that non-union labor be utilized, and where Haworth is required to use union labor or it otherwise becomes impractical to use non-union labor, or where Haworth is required by law to use prevailing wages, Haworth shall be entitled to charge the Customer for any cost differential between the anticipated cost of non-union labor and the actual cost of utilizing union or prevailing wage labor. (g) Haworth shall not be responsible for obtaining permits.

North American Terms of Sale

Project / Site Conditions

Lateral load bracing is not included in the scope of Haworth's work and shall not be performed by Haworth. In areas where flooring Products are to be installed by Haworth overhead construction must be completed prior to the commencement of such work to avoid damage to the panels and finishes. The existing subfloor must be smooth, mopped clean, free of moisture, dust, dirt and debris. Once installed, the access floor must be maintained in the same manner. The subfloor must have a maximum vertical elevation deviation of 0.375" (10mm) over a horizontal span of 10'-0" (3m), and without discontinuities in floor slope. For greater certainty, the scope of Haworth's installation work in such areas shall not be deemed to include any work required to level such subfloor, remove protrusions, remove pre-existing floor coverings or adhesives, or any other work which is required to remedy any conditions which may impede the efficient installation of flooring. Except as may be otherwise specifically indicated in the order, installation pricing for flooring Products and the Scope of Work in relation thereto shall not include any work required to remove and replace floor panels following their initial installation to provide tradespersons or others with access to the underpanel cable management cavity. In areas where movable walls are to be installed, all flooring (including carpeting) and ceiling components (including dropped ceiling grid components) shall be fully complete and ready for the installation of the movable wall products. Further, the existing floor (or other surface on which the movable wall panels are to be installed) shall have a maximum vertical deviation of 1.25" (30mm) and the dropped ceiling grid shall have a maximum vertical deviation of 0.375" (10mm) from the specifications to which such movable wall panels were designed and manufactured (collectively the "Permitted Tolerances"), and shall otherwise comply with any site condition assumptions made known to Haworth prior to the manufacture of such Products (the "Site Assumptions"). Where the Permitted Tolerances or Site Assumptions are not strictly adhered to or met, additional charges may be incurred in connection with site remediation and/or the modification or remanufacture of affected movable wall products, together with all resulting shipping and labor charges at Haworth's then prevailing rates for such Products and services.

Installation Change Orders

Where Customer requests work to be performed or materials to be provided which are not contemplated in the Scope of Work, or Customer otherwise requests Products or services not contemplated in the order (collectively "Extras"), prior to providing such Extras Haworth reserves the right to require the Customer to provide and sign a written Purchase Order or Change Order acceptable to Haworth describing the Extras and the amounts to be charged therefore, and the Customer agrees to pay such charges.

Entire Agreement

The order and this Agreement (including applicable Schedules) constitute the sole agreement between

the parties and supercede any prior understanding or written or oral agreements between the parties (excluding National Sales Agreements). No waiver of any of the provisions of these Standard Terms and Conditions shall be binding on Haworth unless expressly agreed in writing.

Revision Date: June 1, 2015

Index

Products are listed alphabetically in this index by alpha-numeric prefix/suffix codes.

Product Code	Product Description	Page
1200-2100	System 12 – High-Density Stacking Chair – Without Arms	290
1201-2110	System 12 – High-Density Stacking Chair – With Arms	290
180-0028	Galerie Collection – Lounge Seating – Lounge Chair	348
180-0053	Galerie Collection – Lounge Seating – Settee	348
180-0075	Galerie Collection – Lounge Seating – Sofa	348
2006-0031	Tuxedo Series – Lounge Seating – Lounge Chair	351
2006-0056	Tuxedo Series – Lounge Seating – Settee	351
2006-0072	Tuxedo Series – Lounge Seating – Sofa	351
4043-00	Composites Seating Series – Guest/Occasional Seating – Stacking Chair, Arc Arm, Upholstered Back	300
4045-00	Composites Seating Series – Guest/Occasional Seating – Arc Arm, Upholstered Back	296
4046-00	Composites Seating Series – Guest/Occasional Seating – Repose Arm, Upholstered Back	297
4047-00	Composites Seating Series – Guest/Occasional Seating – Cascade Arm, Upholstered Back	298
4048-00	Composites Seating Series – Guest/Occasional Seating – Contour Arm, Upholstered Back	299
4049-00	Composites Seating Series – Occasional Seating – Stool, Armless, Upholstered Back	301
4080-00	Galerie Collection – Lounge Seating – Leg-Base Chair, Fully Upholstered	348
4145-00	Composites Seating Series – Guest/Occasional Seating – Arc Arm, Circle Back	296
4146-00	Composites Seating Series – Guest/Occasional Seating – Repose Arm, Hourglass Back	297
4147-00	Composites Seating Series – Guest/Occasional Seating – Cascade Arm, Circle Back	298
4148-00	Composites Seating Series – Guest/Occasional Seating – Contour Arm, Hourglass Back	299
4243-00	Composites Seating Series – Guest/Occasional Seating – Stacking Chair, Arc Arm, Slat Back	300
4245-00	Composites Seating Series – Guest/Occasional Seating – Arc Arm, Slat Back	296
4246-00	Composites Seating Series – Guest/Occasional Seating – Repose Arm, Cross Back	297
4247-00	Composites Seating Series – Guest/Occasional Seating – Cascade Arm, Slat Back	298
4248-00	Composites Seating Series – Guest/Occasional Seating – Contour Arm, Cross Back	299
4249-00	Composites Seating Series – Occasional Seating – Stool, Armless, Slat Back	301
4851-0011	Hello Seating – Guest Seating – Fixed Arm, Metal Legs	324
4851-0011-W	Hello Seating – Guest Seating – Fixed Arm, Wood Legs	323
4851-0012	Hello Seating – Guest Seating – Fixed Arm, Metal Legs	324
4851-0012-W	Hello Seating – Guest Seating – Fixed Arm, Wood Legs	323
4851-0013	Hello Seating – Guest Seating – Fixed Arm, Metal Legs	324
4851-0013-W	Hello Seating – Guest Seating – Fixed Arm, Wood Legs	323
4852-0011	Hello Seating – Stools – Fixed Arm, Metal Legs	325
4852-0012	Hello Seating – Stools – Fixed Arm, Metal Legs	325
4852-0013	Hello Seating – Stools – Fixed Arm, Metal Legs	325
4854-0011	Hello Seating – Lounge with Legs – Standard Arm	320
4854-0012	Hello Seating – Lounge with Legs –	320
4855-0043	Hello Seating – Mobile Lounge – Standard Arm	321
4855-0043-GSX	Hello Seating – Mobile Lounge –	321
4855-0043-S	Hello Seating – Mobile Lounge –	321
4856-0043	Hello Seating – – Mini-mobile	322
4856-0043-A	Hello Seating – – Mini-mobile	322
4858-0001	Hello Seating – – Accessories	322
4858-0002	Hello Seating – – Accessories	322
5210-32	Prescott Series – Swivel Seating – High-Back Chair, Fully-Upholstered Arm with Wood Arm Trim/ Polypropylene Base	285
5210-32	Prescott Series – Swivel Seating – High-Back Chair, Fully-Upholstered Arm with Wood Arm Trim/Wood Base	286
5215-32	Prescott Series – Swivel Seating – High-Back Chair, Fully-Upholstered Arm/Polypropylene Base	285
5215-32	Prescott Series – Swivel Seating – High-Back Chair, Fully-Upholstered Arm/Wood Base	285
5220-32	Prescott Series – Swivel Seating – Mid-Back Chair, Fully-Upholstered Arm with Wood Arm Trim/ Polypropylene Base	286

Index

Product Code	Product Description	Page
5220-32	Prescott Series – Swivel Seating – Mid-Back Chair, Fully-Upholstered Arm with Wood Arm Trim/Wood Base	287
5225-32	Prescott Series – Swivel Seating – Mid-Back Chair, Fully-Upholstered Arm/Polypropylene Base	286
5225-32	Prescott Series – Swivel Seating – Mid-Back Chair, Fully-Upholstered Arm/Wood Base	287
5818-1816	Galerie Collection – Occasional Tables – 5800 Series Tables	349
5818-1822	Galerie Collection – Occasional Tables – 5800 Series Tables	349
5826-2616	Galerie Collection – Occasional Tables – 5800 Series Tables	349
5826-2622	Galerie Collection – Occasional Tables – 5800 Series Tables	349
5918-1816	Galerie Collection – Occasional Tables – 5900 Series Tables	350
5918-1822	Galerie Collection – Occasional Tables – 5900 Series Tables	350
5926-2616	Galerie Collection – Occasional Tables – 5900 Series Tables	350
5926-2622	Galerie Collection – Occasional Tables – 5900 Series Tables	350
8181-00	Forenze Seating – Guest/Occasional Seating – Serpentine Arm, Upholstered Back	302
8182-00	Forenze Seating – Guest/Occasional Seating – Curve Arm, Upholstered Back	303
8183-00	Forenze Seating – Guest/Occasional Seating – Scroll Arm, Upholstered Back	304
8184-00	Forenze Seating – Guest/Occasional Seating – Cabriole Arm, Upholstered Back	305
8281-00	Forenze Seating – Guest/Occasional Seating – Serpentine Arm, Wave Back	302
8282-00	Forenze Seating – Guest/Occasional Seating – Curve Arm, Wave Back	303
8381-00	Forenze Seating – Guest/Occasional Seating – Serpentine Arm, Ellipse Back	302
8382-00	Forenze Seating – Guest/Occasional Seating – Curve Arm, Ellipse Back	303
8483-00	Forenze Seating – Guest/Occasional Seating – Scroll Arm, Slat Back	304
8484-00	Forenze Seating – Guest/Occasional Seating – Cabriole Arm, Slat Back	305
8583-00	Forenze Seating – Guest/Occasional Seating – Scroll Arm, Star Back	304
8584-00	Forenze Seating – Guest/Occasional Seating – Cabriole Arm, Star Back	305
A802-3110	Accolade Seating – Sled-Base Side Chair	273
A831-1042	Accolade Seating – Mid-Back Chair without Arms – Synchronized-Tilt	272
A831-1142	Accolade Seating – Mid-Back Chair with Cantilever Arms – Synchronized-Tilt	271
A871-1042	Accolade Seating – High-Back Chair without Arms – Synchronized-Tilt	270
A871-1142	Accolade Seating – High-Back Chair with Cantilever Arms – Synchronized-Tilt	269
BOOK-12	System 12 – Accessories – Book Rack	291
CART-12	System 12 – Accessories – Stacking Cart	291
D811-2240	Monaco – Large High-Back Chair with Open Arms	277
D811-2640	Monaco – Large High-Back Chair with Enclosed Arms	278
D821-2240	Monaco – Medium High-Back Chair with Open Arms	279
D821-2640	Monaco – Medium High-Back Chair with Enclosed Arms	280
D831-2240	Monaco – Large Mid-Back Chair with Open Arms	281
D831-2640	Monaco – Large Mid-Back Chair with Enclosed Arms	282
D841-2240	Monaco – Medium Mid-Back Chair with Open Arms	283
D841-2640	Monaco – Medium Mid-Back Chair with Enclosed Arms	284
F235-2042	Improv Tag – Mesh Back without Arms	234
F235-2442	Improv Tag – Mesh Back with Fixed-Height Task Arms	235
F235-2742	Improv Tag – Mesh Back with Height-Adjustable Task Arms	236
F235-2W42	Improv Tag – Mesh Back with Height- and Width-Adjustable 3-D Arms	237
K120-2210	K120 Series – Guest/Occasional Seating – Sled Base with Arms Open-Frame Base	354
K153-10	K100 Series – Public Seating – Ten Seat Beam	359
K153-2	K100 Series – Public Seating – Two Seat Beam	358
K153-3	K100 Series – Public Seating – Three Seat Beam	358
K153-4	K100 Series – Public Seating – Four Seat Beam	358
K153-45	K100 Series – Public Seating – 45° Corner Beam	359
K153-5	K100 Series – Public Seating – Five Seat Beam	358
K153-6	K100 Series – Public Seating – Six Seat Beam	358

Index

Product Code	Product Description	Page
K153-7	K100 Series – Public Seating – Seven Seat Beam	358
K153-8	K100 Series – Public Seating – Eight Seat Beam	358
K153-9	K100 Series – Public Seating – Nine Seat Beam	359
K156-220	K100 Series – Public Seating — Beam Mounted Components – Armless Seat	356
K156-221	K100 Series – Public Seating — Beam Mounted Components – Seat with Arms	356
KGNG-150	K120 Series – Guest/Occasional Seating – Ganging Clip	354
KL01-7200	Tempo Series – Lounge Seating – Open Frame Lounge — One Seat	334
KL01-7210	Tempo Series – Lounge Seating – Open Frame Lounge — One Seat	334
KL02-7200	Tempo Series – Lounge Seating – Open Frame Lounge — Two Seats	334
KL02-7210	Tempo Series – Lounge Seating – Open Frame Lounge — Two Seats	334
KL01-7200	Tempo Series – Lounge Seating – Open Frame Lounge — One Seat	347
KL01-7220	Tempo Series – Lounge Seating –	347
KL02-7200-N	Tempo Series – Modular Add-on Seating – Add-on Seat without Arm	344
KL02-7210-R	Tempo Series – Modular Add-on Seating – Add-on Seat with Right Arm	344
KL03-7200	Tempo Series – Modular Add-on Tables – Radius Corner Table	346
KL03-7210	Tempo Series – Modular Add-on Tables – Square Corner Table	346
KL04-7200-L	Tempo Series – Modular Starter Tables – Left End Table	345
KL04-7210-R	Tempo Series – Modular Starter Tables – Right End Table	345
KL05-7200	Tempo Series – Modular Add-on Tables – In-Line Table	346
KL06-7200-N	Tempo Series – Modular Starter Seating – Starter Seat without Arms	343
KL06-7210-B	Tempo Series – Modular Starter Seating – Starter Seat with Right and Left Arms	342
KL06-7210-L	Tempo Series – Modular Starter Seating – Starter Seat with Left Arm	342
KL06-7210-R	Tempo Series – Modular Starter Seating – Starter Seat with Right Arm	342
KL07-7210	Tempo Series – Preconfigured Seating – Seat, Seat	336
KL08-7210	Tempo Series – Preconfigured Seating – Seat, Seat, Seat	336
KL09-7210	Tempo Series – Preconfigured Seating – Seat, Seat, Seat, Seat	338
KL10-7210	Tempo Series – Preconfigured Seating – Seat, Table, Seat	336
KL11-7210	Tempo Series – Preconfigured Seating – Table, Seat, Seat	337
KL12-7210	Tempo Series – Preconfigured Seating – Seat, Seat, Table	337
KL13-7210	Tempo Series – Preconfigured Seating – Seat, Table, Seat, Seat	338
KL14-7210	Tempo Series – Preconfigured Seating – Seat, Seat, Table, Seat	338
KL15-7210	Tempo Series – Preconfigured Seating – Table, Seat, Seat, Seat	339
KL16-7210	Tempo Series – Preconfigured Seating – Seat, Seat, Seat, Table	339
KL17-3030	Tempo Series – Lounge Seating and Tables – Coffee Table	335
KL18-1818	Tempo Series – Lounge Seating and Tables – End Table	335
KL19-7220	Tempo Series – Lounge Seating and Tables – Fully Upholstered	335
KL20-7220	Tempo Series – Lounge Seating and Tables –	335
KL21-7220	Tempo Series – Lounge Seating and Tables –	335
KL22-2929	K100 Series – Public Seating – Corner Connecting Table, Configuration #1	357
KL23-2929	K100 Series – Public Seating – Corner Connecting Table, Configuration #2	357
KL24-2929	K100 Series – Public Seating – Corner Connecting Table, Configuration #3	357
KL25-2929	K100 Series – Public Seating – Corner Connecting Table, Configuration #4	357
KL26-2124	K100 Series – Public Seating — Beam Mounted Components – In-Line Table	356
KL27-5110	Scamps Series – Children’s Furniture – Chair with Arms	360
KL28-24	Scamps Series – Children’s Furniture – Round Table	360
M211-1042	Improv Series – Mid-Back Chair without Arms	191
M211-1142	Improv Series – Mid-Back Chair with Arms	189
M211-1742	Improv Series – Mid-Back Chair with Height Adjustable Arms	190
M221-1042	Improv Series – High-Back Chair without Arms	188
M221-1142	Improv Series – High-Back Chair with Arms	186

Index

Product Code	Product Description	Page
M221-1742	Improv Series – High-Back Chair with Height Adjustable Arms	187
M231-1042	Improv Series – Improv H.E. Mid-Back Chair without Arms	215
M231-1442	Improv Series – Improv H.E. Mid-Back Chair with Task Arms	208
M231-1742	Improv Series – Improv H.E. Mid-Back Chair with Height Adjustable Task Arms	210
M231-1H42	Improv Series – Improv H.E. Mid-Back Chair with Flipper Arms	212
M231-1W42	Improv Series – Improv H.E. Mid-Back Chair with Height and Width Adjustable 3-D Arms	214
M235-3042	Improv Series – Improv S.E. Mesh Back Chair without Arms	224
M235-3442	Improv Series – Improv S.E. Mesh-Back Chair with Task Arms	226
M235-3742	Improv Series – Improv S.E. Mesh-Back Chair with Height Adjustable Task Arms	228
M235-3H42	Improv Series – Improv S.E. Mesh-Back Chair with Flipper Arms	230
M235-3W42	Improv Series – Improv S.E. Mesh-Back Chair with Height and Width Adjustable 3-D Arms	232
M251-1042	Improv Series – Improv H.E. High-Back Chair without Arms	207
M251-1442	Improv Series – Improv H.E. High-Back Chair with Task Arms	200
M251-1742	Improv Series – Improv H.E. High-Back Chair with Height Adjustable Task Arms	202
M251-1H42	Improv Series – Improv H.E. High-Back Chair with Flipper Arms	204
M251-1W42	Improv Series – Improv H.E. High-Back Chair with Height and Width Adjustable 3-D Arms	206
M271-1042	Improv Series – Improv H.E. XL Chair without Arms	199
M271-1442	Improv Series – Improv H.E. XL Chair with Task Arms	192
M271-1742	Improv Series – Improv H.E. XL Chair with Height Adjustable Task Arms	194
M271-1H42	Improv Series – Improv H.E. XL Chair with Flipper Arms	196
M2E1-1042	Improv Series – Improv H.E. Stool without Arms	223
M2E1-1442	Improv Series – Improv H.E. Stool with Task Arms	216
M2E1-1742	Improv Series – Improv H.E. Stool with Height Adjustable Task Arms	218
M2E1-1H42	Improv Series – Improv H.E. Stool with Flipper Arms	220
M2E1-1W42	Improv Series – Improv H.E. Stool with Height and Width Adjustable 3-D Arms	222
M600-2100	Improv Series – Leg-Base Stacking Chairs – Without Arms	239
M600-2110	Improv Series – Leg-Base Stacking Chairs – With Arms	238
M600-2190	Improv Series – Leg-Base Stacking Chair with Tablet Arm – With Tablet Arm	240
M600-2300	Improv Series – Leg-Base Stacking Chairs – Without Arms	239
M600-2310	Improv Series – Leg-Base Stacking Chairs – With Arms	238
M600-8100	Improv Series – Stools – Without Arms	244
M600-8110	Improv Series – Stools – With Arms	244
M600-8300	Improv Series – Stools – Without Arms	244
M600-8310	Improv Series – Stools – With Arms	244
M601-2100	Improv Series – Sled-Base Chairs – Without Arms, Non-Stacking	242
M601-2110	Improv Series – Sled-Base Chairs – With Arms, Non-Stacking	241
M601-2190	Improv Series – Sled-Base Chair with Tablet Arm – Non-Stacking	243
M601-2300	Improv Series – Sled-Base Chairs – Without Arms, Non-Stacking	242
M601-2310	Improv Series – Sled-Base Chairs – With Arms, Non-Stacking	241
MPRV-BARS	Improv Series – Tandem Tables and Connecting Bars – Chair-to-Chair Connecting Bars	248
MPRV-CART	Improv Series – Accessories – Stacking Dolly	245
MPRV-RACK	Improv Series – Accessories – Book Rack	245
MTE1-20	Improv Series – Tandem Tables and Connecting Bars – End-of-Run Table	248
MT11-20	Improv Series – Tandem Tables and Connecting Bars – In-Line Table	248
MTR1-20	Improv Series – Occasional Tables – Round Table	249
MTV1-2048	Improv Series – Occasional Tables – Oval Table	249
SAS-22-A1A	Candor Modern Seating – Fully Upholstered Seat and Back	295
SAS-22-A1B	Candor Classic Seating – Fully Upholstered Seat and Back	294
SAS-22-A2B	Candor Classic Seating – Fully Upholstered Seat and 3/4 Back	294
SAS-22-A3A	Candor Modern Seating – Fully Upholstered Seat and 1/2 Back	295

Index

Product Code	Product Description	Page
SAS-2W-A4A	Candor Modern Seating – Fully Upholstered Seat and Slat Back	295
SAS-2W-A4B	Candor Classic Seating – Fully Upholstered Seat and Slat Back	294
SCB-44-0H	Very – Seminar with Storage Rack – Perforated Back – Seminar With Storage Rack	96
SCB-44-3H	Very – Seminar with Storage Rack – Perforated Back – Seminar With Storage Rack	96
SCB-45-3H	Very – Seminar with Storage Rack – Tetro Back – Seminar With Storage Rack	111
SCC-44-01	Very – Conference Chair - Perforated – Without Arms	99
SCC-44-11	Very – Conference Chair - Perforated – With Arms	98
SCC-45-01	Very – Conference Chair - Tetro Back – Without Arms	114
SCC-45-11	Very – Conference Chair - Tetro Back – With Arms	113
SCF-44-01	Very – Conference Stool – Perforated Back	100
SCF-44-11	Very – Conference Stool – Perforated Back	100
SCF-45-01	Very – Conference Stool – Tetro Back	115
SCF-45-11	Very – Conference Stool – Tetro Back	115
SCH-44-0S	Very – Wire Stacker – Without Arms	83
SCH-44-3S	Very – Wire Stacker – With Arms	82
SCHA-R	Very – Accessories – Wire Stacker Tablet Arm	116
SCHR-1	Very – Accessories – Wire Stacker Storage Rack	116
SCK-44-3H	Very – Side Chair with Storage Rack – Perforated Back	90
SCK-45-3H	Very – Side Chair with Storage Rack – Tetro Back	105
SCL-44-0H	Very – Bar Height Side Stool – Perforated Back	91
SCL-44-3H	Very – Bar Height Side Stool – Perforated Back	91
SCL-45-0H	Very – Bar Height Side Stool – Tetro Back	106
SCL-45-3H	Very – Bar Height Side Stool – Tetro Back	106
SCLC-44-0H	Very – Counter Height Side Stool – Perforated Back	92
SCLC-44-3H	Very – Counter Height Side Stool – Perforated Back	92
SCLC-45-0H	Very – Counter Height Side Stool – Tetro Back	107
SCLC-45-3H	Very – Counter Height Side Stool – Tetro Back	107
SCM-44-0H	Very – Seminar Chair – Perforated – Without Arms	94
SCM-44-3H	Very – Seminar Chair – Perforated – With Arms	93
SCM-44-RH	Very – Seminar with Tablet Arm – Perforated Back – Seminar With Tablet Arm	95
SCM-45-0H	Very – Seminar Chair – Tetro Back – Without Arms	109
SCM-45-3H	Very – Seminar Chair – Tetro Back – With Arms	108
SCM-45-RH	Very – Seminar with Tablet Arm – Tetro Back – Seminar With Tablet Arm	110
SCS-44-0H	Very – Side Chair – Perforated – Without Arms	88
SCS-44-3H	Very – Side Chair – Perforated – With Arms	87
SCS-44-RH	Very – Side Chair with Tablet Arm – Perforated Back – Side With Tablet Arm	89
SCS-45-0H	Very – Side Chair – Tetro Back – Without Arms	103
SCS-45-3H	Very – Side Chair – Tetro Back – With Arms	102
SCS-45-RH	Very – Side Chair with Tablet Arm – Tetro Back – Side With Tablet Arm	104
SCSG-1	Very – Accessories – Ganging Connector	116
SCSG-2	Very – Accessories – Ganging Connector	116
SCT-1	Very – Accessories – Stacking Carts	117
SCT-20-0011	Very Task – Task Chair without Arms	132
SCT-20-1011	Very Task – Task Chair with Fixed Arms	130
SCT-20-4011	Very Task – Task Chair with Height Adjustable Arms	128
SCT-20-7011	Very Task – Task Chair with 4D Arms	126
SCT-20-7115	Very Task Value Model – Task Chair with 4D Arms	124
SCT-3	Very – Accessories – Stacking Carts	117
SCT-4	Very – Accessories – Stacking Carts	117
SCTC-20-0011	Very Task – Task Stool without Arms	140

Index

Product Code	Product Description	Page
SCTC-20-1011	Very Task – Task Stool with Fixed Arms	138
SCTC-20-4011	Very Task – Task Stool with Height Adjustable Arms	136
SCTC-20-7011	Very Task – Task Stool with 4D Arms	134
SCW-44-0S	Very – Bar Height Wire Stool	84
SCW-44-3S	Very – Bar Height Wire Stool	84
SCWC-44-0S	Very – Counter Height Wire Stool	85
SCWC-44-3S	Very – Counter Height Wire Stool	85
SFS-U0-0N02A	Fern – Task Stool without Arms — Aluminum Model	40
SFS-U0-0N02A	Fern – Task Stool without Arms — Plastic Model	39
SFS-U0-1S02A	Fern – Task Stool with Fixed Arms — Aluminum Model	38
SFS-U0-1S02A	Fern – Task Stool with Fixed Arms — Plastic Model	37
SFS-U0-4S02A	Fern – Task Stool with Height Adjustable Arms — Aluminum Model Aluminum Model	36
SFS-U0-4S02A	Fern – Task Stool with Height Adjustable Arms — Plastic Model	35
SFS-U0-7S02A	Fern – Task Stool with 4D Arms — Aluminum Model	34
SFS-U0-7S02A	Fern – Task Stool with 4D Arms — Plastic Model	33
SFT-U0-0N02A	Fern – Task Chair without Arms — Aluminum Model	32
SFT-U0-0N02A	Fern – Task Chair without Arms — Plastic Model	31
SFT-U0-1S02A	Fern – Task Chair with Fixed Arms — Aluminum Model	30
SFT-U0-1S02A	Fern – Task Chair with Fixed Arms — Plastic Model	29
SFT-U0-4S02A	Fern – Task Chair with Height Adjustable Arms — Aluminum Model	28
SFT-U0-4S02A	Fern – Task Chair with Height Adjustable Arms — Plastic Model	27
SFT-U0-7S01A5	Fern Value Model – Task Chair with 4D Arms — Plastic Model	24
SFT-U0-7S02A	Fern – Task Chair with 4D Arms — Aluminum Model	26
SFT-U0-7S02A	Fern – Task Chair with 4D Arms — Plastic Model	25
SHL-22-1R10	Harbor Work Lounge – Fully Upholstered, Cast Aluminum Base – Lounge Chair	316
SHL-22-1R12	Harbor Work Lounge – Fully Upholstered, Cast Aluminum Base – Lounge Chair	316
SHL-25-1L10	Harbor Work Lounge – Partially Upholstered, Cast Aluminum Base – Lounge Chair	318
SHL-25-1L12	Harbor Work Lounge – Partially Upholstered, Cast Aluminum Base – Lounge Chair	318
SHO-22-G	Harbor Work Lounge – Fully Upholstered, Cast Aluminum Base – Ottoman	317
SHO-25-G	Harbor Work Lounge – Partially Upholstered, Cast Aluminum Base – Ottoman	319
SLS1-2T-01	Lively – Side Chair – Without Arms	155
SLS1-2T-0H	Lively – Side Chair – Without Arms	155
SLS1-2T-11	Lively – Side Chair – With Arms	154
SLS1-2T-1H	Lively – Side Chair – With Arms	154
SLT1-2T-0115A	Lively – Task Chair without Arms – Task Chair without Arms	153
SLT1-2T-1115A	Lively – Task Chair with Fixed Arms – Task Chair with Fixed Arms	152
SLT1-2T-4115A	Lively – Task Chair with Height Adjustable Arms – Task Chair with Height Adjustable Arms	151
SLT1-2T-7115A	Lively Value Model – Task Chair with 4D Arms – Task Chair with 4D Arms	149
SLT1-2T-7115A	Lively – Task Chair with 4D Arms – Task Chair with 4D Arms	150
SODB-2424-P	Openest Collection – Sprig Tables – Round	309
SODC-1616-P	Openest Collection – Sprig Tables – Round	309
SON-3	Openest Collection – Plume Screens – Plume 3	306
SON-6	Openest Collection – Plume Screens – Plume 6	306
SON-9	Openest Collection – Plume Screens – Plume 9	306
SOPB-22	Openest Collection – Chick Pouf – Chick Pouf with Back	308
SOPN-22	Openest Collection – Chick Pouf – Chick Pouf without Back	308
SORA-5320-P	Openest Collection – Sprig Tables – Rectangle	309
SOSR-1-RW	Openest Collection – Feather Sofa – Feather – Asymmetrical	307
SOSS-1-RW	Openest Collection – Feather Sofa – Feather – Symmetrical	307
SPG-11-4	Poppy – Designer: Patricia Urquiola – Four Star Base with Glides	312

Index

Product Code	Product Description	Page
SPG-11-5	Poppy – Designer: Patricia Urquiola – Five Star Base with Casters	312
SPG-11-W	Poppy – Designer: Patricia Urquiola – Wood Base	313
STS-1	Tilt – Stool	361
SZG-22-1	Zody – 4 Leg	80
SZG-22-1	Zody – Sled Base – Sled Base	79
SZT-20-002MA1	Zody – Task Chair without Arms	61
SZT-20-102MA1	Zody – Task Chair with Fixed Arms	57
SZT-20-402MA1	Zody – Task Chair with Height Adjustable Arms	53
SZT-20-702MA1	Zody – Task Chair with 4D Arms	49
SZT-20-711MA5	Zody Value Model – Task Chair with 4D Arms	48
SZTC-20-002MA1	Zody – Task Stool without Arms	76
SZTC-20-102MA1	Zody – Task Stool with Fixed Arms	72
SZTC-20-402MA1	Zody – Task Stool with Height Adjustable Arms	68
SZTC-20-702MA1	Zody – Task Stool with 4D Arms	64
TABR-12	System 12 – Accessories – Tablet Board	291
TQ84-0011	ToDo – Single, Stationary	328
TQ84-0012	ToDo – Double, Stationary	330
TQ84-0013	ToDo – Triple, Stationary	331
TQ85-0011	ToDo – Single, Mobile	329
TQ90-0001	ToDo – Accessories – Wood Tablet with Arm	332
TQ90-0003	ToDo – Accessories – Cup Holder	332
TQ90-0004	ToDo – Ottoman	333
TQ90-0006	ToDo – Accessories – Grommet Cover	332
X611-2040	X99 – Executive without Arms	167
X611-2044	X99 – Executive without Arms	166
X611-2140	X99 – Executive with Loop Arms	165
X611-2144	X99 – Executive with Loop Arms	164
X611-2W40	X99 – Executive with 3-dimensional Arms	162
X611-2W44	X99 – Executive with 3-dimensional Arms	161
X621-2040	X99 – Task Chair without Arms	175
X621-2044	X99 – Task Chair without Arms	174
X621-2140	X99 – Task Chair with Loop Arms	173
X621-2144	X99 – Task Chair with Loop Arms	172
X621-2W40	X99 – Task Chair with 3-dimensional Arms	170
X621-2W44	X99 – Task Chair with 3-dimensional Arms	169
X630-3100	X99 – Guest Chair	176
X640-0040	X99 – Seminar Chair – Without Arms	178
X641-2040	X99 – Advanced Seminar Chair – Without Arms	180
X641-2140	X99 – Advanced Seminar Chair – With Arms	179
X840-0140	X99 – Seminar Chair – With Arms	177
Z600-2100	LOOK Seating – Side Chairs – Without Arms	261
Z600-2130	LOOK Seating – Side Chairs – With Arms	262
Z600-2210	LOOK Seating – Side Chairs – With Arms	262
Z600-2230	LOOK Seating – Side Chairs – With Arms	262
Z600-2440	LOOK Seating – Lounge Chairs – Lounge Chair	263
Z831-1042	LOOK Seating – Mid-Back Chair without Arms	257
Z831-1442	LOOK Seating – Mid-Back Chair with Fixed Arms	258
Z831-1742	LOOK Seating – Mid-Back Chair with Height Adjustable Arms	259
Z831-1W42	LOOK Seating – Mid-Back Chair with Height and Width Adjustable Arms	260
Z851-1042	LOOK Seating – High-Back Chair without Arms	253

Index

<u>Product Code</u>	<u>Product Description</u>	<u>Page</u>
Z851-1442	LOOK Seating – High-Back Chair with Fixed Arms	254
Z851-1742	LOOK Seating – High-Back Chair with Height Adjustable Arms	255
Z851-1W42	LOOK Seating – High-Back Chair with Height and Width Adjustable Arms	256

PRODUCT NON-OBSOLESCENCE AND WARRANTY POLICY

This North American Haworth Product Non-Obsolescence and Warranty Policy (the "policy") applies to products manufactured after May 8, 2015. For products manufactured before this date please refer to the policy published in the NA Price List when purchased or contact your local Authorized Haworth Dealer. All Haworth products are warranted for 24 hour / 7 day use over the length of the Applicable Warranty Period as set forth below.

Haworth, Inc. or Haworth, Ltd., (each called "Haworth") will make a good faith effort to maintain product compatibility within our various generations of integrated product platforms to provide our customers with spaces that adapt to change. Under our non-obsolescence policy, we commit to provide our customers with products of comparable function or operational characteristics for a term equal to the Applicable Warranty Period. Haworth fabrics and finishes must be updated periodically to maintain the market appeal of our products and respond to the demands and changing preferences of our customers. As a result, we or the manufacturer may discontinue some fabrics and finishes before expiration of the Applicable Warranty Period.

If a new product purchased or leased from Haworth or from an Authorized Haworth Dealer proves to be defective (as defined below) while the product is still in the possession of the initial purchaser or lessee and if they, within the Applicable Warranty Period, inform Haworth of the defect by contacting the local Authorized Haworth Dealer, then, except as provided below, Haworth will, at Haworth's option, either repair or replace the product, at Haworth's expense, or refund the purchase price of the product. Except as provided below, a product shall be considered "defective" if Haworth finds that it is defective in material or workmanship and if the defect materially impairs the use of the product to the purchaser or lessee. The applicable warranty period begins on the day the product is manufactured. If a product that the purchaser or lessee references in a notice of defect was not installed by a Haworth Certified installer and/or reconfigured by a Haworth-trained installer, then the product may not be considered defective and Haworth will not be obligated to repair or replace it or to refund its price.

PRODUCTS / APPLICABLE WARRANTY PERIOD

LIFETIME

All Haworth products are warranted for lifetime *except products, components and materials described below:*

TWELVE YEARS

All Haworth NA manufactured seating is warranted for 24/7 multiple shift use by persons up to 325 lbs and includes the framework, mechanisms, seating foam, seat & back mesh and seating glides & casters.

All wood or wood framed products.

TEN YEARS

All wall products (excluding soft close door mechanisms warranted for Two Years), electrical components (excluding Power Base™ AI, USB receptacles and workware products), electrical accessories, fixed task lighting (excluding LED lighting), adjustable keyboard pads, monitor arms and products that are at any time used in a classroom or educational environment (other than administration areas) *except as limited or described below:*

FIVE YEARS

Fabric scrims and fabrics rated Heavy Duty (A) under the Association of Contract Textiles Guidelines, leather, vertical use markerboard laminates, user-adjustable worksurface mechanisms, gel arm caps, thermofused laminates, slow close mechanisms, LED lighting, Power Base™ receptacles with USB charging outlets, electronic ballasts used in task lighting, horizontal glass or thermoplastic table assemblies and Systems Accessories.

THREE YEARS

Power Base AI Electrical products, workware™ products, Hoop products (excludes any warranty for surface damage such as scratches, dents or abrasions), plastic ultraviolet light color fastness and fabrics rated General Contract (a) under the Association of Contract Textiles Guidelines.

ONE TO FIVE YEARS*

Products that are manufactured outside North America and sold into the North American market.

ONE YEAR

Horizontal use markerboard laminate, Openest™ Plume Screens, soft palm rest, mouse pad insert and translucent edging.

Haworth "Specials" products that involve simple modification of a standard based product will be warranted for the same period as the standard catalog product it is based on. Haworth "Specials" products that deviate from standard catalog product in the form of features, construction, function, or aesthetic will be warranted for 1 year.

All software is without warranty of any kind, either expressed or implied.

All service parts are warranted for two years or the remaining balance of the assembly's original warranty period, whichever is longer.

*The Applicable Warranty Period for each such product is specified in Haworth's price list for the product.

A product will not be considered to be defective, and Haworth will not repair, or replace it or refund its price if the product (1) is a consumable product, such as a lamp; (2) is "Customer's Own Material" (i.e. material specified by the purchaser or lessee that is not a standard Haworth product offering, such as Haworth Alliance fabrics); (3) is not installed and used as recommended in Haworth's written specification, installation, care, maintenance and user guides; (4) has been otherwise misused or suffered abusive damage or (5) is a product that is manufactured by a third-party supplier from whom Haworth purchases it for resale without incorporating it into Haworth product (in which case Haworth will assign to the purchaser or lessee any warranty that the manufacturer provides), unless otherwise specified by Haworth in writing. At all times the Covered Product must have been located in a building that is (i) dry, fully closed-in and protected from the natural elements, and (ii) adequately heated, ventilated and air conditioned in order to maintain an internal temperature between 40°F and 90°F (4°C and 32°C) and relative humidity levels between 25% and 55%.

A defect in material or workmanship does not include damage to a product, or failure of a product to operate or perform properly or to maintain appearance, caused by (a) normal wear and tear; (b) an Act of God or transportation; (c) a product alteration made without Haworth's express written authorization; (d) the natural variation of color, grain or texture found in wood and leather; (e) the natural aging found in materials such as wood, fabric and leather which results in colors shifting during use; (f) dye lot variations in fabric, leather or wall covering (g) the natural patina of leather during use; (h) "puddling" of leather or faux leather; or (i) reverse crocking of dyes from clothing onto our seating materials.

EXCEPT AS STATED ABOVE, HAWORTH DOES NOT MAKE A WARRANTY AS TO ANY PRODUCT AND, IN PARTICULAR, DOES NOT MAKE A WARRANTY OF MERCHANTABILITY OR OF FITNESS FOR A PARTICULAR PURPOSE. Product repair or replacement or refund of the price, at Haworth's option, in accordance with this Policy, is the purchaser's or lessee's exclusive remedy for a product defect. Haworth shall not have tort liability with respect to a product, and Haworth shall not be liable for any consequential, economic, indirect, special, punitive or incidental damages arising from a product defect. Haworth shall not be liable for repair or product placement due to improper installation or any defect in materials used for installation which are not manufactured, sold or supplied by Haworth.

Released May 8, 2015

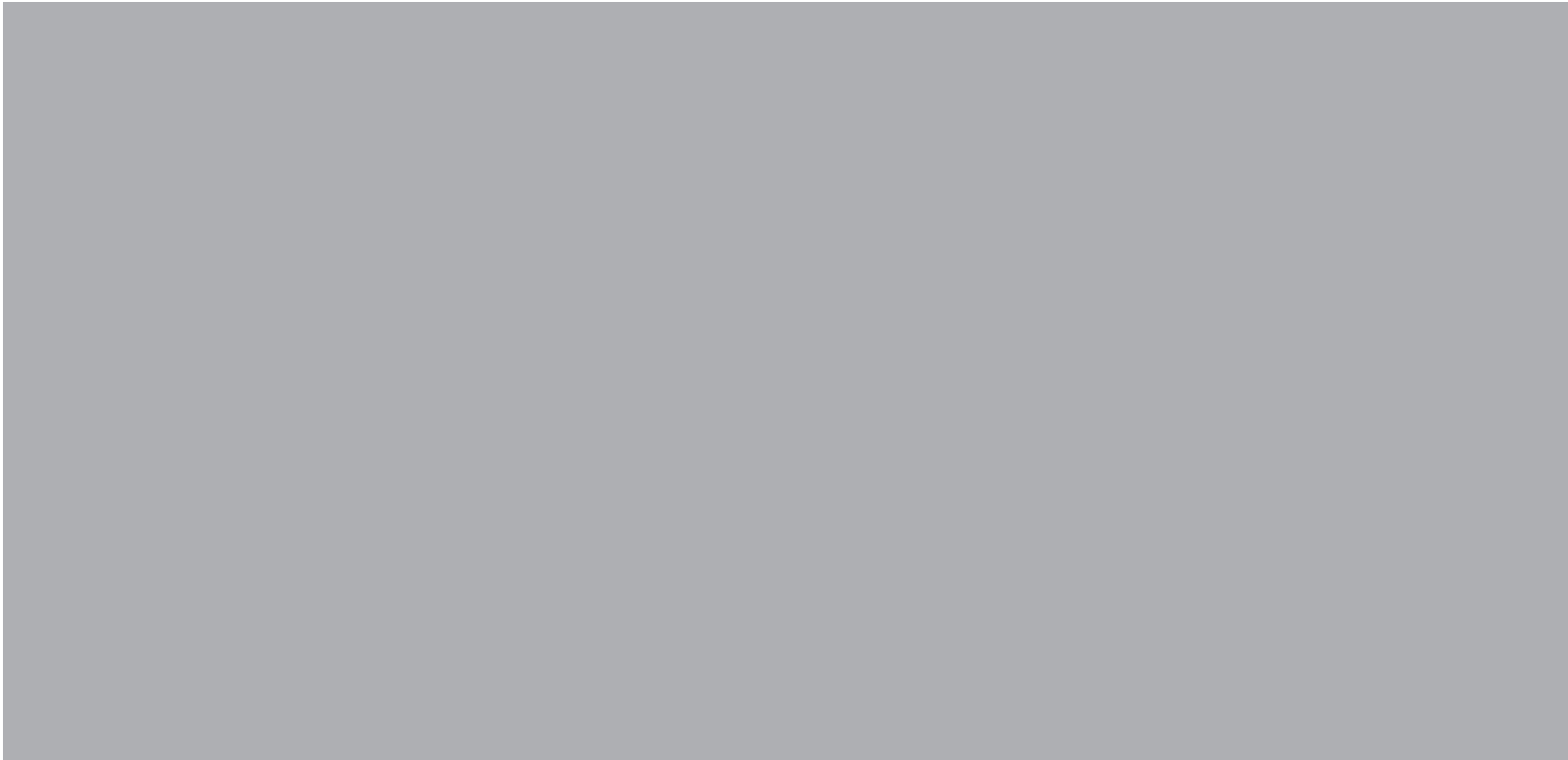

HAWORTH®

For more information call 800.344.2600 or 616.393.3000.

Haworth is a registered trademark of Haworth, Inc.

©Haworth, Inc. 2017 5.17 Item #0004

haworth.com | haworth-europe.com | haworth-asia.com

Fern At-A-Glance

General Specifications

UPHOLSTERY / AESTHETIC OPTIONS

Headrest



Features:

- Height adjusts vertically 2.5" to fit a wide range of users.
- Headrest has an upholstered front with a plastic back. Headrest material on front will match Fern back fabric (mesh or faux leather) and color; plastic back of headrest will match plastic trim color (Black, Fog, or Snow).
- Headrest sent attached; 11.25"W x 7.5"H x 2.5" height adjustment.
- See Fern price pages for specification.
- Headrest can be field installed. For chairs manufactured prior to 6/1/17, you will need to order the headrest and back. For chairs manufactured after 6/1/17, order headrest only. See e-Parts.

Benefits:

- Headrest is mounted to the back, in line with the central loop spine, to enhance Fern's total body support.
- Headrest flexes for support, while responding to natural movements, allowing you to work well in a reclined or upright position.
- The headrest was designed to fit the curvature of the neck while still supporting the head, moving with you as you roll your head to the side.

Faux Leather Upholstery



Features:

- Vertical stitched double seams down the center on the upholstered seat and back with Faux Leather.