

Hi5 FURNITURE Hi5 FURNITURE Hi5 FURNITURE Hi5 FURNITURE Hi5 FURNITURE

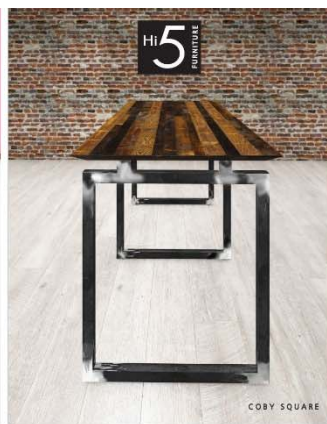

TABLE OF CONTENTS

Seating Chart	4-5		
Ganger Location Codes	6		
Nesting Table	7		
Power Location Codes	8		
Power	8-20	Harbor	121-137
Options	21-24	Island	138-144
Credenzas	25-26	Lincoln	145-177
Arlington	27	Pinnacle	178
Coby Apron	28-62	Railway 1.0	179-185
Coby Square	63-107	Supreme	186-201
Empire	108-111	Union 2.0	202-242
Gateway	112-120	Terms & Conditions	243-245

TABLE TOP EDGE TREATMENTS

Questions? Call 816-774-4050



Edge code: L73

.75" thick laminate top.
EDGE: High Impact 3mm PVC
Square corners.



Edge code: L76

.75" thick laminate top.
EDGE: Self edges
Square corners.



Edge code: L3

1.25" thick laminate top.
EDGE: High Impact 3mm PVC
Square corners.



Edge code: L11

1.25" thick laminate top.
EDGE: Knife 3mm PVC / sealed
Square corners.



Edge code: L6

1.25" thick laminate top.
EDGE: Self edges
Square corners.



Edge code: L8

2" thick laminate top.
EDGE: Self Edge
Square corners.



Edge code: L20

1.25" thick top.
EDGE: Square 1.25" w x 1.25" h
Solid wood edges.
Mitered square corners.



Edge code: L33

1.25" thick laminate top.
EDGE: Knife 2" w x 1.25" h
Solid wood edges.
Mitered square corners.



Edge code: L17

1.25" thick laminate top.
EDGE: Bull nose .625" w x 1.25" h
Baltic birch (apple ply) wood edges.
Mitered square corners.



Edge code: L18

1.25" thick laminate top.
EDGE: Knife 2" w x 1.25" h
Baltic birch (apple ply) wood edges.
Mitered square corners.

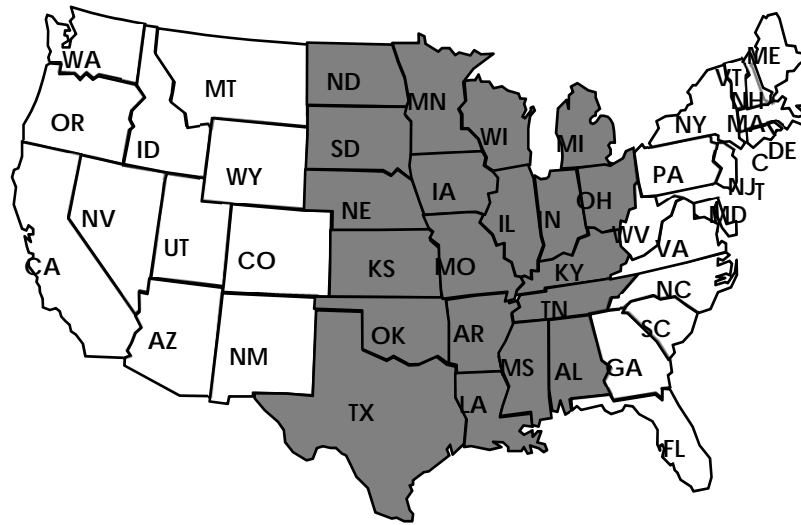

Freight Zone Map

Grey- Zone 1 Prepaid freight on orders over \$2000 NET
Orders under \$2000 NET - Add \$200 NET to order

White - Zone 2 Prepaid freight on orders over \$3000 NET
Orders under \$3000 NET - Add \$300 NET to order

All products are shipped in compliance with the National Motor Freight Classification Code. All products ship unassembled unless otherwise specified by Hi5 Furniture. Freight is prepaid on a dock to dock basis for all orders exceeding zone minimum nets when shipped within the 48 contiguous states excluding Alaska and Hawaii or export.

All orders under zone minimum nets are a flat shipping fee of \$200 net for zone one and \$300 net for zone two, which will be added to the invoice. Hi5 Furniture shall not be held liable for delays caused by strikes, catastrophes, wars, riots or any other cause beyond our control.

Additional expenses will be debited from customer account and billed as "shipping/handling." Examples of additional expenses with variable charges are: Inside delivery, Residential delivery and Lift gate requirements.

Failure to inspect product at time of receipt, note damages on delivery receipt and/or notify Hi5 Furniture of damages within 10 days of the original date of receipt constitutes acceptance of products and a waiver of all claims. Neither Hi5 Furniture nor the carrier will be responsible for concealed damage claims if shipments are left unopened. CONCEALED DAMAGE MUST BE REPORTED WITHIN 7 DAYS FROM DELIVERY TO BE VALID. Any concealed damage reported after 7 days will not be accepted by Hi5 Furniture and is the responsibility of the customer.

All products are loaded on carrier trucks free from defects and/or damage. Responsibility of safe delivery and transport of products is assumed by the carrier upon loading. It is the customer's responsibility that all cartons, crates and packages be opened and inspected at time of delivery for damages or shortages regardless of condition. Any damages found during inspection must be clearly noted on the delivery receipt and packages to be left in original condition as received, failure to do so will void the ability of filing a freight claim. Hi5 Furniture should be notified immediately to assist in filing of freight claim.

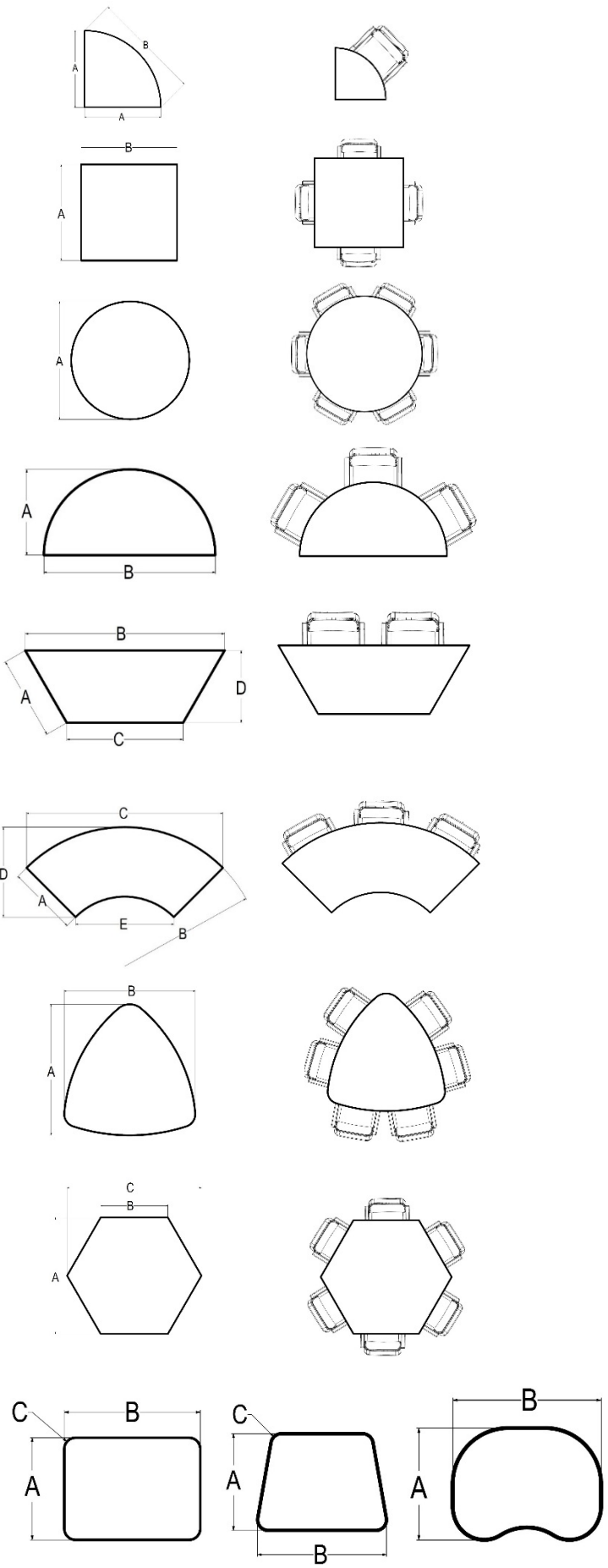

Quarter Round

A	B	Seating Capacity
24"	33.93"	1
30"	42.43"	1
36"	50.87"	2

Square + Round

A	B	Square Seating	Round Seating
24"	24"	2	2
30"	30"	2	3
36"	36"	4	3-4
42"	42"	4	4
48"	48"	4	5
54"	54"	4	5
60"	60"	8	6
72"	72"	8	7-8
84"	84"	8	9
96"	96"	12	10
108"	108"	12	11
120"	120"	16	12

Half Round

A	B	Seating Capacity
24"	48"	1
30"	60"	2
36"	72"	3
60"	60"	3-4

Trapezoid

A	B	C	D	Seating Capacity
24"	60"	36"	20.75"	1
24"	72"	48"	20.75"	2
30"	60"	30"	26"	3
30"	72"	42"	26"	

Crescent

A	B	C	D	E	Seating Capacity
24"	48"	67.81"	31"	33.93"	2
30"	60"	84.81"	38.75"	42.43"	3

Guitar Pick

A	B	Seating Capacity
48"	24"	4
60"	30"	4
72"	36"	5
60"	60"	6

Hexagon

A	B	C	Seating Capacity
41.57"	24"	48"	3
51.96"	30"	60"	6
62.35"	36"	72"	6
72.75"	42"	84"	6
83.14"	48"	96"	Substrate 10-12
103.92"	60"	120"	Substrate 12

Arlington Table Tops

A	B	C	Seating Capacity
18"	24"	2"	1

Seating Chart – based on 30" per seat

www.hi5furniture.com Questions? 816-774-4050

March 1, 2018

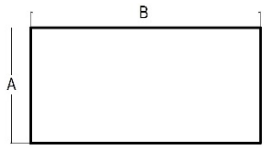

Rectangle

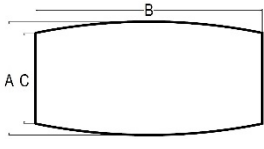
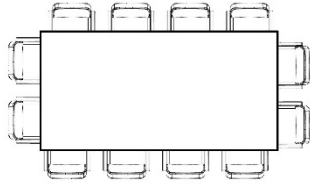

Boat

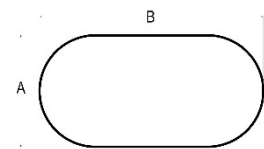
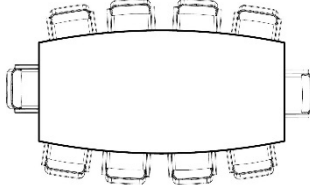

Racetrack

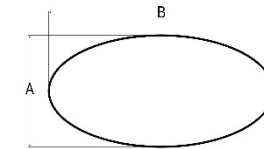
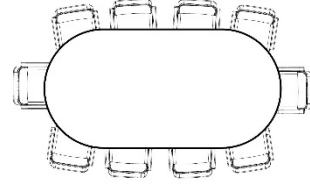

Elliptical / Oval

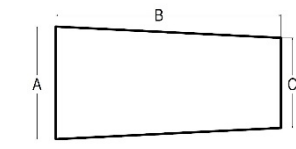
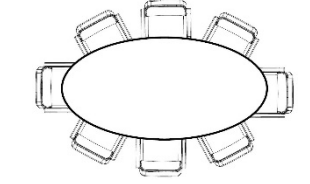

Tele-Wedge

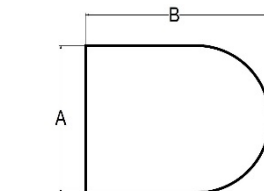
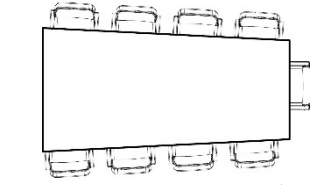

D Shape

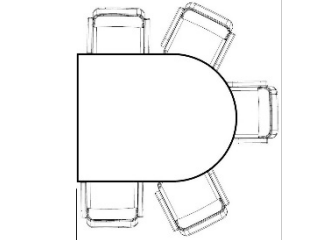

D Shape Seating Capacity

A	B	Seating Capacity
24"	60"	5
24"	72"	5
24"	84"	7
24"	96"	7
30"	60"	5
30"	72"	5
30"	84"	7
30"	96"	7
36"	60"	5
36"	72"	5
36"	84"	7
36"	96"	7
42"	60"	6
42"	72"	6
42"	84"	8
42"	96"	8
48"	60"	6
48"	72"	6
48"	84"	8
48"	96"	8
60"	60"	6
60"	72"	6
60"	84"	8
60"	96"	8

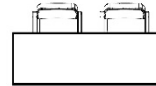

A	B	C	Training	Meeting	A	B	C	Meeting
18	30	NA	1	NA	42	60	30	6
18	60	NA	2	NA	42	72	30	6
18	66	NA	2	NA	42	84	30	6
18	72	NA	2	NA	42	90	30	8
18	84	NA	3	NA	42	96	30	8
18	90	NA	3	NA	42	108	30	10
18	96	NA	3-4	NA	42	120	30	10
18	108	NA	4	NA	42	132	30	10-12
18	120	NA	4-5	NA	42	144	30	12
					42	168	30	12
24	30		1	2	42	192	30	14
24	36		1	2	42	216	30	16
24	48		1	4	42	240	30	168
24	54		2	4	42	264	30	20
24	60		2	6	42	288	30	20-22
24	66		2	6				
24	72		2	6	48	60	36	6-8
24	78		3	6	48	72	36	6-8
24	84		3	6	48	84	36	8-10
24	90		3	8	48	90	36	8-10
24	96		3-4	8	48	96	36	8-10
24	108		4	8	48	108	36	10-12
24	120		4-5	10	48	120	36	10-12
24	132		4-5	10-12	48	132	36	12
24	144		4-5	12	48	144	36	12
					48	168	36	12-14
30	36	18	1	2	48	192	36	14-16
30	48	18	1	4	48	216	36	16-18
30	54	18	2	4	48	240	36	18-20
30	60	18	2	6	48	264	36	20-22
30	66	18	2	6	48	288	36	22
30	72	18	2	6				
30	78	18	3	6	60	72	48	8
30	84	18	3	6	60	84	48	8
30	90	18	3	8	60	90	48	10
30	96	18	3-4	8	60	96	48	10
30	108	18	4	8	60	108	48	12
30	120	18	4-5	10	60	120	48	12
30	132	18	4-5	10-12	60	132	48	12
30	144	18	4-5	12	60	144	48	14
					60	168	48	14
					60	192	48	16
36	48	24	1	4	60	216	48	18
36	54	24	2	4	60	240	48	20
36	60	24	2	6	60	264	48	22
36	66	24	2	6	60	288	48	22
36	72	24	2	6				
36	78	24	3	6				
36	84	24	3	6				
36	90	24	3	8				
36	96	24	3-4	8				
36	108	24	4	8				
36	120	24	4-5	10				
36	132	24	4-5	10-12				
36	144	24	4-5	12				

Table Ganger Location Codes

www.hi5furniture.com Questions? 816-774-4050

March 1, 2018



Table Ganger Location A



Table Ganger Location B



Table Ganger Location C

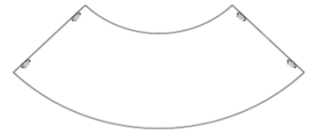

Table Ganger Location A



Table Ganger Location A



Table Ganger Location B

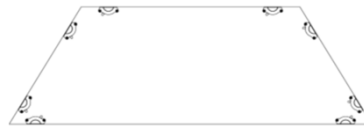

Table Ganger Location C

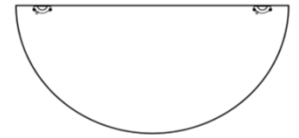
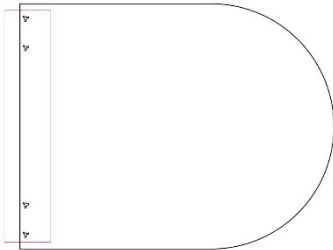
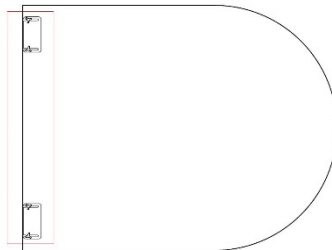

Table Ganger Location D

Quick Leveling Gangers - Location Codes



QUICK RELEASE LOCATION "A"



QUICK RELEASE LOCATION "B"

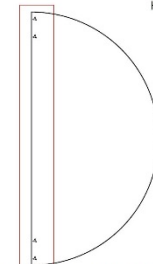

QUICK RELEASE LOCATION "A"

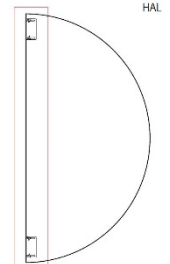

QUICK RELEASE LOCATION "B"

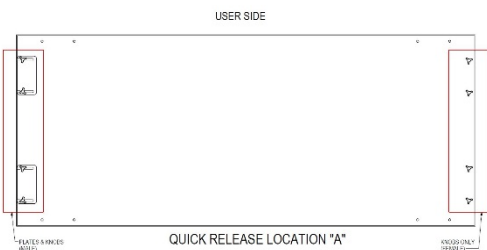

QUICK RELEASE LOCATION "A"

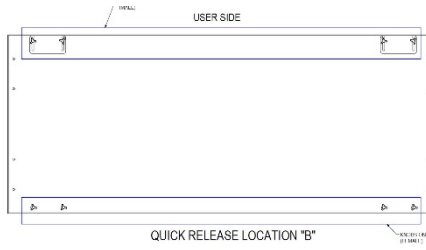

QUICK RELEASE LOCATION "B"

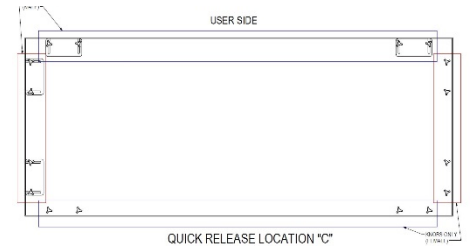

QUICK RELEASE LOCATION "C"

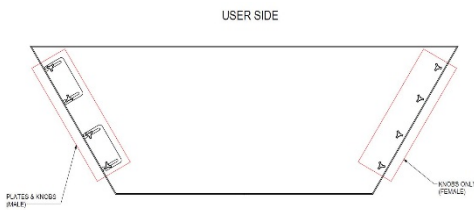

QUICK RELEASE LOCATION "A"

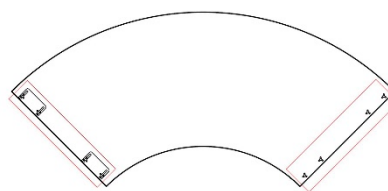

QUICK RELEASE LOCATION "A"

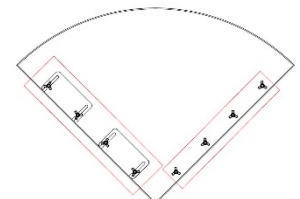

QUICK RELEASE LOCATION "A"

Nesting Table Storage Information

www.hi5furniture.com Questions? 816-774-4050

March 1, 2018

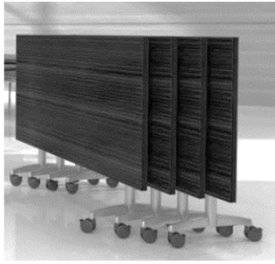

Supreme Tables

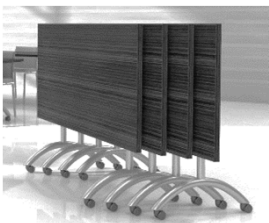
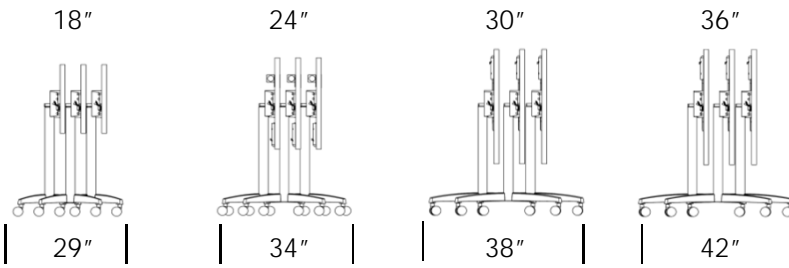

Gateway Tables

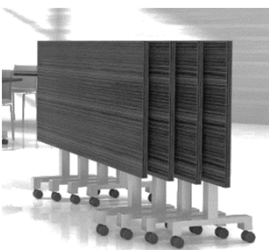
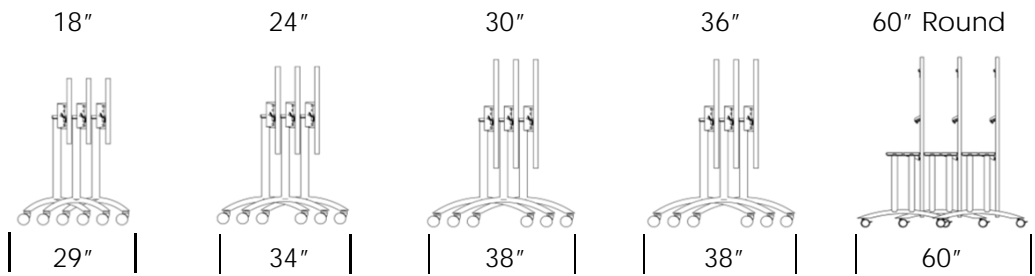

Harbor Tables

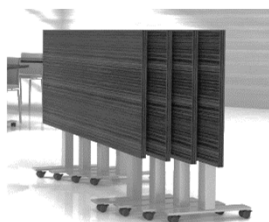
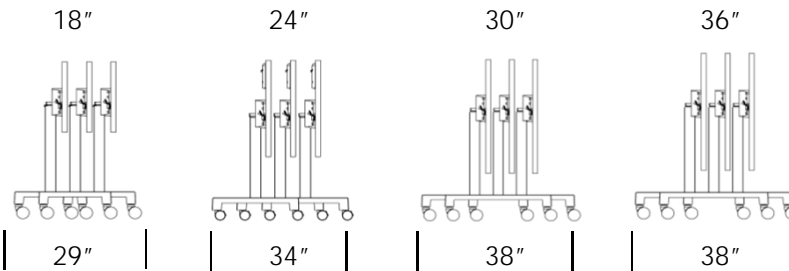

Empire Tables

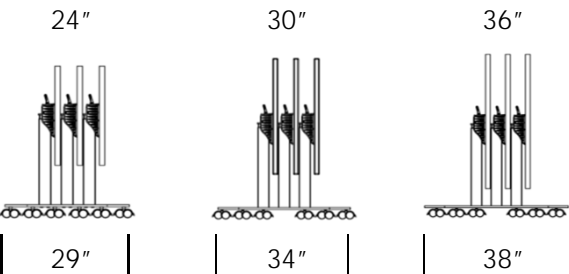

Power location code includes location on the table and the orientation of the power box.

Use these codes for mounting Cove power into Union panel bases or Pinnacle tables.

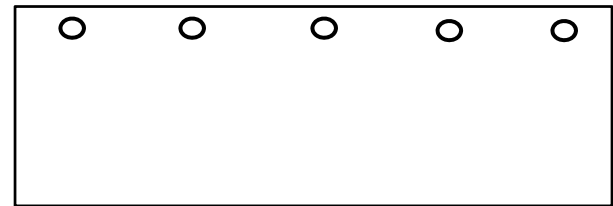
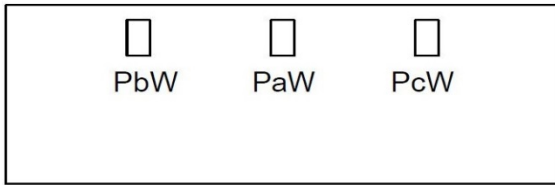
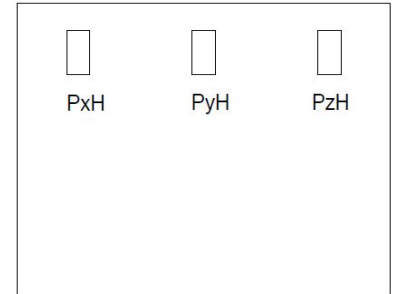
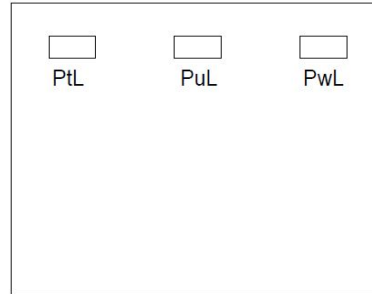
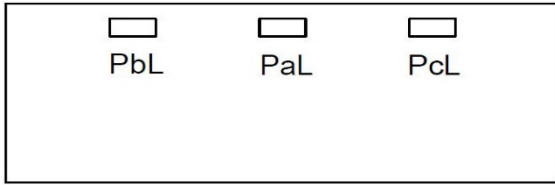

Grommet Location G1 Grommet Location G2 Grommet Location G3 Grommet Location G4 Grommet Location G5

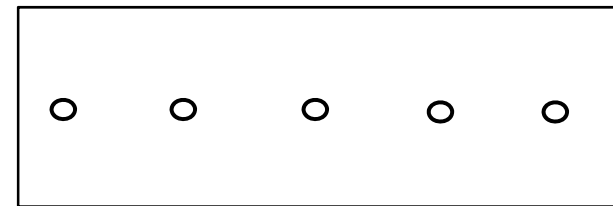
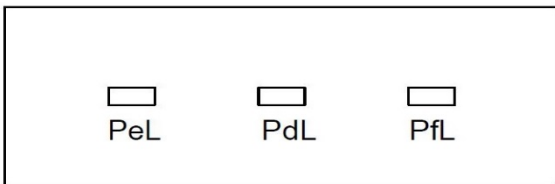

Grommet Location G6 Grommet Location G7 Grommet Location G8 Grommet Location G9 Grommet Location G10

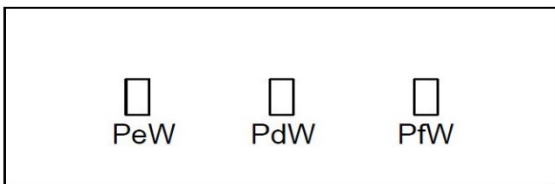

EDGE MOUNTED LOCATION CODES

Use these codes for mounting Cove power into aprons of Coby Apron tables. Also use these codes for Seclusion power boxes.

The example below location code is: PjL, PmL, PnL, PoL, PrL, PsL

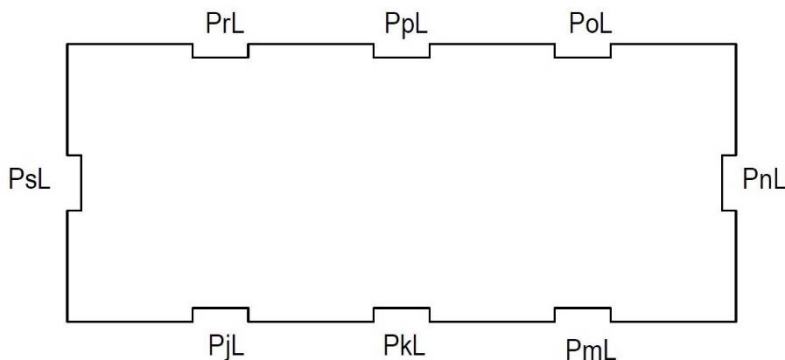

AV PLATES FOR POWER BOXES

Questions? Call 816-774-4050

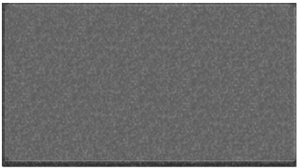

Plate #0 Add \$10 to power unit List Price.

Includes:
One Black Plate



Plate #1 Add \$160 to power unit List Price.

Includes:
(2) RJ-45 Punch Down Siemen Cat 6 Black

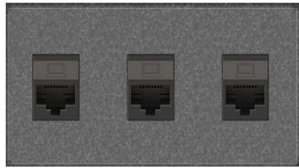

Plate #2 Add \$235 to power unit List Price.

Includes:
(3) RJ-45 Punch Down Siemen Cat 6 Black

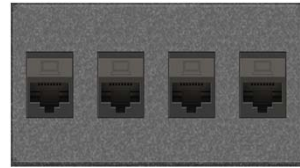

Plate #3 Add \$310 to power unit List Price.

Includes:
(4) RJ-45 Punch Down Siemen Cat 6 Black



Plate #4 Add \$260 to power unit List Price.

Includes:
(1) RJ-11 Siemen Cat 3 Black
(1) RJ-45 Punch Down Siemen Cat 6 Black
(1) VGA 15 Pin w/ 60" patch cord attached



Plate #6 Add \$230 to power unit List Price.

Includes:
(1) Mini-Stereo
(1) RJ-45 Punch Down Siemen Cat 6 Black
(1) VGA 15 Pin w/ 60" patch cord attached

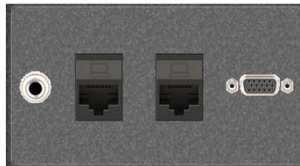

Plate #7 Add \$305 to power unit List Price.

Includes:
(1) Mini-Stereo
(2) RJ-45 Punch Down Siemen Cat 6 Black
(1) VGA 15 Pin w/ 60" patch cord attached

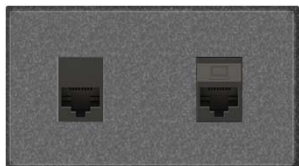

Plate #9 Add \$130 to power unit List Price.

Includes:
(1) RJ-11 Siemen Cat 3 Black
(1) RJ-45 Punch Down Siemen Cat 6 Black



Plate #10 Add \$155 to power unit List Price.

Includes:
(1) Mini-Stereo
(1) VGA 15 Pin w/ 60" patch cord attached



Plate #11 Add \$160 to power unit List Price.

Includes:
(1) RJ-45 Punch Down Siemen Cat 6 Black
(1) USB Type A/A w/ 72 patch cord attached

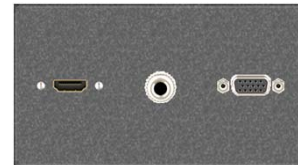

Plate #17 Add \$330 to power unit List Price.

Includes:
(1) HDMI with 36" patch cord attached
(1) Mini-Stereo
(1) VGA 15 Pin w/ 60" patch cord attached

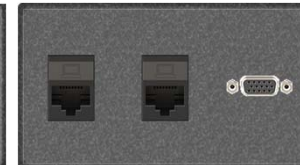

Plate #18 Add \$300 to power unit List Price.

Includes:
(2) RJ-45 Punch Down Siemen Cat 6 Black
(1) VGA 15 Pin w/ 60" patch cord attached



Plate #19 Add \$160 to power unit List Price.

Includes:
(2) USB Type A/A w/ 72 patch cord attached



Plate #21 Add \$335 to power unit List Price.

Includes:
(1) HDMI with 36" patch cord attached
(2) RJ-45 Punch Down Siemen Cat 6 Black



Plate #23 Add \$205 to power unit List Price.

Includes:
(1) RJ-11 Siemen Cat 3 Black
(2) RJ-45 Punch Down Siemen Cat 6 Black



Plate #25 Add \$360 to power unit List Price.

Includes:
(2) HDMI with 36" patch cord attached



Plate #26 Add \$390 to power unit List Price.

Includes:
(1) HDMI with 36" patch cord attached
(1) RJ-45 Punch Down Siemen Cat 6 Black
(1) VGA 15 Pin w/ 60" patch cord attached



Plate #27 Add \$280 to power unit List Price.

Includes:
(1) RJ-11 Siemen Cat 3 Black
(3) RJ-45 Punch Down Siemen Cat 6 Black



Plate #35 Add \$260 to power unit List Price.

Includes:
(1) HDMI with 36" patch cord attached
(1) USB Type A/A w/ 72 patch cord attached

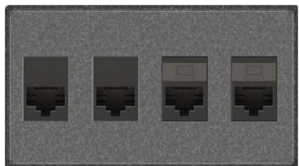

Plate #39 Add \$250 to power unit List Price.

Includes:
(2) RJ-11 Siemen Cat 3 Black
(2) RJ-45 Punch Down Siemen Cat 6 Black



Plate #40 Add \$315 to power unit List Price.

Includes:
(1) HDMI with 36" patch cord attached
(1) VGA 15 Pin w/ 60" patch cord attached



Plate #43 Add \$100 to power unit List Price.

Includes:
(2) RJ-11 Siemen Cat 3 Black

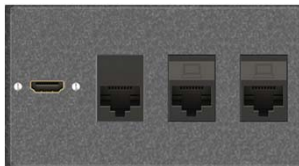

Plate #44 Add \$380 to power unit List Price.

Includes:
(1) HDMI with 36" patch cord attached
(1) RJ-11 Siemen Cat 3 Black
(2) RJ-45 Punch Down Siemen Cat 6 Black



Plate #45 Add \$430 to power unit List Price.

Includes:
(1) DVI Inline F/F
(1) HDMI with 36" patch cord attached

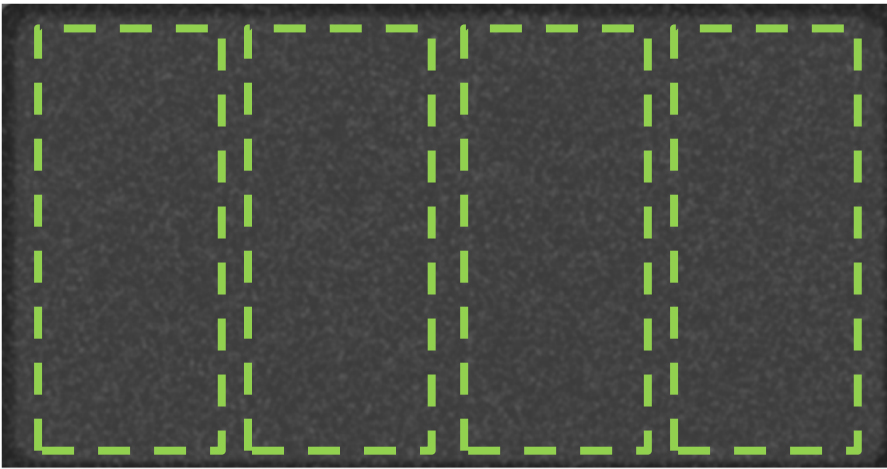

Plate #48 Add \$260 to power unit List Price.

Includes:
(1) HDMI with 36" patch cord attached
(1) RJ-45 Punch Down Siemen Cat 6 Black

BUILD YOUR OWN AV PLATES FOR POWER BOXES

Questions? Call 816-774-4050



Each AV Plate has 4 zones.
Each jack below shows how many zones the jack takes up in space.



Shown: AV Plate with Cord manager Brushes \$35 list per plate



RJ 45 JACK

\$85 list per jack

Specs: RJ-45 Punch Down Siemen Cat 6 Black

A/K/A Network jack, data jack, CAT 5 or CAT 6 jack



VGA - 2 zones

\$140 list per jack

Specs: VGA 15 Pin w/ 60" patch cord attached

A/K/A Projector jack



RJ 11 JACK

\$55 list per jack

Specs: RJ-11 Siemen Cat 3 Black

A/K/A Phone Jack



USB - 2 zones

\$85 list per jack

Specs: USB Type A/A w/ 72 patch cord attached

TO MAKE USB POWERD, MUST ADD TRANSFORMER KIT – ADD \$25 LIST PER TRANSFORMER KIT



Mini-Stereo

\$20 list per jack

A/K/A Stereo jack



HDMI JACK

\$185 list per jack

Specs: HDMI with 36" patch cord attached

COVE POWER – NON-LINKING

Questions? Call 816-774-4050



Specs: The Cove is a flush mount solution. Choose from power only, power and USB charging, or power, USB charging, and AV plate cut-out configurations. Units are wired for circuit one and include a 108" long soft wired 15 AMP corded plug. Receptacles are spill resistant, 12A, 120 VAC. USB ports are 2.1 AMP. Convenience outlets located underneath units, are available on select units and are shown below. All table tops include cut-out(s) and are predrilled for units. Some assembly required. The Cove is ETL listed.

? in the Code represents COLOR.

Replace ? with one of the following: B-Black, S-Silver, W-Gloss White.

Select the Location Code below for your power unit.

Select AV plates (if needed), AV plates can be found on page 8-9.

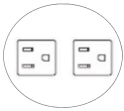

Code: PCVRD2?
(2) Power
List Price: \$350 per unit

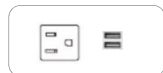

Code: PCV1USB?
(1) power, (2) USB
List Price: \$485 per unit



Code: PCVRD1USB?
(1) power, (2) USB
List Price: \$485 per unit

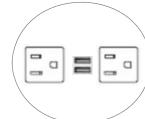

Code: PCVRD2USB?
(2) power, (2) USB
List Price: \$485 per unit

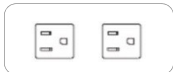

Code: PCV2?
(2) power
List Price: \$350 per unit



Code: PCV2USB?
(2) power, (2) USB
List Price: \$515 per unit



Code: PCV3AV?
(3) power, (1) AV Plate cut-out
List Price: \$540 per unit



Code: PCV2C?
(2) power, (1) outlet under the table
List Price: \$375 per unit



Code: PCV2USBC2?
(2) power, (2) USB, (2) outlet under the table
List Price: \$680 per unit



Code: PCV4AV?
(4) power, (1) AV Plate cut-out
List Price: \$625 per unit



Code: PCV3?
(3) power
List Price: \$540 per unit



Code: PCV3USB?
(3) power, (2) USB
List Price: \$650 per unit



Code: PCV2USBAV?
(2) power, (2) USB, (1) AV Plate cut-out
List Price: \$515 per unit



Code: PCV3USBC?
(3) power, (2) USB, (1) outlet under the table
List Price: \$650 per unit



Code: PCV3USBAV?
(3) power, (2) USB, (1) AV Plate cut-out
List Price: \$650 per unit

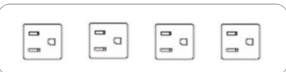

Code: PCV4?
(4) power
List Price: \$595 per unit



Code: PCV4USB?
(4) power, (2) USB
List Price: \$650 per unit

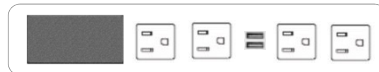

Code: PCV4USBAV?
(4) power, (2) USB, (1) AV Plate cut-out
List Price: \$650 per unit

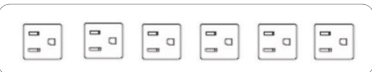

Code: PCV6?
(6) power
List Price: \$625 per unit



Code: PCV6USB2?
(6) power, (4) USB
List Price: \$870 per unit



Code: PCV6USB2AV?
(6) power, (4) USB, (1) AV Plate cut-out
List Price: \$870 per unit

LOCATION CODES ARE ON PAGE 6

COVE POWER – LINKING

Questions? Call 816-774-4050



Specs: The Cove Series is a flush mount. Choose from power only, power and USB charging, or power, USB charging, and AV plate cut-out configurations. Units are wired for two circuits and include metal flexible interconnecting cables that mount to the underside of the tops. Starter cable(s) are specified separately. Receptacles are spill resistant, 12A, 120 VAC. USB ports are 2.1 AMP. All table tops include cut-out(s) and are predrilled for units. Some assembly required. The Cove is ETL listed.

? in the Code represents COLOR.

Replace ? with one of the following: B-Black, S-Silver, W-Gloss White.

Select the Location Code below for your power unit.

Select AV plates (if needed), AV plates can be found on page 8-9.

Select Type and # of Feeder Starter Cables required



Code: PCVL1?
(1) power
List Price: \$485 per unit



Code: PCVL1USB?
(1) power, (2) USB
List Price: \$690 per unit

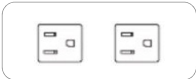

Code: PCVL2?
(2) power
List Price: \$550 per unit



Code: PCVL2USB?
(2) power, (2) USB
List Price: \$715 per unit



Code: PCVL2USBAB?
(2) power, (2) USB, (1) AV plate cut-out
List Price: \$715 per unit



Code: PCVL3?
(3) Power
List Price: \$745 per unit



Code: PCVL3USB?
(3) power, (2) USB
List Price: \$855 per unit

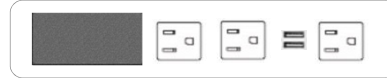

Code: PCVL3USBAB?
(3) power, (2) USB, (1) AV Plate cut-out
List Price: \$855 per unit

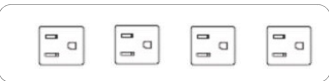

Code: PCVL4?
(4) Power
List Price: \$800 per unit



Code: PCVL4USB?
(4) power, (2) USB
List Price: \$965 per unit

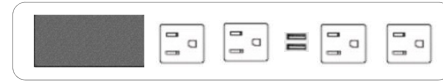

Code: PCVL4USBAB?
(4) power, (2) USB, (1) AV Plate cut-out
List Price: \$965 per unit

SPEC SPARATELY HOW MANY FEEDER CABLES YOU NEED FOR YOUR LAYOUT



Code: PSTS72F - Soft wire 72" long List Price \$220 per cable
Code: PSTS96F - Soft wire 96" long List Price \$300 per cable
Code: PSTS108F - Soft wire 108" long List Price \$340 per cable
Code: PSTS120F - Soft wire 120" long List Price \$350 per cable
Code: PSTS144F - Soft wire 144" long List Price \$380 per cable



Code: PSTH72F - Hardwire 72" long List Price \$140 per cable
Code: PSTH96F - Hardwire 96" long List Price \$170 per cable
Code: PSTH108F - Hardwire 108" long List Price \$180 per cable
Code: PSTH120F - Hardwire 120" long List Price \$195 per cable
Code: PSTH144F - Hardwire 144" long List Price \$220 per cable

LOCATION CODES ARE ON PAGE 6

VILLA POWER – NON LINKING

Questions? Call 816-774-4050



Specs: The Villa Series is a two part unit which includes a black power base which is mounted below the surface and a flush mount grommet which is dropped into cut-out in top and secured with screws. Grommets are available in black, silver, and gloss white. Options are Power, USB charging ports, and data jacks. Units are wired for circuit one and include a 108" long soft wired 15 AMP corded plug. Receptacles are spill resistant, 12A, 120 VAC, USB ports are 2.1 AMP and data jacks are Cat 6. Convenience outlets are located underneath units, additional outlets available on select units and are shown below. All table tops include cut-out(s) and are predrilled for units. Some assembly required. The Villa is ETL listed.

? in the Code represents COLOR.

Replace ? with one of the following: B-Black, S-Silver, W-Gloss White.

Select the Location Code below for your power unit.

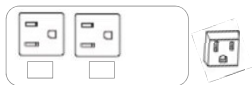

Code: PV?
 (2) power, (2) data jack knockouts and
 (1) outlet under the table
 List Price: \$330 per unit



Code: PV1?
 (2) power, (2) data jacks
 (1) outlet under the table
 List Price: \$470 per unit

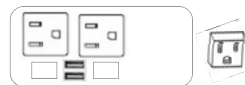

Code: PVUSB?
 (2) power, (2) USB, (2)
 data jack knockouts
 (1) outlet under the table
 List Price: \$495 per unit



Code: PV1USB?
 (2) power, (2) USB,
 (2) data jacks
 (1) outlet under the table
 List Price: \$635 per unit

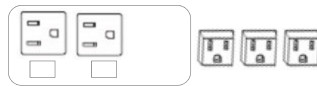

Code: PVP?
 (2) power, (2) data jack knockouts
 (3) outlets under the table
 List Price: \$415 per unit



Code: PVP1?
 (2) power, (2) data jacks
 (3) outlets under the table
 List Price: \$550 per unit



Code: PVPUSB?
 (2) power, (2) USB, (2) data
 jack knockouts
 (3) outlets under the table
 List Price: \$580 per unit



Code: PVP1USB?
 (2) power, (2) USB,
 (2) data jacks
 (3) outlets under the table
 List Price: \$650 per unit

UNDER TABLE ONLY

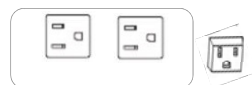

Code: PVUM2CB
 (3) outlets under the table
 List Price: \$260 per unit

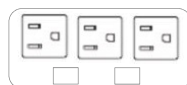

Code: PVUM3DB
 (3) outlets under the table
 (2) data jacks knockouts
 List Price: \$305 per unit

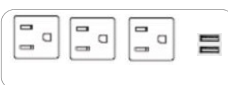

Code: PVUM3USBB
 (3) outlets under the table
 (2) USB under the table
 List Price: \$440 per unit

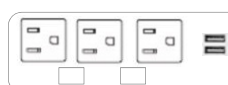

Code: PVUM3DUSBB
 (3) outlets under the table
 (2) USB under the table
 (2) data jacks knockouts
 List Price: \$470 per unit

LOCATION CODES ARE ON PAGE 6

Hi 5 VILLA POWER – LINKING

Questions? Call 816-774-4050



Specs: The Villa Series is a two part unit which includes a black power base which is mounted below the surface and a flush mount grommet which is dropped into cut-out in top and secured with screws. Grommets are available in black, silver, and gloss white. Designed to seamlessly blend power, USB charging ports, and data into a variety of applications. Units are wired for circuit one or circuit 2 and include metal flexible connecting cables that neatly mount to underside of top. Screws and cable clamps are included, power starter cable(s) are specified separately. Receptacles are spill resistant, 12A, 120 VAC, USB ports are 2.1 AMP and data jacks are Cat 6. All table tops include cut-out(s) and are predrilled for units. Some assembly required. The Villa is ETL listed.

? in the Code represents COLOR.

Replace ? with one of the following: B-Black, S-Silver, W-Gloss White.

Select the Location Code below for your power unit.

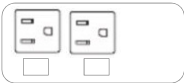

Code: PVL?
(2) power, (2) data jack knockouts
List Price: \$550 per unit

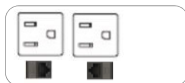

Code: PVL1?
(2) power, (2) data jacks
List Price: \$690 per unit

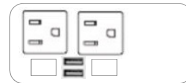

Code: PVLUSB?
(2) power, (2) USB, (2) data jack knockouts
List Price: \$715 per unit



Code: PVL1USB?
(2) power, (2) USB, (2) data jacks
List Price: \$880 per unit



Code: PVPL?
(2) power, (2) data jack knockouts
(2) outlet under the table
List Price: \$635 per unit



Code: PVPL1?
(2) power, (2) data jacks
(2) outlet under the table
List Price: \$770 per unit



Code: PVPLUSB?
(2) power, (2) USB, (1) data jack knockout
(2) outlet under the table
List Price: \$800 per unit



Code: PVPL1USB?
(2) power, (2) USB, (1) data jack
(2) outlet under the table
List Price: \$870 per unit

UNDER TABLE ONLY

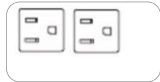

Code: PVUMLB
(2) power
List Price: \$480 per unit

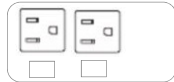

Code: PVUML1B
(2) power, (2) data jack knockouts
List Price: \$505 per unit

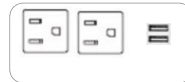

Code: PVUMLUSBB
(2) power, (2) USB
List Price: \$645 per unit

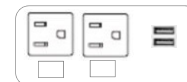

Code: PVUML1USBB
(2) power, (2) USB, (2) data jack knockouts
List Price: \$670 per unit

SPEC SPARATELY HOW MANY FEEDER CABLES YOU NEED FOR YOUR LAYOUT



Code: PSTS72F - Soft wire 72" long List Price \$220 per cable
Code: PSTS96F - Soft wire 96" long List Price \$300 per cable
Code: PSTS108F - Soft wire 108" long List Price \$340 per cable
Code: PSTS120F - Soft wire 120" long List Price \$350 per cable
Code: PSTS144F - Soft wire 144" long List Price \$380 per cable



Code: PSTH72F - Hardwire 72" long List Price \$140 per cable
Code: PSTH96F - Hardwire 96" long List Price \$170 per cable
Code: PSTH108F - Hardwire 108" long List Price \$180 per cable
Code: PSTH120F - Hardwire 120" long List Price \$195 per cable
Code: PSTH144F - Hardwire 144" long List Price \$220 per cable

LOCATION CODES ARE ON PAGE 6

SECLUSION POWER – NON - LINKING

Questions? Call 816-774-4050



Specs: The Seclusion Series is an edge mount unit. Choose from power only, power and USB charging, or power, USB charging, and AV plate cut-out configurations. Units are wired for circuit one and include a 72" long soft wired 15 AMP corded plug.

? in the Code represents COLOR.

Replace ? with one of the following: B-Black, S-Silver, W-Gloss White.

* Premium Upcharge Colors for \$50 list per box are: LG-Light Green, LB-Light Blue, SR-Signal Red, PO –Pure Orange, SY-Sulfur Yellow

Select the Location Code below for your power unit.

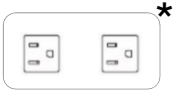

Code: PSE2?
(2) power
List Price: \$290 per unit



Code: PSE1D?
(1) power , (1) data jacks
List Price: \$320 per unit

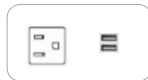

Code: PSE1USB?
(1) power, (2) USB
List Price: \$440 per unit



Code: PSE1USB?
(1) power, (2) USB, (1) AV plate cut-out
List Price: \$440 per unit



Code: PSE3?
(3) power
List Price: \$330 per unit

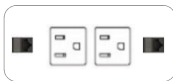

Code: PSE2D2?
(2) power, (2) data jacks
List Price: \$385 per unit



Code: PSE3USB?
(3) power, (2) USB
List Price: \$455 per unit

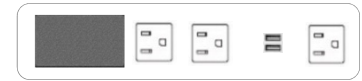

Code: PSE3USB?
(3) power, (2) USB, (1) AV plate cut-out
List Price: \$455 per unit

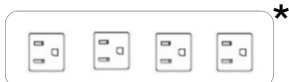

Code: PSE4?
(4) Power
List Price: \$375 per unit



Code: PSE3AV?
(3) power, (1) AV plate cut-out
List Price: \$400 per unit



Code: PSE4USB2?
(4) power, (4) USB
List Price: \$635 per unit



Code: PSE4USB2AV?
(4) power, (4) USB, (1) AV plate cut-out
List Price: \$635 per unit



Code: PSE6?
(6) Power
List Price: \$445 per unit



Code: PSE4AV?
(4) power, (1) AV plate cut-out
List Price: \$440 per unit



Code: PSE5USB?
(5) power, (2) USB
List Price: \$550 per unit

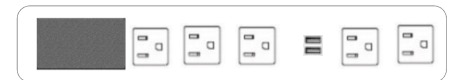

Code: PSE5USB?
(5) power, (2) USB, (1) AV plate cut-out
List Price: \$550 per unit

LOCATION CODES ARE ON PAGE 6

SECLUSION POWER – LINKING

Questions? Call 816-774-4050

Specs: The Seclusion Series is an edge mount unit. Choose from power only, power and USB charging, or power, USB charging, and AV plate cut-out configurations. Units are wired for two circuits and include metal flexible interconnecting cables that mount to the underside of the tops. Starter cable(s) are specified separately.

? in the Code represents COLOR.

Replace ? with one of the following: B-Black, S-Silver

Select the Location Code below for your power unit.

Select AV plates (if needed), AV plates can be found on page 8-9.

Select Type and # of Feeder Starter Cables required



Code: PSEL1D?
 (1) power , (1) data jacks
 List Price: \$665 per unit

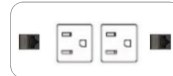

Code: PSEL2D2?
 (2) power, (2) data jacks
 List Price: \$760 per unit

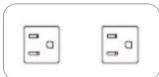

Code: PSEL2?
 (2) power
 List Price: \$665 per unit



Code: PSEL3?
 (3) power
 List Price: \$705 per unit



Code: PSEL3AV?
 (3) power, (1) AV plate cut-out
 List Price: \$790 per unit

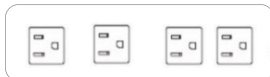

Code: PSEL4?
 (4) Power
 List Price: \$750 per unit

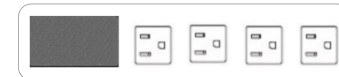

Code: PSEL4AV?
 (4) power, (1) AV plate cut-out
 List Price: \$840 per unit

SPEC SPARATELY HOW MANY FEEDER CABLES YOU NEED FOR YOUR LAYOUT



Code: PSTS72F - Soft wire 72" long List Price \$220 per cable
 Code: PSTS96F - Soft wire 96" long List Price \$300 per cable
 Code: PSTS108F - Soft wire 108" long List Price \$340 per cable
 Code: PSTS120F - Soft wire 120" long List Price \$350 per cable
 Code: PSTS144F - Soft wire 144" long List Price \$380 per cable



Code: PSTH72F - Hardwire 72" long List Price \$140 per cable
 Code: PSTH96F - Hardwire 96" long List Price \$170 per cable
 Code: PSTH108F - Hardwire 108" long List Price \$180 per cable
 Code: PSTH120F - Hardwire 120" long List Price \$195 per cable
 Code: PSTH144F - Hardwire 144" long List Price \$220 per cable

LOCATION CODES ARE ON PAGE 6

INTERACT G2 POWER - NON-LINKING

Questions? Call 816-774-4050



Specs: The Interact G2 Series is designed for small conference areas and meeting rooms. Choose from power or power and USB charging. Both options include (1) AV plate knock-out, (2) data/phone jack knockouts, (2) cord pass throughs and (1) convenience outlet located underneath for added utility power.

Units are wired for circuit one and include 72" hardwire or soft-wired power cords. All table tops include cut-out(s) and are predrilled for units. Some assembly required. The G2 is ETL listed.

? in the Code represents COLOR.

Replace ? with one of the following: B-Black, S-Silver, W-Gloss White.

Select the Location Code below for your power unit.

Select AV plates (if needed), AV plates can be found on page 8-9.

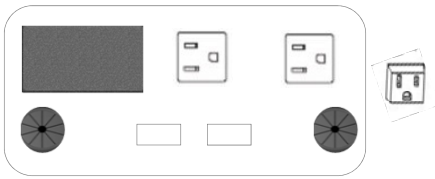

SOFT-WIRED POWER

Code: PIG2S B/S/W

Includes (2) power, (1) AV plate cut-out, (2) data jack knockouts, (2) cord pass throughs, and (1) convenience outlet located on bottom of unit with 72" long soft-wired corded plug. Table tops include cut outs and are pre-drilled.

List Price: \$415 per unit

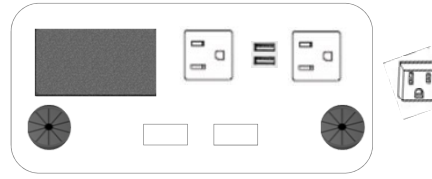

SOFT-WIRED POWER/USB

Code: PIG2USBS B/S/W

Includes (2) power, (2) USB ports, (1) AV plate cut-out, (2) data jack knockouts, (2) cord pass throughs, and (1) convenience outlet located on bottom of unit with 72" long soft-wired corded plug. Table tops include cut outs and are pre-drilled.

List Price: \$580 per unit

HARD-WIRED POWER

Code: PIG2H B/S/W

Includes (2) power, (1) AV plate cut-out, (2) data jack knockouts, (2) cord pass throughs, and (1) convenience outlet located on bottom of unit with 72" long hard-wire cord. Table tops include cut outs and are pre-drilled.

List Price: \$460 per unit

HARD-WIRED POWER

Code: PIG2USBH B/S/W

Includes (2) power, (2) USB ports, (1) AV plate cut-out, (2) data jack knockouts, (2) cord pass throughs, and (1) convenience outlet located on bottom of unit with 72" long hard-wire cord. Table tops include cut outs and are pre-drilled.

List Price: \$635 per unit

LOCATION CODES ARE ON PAGE 6

INTERFACE IITT POWER - NON-LINKING

Questions? Call 816-774-4050



Specs: The Interface II TT Series offers 8 power outlets and 8 AV plates and (1) convenience outlet located underneath for added utility power. Units are wired for circuit one and include 108" long hardwire or soft-wired power cords. Optional feeder cable lengths include 72", 144" or 180" long. All table tops include cut-out(s) and are predrilled for units. Some assembly required.

? in the Code represents COLOR.

Replace ? with one of the following: B-Black, S-Silver

Select the Location Code below for your power unit.

Select AV plates (if needed), AV plates can be found on page 8-9.

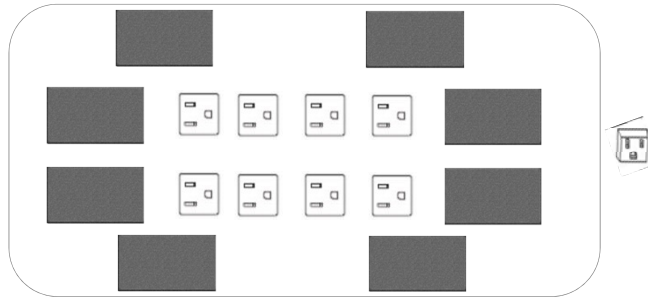

SOFT-WIRED POWER

Code: PIN8S B/S

Includes (8) power, (8) AV plate cut-outs, and (1) convenience outlet located on bottom of unit with 108" long soft-wired corded plug. Table tops include cut outs and are pre-drilled.

List Price: \$1665 per unit

HARD-WIRED POWER

Code: PIN8H B/S

Includes (8) power, (8) AV plate cut-out, and (1) convenience outlet located on bottom of unit with 108" long hard-wired corded plug. Table tops include cut outs and are pre-drilled.

List Price: \$1665 per unit

LOCATION CODES ARE ON PAGE 6

REEF POWER - NON-LINKING AND LINKING

Questions? Call 816-774-4050



Specs: The Reef is a drop in table top units offering capabilities of combining power, USB, data, and additional AV options. It features a retractable lid. Receptacles are 12A, 120 VAC. USB ports are 2.1 AMP. Reef units include (2) data/phone jack knockouts. Data Jacks and AV Plates are specified separately. All table tops include cut-out(s) and are predrilled for units. Some assembly required. UL listed.

Reef non-linking units are wired for circuit one and feature a 108" soft-wire corded plug.

Linking units are wired two circuits and include metal flexible interconnecting cables that mount to the underside of the top.

SPEC SPARATELY HOW MANY FEEDER CABLES YOU NEED FOR YOUR LAYOUT

? in the Code represents COLOR.

Replace ? with one of the following: B-Black, S-Silver, W-Gloss White.

Select the Location Code below for your power unit.

Select Data Jacks or AV plates (if needed), found on page 8-9.

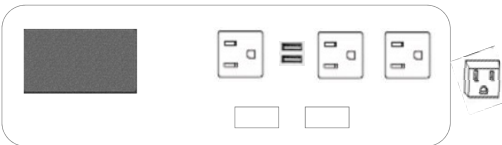

NON-LINKING

Code: PRF3USBAVC?

(3) Power, (2) USB, (1) AV Plate cut-out, (2) data jack knockouts (1) outlets under the table.

List Price: \$1240 per unit

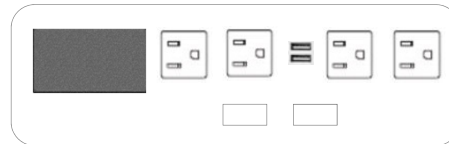

NON-LINKING

Code: PRF4USBAV?

(4) Power, (2) USB, (1) AV Plate cut-out, and (2) data jack knockouts

List Price: \$1240 List



LINKING

Code: PRFL3USBAV?

(3) Power, (2) USB, (1) AV Plate cut-out, (2) data jack knockouts

List Price: \$1840 List

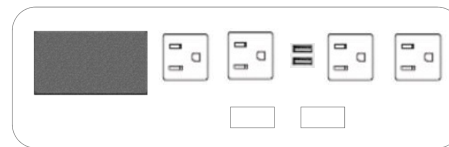

LINKING

Code: PRFL4USBAV?

(4) Power, (2) USB, (1) AV Plate cut-out, and (2) data jack knockouts

List Price: \$1840 List

SPEC SPARATELY HOW MANY FEEDER CABLES YOU NEED FOR YOUR LAYOUT



- Code: PSTS72F - Soft wire 72" long List Price \$220 per cable
- Code: PSTS96F - Soft wire 96" long List Price \$300 per cable
- Code: PSTS108F - Soft wire 108" long List Price \$340 per cable
- Code: PSTS120F - Soft wire 120" long List Price \$350 per cable
- Code: PSTS144F - Soft wire 144" long List Price \$380 per cable



- Code: PSTH72F - Hardwire 72" long List Price \$140 per cable
- Code: PSTH96F - Hardwire 96" long List Price \$170 per cable
- Code: PSTH108F - Hardwire 108" long List Price \$180 per cable
- Code: PSTH120F - Hardwire 120" long List Price \$195 per cable
- Code: PSTH144F - Hardwire 144" long List Price \$220 per cable

LOCATION CODES ARE ON PAGE 6

MINI - OASIS POWER - LINKING

Questions? Call 816-774-4050



Specs: The Mini-Oasis is a drop in table top units offering capabilities of combining power, USB, data, and additional AV options . It features two retractable lids.

Linking units are wired for two circuits and include metal flexible interconnecting cables that mount to the underside of the tops. Data Jacks and AV Plates are specified separately. All table tops include cut-out(s), and cover pan for the underside and are predrilled for units. Some assembly required. UL listed.

SPEC SPARATELY HOW MANY FEEDER CABLES YOU NEED FOR YOUR LAYOUT

? in the Code represents COLOR.

Replace ? with one of the following: B-Black, S-Silver, W-Gloss White.

Select the Location Code below for your power unit.

Select Data Jacks or AV plates (if needed), found on page 8-9.

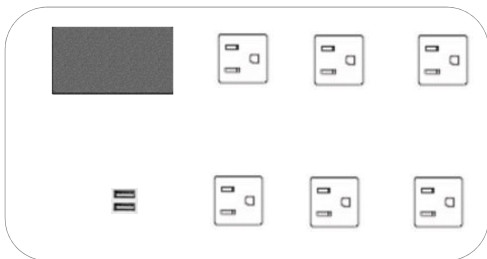

Code: PML6USBAV?
(6) Power, (2) USB, and (1) AV Plate cut-out.

List Price: \$2720 per unit

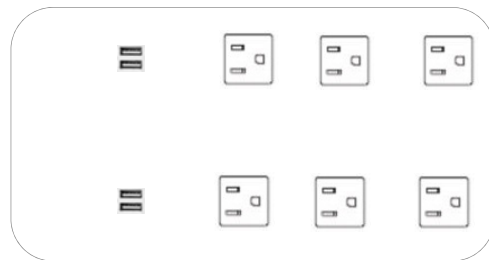

Code: PML6USB2?
(6) Power and (4) USB.

List Price: \$2910 per unit

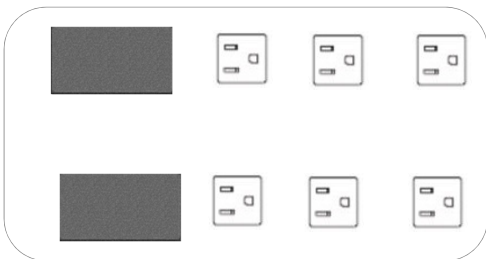

Code: PML6AV2?
(6) Power and (2) AV Plate cut-outs.

List Price: \$2530 per unit

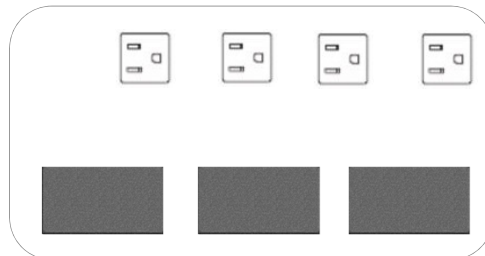

Code: PML4AV3?
(4) Power and (3) AV Plate cut-outs.

List Price: \$2530 per unit

SPEC SPARATELY HOW MANY FEEDER CABLES YOU NEED FOR YOUR LAYOUT



- Code: PSTS72F - Soft wire 72" long List Price \$220 per cable
- Code: PSTS96F - Soft wire 96" long List Price \$300 per cable
- Code: PSTS108F - Soft wire 108" long List Price \$340 per cable
- Code: PSTS120F - Soft wire 120" long List Price \$350 per cable
- Code: PSTS144F - Soft wire 144" long List Price \$380 per cable



- Code: PSTH72F - Hardwire 72" long List Price \$140 per cable
- Code: PSTH96F - Hardwire 96" long List Price \$170 per cable
- Code: PSTH108F - Hardwire 108" long List Price \$180 per cable
- Code: PSTH120F - Hardwire 120" long List Price \$195 per cable
- Code: PSTH144F - Hardwire 144" long List Price \$220 per cable

LOCATION CODES ARE ON PAGE 6

PERFORATED METAL MODESTY PANEL

9" High, 20 gauge steel with a durable powder coat finish. Available in black or silver. Modesty panels are free swinging on all tables. Not available on folding tables. Modesty panel and the underside of the table top are predrilled. Attachment Hardware and assembly instructions are included for field installation. Ganging plate and screws provided for tables longer than 72".

Model Code: MM??

30" table	\$185 list price	48" table	\$230 list price	For 84" tables spec two 42" panels	\$450 list price
36" table	\$190 list price	60" table	\$245 list price	For 96" tables spec two 48" panels	\$460 list price
42" table	\$225 list price	72" table	\$265 list price		

LAMINATED MODESTY PANEL

9" High, .75" thick particle board. Finished with laminate both sides and all edges. Modesty panel and the underside of the table top are predrilled. Attachment Hardware and assembly instructions are included for field installation.

Model Code: ML??

30" table	\$210 list price	48" table	\$250 list price	For 84" tables spec two 42" panels	\$480 list price
36" table	\$230 list price	60" table	\$270 list price	For 96" tables spec two 48" panels	\$500 list price
42" table	\$240 list price	72" table	\$300 list price		

VERTICAL ABS PLASTIC WIRE MANAGEMENT - ROUND

Half round shaped 2.68" x 1", combination of rigid and flexible PVC, vertical wire management. Heavy duty self-adhesive sticky tape is pre-installed on hinged edges of 22" long piece which allows track to conform easily to curved surface. Available in Black or Silver. Field Installed.

Model Code: WVB (black) or WVS (silver) \$25 list price per base

VERTICAL ABS PLASTIC WIRE MANAGEMENT - RECTANGLE

Rectangle shaped 1" x 2", combination of rigid and flexible PVC, vertical wire management. Heavy duty self-adhesive sticky tape is pre-installed on hinged edges of 22" long piece which allows track to conform easily to surface. Available in Black or Silver. Field Installed.

Model Code: WRB (black) or WRS (silver) \$25 list price per base

VERTICAL LASER CUT HOLE WIRE MANAGEMENT

1.5" x 2.5" holes cut in top and bottom of column to feed wire(s) in and out of base.

Model Code: WB \$50 list price per base

HORIZONTAL WIRE MANAGEMENT TRACK

3" x .75" 4-channel wire management track, a co-extrusion with rigid sides and a softer top. Each channel is .75" x .625". In the center of each channel is a slot which has a memory, so it closes back up. Sold in 36" lengths, easily cut to desired length in the field. Features two strips of factory installed double sided tape on each 36" piece. Field Installed.

Model Code: WH \$80 list price per piece

HORIZONTAL CONFERENCE WIRE MANAGEMENT TROUGH

12" wide x 34" long x 6" high 18 gage steel track, with eight 6" access holes, powder coated black. Attachment hardware and installation instructions are included. Field installed.

Model Code: WT \$475 list price per trough

METAL MODESTY PANEL WIRE MANAGEMENT J-CHANNEL

16 gage x 3.5" high x 2.37" deep horizontal J-Channel that hangs on free swinging perforated metal modesty panel. J-Channel simply clips into modesty panel slots, no hardware required. Sits 4.75" below bottom of top. Available in black or silver powder coat. Field Installed.

Model Code: WJ \$210 list price per piece

ROUND WIRE MANAGEMENT GROMMET

2.5" round abs plastic grommet. Tables are drilled out at factory for correct hole size. Insert and cap ship loose and are easily installed, no hardware required. Field installed.

Model code: GS (silver) or GB (black) \$20 list price each



CANYON WIRE MANAGEMENT

All Canyon Bases come standard with two 2" diameter wire management holes located 3" to center of hole from top edge of base, on opposite sides of base to accommodate pass through of wire(s) from base to base or top to base. Optional wire management access door is 8" wide x 10" high and is located starting 2" above bottom of base below one of the wire management holes. Door features a 1" x .75" finger pull and is attached with Velcro to allow easy access of wire(s) and floor receptacle. The 18" bases feature 12" openings in top and bottom and can accommodate up to a regular power box. The 24" bases feature 18" openings in top and bottom and can accommodate up to a Double power box or Mini Oasis.

Model Code: ADCN \$300 list price per door for Canyon bases



UNION WIRE MANAGEMENT

WM2: Union base wire management trough 1.5" deep x 3" wide rectangle 14 gage steel (\$300 list per base)
Steel Wire Management Color: Any HI5 standard powder coat



TABLE GANGER

3.5" diameter 2-piece zinc die-cast table ganger. Simply twist and lock in place. See page 19 for possible configurations and location codes. Sold in sets, which consists of two gangers, four pieces. Attached with #10 x 3/4" screws. Factory installed.

Not available on solid surface table tops or wood edged table tops.

Not available on knife edge profiles.

Model code: TG-LOCATION \$135 list price per set/table

QUICK RELEASE PLATE

Constructed of 11 gage heavy duty steel, the 3" x 6" quick release plates are designed for supporting pie/quarter round shaped tops without a base or ganging larger tables. Simply loosen the hand knobs, slide tables together, tighten hand knobs and tops are joined level and secure. The low profile knob eliminates any conflict between the user and the release mechanism. Inserts are factory installed, plate and knobs are field installed. Plate has a black powder coat finish, knobs are rigid molded plastic.

Available on solid surface table tops and wood edged table tops.

Not available on knife edge profiles.

Model Code: QR \$100 list price each plate

MUTIPLE PIECE TABLES

Tables in multiple pieces require a field joint. Field joints have routed special shaped cut-outs on bottom of top and a grooved edge and use connector bolts and spline material to join tops together. Spline material is inserted into edge to guide and hold pieces together, the connector bolt is inserted into cut-out and tightened until seam is level and tight. Connector bolt is zinc plated, high carbon steel, 3.5" long, threaded about .75" of its length, with 1" cross pieces. Spline material is .125" hardboard cut in 1" widths and various lengths, dependent on table size. Field Installed.

Model Code: FJ \$300 list price each additional joint on tables 10' and under.

*No Up-Charge, standard on tables longer than 10'

FLAT PLATES

3" x 6", .125" thick fixed flat plates are used to provide additional leveling and support on multiple piece tops where there is no base support. Black powder coat finish. Plate, screws, and installation instructions are provided. Field installed.

Model Code: FP \$20 list price each plate

ANTI-SAG BARS

12 gage fabricated steel bar attached to underside of table top. 2" wide, black powder coat finish. Factory installed.

Model code: AS \$100 list price each bar

*Standard on tower collection 60", 66", and 72" tables.



CPU HOLDER - FIXED UNIT

Securely clamps and holds CPU, steel with black epoxy finish. Height adjustment of 13.375" - 20.5".

Model Code: C1 - Width adjustment of 5.5" - 9.25" \$180 List Price Ea

Model Code: C2 - Width adjustment of 2.75" - 5.25" \$180 List Price Ea

CPU HOLDER - SWIVEL UNIT

Securely clamps and holds CPU, steel with black epoxy finish. Height adjustment of 13.375" - 20.5", 360 degrees of swivel and 8.5" of travel provide easy access to connections on the rear of CPU.

Model Code: C3 - Width adjustment of 5.5" - 9.25" \$290 List Price Ea

Model Code: C4 - Width adjustment of 2.75" - 5.25" \$290 List Price Ea



DIVIDER / PRIVACY PANELS

.5" thick clear frosted acrylic panels are 16" high and feature polished edges and through mount hardware.

Tops are provided with pre-drilled holes. Assembly instructions are provided. Field Installed. Model Code:

DPA??

Replace the ?? with the size of panel to complete the divider panel model code. [ex. DPA36 - is for a 36" long divider panel.]

24" panel \$720 list price 48" panel \$1385 list price 84" panel \$2620 list price

30" panel \$970 list price 60" panel \$1495 list price 96" panel \$2625 list price

36" panel \$1025 list price 66" panel \$1550 list price

42" panel \$1380 list price 72" panel \$1905 list price



RADIUS CORNERS

Radius Corners are available in 1", 2", 3", 4" or 5" radius. Due to the limitations of some edge profiles, please consult the factory for edge profile and radius recommendations.

Model Code: RC? Contact Factory for pricing

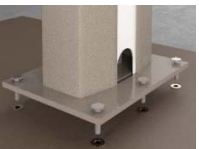

METAL TO METAL CONNECTION

A metal to metal connection is recommended for tables that are dis-assembled and assembled often as the particle board core may weaken and cause stability issues with the bases. 1/4-20 Brass inserts are factory installed and 1/4-20 x 3/4" screws are provided for field installation of bases. Inserts have fins on the outside diameter which provides higher pull-out resistance and prevents splintering and splitting. Model Code: TI

\$100 list price per table



FOLDING TABLE LEG OVER LEG BRACKET

The bracket raises one of the legs of the table so that it will overlap the other leg and fold into the storage position. Aluminum construction, black anodized finish. Two pieces per table are required, (four when used with double T bases), Factory installed.

Tables are not horizontally stackable with riser brackets.

Standard on all folding tables requiring leg over leg application

Model Code:FRC (C Leg) or FRT (T Leg) \$90 list price (C or T leg) FRTT \$160 list price (TT leg)



RECTANGLE FOLDING TABLE CART

Folding Table Cart for Rectangle Tables up to 30 x 72 tables; Flat stack folding table cart. Holds up to 30" wide x 72" long tables. Overall cart dimensions are 74.5"L x 31.5"W x 38"H. Cart weighs 96 lbs. and is black powder coated steel. Each cart holds 4-6 tables. Factory recommends to add customer's own straps to keep tables secure. Model Code: FC-72RE \$2700 list price



Folding Table Cart for Rectangle Tables up to 30 x 96 tables; Flat stack folding table cart. Holds up to 30" wide x 96" long tables. Overall cart dimensions are 105"L x 31.5"W x 38"H. Cart weighs 104 lbs. and is black powder coated steel. Each cart holds 4-6 tables. Factory recommends to add customer's own straps to keep tables secure. Model Code: FC-96RE \$2780 list price

ROUND FOLDING TABLE CART

Folding Table Cart for Round Tables up to 72" round; Edge stack folding table cart. Holds 48", 60" and 72" round folding tables. Overall dimensions are 38.5" wide x 32.75" length x 50" height. Cart weighs 56 lbs and is black powder coated steel. Each cart holds four-six tables. Factory recommends to add customer's own straps to keep tables secure. Model Code: FC-Round \$2500 list price



PUSH BUTTON ADJUSTABLE HEIGHT

The push button adjustable height option is a spring-clip column that allows adjustments in 1" increments. Available in two different ranges and various collections. Available in the following collections: Gateway, Harbor, Liberty, Supreme, and Tower.

Table Height Range: 26" - 35"

C's, T's, and Post legs	Model Code :AHC1, AHT1, AHP1	List Price: \$160 each base
X-Base, Supreme only	Model Code: AHX1	List Price: \$220 each base
TT-Base, Supreme only	Model Code: AHTT	List Price: \$300 each base

Table Height Range: 29" - 42"

C's, T's, and Post legs	Model Code: AHBC1, AHBT1, AHBP1	List Price: \$220 each base
X-Base, Supreme only	Model Code: AHX1	List Price: \$280 each base
TT-Base, Supreme only	Model Code: AHTT	List Price: \$430 each base

HAND CRANK ADJUSTABLE HEIGHT

Adjustment at the turn of the handle. Available in the Liberty and the Empire collections



Empire - Screw thread adjustment with infinite stop positions. Adjust with manual crank handle at a rate of 6-1/3 turns per inch (4mm pitch). Table height range of 9.5", 27.25" - 36.75". Handle slides under table when not in use. Maximum lifting load of 180 pounds for single column and 225 pounds for two columns, maximum of three (3) columns adjusted from one crank handle. Option for Locking Casters is available which adds 2" to starting height.

PNEUMATIC ADJUSTABLE HEIGHT

Pneumatic adjustment with easy lever release. Available in the Empire Collection only.



Pneumatic cylinder assist with infinite stop positions with no-bounce cylinder stop. Steel roller glide system. Unintentional-release resistant lever with cable release. Table height range of 17.7", 27.25"h to 45"h. Range Lifting force of forty four (44) pounds standard. Additional lifting forces are available, Contact Factory for information. Available options include Flip-top and Locking Casters. Locking Casters add 2" to starting height.

ELECTRIC ADJUSTABLE HEIGHT

Electric motor adjustment at the touch of a switch. Available in the Liberty and Empire collections



Empire - Infinite stop positions with adjustment speed of 1.97" per second (50mm/sec). Two table height ranges to choose from: 19.69" of range, 27.25"h to 46.94"h or 26" of range, 22.25"h to 48.25"h. Simple up and down buttons, control up to 12 columns from a single keypad. Maximum lifting force of 225 pounds for two columns. Options and accessories include: Built-in Key pad w/display, Built-in memory keypad with display, key pad cable extensions, motor cable extensions, Link Cables, and safety sensors.



ROUND & SQUARE FLIP TOP NESTING MECHANISM

Construction consists of 11 gauge stamped steel - Used on 42" and 48" flip-top nesting tables. Tops are predrilled for mechanism, field installed.

No Upcharge-Standard

Note: 42" square is maximum size available in the Gateway Collection.



DUAL FLIP TOP NESTING MECHANISM

Consists of two latch assemblies designed to latch table in setup position, lever arm designed to support top in flipped position. Latches and lever arm factory installed in recessed pockets in top. Mounting plates are 5" x 11" x .25" steel, Top and Base supports are two 5.5" wide aluminum extrusions, length dependent upon table size. Extrusions are finished with a black powder coat, latches and lever have a durable black epoxy finish to match.

No Upcharge-Standard on all dual flip top tables

Island Base Placement Options

www.hi5furniture.com Questions? 816-774-4050

March 1, 2018

18 x 60

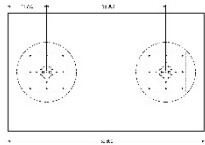

24 x 60

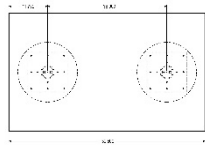

30 x 60

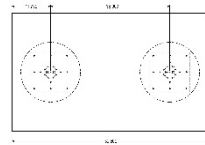

36 x 60

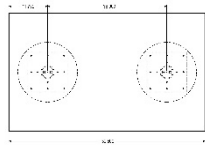

18 x 72

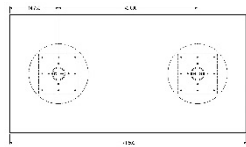

24 x 72

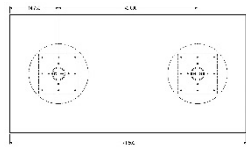

30 x 72

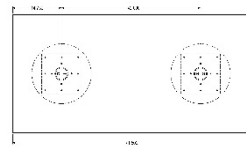

36 x 72

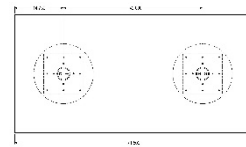

18 x 84

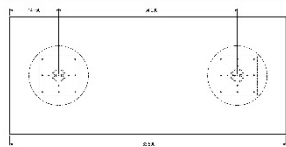

24 x 84

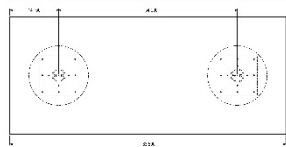

30 x 84

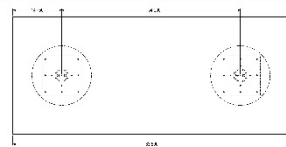

36 x 84

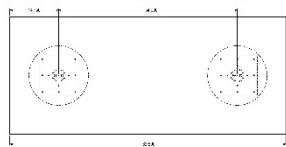

18 x 96

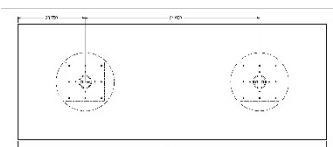

24 x 96

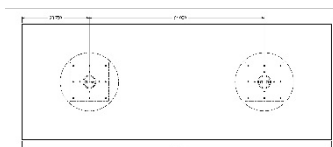

30 x 96

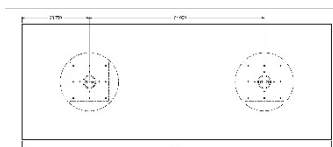

36 x 96

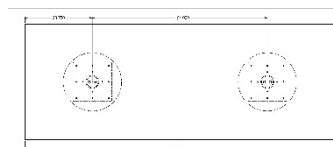

18 x 120

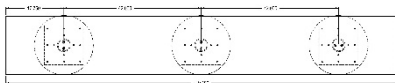

24 x 120

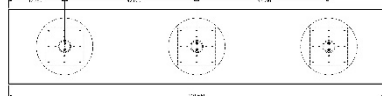

30 x 120

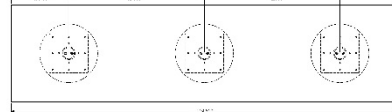

36 x 120

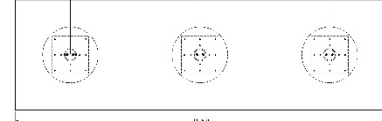



FINISHES NEEDED: <http://hi5furniture.com/finishes/>
HPL Top: Hi5 Graded-in laminates or Non-Premium Wilsonart or Formica
Edge Color: Any Hi5 standard
Base Finish: Any Hi5 standard

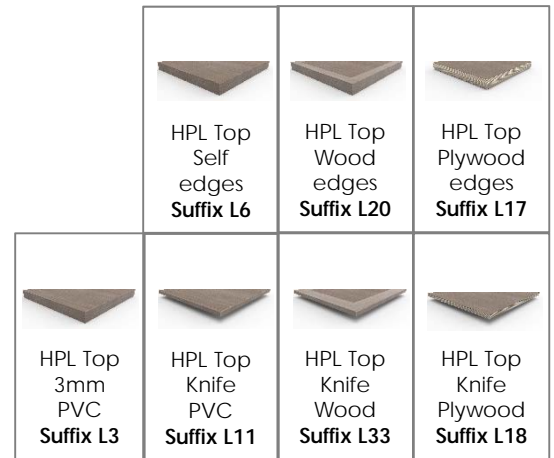
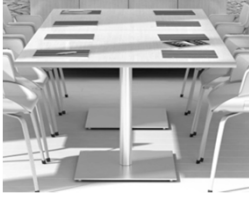

Table Size	Top Shape	Base Shape	Model Code:	Top QTY	Base QTY	Base Size	Column Size	List Price	List Price	List Price
24 x 29" H	ROUND	Round Base	IDD1 2429RD S	1	1	18"	4"	\$1,045	\$1,180	\$1,555
24 x 29" H	ROUND	Square Base	IDQ1 2429RD S	1	1	18"	4"	\$1,345	\$1,470	\$1,520
30 x 29" H	ROUND	Round Base	IDD1 3029RD S	1	1	18"	4"	\$1,090	\$1,275	\$1,740
30 x 29" H	ROUND	Square Base	IDQ1 3029RD S	1	1	18"	4"	\$1,415	\$1,550	\$1,755
36 x 29" H	ROUND	Round Base	IDD1 3629RD S	1	1	18"	4"	\$1,230	\$1,380	\$1,980
36 x 29" H	ROUND	Square Base	IDQ1 3629RD S	1	1	18"	4"	\$1,495	\$1,625	\$2,110
42 x 29" H	ROUND	Round Base	IDD1 4229RD S	1	1	24"	4"	\$1,530	\$1,620	\$2,410
42 x 29" H	ROUND	Square Base	IDQ1 4229RD S	1	1	24"	4"	\$1,670	\$1,810	\$2,800
48 x 29" H	ROUND	Round Base	IDD1 4829RD S	1	1	24"	4"	\$1,780	\$2,010	\$2,960
48 x 29" H	ROUND	Square Base	IDQ1 4829RD S	1	1	24"	6"	\$1,680	\$1,815	\$3,180
60 x 29" H	ROUND	Round Base	IDD1 6029RD S	1	1	32"	6"	\$2,525	\$2,675	\$4,960

POWER & A/V OPTIONS SEE PAGES 8-20

TABLE OPTIONS:

Add Levelers – Raises base 1" off of the floor	LV	\$80 per table
Bar Height on round bases (overall table height is 42")	BH	\$90 per table
Bar Height on square bases (overall table height is 42")	BH	\$150 per table
Café Height on round bases (overall table height is 36")	CH	\$90 per table
Café Height on square bases (overall table height is 36")	CH	\$150 per table
Alternate table height shorter than 29"	SC	\$90 per table
Alternate table height taller than 29"	TC	\$130 per table
Adjustable height (spring clip)	AH	\$280 per table
Polished Chrome on 18" and 24" round bases	CR	\$225 per table



FINISHES NEEDED: <http://hi5furniture.com/finishes/>
HPL Top: Hi5 Graded-in laminates or Non-Premium Wilsonart or Formica
Edge Color: Any Hi5 standard
Base Finish: Any Hi5 standard

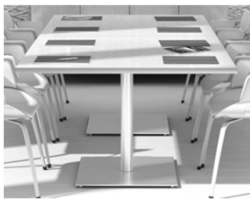

Table Size	Top Shape	Base Shape	Model Code:	Top QTY	Base QTY	Base Size	Column Size	List Price	List Price	List Price
24 x 24 x 29" H	SQUARE	Round Base	IDD1 242429SQ S	1	1	18"	4"	\$960	\$1,090	\$1,440
24 x 24 x 29" H	SQUARE	Square Base	IDQ1 242429SQ S	1	1	18"	4"	\$1,285	\$1,345	\$1,415
30 x 30 x 29" H	SQUARE	Round Base	IDD1 303029SQ S	1	1	18"	4"	\$1,015	\$1,175	\$1,635
30 x 30 x 29" H	SQUARE	Square Base	IDQ1 303029SQ S	1	1	18"	4"	\$1,355	\$1,420	\$1,680
36 x 36 x 29" H	SQUARE	Round Base	IDD1 363629SQ S	1	1	24"	4"	\$1,260	\$1,410	\$2,005
36 x 36 x 29" H	SQUARE	Square Base	IDQ1 363629SQ S	1	1	24"	4"	\$1,585	\$1,660	\$2,170
42 x 42 x 29" H	SQUARE	Round Base	IDD1 424229SQ S	1	1	24"	4"	\$1,555	\$1,865	\$2,655
42 x 42 x 29" H	SQUARE	Square Base	IDQ1 424229SQ S	1	1	24"	4"	\$1,610	\$1,695	\$2,690
48 x 48 x 29" H	SQUARE	Round Base	IDD1 484829SQ S	1	1	28"	4"	\$1,620	\$1,910	\$2,850
48 x 48 x 29" H	SQUARE	Square Base	IDQ1 484829SQ S	1	1	24"	6"	\$1,850	\$1,940	\$3,235

POWER & A/V OPTIONS SEE PAGES 8-20

TABLE OPTIONS:

Add Levelers – Raises base 1" off of the floor	LV	\$80 per table
Bar Height on round bases (overall table height is 42")	BH	\$90 per table
Bar Height on square bases (overall table height is 42")	BH	\$150 per table
Café Height on round bases (overall table height is 36")	CH	\$90 per table
Café Height on square bases (overall table height is 36")	CH	\$150 per table
Alternate table height shorter than 29"	SC	\$90 per table
Alternate table height taller than 29"	TC	\$130 per table
Adjustable height (spring clip)	AH	\$280 per table
Polished Chrome on 18" and 24" round bases	CR	\$225 per table



FINISHES NEEDED: <http://hi5furniture.com/finishes/>
HPL Top: Hi5 Graded-in laminates or Non-Premium Wilsonart or Formica
Edge Color: Any Hi5 standard
Base Finish: Any Hi5 standard

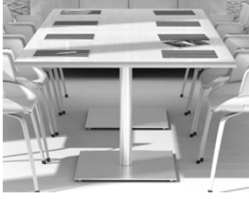

Table Size	Top Shape	Base Shape	Model Code:	Top QTY	Base QTY	Base Size	Column Size	List Price	List Price	List Price
18 x 48 x 29" H Rectangle	Round Base	Round Base	IDD1 184829RES	1	2	18"	4"	\$1,820	\$1,940	\$2,140
18 x 48 x 29" H Rectangle	Square Base	Square Base	IDQ1 184829RES	1	2	18"	4"	\$2,225	\$2,300	\$2,825
18 x 60 x 29" H Rectangle	Round Base	Round Base	IDD1 186029RES	1	2	18"	4"	\$1,880	\$2,010	\$2,250
18 x 60 x 29" H Rectangle	Square Base	Square Base	IDQ1 186029RES	1	2	18"	4"	\$2,310	\$2,390	\$3,060
18 x 72 x 29" H Rectangle	Round Base	Round Base	IDD1 187229RES	1	2	18"	4"	\$1,925	\$2,075	\$2,365
18 x 72 x 29" H Rectangle	Square Base	Square Base	IDQ1 187229RES	1	2	18"	4"	\$2,385	\$2,480	\$3,315
18 x 84 x 29" H Rectangle	Round Base	Round Base	IDD1 188429RES	1	2	18"	4"	\$2,025	\$2,140	\$2,480
18 x 84 x 29" H Rectangle	Square Base	Square Base	IDQ1 188429RES	1	2	18"	4"	\$2,425	\$2,525	\$3,780
18 x 96 x 29" H Rectangle	Round Base	Round Base	IDD1 189629RES	1	2	18"	4"	\$2,040	\$2,210	\$2,725
18 x 96 x 29" H Rectangle	Square Base	Square Base	IDQ1 189629RES	1	2	18"	4"	\$2,430	\$2,545	\$3,795
18 x 120 x 29" H Rectangle	Round Base	Round Base	IDD1 1812029RES	1	2	18"	4"	\$2,345	\$2,480	\$4,040
18 x 120 x 29" H Rectangle	Square Base	Square Base	IDQ1 1812029RES	1	2	18"	4"	\$2,565	\$2,700	\$4,260

POWER & A/V OPTIONS SEE PAGES 8-20

TABLE OPTIONS:

Add Levelers – Raises base 1" off of the floor	LV	\$80 per table
Bar Height on round bases (overall table height is 42")	BH	\$90 per table
Bar Height on square bases (overall table height is 42")	BH	\$150 per table
Café Height on round bases (overall table height is 36")	CH	\$90 per table
Café Height on square bases (overall table height is 36")	CH	\$150 per table
Alternate table height shorter than 29"	SC	\$90 per table
Alternate table height taller than 29"	TC	\$130 per table
Adjustable height (spring clip)	AH	\$280 per table
Polished Chrome on 18" and 24" round bases	CR	\$225 per table



FINISHES NEEDED: <http://hi5furniture.com/finishes/>
HPL Top: Hi5 Graded-in laminates or Non-Premium Wilsonart or Formica
Edge Color: Any Hi5 standard
Base Finish: Any Hi5 standard

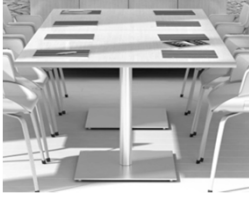

Table Size	Top Shape	Base Shape	Model Code:	Top QTY	Base QTY	Base Size	Column Size	List Price	List Price	List Price
24 x 30 x 29" H Rectangle	Round Base	Round Base	IDD1 243029RES	1	1	18"	4"	\$985	\$1,125	\$1,390
24 x 30 x 29" H Rectangle	Square Base	Square Base	IDQ1 243029RES	1	1	18"	4"	\$1,295	\$1,355	\$1,530
24 x 36 x 29" H Rectangle	Round Base	Round Base	IDD1 243629RES	1	1	18"	4"	\$1,010	\$1,170	\$1,490
24 x 36 x 29" H Rectangle	Square Base	Square Base	IDQ1 243629RES	1	1	18"	4"	\$1,305	\$1,365	\$1,650
24 x 42 x 29" H Rectangle	Round Base	Round Base	IDD1 244229RES	1	1	24"	4"	\$1,170	\$1,350	\$1,735
24 x 42 x 29" H Rectangle	Square Base	Square Base	IDQ1 244229RES	1	1	24"	4"	\$1,470	\$1,535	\$1,965
24 x 48 x 29" H Rectangle	Round Base	Round Base	IDD1 244829RES	1	2	18"	4"	\$1,840	\$2,020	\$2,450
24 x 48 x 29" H Rectangle	Square Base	Square Base	IDQ1 244829RES	1	2	18"	4"	\$2,250	\$2,325	\$2,825
24 x 60 x 29" H Rectangle	Round Base	Round Base	IDD1 246029RES	1	2	18"	4"	\$1,890	\$2,100	\$2,630
24 x 60 x 29" H Rectangle	Square Base	Square Base	IDQ1 246029RES	1	2	18"	4"	\$2,335	\$2,415	\$3,060
24 x 72 x 29" H Rectangle	Round Base	Round Base	IDD1 247229RES	1	2	18"	4"	\$1,930	\$2,185	\$2,820
24 x 72 x 29" H Rectangle	Square Base	Square Base	IDQ1 247229RES	1	2	18"	4"	\$2,410	\$2,505	\$3,315
24 x 84 x 29" H Rectangle	Round Base	Round Base	IDD1 248429RES	1	2	18"	4"	\$2,035	\$2,265	\$3,015
24 x 84 x 29" H Rectangle	Square Base	Square Base	IDQ1 248429RES	1	2	18"	4"	\$2,450	\$2,545	\$3,780
24 x 96 x 29" H Rectangle	Round Base	Round Base	IDD1 249629RES	1	2	18"	4"	\$2,045	\$2,355	\$3,195
24 x 96 x 29" H Rectangle	Square Base	Square Base	IDQ1 249629RES	1	2	18"	4"	\$2,455	\$2,570	\$3,795
24 x 120 x 29" H Rectangle	Round Base	Round Base	IDD1 2412029RES	1	2	18"	4"	\$2,370	\$2,505	\$4,040
24 x 120 x 29" H Rectangle	Square Base	Square Base	IDQ1 2412029RES	1	2	18"	4"	\$2,590	\$2,725	\$4,260

POWER & A/V OPTIONS SEE PAGES 8-20

TABLE OPTIONS:

Add Levelers – Raises base 1" off of the floor	LV	\$80 per table
Bar Height on round bases (overall table height is 42")	BH	\$90 per table
Bar Height on square bases (overall table height is 42")	BH	\$150 per table
Café Height on round bases (overall table height is 36")	CH	\$90 per table
Café Height on square bases (overall table height is 36")	CH	\$150 per table
Alternate table height shorter than 29"	SC	\$90 per table
Alternate table height taller than 29"	TC	\$130 per table
Adjustable height (spring clip)	AH	\$280 per table
Polished Chrome on 18" and 24" round bases	CR	\$225 per table



FINISHES NEEDED: <http://hi5furniture.com/finishes/>
HPL Top: Hi5 Graded-in laminates or Non-Premium Wilsonart or Formica
Edge Color: Any Hi5 standard
Base Finish: Any Hi5 standard



Table Size	Top Shape	Base Shape	Model Code:	Top QTY	Base QTY	Base Size	Column Size	List Price	List Price	List Price
30 x 36 x 29" H Rectangle	Round Base	Round Base	IDD1 303629RES	1	1	24"	4	\$1,350	\$1,415	\$1,870
30 x 36 x 29" H Rectangle	Square Base	Square Base	IDQ1 303629RES	1	1	18"	4	\$1,315	\$1,380	\$1,835
30 x 48 x 29" H Rectangle	Round Base	Round Base	IDD1 304829RES	1	1	24"	4	\$1,235	\$1,445	\$2,085
30 x 48 x 29" H Rectangle	Square Base	Square Base	IDQ1 304829RES	1	1	18"	4	\$1,390	\$1,470	\$2,130
30 x 60 x 29" H Rectangle	Round Base	Round Base	IDD1 306029RES	1	2	18"	4	\$1,930	\$2,190	\$3,060
30 x 60 x 29" H Rectangle	Square Base	Square Base	IDQ1 306029RES	1	2	18"	4	\$2,420	\$2,510	\$3,365
30 x 72 x 29" H Rectangle	Round Base	Round Base	IDD1 307229RES	1	2	18"	4	\$1,985	\$2,300	\$3,275
30 x 72 x 29" H Rectangle	Square Base	Square Base	IDQ1 307229RES	1	2	18"	4	\$2,515	\$2,620	\$3,680
30 x 84 x 29" H Rectangle	Round Base	Round Base	IDD1 308429RES	1	2	18"	4	\$2,105	\$2,395	\$3,480
30 x 84 x 29" H Rectangle	Square Base	Square Base	IDQ1 308429RES	1	2	18"	4	\$2,545	\$2,655	\$4,260
30 x 96 x 29" H Rectangle	Round Base	Round Base	IDD1 309629RES	1	2	18"	4	\$2,120	\$2,500	\$3,690
30 x 96 x 29" H Rectangle	Square Base	Square Base	IDQ1 309629RES	1	2	18"	4	\$2,560	\$2,680	\$4,285
30 x 120 x 29" HRectangle	Round Base	Round Base	IDD1 3012029RES	1	2	18"	4	\$2,495	\$2,640	\$4,670
30 x 120 x 29" HRectangle	Square Base	Square Base	IDQ1 3012029RES	1	2	18"	4	\$2,710	\$2,855	\$4,890

POWER & A/V OPTIONS SEE PAGES 8-20

TABLE OPTIONS:

Add Levelers – Raises base 1" off of the floor	LV	\$80 per table
Bar Height on round bases (overall table height is 42")	BH	\$90 per table
Bar Height on square bases (overall table height is 42")	BH	\$150 per table
Café Height on round bases (overall table height is 36")	CH	\$90 per table
Café Height on square bases (overall table height is 36")	CH	\$150 per table
Alternate table height shorter than 29"	SC	\$90 per table
Alternate table height taller than 29"	TC	\$130 per table
Adjustable height (spring clip)	AH	\$280 per table
Polished Chrome on 18" and 24" round bases	CR	\$225 per table



FINISHES NEEDED: <http://hi5furniture.com/finishes/>
HPL Top: Hi5 Graded-in laminates or Non-Premium Wilsonart or Formica
Edge Color: Any Hi5 standard
Base Finish: Any Hi5 standard

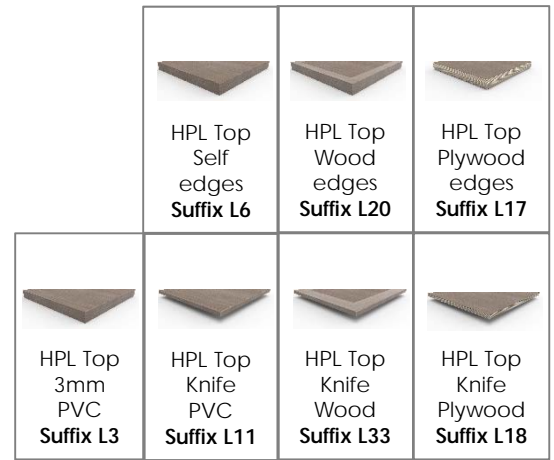

Table Size	Top Shape	Base Shape	Model Code:	Top QTY	Base QTY	Base Size	Column Size	List Price	List Price	List Price
36 x 48 x 29" H Rectangle	Round Base	Round Base	IDD1 364829RES	1	1	28"	4	\$1,590	\$1,760	\$2,530
36 x 48 x 29" H Rectangle	Square Base	Square Base	IDQ1 364829RES	1	1	18"x28"	6	\$1,825	\$1,910	\$2,715
36 x 60 x 29" H Rectangle	Round Base	Round Base	IDD1 366029RES	1	2	18"	4	\$2,325	\$2,530	\$3,540
36 x 60 x 29" H Rectangle	Square Base	Square Base	IDQ1 366029RES	1	2	18"	4	\$2,530	\$2,625	\$3,660
36 x 72 x 29" H Rectangle	Round Base	Round Base	IDD1 367229RES	1	2	18"	4	\$2,410	\$2,650	\$3,795
36 x 72 x 29" H Rectangle	Square Base	Square Base	IDQ1 367229RES	1	2	18"	4	\$2,640	\$2,755	\$4,035
36 x 84 x 29" H Rectangle	Round Base	Round Base	IDD1 368429RES	1	2	18"	4	\$2,590	\$2,765	\$4,520
36 x 84 x 29" H Rectangle	Square Base	Square Base	IDQ1 368429RES	1	2	18"	4	\$2,890	\$3,045	\$4,735
36 x 96 x 29" H Rectangle	Round Base	Round Base	IDD1 369629RES	1	2	18"	4	\$2,610	\$2,885	\$4,290
36 x 96 x 29" H Rectangle	Square Base	Square Base	IDQ1 369629RES	1	2	18"	4	\$2,905	\$3,060	\$4,765
36 x 120 x 29" HRectangle	Round Base	Round Base	IDD1 3612029RES	1	2	18"	4	\$2,910	\$3,105	\$5,295
36 x 120 x 29" HRectangle	Square Base	Square Base	IDQ1 3612029RES	1	2	18"	4	\$3,130	\$3,320	\$5,510

POWER & A/V OPTIONS SEE PAGES 8-20

TABLE OPTIONS:

Add Levelers – Raises base 1" off of the floor	LV	\$80 per table
Bar Height on round bases (overall table height is 42")	BH	\$90 per table
Bar Height on square bases (overall table height is 42")	BH	\$150 per table
Café Height on round bases (overall table height is 36")	CH	\$90 per table
Café Height on square bases (overall table height is 36")	CH	\$150 per table
Alternate table height shorter than 29"	SC	\$90 per table
Alternate table height taller than 29"	TC	\$130 per table
Adjustable height (spring clip)	AH	\$280 per table
Polished Chrome on 18" and 24" round bases	CR	\$225 per table