



**RAVEN TABLE OF CONTENTS**

Raven Specifications .....	2
Raven Banquette Options.....	3
Raven Banquette Pricing.....	4
Raven Banquette Privacy Panel Pricing.....	8
Raven Modular Options.....	9
Raven Modular Pricing.....	10
Raven Modular Privacy Panel Pricing.....	14
Raven Modular Backless Units.....	17
Raven Modular Individual Arms .....	19
Raven Modular Configurations .....	20
Raven Ottomans.....	22
Raven Benches .....	25
Raven Lounge Options .....	26
Raven Lounge Pricing.....	27
Raven Junior .....	28

**RAVEN**

The Raven series offers an extensive variety of shapes and designs to fit a multitude of areas. The banquettes come in three different back heights, a choice of wood or metal legs or a plinth base, and a variety of privacy panels. The modular units offers straight or curved units to create fun configurations, in any open space. This series also offers ottomans, lounge chairs and is complemented with curio side tables, to adapt to any design you dream up. Designed for higher education and any public space that requires long duration seating with comfort.



BANQUETTE



MODULAR



LOUNGE



OTTOMAN



CHILDREN'S

**ORDERING INFORMATION**

- 1) Series Name
- 2) Model Number
- 3) Quantity
- 4) Fabric Grade & Number
- 5) Panel Laminate/Edge Selection
- 6) Optional Items/Colors

**RAVEN SPECIFICATIONS**

**Frame Construction**

Frame assembly is constructed of multi-ply hardwood, with tongue and groove construction. All foam is fully bonded to frame. Seat cushions are 4" graded high resiliency (H.R.) block foam with back 3" (H.R.) foam, covered entirely with special bonded polyester fiber to protect final upholstery. No sag-springs are installed in seat & back along with interlocking helicoil springs to prevent sagging and provide additional lower back and seat support.

**Upholstery**

Seat and back are covered in choice of fabric, vinyl, crypton, leather or COM. ERG uses only water based glues and adhesives in our upholstery process.

**Legs**

2"RD X 3"H round tubular steel legs are standard and available in standard powder coat colors. Optional polished chrome and wood legs are also available. Legs have a factory installed poly vinyl glide.

**Optional Plinth Base (Available only on Banquettes)**

The optional base is available in a choice of laminate or unfinished so that you can add your own cover base or carpet (**clean out not available with plinth**)

**Anchoring**

Raven Banquettes are easy to anchor to the floor. Floor mount instructions can be provided by customer service. Hardware for anchoring bench to the floor is not included.

**Note for Edge of privacy panels:**

- Straight panels: available with 3MM PVC or laminate self edge. Select from any of our 3MM PVC edges in solid or wood tone, no custom colors available.
- Curved panels: will only able available with laminate self edge.
- Both straight and curved panels: when combining straights and curved, ONLY self edge is available.



LOW BACK  
27"



STANDARD BACK  
33"



HIGH BACK  
42"

Available on  
Banquette  
ONLY

SOFT SEATING	WEIGHT LIMIT
1 Seat	500 lbs.
2 Seat	1000 lbs.
3 Seat	1500 lbs.

*Raven Banquette  
Available in 3 heights  
27", 33" or 42"*

**OPTIONS**

- CODE: FR - CAL 133 (TB 133) Fire Retardant
- CODE: MB -Moisture Barrier (up to 60" overall width)
- CODE: MB60 -Moisture Barrier (over 60" overall width)
- CODE: MBB -Moisture Barrier (up to 60" overall width Back-to-Back)
- CODE: MBB60 -Moisture Barrier (over 60" overall width Back-to-Back)
- CODE: LOW - Fully Upholstered Low Back - 27" OA Height
- CODE: WOD - Wood Legs
- CODE: PC - Polished Chrome Legs
- CODE: CAS2 - 2" Black Casters
- CODE: CAS3 - 3" Casters
- CODE: 2FO - Two Fabric Option
- CODE: GD1 - Ratchet Ganging Device for Soft Seating
- CODE: GD2 - Flat Ganging Device for Soft Seating
- CODE: GBP - Ganging Brackets For Plinth Base
- CODE: CO - Clean Out (overall width up to 60")
- CODE: CO1 - Clean Out (overall width over 60")
- CODE: COB - Clean Out Back-to-Back (overall width up to 60")
- CODE: CO1B - Clean Out Back-to-Back (overall width over 60")
- CODE: FM - Floor Mount Tabs
- CODE: PB48 - Plinth Base - up to 48"
- CODE: PB72 - Plinth Base - 49" to 72"
- CODE: PB48B - Plinth Base - up to 48" back-to-back
- CODE: PB72B - Plinth Base - 49" to 72" back-to-back
- CODE: UFB - Unfinished Plinth Base
- CODE: RB1 - Recessed Plinth Base (1 Side only)
- CODE: RB2 - Recessed Plinth Base (2 Sides)



POLISHED CHROME LEGS



WOOD LEGS



TWO FABRIC OPTION



CLEANOUT

**PLINTH BASE**

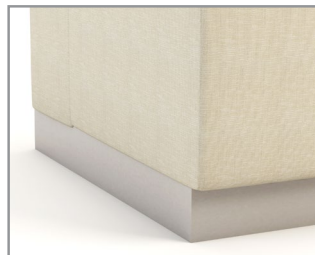

BANQUETTE COMES STANDARD WITH FLUSH SIDES FOR GANGING AND RECESSED FRONT

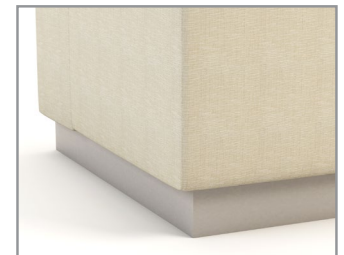

BANQUETTE HAS OPTIONAL RECESSED PLINTH BASE ON ONE OR TWO SIDES

**Note: clean out options not available on plinth base units.**

DIMENSIONS	Straight Banquette
Seat Depth:	20"
Seat Height:	18"
Overall Depth:	27"
Overall Width:	48, 60, 72"
Overall Height:	33"
Qty./Wt.:	1 ea./150 lbs.



RAVEN BANQUETTE WITH  
OPTIONAL PLINTH BASE AND  
POWER/DATA UNIT

**MODEL / DESCRIPTION / LIST PRICING**

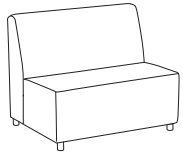

**8372** 48"W Straight Banquette (4 legs)

COM Yardage: Total: 7 Yds. / Back: 4 Yds. / Seat: 3 Yds.

COM	GR1	GR2	GR3	GR4	GR5	GR6	GR7	GR8	GR9	GR10	LEA
\$2226	\$2395	\$2560	\$2725	\$2894	\$3059	\$3227	\$3393	\$3561	\$3726	\$3894	\$4055

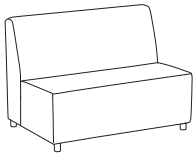

**8374** 60"W Straight Banquette (4 legs)

COM Yardage: Total: 9 Yds. / Back: 5 Yds. / Seat: 4 Yds.

COM	GR1	GR2	GR3	GR4	GR5	GR6	GR7	GR8	GR9	GR10	LEA
\$2783	\$2991	\$3199	\$3408	\$3616	\$3826	\$4033	\$4243	\$4450	\$4659	\$4868	\$5068

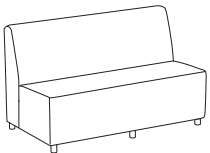

**8376** 72"W Straight Banquette (6 legs)

COM Yardage: Total: 11 Yds. / Back: 6 Yds. / Seat: 5 Yds.

COM	GR1	GR2	GR3	GR4	GR5	GR6	GR7	GR8	GR9	GR10	LEA
\$3499	\$3748	\$3999	\$4248	\$4499	\$4750	\$4999	\$5250	\$5499	\$5749	\$6000	\$6240

Note: clean out options not available on plinth base units.

**OPTIONS**

Add upcharge to list price and code to model number

FR	CAL 133 (TB 133) Fire Retardant per yard	\$101	/yd.
MB	Moisture Barrier - up to 60" width	\$141	ea.
MB60	Moisture Barrier - over 60" width	\$225	ea.
LOW	Fully Upholstered Low Back - 27" OA Height	\$107	per unit
WOD	Wood Legs	\$27	ea.
PC	Polished Chrome Legs	\$29	ea.
CAS3	3" Casters	\$29	ea.
2FO	Two Fabric Option	\$110	
GD1	Ganging Device for Metal/Wood Legs	\$58	
GD2	Flat Ganging Device for Soft Seating	\$58	
GBP	Ganging Bracket for Plinth Base	\$124	

CO	Clean Out (overall width up to 60")	\$281	
CO1	Clean Out (overall width over 60")	\$432	
FM	Floor Mount	\$110	
PB48	Plinth Base - Up To 48"	\$213	
PB72	Plinth Base - 49" to 72"	\$359	
UFB	Unfinished Plinth Base (deduct from plinth option)	Deduct \$80	
RB1	Recessed Base, 1 side	\$124	
RB2	Recessed Base, 2 sides	\$247	

DIMENSIONS	Back-to-Back Banquette
Seat Depth:	20"
Seat Height:	18"
Overall Depth:	55"
Overall Width:	48, 60, 72"
Overall Height:	33"
Qty./Wt.:	1 ea./280 lbs.



BACK-TO-BACK BANQUETTE  
WITH OPTIONAL CLEANOUT

**MODEL / DESCRIPTION / LIST PRICING**



**8380** 48"W Back-to-Back Banquette (6 legs)

COM Yardage: Total: 8 Yds. / Back: 3 Yds. / Seat: 5 Yds.

COM	GR1	GR2	GR3	GR4	GR5	GR6	GR7	GR8	GR9	GR10	LEA
\$4230	\$4547	\$4864	\$5179	\$5498	\$5813	\$6131	\$6447	\$6766	\$7081	\$7399	\$7704



**8382** 60"W Back-to-Back Banquette (6 legs)

COM Yardage: Total: 11 Yds. / Back: 5 Yds. / Seat: 6 Yds.

COM	GR1	GR2	GR3	GR4	GR5	GR6	GR7	GR8	GR9	GR10	LEA
\$5288	\$5684	\$6078	\$6474	\$6872	\$7268	\$7665	\$8060	\$8455	\$8852	\$9247	\$9628

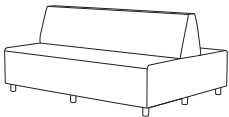

**8384** 72"W Back-to-Back Banquette (8 legs)

COM Yardage: Total: 13 Yds. / Back: 6 Yds. / Seat: 7 Yds.

COM	GR1	GR2	GR3	GR4	GR5	GR6	GR7	GR8	GR9	GR10	LEA
\$6505	\$6979	\$7455	\$7929	\$8404	\$8882	\$9356	\$9829	\$10306	\$10780	\$11258	\$11714

Note: To order Back to Back banquettes with privacy panel, the order will consist of two single straight units and privacy panel. The overall depth of these combined units with panel is 55". See page 8 for panel specs.

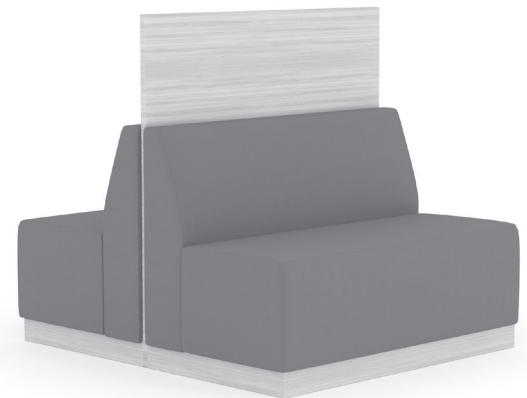

**Note: clean out options not available on plinth base units.**

**OPTIONS**

Add upcharge to list price and code to model number

FR	CAL 133 (TB 133) Fire Retardant per yard	\$101	/yd.
MBB	Moisture Barrier - up to 60" width (Back-to-Back)	\$281	ea.
MBB60	Moisture Barrier - over 60" width (Back-to-Back)	\$449	ea.
WOD	Wood Legs	\$27	ea.
PC	Polished Chrome Legs	\$29	ea.
CAS3	3" Casters	\$29	ea.
2FO	Two Fabric Option	\$110	
GD1	Ganging Device for Metal/Wood Legs	\$58	
GD2	Flat Ganging Device for Soft Seating	\$58	
GBP	Ganging Bracket for Plinth Base	\$124	

COB	Clean Out Back-to-Back (overall width up to 60")	\$562	
CO1B	Clean Out Back-to-Back (overall width over 60")	\$865	
FM	Floor Mount	\$110	
PB48B	Plinth Base - Up To 48" Back-To-Back	\$325	
PB72B	Plinth Base - 49" to 72" Back-To-Back	\$494	
UFB	Unfinished Plinth Base (deduct from plinth option)	Deduct \$80	
RB1	Recessed Base, 1 side	\$124	
RB2	Recessed Base, 2 sides	\$247	

DIMENSIONS	Straight Banquette
Seat Depth:	20"
Seat Height:	18"
Overall Depth:	28.5"
Overall Width:	48, 60, 72"
Overall Height:	42"
Qty./Wt.:	1 ea./150 lbs.

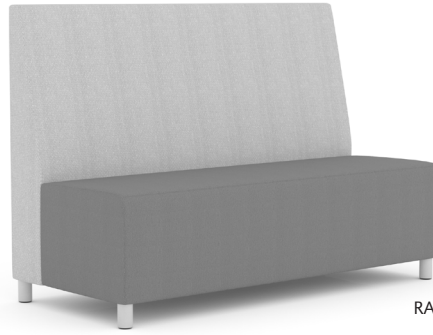

RAVEN HIGH BACK BANQUETTE  
WITH TWO FABRICS

**MODEL / DESCRIPTION / LIST PRICING**



**8372HB** 48"W Straight High Back Banquette (4 legs)

COM Yardage: Total: 7.5 Yds. / Back: 4.5 Yds. / Seat: 3 Yds.

COM	GR1	GR2	GR3	GR4	GR5	GR6	GR7	GR8	GR9	GR10	LEA
\$3388	\$3625	\$3770	\$3921	\$4077	\$4242	\$4411	\$4587	\$4771	\$4962	\$5160	\$6100

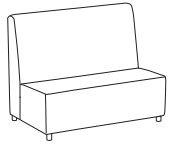

**8374HB** 60"W Straight High Back Banquette (4 legs)

COM Yardage: Total: 9.5 Yds. / Back: 5.5 Yds. / Seat: 4 Yds.

COM	GR1	GR2	GR3	GR4	GR5	GR6	GR7	GR8	GR9	GR10	LEA
\$4168	\$4460	\$4638	\$4825	\$5017	\$5217	\$5427	\$5645	\$5869	\$6103	\$6348	\$7504

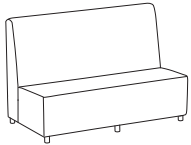

**8376HB** 72"W Straight High Back Banquette (6 legs)

COM Yardage: Total: 11.5 Yds. / Back: 6.5 Yds. / Seat: 5 Yds.

COM	GR1	GR2	GR3	GR4	GR5	GR6	GR7	GR8	GR9	GR10	LEA
\$5106	\$5454	\$5664	\$5885	\$6115	\$6352	\$6600	\$6858	\$7126	\$7403	\$7695	\$9065

**Note: clean out options not available on plinth base units.**

**OPTIONS**

Add upcharge to list price and code to model number

FR	CAL 133 (TB 133) Fire Retardant per yard	\$101	/yd.
MB	Moisture Barrier - up to 60" width	\$141	ea.
MB60	Moisture Barrier - over 60" width	\$225	ea.
LOW	Fully Upholstered Low Back - 27" OA Height	\$107	per unit
WOD	Wood Legs	\$27	ea.
PC	Polished Chrome Legs	\$29	ea.
CAS3	3" Casters	\$29	ea.
2FO	Two Fabric Option	\$110	
GD1	Ganging Device for Metal/Wood Legs	\$58	
GD2	Flat Ganging Device for Soft Seating	\$58	
GBP	Ganging Bracket for Plinth Base	\$124	

CO	Clean Out (overall width up to 60")	\$281	
CO1	Clean Out (overall width over 60")	\$432	
FM	Floor Mount	\$110	
PB48	Plinth Base - Up To 48"	\$213	
PB72	Plinth Base - 49" to 72"	\$359	
UFB	Unfinished Plinth Base (deduct from plinth option)	Deduct \$80	
RB1	Recessed Base, 1 side	\$124	
RB2	Recessed Base, 2 sides	\$247	

DIMENSIONS	Back-to-Back Banquette
Seat Depth:	20"
Seat Height:	18"
Overall Depth:	55"
Overall Width:	22, 48, 60, 72"
Overall Height:	42"
Qty./Wt.:	1 ea./290 lbs.



60" RAVEN BACK-TO-BACK  
HIGH BACK BANQUETTE

**MODEL / DESCRIPTION / LIST PRICING**



**8380HB** 48"W Back-to-Back High Back Banquette (6 legs)

COM Yardage: Total: 9 Yds. / Back: 4 Yds. / Seat: 5 Yds.

COM	GR1	GR2	GR3	GR4	GR5	GR6	GR7	GR8	GR9	GR10	LEA
\$6438	\$6888	\$7163	\$7451	\$7749	\$8059	\$8382	\$8716	\$9064	\$9428	\$9803	\$11589

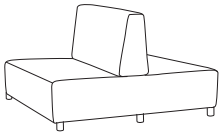

**8382HB** 60" W Back-to-Back High Back Banquette (6 legs)

COM Yardage: Total: 12 Yds. / Back: 6 Yds. / Seat: 6 Yds.

COM	GR1	GR2	GR3	GR4	GR5	GR6	GR7	GR8	GR9	GR10	LEA
\$7921	\$8475	\$8813	\$9167	\$9533	\$9915	\$10310	\$10724	\$11152	\$11596	\$12063	\$14256

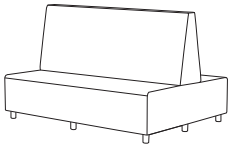

**8384HB** 72" W Back-to-Back High Back Banquette (8 legs)

COM Yardage: Total: 14 Yds. / Back: 7 Yds. / Seat: 7 Yds.

COM	GR1	GR2	GR3	GR4	GR5	GR6	GR7	GR8	GR9	GR10	LEA
\$9559	\$10217	\$10620	\$11040	\$11473	\$11926	\$12398	\$12886	\$13396	\$13924	\$14474	\$17080

**Note: clean out options not available on plinth base units.**

**OPTIONS**

Add upcharge to list price and code to model number

FR	CAL 133 (TB 133) Fire Retardant per yard	\$101	/yd.
MBB	Moisture Barrier - up to 60" width (Back-to-Back)	\$281	ea.
MBB60	Moisture Barrier - over 60" width (Back-to-Back)	\$449	ea.
WOD	Wood Legs	\$27	ea.
PC	Polished Chrome Legs	\$29	ea.
CAS3	3" Casters	\$29	ea.
2FO	Two Fabric Option	\$110	
GD1	Ganging Device for Metal/Wood Legs	\$58	
GD2	Flat Ganging Device for Soft Seating	\$58	
GBP	Ganging Bracket for Plinth Base	\$124	

COB	Clean Out Back-to-Back (overall width up to 60")	\$562	
CO1B	Clean Out Back-to-Back (overall width over 60")	\$865	
FM	Floor Mount	\$110	
PB48B	Plinth Base - Up To 48" Back-To-Back	\$325	
PB72B	Plinth Base - 49" to 72" Back-To-Back	\$494	
UFB	Unfinished Plinth Base (deduct from plinth option)	Deduct \$80	
RB1	Recessed Base, 1 side	\$124	
RB2	Recessed Base, 2 sides	\$247	

**PRIVACY PANELS ONLY**

DIMENSIONS	48" Wide Privacy Panel	60" Wide Privacy Panel	72" Wide Privacy Panel
Panel Depth:	1"	1"	1"
Panel Width:	48"	60"	72"
Panel Height:	48"	48"	48"



RAVEN BACK TO BACK BANQUETTE WITH PRIVACY PANEL



1/2" THICK ACRYLIC PRIVACY PANELS AVAILABLE

**MODEL / DESCRIPTION / LIST PRICING**

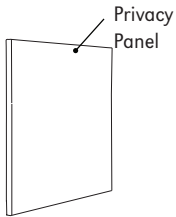

**360P 48" Wide Privacy Panel**

COM Yardage: Total: 3 Yds.

COM	GR1	GR2	GR3	GR4	GR5	GR6	GR7	GR8	GR9	GR10	LEA
\$1055	\$1130	\$1174	\$1222	\$1270	\$1321	\$1374	\$1428	\$1485	\$1545	\$1606	\$1898
LAMINATE			VENEER			ACRYLIC					
\$1458			\$2722			CALL					

**362P 60" Wide Privacy Panel**

COM Yardage: Total: 4 Yds.

COM	GR1	GR2	GR3	GR4	GR5	GR6	GR7	GR8	GR9	GR10	LEA
\$1392	\$1490	\$1549	\$1611	\$1675	\$1742	\$1810	\$1885	\$1959	\$2038	\$2119	\$2506
LAMINATE			VENEER			ACRYLIC					
\$1458			\$2722			CALL					

**365P 72" Wide Privacy Panel**

COM Yardage: Total: 5 Yds.

COM	GR1	GR2	GR3	GR4	GR5	GR6	GR7	GR8	GR9	GR10	LEA
\$1704	\$1823	\$1896	\$1973	\$2051	\$2133	\$2219	\$2308	\$2400	\$2495	\$2594	\$3068
LAMINATE			VENEER			ACRYLIC					
\$1750			\$3177			CALL					

**Note for Edge of privacy panels:**

- Straight panels: available with 3MM PVC or laminate self edge. Select from any of our 3MM PVC edges in solid or wood tone, no custom colors available.
- Curved panels: will only able available with laminate self edge.
- Both straight and curved panels: when combining straights and curved, ONLY self edge is available.

Raven Modular Back  
Available in 2 heights  
27" and 33"

**OPTIONS**

- CODE: FR - CAL 133 (TB 133) Fire Retardant
- CODE: MB - Moisture Barrier (up to 60" overall width)
- CODE: MB60 - Moisture Barrier (over 60" overall width)
- CODE: LOW - Fully Upholstered Low Back - 27" OA Height
- CODE: WOD - Wood Legs
- CODE: WAC - Wood Arm Caps
- CODE: PAC - Poly Arm Caps - Standard Black/Charcoal
- CODE: PC - Polished Chrome Legs
- CODE: CAS3 - 3" Casters
- CODE: CO - Clean Out (overall width up to 50")
- CODE: CO1 - Clean Out (overall width over 50")
- CODE: 2FO - Two Fabric Option
- CODE: GD1 - Ratchet Ganging Device for Soft Seating
- CODE: GD2 - Flat Ganging Device for Soft Seating
- CODE: GD3 - Flat Ganging Device for Café & Training Tables
- CODE: TABF(-) - Fixed Laminate Tablet - outside of modular unit (round post, specify tablet shape A, B or C)
- CODE: TABFB(-) - Fixed Laminate Tablet - between two modular units (blade post, specify tablet shape A, B or C)
- CODE: TABR1(-) - Removable Swivel Tablet (laminate shape A, B or C specify left or right arm)
- CODE: TABR2(-) - Removable Swivel Tablet (laminate shape A, B or C with opening for tablet on both arms)
- CODE: LAM5 - Non-standard laminate for 5 or less tablets see options for upcharge
- CODE: SST - Solid Surface Tablet
- CODE: SS5 - Non-standard Solid Surface top for 5 or less tablets



**TABLET SHAPES**

**Three Tablet Shapes::**

Choose from the three shapes shown and specify; A, B or C and left or right (outside tablet) when ordering.  
Example: TABF(A) Left - this would be a fixed shape A tablet on the left side (when seated).

**Laminate Top:**

- Tablet orders of 5 or less have 4 standard laminate colors:
- Wilsonart Black 1595-60
  - Wilsonart Montana Walnut 7110K-78
  - Formica Brite White 459-58
  - Nevamar Silver Alu Metalx MXT003

**Solid Surface Top:**

- Tablet orders of 5 or less have 4 standard Corian colors:
- Bone
  - Bronzite
  - Glacier White
  - Silver Grey

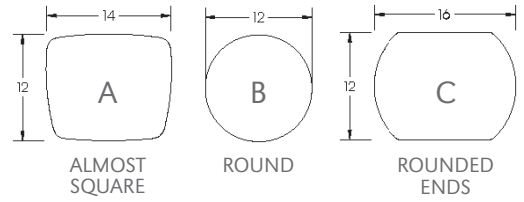

DIMENSIONS	22" Straight Unit	30" Straight Unit	44" Straight Unit
Seat Depth:	20"	20"	20"
Seat Height:	18"	18"	18"
Overall Depth:	27"	27"	27"
Overall Width:	22"	30"	44"
Overall Height:	33"	33"	33"
Qty./Wt.:	1 ea./44 lbs.	1 ea./44 lbs.	1 ea./44 lbs.



STRAIGHT UNITS – TABLET ARM AND ELECTRICAL OPTIONS

**MODEL / DESCRIPTION / LIST PRICING**



**8302** 22" W Straight Unit (4 legs)

COM Yardage: Total: 4 Yds. / Back: 2 Yds. / Seat: 2 Yds.

COM	GR1	GR2	GR3	GR4	GR5	GR6	GR7	GR8	GR9	GR10	LEA
\$1230	\$1320	\$1408	\$1511	\$1601	\$1701	\$1804	\$1906	\$2008	\$2110	\$2211	\$2359



**8304** 30" W Straight Unit (4 legs)

COM Yardage: Total: 5.25 Yds. / Back: 2.5 Yds. / Seat: 2.75 Yds.

COM	GR1	GR2	GR3	GR4	GR5	GR6	GR7	GR8	GR9	GR10	LEA
\$1442	\$1550	\$1663	\$1790	\$1906	\$2033	\$2160	\$2289	\$2416	\$2543	\$2696	\$2843

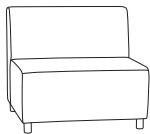

**8306** 44" W Straight Unit (4 legs)

COM Yardage: Total: 7 Yds. / Back: 4 Yds. / Seat: 3 Yds.

COM	GR1	GR2	GR3	GR4	GR5	GR6	GR7	GR8	GR9	GR10	LEA
\$2041	\$2194	\$2346	\$2498	\$2652	\$2805	\$2957	\$3111	\$3264	\$3415	\$3569	\$3716

**OPTIONS**

Add upcharge to list price and code to model number

FR	CAL 133 (TB 133) Fire Retardant per yard	\$101	/yd.
MB	Moisture Barrier - up to 60" width	\$141	ea.
MB60	Moisture Barrier - over 60" width	\$225	ea.
LOW	Fully Upholstered Low Back - 27" OA Height	\$107	
WOD	Wood Legs	\$27	ea.
PC	Polished Chrome Legs	\$29	ea.
CAS3	3" Casters	\$29	ea.
2FO	Two Fabric Option	\$110	
GD1	Ganging Device for Metal/Wood Legs	\$58	
GD2	Flat Ganging Device for Soft Seating	\$58	

TABF-(L)	Fixed Tablet (outside, specify (L/R), shape A, B or C)	\$416	
TABFB-(L)	Fixed Tablet (blade, specify (L/R), shape A, B or C)	\$416	
LAM5	Non-standard laminate (5 tablets or less)	\$281	ea. tablet
SST	Solid Surface Tablet Arm - add to tablet option	\$141	
SS5	Non-standard Solid Surface (5 tablets or less)	Call For Quote	
CO	Clean Out (overall width up to 50")	\$281	
CO1	Clean Out (overall width over 50")	\$432	

DIMENSIONS	30° Curve Inside	45° Curve Inside	60° Curve Inside
Seat Depth:	20"	20"	20"
Seat Height:	18"	18"	18"
Overall Depth:	29"	30.5"	32.5"
Overall Width:	35"	52"	67"
Overall Height:	33"	33"	33"
Qty./Wt.:	1 ea./64 lbs.	1 ea./84 lbs.	1 ea./115 lbs.



60° Inside Curve with Optional Power/Data Unit

**MODEL / DESCRIPTION / LIST PRICING**

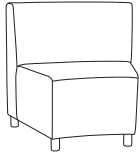

**8308** Inside 30° Curve Unit (4 legs)

COM Yardage: Total: 5.25 Yds. / Back: 2.75 Yds. / Seat: 2.5 Yds.

COM	GR1	GR2	GR3	GR4	GR5	GR6	GR7	GR8	GR9	GR10	LEA
\$1338	\$1427	\$1517	\$1619	\$1708	\$1808	\$1911	\$2012	\$2115	\$2216	\$2318	\$2466

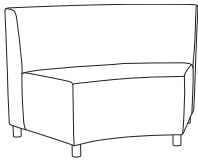

**8310** Inside 45° Curve Unit (4 legs)

COM Yardage: Total: 6 Yds. / Back: 3 Yds. / Seat: 3 Yds.

COM	GR1	GR2	GR3	GR4	GR5	GR6	GR7	GR8	GR9	GR10	LEA
\$1965	\$2092	\$2221	\$2361	\$2489	\$2628	\$2768	\$2909	\$3049	\$3188	\$3329	\$3475

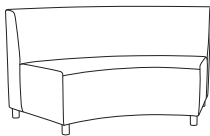

**8318** Inside 60° Curve Unit (5 legs)

COM Yardage: Total: 9 Yds. / Back: 5 Yds. / Seat: 4 Yds.

COM	GR1	GR2	GR3	GR4	GR5	GR6	GR7	GR8	GR9	GR10	LEA
\$2556	\$2683	\$2809	\$2951	\$3077	\$3218	\$3358	\$3497	\$3638	\$3778	\$3919	\$4066

**OPTIONS**

Add upcharge to list price and code to model number

FR	CAL 133 (TB 133) Fire Retardant per yard	\$101	/yd.
MB	Moisture Barrier - up to 60" width	\$141	ea.
MB60	Moisture Barrier - over 60" width	\$225	ea.
LOW	Fully Upholstered Low Back - 27" OA Height	\$107	
WOD	Wood Legs	\$27	ea.
PC	Polished Chrome Legs	\$29	ea.
CAS3	3" Casters	\$29	ea.
2FO	Two Fabric Option	\$110	
GD1	Ganging Device for Metal/Wood Legs	\$58	
GD2	Flat Ganging Device for Soft Seating	\$58	

TABF(-)	Fixed Tablet (outside, specify (L/R), shape A, B or C)	\$416	
TABFB(-)	Fixed Tablet (blade, specify (L/R), shape A, B or C)	\$416	
LAM5	Non-standard laminate (5 tablets or less)	\$281	ea. tablet
SST	Solid Surface Tablet Arm - add to tablet option	\$141	
SS5	Non-standard Solid Surface (5 tablets or less)	Call For Quote	
CO	Clean Out (overall width up to 50")	\$281	
CO1	Clean Out (overall width over 50")	\$432	

DIMENSIONS	20° Curve Outside	30° Curve Outside	45° Curve Outside	60° Curve Outside
Seat Depth:	20"	20"	20"	20"
Seat Height:	18"	18"	18"	18"
Overall Depth:	27"	29"	30.5"	32.5"
Overall Width:	23"	35"	52"	67"
Overall Height:	33"	33"	33"	33"
Qty./Wt.:	1 ea./44 lbs.	1 ea./64 lbs.	1 ea./85 lbs.	1 ea./110 lbs.



60 DEGREE OUTSIDE CURVE

**MODEL / DESCRIPTION / LIST PRICING**

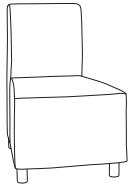

**8312** Outside 20° Curve Unit (4 legs)

COM Yardage: Total: 4.5 Yds. / Back: 2 Yds. / Seat: 2.5 Yds.

COM	GR1	GR2	GR3	GR4	GR5	GR6	GR7	GR8	GR9	GR10	LEA
\$1398	\$1499	\$1588	\$1690	\$1780	\$1883	\$1983	\$2086	\$2187	\$2290	\$2390	\$2538



**8314** Outside 30° Curve Unit (4 legs)

COM Yardage: Total: 5 Yds. / Back: 2 Yds. / Seat: 3 Yds.

COM	GR1	GR2	GR3	GR4	GR5	GR6	GR7	GR8	GR9	GR10	LEA
\$1495	\$1596	\$1685	\$1787	\$1876	\$1979	\$2080	\$2183	\$2284	\$2386	\$2489	\$2633

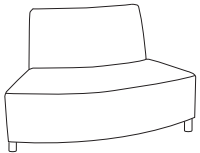

**8316** Outside 45° Curve Unit (4 legs)

COM Yardage: Total: 7 Yds. / Back: 3 Yds. / Seat: 4 Yds.

COM	GR1	GR2	GR3	GR4	GR5	GR6	GR7	GR8	GR9	GR10	LEA
\$2196	\$2322	\$2451	\$2591	\$2719	\$2858	\$2999	\$3139	\$3279	\$3420	\$3559	\$3705

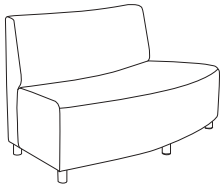

**8320** Outside 60° Curve Unit (5 legs)

COM Yardage: Total: 8 Yds. / Back: 3.5 Yds. / Seat: 4.5 Yds.

COM	GR1	GR2	GR3	GR4	GR5	GR6	GR7	GR8	GR9	GR10	LEA
\$2778	\$2918	\$3045	\$3186	\$3314	\$3452	\$3593	\$3733	\$3874	\$4013	\$4153	\$4300

**OPTIONS**

Add upcharge to list price and code to model number

FR	CAL 133 (TB 133) Fire Retardant per yard	\$101	/yd.
MB	Moisture Barrier - up to 60" width	\$141	ea.
MB60	Moisture Barrier - over 60" width	\$225	ea.
LOW	Fully Upholstered Low Back - 27" OA Height	\$107	
WOD	Wood Legs	\$27	ea.
PC	Polished Chrome Legs	\$29	ea.
CAS3	3" Casters	\$29	ea.
2FO	Two Fabric Option	\$110	
GD1	Ganging Device for Metal/Wood Legs	\$58	
GD2	Flat Ganging Device for Soft Seating	\$58	

TABF(-)	Fixed Tablet (outside, specify (L/R), shape A, B or C)	\$416	
TABFB(-)	Fixed Tablet (blade, specify (L/R), shape A, B or C)	\$416	
LAM5	Non-standard laminate (5 tablets or less)	\$281	ea. tablet
SST	Solid Surface Tablet Arm - add to tablet option	\$141	
SS5	Non-standard Solid Surface (5 tablets or less)		Call For Quote
CO	Clean Out (overall width up to 50")	\$281	
CO1	Clean Out (overall width over 50")	\$432	

DIMENSIONS	Corner Units
Seat Depth:	21"
Seat Height:	18"
Overall Depth:	28"
Overall Width:	28"
Overall Height:	33"
Qty./Wt.:	1 ea./75 lbs.



CORNER UNIT - SQUARE SEAT BACK

**MODEL / DESCRIPTION / LIST PRICING**



**8386** Corner Unit - Square Seat Back (4 legs)

COM Yardage: Total: 6.5 Yds. / Back: 4.5 Yds. / Seat: 2 Yds.

COM	GR1	GR2	GR3	GR4	GR5	GR6	GR7	GR8	GR9	GR10	LEA
\$2368	\$2533	\$2634	\$2739	\$2848	\$2963	\$3081	\$3205	\$3334	\$3467	\$3605	\$4260

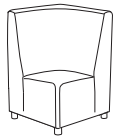

**8388** Corner Unit - Curved Seat Back (4 legs)

COM Yardage: Total: 6.5 Yds. / Back: 4.5 Yds. / Seat: 2 Yds.

COM	GR1	GR2	GR3	GR4	GR5	GR6	GR7	GR8	GR9	GR10	LEA
\$2575	\$2748	\$2852	\$2962	\$3076	\$3196	\$3319	\$3448	\$3582	\$3720	\$3866	\$4550

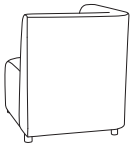

**8389** Corner Unit - Curved Back Panel Corner Unit (4 legs)

COM Yardage: Total: 6.5 Yds. / Back: 4.5 Yds. / Seat: 2 Yds.

COM	GR1	GR2	GR3	GR4	GR5	GR6	GR7	GR8	GR9	GR10	LEA
\$2813	\$3000	\$3112	\$3231	\$3355	\$3482	\$3614	\$3755	\$3896	\$4046	\$4202	\$4936

**OPTIONS**

Add upcharge to list price and code to model number

FR	CAL 133 (TB 133) Fire Retardant per yard	\$101	/yd.
MB	Moisture Barrier - up to 60" width	\$141	ea.
MB60	Moisture Barrier - over 60" width	\$225	ea.
LOW	Fully Upholstered Low Back - 27" OA Height	\$107	
WOD	Wood Legs	\$27	ea.
PC	Polished Chrome Legs	\$29	ea.
CAS3	3" Casters	\$29	ea.

2FO	Two Fabric Option	\$110	
GD1	Ganging Device for Metal/Wood Legs	\$58	
GD2	Flat Ganging Device for Soft Seating	\$58	
CO	Clean Out (overall width up to 50")	\$281	
CO1	Clean Out (overall width over 50")	\$432	

DIMENSIONS	Straight Unit	Straight Unit	Straight Unit
Panel Depth:	1"	1"	1"
Overall Width:	22"	30"	44"
Overall Height:	48"	48"	48"
Qty./Approx Wt.:	1 ea./100 lbs.	1 ea./110 lbs.	1 ea./120 lbs.

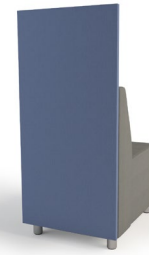

STRAIGHT UNIT

**MODEL / DESCRIPTION / LIST PRICING**

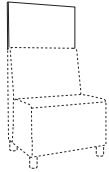

<b>8302P/U</b>	22"W Straight Unit										COM Yardage: 1.5 Yds.
COM	GR1	GR2	GR3	GR4	GR5	GR6	GR7	GR8	GR9	GR10	LEA
\$718	\$770	\$799	\$831	\$865	\$898	\$934	\$972	\$1011	\$1052	\$1093	\$1292
<b>8302P/L</b>	Laminate					<b>8302P/A</b>	Acrylic				
	Laminate						Acrylic				
	\$881						CALL				

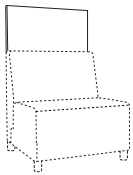

<b>8304P/U</b>	30"W Straight Unit										COM Yardage: 2 Yds.
COM	GR1	GR2	GR3	GR4	GR5	GR6	GR7	GR8	GR9	GR10	LEA
\$890	\$953	\$989	\$1029	\$1071	\$1115	\$1159	\$1204	\$1253	\$1305	\$1357	\$1603
<b>8304P/L</b>	Laminate					<b>8304P/A</b>	Acrylic				
	Laminate						Acrylic				
	\$1068						CALL				

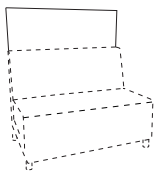

<b>8306P/U</b>	44"W Straight Unit										COM Yardage: 3 Yds.
COM	GR1	GR2	GR3	GR4	GR5	GR6	GR7	GR8	GR9	GR10	LEA
\$1023	\$1094	\$1136	\$1184	\$1230	\$1280	\$1331	\$1384	\$1441	\$1497	\$1558	\$1841
<b>8306P/L</b>	Laminate					<b>8306P/A</b>	Acrylic				
	Laminate						Acrylic				
	\$1231						CALL				

**Note for Edge of privacy panels:**

- Straight panels: available with 3MM PVC or laminate self edge.  
Select from any of our 3MM PVC edges in solid or wood tone, no custom colors available.
- Curved panels: will only be available with laminate self edge.
- Both straight and curved panels: when combining straights and curved, ONLY self edge is available.

**OPTIONS**

Add upcharge to list price and code to model number

FR	CAL 133 (TB 133) Fire Retardant per yard	\$101	/yd.
----	--	-------	------

2FO	Two Fabric Option	\$110	
-----	-------------------	-------	--

DIMENSIONS	30° Curve Inside	45° Curve Inside	60° Curve Inside
Panel Depth:	1"	1"	1"
Overall Width:	35"	52"	67"
Overall Height:	48"	48"	48"
Qty./Approx Wt.:	1 ea./135 lbs.	1 ea./145 lbs.	1 ea./160 lbs.



INSIDE CURVE UNIT

**MODEL / DESCRIPTION / LIST PRICING**

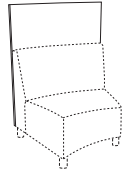

**8308P/U** Inside 30° Curve Unit COM Yardage: 2 Yds.

COM	GR1	GR2	GR3	GR4	GR5	GR6	GR7	GR8	GR9	GR10	LEA
\$1333	\$1427	\$1484	\$1542	\$1604	\$1668	\$1736	\$1805	\$1877	\$1953	\$2030	\$2400

**8308P/L** Laminate

Laminate
\$1748

**8308P/A** Acrylic

Acrylic
CALL

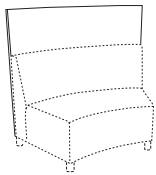

**8310P/U** Inside 45° Curve Unit COM Yardage: 3 Yds.

COM	GR1	GR2	GR3	GR4	GR5	GR6	GR7	GR8	GR9	GR10	LEA
\$1534	\$1641	\$1708	\$1776	\$1845	\$1919	\$1997	\$2077	\$2159	\$2246	\$2335	\$2760

**8310P/L** Laminate

Laminate
\$2010

**8310P/A** Acrylic

Acrylic
CALL

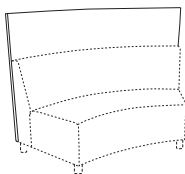

**8318P/U** Inside 60° Curve Unit COM Yardage: 4 Yds.

COM	GR1	GR2	GR3	GR4	GR5	GR6	GR7	GR8	GR9	GR10	LEA
\$2395	\$2562	\$2665	\$2772	\$2881	\$2998	\$3116	\$3241	\$3371	\$3506	\$3645	\$4310

**8318P/L** Laminate

Laminate
\$3132

**8302P/A** Acrylic

Acrylic
CALL

**Note for Edge of privacy panels:**

- Straight panels: available with 3MM PVC or laminate self edge.  
Select from any of our 3MM PVC edges in solid or wood tone, no custom colors available.
- Curved panels: will only able available with laminate self edge.
- Both straight and curved panels: when combining straights and curved, ONLY self edge is available.

**OPTIONS**

Add upcharge to list price and code to model number

FR	CAL 133 (TB 133) Fire Retardant per yard	\$101	/yd.
----	--	-------	------

2FO	Two Fabric Option	\$110	
-----	-------------------	-------	--

DIMENSIONS	20° Curve Outside	30° Curve Outside	45° Curve Outside	60° Curve Outside
Panel Depth:	1"	1"	1"	1"
Overall Width:	22"	35"	52"	67"
Overall Height:	48"	48"	48"	48"
Qty./Approx Wt.:	1 ea./120 lbs.	1 ea./135 lbs.	1 ea./145 lbs.	1 ea./160 lbs.



OUTSIDE CURVE UNIT

**MODEL / DESCRIPTION / LIST PRICING**

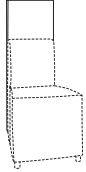

**8312P/U** Outside 20° Curve Unit COM Yardage: 1.5 Yds.

COM	GR1	GR2	GR3	GR4	GR5	GR6	GR7	GR8	GR9	GR10	LEA
\$933	\$999	\$1039	\$1080	\$1121	\$1169	\$1215	\$1264	\$1312	\$1365	\$1421	\$1679

**8312P/L** Laminate

Laminate
\$1329

**8312P/A** Acrylic

Acrylic
CALL

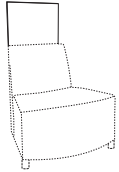

**8314P/U** Outside 30° Curve Unit COM Yardage: 2 Yds.

COM	GR1	GR2	GR3	GR4	GR5	GR6	GR7	GR8	GR9	GR10	LEA
\$1333	\$1427	\$1484	\$1542	\$1604	\$1668	\$1736	\$1805	\$1877	\$1953	\$2030	\$2400

**8314P/L** Laminate

Laminate
\$1854

**8314P/A** Acrylic

Acrylic
CALL

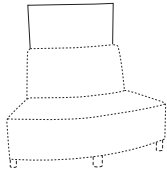

**8316P/U** Outside 45° Curve Unit COM Yardage: 2 Yds.

COM	GR1	GR2	GR3	GR4	GR5	GR6	GR7	GR8	GR9	GR10	LEA
\$1534	\$1641	\$1708	\$1776	\$1845	\$1919	\$1997	\$2077	\$2159	\$2246	\$2335	\$2760

**8316P/L** Laminate

Laminate
\$2116

**8316P/A** Acrylic

Acrylic
CALL

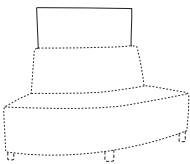

**8320P/U** Outside 60° Curve Unit COM Yardage: 3 Yds.

COM	GR1	GR2	GR3	GR4	GR5	GR6	GR7	GR8	GR9	GR10	LEA
\$2395	\$2562	\$2665	\$2772	\$2881	\$2998	\$3116	\$3241	\$3371	\$3506	\$3645	\$4310

**8320P/L** Laminate

Laminate
\$3238

**8320P/A** Acrylic

Acrylic
CALL

**Note for Edge of privacy panels:**

- Straight panels: available with 3MM PVC or laminate self edge. Select from any of our 3MM PVC edges in solid or wood tone, no custom colors available.
- Curved panels: will only be available with laminate self edge.
- Both straight and curved panels: when combining straights and curved, ONLY self edge is available.

**OPTIONS**

Add upcharge to list price and code to model number

FR	CAL 133 (TB 133) Fire Retardant per yard	\$101	/yd.
----	--	-------	------

2FO	Two Fabric Option	\$110	
-----	-------------------	-------	--

DIMENSIONS	Straight Backless	Bariatric Backless
Seat Depth:	27"	27"
Seat Height:	18"	18"
Overall Depth:	27"	27"
Overall Width:	22", 44"	30"
Overall Height:	18"	18"
Qty./Wt.:	1 ea./40/60 lbs.	1 ea./80 lbs.



SINGLE SEAT BACKLESS WITH  
OPTIONAL TWO FABRIC

**MODEL / DESCRIPTION / LIST PRICING**

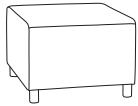

**8326** Single Seat Backless Unit 22"

COM Yardage: Total: 2.5 Yds. / Sides: 1.5 Yds. / Top: 1 Yds.

COM	GR1	GR2	GR3	GR4	GR5	GR6	GR7	GR8	GR9	GR10	LEA
\$1076	\$1169	\$1259	\$1364	\$1455	\$1561	\$1667	\$1771	\$1876	\$1981	\$2087	\$2238

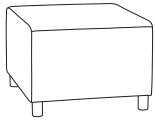

**8328** Bariatric Backless Unit 30"

COM Yardage: Total: 3 Yds. / Sides: 2 Yds. / Top: 1 Yds.

COM	GR1	GR2	GR3	GR4	GR5	GR6	GR7	GR8	GR9	GR10	LEA
\$1343	\$1500	\$1659	\$1817	\$1974	\$2131	\$2289	\$2445	\$2603	\$2760	\$2917	\$3070



**8330** Two Seat Backless Unit 44"

COM Yardage: Total: 4 Yds. / Sides: 2.5 Yds. / Top: 1.5 Yds.

COM	GR1	GR2	GR3	GR4	GR5	GR6	GR7	GR8	GR9	GR10	LEA
\$1943	\$2100	\$2257	\$2416	\$2574	\$2732	\$2887	\$3045	\$3203	\$3360	\$3518	\$3669

**OPTIONS**

Add upcharge to list price and code to model number

FR	CAL 133 (TB 133) Fire Retardant per yard	\$101	/yd.	TABF(-)	Fixed Tablet (outside, specify (L/R), shape A, B or C)	\$416	
MB	Moisture Barrier - up to 60" width	\$141	ea.	TABFB(-)	Fixed Tablet (blade, specify (L/R), shape A, B or C)	\$416	
WOD	Wood Legs	\$27	ea.	LAM5	Non-standard laminate (5 tablets or less)	\$281	ea. tablet
PC	Polished Chrome Legs	\$29	ea.	SST	Solid Surface Tablet Arm - add to tablet option	\$141	
CAS3	3" Casters	\$29	ea.	SS5	Non-standard Solid Surface (5 tablets or less)	Call For Quote	
2FO	Two Fabric Option	\$110					
GD1	Ganging Device for Metal/Wood Legs	\$58					
GD2	Flat Ganging Device for Soft Seating	\$58					

DIMENSIONS	20° Curve Backless	30° Curve Backless	45° Curve Backless	60° Curve Backless
Seat Depth:	27"	27"	27"	27"
Seat Height:	18"	18"	18"	18"
Overall Depth:	28"	29"	30.5"	32.5"
Overall Width:	32"	35"	52"	67"
Overall Height:	18"	18"	18"	18"
Qty./Wt.:	1 ea./42 lbs.	1 ea./62 lbs.	1 ea./82 lbs.	1 ea./102 lbs.



60° CURVE BACKLESS UNIT

**MODEL / DESCRIPTION / LIST PRICING**

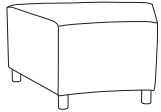

**8332** 20° Curve Unit (4 legs)

COM Yardage: Total: 2.75 Yds. / Sides: 1.75 Yds. / Top: 1 Yds.

COM	GR1	GR2	GR3	GR4	GR5	GR6	GR7	GR8	GR9	GR10	LEA
\$1205	\$1297	\$1389	\$1495	\$1587	\$1691	\$1797	\$1901	\$2007	\$2112	\$2216	\$2367

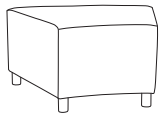

**8334** 30° Curve Unit (4 legs)

COM Yardage: Total: 3.5 Yds. / Sides: 2 Yds. / Top: 1.5 Yds.

COM	GR1	GR2	GR3	GR4	GR5	GR6	GR7	GR8	GR9	GR10	LEA
\$1294	\$1386	\$1479	\$1583	\$1675	\$1781	\$1886	\$1991	\$2095	\$2201	\$2306	\$2456

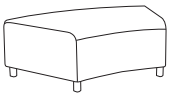

**8336** 45° Curve Unit (4 legs)

COM Yardage: Total: 5 Yds. / Sides: 3.25 Yds. / Top: 1.75 Yds.

COM	GR1	GR2	GR3	GR4	GR5	GR6	GR7	GR8	GR9	GR10	LEA
\$1801	\$1892	\$1983	\$2089	\$2180	\$2286	\$2389	\$2495	\$2601	\$2706	\$2811	\$2962

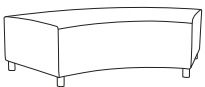

**8338** 60° Curve Unit (5 legs)

COM Yardage: Total: 5.5 Yds. / Sides: 3 Yds. / Top: 2.5 Yds.

COM	GR1	GR2	GR3	GR4	GR5	GR6	GR7	GR8	GR9	GR10	LEA
\$2201	\$2292	\$2384	\$2490	\$2580	\$2686	\$2790	\$2896	\$3001	\$3106	\$3210	\$3361

**OPTIONS**

Add upcharge to list price and code to model number

FR	CAL 133 (TB 133) Fire Retardant per yard	\$101	/yd.	TABF-( )	Fixed Tablet (outside, specify (L/R), shape A, B or C)	\$416	
MB	Moisture Barrier - up to 60" width	\$141	ea.	TABFB-( )	Fixed Tablet (blade, specify (L/R), shape A, B or C)	\$416	
WOD	Wood Legs	\$27	ea.	LAM5	Non-standard laminate (5 tablets or less)	\$281	ea. tablet
PC	Polished Chrome Legs	\$29	ea.	SST	Solid Surface Tablet Arm - add to tablet option	\$141	
CAS3	3" Casters	\$29	ea.	SS5	Non-standard Solid Surface (5 tablets or less)	Call For Quote	
2FO	Two Fabric Option	\$110					
GD1	Ganging Device for Metal/Wood Legs	\$58					
GD2	Flat Ganging Device for Soft Seating	\$58					

DIMENSIONS	R-L Arm	Center Arm
Overall Depth:	27"	19"
Overall Width:	3"	2"
Overall Height:	25"	21"
Qty./Wt.:	1 ea./25 lbs.	1 ea./10 lbs.



SINGLE SEAT WITH ARMS

**MODEL / DESCRIPTION / LIST PRICING**

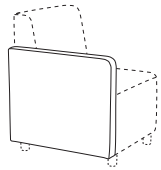

**8358L/R** Left or Right Arm

COM Yardage: 1.5 Yds..

COM	GR1	GR2	GR3	GR4	GR5	GR6	GR7	GR8	GR9	GR10	LEA
\$272	\$325	\$365	\$418	\$457	\$496	\$535	\$576	\$628	\$679	\$731	\$850

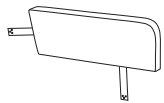

**8358C** Center Arm (ARM CAP NOT AVAILABLE)

COM Yardage: .75 Yds..

COM	GR1	GR2	GR3	GR4	GR5	GR6	GR7	GR8	GR9	GR10	LEA
\$265	\$318	\$356	\$408	\$448	\$488	\$528	\$566	\$619	\$672	\$725	\$842

**Note:** Tablet options available on full left or right arm only and cannot be used with arm caps.

**OPTIONS**

Add upcharge to list price and code to model number

FR	CAL 133 (TB 133) Fire Retardant per yard	\$101	/yd.	SST	Solid Surface Tablet Arm - add to tablet option	\$141	
TAB(-)	Swivel Tablet (specify A, B or C, left or right arm)	\$444		SS5	Non-standard Solid Surface (5 tablets or less)	Call For Quote	
TABR1(-)	Removable Tablet (specify A, B or C, left or right arm)	\$528		WAC	Single Wood Arm Cap	\$100	
TABR2(-)	Removable Tablet (specify A, B or C both arm openings)	\$640		PAC	Poly Arm Cap - Standard Black/Charcoal	\$77	ea.
LAM5	Non-standard laminate (5 tablets or less)	\$281	ea. tablet				



"S" CONFIGURATION: SIX 60° CURVE UNITS, TWO 60° BACKLESS CURVE UNITS WITH CABANA OCCASIONAL TABLES

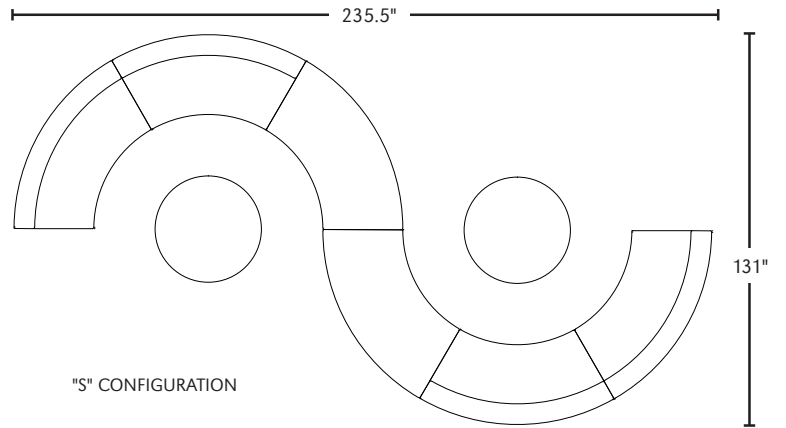

"S" CONFIGURATION



THREE 60° CURVE UNITS, TWO OUTSIDE ARMS, TWO LOUNGE UNITS AND 36" ROUND CABANA TABLE WITH COVE POWER OPTION

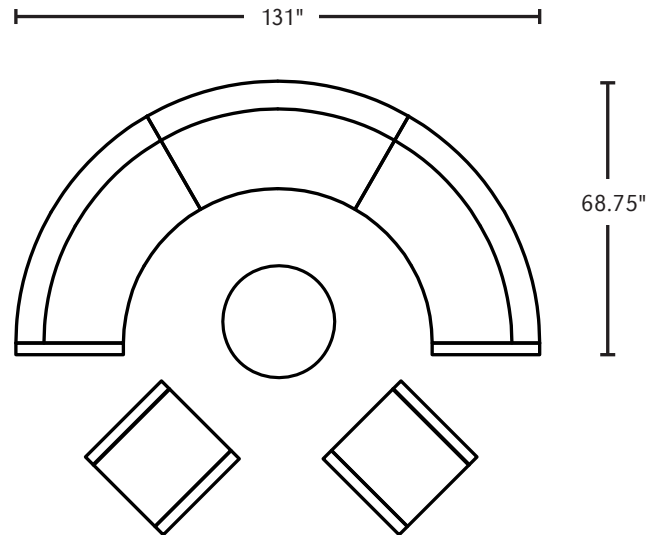

ARC CONFIGURATION



SERPENTINE CONFIGURATION

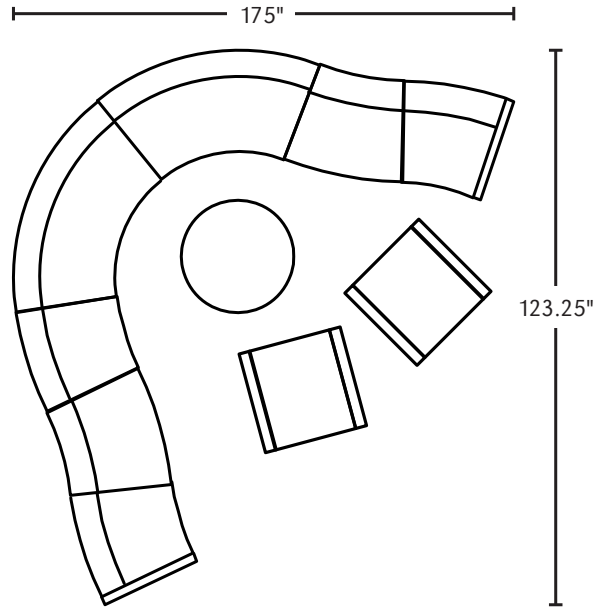

"L" SHAPE CONFIGURATION

ONE CORNER UNIT, SIX STRAIGHT UNITS,, TWO OUTSIDE ARMS, TWO LOUNGE UNITS AND TWO CABANA OCCASIONAL TABLES FEATURING COVE POWER OPTION

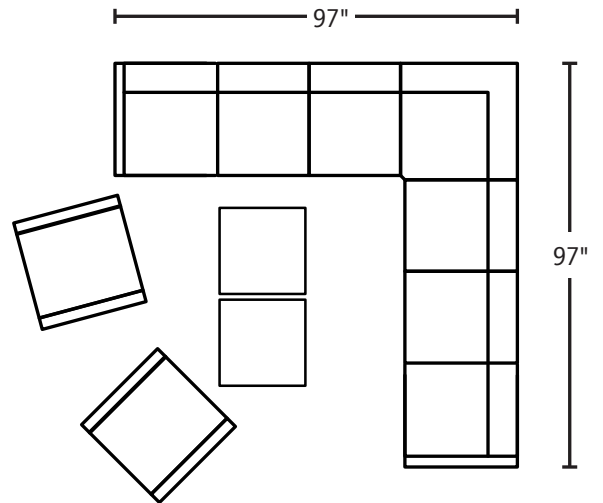

DIMENSIONS	18" Round	24" Round	30" Round	36" Round	42" Round
Overall Depth:	18"	24"	30"	36"	42"
Overall Width:	18"	24"	30"	36"	42"
Overall Height:	16" or 18"	18"	18"	18"	18"
Qty./Wt.:	1 ea./26 lbs.	1 ea./37 lbs.	1 ea./48 lbs.	1 ea./68 lbs.	1 ea./84 lbs.



36" ROUND OTTOMAN

**MODEL / DESCRIPTION / LIST PRICING**

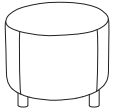

**8341-S** 18" Round Ottoman - 16" height (4 legs) (4 - 2" Casters Needed) COM Yardage: Total: 2.75 Yds. / Sides: 2 Yds. / Top: .75 Yds.

COM	GR1	GR2	GR3	GR4	GR5	GR6	GR7	GR8	GR9	GR10	LEA
\$1002	\$1149	\$1298	\$1447	\$1595	\$1743	\$1892	\$2040	\$2189	\$2339	\$2486	\$2629

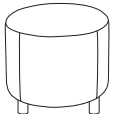

**8341** 18" Round Ottoman (4 legs) (4 - 2" Casters Needed) COM Yardage: Total: 2.75 Yds. / Sides: 2 Yds. / Top: .75 Yds.

COM	GR1	GR2	GR3	GR4	GR5	GR6	GR7	GR8	GR9	GR10	LEA
\$1027	\$1174	\$1323	\$1472	\$1620	\$1768	\$1917	\$2065	\$2214	\$2364	\$2511	\$2654

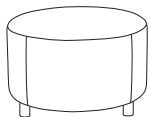

**8339** 24" Round Ottoman (4 legs) (4 Casters Needed) COM Yardage: Total: 2.75 Yds. / Sides: 2 Yds. / Top: .75 Yds.

COM	GR1	GR2	GR3	GR4	GR5	GR6	GR7	GR8	GR9	GR10	LEA
\$1270	\$1428	\$1585	\$1742	\$1900	\$2057	\$2215	\$2372	\$2530	\$2687	\$2845	\$2996

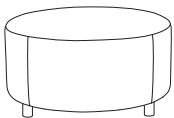

**8340** 30" Round Ottoman (4 legs) (4 Casters Needed) COM Yardage: Total: 3.5 Yds. / Sides: 2.5 Yds. / Top: 1 Yds.

COM	GR1	GR2	GR3	GR4	GR5	GR6	GR7	GR8	GR9	GR10	LEA
\$1746	\$1904	\$2062	\$2220	\$2377	\$2533	\$2691	\$2848	\$3006	\$3163	\$3320	\$3473

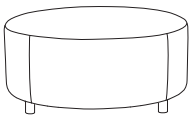

**8342** 36" Round Ottoman (4 legs) (4 Casters Needed) COM Yardage: Total: 4.25 Yds. / Sides: 2.75 Yds. / Top: 1.25 Yds.

COM	GR1	GR2	GR3	GR4	GR5	GR6	GR7	GR8	GR9	GR10	LEA
\$2100	\$2257	\$2416	\$2574	\$2732	\$2887	\$3045	\$3203	\$3360	\$3518	\$3675	\$3827

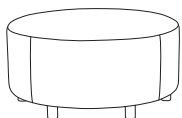

**8344** 42" Round Ottoman (6 legs) (4 Casters Needed) COM Yardage: Total: 4.5 Yds. / Sides: 2.75 Yds. / Top: 1.25 Yds.

COM	GR1	GR2	GR3	GR4	GR5	GR6	GR7	GR8	GR9	GR10	LEA
\$2269	\$2427	\$2585	\$2741	\$2899	\$3057	\$3215	\$3371	\$3530	\$3688	\$3845	\$3994

**OPTIONS**

Add upcharge to list price and code to model number

FR	CAL 133 (TB 133) Fire Retardant per yard	\$101	/yd.
MB	Moisture Barrier - per ottoman	\$141	
WOD	Wood Legs	\$27	ea.
PC	Polished Chrome Legs	\$29	ea.

CAS2	2" Black Casters (18" size Only)	\$29	ea.
CAS3	3" Black Casters (not available on 18" size)	\$29	ea.
2FO	Two Fabric Option	\$110	

DIMENSIONS	18" Round	24" Round	30" Round	36" Round	42" Round
Overall Depth:	18"	24"	30"	36"	42"
Overall Width:	18"	24"	30"	36"	42"
Overall Height:	16" or 18"	18"	18"	18"	18"
Qty./Wt.:	1 ea./26 lbs.	1 ea./37 lbs.	1 ea./48 lbs.	1 ea./68 lbs.	1 ea./84 lbs.



ROUND OTTOMAN / NO LEGS  
W/ PLASTIC GLIDES

**MODEL / DESCRIPTION / LIST PRICING**

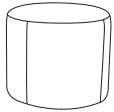

**8341-NLS 18" Round Ottoman - 16" height / No Legs**

COM Yardage: Total: 2.75 Yds. / Sides: 2 Yds. / Top: .75 Yds.

COM	GR1	GR2	GR3	GR4	GR5	GR6	GR7	GR8	GR9	GR10	LEA
\$934	\$1066	\$1195	\$1326	\$1459	\$1588	\$1719	\$1848	\$1981	\$2112	\$2241	\$2366

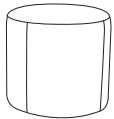

**8341-NL 18" Round Ottoman / No Legs**

COM Yardage: Total: 2.75 Yds. / Sides: 2 Yds. / Top: .75 Yds.



COM	GR1	GR2	GR3	GR4	GR5	GR6	GR7	GR8	GR9	GR10	LEA
\$959	\$1091	\$1220	\$1351	\$1484	\$1613	\$1744	\$1873	\$2006	\$2137	\$2266	\$2391

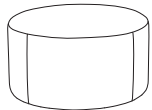

**8339-NL 24" Round Ottoman / No Legs**

COM Yardage: Total: 2.75 Yds. / Sides: 2 Yds. / Top: .75 Yds.



COM	GR1	GR2	GR3	GR4	GR5	GR6	GR7	GR8	GR9	GR10	LEA
\$1178	\$1317	\$1454	\$1593	\$1733	\$1871	\$2009	\$2147	\$2286	\$2425	\$2563	\$2696

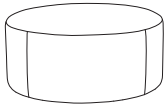

**8340-NL 30" Round Ottoman / No Legs**

COM Yardage: Total: 3.5 Yds. / Sides: 2.5 Yds. / Top: 1 Yds.

COM	GR1	GR2	GR3	GR4	GR5	GR6	GR7	GR8	GR9	GR10	LEA
\$1595	\$1735	\$1872	\$2011	\$2152	\$2289	\$2427	\$2564	\$2705	\$2844	\$2981	\$3113

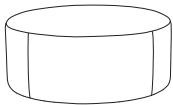

**8342-NL 36" Round Ottoman / No Legs**

COM Yardage: Total: 3.75 Yds. / Sides: 2.5 Yds. / Top: 1.25 Yds.

COM	GR1	GR2	GR3	GR4	GR5	GR6	GR7	GR8	GR9	GR10	LEA
\$1896	\$2034	\$2173	\$2313	\$2450	\$2589	\$2727	\$2866	\$3005	\$3142	\$3281	\$3413



**8344-NL 42" Round Ottoman / No Legs**

COM Yardage: Total: 4.25 Yds. / Sides: 2.75 Yds. / Top: 1.5 Yds.

COM	GR1	GR2	GR3	GR4	GR5	GR6	GR7	GR8	GR9	GR10	LEA
\$2057	\$2196	\$2334	\$2474	\$2612	\$2751	\$2889	\$3027	\$3166	\$3304	\$3443	\$3575

**OPTIONS**

Add upcharge to list price and code to model number

FR	CAL 133 (TB 133) Fire Retardant per yard	\$101	/yd.
MB	Moisture Barrier - per ottoman	\$141	

2FO	Two Fabric Option	\$110	
-----	-------------------	-------	--

DIMENSIONS	27" Square	36" Square	42" Square
Overall Depth:	27"	36"	42"
Overall Width:	27"	36"	42"
Overall Height:	18"	18"	18"
Qty./Wt.:	1 ea./50 lbs.	1 ea./58 lbs.	1 ea./78 lbs.



27" SQUARE WITH CASTERS  
AND FIXED TABLET ARMS



36" SQUARE OTTOMAN

**MODEL / DESCRIPTION / LIST PRICING**

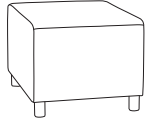

**8346** 27" Square Ottoman



COM Yardage: Total: 3 Yds. / Sides: 2 Yds. / Top: 1 Yds.

COM	GR1	GR2	GR3	GR4	GR5	GR6	GR7	GR8	GR9	GR10	LEA
\$1200	\$1349	\$1498	\$1645	\$1794	\$1944	\$2093	\$2241	\$2389	\$2538	\$2686	\$2828

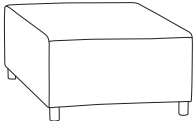

**8348** 36" Square Ottoman

COM Yardage: Total: 3.75 Yds. / Sides: 2.5 Yds. / Top: 1.25 Yds.

COM	GR1	GR2	GR3	GR4	GR5	GR6	GR7	GR8	GR9	GR10	LEA
\$1945	\$2104	\$2261	\$2418	\$2576	\$2734	\$2891	\$3048	\$3205	\$3362	\$3520	\$3671

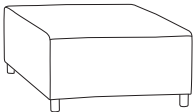

**8350** 42" Square Ottoman

COM Yardage: Total: 4.25 Yds. / Sides: 2.75 Yds. / Top: 1.5 Yds.

COM	GR1	GR2	GR3	GR4	GR5	GR6	GR7	GR8	GR9	GR10	LEA
\$2273	\$2430	\$2587	\$2744	\$2901	\$3059	\$3218	\$3375	\$3532	\$3690	\$3847	\$3998

**OPTIONS**

Add upcharge to list price and code to model number

FR	CAL 133 (TB 133) Fire Retardant per yard	\$101	/yd.
MB	Moisture Barrier - per ottoman	\$141	
WOD	Wood Legs	\$27	ea.
PC	Polished Chrome Legs	\$29	ea.
CAS3	3" Casters	\$29	ea.
2FO	Two Fabric Option	\$110	
GD1	Ganging Device for Metal/Wood Legs	\$58	
GD2	Flat Ganging Device for Soft Seating	\$58	

TABF(-)	Fixed Tablet (outside, specify (L/R), shape A, B or C)	\$416	
TABFB(-)	Fixed Tablet (blade, specify (L/R), shape A, B or C)	\$416	
LAM5	Non-standard laminate (5 tablets or less)	\$281	ea. tablet
SST	Solid Surface Tablet Arm - add to tablet option	\$141	
SS5	Non-standard Solid Surface (5 tablets or less)	Call For Quote	

DIMENSIONS	Straight Benches
Overall Depth:	20"
Overall Width:	22, 44, 66"
Overall Height:	18"
Qty./Wt.:	1 ea./45/60/78 lbs.



THREE SEAT STRAIGHT BENCH

**MODEL / DESCRIPTION / LIST PRICING**

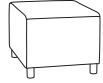

**8352** Single Seat Straight Bench

COM Yardage: Total: 2.25 Yds. / Sides: 1.5 Yds. / Top: .75 Yds.

COM	GR1	GR2	GR3	GR4	GR5	GR6	GR7	GR8	GR9	GR10	LEA
\$1005	\$1092	\$1179	\$1277	\$1364	\$1463	\$1562	\$1661	\$1760	\$1859	\$1958	\$2100



**8354** Two Seat Straight Bench

COM Yardage: Total: 3.25 Yds. / Sides: 1.75 Yds. / Top: 1.5 Yds.

COM	GR1	GR2	GR3	GR4	GR5	GR6	GR7	GR8	GR9	GR10	LEA
\$1868	\$2025	\$2183	\$2339	\$2496	\$2654	\$2812	\$2968	\$3126	\$3285	\$3442	\$3591



**8356** Three Seat Straight Bench

COM Yardage: Total: 4.5 Yds. / Sides: 2.5 Yds. / Top: 2 Yds.

COM	GR1	GR2	GR3	GR4	GR5	GR6	GR7	GR8	GR9	GR10	LEA
\$2195	\$2353	\$2510	\$2668	\$2825	\$2982	\$3140	\$3298	\$3455	\$3611	\$3769	\$3921

**OPTIONS**

Add upcharge to list price and code to model number

FR	CAL 133 (TB 133) Fire Retardant per yard	\$101	/yd.	TABF(-)	Fixed Tablet (outside, specify (L/R), shape A, B or C)	\$416	
MB	Moisture Barrier - up to 60" width	\$141	ea.	TABFB(-)	Fixed Tablet (blade, specify (L/R), shape A, B or C)	\$416	
MB60	Moisture Barrier - over 60" width	\$225	ea.	LAM5	Non-standard laminate (5 tablets or less)	\$281	ea. tablet
WOD	Wood Legs	\$27	ea.	SST	Solid Surface Tablet Arm - add to tablet option	\$141	
PC	Polished Chrome Legs	\$29	ea.	SS5	Non-standard Solid Surface (5 tablets or less)	Call For Quote	
CAS3	3" Casters	\$29	ea.				
2FO	Two Fabric Option	\$110					
GD1	Ganging Device for Metal/Wood Legs	\$58					
GD2	Flat Ganging Device for Soft Seating	\$58					

**OPTIONS**

- CODE: FR - CAL 133 (TB 133) Fire Retardant
- CODE: MB - Moisture Barrier
- CODE: LOW - Fully Upholstered Low Back - 27" OA Height
- CODE: WOD - Wood Legs
- CODE: PC - Polished Chrome Legs
- CODE: CAS3 - 3" Casters
- CODE: 2FO - Two Fabric Option
- CODE: WAC - Wood Arm Caps
- CODE: PAC - Poly Arm Caps - Standard Black/Charcoal
- CODE: 3FO - Three Fabric Option
- CODE: GD1 - Ratchet Ganging Device for Soft Seating
- CODE: GD2 - Flat Ganging Device for Soft Seating

- CODE: GD3 - Flat Ganging Device for Café & Training Tables
- CODE: TAB-(\_) - Non-Removable Swivel Tablet (laminated shape A, B or C left or right arm)
- CODE: TABR1-(\_) - Removable Swivel Tablet (laminated shape A, B or C specify left or right arm)
- CODE: TABR2-(\_) - Removable Swivel Tablet (laminated shape A, B or C with opening for tablet on both arms)
- CODE: LAM5 - Non-standard laminate for 5 or less tablets see options for upcharge
- CODE: SST - Solid Surface Tablet Arm - add to tablet option.
- CODE: SS5 - Non-standard Solid Surface top for 5 or less tablets
- CODE: CO - Clean Out (overall width up to 50")
- CODE: CO1 - Clean Out (overall width over 50")

**Note:**

- Tablet orders of 5 or less - choice of 4 standard laminate colors: Wilsonart Black 1595-60, Formica Brite White 459-58, Wilsonart Montana Walnut 7110K-78 or Nevamar Silver Alu Metalx MXT003.
- Tablet orders of 6 or more - any choice standard laminate colors.

Note: Factory installed power/data available, see accessories online under the 'Products' tab.



RAVEN LOUNGE



RAVEN TWO SEAT LOUNGE

**TABLET SHAPES**

**Three Tablet Shapes::**

Choose from the three shapes shown and specify; A, B or C and left or right (outside tablet) when ordering.  
Example: TABF-(A) Left - this would be a fixed shape A tablet on the left side (when seated).

**Laminate Top:**

- Tablet orders of 5 or less have 4 standard laminate colors:
- Wilsonart Black 1595-60
  - Wilsonart Montana Walnut 7110K-78
  - Formica Brite White 459-58
  - Nevamar Silver Alu Metalx MXT003

**Solid Surface Top:**

- Tablet orders of 5 or less have 4 standard Corian colors:
- Bone
  - Bronzite
  - Glacier White
  - Silver Grey

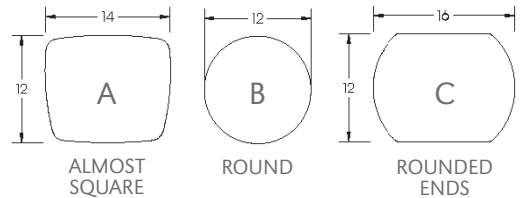

**Note:** Tablets can not be used with Arm Caps.



LOW-BACK



CASTERS

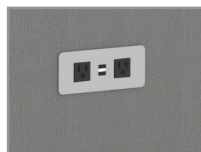

ELECTRICAL/DATA

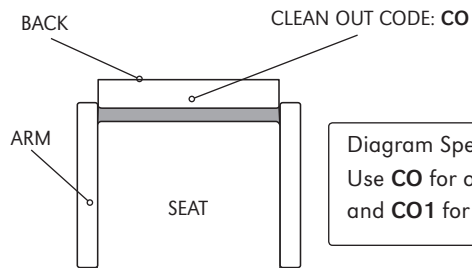

Diagram Specifies A Clean Out  
Use **CO** for overall widths up to 50"  
and **CO1** for overall widths over 50"

DIMENSIONS	Single Seat Lounge	Two Seat Lounge
Seat Depth:	20"	20"
Seat Height:	18"	18"
Arm Height:	25"	25"
Overall Depth:	27"	27"
Overall Width:	27"	49"
Overall Height:	33"	33"
Qty./Wt.:	1 ea./65 lbs.	1 ea./105 lbs.



RAVEN SINGLE LOUNGE  
WITH OPTIONAL LOW BACK

**MODEL / DESCRIPTION / LIST PRICING**



**8403** Single Seat Lounge



COM Yardage: Total: 7 Yds. / Back: 2 Yds. / Seat: 2 Yds./ Arms(2) 3 Yds.

COM	GR1	GR2	GR3	GR4	GR5	GR6	GR7	GR8	GR9	GR10	LEA
\$1868	\$2065	\$2234	\$2444	\$2616	\$2799	\$2983	\$3166	\$3376	\$3586	\$3797	\$4182

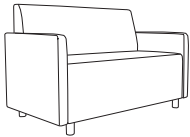

**8401** Two Seat Lounge

COM Yardage: Total: 10 Yds. / Back: 4 Yds. / Seat: 3 Yds. / Arms(2) 3 Yds.

COM	GR1	GR2	GR3	GR4	GR5	GR6	GR7	GR8	GR9	GR10	LEA
\$2727	\$2990	\$3226	\$3490	\$3724	\$3961	\$4198	\$4433	\$4696	\$4959	\$5221	\$5608

**OPTIONS**

Add upcharge to list price and code to model number

FR	CAL 133 (TB 133) Fire Retardant per yard	\$101	/yd.
MB	Moisture Barrier - per seat	\$141	
LOW	Fully Upholstered Low Back - 27" OA Height	\$107	
WOD	Wood Legs	\$27	ea.
PC	Polished Chrome Legs	\$29	ea.
PB	Laminate Plinth Base - Straight Unit	\$180	
CAS3	3" Casters	\$29	ea.
2FO	Two Fabric Option	\$110	
3FO	Three Fabric Option	\$166	
GD1	Ganging Device for Metal/Wood Legs	\$58	
GD2	Flat Ganging Device for Soft Seating	\$58	

TAB(-)	Swivel Tablet (specify A, B or C, left or right arm)	\$444	
TABR1(-)	Removable Tablet (specify A, B or C, left or right arm)	\$528	
TABR2(-)	Removable Tablet (specify A, B or C both arm openings)	\$640	
LAM5	Non-standard laminate (5 tablets or less)	\$281	ea. tablet
SST	Solid Surface Tablet Arm - add to tablet option	\$141	
SS5	Non-standard Solid Surface (5 tablets or less)	Call For Quote	
WAC	Wood Arm Cap	\$100	ea.
PAC	Poly Arm Cap - Standard Black/Charcoal	\$77	ea.
CO	Clean Out (overall width up to 50")	\$281	
CO1	Clean Out (overall width over 50")	\$432	

**RAVEN JUNIOR COLLECTION**

The Raven Junior Lounge Series offers great creativity and flexibility in children's seating. Designed for children's areas and any public spaces that require durable seating.



60° CURVE UNIT



RAVEN JUNIOR



RAVEN JUNIOR  
MODULAR CONFIGURATION

**ORDERING INFORMATION**

- |                            |                               |
|----------------------------|-------------------------------|
| 1) Series Name             | 5) Powder Coat Color for legs |
| 2) Model Number            | 6) Optional Items             |
| 3) Quantity                |                               |
| 4) Fabric Grade and Number |                               |

**RAVEN MODULAR LOUNGE SPECIFICATIONS**

**Frame Construction**

Frame assembly is constructed of multi-ply hardwood, with tongue and groove construction. All foam is fully bonded to frame. Seat cushions are 4" graded high resiliency (H.R.) block foam with back 3" (H.R.) foam, covered entirely with special bonded polyester fiber to protect final upholstery. No sag-springs are installed in seat & back along with interlocking helicoil springs to prevent sagging and provide additional lower back and seat support.

**Upholstery**

Seat and back are covered in choice of fabric, vinyl, crypton, leather or COM. ERG uses only water based glues and adhesives in our upholstery process.

**Legs**

2"RD X 3"H round tubular steel legs are standard and available in standard powder coat colors. Optional polished chrome and wood legs are also available. Legs have a factory installed poly vinyl glide.

**COLORS / FINISHES**

**Legs**

Standard powder coat colors or optional polished chrome available. Wood legs are finished in your choice of standard wood stain colors.

**OPTIONS**

- CODE: FR - CAL 133 (TB 133) Fire Retardant.
- CODE: MB - Moisture Barrier (Up To 60" Overall Width).
- CODE: WOD - Wood Legs.
- CODE: PC - Polished Chrome Legs.
- CODE: CAS3 - 3" Black Casters.
- CODE: 2FO - Two Fabric Option.
- CODE: GD1 - Ratchet Ganging Device for Soft Seating
- CODE: GD2 - Flat Ganging Device for Soft Seating



SINGLE UNIT

DIMENSIONS	Single Unit	Two Seat Unit	Two Seat Backless Unit	Square Ottoman	Round Ottomans
Seat Depth:	17.5"	17.5"	24"	-	-
Seat Height:	16"	16"	16"	-	-
Overall Depth:	24"	24"	24"	24"	18"
Overall Width:	18"	42"	42"	24"	18"
Overall Height:	27.5"	27.5"	16"	16"	16"
Qty./Wt.:	1 ea./35 lbs.	1 ea./60 lbs.	1 ea./55 lbs.	1 ea./40 lbs.	1 ea./40 lbs.

**MODEL / DESCRIPTION / LIST PRICING**



**8400** Single Unit (4 Legs)

COM Yardage: Total: 3 Yds. / Back: 1.5 Yds. / Seat: 1.5 Yds.

COM	GR1	GR2	GR3	GR4	GR5	GR6	GR7	GR8	GR9	GR10	LEA
\$1084	\$1161	\$1207	\$1255	\$1306	\$1359	\$1414	\$1469	\$1527	\$1589	\$1653	\$1954



**8402** Two Seat Unit (4 legs)

COM Yardage: Total: 4.5 Yds. / Back: 2.5 Yds. / Seat: 2 Yds.

COM	GR1	GR2	GR3	GR4	GR5	GR6	GR7	GR8	GR9	GR10	LEA
\$1727	\$1847	\$1920	\$1998	\$2078	\$2160	\$2248	\$2337	\$2431	\$2529	\$2629	\$3109



**8404** Two Seat Backless Unit (4 legs)

COM Yardage: Total: 3.5 Yds. / Top: 1.5 Yds. / Sides: 2 Yds.

COM	GR1	GR2	GR3	GR4	GR5	GR6	GR7	GR8	GR9	GR10	LEA
\$1486	\$1583	\$1643	\$1702	\$1767	\$1834	\$1904	\$1975	\$2049	\$2128	\$2207	\$2592

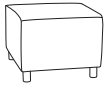

**8406** 24" Square Ottoman - 16" height (4 legs)

COM Yardage: Total: 2.75 Yds. / Top: .75 Yds. / Sides: 1.5 Yds.

COM	GR1	GR2	GR3	GR4	GR5	GR6	GR7	GR8	GR9	GR10	LEA
\$987	\$1048	\$1087	\$1126	\$1166	\$1208	\$1254	\$1297	\$1346	\$1396	\$1446	\$1691

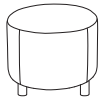

**8341-S** 18" Round Ottoman - 16" height (4 legs)

COM Yardage: Total: 2.75 Yds. / Sides: 2 Yds. / Top: .75 Yds.

COM	GR1	GR2	GR3	GR4	GR5	GR6	GR7	GR8	GR9	GR10	LEA
\$1002	\$1149	\$1298	\$1447	\$1595	\$1743	\$1892	\$2040	\$2189	\$2339	\$2486	\$2629

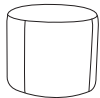

**8341-NLS** 18" Round Ottoman - 16" height / No Legs

COM Yardage: Total: 2.75 Yds. / Sides: 2 Yds. / Top: .75 Yds.

COM	GR1	GR2	GR3	GR4	GR5	GR6	GR7	GR8	GR9	GR10	LEA
\$934	\$1066	\$1195	\$1326	\$1459	\$1588	\$1719	\$1848	\$1981	\$2112	\$2241	\$2366

**OPTIONS**

Add upcharge to list price and code to model number

FR	CAL 133 (TB 133) Fire Retardant per yard	\$101	/yd.
MB	Moisture Barrier - up to 60" overall width	\$141	
2FO	Two Fabric Option	\$110	
GD1	Ganging Device for Metal/Wood Legs	\$58	
GD2	Flat Ganging Device for Soft Seating	\$58	

PC	Polished Chrome Legs	\$29	ea.
CAS3	3" Black Casters	\$29	ea.
WOD	Solid Wood Legs	\$27	ea.

DIMENSIONS	30° curve unit (inside / outside)	60° curve unit (inside / outside)	Backless 30° unit	Backless 60° unit
Seat Depth:	17.5"	17.5"	24"	24"
Seat Height:	16"	16"	16"	16"
Overall Depth:	26"	28"	26"	28"
Overall Width:	24.5"	47"	34.5"	47"
Overall Height:	27.5"	27.5"	16"	16"
Qty./Wt.:	1 ea./62 lbs.	1 ea./110 lbs.	1 ea./35 lbs.	1 ea./55 lbs.



60° CURVE UNIT

### MODEL / DESCRIPTION / LIST PRICING



**8408** 30° inside curve unit (4 Legs)

COM Yardage: Total: 4 Yds. / Back: 2 Yds. / Seat: 2 Yds.

COM	GR1	GR2	GR3	GR4	GR5	GR6	GR7	GR8	GR9	GR10	LEA
\$1106	\$1182	\$1230	\$1278	\$1330	\$1383	\$1439	\$1496	\$1555	\$1619	\$1682	\$1990



**8410** 30° outside curve unit (4 Legs)

COM Yardage: Total: 4.5 Yds. / Back: 2 Yds. / Seat: 2.5 Yds.

COM	GR1	GR2	GR3	GR4	GR5	GR6	GR7	GR8	GR9	GR10	LEA
\$1106	\$1182	\$1230	\$1278	\$1330	\$1383	\$1439	\$1496	\$1555	\$1619	\$1682	\$1990

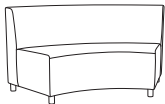

**8412** 60° inside curve unit (5 Legs)

COM Yardage: Total: 6.5 Yds. / Back: 4 Yds. / Seat: 2.5 Yds.

COM	GR1	GR2	GR3	GR4	GR5	GR6	GR7	GR8	GR9	GR10	LEA
\$1863	\$1994	\$2073	\$2156	\$2242	\$2332	\$2425	\$2523	\$2624	\$2727	\$2839	\$3355

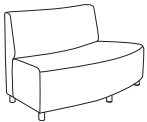

**8414** 60° outside curve unit (5 Legs)

COM Yardage: Total: 7 Yds. / Back: 3 Yds. / Seat: 4 Yds.

COM	GR1	GR2	GR3	GR4	GR5	GR6	GR7	GR8	GR9	GR10	LEA
\$2022	\$2153	\$2232	\$2315	\$2401	\$2491	\$2584	\$2682	\$2783	\$2886	\$2998	\$3514

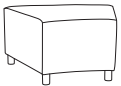

**8416** Backless 30° unit (4 Legs)

COM Yardage: Total: 3 Yds. / Top: 1 Yds. / Sides: 2 Yds.

COM	GR1	GR2	GR3	GR4	GR5	GR6	GR7	GR8	GR9	GR10	LEA
\$996	\$1066	\$1109	\$1153	\$1200	\$1248	\$1295	\$1348	\$1402	\$1459	\$1517	\$1792



**8418** Backless 60° unit (5 Legs)

COM Yardage: Total: 4.75 Yds. / Top: 2 Yds. / Sides: 2.75 Yds.

COM	GR1	GR2	GR3	GR4	GR5	GR6	GR7	GR8	GR9	GR10	LEA
\$1570	\$1679	\$1748	\$1817	\$1889	\$1964	\$2044	\$2124	\$2209	\$2297	\$2388	\$2826

### OPTIONS

Add upcharge to list price and code to model number

FR	CAL 133 (TB 133) Fire Retardant per yard	\$101	/yd.
MB	Moisture Barrier - up to 60" overall width	\$141	
2FO	Two Fabric Option	\$110	
GD1	Ganging Device for Metal/Wood Legs	\$58	
GD2	Flat Ganging Device for Soft Seating	\$58	

PC	Polished Chrome Legs	\$29	ea.
CAS3	3" Black Casters	\$29	ea.
WOD	Solid Wood Legs	\$27	ea.