



Model #28725 Vox® Credenza on legs, see page 294

Model #50514/2 Vox® Conference Table with Taper legs, see page 81

Both items F-18, Natural White Oak



Model #28702 Vox® Credenza on Legs, see page 292

F-20 Natural Ribbon Stripe Sapele

Berkley armless sofa, see Nienkämper Seating Price List



Self Edge Top

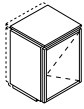
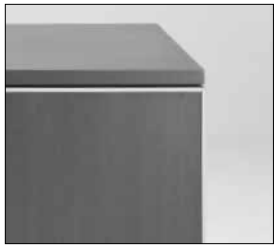

Available in two depths as illustrated

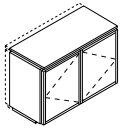

Available in two depths as illustrated

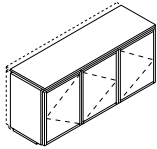

Available in two depths as illustrated

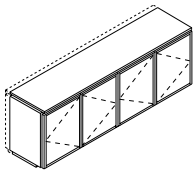

Available in two depths as illustrated

Model Number	Cabinet Finish	Top Finish	L" x	D" x	H"	List Price	Product Description
* 23501/2	Wood	Wood	23½"	20"	34¼"	<b>3,330</b>	Vox credenzas are available in two standard depths: 20" and 25¾"
23501/3	Paint	Wood				<b>2,990</b>	
23501/5	Wood	Laminate				<b>3,160</b>	
23501/4	Paint	Laminate				<b>2,850</b>	
Frosted Glass Doors - Add "/G" to model # and \$105 to price.							
* 23431	Wood	Wood	23½"	25¾"	34¼"	<b>3,785</b>	Standard finish options are selected by model number and include: • Wood case with wood top • Painted case with wood top • Wood case with laminate top • Painted case with laminate top
23431/3	Paint	Wood				<b>3,415</b>	
23431/5	Wood	Laminate				<b>3,585</b>	
23431/4	Paint	Laminate				<b>3,235</b>	
Frosted Glass Doors - Add "/G" to model # and \$105 to price.							
* 23502/2	Wood	Wood	47½"	20"	34¼"	<b>4,400</b>	Choose standard wood veneers, plastic laminates and aluminum/ paint finishes from pages 10-12.
23502/3	Paint	Wood				<b>3,970</b>	
23502/5	Wood	Laminate				<b>4,180</b>	Credenza doors include aluminum trim around the perimeter that is available in all of the standard aluminum finishes on page 13.
23502/4	Paint	Laminate				<b>3,970</b>	
Frosted Glass Doors - Add "/G" to model # and \$210 to price.							
* 23432	Wood	Wood	47½"	25¾"	34¼"	<b>5,005</b>	Doors may be specified with optional glass panels in a variety of transparencies and colours. Contact Nienkamper Customer Service (1-800-668-9318) for specific information regarding glass doors options.
23432/3	Paint	Wood				<b>4,505</b>	
23432/5	Wood	Laminate				<b>4,755</b>	
23432/4	Paint	Laminate				<b>4,505</b>	
Frosted Glass Doors - Add "/G" to model # and \$210 to price.							
* 23503/2	Wood	Wood	70¾"	20"	34¼"	<b>6,170</b>	Doors are standard with push latches. A variety of optional pulls are specified on page 302. Glass doors are not available with pulls
23503/3	Paint	Wood				<b>5,520</b>	
23503/5	Wood	Laminate				<b>5,875</b>	
23503/4	Paint	Laminate				<b>5,275</b>	
Frosted Glass Doors - Add "/G" to model # and \$310 to price.							
* 23433	Wood	Wood	70¾"	25¾"	34¼"	<b>7,020</b>	Cabinets are built in sections not exceeding three pedestal widths, with tops shipped separately. Tops longer than 118" in length are made in two pieces.
23433/3	Paint	Wood				<b>6,260</b>	
23433/5	Wood	Laminate				<b>6,660</b>	
23433/4	Paint	Laminate				<b>5,990</b>	
Frosted Glass Doors - Add "/G" to model # and \$310 to price.							
** 23504/2	Wood	Wood	94¾"	20"	34¼"	<b>7,265</b>	To enhance the function of your credenza a range of optional interiors can be selected on pages 304-309.
23504/3	Paint	Wood				<b>6,530</b>	
23504/5	Wood	Laminate				<b>6,895</b>	
23504/4	Paint	Laminate				<b>6,225</b>	
Frosted Glass Doors - Add "/G" to model # and \$415 to price.							
** 23434	Wood	Wood	94¾"	25¾"	34¼"	<b>8,240</b>	<b>Refrigerators page 300 and Equipment storage racks pages 304-305 are not available in 20" deep credenzas.</b>
23434/3	Paint	Wood				<b>7,430</b>	
23434/5	Wood	Laminate				<b>7,845</b>	
23434/4	Paint	Laminate				<b>7,055</b>	
Frosted Glass Doors - Add "/G" to model # and \$415 to price.							



**Model # 23444**

Vox four-pedestal credenza in walnut veneer with silver anodized aluminum trim.

\* Cabinet in 1 piece, Top in 1 piece

\*\* Cabinet in 2 pieces, Top in 1 piece

# VOX® CREDENZAS ON GLIDES



Self Edge Top

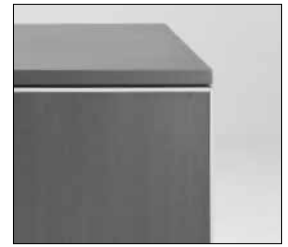

	Model Number	Cabinet Finish	Top Finish	L" x D" x H"	List Price	Product Description
<p>Available in two depths as illustrated</p>	** 23505/2	Wood	Wood	118" 20" 34¼"	8,735	Vox credenzas are available in two standard depths 20" and 25 <sup>3</sup> / <sub>8</sub> " Standard finish options are selected by model number and include: <ul style="list-style-type: none"> <li>• Wood case with wood top</li> <li>• Painted case with wood top</li> <li>• Wood case with laminate top</li> <li>• Painted case with laminate top</li> </ul>
	23505/3	Paint	Wood		7,865	
	23505/5	Wood	Laminate		8,305	
	23505/4	Paint	Laminate		7,470	
	Frosted Glass Doors - Add "/G" to model # and \$515 to price.					
<p>Available in two depths as illustrated</p>	** 23435	Wood	Wood	118" 25 <sup>3</sup> / <sub>8</sub> " 3¼"	9,925	<b>For credenzas with Fingerprint Resistance P-Lam, please contact customer service for upcharge.</b>  Choose standard wood veneers, plastic laminates and aluminum/ paint finishes from page 10-12.  Credenza doors include aluminum trim around the perimeter that is available in all of the standard aluminum finishes on page 13.  Doors may be specified with optional glass panels in a variety of transparencies and colours. Contact Nienkamper Customer Service (1-800-668-9318) for specific information regarding glass doors options.  Doors are standard with push latches. A variety of optional pulls are specified on page 302. Glass doors are not available with pulls.  Cabinets are built in sections not exceeding three pedestal widths, with tops shipped separately. Tops longer than 118" in length are made in two pieces.  To enhance the function of your credenza a range of optional interiors can be selected on pages 304-309.  <b>Credenza 20" deep cannot accommodate refrigerators and equipment storage racks.</b>
	23435/3	Paint	Wood		8,940	
	23435/5	Wood	Laminate		9,425	
	23435/4	Paint	Laminate		8,490	
	Frosted Glass Doors - Add "/G" to model # and \$515 to price.					
<p>Available in two depths as illustrated</p>	*** 23506/2	Wood	Wood	141 <sup>5</sup> / <sub>8</sub> " 20" 34¼"	10,120	<b>Standard features:</b> <ul style="list-style-type: none"> <li>• Easily leveled from interior of cabinet</li> <li>• One adjustable shelf per opening</li> <li>• Top is self-edged on four sides</li> <li>• Single pedestal interior dimensions:                             <ul style="list-style-type: none"> <li>25<sup>3</sup>/<sub>8</sub>" deep - 22" W x 23<sup>1</sup>/<sub>2</sub>" D x 28<sup>3</sup>/<sub>4</sub>" H</li> <li>20" deep - 22" W x 18<sup>1</sup>/<sub>8</sub>" D x 28<sup>3</sup>/<sub>4</sub>" H</li> </ul> </li> </ul>
	23506/3	Paint	Wood		9,120	
	23506/5	Wood	Laminate		9,625	
	23506/4	Paint	Laminate		8,655	
	Frosted Glass Doors - Add "/G" to model # and \$620 to price.					
<p>Available in two depths as illustrated</p>	*** 23436	Wood	Wood	141 <sup>5</sup> / <sub>8</sub> " 25 <sup>3</sup> / <sub>8</sub> " 34¼"	11,510	Credenza 20" deep cannot accommodate refrigerators and equipment storage racks.
	23436/3	Paint	Wood		10,350	
	23436/5	Wood	Laminate		10,920	
	23436/4	Paint	Laminate		9,830	
	Frosted Glass Doors - Add "/G" to model # and \$620 to price.					
<p>Available in two depths as illustrated</p>	**** 23507/2	Wood	Wood	165 <sup>1</sup> / <sub>4</sub> " 20" 34¼"	11,370	Credenza 20" deep cannot accommodate refrigerators and equipment storage racks.
	23507/3	Paint	Wood		10,225	
	23507/5	Wood	Laminate		10,800	
	23507/4	Paint	Laminate		9,915	
	Frosted Glass Doors - Add "/G" to model # and \$725 to price.					
<p>Available in two depths as illustrated</p>	**** 23437	Wood	Wood	165 <sup>1</sup> / <sub>4</sub> " 25 <sup>3</sup> / <sub>8</sub> " 34¼"	12,900	Credenza 20" deep cannot accommodate refrigerators and equipment storage racks.
	23437/3	Paint	Wood		11,615	
	23437/5	Wood	Laminate		12,275	
	23437/4	Paint	Laminate		11,255	
	Frosted Glass Doors - Add "/G" to model # and \$725 to price.					
<p>Available in two depths as illustrated</p>	**** 23508/2	Wood	Wood	188 <sup>3</sup> / <sub>8</sub> " 20" 34¼"	12,675	Credenza 20" deep cannot accommodate refrigerators and equipment storage racks.
	23508/3	Paint	Wood		11,405	
	23508/5	Wood	Laminate		12,055	
	23508/4	Paint	Laminate		10,850	
	Frosted Glass Doors - Add "/G" to model # and \$825 to price.					
<p>Available in two depths as illustrated</p>	**** 23438	Wood	Wood	188 <sup>3</sup> / <sub>8</sub> " 25 <sup>3</sup> / <sub>8</sub> " 34¼"	14,410	Credenza 20" deep cannot accommodate refrigerators and equipment storage racks.
	23438/3	Paint	Wood		12,980	
	23438/5	Wood	Laminate		13,680	
	23438/4	Paint	Laminate		12,310	
	Frosted Glass Doors - Add "/G" to model # and \$825 to price.					

\*\* Cabinet in 2 pieces, Top in 1 piece  
 \*\*\* Cabinet in 2 pieces, Top in 2 pieces  
 \*\*\*\* Cabinet in 3 pieces, Top in 2 pieces



Model # 701  
 Vox Serving/Storage Tray placed on a Vox credenza with silver anodized trim. Both items finished in Natural Figured Sycamore.

# VOX® CREDENZAS ON CASTERS

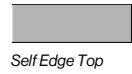
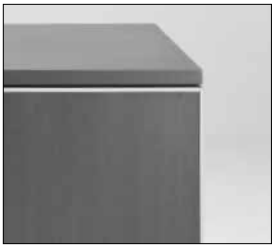

Self Edge Top

Model Number	Cabinet Finish	Top Finish	L" x	D" x	H"	List Price	Product Description
* 23441	Wood	Wood	23½"	25¾"	34¼"	<b>4,360</b>	Vox credenzas on casters are available only in standard depth of 25¾"
23441/3	Paint	Wood				<b>3,925</b>	
23441/5	Wood	Laminate				<b>4,145</b>	
23441/4	Paint	Laminate				<b>3,725</b>	
Frosted Glass Doors - Add "/G" to model # and \$105 to price.							
* 23442	Wood	Wood	47½"	25¾"	34¼"	<b>5,645</b>	Standard finish options are selected by model number and include: <ul style="list-style-type: none"> <li>• Wood case with wood top</li> <li>• Painted case with wood top</li> <li>• Wood case with laminate top</li> <li>• Painted case with laminate top</li> </ul>
23442/3	Paint	Wood				<b>5,070</b>	
23442/5	Wood	Laminate				<b>5,370</b>	
23442/4	Paint	Laminate				<b>4,830</b>	
Frosted Glass Doors - Add "/G" to model # and \$210 to price.							
<b>For credenzas with Fingerprint Resistance P-Lam, please contact customer service for upcharge.</b>							
Choose standard wood veneers, plastic laminates and aluminum/ paint finishes from page 10-12.							
Credenza doors include aluminum trim around the perimeter that is available in all of the standard aluminum finishes on page 13.							
Doors may be specified with optional glass panels in a variety of transparencies and colours. Contact Nienkamper Customer Service (1-800-668-9318) for specific information regarding glass doors options.							
Doors are standard with push latches. A variety of optional pulls are specified on page 302.							
Glass doors are not available with pulls							
Cabinets are built in sections not exceeding three pedestal widths, with tops shipped separately. Tops longer than 118" in length are made in two pieces.							
To enhance the function of your credenza a range of optional interiors can be selected on pages 304-309.							
* 23443	Wood	Wood	70¾"	25¾"	34¼"	<b>7,620</b>	Cabinets are built in sections not exceeding three pedestal widths, with tops shipped separately. Tops longer than 118" in length are made in two pieces.
23443/3	Paint	Wood				<b>6,855</b>	
23443/5	Wood	Laminate				<b>7,005</b>	
23443/4	Paint	Laminate				<b>6,500</b>	
Frosted Glass Doors - Add "/G" to model # and \$310 to price.							
* 23444	Wood	Wood	94¾"	25¾"	34¼"	<b>8,695</b>	To enhance the function of your credenza a range of optional interiors can be selected on pages 304-309.
23444/3	Paint	Wood				<b>7,825</b>	
23444/5	Wood	Laminate				<b>8,250</b>	
23444/4	Paint	Laminate				<b>7,440</b>	
Frosted Glass Doors - Add "/G" to model # and \$415 to price.							

**Standard features:**

- 4" non-marking industrial strength casters
- One adjustable shelf per opening
- Top is self-edged on four sides
- Single pedestal interior dimensions: 25¾" deep - 22" W x 23½" D x 28¾" H

\* Cabinet in 1 piece, Top in 1 piece  
 \*\* Cabinet in 2 pieces, Top in 1 piece

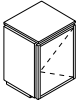

Available in one depth only

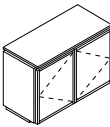

Available in one depth only

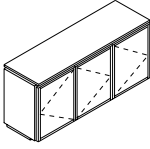

Available in one depth only

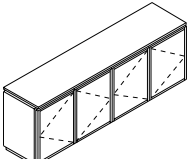

Available in one depth only



Model # 23444  
 Vox four-pedestal credenza in Walnut finish with silver anodized aluminum trim.

# VOX® CREDENZAS ON LEGS – 20¼” HIGH

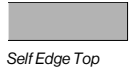

Self Edge Top

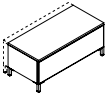

Available in two depths as illustrated

Model Number	Cabinet Finish	Top Finish	L" x	D" x	H"	List Price	Product Description
* 28741/2	Wood	Wood	47¾"	19¾"	20¼"	<b>3,960</b>	Vox credenzas on legs are available in two standard depths: 19¾" and 25¼" and three standard heights 20¼", 29" and 34¼".
28741/3	Paint	Wood				<b>3,555</b>	
28741/5	Wood	Laminate				<b>3,755</b>	
28741/4	Paint	Laminate				<b>3,380</b>	

- Standard finish options are selected by model number and include:
- Wood case with wood top
  - Painted case with wood top
  - Wood case with laminate top
  - Painted case with laminate top

* 28701	Wood	Wood	47¾"	25¼"	20¼"	<b>4,490</b>	<b>For credenzas with Fingerprint Resistance P-Lam, please contact customer service for upcharge.</b>
28701/3	Paint	Wood				<b>4,040</b>	
28701/5	Wood	Laminate				<b>4,270</b>	
28701/4	Paint	Laminate				<b>3,840</b>	

Choose standard wood veneers, plastic laminates, and aluminum/ paint finishes from pages 10-12.

Credenza drawers include aluminum trim around the perimeter that is available in all of the standard aluminum finishes on page 13.

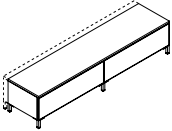

Available in two depths as illustrated

** 28742/2	Wood	Wood	94¾"	19¾"	20¼"	<b>7,095</b>	A variety of pulls are specified on page 302.
28742/3	Paint	Wood				<b>6,390</b>	
28742/5	Wood	Laminate				<b>6,730</b>	
28742/4	Paint	Laminate				<b>6,070</b>	

Cabinets are built in sections not exceeding three pedestal widths with tops shipped separately. Tops longer than 118" in length are made in two pieces.

**Standard features:**

- Easily leveled at the base of each metal leg
- Top is self-edged on four sides
- Extra wide drawer that can accommodate a range of storage requirements including legal and letter file storage

** 28702	Wood	Wood	94¾"	25¼"	20¼"	<b>8,050</b>	
28702/3	Paint	Wood				<b>7,250</b>	
28702/5	Wood	Laminate				<b>7,650</b>	
28702/4	Paint	Laminate				<b>6,885</b>	

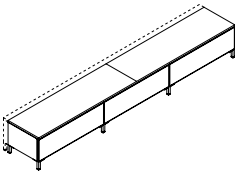

Available in two depths as illustrated

*** 28743/2	Wood	Wood	141½"	19¾"	20¼"	<b>10,605</b>	
28743/3	Paint	Wood				<b>9,540</b>	
28743/5	Wood	Laminate				<b>10,075</b>	
28743/4	Paint	Laminate				<b>9,065</b>	

*** 28703	Wood	Wood	141½"	25¼"	20¼"	<b>12,055</b>	
28703/3	Paint	Wood				<b>10,850</b>	
28703/5	Wood	Laminate				<b>11,440</b>	
28703/4	Paint	Laminate				<b>10,310</b>	



Model # 28701  
Shown in Rift Cut Oak with Swivel Pulls, FP-5, and silver anodized aluminum trim.

Model # 28725  
Shown in Rift Cut Oak with Swivel Pulls, FP-5, and silver anodized aluminum trim.

\* Cabinet in 1 piece, Top in 1 piece  
\*\* Cabinet in 2 pieces, Top in 1 piece  
\*\*\* Cabinet in 2 pieces, Top in 2 pieces

# VOX® CREDENZAS ON LEGS – 29" HIGH



Self Edge Top

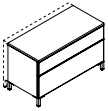

Available in two depths as illustrated

Model Number	Cabinet Finish	Top Finish	L" x	D" x	H"	List Price	Product Description
* 28751/2	Wood	Wood	47 <sup>3</sup> / <sub>16</sub> "	19 <sup>3</sup> / <sub>4</sub> "	29"	<b>4,390</b>	Vox credenzas on legs are available in two standard depths: 19 <sup>3</sup> / <sub>4</sub> " and 25 <sup>1</sup> / <sub>4</sub> " and three standard heights: 20 <sup>1</sup> / <sub>2</sub> ", 29" and 34 <sup>1</sup> / <sub>4</sub> ".
28751/3	Paint	Wood				<b>3,960</b>	
28751/5	Wood	Laminate				<b>4,175</b>	
28751/4	Paint	Laminate				<b>3,755</b>	

- Standard finish options are selected by model number and include:
- Wood case with wood top
  - Painted case with wood top
  - Wood case with laminate top
  - Painted case with laminate top

* 28711	Wood	Wood	47 <sup>3</sup> / <sub>16</sub> "	25 <sup>1</sup> / <sub>4</sub> "	29"	<b>4,990</b>
28711/3	Paint	Wood				<b>4,490</b>
28711/5	Wood	Laminate				<b>4,745</b>
28711/4	Paint	Laminate				<b>4,270</b>

**For credenzas with Fingerprint Resistance P-Lam, please contact customer service for upcharge.**

Choose standard wood veneers, plastic laminates and aluminum/ paint finishes from page 10-12.

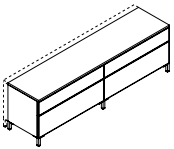

Available in two depths as illustrated

** 28752/2	Wood	Wood	94 <sup>9</sup> / <sub>16</sub> "	19 <sup>3</sup> / <sub>4</sub> "	29"	<b>7,870</b>
28752/3	Paint	Wood				<b>7,090</b>
28752/5	Wood	Laminate				<b>7,485</b>
28752/4	Paint	Laminate				<b>6,730</b>

Credenza doors include aluminum trim around the perimeter that is available in all of the standard aluminum finishes on page 13.

Where applicable, doors may be specified with optional glass panels in a variety of transparencies and colours. Contact Nienkamper Customer Service (1-800-668-9318) for specific information regarding glass doors options.

** 28712	Wood	Wood	94 <sup>9</sup> / <sub>16</sub> "	25 <sup>1</sup> / <sub>4</sub> "	29"	<b>8,950</b>
28712/3	Paint	Wood				<b>8,055</b>
28712/5	Wood	Laminate				<b>8,500</b>
28712/4	Paint	Laminate				<b>7,655</b>

Doors are standard with push latches. A variety of optional pulls are specified on page 302. Glass doors are not available with pulls

Cabinets are built in sections not exceeding three pedestal widths, with tops shipped separately. Tops longer than 118" in length are made in two pieces.

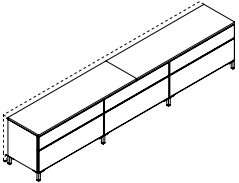

Available in two depths as illustrated

*** 28753/2	Wood	Wood	141 <sup>5</sup> / <sub>16</sub> "	19 <sup>3</sup> / <sub>4</sub> "	29"	<b>11,785</b>
28753/3	Paint	Wood				<b>10,620</b>
28753/5	Wood	Laminate				<b>11,205</b>
28753/4	Paint	Laminate				<b>10,090</b>

To enhance the function of your credenza a range of optional interiors can be selected on pages 304-309.

**Door pedestals cannot accommodate refrigerator or Equipment storage racks.**

*** 28713	Wood	Wood	141 <sup>5</sup> / <sub>16</sub> "	25 <sup>1</sup> / <sub>4</sub> "	29"	<b>13,400</b>
28713/3	Paint	Wood				<b>12,060</b>
28713/5	Wood	Laminate				<b>12,715</b>
28713/4	Paint	Laminate				<b>11,455</b>

**Standard features:**

- Easily leveled at the base of each metal leg
- Top is self-edged on four sides
- Extra wide box and file drawers accommodate a range of storage requirements including legal and letter file storage.
- Single pedestal interior dimensions:  
25<sup>1</sup>/<sub>2</sub>" deep - 22" W x 23<sup>1</sup>/<sub>2</sub>" D x 21<sup>3</sup>/<sub>4</sub>" H  
20" deep - 22" W x 18<sup>1</sup>/<sub>8</sub>" D x 21<sup>3</sup>/<sub>4</sub>" H

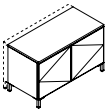

Available in two depths as illustrated

* 28754/2	Wood	Wood	47 <sup>3</sup> / <sub>16</sub> "	19 <sup>3</sup> / <sub>4</sub> "	29"	<b>4,180</b>
28754/3	Paint	Wood				<b>3,765</b>
28754/5	Wood	Laminate				<b>3,975</b>
28754/4	Paint	Laminate				<b>3,570</b>

Frosted Glass Doors - Add "/G" to model # and \$210 to price.

* 28714	Wood	Wood	47 <sup>3</sup> / <sub>16</sub> "	19 <sup>3</sup> / <sub>4</sub> "	29"	<b>4,750</b>
28714/3	Paint	Wood				<b>4,275</b>
28714/5	Wood	Laminate				<b>4,510</b>
28714/4	Paint	Laminate				<b>4,060</b>

Frosted Glass Doors - Add "/G" to model # and \$210 to price.

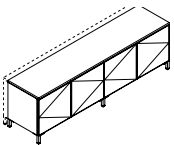

Available in two depths as illustrated

** 28755/2	Wood	Wood	94 <sup>9</sup> / <sub>16</sub> "	19 <sup>3</sup> / <sub>4</sub> "	29"	<b>7,495</b>
28755/3	Paint	Wood				<b>6,735</b>
28755/5	Wood	Laminate				<b>7,120</b>
28755/4	Paint	Laminate				<b>6,420</b>

Frosted Glass Doors - Add "/G" to model # and \$415 to price.

** 28715	Wood	Wood	94 <sup>9</sup> / <sub>16</sub> "	25 <sup>1</sup> / <sub>4</sub> "	29"	<b>8,510</b>
28715/3	Paint	Wood				<b>7,665</b>
28715/5	Wood	Laminate				<b>8,090</b>
28715/4	Paint	Laminate				<b>7,275</b>

Frosted Glass Doors - Add "/G" to model # and \$415 to price.



Model # 28712

Shown in Rift Cut Oak with Flush Pulls, FP-5, and silver anodized aluminum trim.

- \* Cabinet in 1 piece, Top in 1 piece
- \*\* Cabinet in 2 pieces, Top in 1 piece
- \*\*\* Cabinet in 2 pieces, Top in 2 pieces

# VOX® CREDENZAS ON LEGS – 29" HIGH



Self Edge Top

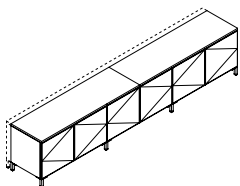

Available in two depths as illustrated

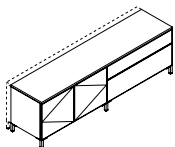

Available in two depths as illustrated

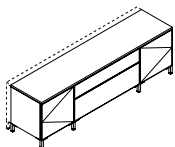

Available in two depths as illustrated

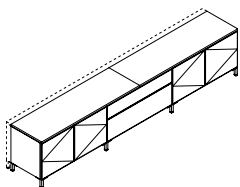

Available in two depths as illustrated

Model Number	Cabinet Finish	Top Finish	L" x	D" x	H"	List Price	Product Description
*** 28756/2	Wood	Wood	141 <sup>5</sup> / <sub>16</sub> "	19 <sup>3</sup> / <sub>4</sub> "	29"	<b>11,225</b>	Vox credenzas on legs are available in two standard depths: 20" and 25 <sup>1</sup> / <sub>4</sub> " and three standard heights: 20 <sup>1</sup> / <sub>4</sub> ", 29" and 34 <sup>1</sup> / <sub>4</sub> ".  Standard finish options are selected by model number and include: • Wood case with wood top • Painted case with wood top • Wood case with laminate top • Painted case with laminate top
28756/3	Paint	Wood				<b>10,100</b>	
28756/5	Wood	Laminate				<b>10,665</b>	
28756/4	Paint	Laminate				<b>9,595</b>	
Frosted Glass Doors - Add "/G" to model # and \$620 to price.							
*** 28716	Wood	Wood	141 <sup>5</sup> / <sub>16</sub> "	25 <sup>1</sup> / <sub>4</sub> "	29"	<b>12,745</b>	<b>For credenzas with Fingerprint Resistance P-Lam, please contact customer service for upcharge.</b>  Choose standard wood veneers, plastic laminates, and aluminum/ paint finishes from pages 10-12.  Credenza doors include aluminum trim around the perimeter that is available in all of the standard aluminum finishes on page 13.  Where applicable doors may be specified with optional glass panels in a variety of transparencies and colours. Contact Nienkamper Customer Service (1-800-668-9318) for specific information regarding glass doors options.  Doors are standard with push latches. A variety of optional pulls are specified on page 302. Glass doors are not available with pulls.  Cabinets are built in sections not exceeding three pedestal widths with tops shipped separately. Tops longer than 118" in length are made in two pieces.  To enhance the function of your credenza a range of optional interiors can be selected on pages 304-309.  <b>Door pedestals cannot accommodate refrigerator or Equipment storage racks.</b>  <b>Standard features:</b> • Easily leveled at the base of each metal leg • Top is self-edged on four sides • Extra wide box and file drawers accommodate a range of storage requirements including legal and letter file storage. • Single pedestal interior dimensions: 25 <sup>1</sup> / <sub>2</sub> " deep - 22" W x 23 <sup>1</sup> / <sub>2</sub> " D x 21 <sup>1</sup> / <sub>4</sub> " H 20" deep - 22" W x 18 <sup>1</sup> / <sub>8</sub> " D x 21 <sup>1</sup> / <sub>4</sub> " H
28716/3	Paint	Wood				<b>11,415</b>	
28716/5	Wood	Laminate				<b>12,110</b>	
28716/4	Paint	Laminate				<b>10,900</b>	
Frosted Glass Doors - Add "/G" to model # and \$620 to price.							
* 28757/2	Wood	Wood	94 <sup>9</sup> / <sub>16</sub> "	19 <sup>3</sup> / <sub>4</sub> "	29"	<b>8,105</b>	Credenza doors include aluminum trim around the perimeter that is available in all of the standard aluminum finishes on page 13.  Where applicable doors may be specified with optional glass panels in a variety of transparencies and colours. Contact Nienkamper Customer Service (1-800-668-9318) for specific information regarding glass doors options.  Doors are standard with push latches. A variety of optional pulls are specified on page 302. Glass doors are not available with pulls.  Cabinets are built in sections not exceeding three pedestal widths with tops shipped separately. Tops longer than 118" in length are made in two pieces.  To enhance the function of your credenza a range of optional interiors can be selected on pages 304-309.  <b>Door pedestals cannot accommodate refrigerator or Equipment storage racks.</b>  <b>Standard features:</b> • Easily leveled at the base of each metal leg • Top is self-edged on four sides • Extra wide box and file drawers accommodate a range of storage requirements including legal and letter file storage. • Single pedestal interior dimensions: 25 <sup>1</sup> / <sub>2</sub> " deep - 22" W x 23 <sup>1</sup> / <sub>2</sub> " D x 21 <sup>1</sup> / <sub>4</sub> " H 20" deep - 22" W x 18 <sup>1</sup> / <sub>8</sub> " D x 21 <sup>1</sup> / <sub>4</sub> " H
28757/3	Paint	Wood				<b>7,290</b>	
28757/5	Wood	Laminate				<b>7,690</b>	
28757/4	Paint	Laminate				<b>6,925</b>	
Frosted Glass Doors - Add "/G" to model # and \$570 to price.							
* 28717	Wood	Wood	94 <sup>9</sup> / <sub>16</sub> "	25 <sup>1</sup> / <sub>4</sub> "	29"	<b>9,195</b>	Credenza doors include aluminum trim around the perimeter that is available in all of the standard aluminum finishes on page 13.  Where applicable doors may be specified with optional glass panels in a variety of transparencies and colours. Contact Nienkamper Customer Service (1-800-668-9318) for specific information regarding glass doors options.  Doors are standard with push latches. A variety of optional pulls are specified on page 302. Glass doors are not available with pulls.  Cabinets are built in sections not exceeding three pedestal widths with tops shipped separately. Tops longer than 118" in length are made in two pieces.  To enhance the function of your credenza a range of optional interiors can be selected on pages 304-309.  <b>Door pedestals cannot accommodate refrigerator or Equipment storage racks.</b>  <b>Standard features:</b> • Easily leveled at the base of each metal leg • Top is self-edged on four sides • Extra wide box and file drawers accommodate a range of storage requirements including legal and letter file storage. • Single pedestal interior dimensions: 25 <sup>1</sup> / <sub>2</sub> " deep - 22" W x 23 <sup>1</sup> / <sub>2</sub> " D x 21 <sup>1</sup> / <sub>4</sub> " H 20" deep - 22" W x 18 <sup>1</sup> / <sub>8</sub> " D x 21 <sup>1</sup> / <sub>4</sub> " H
28717/3	Paint	Wood				<b>8,290</b>	
28717/5	Wood	Laminate				<b>8,740</b>	
28717/4	Paint	Laminate				<b>7,870</b>	
Frosted Glass Doors - Add "/G" to model # and \$570 to price.							
** 28758/2	Wood	Wood	94 <sup>9</sup> / <sub>16</sub> "	19 <sup>3</sup> / <sub>4</sub> "	29"	<b>8,190</b>	Credenza doors include aluminum trim around the perimeter that is available in all of the standard aluminum finishes on page 13.  Where applicable doors may be specified with optional glass panels in a variety of transparencies and colours. Contact Nienkamper Customer Service (1-800-668-9318) for specific information regarding glass doors options.  Doors are standard with push latches. A variety of optional pulls are specified on page 302. Glass doors are not available with pulls.  Cabinets are built in sections not exceeding three pedestal widths with tops shipped separately. Tops longer than 118" in length are made in two pieces.  To enhance the function of your credenza a range of optional interiors can be selected on pages 304-309.  <b>Door pedestals cannot accommodate refrigerator or Equipment storage racks.</b>  <b>Standard features:</b> • Easily leveled at the base of each metal leg • Top is self-edged on four sides • Extra wide box and file drawers accommodate a range of storage requirements including legal and letter file storage. • Single pedestal interior dimensions: 25 <sup>1</sup> / <sub>2</sub> " deep - 22" W x 23 <sup>1</sup> / <sub>2</sub> " D x 21 <sup>1</sup> / <sub>4</sub> " H 20" deep - 22" W x 18 <sup>1</sup> / <sub>8</sub> " D x 21 <sup>1</sup> / <sub>4</sub> " H
28758/3	Paint	Wood				<b>7,375</b>	
28758/5	Wood	Laminate				<b>7,790</b>	
28758/4	Paint	Laminate				<b>7,015</b>	
Frosted Glass Doors - Add "/G" to model # and \$570 to price.							
** 28718	Wood	Wood	94 <sup>9</sup> / <sub>16</sub> "	25 <sup>1</sup> / <sub>4</sub> "	29"	<b>9,305</b>	Credenza doors include aluminum trim around the perimeter that is available in all of the standard aluminum finishes on page 13.  Where applicable doors may be specified with optional glass panels in a variety of transparencies and colours. Contact Nienkamper Customer Service (1-800-668-9318) for specific information regarding glass doors options.  Doors are standard with push latches. A variety of optional pulls are specified on page 302. Glass doors are not available with pulls.  Cabinets are built in sections not exceeding three pedestal widths with tops shipped separately. Tops longer than 118" in length are made in two pieces.  To enhance the function of your credenza a range of optional interiors can be selected on pages 304-309.  <b>Door pedestals cannot accommodate refrigerator or Equipment storage racks.</b>  <b>Standard features:</b> • Easily leveled at the base of each metal leg • Top is self-edged on four sides • Extra wide box and file drawers accommodate a range of storage requirements including legal and letter file storage. • Single pedestal interior dimensions: 25 <sup>1</sup> / <sub>2</sub> " deep - 22" W x 23 <sup>1</sup> / <sub>2</sub> " D x 21 <sup>1</sup> / <sub>4</sub> " H 20" deep - 22" W x 18 <sup>1</sup> / <sub>8</sub> " D x 21 <sup>1</sup> / <sub>4</sub> " H
28718/3	Paint	Wood				<b>8,370</b>	
28718/5	Wood	Laminate				<b>8,840</b>	
28718/4	Paint	Laminate				<b>7,955</b>	
Frosted Glass Doors - Add "/G" to model # and \$570 to price.							
*** 28759/2	Wood	Wood	141 <sup>5</sup> / <sub>16</sub> "	19 <sup>3</sup> / <sub>4</sub> "	29"	<b>11,645</b>	Credenza doors include aluminum trim around the perimeter that is available in all of the standard aluminum finishes on page 13.  Where applicable doors may be specified with optional glass panels in a variety of transparencies and colours. Contact Nienkamper Customer Service (1-800-668-9318) for specific information regarding glass doors options.  Doors are standard with push latches. A variety of optional pulls are specified on page 302. Glass doors are not available with pulls.  Cabinets are built in sections not exceeding three pedestal widths with tops shipped separately. Tops longer than 118" in length are made in two pieces.  To enhance the function of your credenza a range of optional interiors can be selected on pages 304-309.  <b>Door pedestals cannot accommodate refrigerator or Equipment storage racks.</b>  <b>Standard features:</b> • Easily leveled at the base of each metal leg • Top is self-edged on four sides • Extra wide box and file drawers accommodate a range of storage requirements including legal and letter file storage. • Single pedestal interior dimensions: 25 <sup>1</sup> / <sub>2</sub> " deep - 22" W x 23 <sup>1</sup> / <sub>2</sub> " D x 21 <sup>1</sup> / <sub>4</sub> " H 20" deep - 22" W x 18 <sup>1</sup> / <sub>8</sub> " D x 21 <sup>1</sup> / <sub>4</sub> " H
28759/3	Paint	Wood				<b>10,485</b>	
28759/5	Wood	Laminate				<b>11,055</b>	
28759/4	Paint	Laminate				<b>9,965</b>	
Frosted Glass Doors - Add "/G" to model # and \$775 to price.							
*** 28719	Wood	Wood	141 <sup>5</sup> / <sub>16</sub> "	25 <sup>1</sup> / <sub>4</sub> "	29"	<b>13,225</b>	Credenza doors include aluminum trim around the perimeter that is available in all of the standard aluminum finishes on page 13.  Where applicable doors may be specified with optional glass panels in a variety of transparencies and colours. Contact Nienkamper Customer Service (1-800-668-9318) for specific information regarding glass doors options.  Doors are standard with push latches. A variety of optional pulls are specified on page 302. Glass doors are not available with pulls.  Cabinets are built in sections not exceeding three pedestal widths with tops shipped separately. Tops longer than 118" in length are made in two pieces.  To enhance the function of your credenza a range of optional interiors can be selected on pages 304-309.  <b>Door pedestals cannot accommodate refrigerator or Equipment storage racks.</b>  <b>Standard features:</b> • Easily leveled at the base of each metal leg • Top is self-edged on four sides • Extra wide box and file drawers accommodate a range of storage requirements including legal and letter file storage. • Single pedestal interior dimensions: 25 <sup>1</sup> / <sub>2</sub> " deep - 22" W x 23 <sup>1</sup> / <sub>2</sub> " D x 21 <sup>1</sup> / <sub>4</sub> " H 20" deep - 22" W x 18 <sup>1</sup> / <sub>8</sub> " D x 21 <sup>1</sup> / <sub>4</sub> " H
28719/3	Paint	Wood				<b>11,905</b>	
28719/5	Wood	Laminate				<b>12,565</b>	
28719/4	Paint	Laminate				<b>11,310</b>	
Frosted Glass Doors - Add "/G" to model # and \$775 to price.							

- \* Cabinet in 1 piece, Top in 1 piece
- \*\* Cabinet in 2 pieces, Top in 1 piece
- \*\*\* Cabinet in 2 pieces, Top in 2 pieces



Model # 28712  
Shown in Rift Cut Oak with Flush Pulls, FP-5, and silver anodized aluminum trim.

# VOX® CREDENZAS ON LEGS – 34¼" HIGH



Self Edge Top

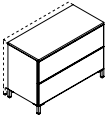

Available in two depths as illustrated

Model Number	Cabinet Finish	Top Finish	L" x	D" x	H"	List Price	Product Description
* 28761/2	Wood	Wood	47 <sup>7</sup> / <sub>16</sub> "	19 <sup>3</sup> / <sub>4</sub> "	34 <sup>1</sup> / <sub>4</sub> "	<b>4,570</b>	Vox credenzas on legs are available in two standard depths: 20" and 25 <sup>1</sup> / <sub>4</sub> " and three standard heights: 20 <sup>1</sup> / <sub>4</sub> ", 29" and 34 <sup>1</sup> / <sub>4</sub> ".
28761/3	Paint	Wood				<b>4,105</b>	
28761/5	Wood	Laminate				<b>4,345</b>	
28761/4	Paint	Laminate				<b>3,910</b>	

Standard finish options are selected by model number and include:

- Wood case with wood top
- Painted case with wood top
- Wood case with laminate top
- Painted case with laminate top

* 28721	Wood	Wood	47 <sup>7</sup> / <sub>16</sub> "	25 <sup>1</sup> / <sub>4</sub> "	34 <sup>1</sup> / <sub>4</sub> "	<b>5,180</b>
28721/3	Paint	Wood				<b>4,665</b>
28721/5	Wood	Laminate				<b>4,920</b>
28721/4	Paint	Laminate				<b>4,435</b>

**For credenzas with Fingerprint Resistance P-Lam, please contact customer service for upcharge.**

Choose standard wood veneers, plastic laminates, and aluminum/ paint finishes from pages 10-12.

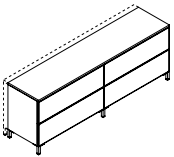

Available in two depths as illustrated

** 28762/2	Wood	Wood	94 <sup>7</sup> / <sub>16</sub> "	19 <sup>3</sup> / <sub>4</sub> "	34 <sup>1</sup> / <sub>4</sub> "	<b>8,185</b>
28762/3	Paint	Wood				<b>7,370</b>
28762/5	Wood	Laminate				<b>7,775</b>
28762/4	Paint	Laminate				<b>7,010</b>

Credenza doors include aluminum trim around the perimeter that is available in all of the standard aluminum finishes on page 13.

Where applicable doors may be specified with optional glass panels in a variety of transparencies and colours. Contact Nienkamper Customer Service (1-800-668-9318) for specific information regarding glass doors options.

** 28722	Wood	Wood	94 <sup>7</sup> / <sub>16</sub> "	25 <sup>1</sup> / <sub>4</sub> "	34 <sup>1</sup> / <sub>4</sub> "	<b>9,305</b>
28722/3	Paint	Wood				<b>8,365</b>
28722/5	Wood	Laminate				<b>8,840</b>
28722/4	Paint	Laminate				<b>7,950</b>

Doors are standard with push latches for opening. A variety of optional pulls are specified on page 302. Glass doors are not available with pulls.

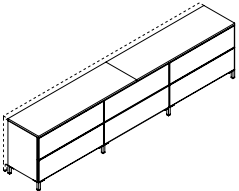

Available in two depths as illustrated

*** 28763/2	Wood	Wood	141 <sup>5</sup> / <sub>16</sub> "	19 <sup>3</sup> / <sub>4</sub> "	34 <sup>1</sup> / <sub>4</sub> "	<b>12,275</b>
28763/3	Paint	Wood				<b>11,045</b>
28763/5	Wood	Laminate				<b>11,655</b>
28763/4	Paint	Laminate				<b>10,500</b>

Cabinets are built in sections not exceeding three pedestal widths, with tops shipped separately. Tops longer than 118" in length are made in two pieces.

To enhance the function of your credenza a range of optional interiors can be selected on pages 304-309.

*** 28723	Wood	Wood	141 <sup>5</sup> / <sub>16</sub> "	25 <sup>1</sup> / <sub>4</sub> "	34 <sup>1</sup> / <sub>4</sub> "	<b>13,935</b>
28723/3	Paint	Wood				<b>12,545</b>
28723/5	Wood	Laminate				<b>13,245</b>
28723/4	Paint	Laminate				<b>11,930</b>

**Door pedestals 20" deep cannot accommodate refrigerators or equipment racks.**

**Standard features:**

- Easily leveled at the base of each metal leg
- Top is self-edged on four sides
- Extra wide file drawers accommodate a range of storage requirements including legal and letter file storage.
- Single pedestal interior dimensions:  
25<sup>1</sup>/<sub>2</sub>" deep - 22" W x 23<sup>1</sup>/<sub>2</sub>" D x 26" H  
20" deep - 22" W x 18<sup>1</sup>/<sub>8</sub>" D x 26" H

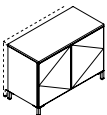

Available in two depths as illustrated

* 28764/2	Wood	Wood	47 <sup>7</sup> / <sub>16</sub> "	19 <sup>3</sup> / <sub>4</sub> "	34 <sup>1</sup> / <sub>4</sub> "	<b>4,345</b>
28764/3	Paint	Wood				<b>3,920</b>
28764/5	Wood	Laminate				<b>4,130</b>
28764/4	Paint	Laminate				<b>3,715</b>

Frosted glass doors: add "/G" to model # and \$210 to price.

* 28724	Wood	Wood	47 <sup>7</sup> / <sub>16</sub> "	25 <sup>1</sup> / <sub>4</sub> "	34 <sup>1</sup> / <sub>4</sub> "	<b>4,930</b>
28724/3	Paint	Wood				<b>4,440</b>
28724/5	Wood	Laminate				<b>4,690</b>
28724/4	Paint	Laminate				<b>4,215</b>

Frosted glass doors: add "/G" to model # and \$210 to price.

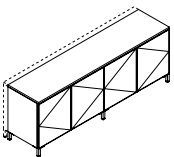

Available in two depths as illustrated

** 28765/2	Wood	Wood	94 <sup>7</sup> / <sub>16</sub> "	19 <sup>3</sup> / <sub>4</sub> "	34 <sup>1</sup> / <sub>4</sub> "	<b>7,795</b>
28765/3	Paint	Wood				<b>7,025</b>
28765/5	Wood	Laminate				<b>7,400</b>
28765/4	Paint	Laminate				<b>6,665</b>

Frosted glass doors: add "/G" to model # and \$415 to price.

** 28725	Wood	Wood	94 <sup>7</sup> / <sub>16</sub> "	25 <sup>1</sup> / <sub>4</sub> "	34 <sup>1</sup> / <sub>4</sub> "	<b>8,855</b>
28725/3	Paint	Wood				<b>7,970</b>
28725/5	Wood	Laminate				<b>8,400</b>
28725/4	Paint	Laminate				<b>7,570</b>

Frosted glass doors: add "/G" to model # and \$415 to price.



Model # 28723

Shown in Quarter Cut Natural Walnut with Flush Pulls, FP2-S, and silver anodized aluminum trim.

- \* Cabinet in 1 piece, Top in 1 piece
- \*\* Cabinet in 2 pieces, Top in 1 piece
- \*\*\* Cabinet in 2 pieces, Top in 2 pieces



# VOX® CREDENZAS ON LEGS – 34¼" HIGH



Self Edge Top

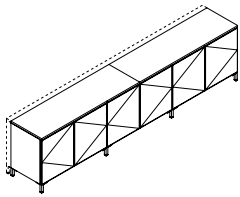

Available in two depths as illustrated

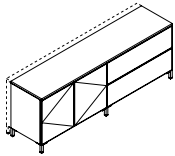

Available in two depths as illustrated

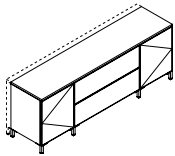

Available in two depths as illustrated

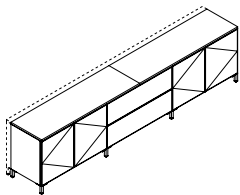

Available in two depths as illustrated

Model Number	Cabinet Finish	Top Finish	L" x	D" x	H"	List Price	Product Description
*** 28766/2	Wood	Wood	141 <sup>5</sup> / <sub>16</sub> "	19 <sup>3</sup> / <sub>4</sub> "	34 <sup>1</sup> / <sub>4</sub> "	<b>11,670</b>	Vox credenzas on legs are available in two standard depths: 20" and 25 <sup>1</sup> / <sub>4</sub> " and three standard heights: 20 <sup>1</sup> / <sub>4</sub> ", 29" and 34 <sup>1</sup> / <sub>4</sub> ".  Standard finish options are selected by model number and include: • Wood case with wood top • Painted case with wood top • Wood case with laminate top • Painted case with laminate top
28766/3	Paint	Wood				<b>10,500</b>	
28766/5	Wood	Laminate				<b>11,095</b>	
28766/4	Paint	Laminate				<b>9,985</b>	
Frosted Glass Doors - Add "/G" to model # and \$620 to price.							
*** 28726	Wood	Wood	141 <sup>5</sup> / <sub>16</sub> "	25 <sup>1</sup> / <sub>4</sub> "	34 <sup>1</sup> / <sub>4</sub> "	<b>13,250</b>	Choose standard wood veneers, plastic laminates, and aluminum/ paint finishes from pages 10-12.  Credenza doors include aluminum trim around the perimeter that is available in all of the standard aluminum finishes on page 13.  Where applicable doors may be specified with optional glass panels in a variety of transparencies and colours. Contact Nienkamper Customer Service (1-800-668-9318) for specific information regarding glass doors options.  Doors are standard with push latches for opening A variety of optional pulls are specified on page 302. Glass doors are not available with pulls  Cabinets are built in sections not exceeding three pedestal widths, with tops shipped separately. Tops longer than 118" in length are made in two pieces.  To enhance the function of your credenza a range of optional interiors can be selected on pages 304-309.  <b>Door pedestals 20" deep cannot accommodate refrigerators or equipment racks.</b>
28726/3	Paint	Wood				<b>11,935</b>	
28726/5	Wood	Laminate				<b>12,605</b>	
28726/4	Paint	Laminate				<b>11,345</b>	
Frosted Glass Doors - Add "/G" to model # and \$620 to price.							
* 28767/2	Wood	Wood	94 <sup>9</sup> / <sub>16</sub> "	19 <sup>3</sup> / <sub>4</sub> "	34 <sup>1</sup> / <sub>4</sub> "	<b>8,440</b>	Where applicable doors may be specified with optional glass panels in a variety of transparencies and colours. Contact Nienkamper Customer Service (1-800-668-9318) for specific information regarding glass doors options.  Doors are standard with push latches for opening A variety of optional pulls are specified on page 302. Glass doors are not available with pulls  Cabinets are built in sections not exceeding three pedestal widths, with tops shipped separately. Tops longer than 118" in length are made in two pieces.  To enhance the function of your credenza a range of optional interiors can be selected on pages 304-309.  <b>Door pedestals 20" deep cannot accommodate refrigerators or equipment racks.</b>
28767/3	Paint	Wood				<b>7,590</b>	
28767/5	Wood	Laminate				<b>8,010</b>	
28767/4	Paint	Laminate				<b>7,225</b>	
Frosted Glass Doors - Add "/G" to model # and \$570 to price.							
* 28727	Wood	Wood	94 <sup>9</sup> / <sub>16</sub> "	25 <sup>1</sup> / <sub>4</sub> "	34 <sup>1</sup> / <sub>4</sub> "	<b>9,585</b>	Where applicable doors may be specified with optional glass panels in a variety of transparencies and colours. Contact Nienkamper Customer Service (1-800-668-9318) for specific information regarding glass doors options.  Doors are standard with push latches for opening A variety of optional pulls are specified on page 302. Glass doors are not available with pulls  Cabinets are built in sections not exceeding three pedestal widths, with tops shipped separately. Tops longer than 118" in length are made in two pieces.  To enhance the function of your credenza a range of optional interiors can be selected on pages 304-309.  <b>Door pedestals 20" deep cannot accommodate refrigerators or equipment racks.</b>
28727/3	Paint	Wood				<b>8,620</b>	
28727/5	Wood	Laminate				<b>9,110</b>	
28727/4	Paint	Laminate				<b>8,190</b>	
Frosted Glass Doors - Add "/G" to model # and \$570 to price.							
** 28768/2	Wood	Wood	94 <sup>9</sup> / <sub>16</sub> "	19 <sup>3</sup> / <sub>4</sub> "	34 <sup>1</sup> / <sub>4</sub> "	<b>8,525</b>	Where applicable doors may be specified with optional glass panels in a variety of transparencies and colours. Contact Nienkamper Customer Service (1-800-668-9318) for specific information regarding glass doors options.  Doors are standard with push latches for opening A variety of optional pulls are specified on page 302. Glass doors are not available with pulls  Cabinets are built in sections not exceeding three pedestal widths, with tops shipped separately. Tops longer than 118" in length are made in two pieces.  To enhance the function of your credenza a range of optional interiors can be selected on pages 304-309.  <b>Door pedestals 20" deep cannot accommodate refrigerators or equipment racks.</b>
28768/3	Paint	Wood				<b>7,675</b>	
28768/5	Wood	Laminate				<b>8,100</b>	
28768/4	Paint	Laminate				<b>7,290</b>	
Frosted Glass Doors - Add "/G" to model # and \$570 to price.							
** 28728	Wood	Wood	94 <sup>9</sup> / <sub>16</sub> "	25 <sup>1</sup> / <sub>4</sub> "	34 <sup>1</sup> / <sub>4</sub> "	<b>9,680</b>	Where applicable doors may be specified with optional glass panels in a variety of transparencies and colours. Contact Nienkamper Customer Service (1-800-668-9318) for specific information regarding glass doors options.  Doors are standard with push latches for opening A variety of optional pulls are specified on page 302. Glass doors are not available with pulls  Cabinets are built in sections not exceeding three pedestal widths, with tops shipped separately. Tops longer than 118" in length are made in two pieces.  To enhance the function of your credenza a range of optional interiors can be selected on pages 304-309.  <b>Door pedestals 20" deep cannot accommodate refrigerators or equipment racks.</b>
28728/3	Paint	Wood				<b>8,715</b>	
28728/5	Wood	Laminate				<b>9,190</b>	
28728/4	Paint	Laminate				<b>8,290</b>	
Frosted Glass Doors - Add "/G" to model # and \$570 to price.							
*** 28769/2	Wood	Wood	141 <sup>5</sup> / <sub>16</sub> "	19 <sup>3</sup> / <sub>4</sub> "	34 <sup>1</sup> / <sub>4</sub> "	<b>12,095</b>	Where applicable doors may be specified with optional glass panels in a variety of transparencies and colours. Contact Nienkamper Customer Service (1-800-668-9318) for specific information regarding glass doors options.  Doors are standard with push latches for opening A variety of optional pulls are specified on page 302. Glass doors are not available with pulls  Cabinets are built in sections not exceeding three pedestal widths, with tops shipped separately. Tops longer than 118" in length are made in two pieces.  To enhance the function of your credenza a range of optional interiors can be selected on pages 304-309.  <b>Door pedestals 20" deep cannot accommodate refrigerators or equipment racks.</b>
28769/3	Paint	Wood				<b>10,895</b>	
28769/5	Wood	Laminate				<b>9,095</b>	
28769/4	Paint	Laminate				<b>10,345</b>	
Frosted Glass Doors - Add "/G" to model # and \$775 to price.							
*** 28729	Wood	Wood	141 <sup>5</sup> / <sub>16</sub> "	25 <sup>1</sup> / <sub>4</sub> "	34 <sup>1</sup> / <sub>4</sub> "	<b>13,740</b>	Where applicable doors may be specified with optional glass panels in a variety of transparencies and colours. Contact Nienkamper Customer Service (1-800-668-9318) for specific information regarding glass doors options.  Doors are standard with push latches for opening A variety of optional pulls are specified on page 302. Glass doors are not available with pulls  Cabinets are built in sections not exceeding three pedestal widths, with tops shipped separately. Tops longer than 118" in length are made in two pieces.  To enhance the function of your credenza a range of optional interiors can be selected on pages 304-309.  <b>Door pedestals 20" deep cannot accommodate refrigerators or equipment racks.</b>
28729/3	Paint	Wood				<b>12,360</b>	
28729/5	Wood	Laminate				<b>13,045</b>	
28729/4	Paint	Laminate				<b>11,760</b>	
Frosted Glass Doors - Add "/G" to model # and \$775 to price.							

- \* Cabinet in 1 piece, Top in 1 piece
- \*\* Cabinet in 2 pieces, Top in 1 piece
- \*\*\* Cabinet in 2 pieces, Top in 2 pieces



Model # 28723  
Shown in Quarter Cut Natural Walnut with Flush Pulls, FP2-S, and silver anodized aluminum trim.

# VOX® BOARDROOM CREDENZAS ON GLIDES



## Standard Edge Profile



## Optional Edge Profiles

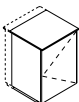
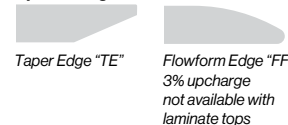

Available in two depths as illustrated

Model Number	Cabinet Finish	Top Finish	L" x	D" x	H"	List Price	Product Description
* 29731/2	Wood	Wood	25½"	20"	34½"	<b>3,535</b>	Vox boardroom credenzas are available in two standard depths: 20" and 25½".
29731/3	Paint	Wood				<b>3,175</b>	
29731/5	Wood	Laminate				<b>3,360</b>	
29731/4	Paint	Laminate				<b>3,030</b>	

Frosted Glass Doors - Add "/G" to model # and \$105 to price.

Standard finish options are selected by model number and include:

- Wood case with wood top
- Painted case with wood top
- Wood case with laminate top
- Painted case with laminate top

* 27901	Wood	Wood	25½"	25½"	34½"	<b>4,025</b>
27901/3	Paint	Wood				<b>3,605</b>
27901/5	Wood	Laminate				<b>3,815</b>
27901/4	Paint	Laminate				<b>3,430</b>

Frosted Glass Doors - Add "/G" to model # and \$105 to price.

**For credenzas with Fingerprint Resistance P-Lam, please contact customer service for upcharge.**

Choose standard wood veneers, plastic laminates, and aluminum/ paint finishes from pages 10-12.

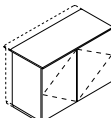

Available in two depths as illustrated

* 29732/2	Wood	Wood	49½"	20"	34½"	<b>4,690</b>
29732/3	Paint	Wood				<b>4,215</b>
29732/5	Wood	Laminate				<b>4,445</b>
29732/4	Paint	Laminate				<b>4,010</b>

Frosted Glass Doors - Add "/G" to model # and \$210 to price.

Doors are standard with push latches for opening. A variety of optional pulls are specified on page 302.

Cabinets are built in sections not exceeding three pedestal widths with tops shipped separately. Tops longer than 118" in length are made in two pieces.

* 27902	Wood	Wood	49½"	25½"	34½"	<b>5,320</b>
27902/3	Paint	Wood				<b>4,785</b>
27902/5	Wood	Laminate				<b>5,050</b>
27902/4	Paint	Laminate				<b>4,555</b>

Frosted Glass Doors - Add "/G" to model # and \$210 to price.

To enhance the function of your credenza a range of optional interiors can be selected on pages 304-309.

**20" deep credenzas cannot accommodate refrigerators and equipment storage racks.**

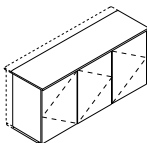

Available in two depths as illustrated

* 29733/2	Wood	Wood	72¾"	20"	34½"	<b>6,565</b>
29733/3	Paint	Wood				<b>5,915</b>
29733/5	Wood	Laminate				<b>6,245</b>
29733/4	Paint	Laminate				<b>5,620</b>

Frosted Glass Doors - Add "/G" to model # and \$310 to price.

### Standard features:

- Easily leveled from interior of cabinet
- One adjustable shelf per opening
- Facet edge on three sides; self edged back
- Dimensions shown in this price list apply to Facet edge tops
- Single pedestal interior dimensions:  
25½" deep - 22" W x 23½" D x 28¾" H  
20" deep - 22" W x 18½" D x 28¾" H

* 27903	Wood	Wood	72¾"	25½"	34½"	<b>7,460</b>
27903/3	Paint	Wood				<b>6,715</b>
27903/5	Wood	Laminate				<b>7,085</b>
27903/4	Paint	Laminate				<b>6,390</b>

Frosted Glass Doors - Add "/G" to model # and \$310 to price.

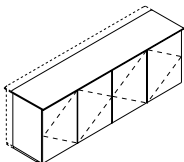

Available in two depths as illustrated

** 29734/2	Wood	Wood	96¾"	20"	34½"	<b>7,720</b>
29734/3	Paint	Wood				<b>6,950</b>
29734/5	Wood	Laminate				<b>7,335</b>
29734/4	Paint	Laminate				<b>6,620</b>

Frosted Glass Doors - Add "/G" to model # and \$415 to price.

** 27904	Wood	Wood	96¾"	25½"	34½"	<b>8,770</b>
27904/3	Paint	Wood				<b>7,905</b>
27904/5	Wood	Laminate				<b>8,335</b>
27904/4	Paint	Laminate				<b>7,505</b>

Frosted Glass Doors - Add "/G" to model # and \$415 to price.

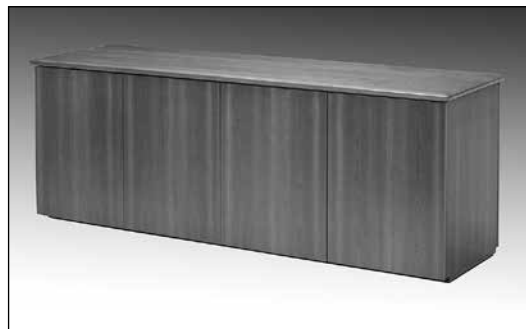

### Model # 27904/2

Vox Boardroom four-pedestal credenza in Natural Cherry finish with Facet Edge.

\* Cabinet in 1 piece, Top in 1 piece

\*\* Cabinet in 2 pieces, Top in 1 piece

# VOX® BOARDROOM CREDENZAS ON GLIDES

## Standard Edge Profile



Facet Edge "FC"  
Standard

## Optional Edge Profiles







Taper Edge "TE"

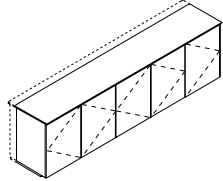
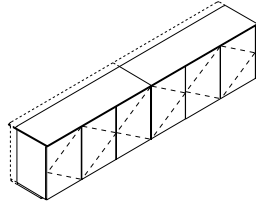
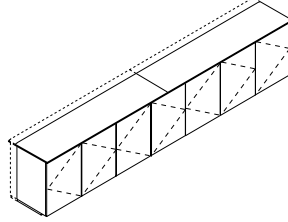
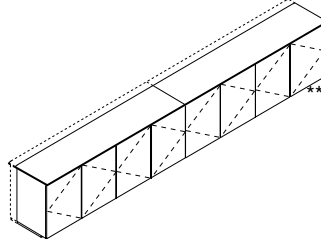

Flowform Edge "FF"

3% upcharge  
not available with laminate tops

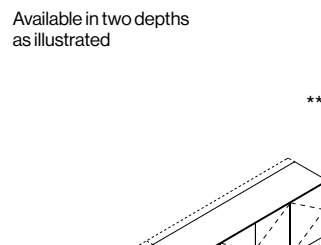

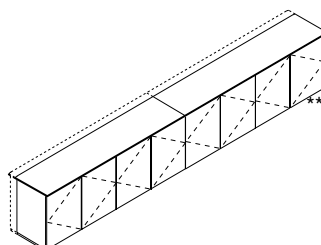
	Model Number	Cabinet Finish	Top Finish	L" x	D" x	H"	List Price	Product Description
 <p>Available in two depths as illustrated</p>	** 29735/2	Wood	Wood	120"	20"	34½"	<b>9,295</b>	Vox boardroom credenzas are available in two standard depths: 20" and 25½".  Standard finish options are selected by model number and include: <ul style="list-style-type: none"> <li>• Wood case with wood top</li> <li>• Painted case with wood top</li> <li>• Wood case with laminate top</li> <li>• Painted case with laminate top</li> </ul>
	29735/3	Paint	Wood				<b>8,365</b>	
	29735/5	Wood	Laminate				<b>8,840</b>	
	29735/4	Paint	Laminate				<b>7,950</b>	
	Frosted Glass Doors - Add "/G" to model # and \$515 to price.							
 <p>Available in two depths as illustrated</p>	** 27905	Wood	Wood	120"	25½"	34½"	<b>10,555</b>	<b>For credenzas with Fingerprint Resistance P-Lam, please contact customer service for upcharge.</b>  Choose standard wood veneers, plastic laminates, and aluminum/paint finishes from pages 10-12.  Doors are standard with push latches. A variety of optional pulls are specified on page 302.  Cabinets are built in sections not exceeding three pedestal widths, with tops shipped separately. Tops longer than 118" in length are made in two pieces.
	27905/3	Paint	Wood				<b>9,510</b>	
	27905/5	Wood	Laminate				<b>10,035</b>	
	27905/4	Paint	Laminate				<b>9,035</b>	
	Frosted Glass Doors - Add "/G" to model # and \$515 to price.							
 <p>Available in two depths as illustrated</p>	*** 29736/2	Wood	Wood	143⅝"	20"	34½"	<b>10,755</b>	To enhance the function of your credenza a range of optional interiors can be selected on pages 304-309.  <b>20" deep credenzas cannot accommodate refrigerators and equipment storage racks.</b>  <b>Standard features:</b> <ul style="list-style-type: none"> <li>• Easily leveled from interior of cabinet</li> <li>• One adjustable shelf per opening</li> <li>• Facet edge on three sides; self edged back</li> <li>• Dimensions shown in this price list is for Facet edge top</li> <li>• Single pedestal interior dimensions:                             <ul style="list-style-type: none"> <li>25½" deep - 22" W x 23½" D x 28¾" H</li> <li>20" deep - 22" W x 18½" D x 28¾" H</li> </ul> </li> </ul>
	29736/3	Paint	Wood				<b>9,685</b>	
	29736/5	Wood	Laminate				<b>10,220</b>	
	29736/4	Paint	Laminate				<b>9,195</b>	
	Frosted Glass Doors - Add "/G" to model # and \$620 to price.							
 <p>Available in two depths as illustrated</p>	*** 27906	Wood	Wood	143⅝"	25½"	34½"	<b>12,230</b>	To enhance the function of your credenza a range of optional interiors can be selected on pages 304-309.
	27906/3	Paint	Wood				<b>11,000</b>	
	27906/5	Wood	Laminate				<b>11,610</b>	
	27906/4	Paint	Laminate				<b>10,455</b>	
	Frosted Glass Doors - Add "/G" to model # and \$620 to price.							
 <p>Available in two depths as illustrated</p>	**** 29737/2	Wood	Wood	167¼"	20"	34½"	<b>12,095</b>	To enhance the function of your credenza a range of optional interiors can be selected on pages 304-309.
	29737/3	Paint	Wood				<b>10,895</b>	
	29737/5	Wood	Laminate				<b>11,490</b>	
	29737/4	Paint	Laminate				<b>10,345</b>	
	Frosted Glass Doors - Add "/G" to model # and \$725 to price.							
 <p>Available in two depths as illustrated</p>	**** 27907	Wood	Wood	167¼"	25½"	34½"	<b>13,750</b>	To enhance the function of your credenza a range of optional interiors can be selected on pages 304-309.
	27907/3	Paint	Wood				<b>12,370</b>	
	27907/5	Wood	Laminate				<b>13,045</b>	
	27907/4	Paint	Laminate				<b>11,750</b>	
	Frosted Glass Doors - Add "/G" to model # and \$725 to price.							
 <p>Available in two depths as illustrated</p>	**** 29738/2	Wood	Wood	190⅞"	20"	34½"	<b>13,570</b>	To enhance the function of your credenza a range of optional interiors can be selected on pages 304-309.
	29738/3	Paint	Wood				<b>12,205</b>	
	29738/5	Wood	Laminate				<b>12,870</b>	
	29738/4	Paint	Laminate				<b>11,590</b>	
	Frosted Glass Doors - Add "/G" to model # and \$825 to price.							
 <p>Available in two depths as illustrated</p>	**** 27908	Wood	Wood	190⅞"	25½"	34½"	<b>15,405</b>	To enhance the function of your credenza a range of optional interiors can be selected on pages 304-309.
	27908/3	Paint	Wood				<b>13,855</b>	
	27908/5	Wood	Laminate				<b>14,630</b>	
	27908/4	Paint	Laminate				<b>13,180</b>	
	Frosted Glass Doors - Add "/G" to model # and \$825 to price.							

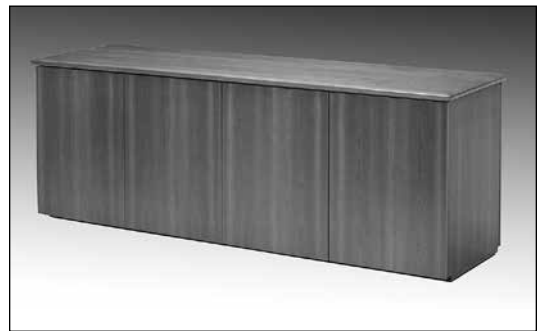

### Model # 27904/2

Vox Boardroom four-pedestal credenza in Natural Cherry finish with Facet Edge.

\*\* Cabinet in 2 pieces, Top in 1 piece  
 \*\*\* Cabinet in 2 pieces, Top in 2 pieces  
 \*\*\*\* Cabinet in 3 pieces, Top in 2 pieces

# VOX® BOARDROOM CREDENZAS ON CASTERS



**Standard Edge Profile**



Facet Edge "FC"  
Standard

**Optional Edge Profiles**



Taper Edge "TE"



Flowform Edge "FF"  
3% upcharge  
laminates not available

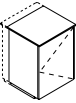

Available in one depth only

Model Number	Cabinet Finish	Top Finish	L" x	D" x	H"	List Price	Product Description
* 27911	Wood	Wood	25½"	25¾"	34½"	4,645	Vox boardroom credenzas on casters are only available in the standard depth of 25¾".
27911/3	Paint	Wood				4,180	
27911/5	Wood	Laminate				4,815	
27911/4	Paint	Laminate				3,980	

Frosted Glass Doors - Add "/G" to model # and \$105 to price.

- Standard finish options are selected by model number and include:
- Wood case with wood top
  - Painted case with wood top
  - Wood case with laminate top
  - Painted case with laminate top

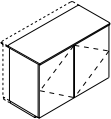

Available in one depth only

* 27912	Wood	Wood	49¾"	25¾"	34½"	6,035	<b>For credenzas with Fingerprint Resistance P-Lam, please contact customer service for upcharge.</b>
27912/3	Paint	Wood				5,415	
27912/5	Wood	Laminate				5,715	
27912/4	Paint	Laminate				5,160	

Frosted Glass Doors - Add "/G" to model # and \$210 to price.

Choose standard wood veneers, plastic laminates, and aluminum/paint finishes from pages 10-12.

Doors are standard with push latches for opening. A variety of optional pulls are specified on page 302.

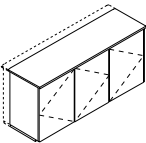

Available in one depth only

* 27913	Wood	Wood	72¾"	25¾"	34½"	8,105	Cabinets are built in sections not exceeding three pedestal widths with tops shipped separately. Tops longer than 118" in length are made in two pieces.
27913/3	Paint	Wood				7,300	
27913/5	Wood	Laminate				7,705	
27913/4	Paint	Laminate				6,925	

Frosted Glass Doors - Add "/G" to model # and \$310 to price.

To enhance the function of your credenza a range of optional interiors can be selected on pages 304-309.

**Standard features:**

- 4" non-marking industrial strength casters
- One adjustable shelf per opening
- Facet edge on three sides; self-edged back
- Dimensions shown in this price list apply to Facet edge top
- Single pedestal interior dimensions: 25¾" deep - 22" W x 23½" D x 26¾" H

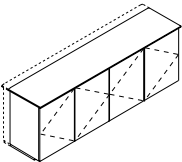

Available in one depth only

* 27914	Wood	Wood	96¾"	25¾"	34½"	9,240	Frosted Glass Doors - Add "/G" to model # and \$415 to price.
27914/3	Paint	Wood				8,320	
27914/5	Wood	Laminate				8,780	
27914/4	Paint	Laminate				7,910	

Frosted Glass Doors - Add "/G" to model # and \$415 to price.

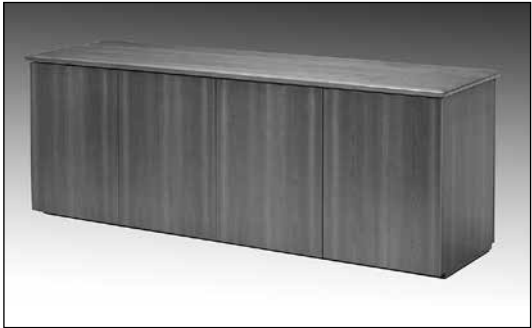







**Model # 27914/2**

Vox Boardroom four pedestal credenza in Natural Cherry finish with Facet Edge.

\* Cabinet in 1 piece, Top in 1 piece  
\*\* Cabinet in 2 pieces, Top in 1 piece

# VOX® CREDENZA DRAWER/DOOR PULL SPECIFICATIONS

	Finish	Model Number	L" x H" x D"	Product Description
<u>FLUSH PULL – PAINT FINISH</u> 	Silver	FP-S	2" x 1 <sup>3</sup> / <sub>4</sub> " x 1/16"	<p><b>The Flush Pull</b> is cast stainless steel finished in standard paint finishes to match the cabinets. When ordering pulls, add the drawer pull code to the end of the model number of the cabinet selected.</p> <p>Flush pulls are horizontal on credenza fronts, vertical on closet fronts.</p>
	Champagne	FP-C		
	Light Bronze	FP-LB		
<u>FLUSH PULL 2 – PAINT FINISH</u> 	<b>Silver</b>	<b>FP2-S</b>	<b>4<sup>1</sup>/<sub>2</sub>" - 7" x 2<sup>1</sup>/<sub>8</sub>" x 3/16"</b>	<p><b>The Flush Pull 2</b> is die cast zinc and is finished in a metallic silver or champagne paint, supplied in two sizes scaled to fit the cabinet fronts. When ordering pulls, add the drawer pull code to the end of the model number of the cabinet selected.</p> <p>Flush pulls are horizontal on credenza fronts, vertical on closet fronts.</p>
	<b>Champagne</b>	<b>FP2-C</b>		
<u>SWIVEL PULL – PAINT FINISH</u> 	Silver	SP-S	1 <sup>1</sup> / <sub>8</sub> " x 1 <sup>3</sup> / <sub>4</sub> " x 1/16"	<p><b>The Swivel Pull</b> is cast stainless steel finished in standard paint finishes to match the cabinets. When ordering pulls, add the drawer pull code to the end of the model number of the cabinet selected.</p>
	Champagne	SP-C		
	Light Bronze	SP-LB		
<u>LARGE SWIVEL PULL – STAINLESS STEEL</u> 	<b>Fine Brushed</b>	<b>LSP-FBS</b>	<b>5<sup>1</sup>/<sub>2</sub>" x 2<sup>3</sup>/<sub>4</sub>" x 1/16"</b>	<p><b>The Large Swivel Pull</b> is die-cast zinc, finished in a smooth fine brushed stainless steel. Pushing lightly on the top of the centre component swivels the handle outward to grasp. Once the user lets go of the pull it swivels back into flush position. When ordering pulls, add the drawer pull code to the end of the model number of the cabinet selected</p>
<u>BAR PULL – STAINLESS STEEL</u> 	Satin Finish	<b>BP-BSS</b>	<b>13<sup>3</sup>/<sub>8</sub>" - 19<sup>5</sup>/<sub>8</sub>" x 3/8"</b>	<p><b>The Satin-finished Stainless Steel Bar Pull</b> is supplied in two sizes scaled to fit the cabinet fronts. All bar pulls run horizontally on credenza fronts, and vertically on closet fronts. When ordering pulls, add the drawer pull code to the end of the model number of the cabinet selected.</p>
<u>BAR PULL – ANODIZED ALUMINUM</u> 	<b>Silver</b>	<b>BP-S</b>	<b>14" - 20" x 3/8" x 1<sup>1</sup>/<sub>2</sub>"</b>	<p><b>The anodized aluminum Bar Pull</b> is supplied in two sizes scaled to fit the cabinet fronts. All bar pulls run horizontally on credenza fronts and vertically on closet fronts. Available in three standard anodized aluminum finishes to match cabinets. When ordering pulls, add the drawer pull code to the end of the model number of the cabinet selected.</p>
	<b>Champagne</b>	<b>BP-C</b>		
	<b>Light Bronze</b>	<b>BP-LB</b>		

# VOX® CREDENZAS – PULL POSITIONS

---

## FLUSH PULL



Flush Pull – FP-S

## SWIVEL PULL



Swivel Pull – SP-S

## BAR PULL





Aluminum Bar Pull – BP-S, 14"

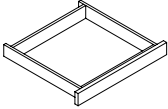
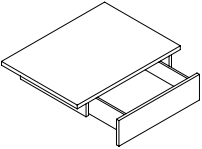
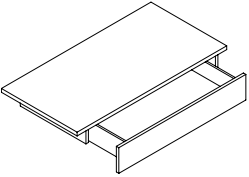
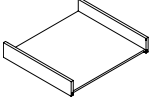

Aluminum Bar Pull – BP-S, 20"

## STANDARD FEATURES

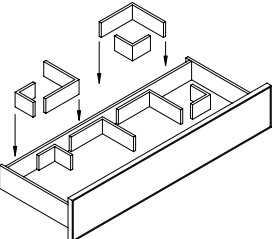
	Model Number	L" x D"	H"	List Price	Product Description
<p><u>SINGLE PEDESTAL FIXED DRAWER</u></p> 	<b>28707</b>	<b>21" x 20<sup>3</sup>/<sub>16</sub>"</b>	<b>3<sup>1</sup>/<sub>2</sub>"</b>	<b>625</b>	<ul style="list-style-type: none"> <li>• drawer assembly attaches to sub-top and can be added to a credenza at any time</li> <li>• fits into 1-ped &amp; 2-ped openings (two can fit into a 2-ped opening)</li> <li>• drawer interior and face veneered and finished to match credenza</li> <li>• interior dimensions: 17-1/4"W x 16-1/16"D x 2-1/4"H</li> <li>• accommodates cutlery tray model (#28705)</li> </ul>
<p><u>SINGLE PEDESTAL ADJUSTABLE SHELF WITH DRAWER</u></p> 	23422	21 <sup>7</sup> / <sub>8</sub> " x 23 <sup>1</sup> / <sub>16</sub> "	7 <sup>15</sup> / <sub>16</sub> "	770	<ul style="list-style-type: none"> <li>• height-adjustable shelf with box drawer fits inside 1-ped opening</li> <li>• equipped with self-closing slides</li> <li>• drawer interior is black melamine</li> <li>• drawer face and shelf are veneered and finished to match credenza</li> <li>• interior dimensions: 15-1/8"W x 16"D x 4"H</li> </ul>
<p><u>DOUBLE PEDESTAL ADJUSTABLE SHELF WITH DRAWER</u></p> 	<b>23423</b>	<b>45<sup>9</sup>/<sub>16</sub>" x 23<sup>1</sup>/<sub>16</sub>"</b>	<b>7<sup>15</sup>/<sub>16</sub>"</b>	<b>1,015</b>	<ul style="list-style-type: none"> <li>• height-adjustable shelf with box drawer fits inside 2-ped opening</li> <li>• equipped with self-closing slides</li> <li>• drawer interior is black melamine</li> <li>• drawer face and shelf are veneered and finished to match credenza</li> <li>• interior dimensions: 34-1/4"W x 16"D x 4"H</li> </ul>
<p><u>CUTLERY TRAY SURROUND</u></p> 	28706	18 <sup>1</sup> / <sub>4</sub> " x 16"	3"	200	<ul style="list-style-type: none"> <li>• fits into single ped fixed drawer (#28707), and single / double adjustable shelf drawer (#23422, #23423)</li> <li>• surround is veneer and finished to match credenza</li> <li>• accommodates cutlery tray - model #28705</li> </ul>
<p><u>CUTLERY TRAY</u></p> 	<b>28705</b>	<b>17<sup>1</sup>/<sub>4</sub>" x 16"</b>	<b>2<sup>1</sup>/<sub>8</sub>"</b>	<b>145</b>	<ul style="list-style-type: none"> <li>• plastic tray has 6 compartments (5 small, 1 large)</li> <li>• silver in color</li> <li>• fits into single adjustable shelf with drawer (#28707), and surround (28706)</li> </ul>
<p><u>DOUBLE PEDESTAL BOX DRAWER DIVIDERS</u> 4 LARGE &amp; 4 SMALL INCLUDED</p> 	28709	4 <sup>1</sup> / <sub>4</sub> " x 7 <sup>7</sup> / <sub>8</sub> "	3"	605	<ul style="list-style-type: none"> <li>• "L"-shaped dividers for interior of 2-ped box drawer</li> <li>• used to organize drawer space</li> <li>• bottom of divider has hook-side velcro, and attaches to tempo fabric drawer liner (included)</li> <li>• rift-cut veneer and finished to match credenza</li> </ul>



**Model # 28707**

**Single Pedestal Fixed Drawer**

Shown with optional cutlery tray model #28705

- Fits into single pedestal opening



**Model # 23423**

**Double Pedestal Adjustable Shelf with Drawer**

- Positions are pre-drilled for all 2 pedestal wide openings

**Model # 23422**

**Single Pedestal Adjustable Shelf with Drawer**

- Same features as model #23423 but fits into single pedestal opening



**Model # 28709**

**Double Pedestal Box Drawer Dividers**

- This accessory allows large drawer interiors to be divided and re-arranged as required
- Velcro fabric drawer bottom included



## STANDARD FEATURES

Vox credenzas reflect Nienkämper's commitment to producing well-made furniture that functions superbly. The optional interiors have been designed to enhance the basic design. The refrigerator selected is traditionally used in hospitality applications. Refrigerators cannot be accommodated in 20" deep credenzas.

	Model Number	L" x D" x H"	List Price	Product Description
REFRIGERATOR	23449	18" x 20 1/2" x 20 1/2"	1,515	<b>Model # 23449</b>



- all necessary cutouts, ventilation, elevated black base and grommets are provided
- refrigerator door opens separately from credenza door
- field reversible door hinge
- 1.8 cu.ft. (51 litre) refrigeration capacity
- removable shelves and in door storage
- fits into single pedestal width of 29" high and 34 1/4" high credenzas on legs

## PREMIUM REFRIGERATOR U-LINE 29R

<b>23452</b>	<b>20 3/4"</b>	<b>23"</b>	<b>28 1/2"</b>	<b>5,065</b>
<b>23459</b>	<b>Interior Only</b> (for client's own refrigerator including ventilation slot & grommet at the back)			<b>495</b>



- all necessary cutouts, ventilation and mounting hardware for the refrigerator is provided
- The refrigerator door is finished in stainless steel and opens separately from the credenza door.
- refrigerator door is hinged on the same side as credenza door
- 3.5 cu. ft. refrigeration capacity
- adjustable tempered glass shelves
- adjustable temperature controls
- case and frame are matte black with a brushed stainless steel door

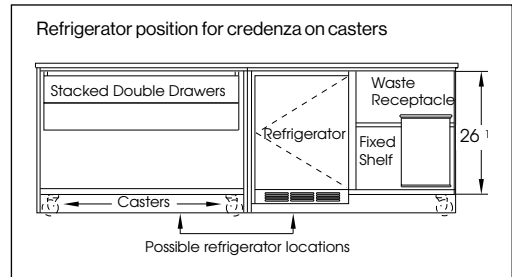

Model # 23449, in credenza on legs



Model # 23452, in credenza on glides



Vox credenzas on casters are available with a refrigeration option.

Refrigerator must be placed away from end pedestal, as illustrated above.

# VOX® CREDENZA INTERIOR OPTIONS

## STANDARD FEATURES

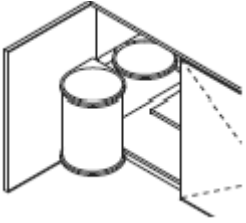
Vox credenzas reflect Nienkämper's commitment to producing well-made furniture that functions superbly. The waste receptacle options below have been designed/selected to accommodate most boardroom and office waste and recycling requirements.

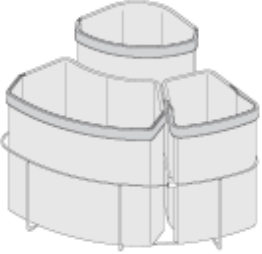
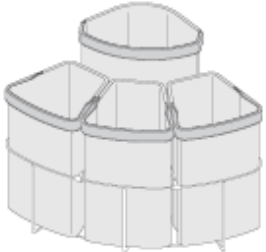
	Model Number	L" x D" x H"	List Price	Product Description
<u>WASTE RECEPTACLE / FIXED SHELF</u>	23454	14" x 12" x 16"	965	<ul style="list-style-type: none"> <li>the waste receptacle is mounted on the inside gable and opens with the credenza door</li> <li>the waste receptacle can be specified behind any credenza door</li> <li>a short fixed shelf is provided in the remaining area</li> <li>the waste receptacle is housed in a stainless steel canister</li> <li>overall capacity is 20 litres or 5¼ gallons</li> </ul>
				
<u>DOUBLE WASTE BIN</u>	23512	15 <sup>3</sup> / <sub>4</sub> " x 17 <sup>3</sup> / <sub>4</sub> " x 20 <sup>5</sup> / <sub>8</sub> "	370	<ul style="list-style-type: none"> <li>2 – 9 litre bins</li> <li>Soft &amp; silent close</li> <li>Container swings out automatically upon opening of the door</li> <li>No additional load on the front</li> <li>The lid rises slightly upon opening, and moves back snugly against the container upon closing</li> <li>Simple removal of the entire system for cleaning of the cupboard</li> </ul>
				
<u>TRIPLE WASTE BIN</u>	23513	19 <sup>5</sup> / <sub>8</sub> " x 17 <sup>3</sup> / <sub>4</sub> " x 20 <sup>5</sup> / <sub>8</sub> "	595	<ul style="list-style-type: none"> <li>1 – 9 litre bin, 1 – 12 litre bin, 1 – 19 litre bin</li> <li>Soft &amp; silent close</li> <li>Container swings out automatically upon opening of the door</li> <li>No additional load on the front</li> <li>The lid rises slightly upon opening, and moves back snugly against the container upon closing</li> <li>Simple removal of the entire system for cleaning of the cupboard</li> </ul>
				
<u>QUADRUPLE WASTE BIN</u>	23514	19 <sup>5</sup> / <sub>8</sub> " x 17 <sup>3</sup> / <sub>4</sub> " x 20 <sup>5</sup> / <sub>8</sub> "	595	<ul style="list-style-type: none"> <li>3 – 9 litre bin, 1 – 12 litre bin</li> <li>Soft &amp; silent close</li> <li>Container swings out automatically upon opening of the door</li> <li>No additional load on the front</li> <li>The lid rises slightly upon opening, and moves back snugly against the container upon closing</li> <li>Simple removal of the entire system for cleaning of the cupboard</li> </ul>
				



Model # 23454 Waste Bin with Shelf





Model # 23513 – Triple Waste Bin

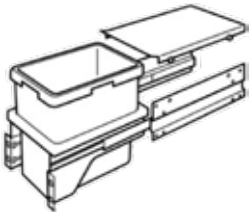

Model # 23514 Quadruple Waste Bin

PULL OUT WASTE BIN

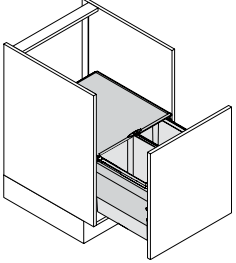
	Model Number	L" x D" x H"	List Price	Product Description
<u>SINGLE PULL OUT WASTE BIN</u>	23515	10½" x 16" x 17½"	1,425	<ul style="list-style-type: none"> <li>1 - 30 litre (8 gallons) bin</li> <li>plastic bin in grey, lid and bin holder in steel with silver grey epoxy-coated</li> <li>soft closing mechanism</li> <li>mounted to the inside of door and side gables of a single pedestal</li> <li>pull must be specified for the credenza</li> <li>list price included the upcharge for modification of casing and pull out door</li> <li>Single Pull Out Waste Bin can be installed inside credenza of 20"D or 25-1/2"D with 29"H or 34-1/4" or 34-1/2"H credenzas</li> </ul>
				
<u>DOUBLE PULL OUT WASTE &amp; RECYCLE BIN - FRONT TO BACK</u>	23516	16½" x 20¾" x 21½"	1,530	<ul style="list-style-type: none"> <li>2-38 litre (10 gallons) bins</li> <li>2 plastic bins in grey, lid and bin holder in steel with silver grey epoxy-coated</li> <li>soft closing mechanism</li> <li>mounted to the inside of door and side gables of a single pedestal</li> <li>pull must be specified for the credenza</li> <li>list price included the upcharge for modification of casing and pull out door</li> <li>Double Pull Out Waste &amp; Recycle Bin - Front to Back can only be installed inside 25-1/2"D credenza with 34-1/4" or 34-1/2"H</li> </ul>
				
<u>DOUBLE PULL OUT WASTE &amp; RECYCLE BIN - SIDE BY SIDE</u>	23517	16¼" x 18¼" x 18½"	1,690	<ul style="list-style-type: none"> <li>2-21 litre (5.5 gallons) bin</li> <li>2 plastic bins in grey, lid and bin holder with double powder-coated metal cover with protective enamel</li> <li>soft closing mechanism</li> <li>mounted to the inside of door and side gables of a single pedestal</li> <li>pull must be specified for the credenza</li> <li>list price included the upcharge for modification of casing and pull out door</li> <li>Double Pull Out Waste &amp; Recycle Bin - Side by Side can only be installed inside credenza of 25-1/2"D with 29"H or 34-1/4" or 34-1/2"H</li> </ul>
				



Model # 23515



Model # 23516



Model # 23517

## STANDARD FEATURES

Vox Boardroom credenzas reflect Nienkämper's commitment to producing well-made furniture that functions superbly. Optional interiors have been designed to enhance the basic design. Audio/Visual racking has been integrated directly into Vox credenzas providing optimum storage capacity for electronic equipment.

	Model Number	L" x D" x H"	List Price	Product Description
<b>EQUIPMENT STORAGE - SLIDING RAIL SYSTEM</b>	23458 <b>Rack Dimension</b>	19" x 19" x 22 <sup>3</sup> / <sub>4</sub> "	\$2,080	<ul style="list-style-type: none"> <li>takes the space of a single pedestal interior</li> <li>used for rack-mounted electronic components 19" wide up to a height of "12U"</li> </ul>
<b>EQUIPMENT STORAGE - ROTATING SLIDING RAIL SYSTEM</b>	23447 <b>Rack Dimension</b>	19" x 19" x 24"	<b>\$2,360</b>	<ul style="list-style-type: none"> <li>steel construction on ball bearing slides</li> <li>pulls out easily for equipment servicing</li> </ul>
	23448 <b>Interior Only (rack supplied by others)</b>		\$425	<ul style="list-style-type: none"> <li>optional pull out and swivel version</li> <li>opening at the back of the credenza is provided for wire access and ventilation</li> <li>locking strip permanently locks rack in the closed position</li> <li>overall capacity is 150 lbs.</li> <li>black finish</li> <li>fits credenzas 34<sup>1</sup>/<sub>4</sub>" high</li> </ul>

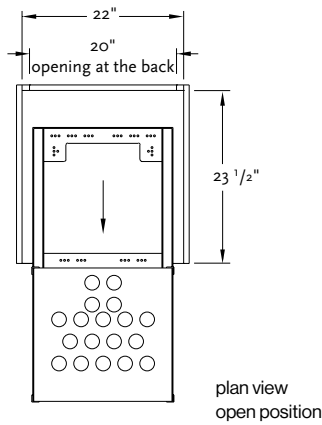
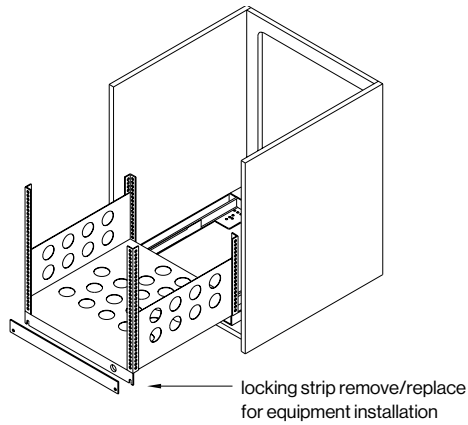

**Note: equipment not for use in 20" deep credenza or cart**



**Model # 23458**  
In closed position/locking strip in place.



**Model # 23458**  
In open position for servicing/locking strip removed.

## STANDARD FEATURES

Vox Boardroom credenzas reflect Nienkämper's commitment to producing well-made furniture that functions superbly. Optional interiors have been designed to enhance the basic design. Audio/Visual racking has been integrated directly into Vox credenzas providing optimum storage capacity for electronic equipment.

	Model Number	L" x D" x H" Rack Dimension	List Price	Product Description
<u>EQUIPMENT STORAGE - ROTATING SWING FRAME</u>	55026	21 <sup>3</sup> / <sub>4</sub> " x 4 <sup>1</sup> / <sub>2</sub> " x 25 <sup>1</sup> / <sub>2</sub> "	\$1,875	<ul style="list-style-type: none"> <li>takes the space of 2 pedestal interiors in any credenza size (with two 14" wide fixed shelves on right)</li> </ul>
	<b>55032</b>	<b>Interior Only (no rack supplied)</b>	<b>\$425</b>	<ul style="list-style-type: none"> <li>used for rack-mounted electronic components 19" wide up to a height of "12U"</li> <li>steel construction with pivoting hinge</li> <li>easily rotates out of the cabinet for equipment access</li> <li>may be locked in position with locking bolt.</li> <li>opening at the back of the credenza for additional wire access and ventilation</li> <li>overall capacity is 150 Lbs.</li> <li>complete with equipment mounting hardware</li> <li>beige finish</li> <li>fits credenzas 34<sup>1</sup>/<sub>4</sub>" high</li> </ul>

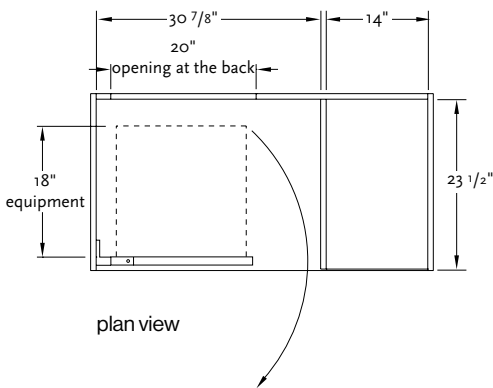
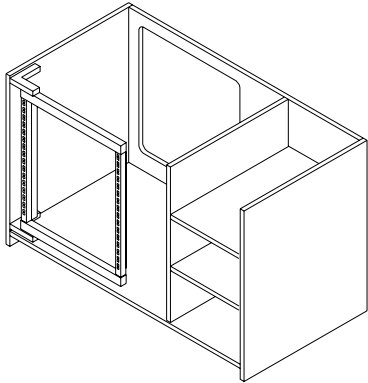

**Note: equipment not for use in 20" deep credenza or cart**



Model # 55026  
Rotating Swing Frame shown inside a Vox credenza.

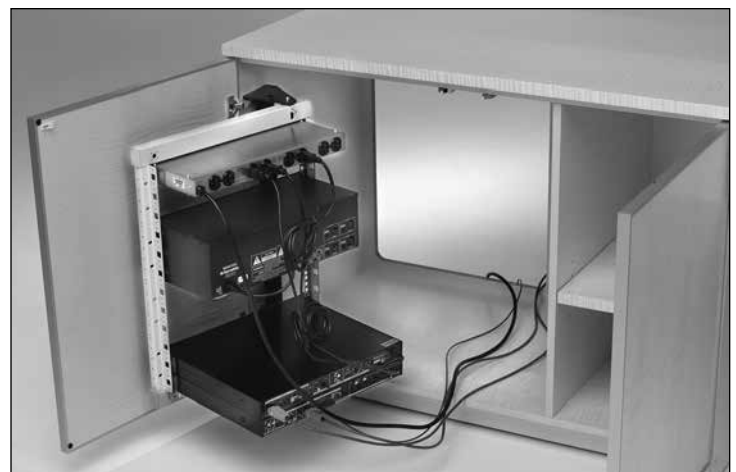

Model # 55026  
Rotating Swing Frame pivoting out to allow access to the back of the equipment.

# VOX® CREDENZA KNEESPACE TOPS FOR ALL CREDENZA STYLES

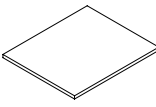
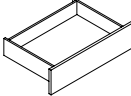
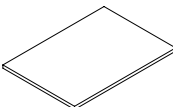
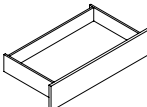
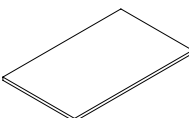
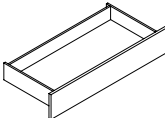
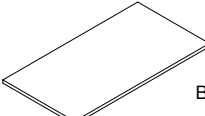
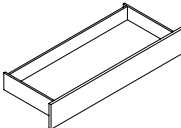
		Model Number	L" x D" x H"	List Price	Product Description
	<b>Tops for:</b> Vox Credenza on Legs	55291	30" x 25 <sup>1</sup> / <sub>2</sub> " x 1"	<b>570</b>	Create kneespace credenzas by bridging any two similar credenza models with a kneespace top.
	Vox Credenza	<b>55295</b>	<b>30" x 25<sup>3</sup>/<sub>8</sub>" x 1"</b>	<b>570</b>	Kneespace tops are available in 4 standard lengths.
	Boardroom Credenza	55299	30" x 25 <sup>7</sup> / <sub>8</sub> " x 1 <sup>1</sup> / <sub>4</sub> "	<b>630</b>	If additional storage is needed, an optional kneespace drawer in the corresponding size can be added to the kneespace top.
	Kneespace Drawer	<b>55303</b>	<b>29<sup>5</sup>/<sub>8</sub>" x 19<sup>1</sup>/<sub>16</sub>" x 7<sup>5</sup>/<sub>8</sub>"</b>	<b>720</b>	Drawer fronts match the finish selected for cabinet fronts and top.
					Large kneespace drawer interiors can be divided by specifying drawer dividers model number 28709 on page 302.
	<b>Tops for:</b>				
	Vox Credenza on Legs	55292	36" x 25 <sup>1</sup> / <sub>2</sub> " x 1"	<b>655</b>	
	Vox Credenza	<b>55296</b>	<b>36" x 25<sup>3</sup>/<sub>8</sub>" x 1"</b>	<b>655</b>	
	Boardroom Credenza	55300	36" x 25 <sup>7</sup> / <sub>8</sub> " x 1 <sup>1</sup> / <sub>4</sub> "	<b>685</b>	
	Kneespace Drawer	<b>55304</b>	<b>35<sup>5</sup>/<sub>8</sub>" x 19<sup>1</sup>/<sub>16</sub>" x 7<sup>5</sup>/<sub>8</sub>"</b>	<b>775</b>	
	<b>Tops for:</b>				
	Vox Credenza on Legs	55293	42" x 25 <sup>1</sup> / <sub>2</sub> " x 1"	<b>705</b>	
	Vox Credenza	<b>55297</b>	<b>42" x 25<sup>3</sup>/<sub>8</sub>" x 1"</b>	<b>705</b>	
	Boardroom Credenza	55301	42" x 25 <sup>7</sup> / <sub>8</sub> " x 1 <sup>1</sup> / <sub>4</sub> "	<b>745</b>	
	Kneespace Drawer	<b>55305</b>	<b>41<sup>5</sup>/<sub>8</sub>" x 19<sup>1</sup>/<sub>16</sub>" x 7<sup>5</sup>/<sub>8</sub>"</b>	<b>855</b>	
	<b>Tops for:</b>				
	Vox Credenza on Legs	55294	48" x 25 <sup>1</sup> / <sub>2</sub> " x 1"	<b>785</b>	
	Vox Credenza	<b>55298</b>	<b>48" x 25<sup>3</sup>/<sub>8</sub>" x 1"</b>	<b>785</b>	
	Boardroom Credenza	55302	48" x 25 <sup>7</sup> / <sub>8</sub> " x 1 <sup>1</sup> / <sub>4</sub> "	<b>830</b>	
	Kneespace Drawer	<b>55306</b>	<b>47<sup>5</sup>/<sub>8</sub>" x 19<sup>1</sup>/<sub>16</sub>" x 7<sup>5</sup>/<sub>8</sub>"</b>	<b>930</b>	

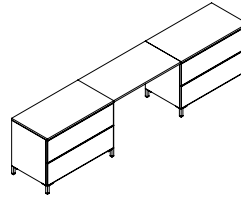
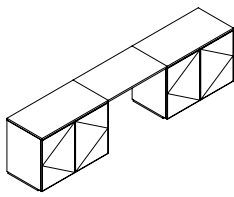
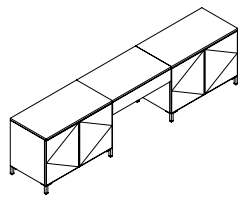
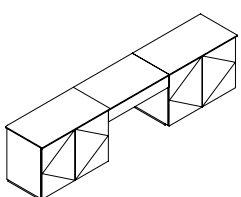



2 X Model #29226 Tangent Shelves with wire support, see page 334;  
 2 X Model #23432 Vox Credenza on Glides, see page 288, with  
 Model #55298 Vox Credenza Kneespace Top, see page 308.  
 All items F-21 Natural Moabe



2 X Model #29227 Tangent Shelving with wire support, see page 334;  
 2 X Model #28711 Vox Credenza on legs, see page 292, with  
 Model #55293 Vox Credenza Kneespace Top, see page 310.  
 Model #70302/2 Ellipse shape Project Table, see page 167.  
 All items F – 19 Natural Walnut, V4, Quarter-cut, Bookmatch