

Vox[®] FlipTop[™]

Mark Muller



nienkämper
International Inc.

Prices include freight charges, blanket wrapped, dock delivered, from the manufacturing source to any location in the contiguous United States. Packing and/or crating are available, if required, upcharges apply.

TABLE OF CONTENTS

WOOD VENEER/FINISHES	4
WOOD GRAIN PLASTIC LAMINATE SURFACES	5-7
BASE & STORAGE INFORMATION	8
FLIPTOP™ MODESTY PANEL PHOTOGRAPHS	9
FORUM INFORMATION	10
VOX®FLIPTOP™ CABLING PHOTOGRAPHY	11
VOX®FLIPTOP™ MEETING TABLES PHOTOGRAPHY	12
VOX®FLIPTOP™ MEETING TABLES WITH FLUSH LEGS	13-19
Tables for Meeting Room Applications	13-16
Meeting Room Layouts	17-19
VOX®FLIPTOP™ MEETING TABLES WITH INSET LEGS	20-27
Planning with FlipTop™ Tables	21
Tables for Meeting Room Applications	22-24
Meeting Room Layouts	25-27
VOX®FLIPTOP™ CONFERENCE TABLES	28-35
Edge Details	29
Forum Information	30
FlipTop™ Infill FlipTop™ Tables used with Conference Tables	31
Vox®Conference™ Tables used with Infill FlipTop™ Tables	32-33
Conference Room Layouts	34-35
TERMS AND CONDITIONS OF SALE	36

VENEERS

All wood surfaces are protected with a durable polyurethane clear laquer with UV inhibitor. This finish is known for its exceptional durability, as well as abrasion, chemical, impact and scratch resistance. Standard sheen level is 45 degrees. Optional 10 and 35 degree sheen levels are available on request at no additional cost.

Wood Species	Order Code	Veneer/Stain	Upcharge
Maple	F-01	Natural Maple	No upcharge applies.
	F-02	Natural Curly Maple - Rotary Cut	Add 15%.
	F-03	Natural Bird's Eye Maple - Rotary Cut	Call Customer Service for pricing.
	F-04	Maple Stained Pear	No upcharge applies.
Cherry	F-05	Natural Cherry	No upcharge applies.
	F-06	Standard Cherry	No upcharge applies.
	F-07	Cherry Stained Amber	No upcharge applies.
	F-08	Cherry Stained Auburn	No upcharge applies.
	F-09	Cherry Stained Burgundy	No upcharge applies.
Mahogany	F-10	Light Mahogany	No upcharge applies.
	F-11	Medium Mahogany	No upcharge applies.
	F-12	Dark Mahogany	No upcharge applies.
	F-13	Red Mahogany	No upcharge applies.
Anagre	F-14	Natural Figured Anagre - Qtr. Cut Book-Match	Add 15%.
	F-15	Figured Anagre Stained Amber - Qtr. Cut Book-Match	Add 15%.
Sycamore	F-16	Natural Figured Sycamore - Qtr. Cut Book-Match	Add 15%.
Walnut	F-17	Burnt Walnut	No upcharge applies.
	F-19	Natural Walnut	No upcharge applies.
	F-24	Carbon Grey Walnut	No upcharge applies.
White Oak	F-18	Natural White Oak - Flat Cut Book-Match (10° sheen)	No upcharge applies.
		Natural White Oak - Rift Cut Slip-Match (10° sheen)	Add 5%
Sapele – Ribbon Stripe	F-20	Natural Ribbon Strip Sepele - Qtr. Cut Slip-Match	No upcharge applies.
Moabe (Cherry substitute)	F-21	Natural Moabe - Quarter - Qtr. Cut Book-Match	No upcharge applies.
Cape Coast Walnut	F-22	Dark Cape Coast Walnut - Qtr. Cut Slip-Match	No upcharge applies.
	F-23	Natural Cape Coast Walnut - Qtr. Cut Slip-Match	No upcharge applies.
Ash	F-25	Slate Grey Ash - Qtr. Cut Slip-Match	No upcharge applies.

VENEER GRAIN OPTIONS

Nienkamper products utilize the best quality veneers available, and, combined with Nienkämper's patented veneering systems, create work environments of incredible quality and beauty.

All veneer furniture comes standard with flat cut book-match veneer; flat cut slip-match veneer can also be specified. Quarter cut slip-match and quarter cut book-match veneers are available at a 5% upcharge. Figured Anagre and Figured Sycamore veneers are Quarter cut book-matched. Bird's Eye Maple and Curly Maple are rotary cut.

Facet Edge, Taper edge and Flowform edge tops with veneer are manufactured with a solid wood edge. All edges are then veneer wrapped to create a seamless profile top.

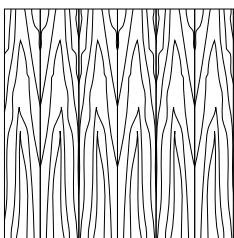

Standard Flat Cut Book-Match V1

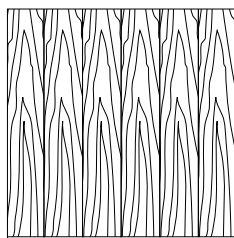

Flat Cut Slip-Match V2

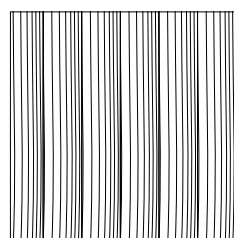

Quarter Cut Slip-Match Add 5% V3

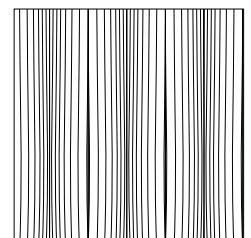

Quarter Cut Book-Match Add 5% V4

P-LAM

Wood grain plastic laminate surfaces are available on table tops with Facet and Taper edges.

These tops are manufactured with a solid wood edge that is applied prior to the laminate top surface. This method conceals the thickness of the wood edge, while providing the durability required. Wood edges are selected that most closely resemble both the species and the color of the laminate chosen

Nienkämper has pre-selected a number of standard wood grain plastic laminates that represent a cross section of both color and species. Simply include the order code with the model number to make these selections. Alternatively wood grain plastic laminates selected outside of Nienkämper's standard selection can be made by specifying the manufacturer as well as the description and model number of the laminate at the time of order. Note: for Facet edge tops the laminate must be a post-forming grade.

Wood Grain Plastic Laminate Surfaces	Order Code	Manufacturer #	Finish
Champagne Sagawood	WL1	Nevamar WM8349T	Textured
Hardrock Maple	WL2	Pionite WM791-SD	Textured/Suede
Amber Curly Maple	WL3	Pionite WM221-SD	Textured/Suede
Anagre	WL4	Pionite WX041-SD	Textured/Suede
Monticello Maple	WL5	Wilsonart 7925-38	Fine Velvet Texture
Millwork Cherry	WL7	Pionite WC431PV	PV-Polished Velvet
Figured Anagre	WL8	Formica7284-58	Matte
Huntington Maple	WL9	Wilsonart 7929-38	Fine Velvet Texture
Wild Cherry	WL10	Formica 5904.43	Artisan
Amber Cherry	WL11	Wilsonart 7919.38	Fine Velvet Texture
Figured Mahogany	WL12	Wilsonart 7040A-60	Matte
Fusion Maple	WL13	Wilsonart 7909-78	Fine Grain
New Age Oak	WL14	Wilsonart 7938-78	Fine Grain
Natural Pear	WL15	Wilsonart 7061-78	Fine Grain
Tuscan Walnut	WL16	Wilsonart 7921-78	Fine Grain
Nepal Teak	WL17	Wilsonart 7209-78	Fine Grain
Wild Cherry	WL18	Wilsonart 7054-78	Fine Grani
River Cherry	WL19	Wilsonart 7937-78	Fine Grain
Montana Walnut	WL20	Wilsonart 7110-78	Fine Grain
Sanara	WL21	Wilsonart 7932-78	Fine Grain
Windsor Mahogany	WL22	Wilsonart 7039-78	Fine Grain
Williamsburg Cherry	WL23	Wilsonart 7936-78	Fine Grain
Florence Walnut	WL25	Wilsonart 7993-78	Fine Grain
Skyline Walnut	WL26	Wilsonart 7964K-12	Soft Grain
Sterling Ash	WL27	Wilsonart 7995-78	Fine Grain

To specify the wood grain laminate required simply add the Order Code WL_ to the model number of the product.

Wood grain laminate samples are available from your local sales representative or by calling Nienkämper's customer service department at 1-800-668-9318.

P-LAM

COLOURED P-LAM

Both Taper and Facet edge profiles are available with a colored laminate top.

Laminate edging on Taper tops. Edging will match the top surface and is applied prior to the surface laminate. By applying the laminate in this way the seam is positioned horizontally, is much less conspicuous as well as more durable.

Wood edging on Facet and Taper Edge tops is applied prior to the laminate. By applying the wood edge in this way the thickness of the wood edge is concealed, while providing the durability required. Wood species and finishes for edging, can be selected from page 4.

For laminates specified outside of Nienkämper's standard selection, specify the manufacturer as well as the description and model number of the laminate selected at time of order. For Facet edge tops, the laminate must be a post forming grade.

Translucent edging on Taper edge tops is applied after the surface laminate. The translucent edge is very durable. Clear translucent edge provides a good match with most white colored laminates, while silver translucent edge provides a metallic look and contrast to colored plastic laminates.



Taper edge in clear translucent with white P-Lam top

Coloured Plastic Laminates Surface	Order Code	Manufacturer #	Finish
Grey (Nienkamper - Light Grey/Putty)	CL-01	Wilsonart 1500-60	Matte
Platinum Gray (Nienkamper - Medium Grey/Clay)	CL-02	Nevamar S6023T	Textured
Slate Grey (Nienkamper - Dark Grey)	CL-03	Wilsonart D91-60	Matte
Black	CL-04	Wilsonart 1595-60	Matte
Angel White	CL-05	Pionite SW-826SD	Textured/Suede
Frosty White	CL-06	Wilsonart 1573-60	Matte
White (for writable surface)	CL-07	Formica 949-90	Gloss



Add the order code behind the edge profile when specifying.

P-LAM

FINGERPRINT RESISTANCE P-LAM

Fingerprint Resistance Plastic Laminate is an innovative material created for interior design applications and is suitable for both vertical and horizontal interior applications on our nienkamper furniture.

The external surface of Fingerprint Resistance Plastic Laminate involves the use of nanotechnology made possible by next generation acrylic resins.

The unique composition offers extraordinary features coupled with a unique user experience. These include an ultra matt surface (eliminating glare), an ultra sofa feel, an anti-fingerprint surface, thermal healing of micro-scratches, increased durability as well as anti-bacterial and mold-resistant properties.

Edgeband with matching color to the Fingerprint Resistance Plastic Laminate is only available on taper edge. For 1" or 1-1/4" thick top with self edge, same Fingerprint Resistance Plastic Laminate can be specified for the self edge or it can be in clear/silver translucent edge.

There is a 10% upcharge on our standard plastic laminate table pricing for Fingerprint Resistance Plastic Laminate.

Colored "Fingerprint Resistance" Plastic Laminate Surface	Order Code	Finish
Black	RL-01	Matte
Gray	RL-02	Matte
Pure White	RL-03	Matte
Sand	RL-04	Matte
Bronze	RL-05	Matte

Edgeband to Match with Colored "Fingerprint Resistance" Plastic Laminate	Order Code
Black	RE-01
Gray	RE-02
Pure White	RE-03
Sand	RE-04
Bronze	RE-05

VOX® FLIPTOP™ MEETING TABLES

BASE AND STORAGE INFORMATION DESIGN - MARK MÜLLER

Vox FlipTop™ Base Design - This versatile design allows the top of the table to rotate into a vertical position for storage.

Each leg is independently locked at the top of the leg with a small catch. Moving the catch to one side locks or unlocks the base from the top. A small colored mark indicates the catch is in an unlocked position.

Low profile plastic casters are individually locked by depressing with the tip of a foot.

Hollow leg assemblies house gas cylinders that provide a neutral balance to the top. A stabilizer rail runs between the leg assemblies providing both structure and wire management.

Flush Legs - This option (pages 13-19) allows multiple tables to be joined together while maximizing knee space to the users. Seams between tables are never used as work areas.

Inset Legs - This option (pages 20-27) maximizes the number of users allowing seating at the end of tables

Flush Leg Style

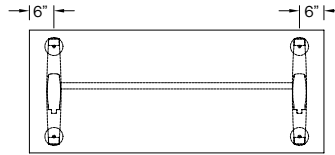

Inset Leg Style

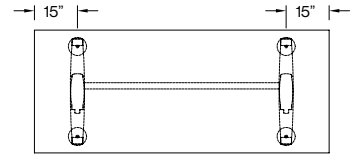

Description

STANDARD VOX FLIPTOP T-BASE

Base Width “

24” Base for 24” deep tops

26” Base for 30” & 36” deep tops

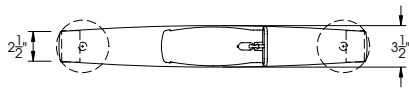

PLAN VIEW

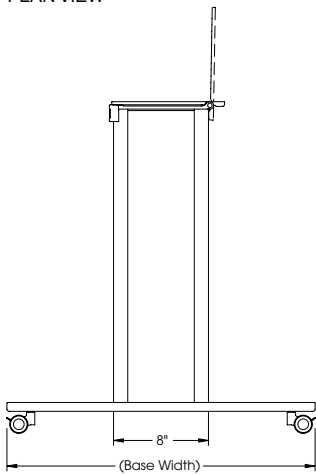

END ELEVATION

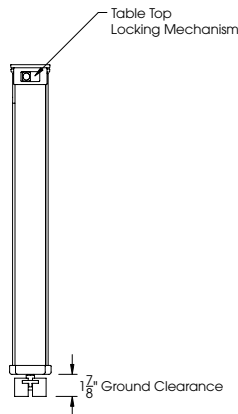

FRONT ELEVATION



Flush leg shown

STORAGE REQUIREMENTS

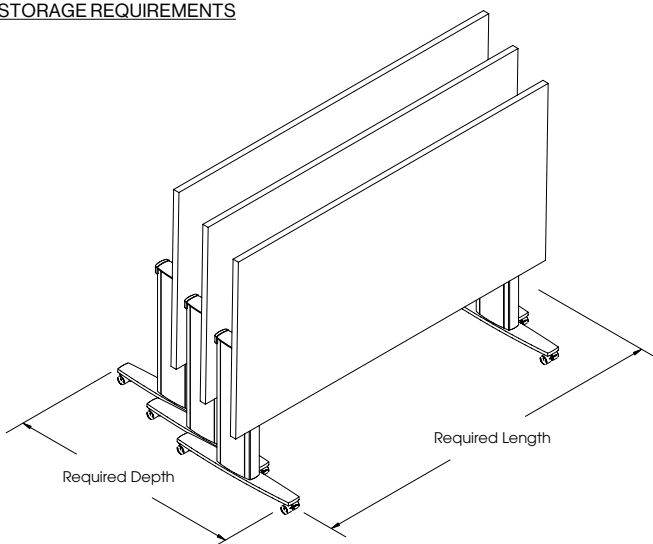

Table Length	Floor Space Required When Nested (L" x D")		
	4 Tables	8 Tables	12 Tables
For 24" to 27" Deep Tops			
60	72x55	87x96	102x137
66	78x55	93x96	108x137
72	84x55	99x96	114x137
78	90x55	105x96	120x137
84	96x55	111x96	126x137
90	102x55	117x96	132x137
For 30" to 36" Deep Tops			
60	72x57	87x98	102x139
66	78x57	93x98	108x139
72	84x57	99x98	114x139
78	90x57	105x98	120x139
84	96x57	111x98	126x139
90	102x57	117x98	132x139

VOX® FLIPTOP™ MODESTY PANELS

PHOTOGRAPHY DESIGN – MARK MÜLLER

Vox® FlipTop tables can be specified with modesty panels. Standard options include veneer to match the top, laminate with translucent edging to match the top, or anodized-aluminum.

A unique flexible hinge joins the modesty panel to the tabletop. When the top is flipped up, the panel aligns with the top and swivels out of the way.



Tables shown with natural cherry veneer and aluminum modesty panels



Table and modesty panel shown in rift cut walnut



Table and modesty panel shown in wood grain laminate WL-1

FORUM INFORMATION

DESIGN – MARK MÜLLER

Vox® FlipTop™ tables can be specified with optional Vox® Forums. Pre-wired “S-Series” Forums as well as “T-Series” Forums are available.

“T-Series” Forums have an added benefit of removing voice/data/power cords directly from the Forum, to be connected when required. This feature also gives the user the option of specifying longer cables when needed.

“S-Series” Forums offer a broad range of pre-wired connections in a slightly larger format than T-Series Forums.

A rail joining the two table legs acts as a stabilizer for the table and along with wire management clips provide a convenient place to store cables.

For complete Vox® Forum™ details refer to the 2007 Vox® Conference™ Price List or simply download the information at: www.nienkamper.com/downloads/Price%20List/US_VoxForums.pdf

FlipTop Tables (1" top thickness)

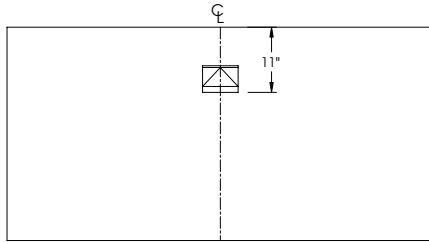

Rectangular Shape

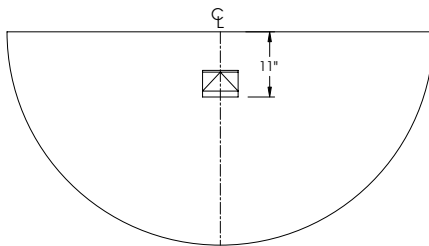

Half-Round Shape

“T” Series Forum

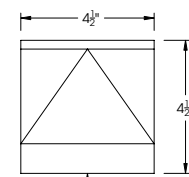

Models TR-A and TR-B

“T” Series Forum

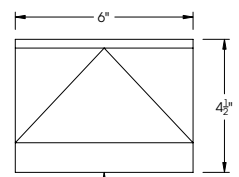

Models TR-C and TR-D

“S” Series Forum

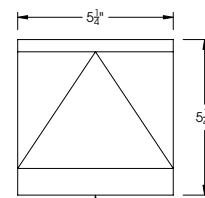

Models A,B,C,G and H

“S” Series Vox® Forums

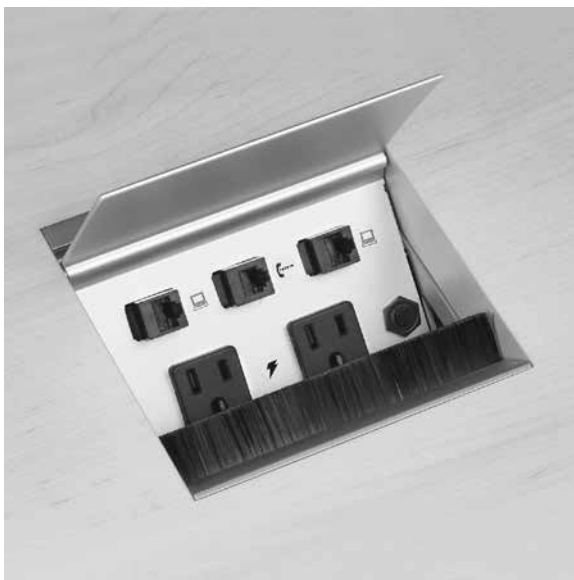

The “S-Series” Forum is available in 2 sizes: 5 1/4” W or 12” W. Fourteen models from A to I with eight data configurations to satisfy most requirements.

“T” Series Vox® Meeting Forums



The “T-Series” Forum is available in 2 sizes 4 1/2” long and 6” long. Power, voice, and data cables can be detached from this Forum for ease of reconfiguring multiple tables or for applying longer cords.

VOX®FLIPTOP™ CABLING

PHOTOGRAPHY DESIGN – MARK MÜLLER



When Vox®FlipTop tables include Vox Forums, cables are routed along the length of the aluminum rail and held in place with plastic wire management clips provided.

This method allows cabling to be located to either side of the table, and connect to the most convenient outlet.

When tables are not in use the same cabling can be easily stowed along the rail with the wire management clips.



Once cables have been located to either leg they can be discretely routed to the floor inside a wire chase that runs up the center of the interior of each leg. A continuous flexible rubber strip holds the cables in place terminating at the base of the leg with a slot that allows the cables to exit the leg.

VOX®FLIPTOP™ MEETING TABLES

PHOTOGRAPHY DESIGN – MARK MÜLLER



**VOX® FLIPTOP™ MEETING TABLES
WITH FLUSH LEGS**

VOX® FLIPTOP™ MEETING TABLE

FLUSH LEGS

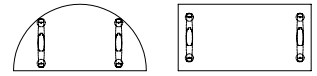

On this page:

Wood veneer tables are standard with a 1/8" solid wood edge that has a slight radius.

P-lam tables are standard with a 1/8" translucent edging that has a slight radius.

Mirror-polished

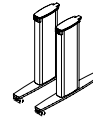

Anodized Finish

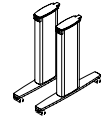

Tops are 1" Thick

	L"	x	D"	x	H"	Top Finish	Model Number	2 T-Bases	List Price	Model Number	2 T-Bases	List Price
RECTANGLE TABLES												
 "Shown Flipped Down"	60	24	29	Wood	56101/2	(2-24")	4,890	56111/2	(2-24")	4,375		
	60	24	29	P-Lam	56102/5	(2-24")	4,680	56112/5	(2-24")	4,170		
	66	24	29	Wood	56103/2	(2-24")	4,990	56113/2	(2-24")	4,480		
	66	24	29	P-Lam	56104/5	(2-24")	4,765	56114/5	(2-24")	4,255		
	72	24	29	Wood	56105/2	(2-24")	5,115	56115/2	(2-24")	4,615		
	72	24	29	P-Lam	56106/5	(2-24")	4,870	56116/5	(2-24")	4,365		
	78	24	29	Wood	56107/2	(2-24")	5,215	56117/2	(2-24")	4,710		
	78	24	29	P-Lam	56108/5	(2-24")	4,950	56118/5	(2-24")	4,445		
	84	24	29	Wood	56109/2	(2-24")	5,315	56119/2	(2-24")	4,815		
	84	24	29	P-Lam	56110/5	(2-24")	5,030	56120/5	(2-24")	4,525		
 "Shown Flipped Up"	90	24	29	Wood	56180/2	(2-24")	5,425	56182/2	(2-24")	4,905		
	90	24	29	P-Lam	56181/5	(2-24")	5,110	56183/5	(2-24")	4,605		
	60	30	29	Wood	56121/2	(2-26")	5,180	56131/2	(2-26")	4,665		
	60	30	29	P-Lam	56122/5	(2-26")	4,905	56132/5	(2-26")	4,400		
	66	30	29	Wood	56123/2	(2-26")	5,290	56133/2	(2-26")	4,775		
	66	30	29	P-Lam	56124/5	(2-26")	5,010	56134/5	(2-26")	4,490		
	72	30	29	Wood	56125/2	(2-26")	5,455	56135/2	(2-26")	4,945		
	72	30	29	P-Lam	56126/5	(2-26")	5,150	56136/5	(2-26")	4,635		
	78	30	29	Wood	56127/2	(2-26")	5,580	56137/2	(2-26")	5,070		
	78	30	29	P-Lam	56128/5	(2-26")	5,250	56138/5	(2-26")	4,735		
84	30	29	Wood	56129/2	(2-26")	5,685	56139/2	(2-26")	5,175			
84	30	29	P-Lam	56130/5	(2-26")	5,315	56140/5	(2-26")	4,815			
90	30	29	Wood	56184/2	(2-26")	5,775	56186/2	(2-26")	5,270			
90	30	29	P-Lam	56185/5	(2-26")	5,395	56187/5	(2-26")	4,890			
60	36	29	Wood	56141/2	(2-26")	5,460	56151/2	(2-26")	4,950			
60	36	29	P-Lam	56142/5	(2-26")	5,135	56152/5	(2-26")	4,630			
66	36	29	Wood	56143/2	(2-26")	5,590	56153/2	(2-26")	5,085			
66	36	29	P-Lam	56144/5	(2-26")	5,240	56154/5	(2-26")	4,725			
72	36	29	Wood	56145/2	(2-26")	5,790	56155/2	(2-26")	5,280			
72	36	29	P-Lam	56146/5	(2-26")	5,425	56156/5	(2-26")	4,905			
78	36	29	Wood	56147/2	(2-26")	5,940	56157/2	(2-26")	5,440			
78	36	29	P-Lam	56148/5	(2-26")	5,540	56158/5	(2-26")	5,030			
84	36	29	Wood	56149/2	(2-26")	6,045	56159/2	(2-26")	5,530			
84	36	29	P-Lam	56150/5	(2-26")	5,605	56160/5	(2-26")	5,095			
90	36	29	Wood	56188/2	(2-26")	6,130	56190/2	(2-26")	5,625			
90	36	29	P-Lam	56189/5	(2-26")	5,695	56191/5	(2-26")	5,180			
HALF-ROUND TABLES												
 "Shown Flipped Down"	30	60	29	Wood	56161/2	(2-24")	5,180	56171/2	(2-24")	4,665		
	30	60	29	P-Lam	56162/5	(2-24")	4,905	56172/5	(2-24")	4,400		
 "Shown Flipped Up"	36	72	29	Wood	56163/2	(2-26")	5,455	56173/2	(2-26")	4,945		
	36	72	29	P-Lam	56164/5	(2-26")	5,150	56174/5	(2-26")	4,635		

VOX® FLIPTOP™ MEETING TABLE

FLUSH LEGS WITH WOOD OR P-LAM MODESTY PANEL



On this page:

Wood veneer tables are standard with a 1/8" solid wood edge that has a slight radius and a wood veneer modesty panel that is self edged

P-lam tables are standard with a 1/8" translucent edging that has a slight radius and a plastic laminate modesty panel with translucent edging to match the top

Tops are 1" Thick

Mirror-polished

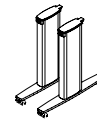

Anodized Finish

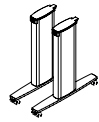

	L"	x	D"	x	H"	Top Finish	Model Number	2 T-Bases	List Price	Model Number	2 T-Bases	List Price
RECTANGLE TABLES	60		24		29	Wood	56101/2P	(2-24")	5,665	56111/2P	(2-24")	5,150
	60		24		29	P-Lam	56102/5P	(2-24")	5,380	56112/5P	(2-24")	4,870
	66		24		29	Wood	56103/2P	(2-24")	5,760	56113/2P	(2-24")	5,255
	66		24		29	P-Lam	56104/5P	(2-24")	5,475	56114/5P	(2-24")	4,970
	72		24		29	Wood	56105/2P	(2-24")	5,905	56115/2P	(2-24")	5,385
	72		24		29	P-Lam	56106/5P	(2-24")	5,590	56116/5P	(2-24")	5,085
	78		24		29	Wood	56107/2P	(2-24")	6,030	56117/2P	(2-24")	5,515
	78		24		29	P-Lam	56108/5P	(2-24")	5,685	56118/5P	(2-24")	5,175
	84		24		29	Wood	56109/2P	(2-24")	6,115	56119/2P	(2-24")	5,615
	84		24		29	P-Lam	56110/5P	(2-24")	5,760	56120/5P	(2-24")	5,255
	90		24		29	Wood	56180/2P	(2-24")	6,245	56182/2P	(2-24")	5,720
	90		24		29	P-Lam	56181/5P	(2-24")	5,860	56183/5P	(2-24")	5,345
	60		30		29	Wood	56121/2P	(2-26")	5,935	56131/2P	(2-26")	5,435
	60		30		29	P-Lam	56122/5P	(2-26")	5,615	56132/5P	(2-26")	5,100
	66		30		29	Wood	56123/2P	(2-26")	6,075	56133/2P	(2-26")	5,550
	66		30		29	P-Lam	56124/5P	(2-26")	5,715	56134/5P	(2-26")	5,205
	72		30		29	Wood	56125/2P	(2-26")	6,250	56135/2P	(2-26")	5,725
	72		30		29	P-Lam	56126/5P	(2-26")	5,875	56136/5P	(2-26")	5,360
	78		30		29	Wood	56127/2P	(2-26")	6,370	56137/2P	(2-26")	5,880
	78		30		29	P-Lam	56128/5P	(2-26")	5,965	56138/5P	(2-26")	5,460
	84		30		29	Wood	56129/2P	(2-26")	6,480	56139/2P	(2-26")	5,965
	84		30		29	P-Lam	56130/5P	(2-26")	6,060	56140/5P	(2-26")	5,540
	90		30		29	Wood	56184/2P	(2-26")	6,605	56186/2P	(2-26")	6,085
	90		30		29	P-Lam	56185/5P	(2-26")	6,130	56187/5P	(2-26")	5,625
	60		36		29	Wood	56141/2P	(2-26")	6,245	56151/2P	(2-26")	5,720
	60		36		29	P-Lam	56142/5P	(2-26")	5,855	56152/5P	(2-26")	5,340
	66		36		29	Wood	56143/2P	(2-26")	6,350	56153/2P	(2-26")	5,865
	66		36		29	P-Lam	56144/5P	(2-26")	5,940	56154/5P	(2-26")	5,440
	72		36		29	Wood	56145/2P	(2-26")	6,565	56155/2P	(2-26")	6,075
	72		36		29	P-Lam	56146/5P	(2-26")	6,130	56156/5P	(2-26")	5,625
	78		36		29	Wood	56147/2P	(2-26")	6,740	56157/2P	(2-26")	6,250
	78		36		29	P-Lam	56148/5P	(2-26")	6,270	56158/5P	(2-26")	5,750
	84		36		29	Wood	56149/2P	(2-26")	6,840	56159/2P	(2-26")	6,325
	84		36		29	P-Lam	56150/5P	(2-26")	6,330	56160/5P	(2-26")	5,835
	90		36		29	Wood	56188/2P	(2-26")	6,945	56190/2P	(2-26")	6,445
	90		36		29	P-Lam	56189/5P	(2-26")	6,435	56191/5P	(2-26")	5,915

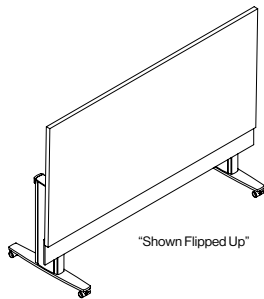
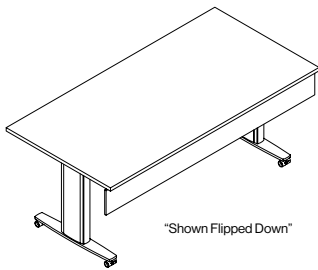

Flat steel swivel latches allow unlimited positioning for ganging Vox FlipTop tables together.

VOX® FLIPTOP™ MEETING TABLE

FLUSH LEGS WITH ALUMINUM MODESTY PANEL



On this page

Wood veneer tables are standard with a 1/8" solid wood edge that has a slight radius and an aluminum modesty panel with grey plastic edging

P-lam tables are standard with a 1/8" translucent edging that has a slight radius and an aluminum modesty panel with grey plastic edging

Tops are 1" Thick

Mirror-polished

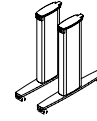

Anodized Finish

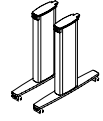

	L"	x	D"	x	H"	Top Finish	Model Number	2 T-Bases	List Price	Model Number	2 T-Bases	List Price
RECTANGLE TABLES	60		24		29	Wood	56101/2AP	(2-24")	5,700	56111/2AP	(2-24")	5,185
	60		24		29	P-Lam	56102/5AP	(2-24")	5,425	56112/5AP	(2-24")	4,905
	66		24		29	Wood	56103/2AP	(2-24")	5,795	56113/2AP	(2-24")	5,290
	66		24		29	P-Lam	56104/5AP	(2-24")	5,520	56114/5AP	(2-24")	5,010
	72		24		29	Wood	56105/2AP	(2-24")	5,930	56115/2AP	(2-24")	5,430
	72		24		29	P-Lam	56106/5AP	(2-24")	5,625	56116/5AP	(2-24")	5,115
	78		24		29	Wood	56107/2AP	(2-24")	6,060	56117/2AP	(2-24")	5,540
	78		24		29	P-Lam	56108/5AP	(2-24")	5,715	56118/5AP	(2-24")	5,205
	84		24		29	Wood	56109/2AP	(2-24")	6,150	56119/2AP	(2-24")	5,645
	84		24		29	P-Lam	56110/5AP	(2-24")	5,795	56120/5AP	(2-24")	5,290
	90		24		29	Wood	56180/2AP	(2-24")	6,270	56182/2AP	(2-24")	5,750
	90		24		29	P-Lam	56181/5AP	(2-24")	5,890	56183/5AP	(2-24")	5,375
	60		30		29	Wood	56121/2AP	(2-26")	5,975	56131/2AP	(2-26")	5,465
	60		30		29	P-Lam	56122/5AP	(2-26")	5,645	56132/5AP	(2-26")	5,135
	66		30		29	Wood	56123/2AP	(2-26")	6,100	56133/2AP	(2-26")	5,590
	66		30		29	P-Lam	56124/5AP	(2-26")	5,745	56134/5AP	(2-26")	5,240
	72		30		29	Wood	56125/2AP	(2-26")	6,275	56135/2AP	(2-26")	5,760
	72		30		29	P-Lam	56126/5AP	(2-26")	5,905	56136/5AP	(2-26")	5,385
	78		30		29	Wood	56127/2AP	(2-26")	6,430	56137/2AP	(2-26")	5,910
	78		30		29	P-Lam	56128/5AP	(2-26")	6,015	56138/5AP	(2-26")	5,505
	84		30		29	Wood	56129/2AP	(2-26")	6,510	56139/2AP	(2-26")	6,015
	84		30		29	P-Lam	56130/5AP	(2-26")	6,090	56140/5AP	(2-26")	5,575
	90		30		29	Wood	56184/2AP	(2-26")	6,630	56186/2AP	(2-26")	6,110
	90		30		29	P-Lam	56185/5AP	(2-26")	6,165	56187/5AP	(2-26")	5,675
	60		36		29	Wood	56141/2AP	(2-26")	6,270	56151/2AP	(2-26")	5,750
	60		36		29	P-Lam	56142/5AP	(2-26")	5,885	56152/5AP	(2-26")	5,370
	66		36		29	Wood	56143/2AP	(2-26")	6,420	56153/2AP	(2-26")	5,895
	66		36		29	P-Lam	56144/5AP	(2-26")	5,985	56154/5AP	(2-26")	5,475
	72		36		29	Wood	56145/2AP	(2-26")	6,620	56155/2AP	(2-26")	6,100
	72		36		29	P-Lam	56146/5AP	(2-26")	6,165	56156/5AP	(2-26")	5,675
	78		36		29	Wood	56147/2AP	(2-26")	6,785	56157/2AP	(2-26")	6,275
	78		36		29	P-Lam	56148/5AP	(2-26")	6,295	56158/5AP	(2-26")	5,790
	84		36		29	Wood	56149/2AP	(2-26")	6,880	56159/2AP	(2-26")	6,350
	84		36		29	P-Lam	56150/5AP	(2-26")	6,360	56160/5AP	(2-26")	5,875
	90		36		29	Wood	56188/2AP	(2-26")	6,990	56190/2AP	(2-26")	6,475
	90		36		29	P-Lam	56189/5AP	(2-26")	6,460	56191/5AP	(2-26")	5,940

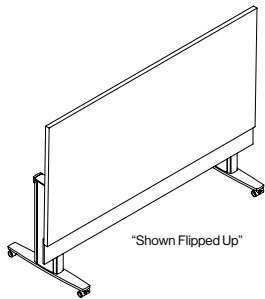
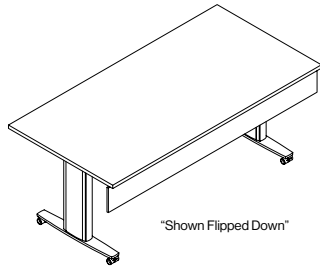

Vox FlipTop tables with aluminum modesty panels.

VOX® MEETING ROOM LAYOUTS

FLUSH LEGS **DRAWINGS NOT TO SCALE**

ROOM1-LAYOUT A1

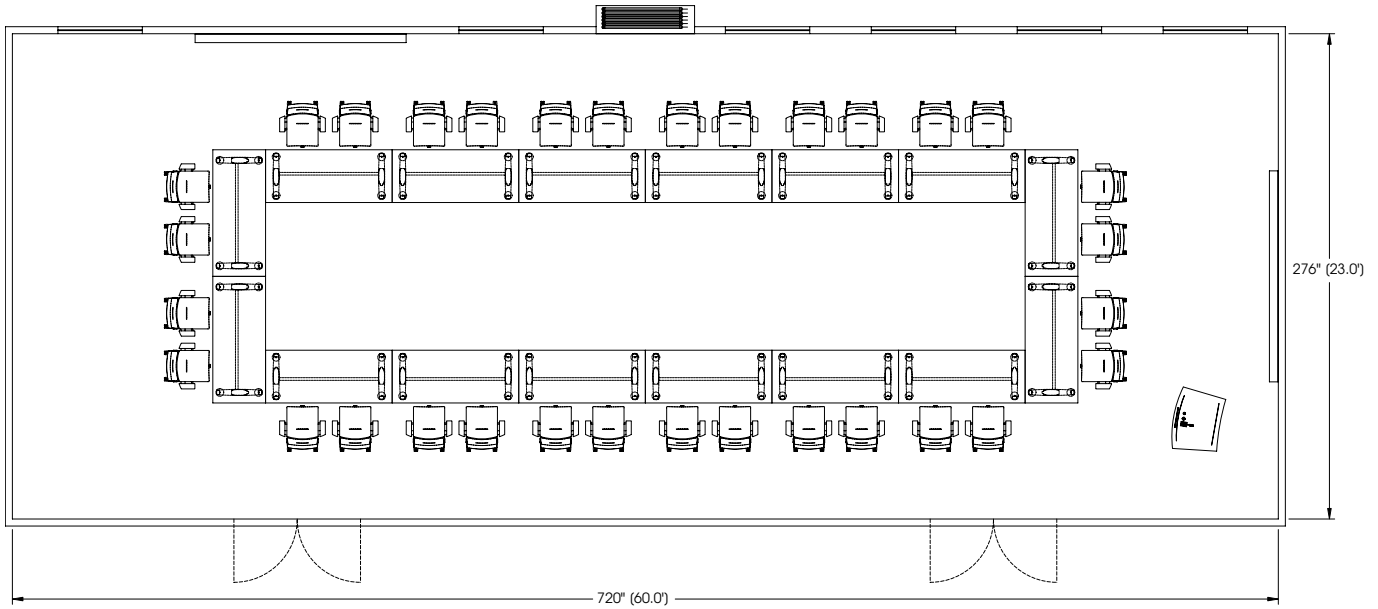

ROOM1-LAYOUT A2

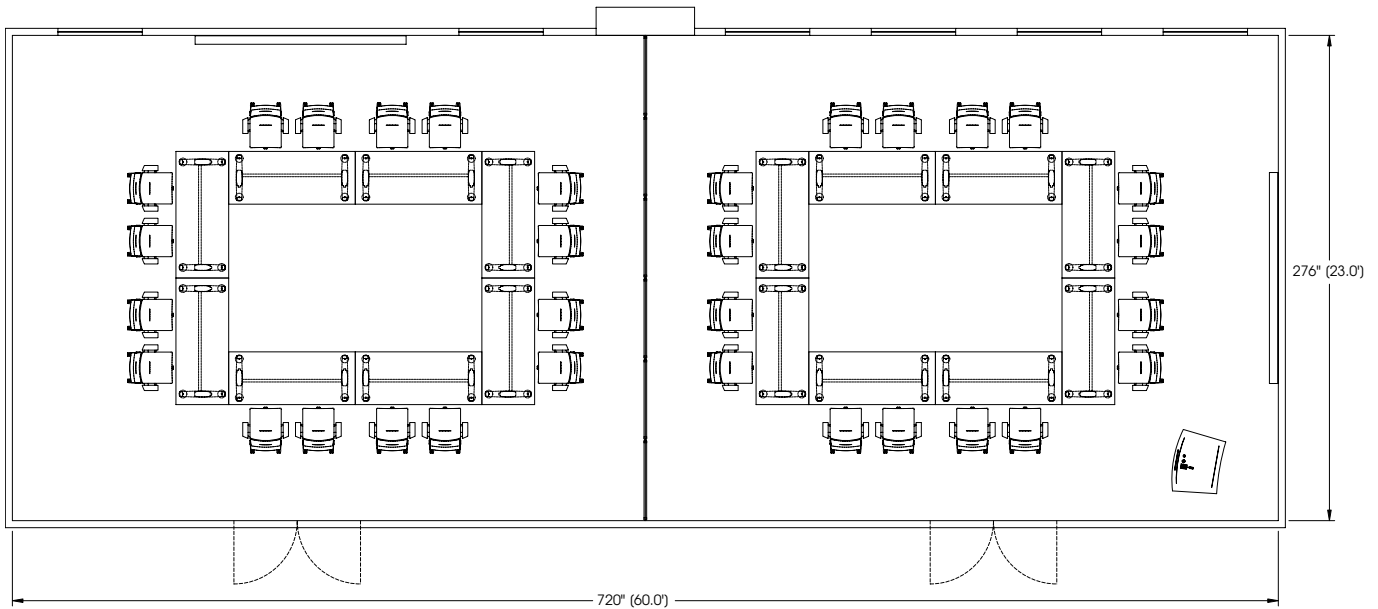

Product Name	Model Number	List Price
16-Vox® FlipTop™ 72" x 30" tables	56135/2	79,030
1-Vox® Presenter's Lectern	23465	9,980
2-120" Vox® Presentation Walls	23494/2	17,315
32-NOW® Conference Chairs, with casters	13022	69,940
Total		176,265

VOX® MEETING ROOM LAYOUTS

FLUSH LEGS DRAWINGS NOT TO SCALE

ROOM1-LAYOUT A3

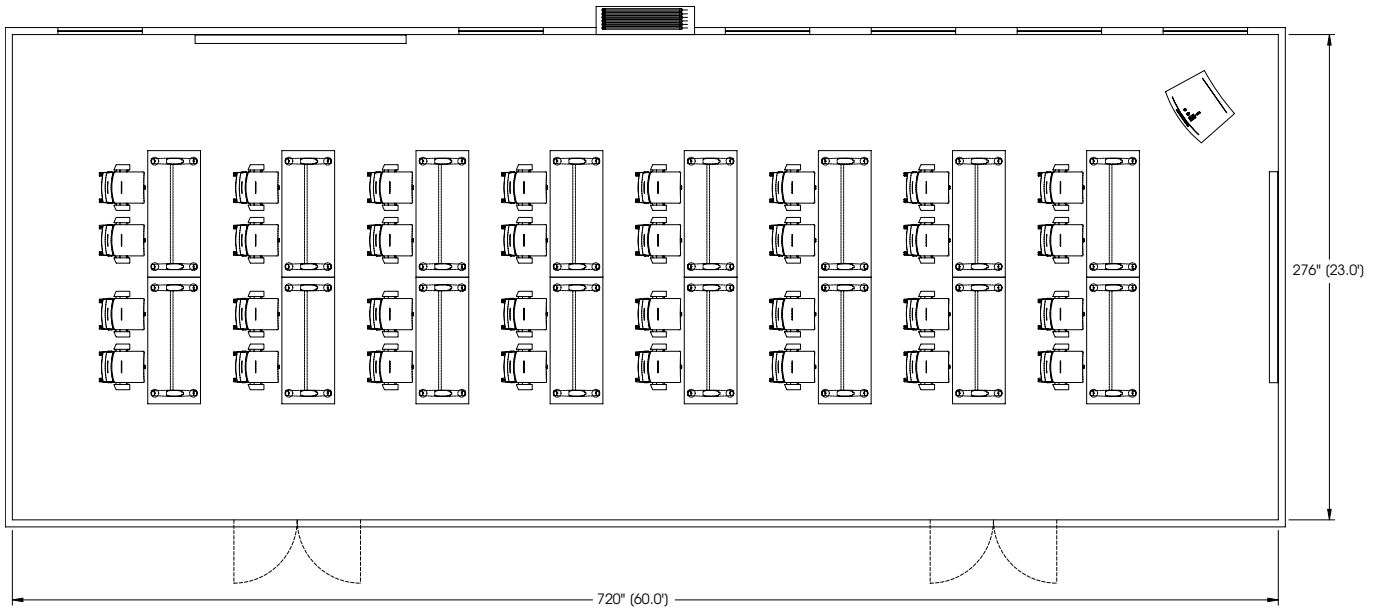

ROOM1-LAYOUT A4

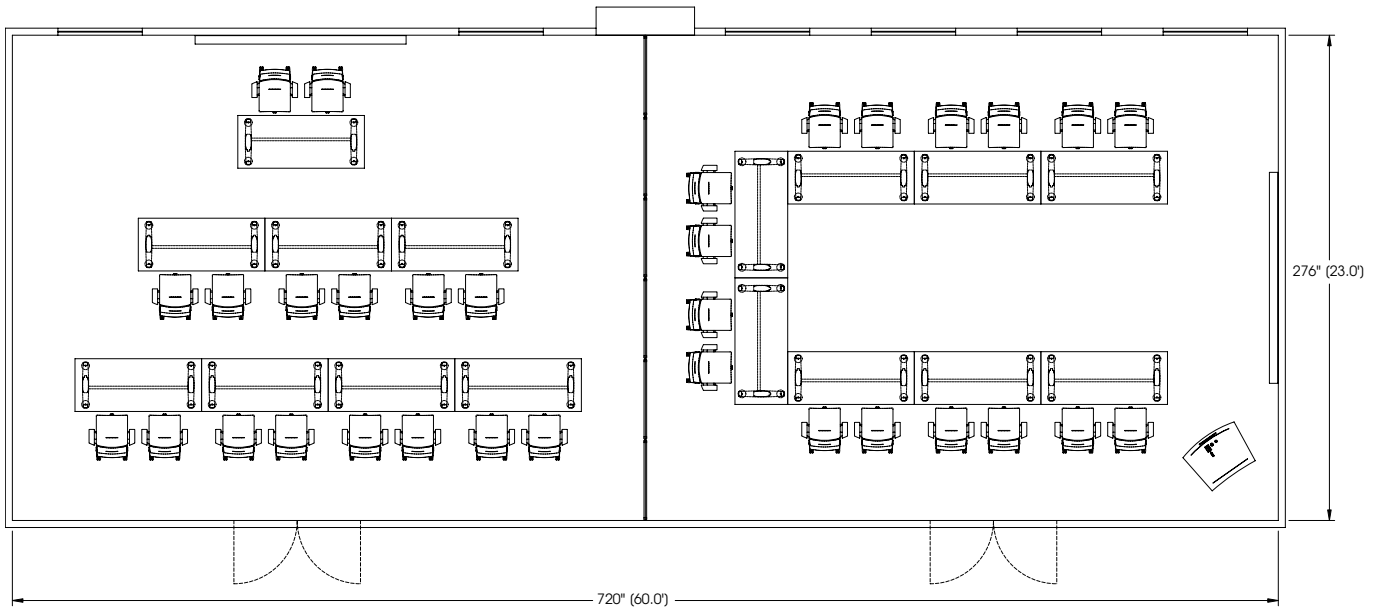

Product Name	Model Number	List Price
16-Vox® FlipTop™ 72" x 30" tables	56135/2	79,030
1-Vox® Presenter's Lectern	23465	9,980
2-120" Vox® Presentation Walls	23494/2	17,315
32-NOW® Conference Chairs, with casters	13022	69,940
Total		176,265

VOX® MEETING ROOM LAYOUTS

FLUSH LEGS **DRAWINGS NOT TO SCALE**

ROOM2 – LAYOUT B1

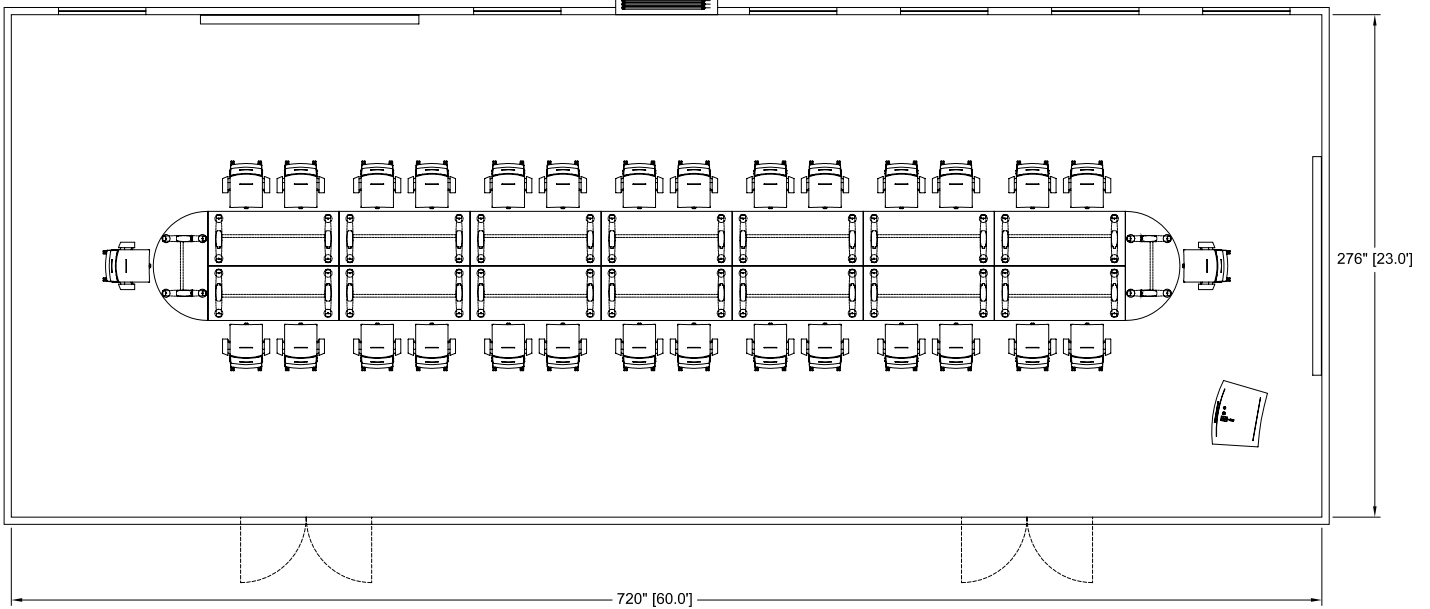

ROOM2 – LAYOUT B2

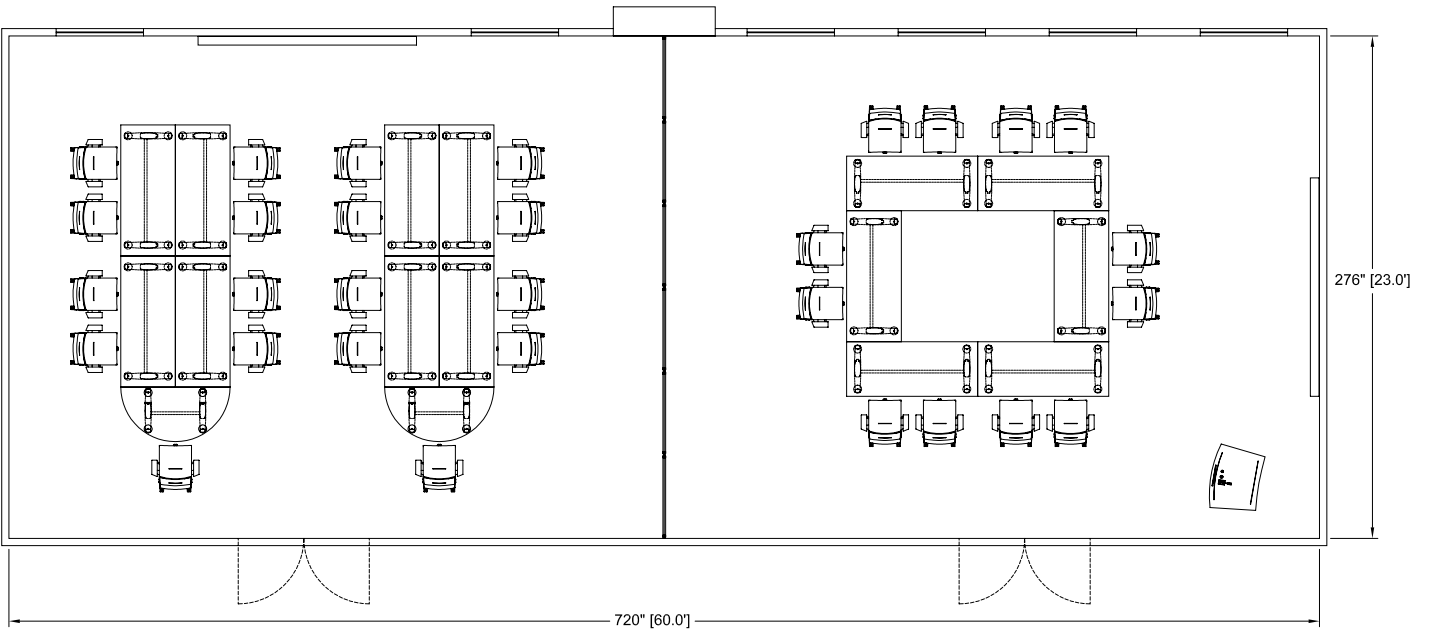

Product Name	Model Number	List Price
14-Vox®FlipTop™ 72" x 30" tables	56135/2	69,155
2-Vox®FlipTop™ Half Round 60" x 30" tables	56171/2	9,320
1-Vox® Presenter's Lectern	23465	9,980
2-120" Vox® Presentation Walls	23494/2	17,315
30-NOW® Conference Chairs, with casters	13022	65,565
Total		171,335

**VOX® FLIPTOP™ MEETING TABLES
WITH INSET LEGS**

PLANNING WITH VOX® FLIPTOP™ TABLES

INSET LEGS VS FLUSH LEGS DESIGN - MARK MÜLLER

Simple and effective tools are available for any space planning required. You can access a full set of PDF and CAD files for Vox FlipTop tables by following the links below.

Type www.nienkamper.com in your browser

Pick the Products Tab heading, (top left)

Select the FlipTop/Meeting Tables category

Select Vox'FlipTop™ Product and scroll down to resources

Drawings based on seating quantities are listed from 6 to 30 seats and offer a plan view of all options available.

Sample file to seat 10:

IGFgroup

nienkämper

VOX® FLIPTOP™ TABLES

10 SEATS

(BASED ON CHAIR WIDTH OF 26")

FL= FLUSH / IN= INSET
SEATING QUANTITY
TABLE DEPTH
A=24" / *B*=30" / *C*=36"
KEY: FL-OG-A1
LAYOUT VERSION (1,2,3...)

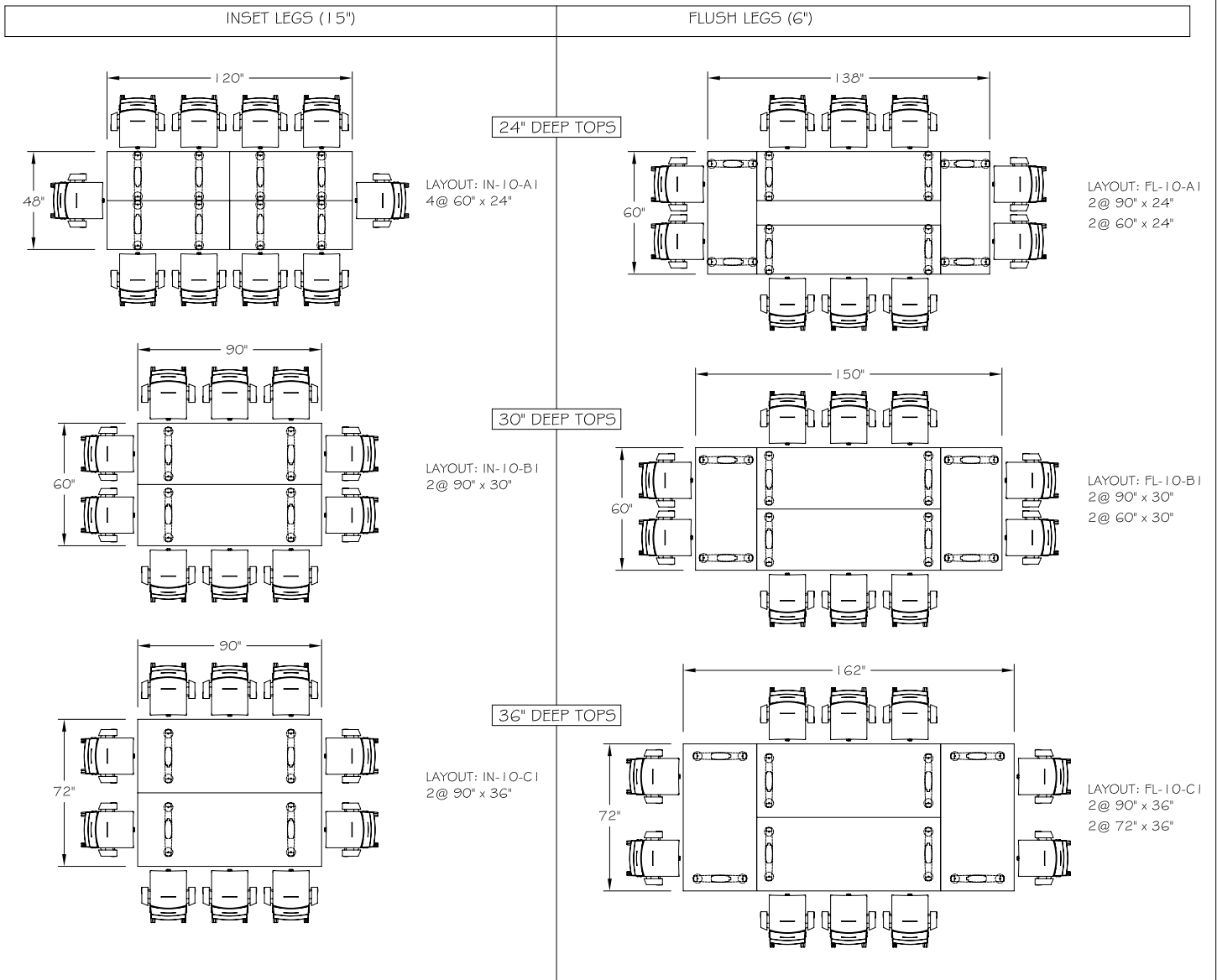

THIS DRAWING IS CONFIDENTIAL AND PROPRIETARY. NO PART OF THIS DRAWING MAY BE COPIED, DISCLOSED TO ANY THIRD PARTY OR USED FOR ANY PURPOSE WITHOUT THE EXPRESS WRITTEN AUTHORIZATION OF NIENKÄMPER FURNITURE & ACCESSORIES

VOX®FLIPTOP™ MEETING TABLE

INSET LEGS DESIGN – MARK MÜLLER

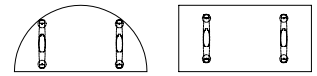

On this page:

Wood veneer tables are standard with a 1/8" solid wood edge that has a slight radius.

P-lam tables are standard with a 1/8" translucent edging that has a slight radius.

Mirror-polished

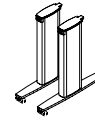

Anodized Finish

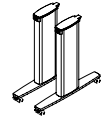

Tops are 1" Thick

	L" x D" x H"	Top Finish	Model Number	2 T-Bases	List Price	Model Number	2 T-Bases	List Price
RECTANGLE TABLES								
<p>"Shown Flipped Down"</p>	60 x 24 x 29	Wood	56410/2	(2-24")	4,890	56416/2	(2-24")	4,375
	60 x 24 x 29	P-Lam	56410/5	(2-24")	4,680	56416/5	(2-24")	4,170
	66 x 24 x 29	Wood	56411/2	(2-24")	4,990	56417/2	(2-24")	4,480
	66 x 24 x 29	P-Lam	56411/5	(2-24")	4,765	56417/5	(2-24")	4,255
	72 x 24 x 29	Wood	56412/2	(2-24")	5,115	56418/2	(2-24")	4,615
	72 x 24 x 29	P-Lam	56412/5	(2-24")	4,870	56418/5	(2-24")	4,365
	78 x 24 x 29	Wood	56413/2	(2-24")	5,215	56419/2	(2-24")	4,710
	78 x 24 x 29	P-Lam	56413/5	(2-24")	4,950	56419/5	(2-24")	4,445
	84 x 24 x 29	Wood	56414/2	(2-24")	5,315	56420/2	(2-24")	4,815
	84 x 24 x 29	P-Lam	56414/5	(2-24")	5,030	56420/5	(2-24")	4,525
<p>"Shown Flipped Up"</p>	90 x 24 x 29	Wood	56415/2	(2-24")	5,425	56421/2	(2-24")	4,905
	90 x 24 x 29	P-Lam	56415/5	(2-24")	5,110	56421/5	(2-24")	4,605
	60 x 30 x 29	Wood	56422/2	(2-26")	5,180	56428/2	(2-26")	4,665
	60 x 30 x 29	P-Lam	56422/5	(2-26")	4,905	56428/5	(2-26")	4,400
	66 x 30 x 29	Wood	56423/2	(2-26")	5,290	56429/2	(2-26")	4,775
	66 x 30 x 29	P-Lam	56423/5	(2-26")	5,010	56429/5	(2-26")	4,490
	72 x 30 x 29	Wood	56424/2	(2-26")	5,455	56430/2	(2-26")	4,945
	72 x 30 x 29	P-Lam	56424/5	(2-26")	5,150	56430/5	(2-26")	4,635
	78 x 30 x 29	Wood	56425/2	(2-26")	5,580	56431/2	(2-26")	5,070
	78 x 30 x 29	P-Lam	56425/5	(2-26")	5,250	56431/5	(2-26")	4,735
84 x 30 x 29	Wood	56426/2	(2-26")	5,685	56432/2	(2-26")	5,175	
84 x 30 x 29	P-Lam	56426/5	(2-26")	5,315	56432/5	(2-26")	4,815	
90 x 30 x 29	Wood	56427/2	(2-26")	5,775	56433/2	(2-26")	5,270	
90 x 30 x 29	P-Lam	56427/5	(2-26")	5,395	56433/5	(2-26")	4,890	
60 x 36 x 29	Wood	56434/2	(2-26")	5,460	56440/2	(2-26")	4,950	
60 x 36 x 29	P-Lam	56434/5	(2-26")	5,135	56440/5	(2-26")	4,630	
66 x 36 x 29	Wood	56435/2	(2-26")	5,590	56441/2	(2-26")	5,085	
66 x 36 x 29	P-Lam	56435/5	(2-26")	5,240	56441/5	(2-26")	4,725	
72 x 36 x 29	Wood	56436/2	(2-26")	5,790	56442/2	(2-26")	5,280	
72 x 36 x 29	P-Lam	56436/5	(2-26")	5,425	56442/5	(2-26")	4,905	
78 x 36 x 29	Wood	56437/2	(2-26")	5,940	56443/2	(2-26")	5,440	
78 x 36 x 29	P-Lam	56437/5	(2-26")	5,540	56443/5	(2-26")	5,030	
84 x 36 x 29	Wood	56438/2	(2-26")	6,045	56444/2	(2-26")	5,530	
84 x 36 x 29	P-Lam	56438/5	(2-26")	5,605	56444/5	(2-26")	5,095	
90 x 36 x 29	Wood	56439/2	(2-26")	6,130	56445/2	(2-26")	5,625	
90 x 36 x 29	P-Lam	56439/5	(2-26")	5,695	56445/5	(2-26")	5,180	
HALF-ROUND TABLES								
<p>"Shown Flipped Down"</p>	30 x 60 x 29	Wood	56161/2	(2-24")	5,180	56171/2	(2-24")	4,665
	30 x 60 x 29	P-Lam	56162/5	(2-24")	4,905	56172/5	(2-24")	4,400
<p>"Shown Flipped Up"</p>	36 x 72 x 29	Wood	56163/2	(2-26")	5,315	56173/2	(2-26")	4,815
	36 x 72 x 29	P-Lam	56164/5	(2-26")	5,030	56174/5	(2-26")	4,525

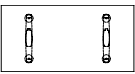

VOX® FLIPTOP™ MEETING TABLE

INSET LEGS WITH WOOD OR P-LAM MODESTY PANEL DESIGN - MARK MÜLLER

On this page:

Wood veneer tables are standard with a 1/8" solid wood edge that has a slight radius and a with wood veneer modesty panel that is self edged

P-lam tables are standard with a 1/8" translucent edging that has a slight radius and a plastic laminate modesty panel with translucent edging to match the top

Tops are 1" Thick

Mirror-polished

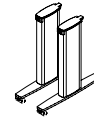

Anodized Finish

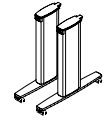

RECTANGLE TABLES		L" x D" x H"	Top Finish	Model Number	2 T-Bases	List Price	Model Number	2 T-Bases	List Price	
<p>"Shown Flipped Down"</p>	60	24	29	Wood	56410/2P	(2-24")	5,665	56416/2P	(2-24")	5,150
	60	24	29	P-Lam	56410/5P	(2-24")	5,380	56416/5P	(2-24")	4,870
	66	24	29	Wood	56411/2P	(2-24")	5,760	56417/2P	(2-24")	5,255
	66	24	29	P-Lam	56411/5P	(2-24")	5,475	56417/5P	(2-24")	4,970
	72	24	29	Wood	56412/2P	(2-24")	5,905	56418/2P	(2-24")	5,385
	72	24	29	P-Lam	56412/5P	(2-24")	5,590	56418/5P	(2-24")	5,085
	78	24	29	Wood	56413/2P	(2-24")	6,030	56419/2P	(2-24")	5,515
	78	24	29	P-Lam	56413/5P	(2-24")	5,685	56419/5P	(2-24")	5,175
	84	24	29	Wood	56414/2P	(2-24")	6,115	56420/2P	(2-24")	5,615
	84	24	29	P-Lam	56414/5P	(2-24")	5,760	56420/5P	(2-24")	5,255
	90	24	29	Wood	56415/2P	(2-24")	6,245	56421/2P	(2-24")	5,720
	90	24	29	P-Lam	56415/5P	(2-24")	5,860	56421/5P	(2-24")	5,345
<p>"Shown Flipped Up"</p>	60	30	29	Wood	56422/2P	(2-26")	5,935	56428/2P	(2-26")	5,435
	60	30	29	P-Lam	56422/5P	(2-26")	5,615	56428/5P	(2-26")	5,100
	66	30	29	Wood	56423/2P	(2-26")	6,075	56429/2P	(2-26")	5,550
	66	30	29	P-Lam	56423/5P	(2-26")	5,715	56429/5P	(2-26")	5,205
	72	30	29	Wood	56424/2P	(2-26")	6,250	56430/2P	(2-26")	5,725
	72	30	29	P-Lam	56424/5P	(2-26")	5,875	56430/5P	(2-26")	5,360
	78	30	29	Wood	56425/2P	(2-26")	6,370	56431/2P	(2-26")	5,880
	78	30	29	P-Lam	56425/5P	(2-26")	5,965	56431/5P	(2-26")	5,460
	84	30	29	Wood	56426/2P	(2-26")	6,480	56432/2P	(2-26")	5,965
	84	30	29	P-Lam	56426/5P	(2-26")	6,060	56432/5P	(2-26")	5,540
	90	30	29	Wood	56427/2P	(2-26")	6,605	56433/2P	(2-26")	6,085
	90	30	29	P-Lam	56427/5P	(2-26")	6,130	56433/5P	(2-26")	5,625
60	36	29	Wood	56434/2P	(2-26")	6,245	56440/2P	(2-26")	5,720	
60	36	29	P-Lam	56434/5P	(2-26")	5,855	56440/5P	(2-26")	5,340	
66	36	29	Wood	56435/2P	(2-26")	6,350	56441/2P	(2-26")	5,865	
66	36	29	P-Lam	56435/5P	(2-26")	5,940	56441/5P	(2-26")	5,440	
72	36	29	Wood	56436/2P	(2-26")	6,565	56442/2P	(2-26")	6,075	
72	36	29	P-Lam	56436/5P	(2-26")	6,130	56442/5P	(2-26")	5,625	
78	36	29	Wood	56437/2P	(2-26")	6,740	56443/2P	(2-26")	6,250	
78	36	29	P-Lam	56437/5P	(2-26")	6,270	56443/5P	(2-26")	5,750	
84	36	29	Wood	56438/2P	(2-26")	6,840	56444/2P	(2-26")	6,325	
84	36	29	P-Lam	56438/5P	(2-26")	6,330	56444/5P	(2-26")	5,835	
90	36	29	Wood	56439/2P	(2-26")	6,945	56445/2P	(2-26")	6,445	
90	36	29	P-Lam	56439/5P	(2-26")	6,435	56445/5P	(2-26")	5,915	

VOX® FLIPTOP™ MEETING TABLE

INSET LEGS WITH ALUMINUM MODESTY PANEL DESIGN – MARK MÜLLER

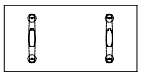

On this page

Wood veneer tables are standard with a 1/8" solid wood edge that has a slight radius and an aluminum modesty panel with grey plastic edging

P-lam tables are standard with a 1/8" translucent edging that has a slight radius and an aluminum modesty panel with grey plastic edging

Tops are 1" Thick

Mirror-polished

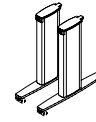

Anodized Finish

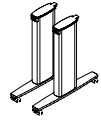

	L"	x	D"	x	H"	Top Finish	Model Number	2 T-Bases	List Price	Model Number	2 T-Bases	List Price
RECTANGLE TABLES	60	24	29	Wood	56410/2AP	(2-24")	5,700	56416/2AP	(2-24")	5,185		
	60	24	29	P-Lam	56410/5AP	(2-24")	5,425	56416/5AP	(2-24")	4,905		
	66	24	29	Wood	56411/2AP	(2-24")	5,795	56417/2AP	(2-24")	5,290		
	66	24	29	P-Lam	56411/5AP	(2-24")	5,520	56417/5AP	(2-24")	5,010		
	72	24	29	Wood	56412/2AP	(2-24")	5,930	56418/2AP	(2-24")	5,430		
	72	24	29	P-Lam	56412/5AP	(2-24")	5,625	56418/5AP	(2-24")	5,115		
	78	24	29	Wood	56413/2AP	(2-24")	6,060	56419/2AP	(2-24")	5,540		
	78	24	29	P-Lam	56413/5AP	(2-24")	5,715	56419/5AP	(2-24")	5,205		
	84	24	29	Wood	56414/2AP	(2-24")	6,150	56420/2AP	(2-24")	5,645		
	84	24	29	P-Lam	56414/5AP	(2-24")	5,795	56420/5AP	(2-24")	5,290		
	90	24	29	Wood	56415/2AP	(2-24")	6,270	56421/2AP	(2-24")	5,750		
	90	24	29	P-Lam	56415/5AP	(2-24")	5,890	56421/5AP	(2-24")	5,375		
	60	30	29	Wood	56422/2AP	(2-26")	5,975	56428/2AP	(2-26")	5,465		
	60	30	29	P-Lam	56422/5AP	(2-26")	5,645	56428/5AP	(2-26")	5,135		
	66	30	29	Wood	56423/2AP	(2-26")	6,100	56429/2AP	(2-26")	5,590		
	66	30	29	P-Lam	56423/5AP	(2-26")	5,745	56429/5AP	(2-26")	5,240		
	72	30	29	Wood	56424/2AP	(2-26")	6,275	56430/2AP	(2-26")	5,760		
	72	30	29	P-Lam	56424/5AP	(2-26")	5,905	56430/5AP	(2-26")	5,385		
	78	30	29	Wood	56425/2AP	(2-26")	6,430	56431/2AP	(2-26")	5,910		
	78	30	29	P-Lam	56425/5AP	(2-26")	6,015	56431/5AP	(2-26")	5,505		
	84	30	29	Wood	56426/2AP	(2-26")	6,510	56432/2AP	(2-26")	6,015		
	84	30	29	P-Lam	56426/5AP	(2-26")	6,090	56432/5AP	(2-26")	5,575		
	90	30	29	Wood	56427/2AP	(2-26")	6,630	56433/2AP	(2-26")	6,110		
	90	30	29	P-Lam	56427/5AP	(2-26")	6,165	56433/5AP	(2-26")	5,675		
	60	36	29	Wood	56434/2AP	(2-26")	6,270	56440/2AP	(2-26")	5,750		
	60	36	29	P-Lam	56434/5AP	(2-26")	5,885	56440/5AP	(2-26")	5,370		
	66	36	29	Wood	56435/2AP	(2-26")	6,420	56441/2AP	(2-26")	5,895		
	66	36	29	P-Lam	56435/5AP	(2-26")	5,985	56441/5AP	(2-26")	5,475		
	72	36	29	Wood	56436/2AP	(2-26")	6,620	56442/2AP	(2-26")	6,100		
	72	36	29	P-Lam	56436/5AP	(2-26")	6,165	56442/5AP	(2-26")	5,675		
	78	36	29	Wood	56437/2AP	(2-26")	6,785	56443/2AP	(2-26")	6,275		
	78	36	29	P-Lam	56437/5AP	(2-26")	6,295	56443/5AP	(2-26")	5,790		
	84	36	29	Wood	56438/2AP	(2-26")	6,880	56444/2AP	(2-26")	6,350		
	84	36	29	P-Lam	56438/5AP	(2-26")	6,360	56444/5AP	(2-26")	5,875		
	90	36	29	Wood	56439/2AP	(2-26")	6,990	56445/2AP	(2-26")	6,475		
	90	36	29	P-Lam	56439/5AP	(2-26")	6,460	56445/5AP	(2-26")	5,940		

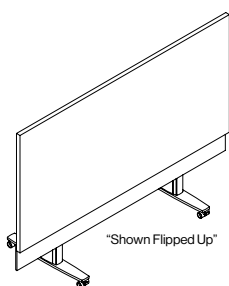
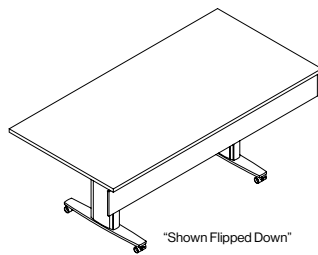

VOX® MEETING ROOM LAYOUTS

INSET LEGS DRAWINGS NOT TO SCALE

ROOM1-LAYOUT C1

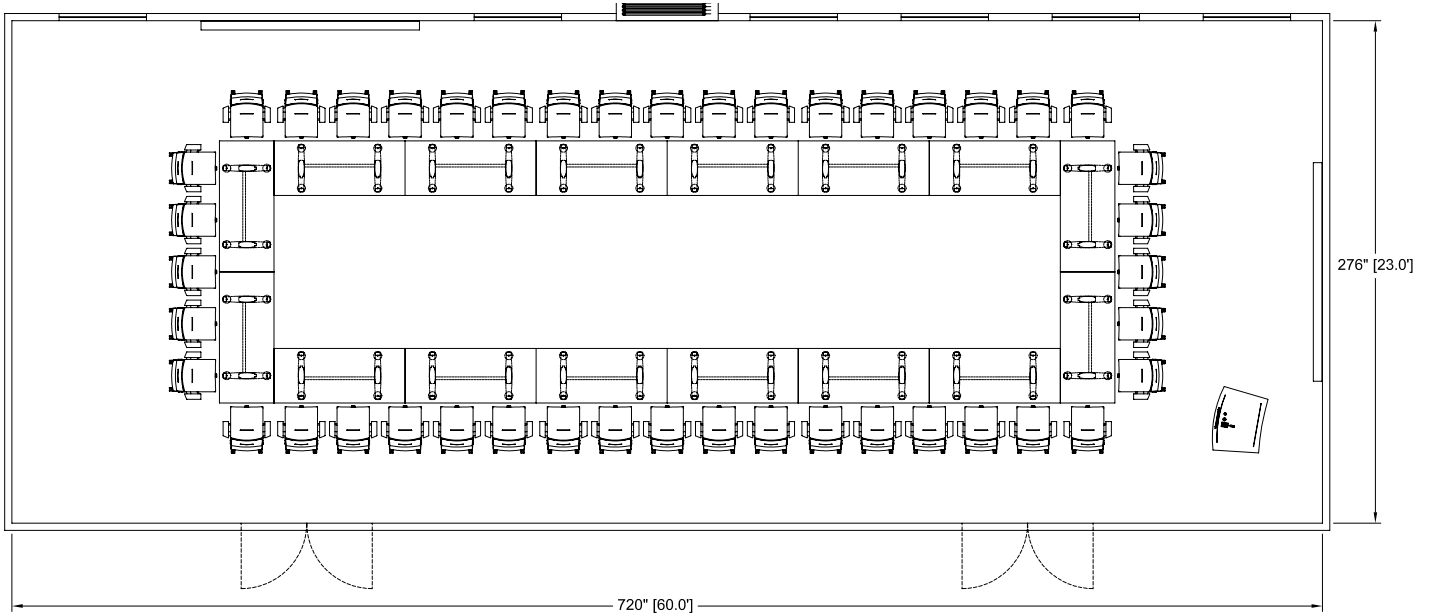

ROOM1-LAYOUT C2

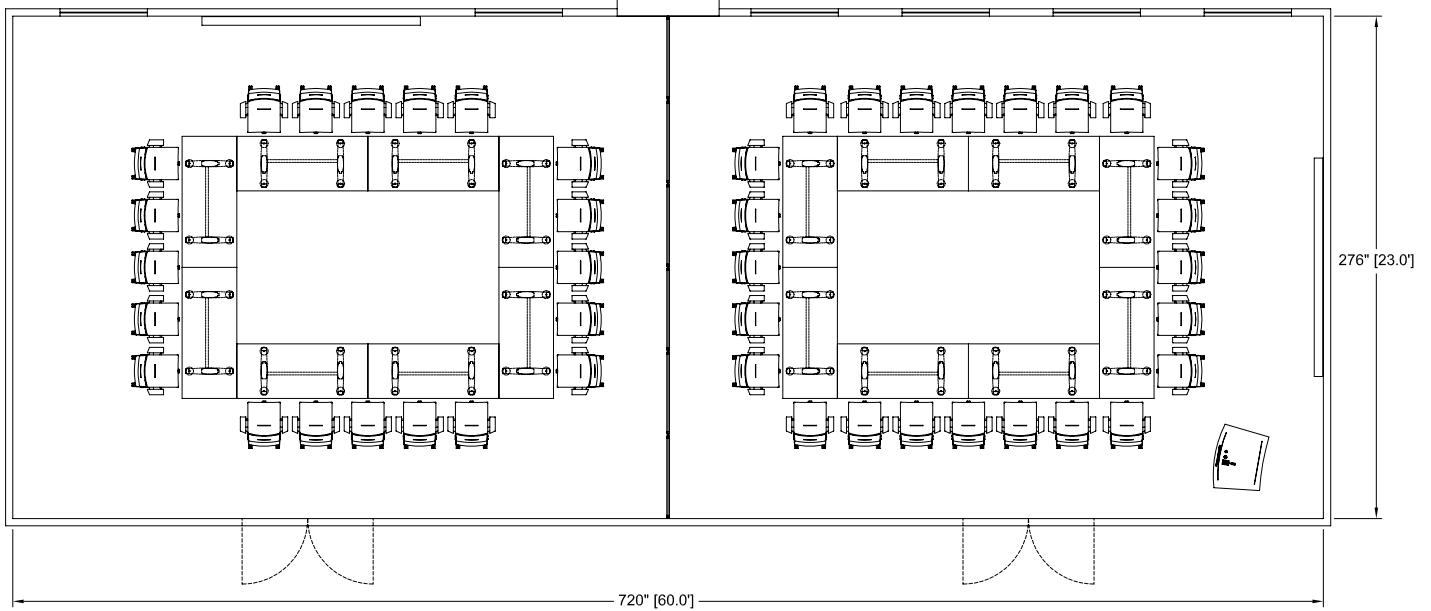

Product Name	Model Number	List Price
16-Vox® FlipTop™ 72" x 30" tables	56430/2	79,030
1-Vox® Presenter's Lectern	23465	9,980
2-120" Vox® Presentation Walls	23494/2	17,315
44-NOW® Conference Chairs, with casters	13022	96,165
Total		202,490

VOX® MEETING ROOM LAYOUTS

INSET LEGS DRAWINGS NOT TO SCALE

ROOM1-LAYOUT C3

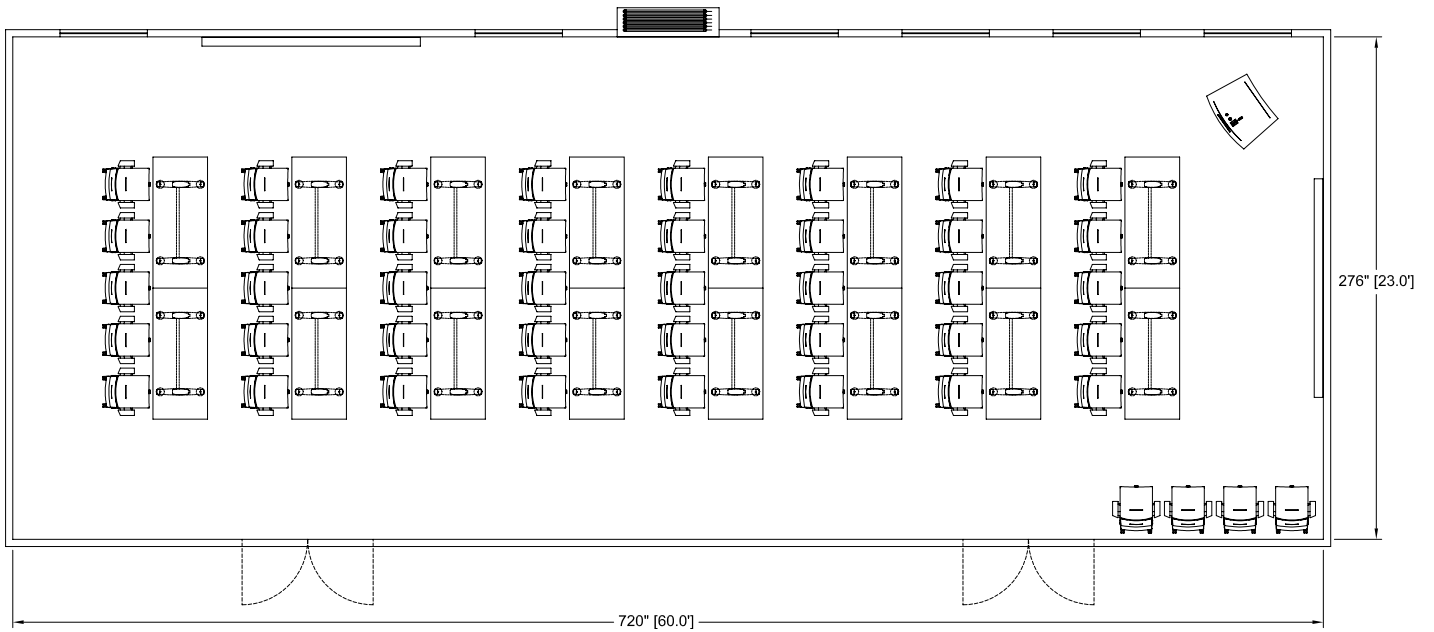

ROOM1-LAYOUT C4

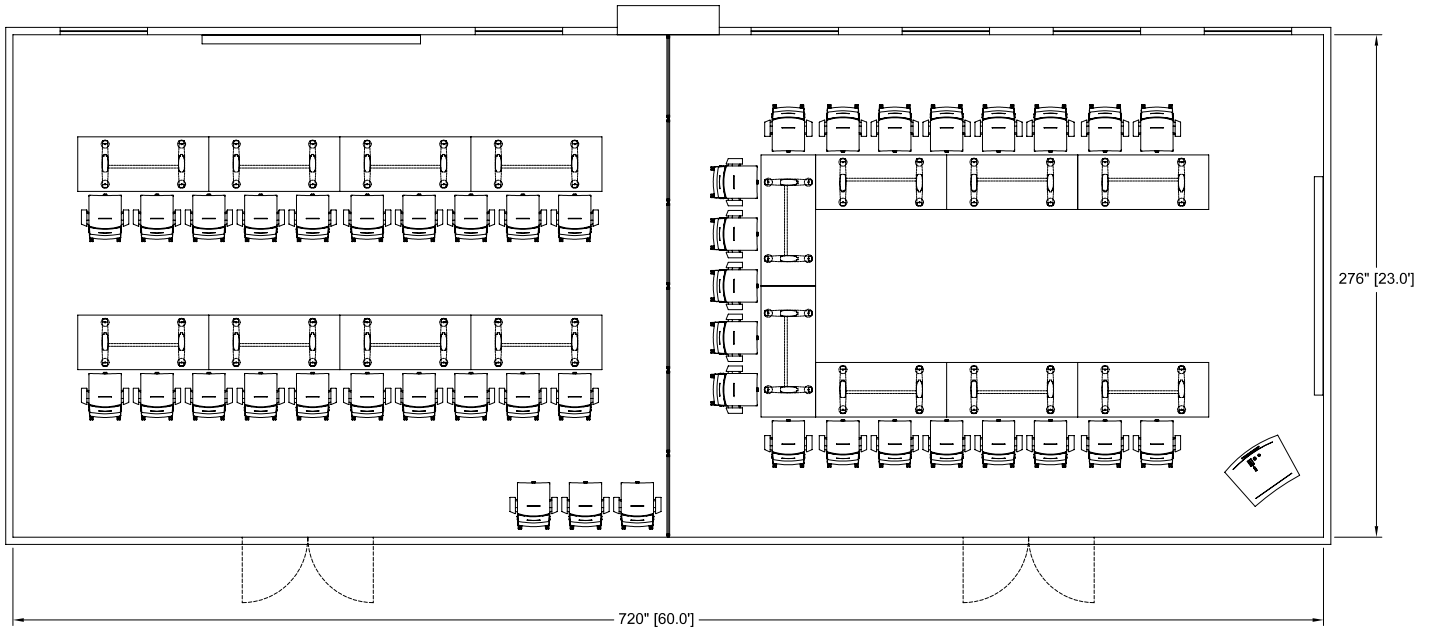

Product Name	Model Number	List Price
16-Vox® FlipTop™ 72" x 30" tables	56430/2	79,030
1-Vox® Presenter's Lectern	23465	9,980
2-120" Vox® Presentation Walls	23494/2	17,315
44-NOW® Conference Chairs, with casters	13022	96,165
Total		202,490

VOX® MEETING ROOM LAYOUTS

INSET LEGS DRAWINGS NOT TO SCALE

ROOM2-LAYOUT D1

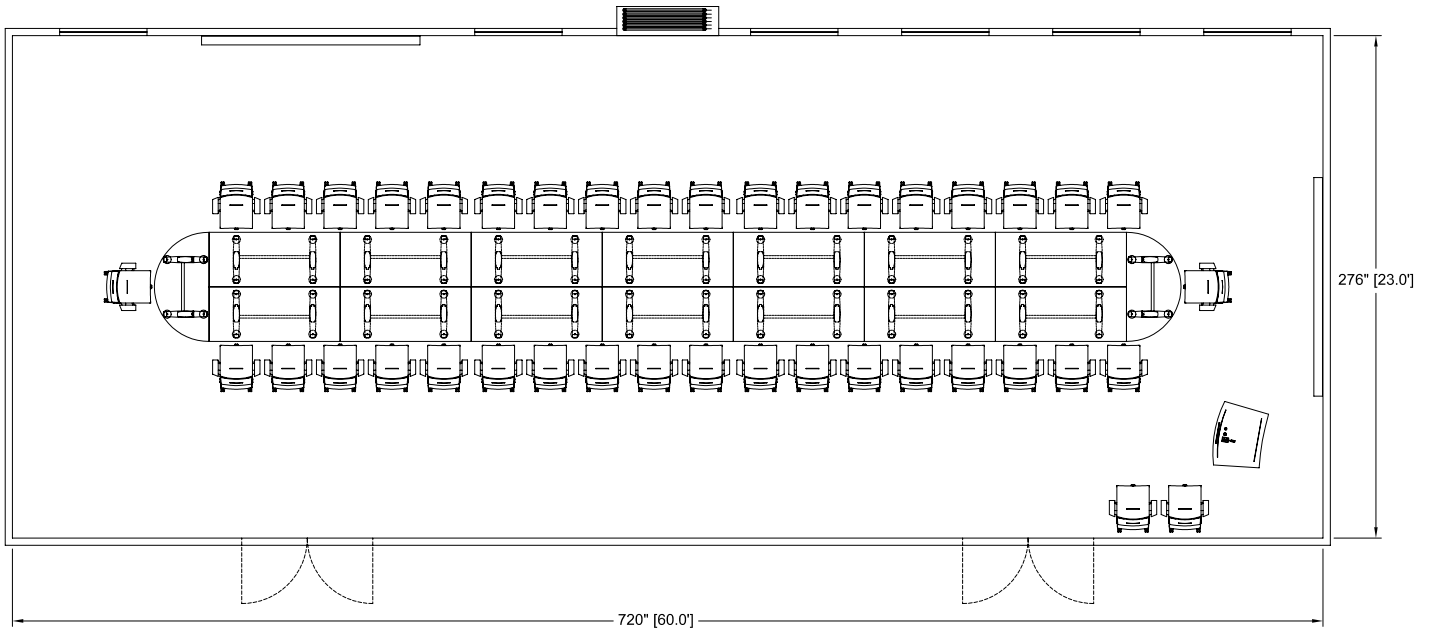

ROOM2-LAYOUT D2

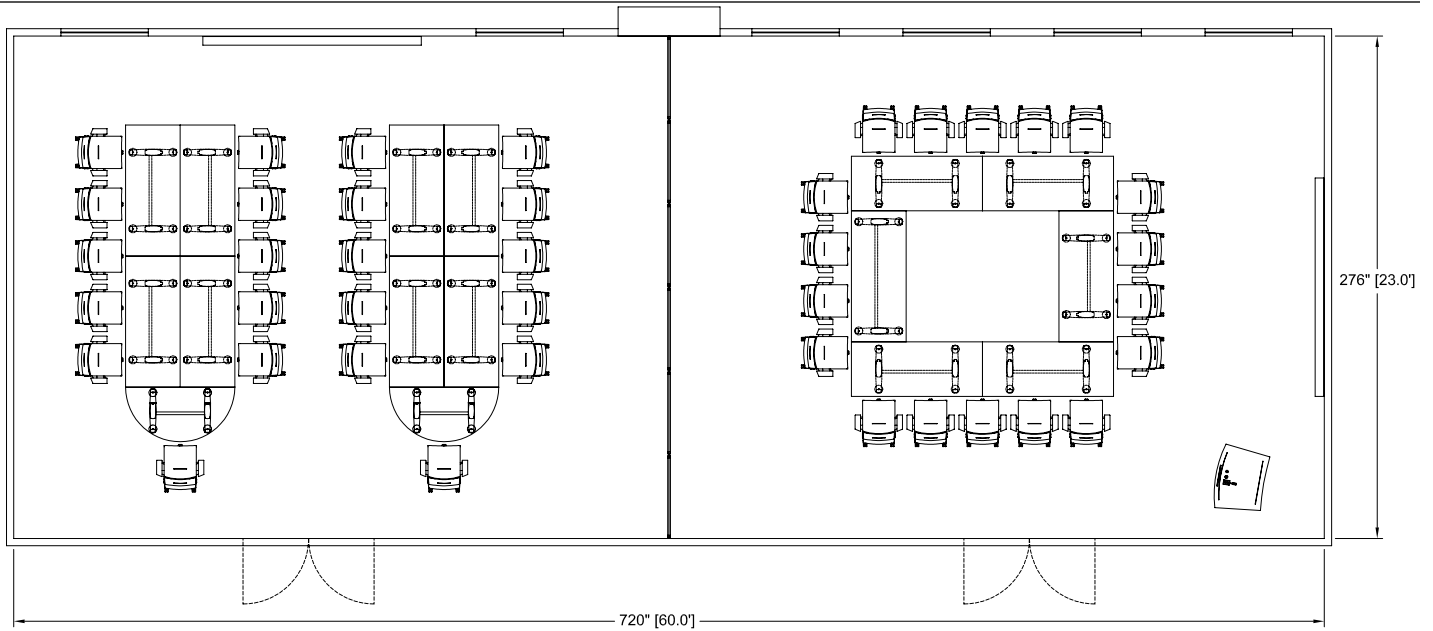

Product Name	Model Number	List Price
14-Vox® FlipTop™ 72" x 30" tables	56430/2	69,155
2-Vox® FlipTop™ Half Round 60" x 30" tables	56171/2	9,320
1-Vox® Presenter's Lectern	23465	9,980
2-120" Vox® Presentation Walls	23494/2	17,315
40-NOW® Conference Chairs, with casters	13022	87,425
Total		193,195

VOX[®] FLIPTOP[™] CONFERENCE TABLES

VOX®FLIPTOP™ CONFERENCE TABLES

EDGE DETAILS DESIGN - MARK MÜLLER

All Vox®FlipTop™ conference tables are available with three edge profiles on user side, to select:

Facet Edge add "FC" after the table model number

Taper Edge add "TE" after the table model number

Flowform Edge add "FF" after the table model number

Flowform Edge is a 5% upcharge

Flowform tops are not available with plastic laminate

- All other edges of the top are Self Edged.
- All Vox®FlipTop™ conference table tops are 1/4" thick, edges are manufactured with a solid wood edge that is profiled and then veneer wrapped.

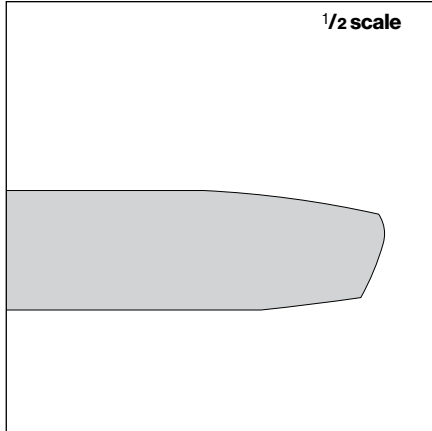
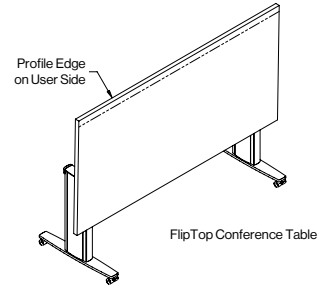

Facet Edge "FC"

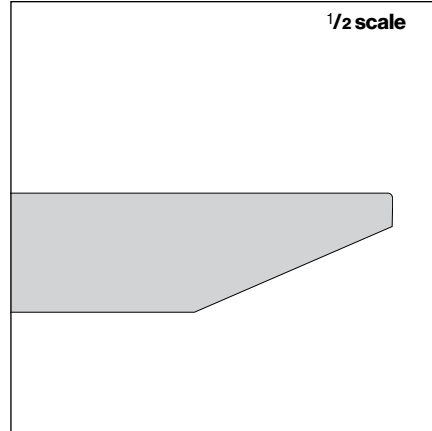

Taper Edge "TE"

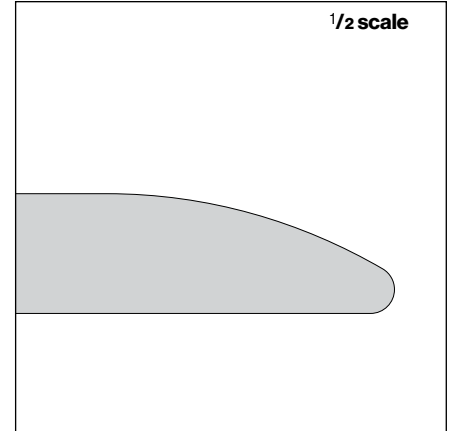

Flowform Edge "FF"

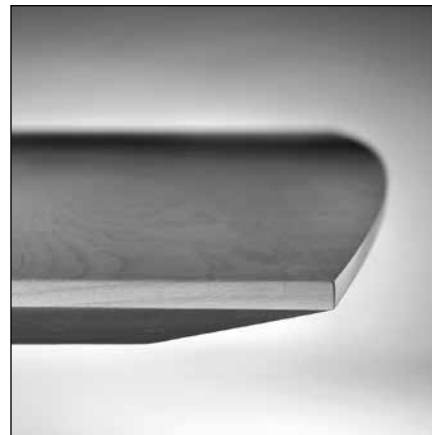

Vox® Infill FlipTop™ tables can be specified with Pre-wired "S-Series" Forums in a range of configurations. A rail joining the two table legs acts as a stabilizer for the table and along with wire management clips provide a convenient place to store cables. For complete Vox®Forum™ details refer to the 2007 Vox®Conference™ Price List or simply download the information at: www.nienkamper.com/downloads/Price%20List/US_VoxForums.pdf

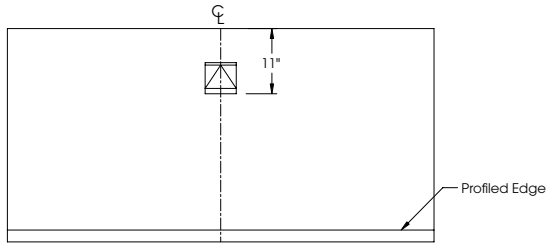

Rectangular Shape

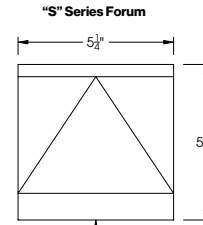

Models A,B,C,G and H

"S" Series Vox® Forums

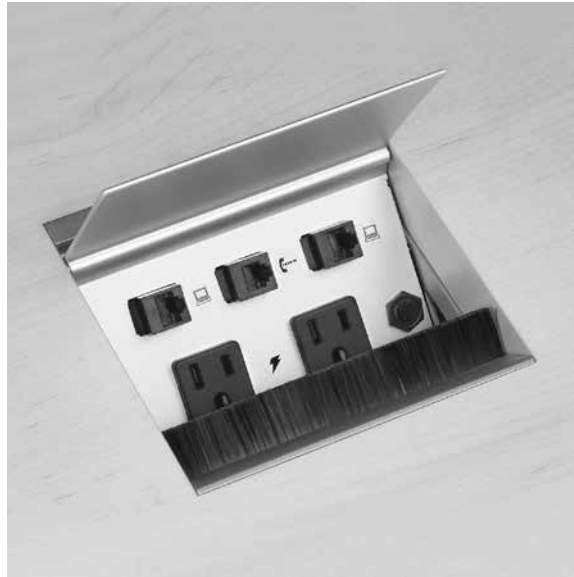

The "S-Series"Forum is available in 2 sizes: 5 1/4" W or 12" W. Fourteen models from A to I with eight data configurations to satisfy most requirements.

VOX® INFILL FLIPTOP™ TABLES

USED WITH CONFERENCE TABLES (PGS 34 – 35) DESIGN – MARK MÜLLER



Specify edge type; add the two letter code after the model number.

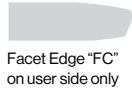

Facet Edge "FC"
on user side only

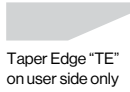

Taper Edge "TE"
on user side only



Flowform Edge "FF"
on user side only
5% upcharge
laminare not available

Mirror-polished

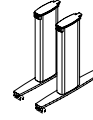

Anodized Finish

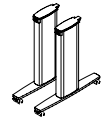

Tops are 1 1/4" Thick

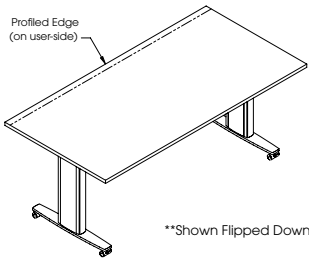

Shown Flipped Down

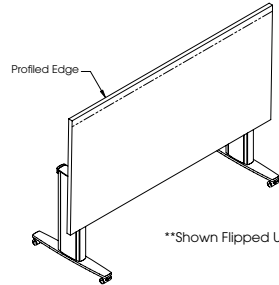

Shown Flipped Up

	L" x D" x H"	Top Finish	Model Number	2 T-Bases	List Price	Model Number	2 T-Bases	List Price
	60 x 24 x 28 1/2	Wood	56201/2	(2-24")	4,890	56211/2	(2-24")	4,375
	60 x 24 x 28 1/2	P-Lam	56202/5	(2-24")	4,680	56212/5	(2-24")	4,170
	66 x 24 x 28 1/2	Wood	56203/2	(2-24")	4,990	56213/2	(2-24")	4,480
	66 x 24 x 28 1/2	P-Lam	56204/5	(2-24")	4,765	56214/5	(2-24")	4,255
	72 x 24 x 28 1/2	Wood	56205/2	(2-24")	4,915	56215/2	(2-24")	4,615
	72 x 24 x 28 1/2	P-Lam	56206/5	(2-24")	4,870	56216/5	(2-24")	4,365
	78 x 24 x 28 1/2	Wood	56207/2	(2-24")	5,215	56217/2	(2-24")	4,710
	78 x 24 x 28 1/2	P-Lam	56208/5	(2-24")	4,950	56218/5	(2-24")	4,445
	84 x 24 x 28 1/2	Wood	56209/2	(2-24")	5,315	56219/2	(2-24")	4,815
	84 x 24 x 28 1/2	P-Lam	56210/5	(2-24")	5,030	56220/5	(2-24")	4,525
	60 x 27 x 28 1/2	Wood	56221/2	(2-24")	5,030	56231/2	(2-24")	4,525
	60 x 27 x 28 1/2	P-Lam	56222/5	(2-24")	4,800	56232/5	(2-24")	4,285
	66 x 27 x 28 1/2	Wood	56223/2	(2-24")	5,135	56233/2	(2-24")	4,630
	66 x 27 x 28 1/2	P-Lam	56224/5	(2-24")	4,880	56234/5	(2-24")	4,370
	72 x 27 x 28 1/2	Wood	56225/2	(2-24")	5,280	56235/2	(2-24")	4,770
	72 x 27 x 28 1/2	P-Lam	56226/5	(2-24")	5,015	56236/5	(2-24")	4,495
	78 x 27 x 28 1/2	Wood	56227/2	(2-24")	5,395	56237/2	(2-24")	4,890
	78 x 27 x 28 1/2	P-Lam	56228/5	(2-24")	5,095	56238/5	(2-24")	4,580
	84 x 27 x 28 1/2	Wood	56229/2	(2-24")	5,505	56239/2	(2-24")	4,990
	84 x 27 x 28 1/2	P-Lam	56230/5	(2-24")	5,180	56240/5	(2-24")	4,665
	60 x 30 x 28 1/2	Wood	56241/2	(2-26")	5,180	56251/2	(2-26")	4,665
	60 x 30 x 28 1/2	P-Lam	56242/5	(2-26")	4,905	56252/5	(2-26")	4,400
	66 x 30 x 28 1/2	Wood	56243/2	(2-26")	5,290	56253/2	(2-26")	4,775
	66 x 30 x 28 1/2	P-Lam	56244/5	(2-26")	5,010	56254/5	(2-26")	4,490
	72 x 30 x 28 1/2	Wood	56245/2	(2-26")	5,455	56255/2	(2-26")	4,945
	72 x 30 x 28 1/2	P-Lam	56246/5	(2-26")	5,150	56256/5	(2-26")	4,635
	78 x 30 x 28 1/2	Wood	56247/2	(2-26")	5,580	56257/2	(2-26")	5,070
	78 x 30 x 28 1/2	P-Lam	56248/5	(2-26")	5,250	56258/5	(2-26")	4,735
	84 x 30 x 28 1/2	Wood	56249/2	(2-26")	5,685	56259/2	(2-26")	5,175
	84 x 30 x 28 1/2	P-Lam	56250/5	(2-26")	5,315	56260/5	(2-26")	4,815
	60 x 33 x 28 1/2	Wood	56261/2	(2-26")	5,315	56271/2	(2-26")	4,815
	60 x 33 x 28 1/2	P-Lam	56262/5	(2-26")	5,025	56272/5	(2-26")	4,510
	66 x 33 x 28 1/2	Wood	56263/2	(2-26")	5,440	56273/2	(2-26")	4,930
	66 x 33 x 28 1/2	P-Lam	56264/5	(2-26")	5,115	56274/5	(2-26")	4,615
	72 x 33 x 28 1/2	Wood	56265/2	(2-26")	5,620	56275/2	(2-26")	5,110
	72 x 33 x 28 1/2	P-Lam	56266/5	(2-26")	5,280	56276/5	(2-26")	4,880
	78 x 33 x 28 1/2	Wood	56267/2	(2-26")	5,760	56277/2	(2-26")	5,255
	78 x 33 x 28 1/2	P-Lam	56268/5	(2-26")	5,385	56278/5	(2-26")	4,880
	84 x 33 x 28 1/2	Wood	56269/2	(2-26")	5,865	56279/2	(2-26")	5,355
	84 x 33 x 28 1/2	P-Lam	56270/5	(2-26")	5,460	56280/5	(2-26")	4,950
	60 x 36 x 28 1/2	Wood	56281/2	(2-26")	5,460	56291/2	(2-26")	4,950
	60 x 36 x 28 1/2	P-Lam	56282/5	(2-26")	5,135	56292/5	(2-26")	4,630
	66 x 36 x 28 1/2	Wood	56283/2	(2-26")	5,590	56293/2	(2-26")	5,085
	66 x 36 x 28 1/2	P-Lam	56284/5	(2-26")	5,240	56294/5	(2-26")	4,725
	72 x 36 x 28 1/2	Wood	56285/2	(2-26")	5,790	56295/2	(2-26")	5,280
	72 x 36 x 28 1/2	P-Lam	56286/5	(2-26")	5,425	56296/5	(2-26")	4,905
	78 x 36 x 28 1/2	Wood	56287/2	(2-26")	5,940	56297/2	(2-26")	5,440
	78 x 36 x 28 1/2	P-Lam	56288/5	(2-26")	5,540	56298/5	(2-26")	5,030
	84 x 36 x 28 1/2	Wood	56289/2	(2-26")	6,045	56299/2	(2-26")	5,530
	84 x 36 x 28 1/2	P-Lam	56290/5	(2-26")	5,605	56300/5	(2-26")	5,095



Specify edge type; add the two letter code after the model number.

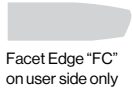

Facet Edge "FC" on user side only

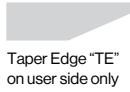

Taper Edge "TE" on user side only



Flowform Edge "FF" on user side only
5% upcharge
laminates not available

Tops are 1/4" Thick

* Based on a chair width of 25".

Mirror-polished

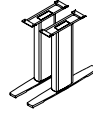

Anodized Finish

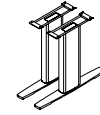

L" x D"	Sugg Seat Capacity*	Top Finish	Top Sections	Model Number	2 T-Bases	List Price	Model Number	2 T-Bases	List Price
96 x 48	6 - 8	Wood	1	56301/2	(2-28")	8,955	56341/2	(2-28")	7,400
96 x 48	6 - 8	P-Lam	1	56302/5	(2-28")	7,650	56342/5	(2-28")	6,095
108 x 48	8 - 10	Wood	1	56303/2	(2-28")	9,630	56343/2	(2-28")	8,085
108 x 48	8 - 10	P-Lam	1	56304/5	(2-28")	8,160	56344/5	(2-28")	6,625
120 x 48	8 - 10	Wood	2	56305/2	(2-28")	11,085	56345/2	(2-28")	9,535
120 x 48	8 - 10	P-Lam	2	56306/5	(2-28")	9,460	56346/5	(2-28")	7,910
120 x 54	8 - 10	Wood	2	56307/2	(2-30")	12,360	56347/2	(2-30")	10,710
132 x 48	8 - 10	Wood	2	56308/2	(2-28")	12,015	56348/2	(2-28")	10,485
132 x 54	8 - 10	Wood	2	56309/2	(2-30")	13,290	56349/2	(2-30")	11,655

These models are constructed without support rails – bases are attached directly to tops.

Mirror-polished

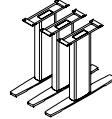

Anodized Finish

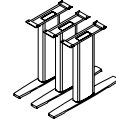

Tops are 1/4" Thick

* Based on a chair width of 25".

L" x D"	Sugg Seat Capacity*	Top Finish	Top Sections	Model Number	3 T-Bases	List Price	Model Number	3 T-Bases	List Price
144 x 48	10 - 12	Wood	2	56310/2	(3-28")	14,555	56350/2	(3-28")	12,240
144 x 54	10 - 12	Wood	2	56311/2	(3-30")	16,125	56351/2	(3-30")	13,640
144 x 60	10 - 12	Wood	2	56312/2	(3-32")	17,235	56352/2	(3-32")	14,735
156 x 48	10 - 12	Wood	2	56313/2	(3-28")	15,475	56353/2	(3-28")	13,150
156 x 54	12 - 14	Wood	2	56314/2	(3-30")	17,135	56354/2	(3-30")	14,655
156 x 60	12 - 14	Wood	2	56315/2	(3-32")	18,385	56355/2	(3-32")	15,880
156 x 66	12 - 14	Wood	2	56316/2	(3-34")	19,690	56356/2	(3-34")	17,075
168 x 48	12 - 14	Wood	2	56317/2	(3-28")	17,105	56357/2	(3-28")	14,780
168 x 54	12 - 14	Wood	2	56318/2	(3-30")	18,890	56358/2	(3-30")	16,410
168 x 60	12 - 14	Wood	2	56319/2	(3-32")	20,245	56359/2	(3-32")	17,750
168 x 66	12 - 14	Wood	2	56320/2	(3-34")	21,690	56360/2	(3-34")	19,050
180 x 48	12 - 14	Wood	3	56321/2	(3-28")	17,835	56361/2	(3-28")	15,505
180 x 60	14 - 16	Wood	3	56322/2	(3-32")	21,160	56362/2	(3-32")	18,655
180 x 66	14 - 16	Wood	3	56323/2	(3-34")	22,685	56363/2	(3-34")	20,055
180 x 72	14 - 16	Wood	3	56324/2	(3-36")	24,730	56364/2	(3-36")	21,810

TABLE DIMENSIONING LAYOUT

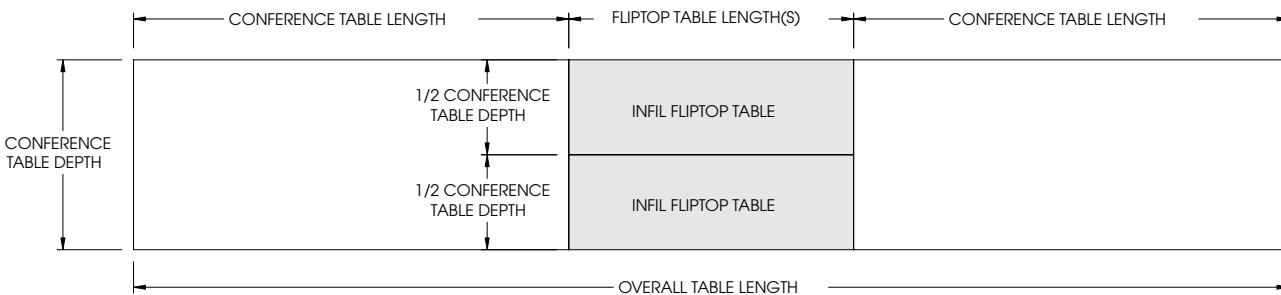

VOX® CONFERENCE TABLES

USED WITH INFILL FLIPTOP™ TABLES (PGS 33) DESIGN - MARK MÜLLER



Specify edge type; add the two letter code after the model number.

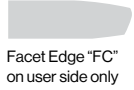

Facet Edge "FC"
on user side only

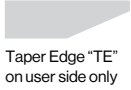

Taper Edge "TE"
on user side only



Flowform Edge "FF"
on user side only
5% upcharge
laminates not available

Mirror-polished

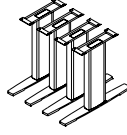

Anodized Finish

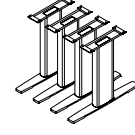

Tops are 1/4" Thick

* Based on a chair width of 25".

L" x D"	Sugg Seat Capacity*	Top Finish	Top Sections	Model Number	4 T-Bases	List Price	Model Number	4 T-Bases	List Price
192 x 54	14 - 16	Wood	4	56325/2	(3-30")	22,960	56365/2	(3-30")	19,645
192 x 60	14 - 16	Wood	4	56326/2	(3-32")	24,590	56366/2	(3-32")	21,240
192 x 66	14 - 16	Wood	4	56327/2	(3-34")	26,315	56367/2	(3-34")	22,800
192 x 72	14 - 16	Wood	4	56328/2	(3-36")	28,705	56368/2	(3-36")	24,820
204 x 54	14 - 16	Wood	4	56329/2	(4-30")	23,800	56369/2	(4-30")	20,480
204 x 60	16 - 18	Wood	4	56330/2	(4-32")	25,530	56370/2	(4-32")	22,180
204 x 66	16 - 18	Wood	4	56331/2	(4-34")	27,345	56371/2	(4-34")	23,840
204 x 72	16 - 18	Wood	4	56332/2	(4-36")	29,825	56372/2	(4-36")	25,935
216 x 54	16 - 18	Wood	4	56333/2	(4-30")	25,265	56373/2	(4-30")	21,955
216 x 60	16 - 18	Wood	4	56334/2	(4-32")	27,130	56374/2	(4-32")	23,790
216 x 66	16 - 18	Wood	4	56335/2	(4-34")	29,090	56375/2	(4-34")	25,600
216 x 72	16 - 18	Wood	4	56336/2	(4-36")	31,740	56376/2	(4-36")	27,830
228 x 54	16 - 18	Wood	4	56337/2	(4-30")	26,310	56377/2	(4-30")	22,995
228 x 60	16 - 18	Wood	4	56338/2	(4-32")	28,290	56378/2	(4-32")	24,955
228 x 66	18 - 20	Wood	4	56339/2	(4-34")	30,975	56379/2	(4-34")	27,495
228 x 72	18 - 20	Wood	4	56340/2	(4-36")	33,120	56380/2	(4-36")	29,235

EDGE PROFILING

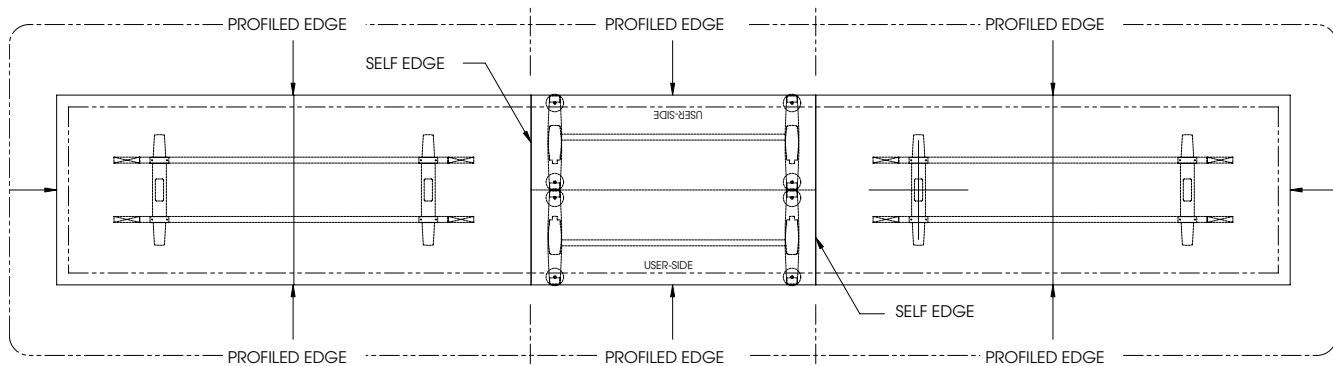

VOX® CONFERENCE ROOM LAYOUTS

DRAWINGS NOT TO SCALE

ROOM 3 – LAYOUT A1: LARGE BOARDROOM INTEGRATION

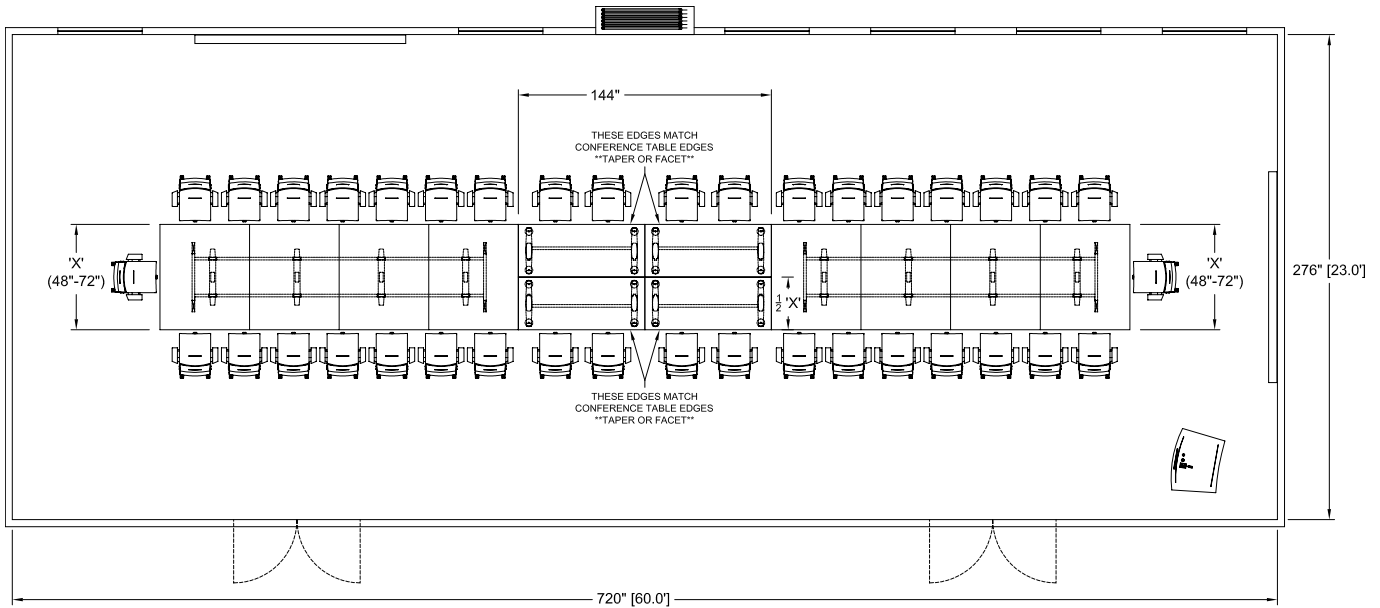

ROOM 3 – LAYOUT A2

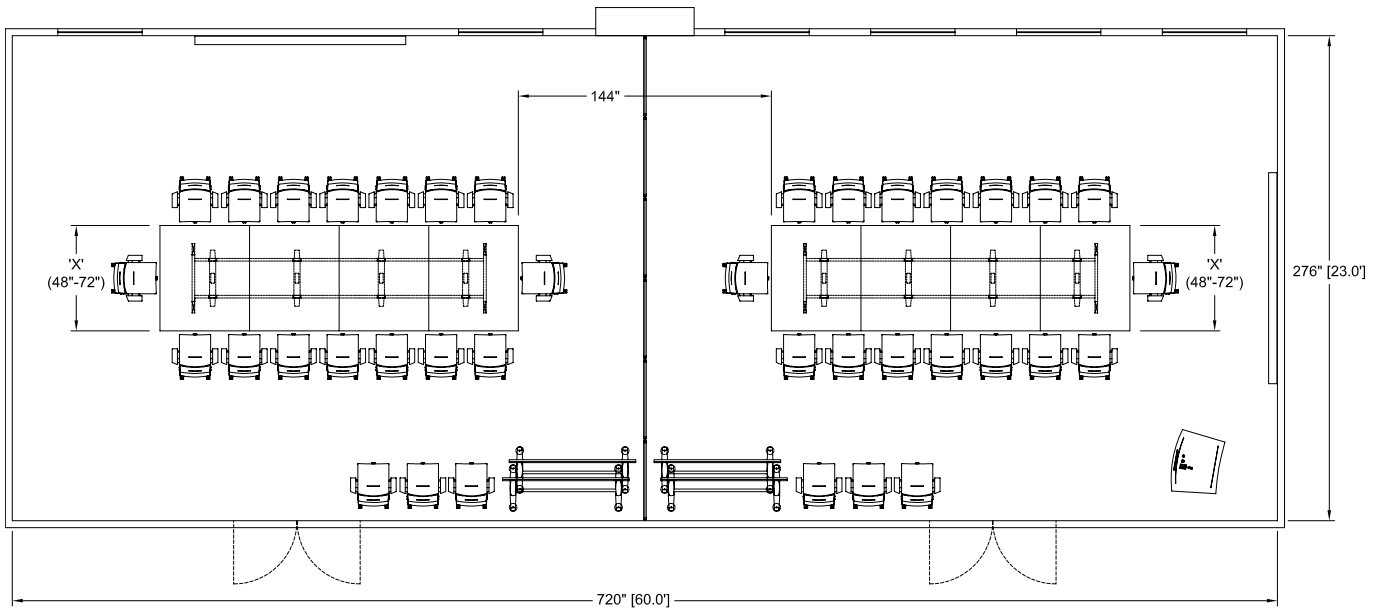

Product Name	Model Number	List Price
4-Vox® FlipTop™ 72" x 30" tables	56255/2	19,765
2-Vox® Rectangle Shape Conference tables, 204" x 60", with T-Bases	56370/2	44,350
1-Vox® Presenter's Lectern	23465	9,980
2-120" Vox® Presentation Walls	23494/2	17,315
38-NOW® Conference Chairs, with casters	13022	83,050
Total		174,460

ROOM 4 – LAYOUT B1: SMALL BOARDROOM INTEGRATION

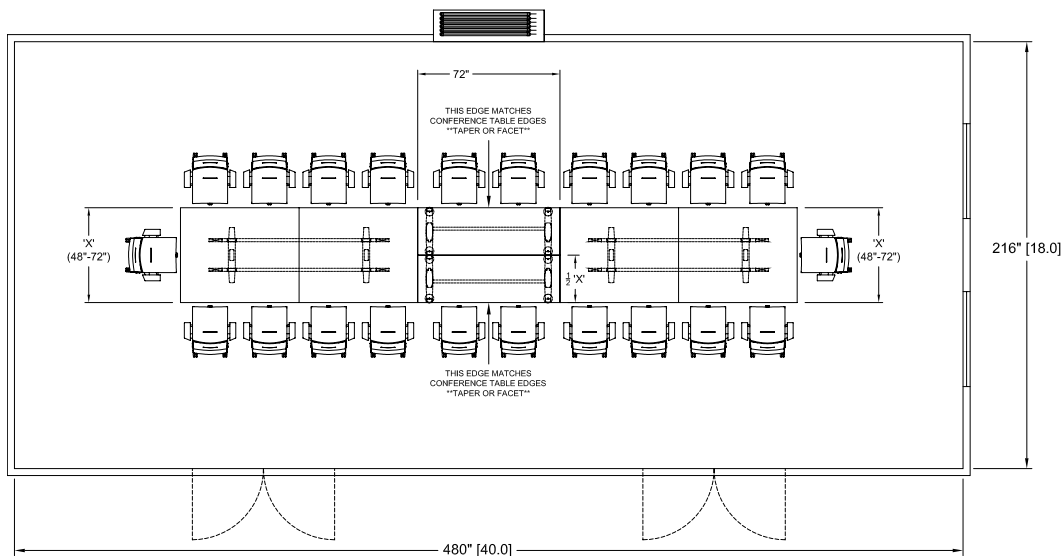

ROOM 4 – LAYOUT B2

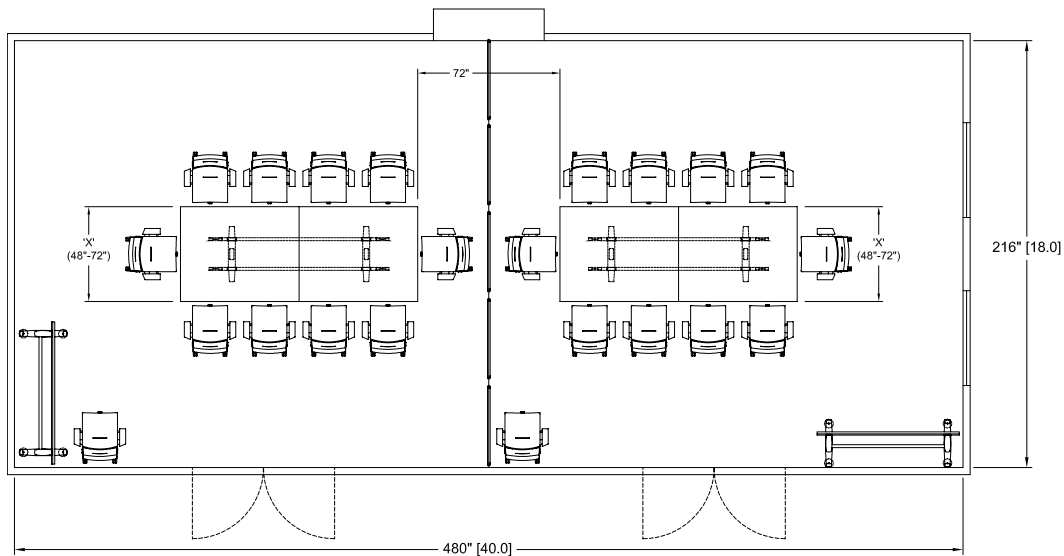

Product Name	Model Number	List Price
2-Vox®FlipTop™ 72" x 24" tables	56215/2	9,220
2-Vox® Rectangle Shape Conference tables, 120" x 48", with T-Bases	56345/2	19,065
22-NOW® Conference Chairs, with casters	13022	48,085
Total		76,370

TERMS AND CONDITIONS OF SALE

PRICES

All prices are list prices, freight included, blanket-wrapped, dock delivered, from the manufacturing source to any location in the contiguous United States.

Brokerage is paid by Nienkämper for product shipped to the United States.

Due to existing conditions in regard to cost of labor and materials, we reserve the right to change prices without notice.

TERMS

Net 30 days from date of invoice to accredited buyers. Two per cent (2%) interest charged monthly on overdue accounts. Deposit of 50% is required with order. Terms will be established upon credit evaluation. Due to delays in processing references, first orders may be treated as C.B.D. orders.

ORDER CONFIRMATION

Orders are accepted upon issuance of our order confirmation and are subject to the terms set forth therein; notwithstanding any variance from the terms of the buyer's order form.

Nienkämper is not liable for any delay or failure to deliver caused by labor or transportation difficulties, accidents, acts of God, failure of sources of supply, or other causes beyond our control, and changes will affect the delivery date.

CHANGE OF ORDERS OR CANCELLATIONS

Changes or cancellations are subject to our ability to conform. A charge will be levied against canceled or changed orders based on costs already incurred by Nienkämper. All changes must be in writing and submitted on a revised purchase order. Changes will affect the delivery date.

STORAGE

If goods cannot be accepted when ready, we may transfer them to storage (which is to be deemed as delivery for invoice purposes). The customer accepts risks and will be charged at prevailing rates.

FREIGHT

Prices include freight charges, blanket-wrapped, dock delivered, from the manufacturing source to any location in the contiguous United States. Packing and/or crating are available, if required, upcharges apply.

CLAIMS

All furniture is given to the carrier and signed for in good condition. It is the responsibility of the receiver to sign for the goods in the presence of the carrier and note the condition in which they are received. Freight claims should be filed with the carrier.

WARRANTY

There are no express or implied warranties, conditions and obligations of the manufacturer, whether statutory or otherwise that extend beyond the description on the face hereof. Our furniture is made to the highest standard and is warranted free from defects of material and workmanship for five years from the date of delivery. During the warranty period we will repair or replace such merchandise as shall prove to be defective, during normal usage in accordance with manufacturer's specifications. The manufacturer shall not be liable for defect wholly attributable to normal manufacturing process. Replacement or repair of the Product shall be the sole remedy of the Customer, and the manufacturer shall not be liable for any direct, indirect, incidental, or consequential loss or damage suffered by the Customer by reason of any defect in workmanship or manufacture of the Product or inability to use the Product. Moreover, this warranty does not cover accidental damage, abuse, alteration, ordinary wear and tear of Goods, negligence and misuse nor variations over which we have no control such as heat or humidity or damage to which the Goods are connected that is not attributable to the failure of the goods themselves. This warranty is null and void when the product is installed with hardware other than that supplied and/or when installed differently than recommended in the installation guide. Modification to the product or hardware may result in failure of the product and cause damage and/or injury.

WOOD FINISHES

Nienkämper offers a wide variety of standard light finishes on cherry, mahogany and figured anigre wood veneers, and a clear natural finish on figured anigre, figured sycamore, maple, bird's eye maple and curly maple.

Light finishes do not mask the grain and other characteristics of each wood species. It is important to understand that pieces of the same type of wood will not look identical when a light finish is used. The appearance of the finish will also depend on the natural color of the veneer. Cherry darkens over time as the wood ages. Pin knots and gum pockets are inherent traits.

Wood is a naturally variable raw material; its variances are not within the furniture manufacturer's control and are therefore not considered defects under this warranty.

