



Pricing April 2021
Discount 57.7% from List prices



MAS SIN 33721

TAILOR Lounge Collection - MODULAR



PRODUCT CODE

91 01 MC - NA

Series

91 : Tailor

Number of Seats

1 : Single Seat
2 : Two Seat
3 : Three Seat

Type

MC : Mid-Back Connected
MIC : Mid-Back, Inside Curve, Connected
MOC : Mid-Back, Outside Curve, Connected
MBC : Bench, Connected

Arms

na : No Arm
L : Left Arm
R : Right Arm



OPTIONS

ARM GAP



ARM CAP



POWER



In table



In seat

FINISHES

FRAME



Select from one of our 76 standard Spectone colors

FABRIC



Select fabrics from one of our textile partners

LAMINATE

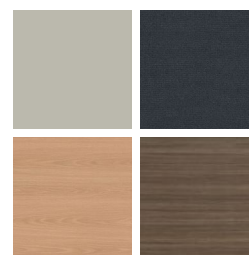

Select from 15 standard laminates or choose any standard Wilsonart, Nevamar, Formica, Arborite and Pionite matte finish laminates for no extra charge

EDGE

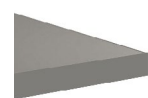

SE

ARM CAPS



Polyurethane

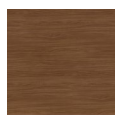

Wood*

*Wood arms are available in 9 standard stains or stain-to-match for no extra charge.

Toll Free: 1-888-761-7732

TAILOR Lounge Collection - MODULAR

HOW TO ORDER

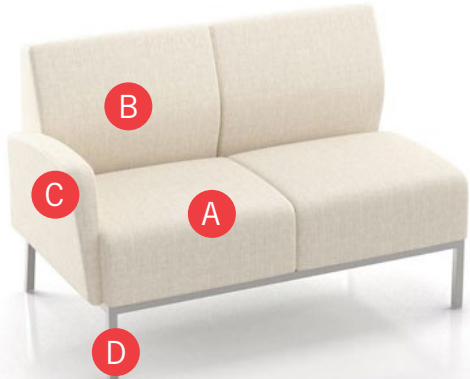

Specify Model

- A Specify Fabric - Seat¹
Manufacturer, Pattern Name, Color
- B Specify Fabric - Back¹
Manufacturer, Pattern Name, Color
- C Specify Fabric - Arms¹
Manufacturer, Pattern Name, Color
- D Specify Frame Finish

Optional: CAL 133, Moisture Barrier, 1" Gap Between Seat and Arm, Arm Caps, Connecting and Freestanding Tables, Power

Restrictions may apply. See price list tables below for more information.

¹ When multiple fabrics are specified on two and three seat chairs, please provide a drawing and legend for fabric placement.



Model	Fabric - Seat 1	Fabric - Seat 2	Fabric - Back 1	Fabric - Back 2	Fabric - Arm 1	Frame Finish
9102MC-L	Momentum, Beeline, Canvas	Momentum, Beeline, Canvas	Momentum, Beeline, Canvas	Momentum, Beeline, Canvas	Momentum, Beeline, Canvas	Silver



TAILOR Lounge Collection - MODULAR

LAYOUTS

To configure Tailor Modular, please specify left to right facing the configuration.

Tailor has two arm styles - end arms which are tapered, and connecting arms which are straight. Please provide a layout drawing with your purchase order or quote request and Customer Service will determine the appropriate arm (end or connecting) depending on their position within the layout. Arms are shipped assembled on the chair.



Tapered End Arm



Straight Connecting Arm

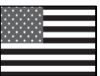

- A** Choose from one-, two-, three-seat and bariatric modular designs.

Note: Single seat configuration is shown in the example below.

- B** Tapered End Arms are installed at the ends of the layout run.

Note: Exceptions apply, see next page for more information.

- C** When arms are specified between seats or seat-to-table, a Straight Connecting Arm will be used.

- D** To complete your configuration, choose from end of run, spacer or corner connecting tables.

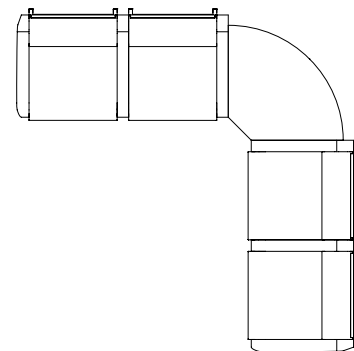
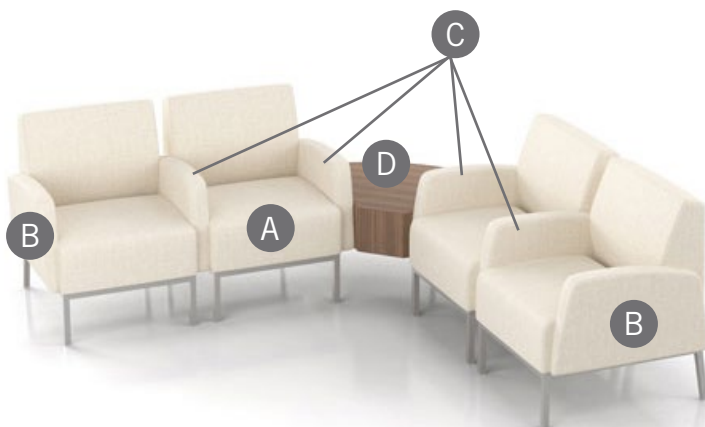

The configuration above can be specified as:

- | | |
|----------|---|
| 9101MC | Single Seat, Two Arms
(one Tapered End, one Straight Connecting) |
| 9101MC-R | Single Seat, With Right Arm Only
(Straight Connecting) |
| 91RC | Corner Table - Radius Corner |
| 9101MC | Single Seat, Two Arms
(two Straight Connecting) |
| 9101MC-R | Single Seat, With Right Arm Only
(Tapered End) |



Pricing April 2021
Discount 57.7% from List prices



MAS SIN 33721

TAILOR Lounge Collection - MODULAR

TAPERED END ARMS ON BOTH ENDS

Configurations with **arms on both ends** will have Tapered End Arms as standard.



Configuration above shows Tapered End Arms on outside of chairs, Straight Connecting Arms in center. Regardless of its complexity, when a configuration is ending in arms on both ends, the configuration will be specified with a Tapered End Arm as standard.



- A** Tapered End Arm
- B** Straight Connecting Arm

STRAIGHT CONNECTING ARM ON ONE END

Configurations with an **arm on one end** will have Straight Connecting Arm as standard.



Configuration above is ending in a table on one end, and an arm on the other end of the run. Regardless of its complexity, when a configuration is ending in one arm only, the configuration will be specified with a Straight Connecting Arm as standard. Customers may specify Tapered End Arm at the end of such run, but a special note must be given to Customer Service at the time of quote/order. Note that the arm beside the table will always be a Straight Connecting Arm.



TAILOR Lounge Collection - MODULAR

FOUR SEAT DESIGN, EXAMPLE 1

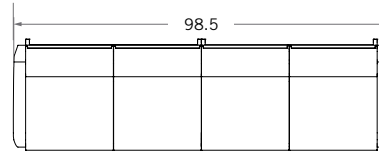
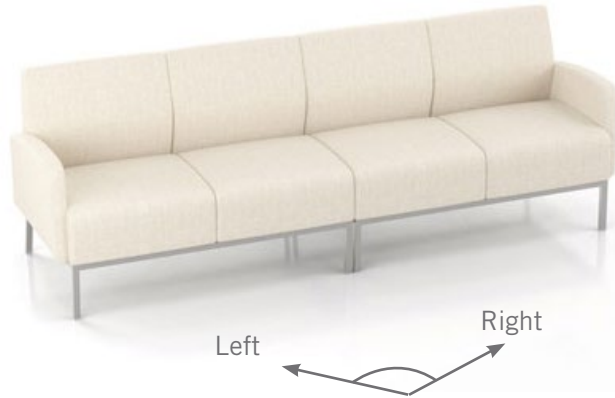

A four-seat configuration may be specified as two two-seat sofas.

- 9102MC-L Two Seat, With Left Arm Only (Tapered End)
- 9102MC-R Two Seat, With Right Arm Only (Tapered End)

FOUR SEAT DESIGN, EXAMPLE 2

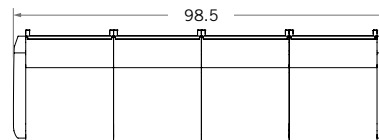

A four-seat configuration may also be specified as four single seat chairs. Please note that the number of legs in this case is double than in the example above.

Note: Specifying with single seats allows for higher flexibility, but this also increases the number of legs.

- 9101MC-L Single Seat, With Left Arm Only (Tapered End)
- 9101MC-NA Single Seat, Without Arms
- 9101MC-NA Single Seat, Without Arms
- 9101MC-R Single Seat, With Right Arm Only (Tapered End)

FOUR SEAT DESIGN, EXAMPLE 3

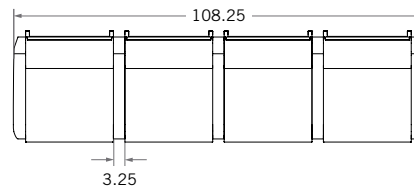

Arms may be added between each seat, increasing the gap between each chair base, as well as the overall width of the configuration.

- 9101MC Single Seat, Two Arms (one Tapered End, one Straight Connecting)
- 9101MC-R Single Seat, With Right Arm Only (Straight Connecting)
- 9101MC-R Single Seat, With Right Arm Only (Straight Connecting)
- 9101MC-R Single Seat, With Right Arm Only (Tapered End)



Pricing April 2021
Discount 57.7% from List prices



MAS SIN 33721

TAILOR Lounge Collection - MODULAR

END TABLE ON BOTH ENDS, EXAMPLE

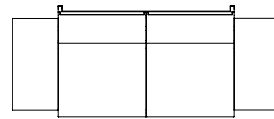
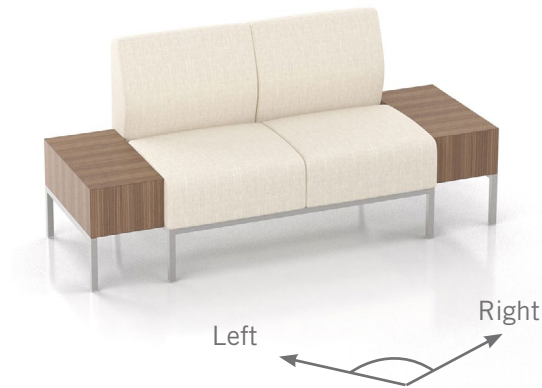

91ERC - 24 x 12
9102MC-NA
91ERC - 24 x 12

End of Run Table Closed - Half Size
Two Seat, Without Arms
End of Run Table Closed - Half Size

SPACER TABLE BETWEEN SEATS, EXAMPLE

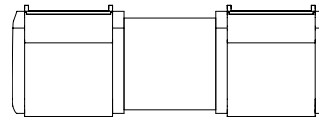
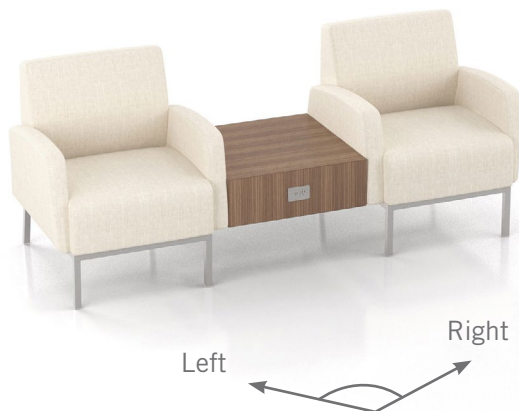

9101MC
91STC - 24 x 24
COV-1U-S
9101MC

Single Seat, Two Arms
(one Tapered End, one Straight Connecting)
Spacer Table Closed - Full Size
Cove, 1 power, 2USB, Silver Pearl
Single Seat, Two Arms
(one Straight Connecting, one Tapered End)



Pricing April 2021
Discount 57.7% from List prices



MAS SIN 33721

TAILOR Lounge Collection - MODULAR

Standard Features

- Separate seat and back
- Wall-saving frame
- Clear, non-marring glides
- Meet BIFMA Seating Durability Test to 500 lbs
- One connecting plate per unit
- Ships assembled, 1/carton 24 cu ft

For fabrics you wish railroaded or repeats larger than 5" x 5", please contact the factory with repeat information, and yardage requirement will be provided.



Wall-saving Frame

To ensure proper configuration please provide a layout drawing.

Options

- Polyurethane arm caps available in Black (B), Taupe RAL 7006 (T) or Sterling Grey (G), add **\$120** List per arm
- For wood arm caps, select from 9 standard stains, or stain-to-match for no extra charge, add **\$142** List per arm
- 1" gap between seat and arm available at **\$49** List per arm
- Upholstered arms/seat/back can match or contrast
- Cove Mini power module centered in the seat front is available in Black, Silver Pearl and Gloss White. Add **\$435** List per seat per module
- Antibacterial and antimicrobial fabrics available
- Connecting and freestanding tables available
- CAL 133 for 9102MC-NA, add **\$213** List per unit. CAL 133 for 9102MC, add **\$329** List per unit



Tapered End Arm



Straight Connecting Arm



Cove Mini

Single Seat, Without Arms

COM 2.75 yds
1.25 yds COM per single seat
1.5 yds COM per single back

MODEL	COM	GR 1	GR 2	GR 3	GR 4	GR 5	GR 6
9101MC-NA	981	1131	1179	1283	1436	1556	1710

Dimensions (inches)
seat H 18.0 seat W 23.0
total H 33.0 total W 23.0 depth 29.0



9101MC-NA
43 lbs

Single Seat, Two Arms

COM 4.25 yds
1.25 yds COM per single seat
1.5 yds COM per single back
0.75 yds COM per arm

MODEL	COM	GR 1	GR 2	GR 3	GR 4	GR 5	GR 6
9101MC	1497	1732	1808	1970	2209	2393	2635

Dimensions (inches)
seat H 18.0 seat W 23.0 arm H 24.5
total H 33.0 total W 29.5 depth 29.0



9101MC
67 lbs



Pricing April 2021
Discount 57.7% from List prices



MAS SIN 33721

TAILOR Lounge Collection - MODULAR

Standard Features

- Separate seat and back
- Wall-saving frame
- Clear, non-marring glides
- Meet BIFMA Seating Durability Test to 500 lbs
- One connecting plate per unit
- Ships assembled, 1/carton 24 cu ft

For fabrics you wish railroaded or repeats larger than 5" x 5", please contact the factory with repeat information, and yardage requirement will be provided.

To ensure proper configuration please provide a layout drawing.



Wall-saving Frame

Options

- Polyurethane arm caps available in Black (B), Taupe RAL 7006 (T) or Sterling Grey (G), add **\$120** List per arm
- For wood arm caps, select from 9 standard stains, or stain-to-match for no extra charge, add **\$142** List per arm
- 1" gap between seat and arm available at **\$49** List per arm
- Upholstered arms/seat/back can match or contrast
- Cove Mini power module centered in the seat front is available in Black, Silver Pearl and Gloss White. Add **\$435** List per seat per module
- Antibacterial and antimicrobial fabrics available
- Connecting and freestanding tables available
- CAL 133, add **\$271** List per unit



Tapered End Arm



Straight Connecting Arm



Cove Mini

Single Seat, With Right Arm Only

COM 3.5 yds
1.25 yds COM per single seat
1.5 yds COM per single back
0.75 yds COM per arm

MODEL	COM	GR 1	GR 2	GR 3	GR 4	GR 5	GR 6
9101MC-R	1239	1431	1494	1627	1823	1973	2173

Dimensions (inches)

	seat H	18.0	seat W	23.0	arm H	24.5
total H	33.0	total W	26.25	depth	29.0	



9101MC-R
55 lbs

Single Seat, With Left Arm Only

COM 3.5 yds
1.25 yds COM per single seat
1.5 yds COM per single back
0.75 yds COM per arm

MODEL	COM	GR 1	GR 2	GR 3	GR 4	GR 5	GR 6
9101MC-L	1239	1431	1494	1627	1823	1973	2173

Dimensions (inches)

	seat H	18.0	seat W	23.0	arm H	24.5
total H	33.0	total W	26.25	depth	29.0	



9101MC-L
55 lbs



Pricing April 2021
Discount 57.7% from List prices



MAS SIN 33721

TAILOR Lounge Collection - MODULAR

Standard Features

- Separate seat and back
- Wall-saving frame
- Clear, non-marring glides
- Meet BIFMA Seating Durability Test to 750 lbs
- One connecting plate per unit
- Ships assembled, 1/carton 32 cu ft

For fabrics you wish railroaded or repeats larger than 5" x 5", please contact the factory with repeat information, and yardage requirement will be provided.

To ensure proper configuration please provide a layout drawing.



Wall-saving Frame

Options

- Polyurethane arm caps available in Black (B), Taupe RAL 7006 (T) or Sterling Grey (G), add **\$120** List per arm
- For wood arm caps, select from 9 standard stains, or stain-to-match for no extra charge, add **\$142** List per arm
- 1" gap between seat and arm available at **\$49** List per arm
- Upholstered arms/seat/back can match or contrast
- Cove Mini power module centered in the seat front is available in Black, Silver Pearl and Gloss White. Add **\$435** List per seat per module
- Antibacterial and antimicrobial fabrics available
- Connecting and freestanding tables available
- CAL 133, add **\$389** List per unit



Tapered End Arm



Straight Connecting Arm



Cove Mini

Bariatric Single Seat, Two Arms

COM 5 yds
1.5 yds COM per single seat
2 yds COM per single back
0.75 yds COM per arm

MODEL	COM	GR 1	GR 2	GR 3	GR 4	GR 5	GR 6
9101GC	1636	1895	1988	2180	2465	2684	2973

Dimensions (inches)

seat H	18.0	seat W	30.0	arm H	24.5
total H	33.0	total W	36.5	depth	29.0



9101GC
75 lbs



Pricing April 2021
Discount 57.7% from List prices



MAS SIN 33721

TAILOR Lounge Collection - MODULAR

Standard Features

- Separate seat and back
- Wall-saving frame
- Clear, non-marring glides
- Meet BIFMA Seating Durability Test to 570 lbs
- One connecting plate per unit
- Ships assembled, 1/carton 43 cu ft

For fabrics you wish railroaded or repeats larger than 5" x 5", please contact the factory with repeat information, and yardage requirement will be provided.

To ensure proper configuration please provide a layout drawing.

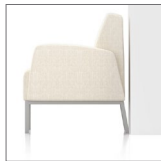

Wall-saving Frame

Options

- Polyurethane arm caps available in Black (B), Taupe RAL 7006 (T) or Sterling Grey (G), add **\$120** List per arm
- For wood arm caps, select from 9 standard stains, or stain-to-match for no extra charge, add **\$142**List per arm
- 1" gap between seat and arm available at **\$49** List per arm
- Upholstered arms/seat/back can match or contrast
- Cove Mini power module centered in the seat front is available in Black, Silver Pearl and Gloss White. Add **\$435** List per seat per module
- Antibacterial and antimicrobial fabrics available
- Connecting and freestanding tables available
- CAL 133 for 9102MC-NA, add **\$426** List per unit. CAL 133 for 9102MC, add **\$542**List per unit



Tapered End Arm



Straight Connecting Arm



Cove Mini

Two Seat, Without Arms

COM 5.5 yds
1.25 yds COM per single seat
1.5 yds COM per single back

MODEL	COM	GR 1	GR 2	GR 3	GR 4	GR 5	GR 6
9102MC-NA	1704	2005	2103	2310	2617	2852	3163

Dimensions (inches)

seat H	18.0	seat W	23.0				
total H	33.0	total W	46.0	depth	29.0		



9102MC-NA
92 lbs

Two Seat, With Two Arms

COM 7 yds
1.25 yds COM per single seat
1.5 yds COM per single back
0.75 yds COM per arm

MODEL	COM	GR 1	GR 2	GR 3	GR 4	GR 5	GR 6
9102MC	2222	2606	2732	2997	3389	3689	4088

Dimensions (inches)

seat H	18.0	seat W	23.0	arm H	24.5		
total H	33.0	total W	52.5	depth	29.0		



9102MC
116 lbs



Pricing April 2021
Discount 57.7% from List prices



MAS SIN 33721

TAILOR Lounge Collection - MODULAR

Standard Features

- Separate seat and back
- Wall-saving frame
- Clear, non-marring glides
- Meet BIFMA Seating Durability Test to 570 lbs
- One connecting plate per unit
- Ships assembled, 1/carton 43 cu ft

For fabrics you wish railroaded or repeats larger than 5" x 5", please contact the factory with repeat information, and yardage requirement will be provided.

To ensure proper configuration please provide a layout drawing.



Wall-saving Frame

Options

- Polyurethane arm caps available in Black (B), Taupe RAL 7006 (T) or Sterling Grey (G), add **\$120** List per arm
- For wood arm caps, select from 9 standard stains, or stain-to-match for no extra charge, add **\$142** List per arm
- 1" gap between seat and arm available at **\$49** List per arm
- Upholstered arms/seat/back can match or contrast
- Cove Mini power module centered in the seat front is available in Black, Silver Pearl and Gloss White. Add **\$435** List per seat per module
- Antibacterial and antimicrobial fabrics available
- Connecting and freestanding tables available
- CAL 133, add **\$484**List per unit



Tapered End Arm



Straight Connecting Arm



Cove Mini

Two Seat, With Right Arm Only

COM 6.25 yds
1.25 yds COM per single seat
1.5 yds COM per single back
0.75 yds COM per arm

MODEL	COM	GR 1	GR 2	GR 3	GR 4	GR 5	GR 6
9102MC-R	1964	2305	2417	2654	3002	3271	3626

Dimensions (inches)

	seat H	18.0	seat W	23.0	arm H	24.5	total H	33.0	total W	49.25	depth	29.0



9102MC-R
104 lbs

Two Seat, With Left Arm Only

COM 6.25 yds
1.25 yds COM per single seat
1.5 yds COM per single back
0.75 yds COM per arm

MODEL	COM	GR 1	GR 2	GR 3	GR 4	GR 5	GR 6
9102MC-L	1964	2305	2417	2654	3002	3271	3626

Dimensions (inches)

	seat H	18.0	seat W	23.0	arm H	24.5	total H	33.0	total W	49.25	depth	29.0



9102MC-L
104 lbs



Pricing April 2021
Discount 57.7% from List prices



MAS SIN 33721

TAILOR Lounge Collection - MODULAR

Standard Features

- Separate seat and back
- Wall-saving frame
- Clear, non-marring glides
- Meet BIFMA Seating Durability Test to 750 lbs
- One connecting plate per unit
- Ships assembled, 1/carton 62 cu ft

For fabrics you wish railroaded or repeats larger than 5" x 5", please contact the factory with repeat information, and yardage requirement will be provided.

To ensure proper configuration please provide a layout drawing.



Wall-saving Frame

Options

- Polyurethane arm caps available in Black (B), Taupe RAL 7006 (T) or Sterling Grey (G), add **\$120** List per arm
- For wood arm caps, select from 9 standard stains, or stain-to-match for no extra charge, add **\$142** List per arm
- 1" gap between seat and arm available at **\$49** List per arm
- Upholstered arms/seat/back can match or contrast
- Cove Mini power module centered in the seat front is available in Black, Silver Pearl and Gloss White. Add **\$435** List per seat per module
- Antibacterial and antimicrobial fabrics available
- Connecting and freestanding tables available
- CAL 133 for 9102MC-NA, add **\$639** List per unit. CAL 133 for 9102MC, add **\$755** List per unit



Tapered End Arm



Straight Connecting Arm



Cove Mini

Three Seat, Without Arms

COM 8.25 yds

1.25 yds COM per single seat

1.5 yds COM per single back

MODEL	COM	GR 1	GR 2	GR 3	GR 4	GR 5	GR 6
9103MC-NA	2430	2879	3026	3338	3796	4149	4617

Dimensions (inches)

seat H	18.0	seat W	23.0				
total H	33.0	total W	69.0	depth	29.0		



9103MC-NA
137 lbs

Three Seat, With Two Arms

COM 9.75 yds

1.25 yds COM per single seat

1.5 yds COM per single back

0.75 yds COM per arm

MODEL	COM	GR 1	GR 2	GR 3	GR 4	GR 5	GR 6
9103MC	2946	3480	3655	4024	4569	4988	5542

Dimensions (inches)

seat H	18.0	seat W	23.0	arm H	24.5		
total H	33.0	total W	75.5	depth	29.0		



9103MC
161 lbs



Pricing April 2021
Discount 57.7% from List prices



MAS SIN 33721

TAILOR Lounge Collection - MODULAR

Standard Features

- Separate seat and back
- Wall-saving frame
- Clear, non-marring glides
- Meet BIFMA Seating Durability Test to 750 lbs
- One connecting plate per unit
- Ships assembled, 1/carton 62 cu ft

For fabrics you wish railroaded or repeats larger than 5" x 5", please contact the factory with repeat information, and yardage requirement will be provided.

To ensure proper configuration please provide a layout drawing.



Wall-saving Frame

Options

- Polyurethane arm caps available in Black (B), Taupe RAL 7006 (T) or Sterling Grey (G), add **\$120** List per arm
- For wood arm caps, select from 9 standard stains, or stain-to-match for no extra charge, add **\$142** List per arm
- 1" gap between seat and arm available at **\$49** List per arm
- Upholstered arms/seat/back can match or contrast
- Cove Mini power module centered in the seat front is available in Black, Silver Pearl and Gloss White. Add **\$435** List per seat per module
- Antibacterial and antimicrobial fabrics available
- Connecting and freestanding tables available
- CAL 133, add **\$697** List per unit



Tapered End Arm



Straight Connecting Arm



Cove Mini

Three Seat, With Right Arm Only

COM 9 yds
1.25 yds COM per single seat
1.5 yds COM per single back
0.75 yds COM per arm

MODEL	COM	GR 1	GR 2	GR 3	GR 4	GR 5	GR 6
9103MC-R	2687	3179	3342	3681	4183	4568	5078

Dimensions (inches)			
seat H	18.0	seat W	23.0
total H	33.0	total W	72.25
		arm H	24.5
		depth	29.0



9103MC-R
149 lbs

Three Seat, With Left Arm Only

COM 9 yds
1.25 yds COM per single seat
1.5 yds COM per single back
0.75 yds COM per arm

MODEL	COM	GR 1	GR 2	GR 3	GR 4	GR 5	GR 6
9103MC-L	2687	3179	3342	3681	4183	4568	5078

Dimensions (inches)			
seat H	18.0	seat W	23.0
total H	33.0	total W	72.25
		arm H	24.5
		depth	29.0



9103MC-L
149 lbs



Pricing April 2021
Discount 57.7% from List prices



MAS SIN 33721

TAILOR Lounge Collection - MODULAR - SERPENTINE

HOW TO ORDER

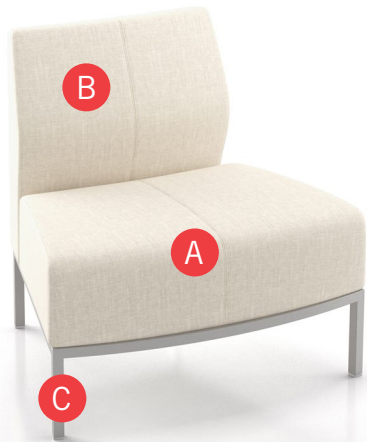

Specify Model

- A** Specify Fabric - Seat
Manufacturer, Pattern Name, Color
- B** Specify Fabric - Back
Manufacturer, Pattern Name, Color
- C** Specify Frame Finish

Optional: CAL 133, Moisture Barrier, Arms, Connecting and Freestanding Tables

Model	Fabric - Seat 1	Fabric - Back 1	Frame Finish
9101MOC	Momentum, Beeline, Canvas	Momentum, Beeline, Canvas	Silver



SEAMS

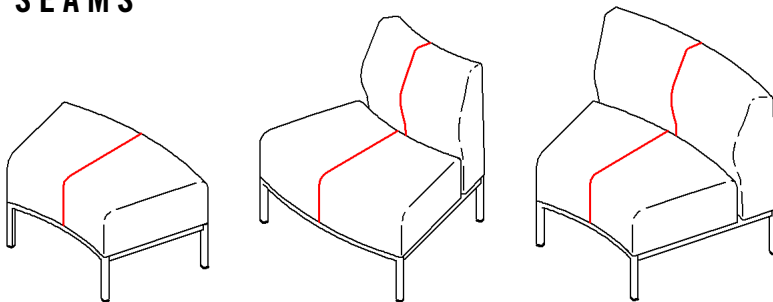

Please note that all Tailor Serpentine models feature a centered vertical seam (red line). If patterned fabric is being used, the patterns may not line up along the seams or between chairs.

30 DEGREE ANGLE



Bench

Chair, Inside Curve

Chair, Outside Curve

All Tailor Serpentine models are designed at a 30° angle. To create a 90° corner, use three units of the same orientation (i.e., inside curve or outside curve). The bench, depending on how it's specified, can be used as either inside curve or outside curve unit.



TAILOR Lounge Collection - MODULAR - SERPENTINE

Standard Features

- 30° angle
- Separate seat and back
- Non wall-saving frame.
NOTE: If ordering with other Tailor Modular designs, specify all connected seating within the configuration as non wall-saving.
- Clear, non-marring glides
- Meet BIFMA Seating Durability Test to 500 lbs
- One connecting plate per unit
- Ships assembled, 1/carton 24 cu ft

For fabrics you wish railroaded or repeats larger than 5" x 5", please contact the factory with repeat information, and yardage requirement will be provided.



Non Wall-saving Frame

To ensure proper configuration please provide a layout drawing.

Options

- Tapered or Straight connecting arm
- Polyurethane arm caps available in Black (B), Taupe RAL 7006 (T) or Sterling Grey (G), add \$120 List per arm
- For wood arm caps, select from 9 standard stains, or stain-to-match for no extra charge, add \$142 List per arm
- 1" gap between seat and arm available at \$49 List per arm
- Upholstered arms/seat/back can match or contrast
- Antibacterial and antimicrobial fabrics available
- Connecting and freestanding tables available
- CAL 133 for 9101MIC-NA, add \$252 List per unit. CAL 133 for 9101MIC, add \$368 List per unit



Tapered End Arm

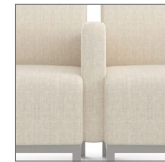

Straight Connecting Arm

Tailor Serpentine, Inside Curve, Without Arms

COM 3.25 yds
1.5 yds COM per single seat
1.75 yds COM per single back

MODEL	COM	GR 1	GR 2	GR 3	GR 4	GR 5	GR 6
9101MIC-NA	1726	1913	1974	2099	2289	2430	2622

Dimensions (inches)
seat H 18.0 seat W 22.0/33.0
total H 33.0 total W 37.0 depth 29.5



9101MIC-NA
54 lbs

Tailor Serpentine, Inside Curve, Two Arms

COM 4.75 yds
1.5 yds COM per single seat
1.75 yds COM per single back
0.75 yds COM per arm

MODEL	COM	GR 1	GR 2	GR 3	GR 4	GR 5	GR 6
9101MIC	2233	2512	2604	2793	3077	3288	3578

Dimensions (inches)
seat H 18.0 seat W 22.0/33.0
total H 33.0 total W 43.5 depth 29.5



9101MIC
78 lbs



TAILOR Lounge Collection - MODULAR - SERPENTINE

Standard Features

- 30° angle
- Separate seat and back
- Non wall-saving frame.
NOTE: If ordering with other Tailor Modular designs, specify all connected seating within the configuration as non wall-saving.
- Clear, non-marring glides
- Meet BIFMA Seating Durability Test to 500 lbs
- One connecting plate per unit
- Ships assembled, 1/carton 24 cu ft

Options

- Tapered or Straight connecting arm
- Polyurethane arm caps available in Black (B), Taupe RAL 7006 (T) or Sterling Grey (G), add \$120 List per arm
- For wood arm caps, select from 9 standard stains, or stain-to-match for no extra charge, add \$142 List per arm
- 1" gap between seat and arm available at \$49 List per arm
- Upholstered arms/seat/back can match or contrast
- Antibacterial and antimicrobial fabrics available
- Connecting and freestanding tables available
- CAL 133, add \$310 List per unit

For fabrics you wish railroaded or repeats larger than 5" x 5", please contact the factory with repeat information, and yardage requirement will be provided.



Non Wall-saving Frame

To ensure proper configuration please provide a layout drawing.



Tapered End Arm



Straight Connecting Arm

Tailor Serpentine, Inside Curve, With Right Arm Only

COM 4.0 yds
1.5 yds COM per single seat
1.75 yds COM per single back
0.75 yds COM per arm

MODEL	COM	GR 1	GR 2	GR 3	GR 4	GR 5	GR 6
9101MIC-R	1980	2212	2289	2446	2684	2860	3102

Dimensions (inches)
seat H 18.0 seat W 22.0/33.0
total H 33.0 total W 40.25 depth 29.5



9101MIC-R
66 lbs

Tailor Serpentine, Inside Curve, With Left Arm Only

COM 4.0 yds
1.5 yds COM per single seat
1.75 yds COM per single back
0.75 yds COM per arm

MODEL	COM	GR 1	GR 2	GR 3	GR 4	GR 5	GR 6
9101MIC-L	1980	2212	2289	2446	2684	2860	3102

Dimensions (inches)
seat H 18.0 seat W 22.0/33.0
total H 33.0 total W 40.25 depth 29.5



9101MIC-L
66 lbs



TAILOR Lounge Collection - MODULAR - SERPENTINE

Standard Features

- 30° angle
- Separate seat and back
- Non wall-saving frame.
 - NOTE:** If ordering with other Tailor Modular designs, specify all connected seating within the configuration as non wall-saving.
- Clear, non-marring glides
- Meet BIFMA Seating Durability Test to 500 lbs
- One connecting plate per unit
- Ships assembled, 1/carton 24 cu ft

Options

- Tapered or Straight connecting arm
- Polyurethane arm caps available in Black (B), Taupe RAL 7006 (T) or Sterling Grey (G), add **\$120** List per arm
- For wood arm caps, select from 9 standard stains, or stain-to-match for no extra charge, add **\$142** List per arm
- 1" gap between seat and arm available at **\$49** List per arm
- Upholstered arms/seat/back can match or contrast
- Antibacterial and antimicrobial fabrics available
- Connecting and freestanding tables available
- CAL 133 for 9101MOC-NA, add **\$248** List per unit. CAL 133 for 9101MOC, add **\$364** List per unit

For fabrics you wish railroaded or repeats larger than 5" x 5", please contact the factory with repeat information, and yardage requirement will be provided.



Non Wall-saving Frame

To ensure proper configuration please provide a layout drawing.



Tapered End Arm



Straight Connecting Arm

Tailor Serpentine, Outside Curve, Without Arms

COM 3.2 yds
 1.5 yds COM per single seat
 1.7 yds COM per single back

MODEL	COM	GR 1	GR 2	GR 3	GR 4	GR 5	GR 6
9101MOC-NA	1634	1821	1882	2007	2197	2338	2531

Dimensions (inches)

seat H	18.0	seat W	33.0/22.0
total H	33.0	total W	37.0 depth 29.5



9101MOC-NA
46 lbs

Tailor Serpentine, Outside Curve, Two Arms

COM 4.7 yds
 1.5 yds COM per single seat
 1.7 yds COM per single back
 0.75 yds COM per arm

MODEL	COM	GR 1	GR 2	GR 3	GR 4	GR 5	GR 6
9101MOC	2141	2420	2512	2701	2986	3197	3486

Dimensions (inches)

seat H	18.0	seat W	33.0/22.0
total H	33.0	total W	43.5 depth 29.5



9101MOC
70 lbs



TAILOR Lounge Collection - MODULAR - SERPENTINE

Standard Features

- 30° angle
- Separate seat and back
- Non wall-saving frame
- Clear, non-marring glides
- Meet BIFMA Seating Durability Test to 500 lbs
- One connecting plate per unit
- Ships assembled, 1/carton 24 cu ft

For fabrics you wish railroaded or repeats larger than 5" x 5", please contact the factory with repeat information, and yardage requirement will be provided.

Options

- Tapered or straight connecting arm
- Polyurethane arm caps available in Black (B), Taupe RAL 7006 (T) or Sterling Grey (G), add **\$120** List per arm
- For wood arm caps, select from 9 standard stains, or stain-to-match for no extra charge, add **\$142** List per arm
- 1" gap between seat and arm available at **\$49** List per arm
- Upholstered arms/seat/back can match or contrast
- Antibacterial and antimicrobial fabrics available
- Connecting and freestanding tables available
- CAL 133, add **\$306** List per unit



Non Wall-saving Frame

To ensure proper configuration please provide a layout drawing.



Tapered End Arm



Straight Connecting Arm

Tailor Serpentine, Outside Curve, With Right Arm Only

COM 3.95 yds
1.5 yds COM per single seat
1.7 yds COM per single back
0.75 yds COM per arm

MODEL	COM	GR 1	GR 2	GR 3	GR 4	GR 5	GR 6
9101MOC-R	1888	2121	2197	2354	2592	2768	3010

Dimensions (inches)
seat H 18.0 seat W 33.0/22.0
total H 33.0 total W 40.25 depth 29.5



9101MOC-R
58 lbs

Tailor Serpentine, Outside Curve, With Left Arm Only

COM 3.95 yds
1.5 yds COM per single seat
1.7 yds COM per single back
0.75 yds COM per arm

MODEL	COM	GR 1	GR 2	GR 3	GR 4	GR 5	GR 6
9101MOC-L	1888	2121	2197	2354	2592	2768	3010

Dimensions (inches)
seat H 18.0 seat W 33.0/22.0
total H 33.0 total W 40.25 depth 29.5



9101MOC-L
58 lbs



Pricing April 2021
Discount 57.7% from List prices



MAS SIN 33721

TAILOR Lounge Collection - MODULAR - SERPENTINE

Standard Features

- 30° angle
- Non wall-saving frame
- Clear, non-marring glides
- Meet BIFMA Seating Durability Test to 500 lbs
- One connecting plate per unit
- Ships assembled, 1/carton 11 cu ft

Options

- Antibacterial and antimicrobial fabrics available
- CAL 133, add \$116 List per unit

For fabrics you wish railroaded or repeats larger than 5" x 5", please contact the factory with repeat information, and yardage requirement will be provided.



To ensure proper configuration please provide a layout drawing.

Non Wall-saving Frame



Tailor Serpentine, Bench

COM 1.5 yds
1.5 yds COM per single seat

MODEL	COM	GR 1	GR 2	GR 3	GR 4	GR 5	GR 6
9101MBC	1030	1117	1145	1205	1293	1360	1450

Dimensions (inches)							
seat H	18.0	seat W	22.0/33.0				
total H	18.0	total W	33.0	depth	22.0		



9101MBC
32 lbs



Pricing April 2021
Discount 57.7% from List prices



MAS SIN 33721

TAILOR Lounge Collection - MODULAR TABLES

Standard Features

- Tables in laminate or veneer
- Select laminate tops from 15 standard laminates or choose any standard Wilsonart, Nevamar, Formica, Arborite and Pionite matte finish laminates at no upcharge.
- 9 standard veneers. Stain-to-match available at no upcharge.
- Tables available with Self Edge (SE) only
- Steel table legs available in any Spectone color
- Tops utilize NU Green earth friendly core
- Clear, non-marring glides
- One connecting plate per unit
- Ships KD
- 17" height

Options

- To add Cove Mini, clamp mounted with 1 power, 2 USB (charging only), and a 108" long cord to Tailor modular tables, add **\$351** List. Cove will be located on the flat front face of the closed tables as standard. It is not recommended to specify power on open tables. Specify separately at time of order.



Black **COVSMC1P1U-B**
Silver Pearl **COVSMC1P1U-S**
Gloss White **COVSMC1P1U-W**

To ensure proper configuration please provide a layout drawing.

Corner and Spacer Connecting Tables

Model		Laminate SE	Veneer SE	Weight	Cu.Ft.
91STC - 24X24	SPACER TABLE CLOSED - FULL SIZE	847	1186	32	11
91STO - 24X24	SPACER TABLE OPEN - FULL SIZE	869	1216	30	11
91STC - 24X12	SPACER TABLE CLOSED - HALF SIZE	793	1109	20	7
91STO - 24X12	SPACER TABLE OPEN - HALF SIZE	814	1139	20	7
91ERC - 24X24	END OF RUN TABLE CLOSED - FULL SIZE	1022	1430	33	11
91ERO - 24X24	END OF RUN TABLE OPEN - FULL SIZE	1043	1461	31	11
91ERC - 24X12	END OF RUN TABLE CLOSED - HALF SIZE	967	1354	21	7
91ERO - 24X12	END OF RUN TABLE OPEN - HALF SIZE	988	1384	21	7
91ERB	END OF RUN TABLE - BULLET	1112	1557	36	14
91HM	END OF RUN TABLE - HALF-MOON	1485	2276	75	25
91RC	CORNER TABLE - 90 RADIUS CORNER	1112	1557	45	16
91RC45	CORNER TABLE - 45 RADIUS CORNER	1112	1557	32	12



91STC - 24 x 24
32 lbs



91STO - 24 x 24
30 lbs



91STC - 24 x 12
20 lbs



91STO - 24 x 12
20 lbs



91RC
45 lbs



91RC45
32 lbs



91ERC - 24 x 24
33 lbs



91ERO - 24 x 24
31 lbs



91ERC - 24 x 12
21 lbs



91ERO - 24 x 12
21 lbs



91ERB
36 lbs



91HM
75 lbs