



Prices effective July 5, 2023

Published July 2023

# Public Office Landscape®

<b>Introduction</b>	<b>page 2</b>
<b>Public Office Landscape®</b>	<b>3</b>
Seating	5
Desking and Storage	14
Power	16
Tables	32
Space Delineation	39
<b>Indices</b>	<b>43</b>
By Name	43
By Number	45
<b>Appendices</b>	
20-Day or Less/Assigned Lead-Time Order Information	
Customer's Own Material Order Information-Workspaces	
Proprietary Textiles Application Chart-Workspaces	
Proprietary Textile Colors-Workspaces	
Customer's Own Material/Customer's Own Leather Order Information-Seating	
Proprietary Textiles Application Chart-Seating	
Proprietary Textile Colors-Seating	
Maharam® Application Chart-Seating	
Maharam Colors-Seating	
<b>For the latest materials information, refer to the Materials pages on HermanMiller.com.</b>	

# Introduction

## A Note on the Organization of This Book

There are a few signals that will help you understand the organization of this book. Once you know them, you should be able to find your way around easily.

### Like a newspaper, this book is formatted with columns of text and illustrations that run vertically.

Information wraps from one column to the next and continues for as many pages as it needs to.

### Black bars are clues.

A black bar at the top of a page signals the start of information about a product.

This information is divided into two sections, each signaled by a black bar. Product Information includes a description, additional notes, and dimensional drawings. Specification Information, which always begins at the top of a column, includes a series of steps. Each step represents a decision you need to make in order to complete your product number. Steps must be followed sequentially. The number of pages needed to complete information on a product varies; some will be complete in one page; others may fill three or four pages. Just continue going through the steps until you run into the next product, signaled by the black bar at the top of the page.

Black tabs running along the outside edge of the page help you locate what section you are in or what section you want to go to. You can thumb forwards or backwards to find a section; tabs and text appear on both sides of the page.

The additional pages in the back of the book include the appendices and indices. They are signaled by a long black bar running along the outside edge of the page.

### The index is presented two ways.

The first index is in alphabetical order by product name. It can be helpful if you are new to the products and numbering scheme or if you are looking for a type of product, such as work chair or round table.

The second index is by product number. It lists, in alphanumeric order, the base product number, typically a five-digit number.

## General Information

This book is effective July 5, 2023, subject to change without notice. Products may be purchased from authorized Herman Miller dealers who will quote prices upon request. For more information about our products and services or to see a list of dealers, visit [www.HermanMiller.com](http://www.HermanMiller.com).

All prices are list prices. Additional services, such as planning services, design, storage, and installation, are not included and must be added to these prices when the additional services are requested.

Illustrations, specifications, and prices are based on the latest information at the time of publication. The right is reserved to make changes at any time without notice in prices, fabrics, finishes, materials, specifications, and models, and also to discontinue models and finishes.

Dimensions shown in the drawings are engineering drawing dimensions rounded up to the nearest  $\frac{1}{8}$ ". Product is shipped set up or knocked down. Products that include "Shipped knocked down" in the description require some assembly. If this statement does not appear in the description, the product is shipped assembled.

Service problems are normally handled by a Herman Miller authorized dealer. Where this cannot be accomplished on a local level, service problems should be referred to the Customer Care Representative for your region, Herman Miller, Inc., Zeeland, Michigan 49464.

### 20-Day or Less/Assigned Lead-Time Shipments

All products and options in this price book not designated by an Assigned Program icon  will ship in **20 business days or less** after being acknowledged by Herman Miller.

Products and options designated by an  are on the assigned lead-time program and may ship in 20 days, less than 20 days, or more than 20 days from order acknowledgement.

**Seating**

**Desking and Storage**

**Power**

**Tables**

**Space Delineation**



# Social Chair

BVS1N.

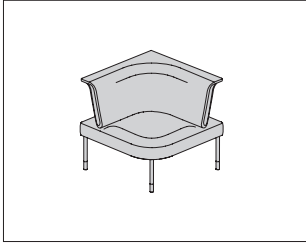

### Product Information

#### Description

This chair has an upholstered foam seat on an expanded polypropylene base, with a Network-wrapped suspension back. The chair can be freestanding next to a desk or connected to other social chairs or café tables. It accepts the attachment of screens. It comes with legs for freestanding applications or without legs when attached to other chairs. Legs have glides that provide up to 2" of adjustment.

#### Notes

- Chair supports attachment of 2 screens.
- When specified without legs, order seating legs (BVS3.) separately.
- When specifying leg (L) option, legs are welded to seat frame and are not reconfigurable.
- Network color and back loop frame color will match.
- Seat fabric is railroaded.
- Customers Own Material can only be specified for seat fabric. See Customers Own Material Order Information in appendices.
- Seat accepts Customer's Own Material (COM). Yardage is estimated for nondirectional 54"-wide fabrics. Order 2.16 yards of fabric per cushion. For information on multiple quantities or directional fabrics, contact COM Department. See Order Information in Appendices.

#### Dimensions

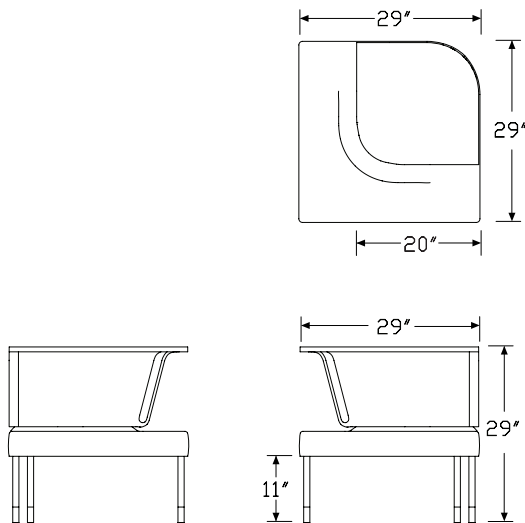

### Specification Information

#### Step 1.

**BVS1N.**

#### Step 2. Seat Style

- L** left
- R** right

#### Step 3. Leg Option

- L** legs
- N** no legs

#### Step 4. Fire Retardancy

*For not fire retardant (\*), skip this step.*  
not fire retardant

#### Prices for Steps 1-4.

		*
<b>BVS1N.L</b>	<b>L</b>	\$2747
	<b>N</b>	\$2747
	<b>R L</b>	\$2747
	<b>N</b>	\$2747

#### Step 5. Glide Option

*For legs (L)*

- C** nylon glide, carpet floors +\$0

#### Step 6. Leg Finish

*For legs (L)*

- G1** graphite +\$0
- 91** white +\$0
- MS** metallic silver +\$0

#### Step 7. Glide Finish

*For graphite (G1)*

- BK** black +\$0

*For white (91)*

- 8Q** folkstone grey +\$0

*For metallic silver (MS)*

- 63** fog +\$0

Step 8. Back Frame Finish		
<b>91</b>	white	+\$0
<b>G1</b>	graphite	+\$0
<b>RO</b>	red	+\$0
<b>97</b>	twilight	+\$0
<b>63</b>	fog	+\$0
<b>79</b>	green apple	+\$0
<b>WBY</b>	wild berry	+\$0

Step 9. Back Knit Color		
Price Category 4		
<i>For white (91)</i>		
<b>1A901</b>	network warm white	+\$0
<b>1A902</b>	network fog	+\$0
<b>1A903</b>	network red	+\$0
<b>1A904</b>	network wild berry	+\$0
<b>1A905</b>	network green apple	+\$0
<b>1A906</b>	network twilight blue	+\$0
<b>1A907</b>	network graphite	+\$0
<b>1DL01</b>	dialogue light brindle	+\$0
<b>1DL02</b>	dialogue dark brindle	+\$0

Price Category 4		
<i>For graphite (G1)</i>		
<b>1A901</b>	network warm white	+\$0
<b>1A902</b>	network fog	+\$0
<b>1A903</b>	network red	+\$0
<b>1A904</b>	network wild berry	+\$0
<b>1A905</b>	network green apple	+\$0
<b>1A906</b>	network twilight blue	+\$0
<b>1A907</b>	network graphite	+\$0
<b>1DL01</b>	dialogue light brindle	+\$0
<b>1DL02</b>	dialogue dark brindle	+\$0

Price Category 4		
<i>For red (RO)</i>		
<b>1A901</b>	network warm white	+\$0
<b>1A902</b>	network fog	+\$0
<b>1A903</b>	network red	+\$0
<b>1A904</b>	network wild berry	+\$0
<b>1A905</b>	network green apple	+\$0
<b>1A906</b>	network twilight blue	+\$0
<b>1A907</b>	network graphite	+\$0

Price Category 4		
<i>For twilight (97)</i>		
<b>1A901</b>	network warm white	+\$0
<b>1A902</b>	network fog	+\$0
<b>1A903</b>	network red	+\$0
<b>1A904</b>	network wild berry	+\$0
<b>1A905</b>	network green apple	+\$0
<b>1A906</b>	network twilight blue	+\$0
<b>1A907</b>	network graphite	+\$0

Price Category 4		
<i>For fog (63)</i>		
<b>1A901</b>	network warm white	+\$0
<b>1A902</b>	network fog	+\$0
<b>1A903</b>	network red	+\$0
<b>1A904</b>	network wild berry	+\$0
<b>1A905</b>	network green apple	+\$0
<b>1A906</b>	network twilight blue	+\$0
<b>1A907</b>	network graphite	+\$0
<b>1DL01</b>	dialogue light brindle	+\$0
<b>1DL02</b>	dialogue dark brindle	+\$0

Price Category 4		
<i>For green apple (79)</i>		
<b>1A901</b>	network warm white	+\$0
<b>1A902</b>	network fog	+\$0
<b>1A903</b>	network red	+\$0
<b>1A904</b>	network wild berry	+\$0
<b>1A905</b>	network green apple	+\$0
<b>1A906</b>	network twilight blue	+\$0
<b>1A907</b>	network graphite	+\$0

Price Category 4		
<i>For wild berry (WBY)</i>		
<b>1A901</b>	network warm white	+\$0
<b>1A902</b>	network fog	+\$0
<b>1A903</b>	network red	+\$0
<b>1A904</b>	network wild berry	+\$0
<b>1A905</b>	network green apple	+\$0
<b>1A906</b>	network twilight blue	+\$0
<b>1A907</b>	network graphite	+\$0

## Social Chair *continued*

Step 10. Seat Fabric	
Price Category 1	+\$0
Price Category 2	+\$30
Price Category 3	+\$55
Price Category 4	+\$108
Price Category 5	+\$161
Price Category 7	+\$346
Price Category 8	+\$455
Price Category 9	+\$505
Price Category 10	+\$686
Price Category C	+\$128
Price Category D	+\$162
Price Category E	+\$230
Price Category F	+\$253
Price Category G	+\$296
Price Category I	+\$638

# Sectional Seating

BVS2N.

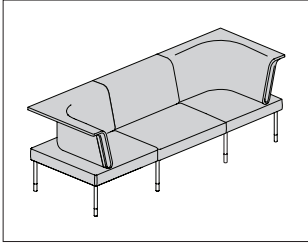

Public Office Landscape® Seating

## Product Information

### Description

The sectional seat comes in straight, right-corner, and left-corner styles. It has an upholstered foam seat on an expanded polypropylene base, with a Network-wrapped suspension back. Sectional seats connect to other sectional seats and social chairs and accept the attachment of screens.

### Notes

Order seating legs (BVS3.) separately.

Corner-style seats support 2 screens. Straight-style seats support 1 screen.

Network color and back loop frame color will match.

Seat fabric is railroaded.

Customers Own Material can only be specified for seat fabric. See

Customers Own Material Order Information in appendices.

Seat accepts Customer's Own Material (COM). Yardage is estimated for nondirectional 54"-wide fabrics.

Seat style—Yardage

CR—2.16

CL—2.16

29—2.21

For information on multiple quantities or directional fabrics, contact COM Department. See Order Information in Appendices.

## Dimensions

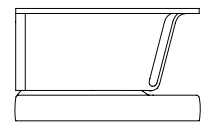
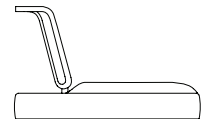
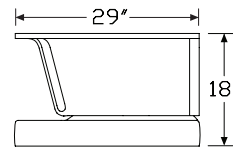
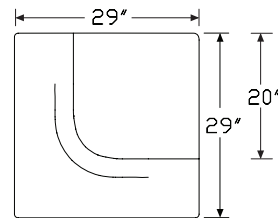
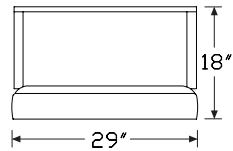
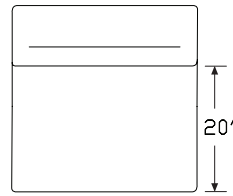

# Sectional Seating *continued*

## Specification Information

### Step 1.

**BVS2N.**

### Step 2. Seat Style

- CR** corner right
- CL** corner left
- 29** straight, 29"

### Step 3. Fire Retardancy

*For not fire retardant (\*), skip this step.*  
not fire retardant

### Prices for Steps 1-3.

	*
<b>BVS2N. CR</b>	\$2747
<b>CL</b>	\$2747
<b>29</b>	\$2747

### Step 4. Back Frame Finish

- 91** white +\$0
- G1** graphite +\$0
- RO** red +\$0
- 97** twilight +\$0
- 63** fog +\$0
- 79** green apple +\$0
- WBY** wild berry +\$0

### Step 5. Back Knit Color

#### Price Category 4

#### *For white (91)*

- 1A901** network warm white +\$0
- 1A902** network fog +\$0
- 1A903** network red +\$0
- 1A904** network wild berry +\$0
- 1A905** network green apple +\$0
- 1A906** network twilight blue +\$0
- 1A907** network graphite +\$0
- 1DL01** dialogue light brindle +\$0
- 1DL02** dialogue dark brindle +\$0

#### Price Category 4

#### *For graphite (G1)*

- 1A901** network warm white +\$0
- 1A902** network fog +\$0
- 1A903** network red +\$0
- 1A904** network wild berry +\$0
- 1A905** network green apple +\$0
- 1A906** network twilight blue +\$0
- 1A907** network graphite +\$0
- 1DL01** dialogue light brindle +\$0
- 1DL02** dialogue dark brindle +\$0

#### Price Category 4

#### *For red (RO)*

- 1A901** network warm white +\$0
- 1A902** network fog +\$0
- 1A903** network red +\$0
- 1A904** network wild berry +\$0
- 1A905** network green apple +\$0
- 1A906** network twilight blue +\$0
- 1A907** network graphite +\$0

#### Price Category 4

#### *For twilight (97)*

- 1A901** network warm white +\$0
- 1A902** network fog +\$0
- 1A903** network red +\$0
- 1A904** network wild berry +\$0
- 1A905** network green apple +\$0
- 1A906** network twilight blue +\$0
- 1A907** network graphite +\$0

#### Price Category 4

#### *For fog (63)*

- 1A901** network warm white +\$0
- 1A902** network fog +\$0
- 1A903** network red +\$0
- 1A904** network wild berry +\$0
- 1A905** network green apple +\$0
- 1A906** network twilight blue +\$0
- 1A907** network graphite +\$0
- 1DL01** dialogue light brindle +\$0
- 1DL02** dialogue dark brindle +\$0

# Sectional Seating *continued*

---

Price Category 4  
*For green apple (79)*

---

<b>1A901</b> network warm white	+\$0
<b>1A902</b> network fog	+\$0
<b>1A903</b> network red	+\$0
<b>1A904</b> network wild berry	+\$0
<b>1A905</b> network green apple	+\$0
<b>1A906</b> network twilight blue	+\$0
<b>1A907</b> network graphite	+\$0

---

Price Category 4  
*For wild berry (WBY)*

---

<b>1A901</b> network warm white	+\$0
<b>1A902</b> network fog	+\$0
<b>1A903</b> network red	+\$0
<b>1A904</b> network wild berry	+\$0
<b>1A905</b> network green apple	+\$0
<b>1A906</b> network twilight blue	+\$0
<b>1A907</b> network graphite	+\$0

---

Step 6. Seat Fabric

Price Category 1	+\$0
Price Category 2	+\$30
Price Category 3	+\$55
Price Category 4	+\$108
Price Category 5	+\$161
Price Category 7	+\$346
Price Category 8	+\$455
Price Category 9	+\$505
Price Category 10	+\$686
Price Category C	+\$128
Price Category D	+\$162
Price Category E	+\$230
Price Category F	+\$253
Price Category G	+\$296
Price Category I	+\$638

# Legs

# BVS3.

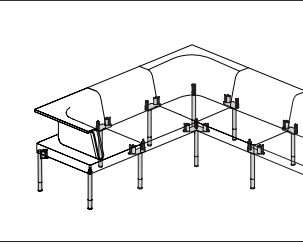

### Product Information

#### Description

Seating legs provide 4 attachment options to accommodate the various configurations of social chairs and sectional seats. Legs have glides that provide up to 2" of adjustment.

#### Notes

When specifying trivalent chrome (47) finish option, glide color must be specified separately.

#### Dimensions

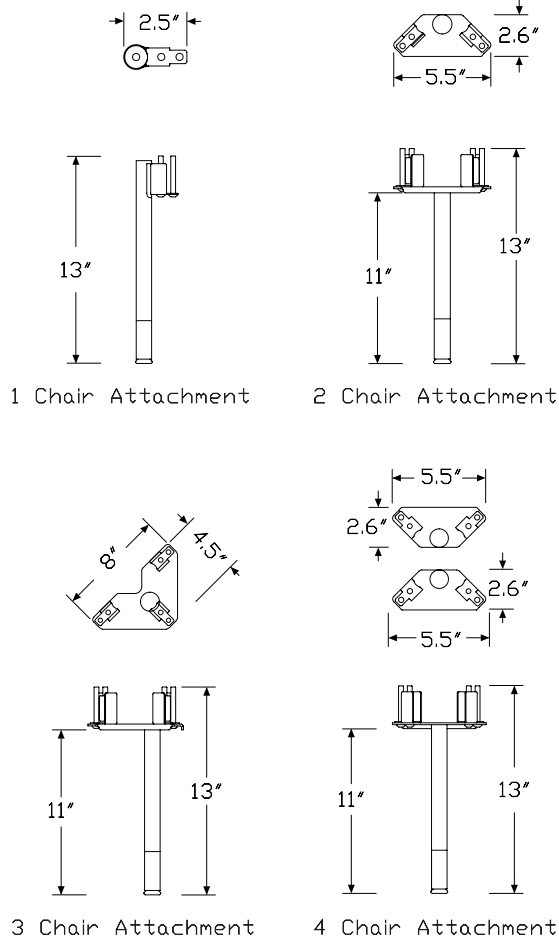

### Specification Information

#### Step 1.

**BVS3.**

#### Step 2. Leg Option

- 1 attaches to one chair
- 2 attaches to two chairs
- 3 attaches to three chairs
- 4 attaches to four chairs

#### Prices for Steps 1-2.

<b>BVS3. 1</b>	\$84
<b>2</b>	\$121
<b>3</b>	\$170
<b>4</b>	\$239

#### Step 3. Glide Option

<b>C</b>	nylon glide, carpet floors	+\$0
----------	----------------------------	------

#### Step 4. Leg Finish

<b>91</b>	white	+\$0
<b>G1</b>	graphite	+\$0
<b>MS</b>	metallic silver	+\$0
<b>47</b>	trivalent chrome	+\$10

#### Step 5. Glide Finish

##### For graphite (G1)

<b>BK</b>	black	+\$0
-----------	-------	------

##### For white (91)

<b>8Q</b>	folkstone grey	+\$0
-----------	----------------	------

##### For metallic silver (MS)

<b>63</b>	fog	+\$0
-----------	-----	------

##### For trivalent chrome (47)

<b>BK</b>	black <input type="checkbox"/>	+\$0
<b>8Q</b>	folkstone grey <input type="checkbox"/>	+\$0
<b>63</b>	light grey <input type="checkbox"/>	+\$0

Seat Back Ganging Kit

BVS4.

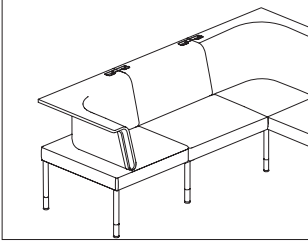

Public Office Landscape® Seating

**Product Information**

**Description**  
This seat back ganging kit aligns 2 chairs that are side-by-side.

**Dimensions**

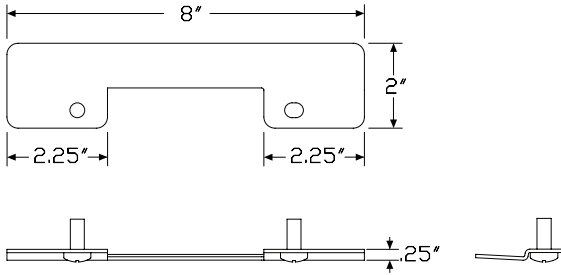

**Specification Information**

<b>Step 1.</b>	
<b>BVS4.</b>	\$47
<b>Step 2. Leg Option</b>	
2 ganging kit for 2 seats	+\$0

# Seat Back Alignment Clip

BVS5.

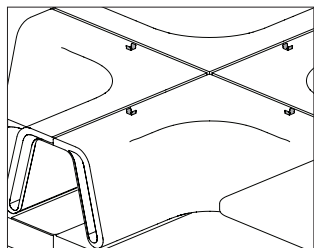

### Product Information

#### Description

This seat back alignment clip aligns 2 chairs that are back-to-back.

#### Dimensions

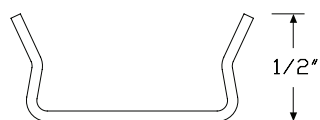
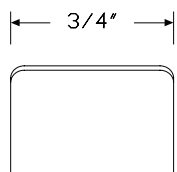
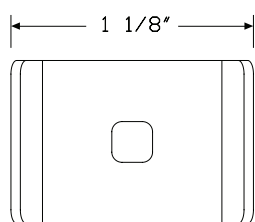

### Specification Information

#### Step 1.

**BVS5.1**

\$26

Desk and Bin Finishing Kit

BVD4.

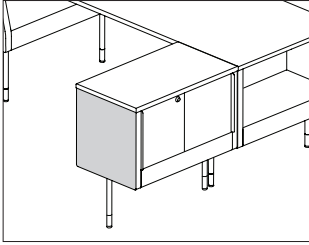

Public Office Landscape® Desking and Storage

**Product Information**

**Description**

This finishing kit is painted steel and covers the exposed end of a desk, peninsula table, connecting bin, or freestanding bin.

**Notes**

Specify kit color to match color of corresponding desk, peninsula table, connecting bin, or freestanding bin.

**Dimensions**

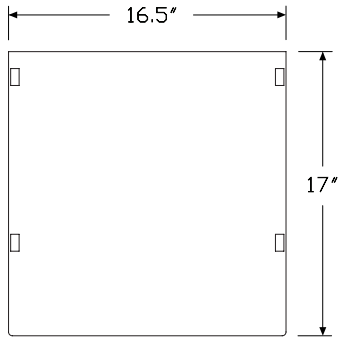

**Specification Information**

**Step 1.**

**BVD4.**

**Step 2. Kit Application**

- 1** bin finishing kit, single
- 2** bin finishing kit, double

**Prices for Steps 1-2.**

<b>BVD4. 1</b>	\$80
<b>2</b>	\$134

**Step 3. End Cap Material Finish**

<b>G1</b>	graphite	+\$0
<b>91</b>	white	+\$0
<b>MS</b>	metallic silver	+\$0

# Desk and Bin Ganging Plate

BVD5.

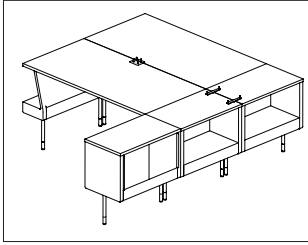

## Product Information

### Description

These ganging plates provide attachment between units. Attachment hardware included.

### Notes

See Planning Guide for more information about settings.

### Dimensions

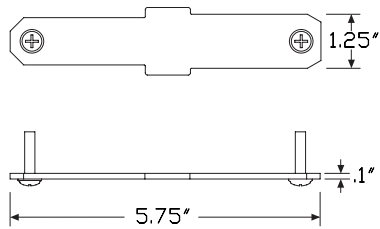

Peninsula table & freestanding bin ganging plates (B)

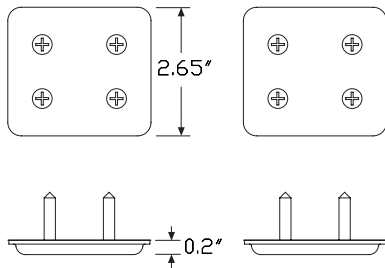
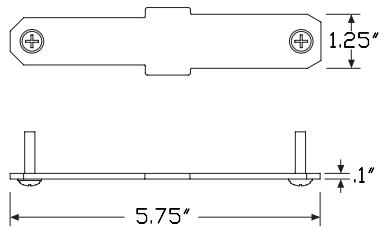

Desk & connecting bin ganging plates (C)

## Specification Information

### Step 1.

**BVD5.**

### Step 2. Application

**B** bin-to-bin

**C** connecting bin ganging kit

### Prices for Steps 1-2.

<b>BVD5. B</b>	\$97
<b>C</b>	\$189

Modular Power Entry, New York BVE02.

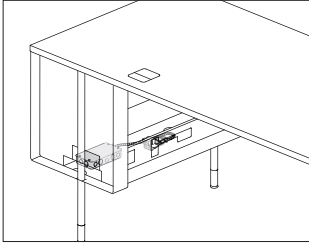

**Product Information**

Description

This power entry connects a buildings electrical supply from a wall, floor, or column to a desk or connecting bin. It includes a junction box with 8" of wire and a harness. The junction box can be located in the desk or connecting bin. The power entry plugs into any of the ports on the power block. UL listed and Canadian UL listed.

Notes

A licensed electrician must wire power entry.

Dimensions

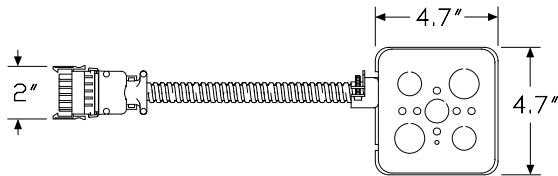
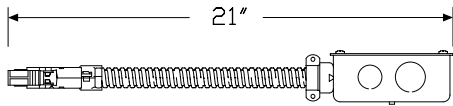

**Specification Information**

Step 1.

**BVE02.**

Step 2. Wire Configuration

**08** 8 wire

Prices for Steps 1-2.

**BVE02. 08** \$363

# Power Block

BVE03.

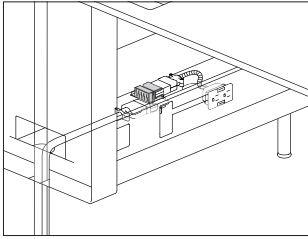

### Product Information

#### Description

This power block has electrical ports for connecting modular power to receptacles and jumpers. UL listed and Canadian UL listed.

#### Notes

See Planning Guide for more information about power.

#### Dimensions

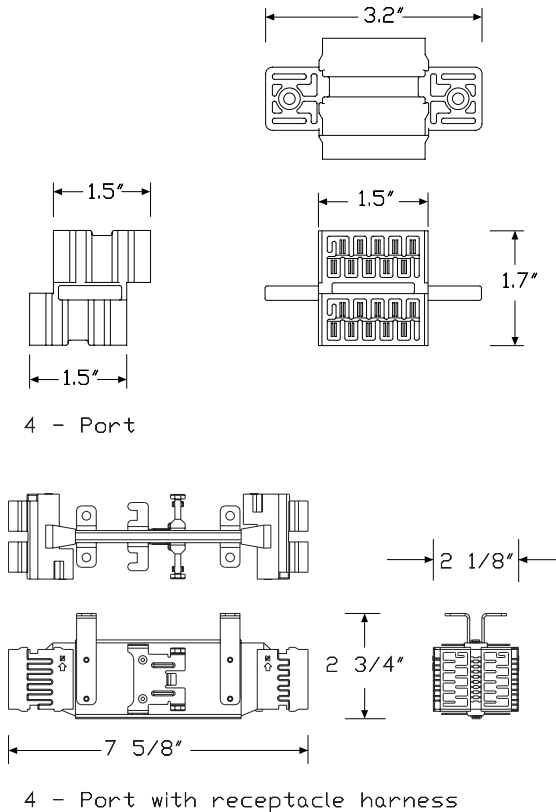

### Specification Information

#### Step 1.

**BVE03.**

#### Step 2. Wire Configuration

**08** 8 wire

#### Step 3. Block Configuration

**04** 4 port

**4R** 4 port with receptacle harness A

#### Prices for Steps 1-3.

	<b>04</b>	<b>4R</b>
<b>BVE03. 08</b>	\$68	122

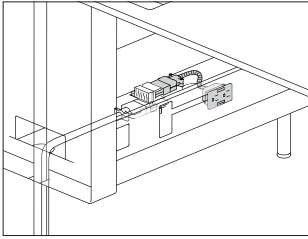

**Product Information**

**Description**

This receptacle connects to a power block and provides power to a desk. Package contains 1 duplex receptacle. UL listed and Canadian UL listed.

**Dimensions**

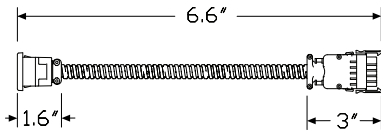

Public Office Landscape® Power

**Specification Information**

**Step 1.**

**BVE04.**

**Step 2. Wire Configuration**

**08** 8 wire

**Step 3. Duplex Type**

*For 8 wire (08)*

- AN** circuit a - shared neutral, 8 wire
- BN** circuit b - shared neutral, 8 wire
- CN** circuit c - shared neutral, 8 wire
- DN** circuit d - shared neutral, 8 wire
- AG** circuit a - shared neutral isolated ground, 8 wire
- BG** circuit b - shared neutral isolated ground, 8 wire
- CG** circuit c - shared neutral isolated ground, 8 wire
- DG** circuit d - shared neutral isolated ground, 8 wire

**Prices for Steps 1-3.**

	<b>AN</b>	<b>BN</b>	<b>CN</b>	<b>DN</b>	<b>AG</b>	<b>BG</b>
<b>BVE04. 08</b>	\$151	151	151	151	151	151
					<b>CG</b>	<b>DG</b>
<b>BVE04. 08</b>					\$151	151

**Step 4. Duplex Color**

- 91** white +\$0
- BK** black +\$0

# Modular Power Controlled Duplex

BVE04M

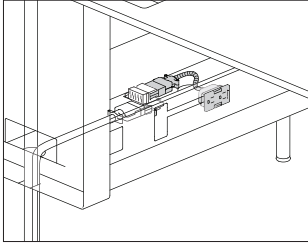

## Product Information

### Description

This receptacle is to be used for ASHRAE90.1 and Title 24 compliance. A controlled receptacle should be used for any receptacles that are under automated control by the energy management system. The receptacle connects to a power block and provides power to a desk. Package contains 1 duplex receptacle. It is UL listed and Canadian UL listed.

### Dimensions

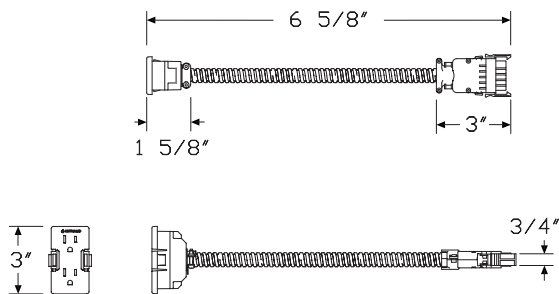

## Specification Information

### Step 1.

**BVE04M.**

### Step 2. Wire Configuration

**08** 8 wire

### Step 3. Duplex Type

#### For 8 wire (08)

- AN** circuit a - shared neutral, 8 wire
- BN** circuit b - shared neutral, 8 wire
- CN** circuit c - shared neutral, 8 wire
- DN** circuit d - shared neutral, 8 wire
- AG** circuit a - shared neutral isolated ground, 8 wire
- BG** circuit b - shared neutral isolated ground, 8 wire
- CG** circuit c - shared neutral isolated ground, 8 wire
- DG** circuit d - shared neutral isolated ground, 8 wire

#### Prices for Steps 1-3.

	<b>AN</b>	<b>BN</b>	<b>CN</b>	<b>DN</b>	<b>AG</b>	<b>BG</b>
<b>BVE04M. 08</b>	\$151	151	151	151	151	151
					<b>CG</b>	<b>DG</b>
<b>BVE04M. 08</b>					\$151	151

### Step 4. Duplex Color

- 91** white +\$0
- BK** black +\$0

# Power Block-to-Power Block Jumper

BVE05.

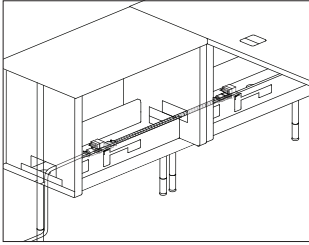

## Product Information

**Description**  
 This power jumper connects power block to power block. UL listed and Canadian UL listed.

**Notes**  
 See Planning Guide for more information about settings.

## Dimensions

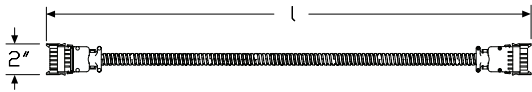

## Specification Information

**Step 1.**

**BVE05.**

## Step 2. Wire Configuration

**08** 8 wire

## Step 3. Jumper Length

- 29** 29" wide
- 30** 52" wide
- 116** 116" wide
- 134** 134" wide

## Prices for Steps 1-3.

	<b>29</b>	<b>30</b>	<b>116</b>	<b>134</b>
<b>BVE05. 08</b>	\$151	226	240	270

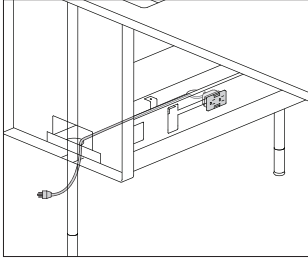

**Product Information**

**Description**

This corded power receptacle provides a plug-in solution in lieu of the modular power system. It plugs directly into a wall or floor outlet. Cord comes in 6', 10', and 20' lengths. Package contains 1 duplex receptacle. UL listed and Canadian UL listed.

**Dimensions**

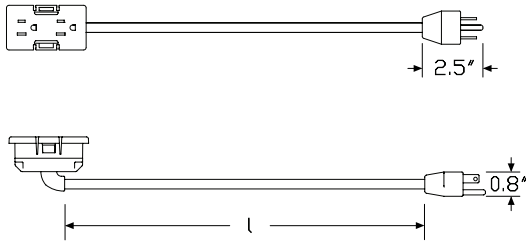

**Specification Information**

**Step 1.**

**BVE06.**

**Step 2. Duplex Configuration**

**1** single duplex

**Step 3. Cord Length**

- 06** 6' long
- 10** 10' long
- 20** 20' long

**Prices for Steps 1-3.**

	<b>06</b>	<b>10</b>	<b>20</b>
<b>BVE06. 1</b>	\$137	165	248

**Step 4. Duplex Color**

<b>91</b>	white		+\$0
<b>BK</b>	black		+\$0

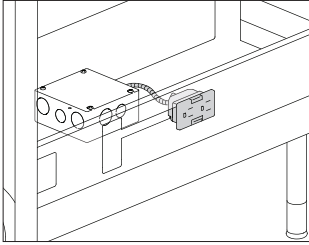

**Product Information**

**Description**

This hardwired receptacle connects to the Chicago Power Junction Box and provides power to the desk. Package contains 1 duplex receptacle. UL listed and Canadian UL listed.

**Notes**

A licensed electrician must wire the receptacle to the junction box (BVE08.), ordered separately.

**Dimensions**

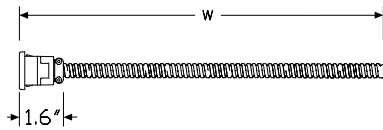

**Specification Information**

**Step 1.**

**BVE07.**

**Step 2. Configuration**

- A** circuit a
- B** circuit b

**Prices for Steps 1-2.**

<b>BVE07. A</b>	\$151
<b>B</b>	\$151

**Step 3. Duplex Color**

<b>91</b>	white	+\$0
<b>BK</b>	black	+\$0

# Chicago Power - Controlled Duplex

BVE07M

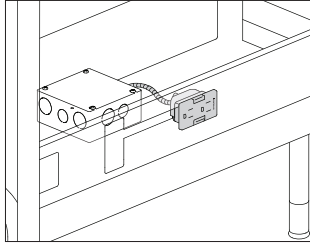

## Product Information

### Description

This receptacle is to be used for ASHRAE90.1 and Title 24 compliance. A controlled receptacle should be used for any receptacles that are under automated control by the energy management system. This hard-wired receptacle connects to the Chicago power junction box and provides power to a desk. Package contains 1 duplex receptacle. It is UL listed and Canadian UL listed.

### Notes

A licensed electrician must wire the receptacle to the junction box (BVE08.), ordered separately.

### Dimensions

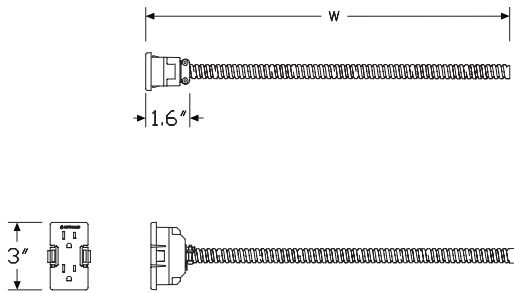

## Specification Information

### Step 1.

**BVE07M.**  A

### Step 2. Configuration

**A** circuit a  A

**B** circuit b  A

### Prices for Steps 1-2.

<b>BVE07M. A</b>	\$151
<b>B</b>	\$151

### Step 3. Duplex Color

<b>91</b> white <input type="checkbox"/> A	+\$0
<b>BK</b> black <input type="checkbox"/> A	+\$0

Controlled Receptacle Decal G9999.  
(12 per sheet)

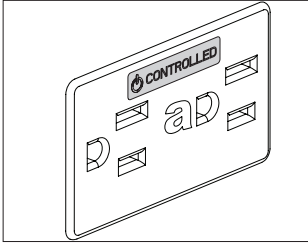

**Product Information**

**Description**

This decal is to be used for ASHRAE90.1 and Title 24 compliance. The decal is used to mark standard receptacles (new or existing) that are under automated control by the energy management system. 1 sheet includes 12 clear decals with white or black print.

**Dimensions**

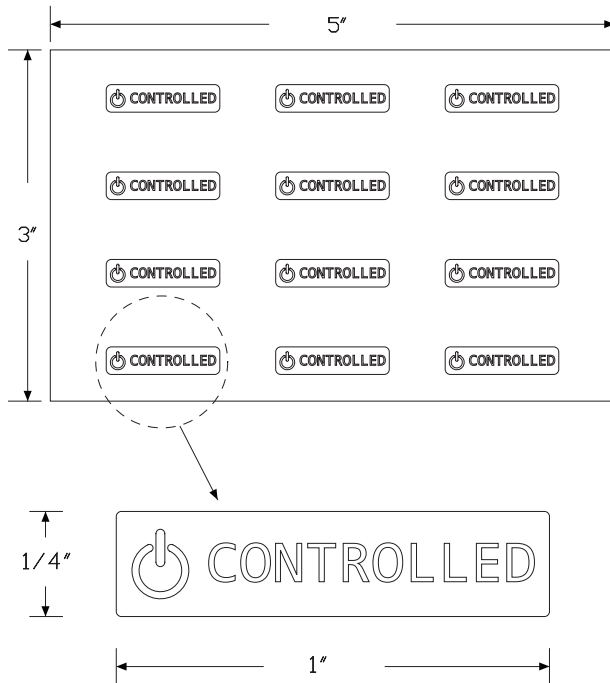

Public Office Landscape® Power

**Specification Information**

**Step 1.**

**G9999.**  A

**Step 2. Color**

**B** black print  A

**W** white print  A

**Prices for Steps 1-2.**

<b>G9999. B</b>	\$17
<b>W</b>	\$17

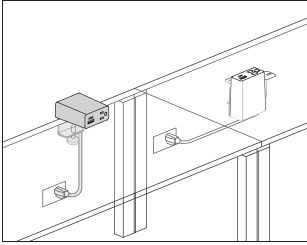

**Product Information**

**Description**

This electrical distributor plugs directly into floor, wall, or ceiling drop outlets. Each module configuration presents the same visual appearance. Cable clips and attachment hardware included. Product is UL listed.

**Notes**

Cable clips for cord management are intended for a 1-time installation.

Clamp versions can be reoriented in the field by a technician.

USB ports provide a combined 20 watts of power to charge most devices and tablets at full speed. USB-C provides 15 watts of power and USB-A provides 10 watts of power individually. When using the USB-C and USB-A ports simultaneously, USB-C remains at 15 watts and USB-A reduces to 5 watts.

Cord color is predetermined. For white (91) finish cords will be white.

For graphite (G1) finish cords will be black.

Grommet mount attachment (Y1414.xxxG) does not come with the mini grommet. Order Logic mini grommet (Y1412.) separately, as needed.

**Dimensions**

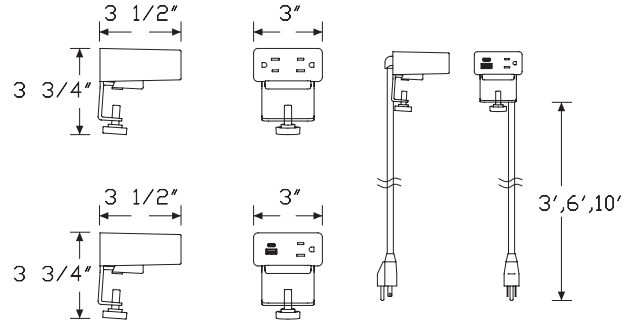

Surface Clamp

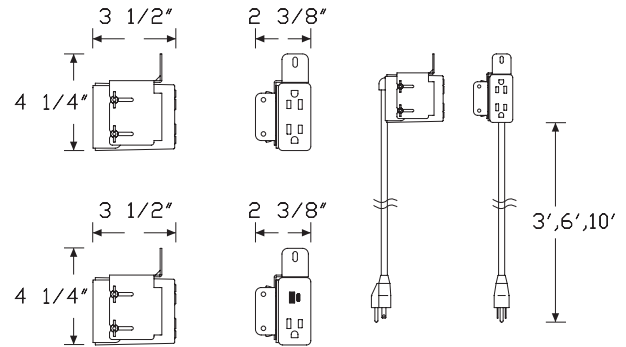

Grommet Mount

**Specification Information**

Step 1.

**Y1414.**

Step 2. Configuration

- L** 1 simplex receptacles, 1 powered USB A/C Combo
- K** 2 simplex receptacles

Step 3. Cord/Conduit Length

- 03** 3' cord/conduit
- 06** 6' cord/conduit
- 10** 10' cord/conduit

Step 4. Attachment

- G** grommet mount
- S** surface clamp

Prices for Steps 1-4.

	<b>G</b>	<b>S</b>
<b>Y1414. L 03</b>	\$457	457
<b>06</b>	\$457	457
<b>10</b>	\$468	468
<b>K 03</b>	\$256	256
<b>06</b>	\$256	256
<b>10</b>	\$269	269

Step 5. Finish

- BK** black A +\$0
- 91** white A +\$0
- 98** studio white A +\$0
- G1** graphite A +\$0

Logic G1200 Grommet Pass Thru Y1420.

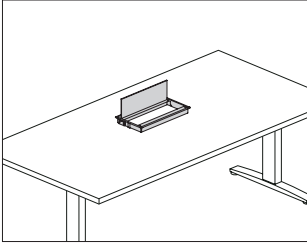

**Product Information**

**Description**

This Logic Power Access Solutions™ grommet mounted metal enclosure provides access to cords kept beneath the surface. The unit has an integrated cord keeper.

**Notes**

Unit size is based on the grommet mounted electrical distributor (Y1425.) with simplex receptacles.

**Dimensions**

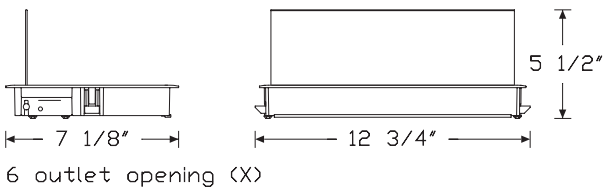
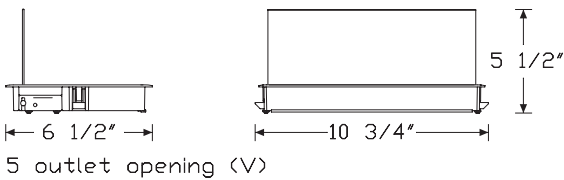
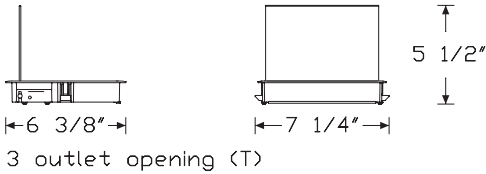

**Specification Information**

**Step 1.**

**Y1420.**

**Step 2. Configuration**

- T** three outlet opening
- V** five outlet opening
- X** six outlet opening

**Prices for Steps 1-2.**

<b>Y1420. T</b>	\$294
<b>V</b>	\$323
<b>X</b>	\$351

**Step 3. Finish**

<b>91</b>	white <input type="checkbox"/>	+\$0
<b>98</b>	studio white <input type="checkbox"/>	+\$0
<b>BK</b>	black <input type="checkbox"/>	+\$0
<b>G1</b>	graphite <input type="checkbox"/>	+\$0
<b>MS</b>	metallic silver <input type="checkbox"/>	+\$0

Chicago Power - Junction Box BVE08.

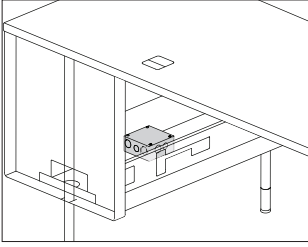

**Product Information**

**Description**  
This hardwired junction box provides power for up to 2 hardwired Chicago Power Receptacles. UL listed and Canadian UL listed.

**Notes**

A licensed electrician must wire the junction box to the Chicago power receptacle (BVE07.), ordered separately.

**Dimensions**

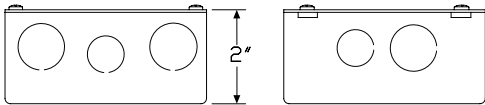
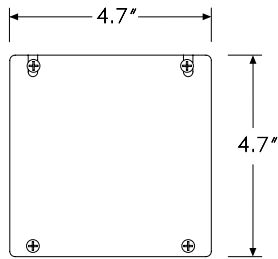

**Specification Information**

**Step 1.**  
**BVE08.** \$110

Logic HD Cable Manager

Y1424.

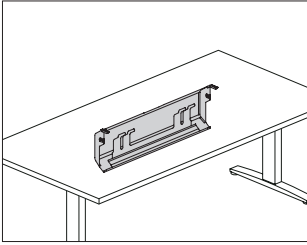

**Product Information**

**Description**

This Logic Power Access Solutions™ stand-alone cable management tray mounts to the underside of most surfaces. It can be used with a Logic unit for cord storage, or used alone with cords routed through the back side of the unit. Tray drops down and holds cords in place while working and can be easily stowed back in place.

**Dimensions**

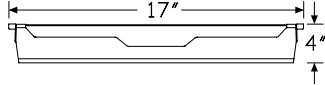
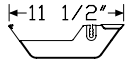

**Specification Information**

**Step 1.**

**Y1424.**

**Step 2. Size**

**17** 17" wide tray

**Prices for Steps 1-2.**

**Y1424. 17** \$323

**Step 3. Finish**

<b>SNA</b>	satin aluminum	+\$0
<b>SNB</b>	satin bronze	+\$0
<b>SNC</b>	satin carbon	+\$0
<b>91</b>	white <input type="checkbox"/>	+\$0
<b>98</b>	studio white <input type="checkbox"/>	+\$0
<b>BK</b>	black <input type="checkbox"/>	+\$0
<b>G1</b>	graphite <input type="checkbox"/>	+\$0
<b>MS</b>	metallic silver <input type="checkbox"/>	+\$0

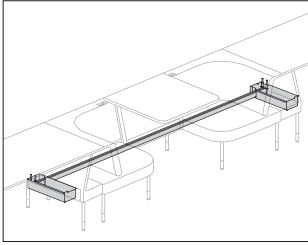

**Product Information**

**Description**

This kit includes beam to route power jumper and data between power bridge access desks positioned L-shelf-to-L-shelf with or without social chairs and café table between desk configurations. Attachment hardware included. Power components must be ordered separately.

**Notes**

Receptacle over only option (NB) supports desk back-to-back configurations with a single or double café and power bridge desk located on left or right side.

Jumper tray only option (00) covers the power block and desk jumper in back-to-back L-shelf configurations with the power bridge desk.

Short bridge option (29) connects L-shelf-to-desk bin configurations with a single social chair between desks. At least 1 desk must be the power bridge desk.

Long bridge option (87) connects L-shelf-to-L-shelf in desk side-to-side configurations with a café table between the power bridge desks.

See Planning Guide for more information about settings.

Public Office Landscape® Power

**Dimensions**

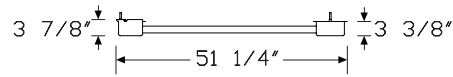
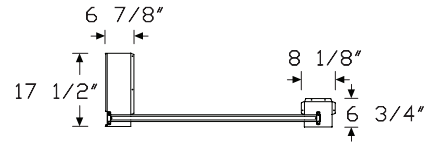

Short Bridge (29)

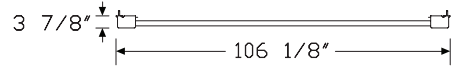

Long Bridge (87)

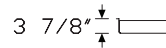
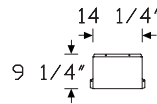

Jumper Tray (00)

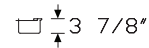
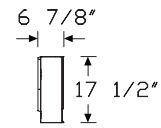

Receptacle Cover (NB)

**Specification Information**

Step 1.

**BVE09.**

Step 2. Length

- NB** receptacle cover only
- 00** jumper tray only
- 29** short bridge
- 87** long bridge

Step 3. Desk Bin Orientation

*For receptacle cover only (NB)*

- L** left bin
- R** right bin

*For jumper tray only (00), short bridge (29), or long bridge (87)*

- B** left bin and right bin

Prices for Steps 1-3.

	<b>B</b>	<b>L</b>	<b>R</b>
<b>BVE09. NB</b>	—	\$182	182
<b>00</b>	\$151	—	—
<b>29</b>	\$668	—	—
<b>87</b>	\$964	—	—

Step 4. Finish

- 91** white +\$0
- G1** graphite +\$0
- MS** metallic silver +\$0

# Single Café Table

BVT1.

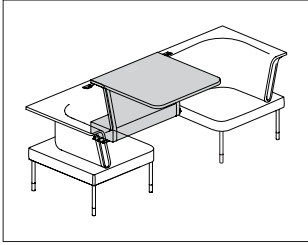

### Product Information

#### Description

This single café table comes with a laminate squared-edge work surface. It has a painted steel shelf, accepts a single 29"-wide screen, and is available with or without power access. Café table includes bag hook. Attachment hardware included.

#### Notes

Single café table cannot stand alone and must attach between 2 social chairs (BVS1N.).

Power access comes with single grommet to accommodate power at the surface. Grommet color is either graphite or white, matched to the work surface color.

To bring power to the surface of a single café table with power access, order Logic Mini, Grommet Mount (Y1414.) separately.

Bag hook color is matched to shelf color.

#### Dimensions

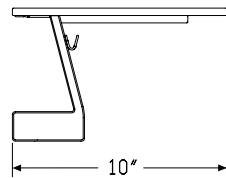
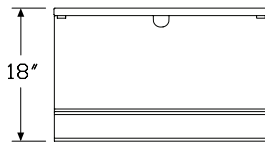
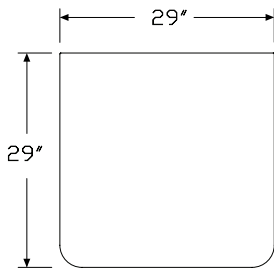

### Specification Information

#### Step 1.

**BVT1.**

#### Step 2. Depth

**29** 29" deep

#### Step 3. Power Access

**P** power access

**N** no power access

#### Step 4. Top Material

**L** high-pressure laminate top/thermoplastic edge

#### Prices for Steps 1-4.

	<b>L</b>
<b>BVT1. 29 P</b>	\$1356
<b>N</b>	\$1278

#### Step 5. Top Finish

<b>76</b>	light brown walnut	+\$0
<b>8Q</b>	folkstone grey	+\$0
<b>91</b>	white	+\$0
<b>98</b>	studio white	+\$0
<b>CL</b>	cool grey neutral	+\$0
<b>HF</b>	inner tone light	+\$0
<b>HM</b>	natural maple	+\$0
<b>HP</b>	light anigre	+\$0
<b>HX</b>	aged cherry	+\$0
<b>LBA</b>	clear on ash	+\$0
<b>LBR</b>	phantom ecru	+\$0
<b>LBS</b>	phantom cocoa	+\$0
<b>LBU</b>	medium matte walnut	+\$0
<b>LBV</b>	warm grey teak	+\$0
<b>LBB</b>	oak on ash	+\$0
<b>LBC</b>	walnut on ash	+\$0
<b>LBF</b>	neutral twill	+\$0
<b>LBJ</b>	graphite twill	+\$0
<b>LBN</b>	classic linen	+\$0
<b>LBQ</b>	white twill	+\$0
<b>LT</b>	light tone	+\$0
<b>LU</b>	soft white	+\$0
<b>WL</b>	sandstone	+\$0
<b>WN</b>	warm grey neutral	+\$0

## Single Café Table *continued*

Step 6. Edge Finish		
<b>76</b>	light brown walnut	+\$0
<b>8Q</b>	folkstone grey	+\$0
<b>91</b>	white	+\$0
<b>98</b>	studio white	+\$0
<b>BU</b>	black umber	+\$0
<b>CL</b>	cool grey neutral	+\$0
<b>HF</b>	inner tone light	+\$0
<b>HM</b>	natural maple	+\$0
<b>HP</b>	light anigre	+\$0
<b>HX</b>	aged cherry	+\$0
<b>LBA</b>	clear on ash	+\$0
<b>LBR</b>	phantom ecru	+\$0
<b>LBS</b>	phantom cocoa	+\$0
<b>LBU</b>	medium matte walnut	+\$0
<b>LBV</b>	warm grey teak	+\$0
<b>LBB</b>	oak on ash	+\$0
<b>LBC</b>	walnut on ash	+\$0
<b>LBF</b>	neutral twill	+\$0
<b>LBJ</b>	graphite twill	+\$0
<b>LBN</b>	classic linen	+\$0
<b>LBQ</b>	white twill	+\$0
<b>LU</b>	soft white	+\$0
<b>WL</b>	sandstone	+\$0
<b>WN</b>	warm grey neutral	+\$0

Step 7. Shelf Finish		
<b>MS</b>	metallic silver	+\$0
<b>G1</b>	graphite	+\$0
<b>91</b>	white	+\$0

Step 8. Grommet Selection		
<i>For power access (P)</i>		
<b>91</b>	white	+\$0
<b>G1</b>	graphite	+\$0

# Focus Café Table

BVT2.

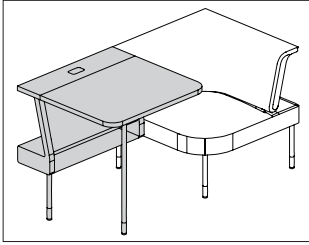

### Product Information

#### Description

The focus café table comes with a laminate squared-edge work surface. It has a painted steel shelf, accepts a single 29"-wide screen, accepts power accessories, and is available with or without power access. Stiffeners, and attachment hardware included.

#### Notes

Focus café table cannot stand alone and must attach to 1 social chair (BVS1N).

Power accessories in this application will comply with UL 962A. Power access comes with single grommet to accommodate power at the surface. Grommet color is either graphite or white, matched to the work surface color.

To bring power to the surface of a focus café table with power access, order Logic Mini, Grommet Mount (Y1414.) separately.

#### Dimensions

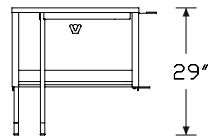
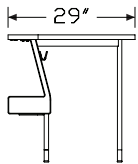
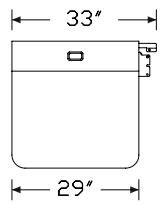

### Specification Information

#### Step 1.

**BVT2.**

#### Step 2. Depth

**29** 29" deep

#### Step 3. Power Access

**P** power access

**N** no power access

#### Step 4. Surface Application

**L** table left

**R** table right

#### Step 5. Top Material

**L** high-pressure laminate top/thermoplastic edge

#### Prices for Steps 1-5.

		LL	RL
<b>BVT2.</b>	<b>29 P</b>	\$1867	1867
	<b>N</b>	\$1756	1756

Step 6. Top Finish

<b>76</b>	light brown walnut	+\$0
<b>8Q</b>	folkstone grey	+\$0
<b>91</b>	white	+\$0
<b>98</b>	studio white	+\$0
<b>CL</b>	cool grey neutral	+\$0
<b>HF</b>	inner tone light	+\$0
<b>HM</b>	natural maple	+\$0
<b>HP</b>	light anigre	+\$0
<b>HX</b>	aged cherry	+\$0
<b>LBA</b>	clear on ash	+\$0
<b>LBR</b>	phantom ecru	+\$0
<b>LBS</b>	phantom cocoa	+\$0
<b>LBU</b>	medium matte walnut	+\$0
<b>LBV</b>	warm grey teak	+\$0
<b>LBB</b>	oak on ash	+\$0
<b>LBC</b>	walnut on ash	+\$0
<b>LBF</b>	neutral twill	+\$0
<b>LBJ</b>	graphite twill	+\$0
<b>LBN</b>	classic linen	+\$0
<b>LBQ</b>	white twill	+\$0
<b>LT</b>	light tone	+\$0
<b>LU</b>	soft white	+\$0
<b>WL</b>	sandstone	+\$0
<b>WN</b>	warm grey neutral	+\$0

Step 7. Edge Finish

<b>76</b>	light brown walnut	+\$0
<b>8Q</b>	folkstone grey	+\$0
<b>91</b>	white	+\$0
<b>98</b>	studio white	+\$0
<b>BU</b>	black umber	+\$0
<b>CL</b>	cool grey neutral	+\$0
<b>HF</b>	inner tone light	+\$0
<b>HM</b>	natural maple	+\$0
<b>HP</b>	light anigre	+\$0
<b>HX</b>	aged cherry	+\$0
<b>LBA</b>	clear on ash	+\$0
<b>LBR</b>	phantom ecru	+\$0
<b>LBS</b>	phantom cocoa	+\$0
<b>LBU</b>	medium matte walnut	+\$0
<b>LBV</b>	warm grey teak	+\$0
<b>LBB</b>	oak on ash	+\$0
<b>LBC</b>	walnut on ash	+\$0
<b>LBF</b>	neutral twill	+\$0
<b>LBJ</b>	graphite twill	+\$0
<b>LBN</b>	classic linen	+\$0
<b>LBQ</b>	white twill	+\$0
<b>LU</b>	soft white	+\$0
<b>WL</b>	sandstone	+\$0
<b>WN</b>	warm grey neutral	+\$0

Step 8. Leg Finish

<b>MS</b>	metallic silver	+\$0
<b>G1</b>	graphite	+\$0
<b>91</b>	white	+\$0

Step 9. Shelf Finish

---

*For metallic silver (MS)*

<b>MS</b>	metallic silver	+\$0
-----------	-----------------	------

---

*For graphite (G1)*

<b>G1</b>	graphite	+\$0
-----------	----------	------

---

*For white (91)*

<b>91</b>	white	+\$0
-----------	-------	------

Step 10. Grommet Selection

*For power access (P)*

<b>91</b>	white	+\$0
<b>G1</b>	graphite	+\$0

# Double Café Table

BVT3.

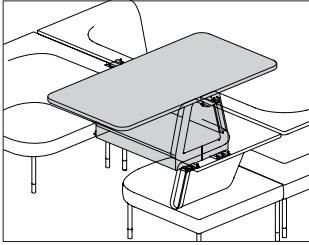

### Product Information

#### Description

This double café table comes with a laminate squared-edge work surface. It has a painted steel shelf and is available with or without power access. Attachment hardware included.

#### Notes

Double café table cannot stand alone and must attach between 4 social chairs (BVS1N.).

Power access comes with 2 grommets to accommodate power at the surface. Grommet color is either graphite or white, matched to the work surface color.

To bring power to the surface of a double café table with power access, order Logic Mini, Grommet Mount (Y1414.) separately.

#### Dimensions

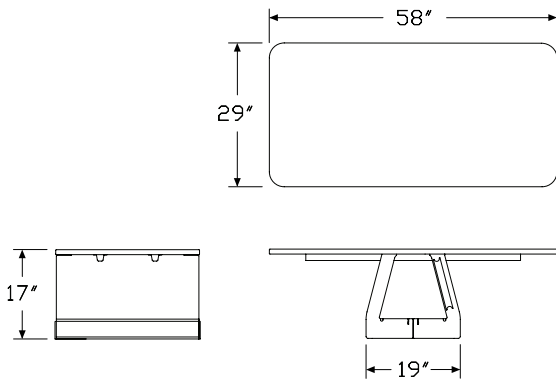

### Specification Information

#### Step 1.

**BVT3.**

#### Step 2. Depth

**29** 29" deep

#### Step 3. Power Access

**P** power access

**N** no power access

#### Step 4. Top Material

**L** high-pressure laminate top/thermoplastic edge

#### Prices for Steps 1-4.

		<b>L</b>
<b>BVT3.</b>	<b>29 P</b>	\$1608
	<b>N</b>	\$1481

#### Step 5. Top Finish

<b>76</b>	light brown walnut	+\$0
<b>8Q</b>	folkstone grey	+\$0
<b>91</b>	white	+\$0
<b>98</b>	studio white	+\$0
<b>CL</b>	cool grey neutral	+\$0
<b>HF</b>	inner tone light	+\$0
<b>HM</b>	natural maple	+\$0
<b>HP</b>	light anigre	+\$0
<b>HX</b>	aged cherry	+\$0
<b>LBA</b>	clear on ash	+\$0
<b>LBR</b>	phantom ecru	+\$0
<b>LBS</b>	phantom cocoa	+\$0
<b>LBU</b>	medium matte walnut	+\$0
<b>LBV</b>	warm grey teak	+\$0
<b>LBB</b>	oak on ash	+\$0
<b>LBC</b>	walnut on ash	+\$0
<b>LBF</b>	neutral twill	+\$0
<b>LBJ</b>	graphite twill	+\$0
<b>LBN</b>	classic linen	+\$0
<b>LBQ</b>	white twill	+\$0
<b>LT</b>	light tone	+\$0
<b>LU</b>	soft white	+\$0
<b>WL</b>	sandstone	+\$0
<b>WN</b>	warm grey neutral	+\$0

## Double Café Table *continued*

### Step 6. Edge Finish

<b>76</b>	light brown walnut	+\$0
<b>8Q</b>	folkstone grey	+\$0
<b>91</b>	white	+\$0
<b>98</b>	studio white	+\$0
<b>BU</b>	black umber	+\$0
<b>CL</b>	cool grey neutral	+\$0
<b>HF</b>	inner tone light	+\$0
<b>HM</b>	natural maple	+\$0
<b>HP</b>	light anigre	+\$0
<b>HX</b>	aged cherry	+\$0
<b>LBA</b>	clear on ash	+\$0
<b>LBR</b>	phantom ecru	+\$0
<b>LBS</b>	phantom cocoa	+\$0
<b>LBU</b>	medium matte walnut	+\$0
<b>LBV</b>	warm grey teak	+\$0
<b>LBB</b>	oak on ash	+\$0
<b>LBC</b>	walnut on ash	+\$0
<b>LBF</b>	neutral twill	+\$0
<b>LBJ</b>	graphite twill	+\$0
<b>LBN</b>	classic linen	+\$0
<b>LBQ</b>	white twill	+\$0
<b>LU</b>	soft white	+\$0
<b>WL</b>	sandstone	+\$0
<b>WN</b>	warm grey neutral	+\$0

### Step 7. Shelf Finish

<b>MS</b>	metallic silver	+\$0
<b>G1</b>	graphite	+\$0
<b>91</b>	white	+\$0

### Step 8. Grommet Selection

#### *For power access (P)*

<b>91</b>	white	+\$0
<b>G1</b>	graphite	+\$0

# Flat Edge Screen, Single Material BVP1.

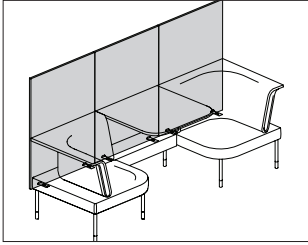

## Product Information

### Description

Screens attach to social chairs, sectional seats, desks, single café tables, peninsula tables, and freestanding bins. They are tackable with a single fabric covering the entire screen. Attachment is by a push-button mechanism.

### Notes

Screen attaches to a social chair (BVS1N.), sectional seat (BVS2N.), and single café table (BVT1.).

Applications with adjacent screens in a line or at a corner require alignment clip (BVP3.), ordered separately.

Screens accept whiteboard overhang (BVP4.), ordered separately.

Screen accepts Customer's Own Material (COM). Yardage is estimated for nondirectional 54"-wide fabrics.

### Height—Yardage

42—2.33

54—3.09

68—3.97

For information on multiple quantities or directional fabrics, contact COM Department. See Order Information in Appendices.

### Dimensions

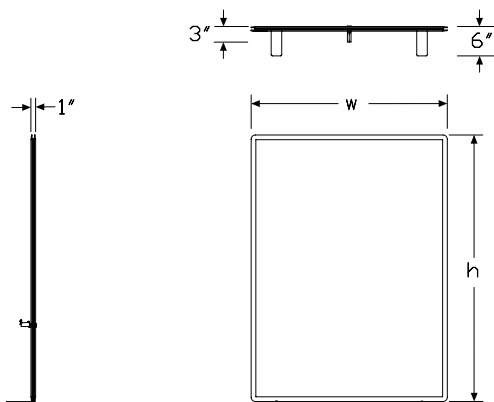

## Specification Information

### Step 1.

**BVP1.**

### Step 2. Width

**29** 29" wide

### Step 3. Height

**42** 42" high

**54** 54" high

**68** 68" high

### Step 4. Screen Material

**F** fabric

### Prices for Steps 1-4.

	<b>F</b>
<b>BVP1. 29 42</b>	\$936
<b>54</b>	\$1205
<b>68</b>	\$1432

### Step 5. Fabric

#### For 42" high (42) with fabric (F)

Price Category 1	+\$0
Price Category 2	+\$26
Price Category 3	+\$60
Price Category 4	+\$106
Price Category 5	+\$161
Price Category B	+\$83
Price Category C	+\$137
Price Category E	+\$244

#### For 54" high (54) with fabric (F)

Price Category 1	+\$0
Price Category 2	+\$34
Price Category 3	+\$79
Price Category 4	+\$132
Price Category 5	+\$224
Price Category B	+\$113
Price Category C	+\$188
Price Category E	+\$335

# Flat Edge Screen, Single Material

*continued*

---

*For 68" high (68) with fabric (F)*

Price Category 1	+\$0
Price Category 2	+\$43
Price Category 3	+\$103
Price Category 4	+\$169
Price Category 5	+\$281
Price Category B	+\$142
Price Category C	+\$235
Price Category E	+\$419

# Screen and Desktop Divider Alignment Kit

BVP3.

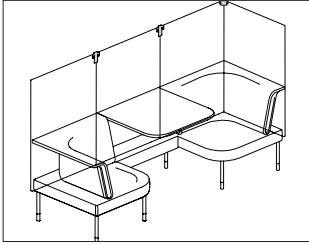

## Product Information

**Description**  
 This clip comes in 2 types to align screens and desktop dividers either in a line or at a corner. Clip finish is metallic silver (MS).

## Dimensions

## Specification Information

Step 1.

**BVP3.**

## Step 2. Application

- S** straight
- C** corner

## Prices for Steps 1-2.

<b>BVP3. S</b>	\$20
<b>C</b>	\$37

Public Office Landscape® Space Delineation

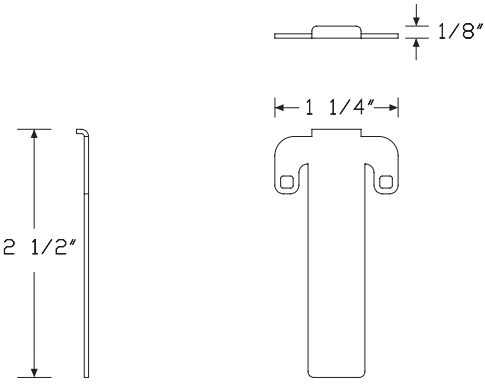

Straight

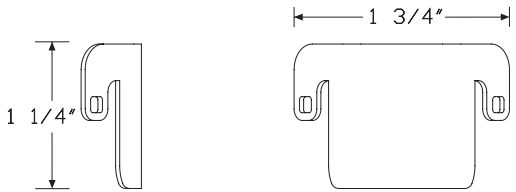
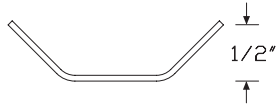

Corner

# Whiteboard Overhang

BVP4.

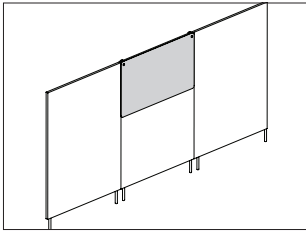

### Product Information

#### Description

This whiteboard hangs over a screen. It is 25" high when used on 54"-high screens, and 39" high when used on 68"-high screens. Available in 29" width to match screen width. Bracket finish is metallic silver (MS).

#### Notes

Available for 54"-high and 68"-high screens only.  
A screen can support only a single whiteboard overhang.

#### Dimensions

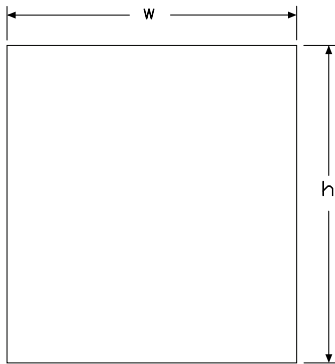

### Specification Information

#### Step 1.

**BVP4.**

#### Step 2. Width

**29** 29" wide

#### Step 3. Height

**54** 54" high

**68** 68" high

#### Prices for Steps 1-3.

	<b>54</b>	<b>68</b>
<b>BVP4. 29</b>	\$636	848



# Index by Product Name

<b>Public Office Landscape®</b>	
Chicago Power - Controlled Duplex	page(s) 23
Chicago Power - Duplex	22
Chicago Power - Junction Box	28
Controlled Receptacle Decal (12 per sheet)	24
Corded Power Solution	21
Desk and Bin Finishing Kit	14
Desk and Bin Ganging Plate	15
Double Café Table	36
Flat Edge Screen, Single Material	38
Focus Café Table	34
Legs	11
Logic G1200 Grommet Pass Thru	27
Logic HD Cable Manager	29
Logic Mini	25
Modular Power Controlled Duplex	19
Modular Power Duplex	18
Modular Power Entry, New York	16
Power Block	17
Power Block-to-Power Block Jumper	20
Power Bridge	30
Screen and Desktop Divider Alignment Kit	40
Seat Back Alignment Clip	13
Seat Back Ganging Kit	12
Sectional Seating	8
Single Café Table	32
Social Chair	5
Whiteboard Overhang	41



## Index by Product Number



BVD4. Desk and Bin Finishing Kit	page(s) 14
BVD5. Desk and Bin Ganging Plate	15
BVE02. Modular Power Entry, New York	16
BVE03. Power Block	17
BVE04. Modular Power Duplex	18
BVE04M Modular Power Controlled Duplex	19
BVE05. Power Block-to-Power Block Jumper	20
BVE06. Corded Power Solution	21
BVE07. Chicago Power - Duplex	22
BVE07M Chicago Power - Controlled Duplex	23
BVE08. Chicago Power - Junction Box	28
BVE09. Power Bridge	30
BVP1. Flat Edge Screen, Single Material	38
BVP3. Screen and Desktop Divider Alignment Kit	40
BVP4. Whiteboard Overhang	41
BVS1N. Social Chair	5
BVS2N. Sectional Seating	8
BVS3. Legs	11
BVS4. Seat Back Ganging Kit	12
BVS5. Seat Back Alignment Clip	13
BVT1. Single Café Table	32
BVT2. Focus Café Table	34
BVT3. Double Café Table	36
G9999. Controlled Receptacle Decal (12 per sheet)	24
Y1414. Logic Mini	25
Y1420. Logic G1200 Grommet Pass Thru	27
Y1424. Logic HD Cable Manager	29



# 20-Day or Less/Assigned Lead-Time Order Information

## 20-Day or Less and Assigned Lead-Time Programs

20-day or less and assigned lead-time products are designed for established Herman Miller dealers with pre-approved credit.

Products are distributed from multiple manufacturing facilities across the United States. All products and options not designated by an Assigned Lead-Time icon  will ship in 20 business days or less after being acknowledged by Herman Miller. Products and options designated by an  are on the assigned lead-time program and will ship in 20 days, less than 20 days, or more than 20 days from order acknowledgement.

## Ordering Procedure

Please place orders through Order Manager. If this is not available to you, place orders through mail or fax. Verbal purchase orders will not be accepted.

Order Entry fax number for Meridian®

Filing and Storage: (616) 846 9236.

Order Entry fax number for all other products:

(616) 654 3085.

For more information, contact your Customer Care representative at:  
(866) 854 3048 ext 3400.

## Shipments and Delivery

Per Herman Miller Terms and Conditions.

## Changes and Cancellation

Per Herman Miller Terms and Conditions.



# Customer's Own Material Order Information — Workspaces

## Customer's Own Material

### Program Overview

The Customer's Own Material (COM) program gives you the option of using textiles other than those listed. Herman Miller will test textiles for application to Herman Miller products and will process orders for those with approved COM textiles only. COM textiles are on assigned lead times.

Omni lists an overview of fabrics that have been tested and indicates whether or not they were approved for application to Herman Miller products.

Specific information on the terms and conditions, testing, approval, and ordering process for COM is listed below. Questions about the COM program and requests for assistance may be directed to your COM representative at:

(616) 654 3400

(866) 854 3048 ext 6543400

### Customer's Own Material Warranty

Herman Miller does not warrant COM textiles. COM textiles are tested for application only; they are not tested for performance. The Herman Miller warranty does apply to the underlying products.

Suppliers of COM textiles are responsible for color consistency within commercial tolerances, UV stability, and resistance to soiling and perspiration.

### Customer's Own Material Pricing

COM is a Category 1 fabric. There are no application charges for COM fabrics.

Ordering and payment for COM textile yardage are the responsibility of the customer and the textile supplier.

If desired, Herman Miller will purchase COM textiles directly from Maharam, Camira, C.F. Stinson, Guilford of Maine, Luna Textiles, Momentum Textiles and Ultrafabrics to simplify ordering and shipment. For this service, refer to the Supplier Connection program in Omni.

### Application Note

Herman Miller does not guarantee that Customer's Own Material (COM) fabric patterns will align across panels/tiles or from one screen to the next. We also do not guarantee that COM fabric designs will be positioned consistently in the same location across several panels, tiles, or screens.

### Textile Approval

1. Select a COM textile and a Herman Miller product.
2. If your textile does not show as tested in Omni, submit a request. You will be required to select a specific color of the textile and feature of the product to test, i.e., seat, back, etc.
3. Herman Miller will notify you of approval or disapproval within 4 days from receipt of the test yardage.

### Ordering Products with COM

1. Refer to the specific products to determine the yardage required for COM textiles.  
*Note: Yardage requirements are based on nondirectional, 54"-wide textiles. 66"-wide textiles are needed for application on 60"-wide products. Additional yardage may be needed due to the unique characteristics of a textile.*
2. Obtain the COM ID# in Omni. If the color you are ordering does not have a COM ID# assigned, click "Create ID".
3. Enter your order on Order Manager in Omni.
4. Upon receipt of your purchase order, Herman Miller will send you a PO acknowledgment.
5. Arrangements must be made for the textiles to be shipped from the supplier to Herman Miller for application to the Herman Miller products. Textiles must be tagged with the assigned identification number and the roll yardage quantity. See Omni for shipping procedures and current shipping addresses or contact a COM representative at (616) 654 3400 or (866) 854 3048 ext 6543400.  
Products will be scheduled for production when COM textiles are received at Herman Miller. Standard lead times in effect at that time will apply.

*Note: If textiles are to be purchased directly by Herman Miller through the Supplier Connection program, Herman Miller will handle the ordering and shipping process and will schedule your order for production upon receipt of your purchase order (dependent on textile availability). Refer to the Supplier Connection program for more information.*

# Customer's Own Material Order Information — Workspaces

*continued*

## Supplier Connection

### Program Overview

The Supplier Connection program is a service offered by Herman Miller to purchase approved COM textiles directly from Maharam, Camira, C.F. Stinson, Guilford of Maine, Luna Textiles, Momentum Textiles and Ultrafabrics. When you select a textile through this program, Herman Miller will facilitate the ordering, scheduling, and shipment of the textile directly with the supplier.

Suppliers included in the Supplier Connection program keep an active inventory of textiles that are pre-approved for application to Herman Miller products. Pre-approval applies only to the suitability of a textile for manufacturing and application to a Herman Miller product. Omni provides an overview of fabrics that have been tested and indicates whether or not they were approved for application to Herman Miller products.

Specific information on the terms and conditions, testing, approval, and ordering process for the Supplier Connection program is listed below. Questions and requests for assistance may be directed to your COM representative at:

(616) 654 3400

(866) 854 3048 ext 6543400

### Supplier Connection Warranty

Textiles purchased by Herman Miller through the Supplier Connection program are COM and are not warranted by Herman Miller. COM textiles are tested for application only; they are not tested for performance. The Herman Miller warranty does apply to the underlying products.

Suppliers of COM textiles are responsible for color consistency within commercial tolerances, UV stability, and resistance to soiling and perspiration.

### Supplier Connection Pricing

Textiles purchased by Herman Miller through the Supplier Connection program are COM. COM is a Category 1 fabric. There are no application charges for COM fabrics.

Payment for textiles purchased by Herman Miller through the Supplier Connection program is the responsibility of the customer or dealer. Herman Miller will invoice the order at a total product cost based on the supplier's price published at the time of the order.

### Textile Approval

1. Select a COM textile and a Herman Miller product.
2. If your textile does not show as tested in Omni, submit a request. You will be required to select a specific color of the textile and feature of the product to test, i.e., seat, back, etc.
3. Herman Miller will notify you of approval or disapproval within 4 days from receipt of the test yardage.

### Ordering Products with Supplier Connection COM

1. Identify and include the following information on your purchase order:
  - Product number and option
  - Herman Miller's COM identification number
2. Enter your order on Order Manager in Omni.
3. Upon receipt of the purchase order, Herman Miller will process your order and send you a PO acknowledgment. Herman Miller will determine the yardage required to produce your product and will order and schedule for delivery the required textile. Standard lead times in effect at the time the textile is allocated at the supplier will apply to products ordered through this program.

# Proprietary Textiles Application Chart – Workspaces

• Available

**A** Assigned lead-time textile.  
See page 2 for exception notes.

	Action Office® Panels/Connectors	Action Office B-Style Tackboards	Action Office/Ethospace E-Style Storage	Ethospace Tiles/Connectors	Ethospace/Canvas Office Landscape® Privacy Doors	Canvas Tiles/Extended Width Tiles/Channel Tiles	Canvas B-/E-Style Storage	Canvas Tackboards	Canvas Metal Desk Hutch Back Panel	Canvas Vista™ Movable Insert and Display Unit	OE1 Boundary Agile Wall Tile	OE1 Boundary Project Board and Screens	OE1 Nook Liner/Felt Screen Liner/Storage Trolley Liner	Overlay™ Performance Wall Cladding	Parl™ Screens/Flat Edge Screens/Channel Screens	Passport Work Table Screen	Renew™ Link Screens	Ambit™ Workspace Solutions Screen	Ambit Workspace Solutions Metal Screen Liner	Exclave® Tackable Boards and Stowage Tackable Backdrop	Exclave Video-Friendly Tackable Boards & Stowage Tackable Backdrop	Personal Side Screen	Tu® Wood Storage Cubby Tackboard	Seating
<b>Price Category 1</b>																								
COM Customer's Own Material <b>A</b>	1	1	1	1	1	1	1	1	1	1	1		1	1		1	1		1		1	1	1	
2V__ Chain	•	•	•	•	•	22	•	•	•	•	•		•	•		•	•						•	
8T__ Crossing (85__)	2	2	•	•	•	•	2	•	•		•	•	•	•		•	•		•	8		•	18	
3DE__ Dex	6	2	•	•	•	•	2	•	•		•	•	•	•		•	•		•		•	•	•	
95__ Gem	2	2	•	•	•	•	2	•	•				•	•			•					•	•	
2l__ Grasscloth	•	•	•	•	•	•	•	•	•		•		•	•		•	•					•	•	
1MN__ Monologue	2	2	•	•	•	•	2	•	•		•		•	•		•	•					•	•	
5T__ Resonance	•	•	•	•	•	•	•	•	•				•	•								•	•	
4SC__ Scatter	2	2				•		•	•		•		•	•		•	•		•		•	•	•	
3DN__ Scribe	•	•	•	•	•	•	•	•	•		•	•	•	•		•	•		•		•	•	•	
2M__ Silkworm	•	•	•	•	•	•	•	•	•				•	•			•					•	•	
22F__ Slant	6	•		•	•	•	•	•	•				•										•	
235__ Tailored	•	•	•	•	•	8	•	•	•				•										•	
1WS__ Whisper	2	2	•	•	•	•	2	•	•		•	•	•	•		•	•		•		•	•	•	
<b>Price Category 2</b>																								
3AR__ Aristo	2	2	•	•	•	•	2	•	•		•		•	•		•	•		•		•	•	•	
1CD__ Code	•	•	•	•	•	•	•	•	•				•	•					•				•	
51__ Cord	•	•	•	•	•	•	•	•	•														•	
92__ Crepe	2	•	•	•	•	•	•	•	•				•	•			•		•	8		•	•	
3EP__ Epic	2	2	•	•	•	•	2	•	•		•	•	•	•		•	•		•		•	•	•	
84__ Grosgrain	4	•	•	•	•	8	•		•				•				•				19		•	
4N__ Horizon	2	2	•	•	•	•	•	•	•				•	•			•					•	•	
1LM__ Loom	2	2	•		•	•	•	•	•		•	•	•	•		•	•		•				•	
1HA__ Medley	2	2	•	•	•	•	•	•	•		•	•	•	•		•	•		•	8		•	•	
4ME__ Mellow	2	2	•	•	•	•	2	•	•		•	•	•	•		•	•		•		•	•	•	
3RA__ Rain	•	•	•	•	•	•	•	•	•		•	•	•	•		•	•					•	•	
3SL__ Sequel			2				2																•	
4TE__ Terra	2	2	•	•	•	•	2	•	•		•	•	•	•		•	•		•		•	•	•	
3TW__ Twine	•	•	•	21	•	•	•	•	•		•	•	•	•		•	•		•		•	•	•	
8R__ Twist (55__)	5	2	•	•	•	•	2	•	•		•	•	•	•		•	•				•	•	18	

continued on next page

# Proprietary Textiles Application Chart — Workspaces

continued

	Action Office® Panels/Connectors	Action Office B-Style Tackboards	Action Office/Ethospace E-Style Storage	Ethospace Tiles/Connectors	Ethospace/Canvas Office Landscape® Privacy Doors	Canvas Tiles/Extended Width Tiles/Channel Tiles	Canvas B-/E-Style Storage	Canvas Tackboards	Canvas Metal Desk Hutch Back Panel	Canvas Vista™ Movable Insert and Display Unit	OE1 Boundary Agile Wall Tile	OE1 Boundary Project Board and Screens	OE1 Nook Liner/Felt Screen Liner/Storage Trolley Liner	Overlay™ Performance Wall Cladding	Pari™ Screens/Flat Edge Screens/Channel Screens	Passport Work Table Screen	Renew™ Link Screens	Ambit™ Workspace Solutions Screens	Ambit™ Workspace Solutions Metal Screen Liner	Exclave® Tackable Boards and Storage Tackable Backdrop	Exclave Video-Friendly Tackable Boards & Stowage Tackable Backdrop	Personal Side Screen	Tu® Wood Storage Cubby Tackboard	Seating
<b>Price Category 3</b>																								
47__ Ground Cloth®	•	•	•	•	•	•	•	•	•	•	•	•	•	•	•	•	•	•	•	•	•	•	•	
8L__ Savannah	•	•	•	•	•	•	•	•	•	•											∞	•	•	
8W__ Strands	•	•	•	•	•	•	•	•	•			•			•	•						•	•	
<b>Price Category 4</b>																								
3DM__ Daydream	2	2	•			•	2	•	•	•	•	•								•		•	•	
2X__ Glisten	•	•	•	•	•	•	•	•	•	•					•	•						•	•	
1HS__ Hush	•	•	•	•	•	•	•	•	•	•												•	•	
<b>Price Category 5</b>																								
14A__ Hopsak	2	2	•	•		•	2	•	•	•	•				•					•		•	•	
<b>Price Category 6</b>																								
No fabrics available at this time.																								

- 1 Refer to price book appendices and Omni for COM information.
- 2 Available on all products except 54" and 60" wide.
- 4 Not available on Action Office (AO®) acoustical panels.
- 5 (8R\_\_), (8T\_\_), (85\_\_), and (55\_\_) not available on AO acoustical panels and not available on 54"- or 60"-wide products.
- 6 Not available on Action Office (AO®) connectors, cable management, and spacers.
- 8 Available in select colors. See the "Proprietary Textile Colors — Workspaces" appendix.
- 18 Available on seating products in select colors. See the "Proprietary Textile Colors — Seating" appendix.
- 19 Not available in Grosgrain (84\_\_) fabric color 8405.
- 21 Not available on Ethospace connectors and cable management tiles.
- 22 Not available as railroaded application option for Chain (2V00) on Canvas Extended Width Tiles.

Application Note: Herman Miller cannot guarantee material/pattern alignment in adjacent products. For example, a fabric's pattern may not align from one screen to the next, or from one panel to the next.

# Proprietary Textile Colors – Workspaces

## Price Category 1

### Customer's Own Material

See Order Information in Appendices.  
Assigned lead-time textile. A

### Chain

66" wide	
100% recycled polyester	
2V01	Pearl
2V02	Oyster
2V03	Wheat
2V04	Linen
2V05	Wicker
2V06	Bamboo
2V07	Sage
2V08	Spring Wood
2V09	Iceberg

### Crossing

54" wide	
86% antimony-free polyester	
14% polyester	
8T03	Wicker *
8T04	Porcelain *
8T05	Warm Grey *
8T10	Tomato
8T13	Green Apple
8T16	Periwinkle
8T17	Cerulean
8T18	Indigo
8T19	Shale *
8T22	Tin *
8T23	Graphite
8T24	Black

### Crossing

For workspaces products only.  
54" wide  
86% antimony-free polyester  
14% polyester  
8501 Ivory \*  
8502 Oyster \*  
  
\* Colors available on Exclave®  
Video-friendly Tackable  
Boards and Stowage Tackable  
Backdrop

### Dex

54" wide	
100% recycled polyester	
3DE01	Frost
3DE02	Silver Pine
3DE03	Stone
3DE04	Shale
3DE05	Charcoal
3DE06	Gossamer
3DE07	Pine

### Gem

54" wide	
100% antimony-free polyester	
9502	Tangerine
9503	Red
9507	Twilight
9508	Bayou
9510	Berry Blue
9511	Aqua Green
9512	Green Apple
9514	Black
9515	Slate Grey
9516	Fog

### Grasscloth

66" wide	
100% recycled polyester	
2I01	Silver Birch
2I02	Pampas
2I03	Sedge
2I07	Lea
2I08	Taro
2I09	Steam Grey
2I13	Gravel

### Monologue

54" wide	
56% recycled polyester	
44% polyester	
1MN01	Linen
1MN02	Alabaster
1MN03	Truffle
1MN04	Folkstone
1MN05	Silver Pine
1MN06	Slate
1MN07	Seed
1MN08	Yellow Oxide
1MN09	Persimmon
1MN10	Tundra
1MN11	Meadow
1MN12	Blue Sky
1MN13	Blue Spruce
1MN14	Deep Sea

### Resonance

66" wide	
100% polyester	
5T04	Greige
5T05	Porcelain
5T06	Alabaster
5T15	Iris
5T28	Sugar
5T47	Tobacco
5T54	Saltbush
5T57	Seed
5T58	Sepia
5T60	Iceberg
5T65	Red
5T67	Boysenberry
5T68	Pistachio
5T69	Green Apple
5T71	Jade
5T72	Blue Green
5T74	Twilight

### Scatter

54" wide	
100% recycled polyester, with 26% ocean bound plastic	
4SC01	Alpine
4SC02	Fog
4SC03	Shale
4SC04	Persimmon
4SC05	Red Violet
4SC06	Lime Zest
4SC07	Olive
4SC08	Glacier
4SC09	Blue Sky
4SC10	Lagoon
4SC11	Slate Grey
4SC12	Blue Black

Price category 1 continued on next page

# Proprietary Textile Colors — Workspaces

continued

## Price Category 1

continued

### Scribe

54" wide  
100% recycled polyester  
with 53% ocean bound plastic

3DN01	Spring Wood
3DN02	Poplar
3DN03	Pewter
3DN04	Deep Sea
3DN05	Fir
3DN06	Nutmeg

### Silkworm

66" wide  
58% recycled polyester  
42% polyester

2M01	Cocoon
2M02	Pongee
2M03	Saffron
2M04	Tussah
2M05	Ceylon
2M06	Jasmine
2M07	Shale
2M08	Monsoon

### Slant

66" wide  
51% polyester  
49% recycled polyester

22F04	Pesto
22F06	Neptune
22F07	Blueberry
22F10	Pumpkin
22F12	Silver Birch
22F13	Bluestone
22F15	Shale

### Tailored

54" wide  
56% polyester  
44% recycled polyester

23501	Studio White *
23502	Sugar
23503	Tomato
23504	Orchid
23505	Boysenberry
23506	Chive
23507	Bluegrass
23508	Cobalt
23509	Cadet
23510	Fog
23511	Graphite
23512	Black
23513	Coffee

\* Color not available on Canvas Tiles.

### Whisper

54" wide  
73% recycled polyester  
27% polyester,  
with 11.3% ocean bound plastic

1WS01	Sand Dollar
1WS02	Pebble
1WS03	Silver Birch
1WS04	Iceberg
1WS05	Silver Pine
1WS06	Carbon
1WS07	Cumin
1WS08	Adobe
1WS09	Strawberry
1WS10	Blush
1WS11	Eggplant
1WS12	Willow
1WS13	Sea Grass
1WS14	Pool
1WS15	Blueberry
1WS16	Glacier
1WS17	Grey
1WS18	Canyon

## Price Category 2

### Aristo

54" wide  
88% recycled polyester  
12% polyester  
Acrylic backing

3AR01	Forest Moss
3AR02	Light Brindle
3AR03	Mink
3AR04	Copper
3AR05	Adobe
3AR06	Cherry
3AR07	Lilac
3AR08	Green Apple
3AR09	Surf
3AR10	Waterfall
3AR11	Cadet
3AR12	Tin
3AR13	Pewter
3AR14	Grey Brindle
3AR15	Grey Black

### Code

66" wide  
100% Repreve recycled polyester

1CD01	Linen
1CD02	Khaki
1CD03	Iceberg
1CD04	Zinc
1CD05	Blue Black

### Cord

66" wide  
51% antimony-free polyester  
49% polyester

5101	Ivory
5102	White Ash
5103	Linen
5104	Bamboo
5105	Sepia
5107	Sesame
5109	Bayou
5111	Spring Wood
5112	Summer White

### Crepe

54" wide  
100% recycled polyester,  
with 43.6% ocean bound plastic

9201	Licorice
9203	Smoke
9207	Cherry
9223	Cadet
9241	Beachglass
9249	Stone *
9251	Fog *
9252	Slate Grey
9261	Shale
9262	Graphite
9265	Mineral
9266	Persimmon
9267	Juniper
9268	Glacier
9269	Cascade
9270	Navy

\* Colors available on Exclave® Video-friendly Tackable Boards and Stowage Tackable Backdrop.

Price category 2 continued on next page

# Proprietary Textile Colors – Workspaces

continued

## Price Category 2

continued

Epic	
54" wide	
56% recycled polyester	
44% polyester	
Acrylic backing	
3EP01	Alabaster
3EP02	Smoke
3EP03	Falcon
3EP04	Citrus Spring
3EP05	Copper
3EP06	Urban Orange
3EP07	Poppy
3EP08	Wild Plum
3EP09	Sugar Plum
3EP10	Clover
3EP11	Loden
3EP12	Everglade
3EP13	Mist
3EP14	Peacock
3EP15	Cadet
3EP16	Indigo
3EP17	Spring Wood
3EP18	Grey Brindle
3EP19	Seed
3EP20	Carbon Dark

Grosgrain	
66" wide	
100% recycled polyester	
8402	White Ash
8404	Khaki
8405	Oyster *
8408	Spa Blue
8409	Bud
8411	Bayou
8412	Tin

\* Color not available on Canvas Dock Mounted Screens and Thrive® Personal Side Screen.

Horizon	
54" wide	
65% antimony-free polyester	
35% polyester	
4N01	Rye Grass
4N02	Sugar Pine
4N03	Silver Pine
4N04	White Ash
4N05	Spring Wood
4N06	Tamarack
4N07	Mushroom
4N08	Haystack
4N09	Oat Grass
4N10	Forest Moss
4N11	Hickory
4N12	Beech Nut
4N13	Pine Cone
4N14	Poplar
4N15	Elderberry

Loom	
54" wide	
100% polyester	
1LM01	Linen
1LM03	Brick and Mortar
1LM04	Salt and Pepper
1LM05	Black
1LM08	Wild Berry
1LM09	Loden
1LM10	Jade
1LM11	Deep Sea

Medley	
54" wide	
100% polyester	
1HA01	Stone *
1HA02	Trail
1HA03	Charcoal
1HA04	Cinder
1HA05	Citrus
1HA06	Papaya
1HA07	Chutney
1HA08	Tundra
1HA09	Feather Grey *
1HA10	Chartreuse
1HA11	Loden
1HA12	Peacock
1HA13	Bayou *
1HA14	Blue Grotto
1HA15	Blueberry
1HA22	Khaki
1HA23	Pewter
1HA24	Yellow Oxide
1HA25	Vintage Rose
1HA26	Raspberry
1HA27	Acai Berry

\* Colors available on Exclave®  
Video-friendly Tackable  
Boards and Stowage Tackable  
Backdrop

Mellow	
54" wide	
100% recycled polyester, with 16% ocean bound plastic	
4ME01	Mineral
4ME02	Pewter
4ME03	Wisteria
4ME04	Olive
4ME05	Glacier
4ME06	Oceanside
4ME07	Charcoal

Rain	
66" wide	
100% recycled polyester	
3RA01	Iceberg
3RA02	Frost
3RA03	Pewter
3RA04	Graphite
3RA05	Warm White
3RA06	Linen
3RA07	Rye
3RA08	Light Brindle

Sequel	
54" wide	
100% vinyl	
100% polyester knit backing	
Resilience® finish	
3SL01	White
3SL02	Pebble
3SL03	Mushroom
3SL04	Stone
3SL05	Chestnut
3SL06	Rattan
3SL07	Black Cherry
3SL08	Tundra
3SL09	Seal
3SL10	Blue Fog
3SL11	Folkstone
3SL12	Shale
3SL13	Slate Grey
3SL14	Charcoal
3SL15	Carbon Dark

Price category 2 continued on next page

# Proprietary Textile Colors — Workspaces

continued

## Price Category 2

continued

Terra	
54" wide	
100% post-consumer recycled biodegradable polyester *	
4TE01	Spring Wood
4TE02	Zinc
4TE03	Pine Cone
4TE04	Charcoal

\* 1% biodegradation in 1,278 days under ASTM D5511 conditions. No evidence of further degradation.

Twine	
66" wide	
100% recycled polyester	
3TW01	Silver Birch
3TW02	Ivory
3TW03	Alabaster
3TW04	Bamboo
3TW05	Iceberg
3TW06	Charcoal
3TW07	Feather Grey
3TW08	Shale

Twist	
54" wide	
80% antimony-free polyester	
13% recycled polyester	
7% polyester	
8R05	Wicker
8R10	Poppy
8R14	Tin
8R15	Shale
8R16	Graphite
8R17	Birch
8R18	Sepia
8R22	Blueberry
8R23	Green Apple
8R26	Gunmetal
8R27	Cinder
8R28	Citrus
8R29	Pekoe
8R30	Tangerine
8R31	Red Plum
8R32	Wisteria
8R33	Forest
8R34	Jade Dark
8R35	Waterfall
8R36	Midnight Blue
8R37	Carbon Dark

Twist	
For workspaces products only.	
54" wide	
80% antimony-free polyester	
13% recycled polyester	
7% polyester	
5S01	Pearl
5S02	Ivory
5S03	Oyster

## Price Category 3

Ground Cloth®	
66" wide	
100% polyester	
4701	Vapor Grey
4721	Warm White *
4722	Fog *
4723	Straw *
4724	Red Orange *
4725	Wild Berry *
4726	Green Apple *
4727	Caribbean *
4728	Midnight *
4729	Cappuccino *

\* Colors available on Exclave®  
Video-friendly Tackable  
Boards and Stowage Tackable  
Backdrop

Savannah	
66" wide	
76% recycled polyester	
24% polypropylene	
8L02	Oyster
8L04	Jute
8L05	Bamboo
8L06	Metal
8L07	Linen
8L10	Frost
8L11	Shale

Strands	
66" wide	
100% recycled polyester	
8W01	Pebble
8W02	Porcelain
8W03	Taupe
8W04	Honey
8W05	Khaki
8W06	Rye
8W07	Wicker
8W08	Tin
8W09	Cool Grey

## Price Category 4

Daydream	
54" wide	
48% wool	
41% recycled polyester	
9% nylon	
2% polyester	
3DM01	Rye Grass
3DM02	Silver Birch
3DM03	Pewter
3DM04	Graphite
3DM05	Black
3DM06	Lemongrass
3DM07	Permission
3DM08	Juniper
3DM09	Sea Grass
3DM10	Nightfall

Glisten	
66" wide	
84% polyester	
16% recycled polyester	
2X02	Rye
2X05	Iceberg
2X09	Pewter
2X10	Ash

Hush	
66" wide	
80% polyester	
20% viscose	
1HS01	Canyon
1HS02	Pesto
1HS03	Bayou
1HS04	Greystone
1HS05	Charcoal
1HS06	Rye Grass
1HS07	Cool Grey
1HS08	Dark Grey
1HS09	Aqua Green
1HS10	Nightfall

# Proprietary Textile Colors — Workspaces

*continued*

---

## Price Category 5

<b>Hopsak</b>	
56" wide	
100% recycled polyester	
14A20	Black
14A22	Raw Umber Dark
14A26	Grey Blue Dark
14A30	Sepia Dark
14A38	Emerald Dark
14A39	Yellow Dark
14A40	Orange
14A41	Sienna
14A42	Olive Green Dark
14A43	Crimson
14A44	Crimson Dark Dark
14A45	Violet Dark
14A46	Pink Dark Dark
14A47	Ultramarine Dark
14A48	Cobalt Blue
14A49	Terra Cotta
14A50	Ochre Dark



# Customer's Own Material/Customer's Own Leather Order Information — Seating

## Packaging

Packaging varies according to individual product. A surcharge may be added for special packaging requests. Contact Customer Care for specific information.

## Customer's Own Material/Customer's Own Leather

### Program Overview

The Customer's Own Material (COM) and Customer's Own Leather (COL) program gives you the option of using textiles other than those listed. Herman Miller will test textiles for application to Herman Miller products and will process orders for those with approved COM/COL textiles only. COM/COL are assigned lead-time textiles.

Omni lists an overview of fabrics and leathers that have been tested and indicates whether or not they were approved for application to Herman Miller products.

Specific information on the terms and conditions, testing, approval, and ordering process for COM/COL is listed below. Questions about the COM/COL program and requests for assistance may be directed to your COM representative at:

(616) 654 3400

(866) 854 3048 ext 6543400

### Customer's Own Material/Customer's Own Leather Warranty

Herman Miller does not warrant COM/COL textiles. COM/COL textiles are tested for application only; they are not tested for performance. The Herman Miller warranty does apply to the underlying products.

Suppliers of COM/COL textiles are responsible for color consistency within commercial tolerances, UV stability, and resistance to soiling and perspiration.

### Customer's Own Material/Customer's Own Leather Pricing

COM is a Category 1 fabric. There are no application charges for COM fabrics. COL is a Category 7 textile; refer to prices on specific products to determine the application charge.

Ordering and payment for COM/COL textile yardage are the responsibility of the customer and the textile supplier.

If desired, Herman Miller will purchase COM textiles directly from Maharam, Camira, C.F. Stinson, Guilford of Maine, Luna Textiles, Momentum Textiles and Ultrafabrics to simplify ordering and shipment. For this service, refer to the Supplier Connection program.

## Textile Approval

1. Select a COM textile and a Herman Miller product.
2. If your textile does not show as tested in Omni, submit a request. You will be required to select a specific color of the textile and feature of the product to test, i.e., seat, back, etc.
3. Herman Miller will notify you of approval or disapproval within 4 days from receipt of the test yardage.

## Ordering Products with COM/COL

1. Refer to the specific products to determine the yardage required for COM/COL textiles.  
*Note: Additional yardage may be needed due to the unique characteristics of a textile.*
2. Obtain the COM ID# in Omni. If the color you are ordering does not have a COM ID# assigned, click "Create ID".
3. Enter your order on Order Manager in Omni.
4. Upon receipt of your purchase order, Herman Miller will send you a PO acknowledgment.
5. Arrangements must be made for the textiles to be shipped from the supplier to Herman Miller for application to the seating products. Textiles must be tagged with the assigned identification number and the roll yardage quantity. See Omni for shipping procedures and current shipping addresses or contact a COM representative at  
(616) 654 3400 or (866) 854 3048 ext 6543400.

Products will be scheduled for production when COM/COL textiles are received at Herman Miller. Standard lead times in effect at that time will apply.

*Note: If textiles are to be purchased directly by Herman Miller through the Supplier Connection program, Herman Miller will handle the ordering and shipping process and will schedule your order for production upon receipt of your purchase order (dependent on textile availability). Refer to the Supplier Connection program for more information.*

# Customer's Own Material/Customer's Own Leather Order Information — Seating

continued

## Supplier Connection

### Program Overview

The Supplier Connection program is a service offered by Herman Miller to purchase approved COM textiles directly from Maharam, Camira, C.F. Stinson, Guilford of Maine, Luna Textiles, Momentum Textiles and Ultrafabrics. When you select a textile through this program, Herman Miller will facilitate the ordering, scheduling, and shipment of the textile directly with the supplier.

Suppliers included in the Supplier Connection program keep an active inventory of textiles that are pre-approved for application to Herman Miller products. Pre-approval applies only to the suitability of a textile for manufacturing and application to a Herman Miller product. Omni provides an overview of fabrics that have been tested and indicates whether or not they were approved for application to Herman Miller products.

Specific information on the terms and conditions, testing, approval, and ordering process for the Supplier Connection program is listed below. Questions and requests for assistance may be directed to your COM representative at:

(616) 654 3400

(866) 854 3048 ext 6543400

### Supplier Connection Warranty

Textiles purchased by Herman Miller through the Supplier Connection program are COM and are not warranted by Herman Miller. COM textiles are tested for application only; they are not tested for performance. The Herman Miller warranty does apply to the underlying products.

Suppliers of COM textiles are responsible for color consistency within commercial tolerances, UV stability, and resistance to soiling and perspiration.

### Supplier Connection Pricing

Textiles purchased by Herman Miller through the Supplier Connection program are COM. COM is a Category 1 fabric. There are no application charges for COM fabrics.

Payment for textiles purchased by Herman Miller through the Supplier Connection program is the responsibility of the customer or dealer. Herman Miller will invoice the order at a total product cost based on the supplier's price published at the time of the order.

### Textile Approval

1. Select a COM textile and a Herman Miller product.
2. If your textile does not show as tested in Omni, submit a request. You will be required to select a specific color of the textile and feature of the product to test, i.e., seat, back, etc.
3. Herman Miller will notify you of approval or disapproval within 4 days from receipt of the test yardage.

### Ordering Products with Supplier Connection COM

1. Identify and include the following information on your purchase order:
  - Product number and option
  - Herman Miller's COM identification number
2. Enter your order on Order Manager in Omni.
3. Upon receipt of the purchase order, Herman Miller will process your order and send you a PO acknowledgment. Herman Miller will determine the yardage required to produce your product and will order and schedule for delivery the required textile. Standard lead times in effect at the time the textile is allocated at the supplier will apply to products ordered through this program.

# Proprietary Textiles Application Chart — Seating

• Available

[A] Assigned lead-time textile.

[N] Non-woven textile.

See following page for exception notes.

## Price Category 1

	Aeron® Chairs	Cosm™ Chairs	Mirra® 2 Chairs/Stools	Embody® Chairs	Fuld Nesting Chairs	Sayl® Work Chairs/Stools	Sayl Side Chairs	Setu® Chairs/Stools	Zeph™ Chairs	Verus™ Work Chairs/Stools Back	Verus Work Chairs/Stools Seat	Verus Side Chairs Back	Verus Side Chairs Seat	Verus Plus Chairs	Aside® Chairs	Caper® Chairs/Stools	Lino™ Chairs Back	Lino Chairs Seat	OE1 Storage Trolley Cushion Top	Public Office Landscape® Back	Public Office Landscape Seat	Plex® Lounge Furniture	Swoop™ Lounge Seating - Fully Upholstered	Swoop Lounge Seating - Plywood	Valor™ Seating	Eames® Tandem Sling Seating	Cushion Tops	Workspaces	
COM Customer's Own Material [A]						1	1			1	1	1	1	1	1			1	1		1	1	1	1	1	1	1	1	1
231__ 8Z Pellicle®	•																												
1A7__ AireWeave™ 2			•																										
8T__ Crossing								•							•				•				•	•			•	•	
3DE__ Dex						•	•	•		•	•	•	•	•	•				•		•	19	•		•		•	•	
4RM__ Duo																	•												
6V__ Flexnet™																•													
95__ Gem								•							•				•			•	•				•	•	
845__ Intercept			•																										
365__ Interweave 2										•		•																	
4W__ Lyris 2™								•																					
1MN__ Monologue						24	22	•		•	•	•						•	•		•	•	•	•	•	•	•	•	
5H2__ Ripple 3D Knit									•																				
5H1__ Splash 3D Knit									•																				
4SC__ Scatter						•	•	•		•	•	•	•	•	•			•	•		•	•	•	•			•	•	
3DN__ Scribe						21	22	•		•		•	•	•	•			•	•		•					•		•	
3DK__ Stretch Knit [A]						21																							
235__ Tailored						•	•	•		•	•	•	•		•			•		•	23				•		7	•	
9NK__ Tuck 3D Knit					•																								
1WS__ Whisper						24	•	•		•	•	•	•	•	•			•	•		•	•	•	•	•	•	•	•	

## Price Category 2

3AR__ Aristo						•	•	•		•	•	•	•	•	•			•	•	•	•	•	•	•	•	•	•	•
92__ Crepe						•	•	•		•	•	•	•	•	•			•	•	•	•	•	•	•	•	•	•	•
3EP__ Epic						•	•			•	•	•	•	•	•			•	•	•	•	•	•	•	•	•	•	•
1LM__ Loom						•	•			•	•	•	•	•	•			•	•	•	•	•	•	•	•	•	•	•
1MV__ Marvel [N]						21	22	•										•							•		•	•
1HA__ Medley				•		•	22			•	•	•	•	•	•			•	•	•	•	•	•	•	•	•	•	•
4ME__ Mellow						•	22	•		•	•	•	•	•	•			•	•	•	•	•	•	•	•	•	•	•
30__ Rhythm				23		•	•			•	•	•	•	•	•			•	•	•	•	•	•	•	•	•	•	•
3SL__ Sequel [N]						•	•	•		•	•	•	•	•	•	8		•	•	•	•	•	•	•	•	•	•	•
4TE__ Terra						•	22			•	•	•	•	•	•			•	•	•	•	•	•	•	•	•	•	•
8R__ Twist						•	•	•		•	•	•	•	•	•			•	•	•	•	•	•	•	•	•	•	•

## Price Category 3

3AC__ Ace						21	•			•	•	•	•	•	8			•	•	•	19			•		•	•	
4LN__ Landing [N]																										•		
8M__ Latitude™				23		•	•											•					•	•				

## Price Category 4

3DM__ Daydream						21	•	•		•		•	•	•				•	•			•	•	•			•	•
1DL__ Dialogue																				•								
1A9__ Network																					•							
3SY__ Sync				•		•	•	•		•	•	•	•	•	•			•		•	•	•	•	•	•	•	•	•

continued on next page

# Proprietary Textiles Application Chart — Seating continued

• Available

[A] Assigned lead-time textile.

[N] Non-woven textile.

See below for exception notes.

	Aeron® Chairs	Cosm™ Chairs	Mirra® 2 Chairs/Stools	Embody® Chairs	Fuld Nesting Chairs	Sayl® Work Chairs/Stools	Sayl Side Chairs	Setu® Chairs/Stools	Zeph™ Chairs	Verus™ Work Chairs/Stools Back	Verus Work Chairs/Stools Seat	Verus Side Chairs Back	Verus Side Chairs Seat	Verus Plus Chairs	Aside® Chairs	Caper® Chairs/Stools	Lino™ Chairs Back	Lino Chairs Seat	OE1 Storage Trolley Cushion Top	Public Office Landscape® Back	Public Office Landscape Seat	Plex® Lounge Furniture	Swoop™ Lounge Seating - Fully Upholstered	Swoop Lounge Seating - Plywood	Valor™ Seating	Eames® Tandem Sling Seating	Cushion Tops	Workspaces
<b>Price Category 5</b>																												
3CY__Cozy						•	•	•		•	•	•	•	•	•			•				•	•	•	•	•	•	•
14A__Hopsak						•	•	•		•	•	•	•	•	•			•	•		•	•	•	•	•	•	•	•
3SU__Summit [N]						•	•	•		•	•	•	•	•				•			•	•	•	•	•	•	•	•
<b>Price Category 6</b>																												
35__ Balance				•																								
<b>Price Category 7</b>																												
COL Customer's Own Leather [A]	1														8			1									1	
<b>Price Category 8</b>																												
No fabrics available at this time																												
<b>Price Category 9</b>																												
21__ Leather [N]	23														8		•	•						•			•	

Application Note: Herman Miller cannot guarantee material/pattern alignment in adjacent products. For example, a fabric's pattern may not align from one pedestal cushion top to the next, or from one chair to another.

- 1 Refer to price book appendices and Omni for COM/COL information.
- 7 Available on 1" Cushion Tops only.
- 8 Only available on the Aside nonupholstered outer back option (PB).
- 9 Available on Valor upholstered seat only.
- 19 Available on Plex seat only.
- 21 Not available on Sayl upholstered back work chairs.
- 22 Not available on Sayl side chairs with upholstered backs.
- 23 Available in select colors. Refer to "Proprietary Textile Colors-Seating" for color offering.
- 24 Not available on Sayl upholstered High-Back Work Chairs.

# Proprietary Textile Colors — Seating

## Price Category 1

### Customer's Own Material

See Order Information in Appendices.  
Assigned lead-time textile. A

### 8Z Pellicle®

For New Aeron® Chairs  
56% elastomeric  
44% polyester

23101 Mineral  
23102 Carbon  
23103 Graphite

### AireWeave™ 2

For Mirra® 2 Chairs  
67% elastomeric  
33% antimony-free polyester

1A701 Alpine  
1A702 Slate Grey  
1A703 Graphite  
1A704 Lime Green  
1A705 Cappuccino  
1A706 Urban Orange  
1A707 Dark Turquoise  
1A708 Twilight

### Crossing

54" wide  
86% antimony-free polyester  
14% polyester

8T03 Wicker  
8T04 Porcelain  
8T05 Warm Grey  
8T10 Tomato  
8T13 Green Apple  
8T16 Periwinkle  
8T17 Cerulean  
8T18 Indigo  
8T19 Shale  
8T22 Tin  
8T23 Graphite  
8T24 Black

### Dex

54" wide  
100% recycled polyester

3DE01 Frost  
3DE02 Silver Pine  
3DE03 Stone  
3DE04 Shale  
3DE05 Charcoal  
3DE06 Gossamer  
3DE07 Pine

### Duo

For Lino™ Chairs  
52% polyester  
48% elastomeric

4RM01 Mineral  
4RM02 Poppy  
4RM03 Green Leaf  
4RM04 Jade  
4RM05 Shadow  
4RM06 Graphite

### Flexnet™

For Caper® Chairs  
69% elastomeric  
31% polyester

6V01 Black  
6V02 Silver Grey

### Gem

54" wide  
100% antimony-free polyester

9502 Tangerine  
9503 Red  
9507 Twilight  
9508 Bayou  
9510 Berry Blue  
9511 Aqua Green  
9512 Green Apple  
9514 Black  
9515 Slate Grey  
9516 Fog

### Intercept

For Cosm™ Chairs  
60% elastomeric  
40% polyester

84501 Graphite  
84502 Carbon  
84503 Mineral  
84504 Nightfall  
84505 Glacier  
84506 Canyon

### Interweave 2

For Verus™ Chairs  
65% elastomeric  
35% polyester

36501 Iceberg  
36502 Poppy  
36503 Beachglass  
36504 Blue Grotto  
36505 Slate  
36506 Shale

### Lyris 2™

For Setu® Chairs  
74% elastomeric  
26% polyester

4W21 Alpine  
4W22 Mango  
4W23 Chartreuse  
4W25 Berry Blue  
4W26 Slate Grey  
4W28 Chino  
4W29 Rattan  
4W30 Java  
4W31 Graphite

### Monologue

54" wide  
56% recycled polyester  
44% polyester

1MN01 Linen  
1MN02 Alabaster  
1MN03 Truffle  
1MN04 Folkstone  
1MN05 Silver Pine  
1MN06 Slate

### Monologue *continued*

1MN07 Seed  
1MN08 Yellow Oxide  
1MN09 Persimmon  
1MN10 Tundra  
1MN11 Meadow  
1MN12 Blue Sky  
1MN13 Blue Spruce  
1MN14 Deep Sea

### Ripple 3D Knit

Available only on Zeph™ Chairs.  
knit to size  
51% post-consumer recycled polyester  
48% polyester  
1% lycra

5H201 Black  
5H202 Carbon  
5H203 Alpine  
5H204 Silt  
5H205 Tea Rose  
5H206 Cocoa  
5H207 Persimmon  
5H208 Blaze  
5H209 Cayenne  
5H210 Falcon  
5H211 Mustard Seed  
5H212 Patina  
5H213 Olive  
5H214 Moss  
5H215 Aloe  
5H216 Glacier  
5H217 Ultramarine  
5H218 Nightfall  
5H219 Bluebell  
5H220 Boysenberry  
5H221 Nightfall/Bluebell  
5H222 Patina/Alpine  
5H223 Cayenne/Glacier  
5H224 Tea Rose/Olive  
5H225 Silt/Blaze

*Price category 1 continued on next page*

# Proprietary Textile Colors — Seating

continued

## Price Category 1

continued

Appendix: Proprietary Textile Colors — Seating

Scatter	
54" wide	
100% recycled polyester, with 26% ocean bound plastic	
4SC01	Alpine
4SC02	Fog
4SC03	Shale
4SC04	Persimmon
4SC05	Red Violet
4SC06	Lime Zest
4SC07	Olive
4SC08	Glacier
4SC09	Blue Sky
4SC10	Lagoon
4SC11	Slate Grey
4SC12	Blue Black

Scribe	
54" wide	
100% recycled polyester with 53% ocean bound plastic	
3DN01	Spring Wood
3DN02	Poplar
3DN03	Pewter
3DN04	Deep Sea
3DN05	Fir
3DN06	Nutmeg

Splash 3D Knit	
Available only on Zeph™ Chairs. knit to size	
54% post-consumer recycled polyester 44% polyester 2% lycra	
5H101	Black
5H102	Carbon
5H103	Alpine
5H104	Silt
5H105	Tea Rose
5H106	Cocoa
5H107	Persimmon
5H108	Blaze
5H109	Cayenne
5H110	Falcon

Splash 3D Knit continued	
5H111	Mustard Seed
5H112	Patina
5H113	Olive
5H114	Moss
5H115	Aloe
5H116	Glacier
5H117	Ultramarine
5H118	Nightfall
5H119	Bluebell
5H120	Boysenberry

Stretch Knit	
Assigned lead-time textile. <span style="border: 1px solid black; padding: 0 2px;">A</span>	
Available only on Sayl® Suspension Back Work Chairs 97% polyester, 3% spandex	

3DK01	Fog
3DK02	Slate Grey
3DK03	Java
3DK04	Black
3DK05	Red
3DK06	Green Apple
3DK07	Berry Blue

Tailored	
54" wide	
56% polyester 44% recycled polyester	
23501	Studio White *
23502	Sugar *
23503	Tomato
23504	Orchid
23505	Boysenberry
23506	Chive
23507	Bluegrass
23508	Cobalt
23509	Cadet
23510	Fog
23511	Graphite
23512	Black
23513	Coffee

\* Colors not available on  
Plex™ Lounge Furniture.

Tuck 3D Knit	
Available only on Fuld Nesting Chairs. knit to size	
56% polyester 44% recycled polyester	
9NK01	Alpine
9NK02	Carbon
9NK03	Nightfall
9NK04	Olive
9NK05	Cocoa
9NK06	Canyon

Whisper	
54" wide	
73% recycled polyester 27% polyester with 11.3% ocean bound plastic	
1WS01	Sand Dollar
1WS02	Pebble
1WS03	Silver Birch
1WS04	Iceberg
1WS05	Silver Pine
1WS06	Carbon
1WS07	Cumin
1WS08	Adobe
1WS09	Strawberry
1WS10	Blush
1WS11	Eggplant
1WS12	Willow
1WS13	Sea Grass
1WS14	Pool
1WS15	Blueberry
1WS16	Glacier
1WS17	Grey
1WS18	Canyon

## Price Category 2

Aristo	
54" wide	
88% recycled polyester 12% polyester Acrylic backing	
3AR01	Forest Moss
3AR02	Light Brindle
3AR03	Mink
3AR04	Copper
3AR05	Adobe
3AR06	Cherry
3AR07	Lilac
3AR08	Green Apple
3AR09	Surf
3AR10	Waterfall
3AR11	Cadet
3AR12	Tin
3AR13	Pewter
3AR14	Grey Brindle
3AR15	Grey Black

Crepe	
54" wide	
100% recycled polyester, with 43.6% ocean bound plastic	
9201	Licorice
9203	Smoke
9207	Cherry
9223	Cadet
9241	Beachglass
9249	Stone
9251	Fog
9252	Slate Grey
9261	Shale
9262	Graphite
9265	Mineral
9266	Persimmon
9267	Juniper
9268	Glacier
9269	Cascade
9270	Navy

Price category 2 continued on  
next page

# Proprietary Textile Colors — Seating

continued

## Price Category 2

continued

Epic	
54" wide	
56% recycled polyester	
44% polyester	
Acrylic backing	
3EP01	Alabaster
3EP02	Smoke
3EP03	Falcon
3EP04	Citrus Spring
3EP05	Copper
3EP06	Urban Orange
3EP07	Poppy
3EP08	Wild Plum
3EP09	Sugar Plum
3EP10	Clover
3EP11	Loden
3EP12	Everglade
3EP13	Mist
3EP14	Peacock
3EP15	Cadet
3EP16	Indigo
3EP17	Spring Wood
3EP18	Grey Brindle
3EP19	Seed
3EP20	Carbon Dark

Loom	
54" wide	
100% polyester	
1LM01	Linen *
1LM03	Brick and Mortar
1LM04	Salt and Pepper
1LM05	Black
1LM08	Wild Berry
1LM09	Loden
1LM10	Jade
1LM11	Deep Sea

\* Color not available on Valor™ Seating

Marvel	
54" wide	
100% pvc-free polyurethane	
1MV01	Summer White
1MV02	Sand Dollar
1MV03	Espresso
1MV04	Folkstone Grey
1MV05	Graphite
1MV06	Onyx
1MV07	Polar Blue
1MV08	Blush Grey
1MV09	Woodrose
1MV10	Citrus
1MV11	Adobe
1MV12	Red
1MV13	Kiwi Green
1MV14	Pine
1MV15	Teal Green
1MV16	Twilight

Medley	
54" wide	
100% polyester	
1HA01	Stone
1HA02	Trail
1HA03	Charcoal
1HA04	Cinder
1HA05	Citrus
1HA06	Papaya
1HA07	Chutney
1HA08	Tundra
1HA09	Feather Grey
1HA10	Chartreuse
1HA11	Loden
1HA12	Peacock
1HA13	Bayou
1HA14	Blue Grotto
1HA15	Blueberry
1HA22	Khaki
1HA23	Pewter
1HA24	Yellow Oxide
1HA25	Vintage Rose
1HA26	Raspberry
1HA27	Acai Berry

Mellow	
54" wide	
100% recycled polyester, with 16% ocean bound plastic	
4ME01	Mineral
4ME02	Pewter
4ME03	Wisteria
4ME04	Olive
4ME05	Glacier
4ME06	Oceanside
4ME07	Charcoal

Rhythm	
54" wide	
100% polyester	
3001	Kiwi Green *
3002	Green Apple *
3003	Peacock *
3004	Bayou *
3005	Berry Blue
3006	Iris *
3007	Twilight
3008	Pumpkin *
3009	Poppy *
3010	Molasses *
3011	Mulberry *
3012	Khaki *
3013	Mink *
3014	Black
3015	Charcoal

\* Colors not available on Embody® Chair.

Sequel	
54" wide	
100% vinyl	
100% polyester knit backing	
Resilience® finish	
3SL01	White
3SL02	Pebble
3SL03	Mushroom
3SL04	Stone
3SL05	Chestnut
3SL06	Rattan
3SL07	Black Cherry
3SL08	Tundra
3SL09	Seal
3SL10	Blue Fog
3SL11	Folkstone
3SL12	Shale
3SL13	Slate Grey
3SL14	Charcoal
3SL15	Carbon Dark
3SL28	Navy *

\* Color available on Eames® Tandem Sling Seating.

Terra	
54" wide	
100% post-consumer recycled biodegradable polyester *	
4TE01	Spring Wood
4TE02	Zinc
4TE03	Pine Cone
4TE04	Charcoal

\* 1% biodegradation in 1,278 days under ASTM D5511 conditions. No evidence of further degradation.

Price category 2 continued on next page

# Proprietary Textile Colors — Seating

continued

Appendix: Proprietary Textile Colors — Seating

## Price Category 2

continued

Twist	
54" wide	
80% antimony-free polyester	
13% recycled polyester	
7% polyester	
8R05	Wicker
8R10	Poppy
8R14	Tin
8R15	Shale
8R16	Graphite
8R17	Birch
8R18	Sepia
8R22	Blueberry
8R23	Green Apple
8R26	Gunmetal
8R27	Cinder
8R28	Citrus
8R29	Pekoe
8R30	Tangerine
8R31	Red Plum
8R32	Wisteria
8R33	Forest
8R34	Jade Dark
8R35	Waterfall
8R36	Midnight Blue
8R37	Carbon Dark

## Price Category 3

Ace	
54" wide	
100% polyurethane	
Polyester knit backing	
Stain resistant finish	
3AC01	Summer White
3AC02	White Ash
3AC03	Rye
3AC04	Metal
3AC05	Clay
3AC06	Chestnut
3AC07	Citrus
3AC08	Camelback
3AC09	Chipotle
3AC10	Claret
3AC11	Slate Purple
3AC12	Artichoke
3AC13	Sepia Dark
3AC14	Aloe
3AC15	Flint
3AC16	Blue Sky
3AC17	Oceanside
3AC18	Midnight
3AC19	Spring Wood
3AC20	Frost
3AC21	Lead
3AC22	Black

Landing	
For Eames® Tandem Sling Seating	
54" wide	
100% TPE	
Polyester knit backing	
4LN01	Black

Latitude™	
61" wide	
100% polyester	
8M01	Graphite
8M02	Shadow
8M10	Alpine
8M17	Black
8M21	Slate Grey
8M22	Lime Green
8M23	French Press
8M24	Urban Orange
8M25	Dark Turquoise
8M26	Twilight

Latitude	
Colors for Mirra 2 Chairs	
100% polyester	
8M10	Alpine
8M17	Black
8M21	Slate Grey
8M22	Lime Green
8M23	French Press
8M24	Urban Orange
8M25	Dark Turquoise
8M26	Twilight

## Price Category 4

Daydream	
54" wide	
48% wool	
41% recycled polyester	
9% nylon	
2% polyester	
3DM01	Rye Grass
3DM02	Silver Birch
3DM03	Pewter
3DM04	Graphite
3DM05	Black
3DM06	Lemongrass
3DM07	Permission
3DM08	Juniper
3DM09	Sea Grass
3DM10	Nightfall

Dialogue	
For Public Office Landscape®	
Sectional Back/Social Chair Back	
knit to size	
100% polyester	
1DL01	Light Brindle
1DL02	Dark Brindle

Network	
For Public Office Landscape®	
Sectional Back/Social Chair Back	
knit to size	
100% polyester	
1A901	Warm White
1A902	Fog
1A903	Red
1A904	Wildberry
1A905	Green Apple
1A906	Twilight
1A907	Graphite

Price category 4 continued on next page

# Proprietary Textile Colors — Seating

continued

## Price Category 4

continued

Sync	
55" wide	
100% polyester	
3SY01	Pine Cone
3SY02	Citron
3SY03	Canyon
3SY04	Truffle
3SY05	Wild Berry
3SY06	Everglade
3SY07	Glacier
3SY08	Nightfall
3SY09	Dark Mineral
3SY10	Slate Grey
3SY11	Dark Carbon
3SY12	Black

## Price Category 5

Cozy	
54" wide	
100% wool	
3CY01	Heathered Warm Grey
3CY02	Heathered Rye Grass
3CY03	Heathered Cool Grey
3CY04	Heathered Blue Grey
3CY05	Heathered Black
3CY06	Heathered Persimmon
3CY07	Heathered Loden
3CY08	Heathered Jade
3CY09	Heathered Lagoon
3CY10	Heathered Twilight

Hopsak	
56" wide	
100% recycled polyester	
14A20	Black
14A22	Raw Umber Dark
14A26	Grey Blue Dark
14A30	Sepia Dark
14A38	Emerald Dark
14A39	Yellow Dark
14A40	Orange
14A41	Sienna
14A42	Olive Green Dark
14A43	Crimson
14A44	Crimson Dark Dark
14A45	Violet Dark
14A46	Pink Dark Dark
14A47	Ultramarine Dark
14A48	Cobalt Blue
14A49	Terra Cotta
14A50	Ochre Dark

Summit	
54" wide	
100% silicone	
Polyester knit backing	
3SU01	Bright White
3SU02	Oyster
3SU03	Zinc
3SU04	Sparrow
3SU05	Taupe
3SU06	Java
3SU07	Black
3SU08	Cherry
3SU09	Beachglass
3SU10	Midnight

## Price Category 6

Balance	
For Embody® chairs	
100% polyester	
3512	Carbon
3513	Black

Appendix: Proprietary Textile Colors — Seating

# Proprietary Textile Colors — Seating

continued

---

## Price Category 7

**Customer's Own Leather**  
See Order Information in Appendices. Assigned lead-time textile. [A](#)

---

## Price Category 8

No fabrics available at this time.

---

## Price Category 9

<b>Leather</b>	
approx. 50 sq. ft. per hide	
100% leather	
2101	Ivory
2109	Black *
2110	Smoke
2111	Graphite
2112	Khaki
2113	Rattan
2114	Truffle
2115	Alpine
2116	Haze
2117	Sable Grey
2118	Dark Mineral **
2119	Dark Carbon ***
2120	Cranberry
2121	Deep Sea

\* Armpad color available on Aeron® Chair, Graphite.

\*\* Armpad color available on Aeron Chair, Mineral.

\*\*\* Armpad color available on Aeron Chair, Carbon.

# Maharam® Application Chart — Seating

- Available

[A] Maharam textiles are on assigned lead times.

[N] Non-woven textile.

See below for exception notes.

	Asari Work Chairs by Herman Miller™	Sayl® Work Chairs/Stools	Sayl Side Chairs	Setu® Chairs/Stools	Verus® Work Chairs/Stools Back	Verus Work Chairs/Stools Seat	Verus Side Chairs Back	Verus Side Chairs Seat	Verus Plus Chairs	Aside® Chairs	Caper® Chairs/Stools	Lino® Chairs Seat	OE1 Storage Trolley Cushion Top	Public Office Landscape® Seat	Plex® Lounge Furniture	Swoop™ Lounge Seating - Fully Upholstered	Swoop Lounge Seating - Plywood	Valor™ Seating	Cushion Tops	Workspaces
<b>Price Category 1</b>																				
No fabrics available at this time.																				
<b>Price Category 2</b>																				
ZMA__ Metaphor - Maharam		16	16	•	•	•	•	•	•	•	•	•	•	•	•	•	•	•	•	•
811__ Muse - Maharam		16	16		•	•					•		•				26			•
<b>Price Category 3</b>																				
ZM2__ Meld - Maharam *		•	•	•	•	•	•	•	•	8	•	•	•	•	•	•			•	•
<b>Price Category 4</b>																				
ZLR__ Lariat - Maharam [N]		•	•	•	•	•	•	•	•				•	•	20				•	•
<b>Price Category 5</b>																				
4OG__ Method - Maharam		16	16	•	•	•	•	•	•		•	•	•	•	•	•			•	•
ZNC__ Nico - Maharam		•	•		•	•	•	•	•		•		•	•	•	•	•	•	•	•
<b>Price Category 6</b>																				
No fabrics available at this time.																				
<b>Price Category 7</b>																				
ZB3__ Beck - Maharam		16	16	•	•	•	•	•	•		•		•	•	•	•	•	•	•	•
<b>Price Category 8</b>																				
ZLU__ Luce - Maharam		•	16	16	•	•	•	•	•		•		•	•	•	•	•	•	•	•
<b>Price Category 9</b>																				
ZC0__ Campana - Maharam		16	16		•	•	•	•	•		•		•	•	•	•	•	•	•	•
ZGE__ Gemma - Maharam		•	•	•	•	•	•	•	•		•		•	•	•	•	•	•	•	•
ZJA__ Jasper - Maharam		16	16		•	•	•	•	•		•		•					•	7	
<b>Price Category 10</b>																				
3KH__ Firma - Maharam		16		•	•	•	•	•	•		•		•	•	•	•	•	•	•	•
ZGF__ Gemma Multi - Maharam		•	•	•	•	•	•	•	•		•		•	•	•	•	•	•	•	•
ZGF__ Gemma Multi Reverse - Maharam		•	•	•	•	•	•	•	•		•		•	•	•	•	•	•	•	•
ZP4__ Petra - Maharam		16	16		•	•	•	•	•		•		•	•	•	•	•	•	•	•
<b>Price Category A</b>																				
No fabrics available at this time.																				
<b>Price Category B</b>																				
VM__ Medium - Maharam		•	•		•	•		•	•	•	•	•							•	•
TI__ Messenger - Maharam *		•	•	•	•	•	•	•	•		•		•	•	•	•	•	•	26	•
<b>Price Category C</b>																				
Z27__ Manner - Maharam		•	•		•	•		•	•	•	•	•							•	•
887__ Merit - Maharam		•	•		•	•	•	•	•		•		•	•	•	•	•	•	•	•
Z3__ Metric - Maharam		•	•		•	•	•	•	•		•		•	•	•	•	•	•	•	•
ZML__ Milestone - Maharam		•	•		•	•		•	•		•		•	•	•	•	•	•	•	•
8EY__ Murmur - Maharam		•	16		•	•		•	•		•		•	•	•	•	•	•	•	7
<b>Price Category D</b>																				
818__ Bluff - Maharam [N]		16	16		•	•	•	•	•	8			•	21		•	•	•		
ZMD__ Mode - Maharam		18	•	•	•	•	•	•	•				•		•	•	•	•	•	•

continued on next page

\* Available in select colors on 20-day lead-time. Refer to "Maharam Colors - Seating" for 20-day colors.

# Maharam® Application Chart — Seating *continued*

• Available

[A] Maharam textiles are on assigned lead times.

[N] Non-woven textile.

See below for exception notes.

Appendix: Maharam Application Chart — Seating

	Asari Work Chairs by Herman Miller™	Sayl® Work Chairs/Stools	Sayl Side Chairs	Setu® Chairs/Stools	Verus® Work Chairs/Stools Back	Verus Work Chairs/Stools Seat	Verus Side Chairs Back	Verus Side Chairs Seat	Verus Plus Chairs	Aside® Chairs	Caper® Chairs/Stools	Lino® Chairs Seat	OE1 Storage Trolley Cushion Top	Public Office Landscape® Seat	Plex® Lounge Furniture	Swoop™ Lounge Seating - Fully Upholstered	Swoop Lounge Seating - Plywood	Valor™ Seating	Cushion Tops	Workspaces
<b>Price Category E</b>																				
ZAT__ Article - Maharam [N]		16	16		•	•	•	•				•		•				•		7
896__ Dwell - Maharam		16	16			•		•				•		•				•		7
ZP2__ Pick - Maharam		18	•		•	•	•	•				•	•			•	•	•	•	
ZR2__ Roster - Maharam		16	16			•		•	•			•		•				•		
ZT3__ Technic - Maharam		18	•		•	•	•	•										•		7
<b>Price Category F</b>																				
82T__ Apt - Maharam [N]		18	•		•	•	•	•						•		•		•		7
871__ Brindle - Maharam		16	16			•		•				•	•	•				•	•	
87Z__ Conduit - Maharam		16	16			•	•	•				•	•	•						7
74M__ Instill - Maharam [N]		18	16			•	•	•				•	•	•				•	•	7
89N__ Keen - Maharam		16	16			•		•	•			•	•	•				•	•	
V9G__ Ledger - Maharam [N]		18	16			•	•	•	•			•	•					•	•	
ZLL__ Loop - Maharam		16	16			•		•		8		•		•				•		
82A__ Multiply - Maharam		16	16			•	•	•	•			•		•				•	•	
8LW__ Pepper - Maharam		16	16			•		•				•		•	21		•		9	•
ZRA__ Runner Standard - Maharam		18	•		•	•	•	•												7
Z31__ Sequence - Maharam		•	•		•	•	•	•					•					•	•	•
Z33__ Strum - Maharam [N]			16														•		•	7
<b>Price Category G</b>																				
ZC2__ Compound - Maharam [N]		16	16			•	•	•	•	8		•			•			•	•	7
ZEM__ Emboss - Maharam [N]			16																	7
ZF1__ Fold - Maharam [N]		16	16																	7
8AR__ Gild - Maharam			16			•	•	•	•					•	21		•	•	•	
ZPR__ Pare - Maharam		18	16			•		•		8		•		•	•	•				7
ZP1__ Pick Crypton - Maharam		16	•			•	•	•				•								7
ZRF__ Runner - Maharam		16	16										•							•
<b>Price Category H</b>																				
ZT__ Circles - Maharam		16	16																	•
ZS__ Crosspatch - Maharam			•										•							•
ZK__ Dot Pattern - Maharam			•	•	•		•		•				•							•
ZQF__ Offset - Maharam		16	•										•							•
ZL__ Small Dot Pattern - Maharam			•	•	•		•		•				•							•
<b>Price Category I</b>																				
7CW__ Cursive - Maharam		16	16			•	•	•	•	8		•	•	•						•
ZSY__ Study - Maharam													•							•

continued on next page

# Maharam® Application Chart — Seating *continued*

- Available

[A] Maharam textiles are on assigned lead times.

[N] Non-woven textile.

See below for exception notes.

	Asari Work Chairs by Herman Miller™	Sayl® Work Chairs/Stools	Sayl Side Chairs	Setu® Chairs/Stools	Verus® Work Chairs/Stools Back	Verus Work Chairs/Stools Seat	Verus Side Chairs Back	Verus Side Chairs Seat	Verus Plus Chairs	Aside® Chairs	Caper® Chairs/Stools	Lino® Chairs Seat	OE1 Storage Trolley Cushion Top	Public Office Landscape® Seat	Plex® Lounge Furniture	Swoop™ Lounge Seating - Fully Upholstered	Swoop Lounge Seating - Plywood	Valor™ Seating	Cushion Tops	Workspaces
<b>Price Category J-K</b>	No fabrics available at this time.																			
<b>Price Category L</b>																				
ZMK_ _ Minicheck - Maharam		•	•			•	•	•		•		•						•		7
<b>Price Category M</b>																				
ZF2_ _ Fruit - Maharam				16						•										7
<b>Price Category N-Q</b>	No fabrics available at this time.																			
<b>Price Category R</b>																				
Stow Leather	•																			
<b>Price Category S-Z</b>																				
No fabrics available at this time.																				

7 Available on 1” Cushion Tops only.

8 Only available on the Aside nonupholstered outer back option (PB).

9 Available on Valor upholstered seat.

16 Available on Sayl Chair seat.

18 Available on Sayl Chair seat and upholstered mid-back.

20 Not available on Plex Club Chair with Headrest.

21 Available on Plex seat and on Ottoman.

26 Available in select colors. Refer to “Maharam Textile Colors - Seating” for color offering.



# Maharam® Colors — Seating

## Price Category 1

No fabrics available at this time.

## Price Category 2

Metaphor – Maharam	
54" wide	
100% polyester	
Acrylic backing	
ZMA01/466553-001 Afterfeather	
ZMA02/466553-002 Moonflower	
ZMA03/466553-003 Handcraft	
ZMA04/466553-004 Crossroad	
ZMA05/466553-005 Chondrite	
ZMA06/466553-006 Detective	
ZMA07/466553-007 Steamship	
ZMA08/466553-008 Electricity	
ZMA09/466553-009 Takeoff	
ZMA10/466553-010 Parachute	
ZMA11/466553-011 Blueshift	
ZMA12/466553-012 Dockyard	
ZMA13/466553-013 Bathe	
ZMA14/466553-014 Icebound	
ZMA15/466553-015 Thermosphere	
ZMA16/466553-016 Aboard	
ZMA17/466553-017 Agateway	
ZMA18/466553-018 Homeland	
ZMA19/466553-019 Rockfall	
ZMA20/466553-020 Undergrowth	
ZMA21/466553-021 Gremolata	
ZMA22/466553-022 Patina	
ZMA23/466553-023 Sylvan	
ZMA24/466553-024 Outfield	
ZMA25/466553-025 Windbreak	
ZMA26/466553-026 Saguaro	
ZMA27/466553-027 Barnwood	
ZMA28/466553-028 Cookshop	
ZMA29/466553-029 Amandine	
ZMA30/466553-030 Bodhran	
ZMA31/466553-031 Centerstage	
ZMA32/466553-032 Focaccia	
ZMA33/466553-033 Bumblebee	
ZMA34/466553-034 Microbrew	
ZMA35/466553-035 Sauna	
ZMA36/466553-036 Gazebo	
ZMA37/466553-037 Pirouette	
ZMA38/466553-038 Heartbeat	
ZMA39/466553-039 Shino	
ZMA40/466553-040 Sunrise	
ZMA41/466553-041 Florist	

Metaphor <i>continued</i>	
ZMA42/466553-042 Beadwork	
ZMA43/466553-043 Framboise	
ZMA44/466553-044 Wisteria	
ZMA45/466553-045 Warrior	

Muse – Maharam	
54" wide	
100% post-consumer recycled polyester	
81101/466487-001 Crescendo	
81102/466487-002 Resonate	
81103/466487-003 Runway	
81104/466487-004 Ascend	
81105/466487-005 Veil *	
81106/466487-006 Refresh *	
81107/466487-007 Clear *	
81108/466487-008 Fantasy	
81109/466487-009 Miso	
81110/466487-010 Compass	
81111/466487-011 Bergamot *	
81112/466487-012 Grasshopper	
81113/466487-013 Goal	
81114/466487-014 Mistletoe	
81115/466487-015 Seaglass *	
81116/466487-016 Frigid	
81117/466487-017 Riverbend	
81118/466487-018 Noble	
81119/466487-019 Pulsar	
81120/466487-020 Velella	
81121/466487-021 Sailboat	
81122/466487-022 Sparse	
81123/466487-023 Vase	
81124/466487-024 Haven	
81125/466487-025 Mead	
81126/466487-026 Neat	
81127/466487-027 Jovial	
81128/466487-028 Theater	
81129/466487-029 Poinsettia	
81130/466487-030 Celebrate	
81131/466487-031 Spectacle	

\* Colors not available on Valor Seating.

## Price Category 3

Meld – Maharam	
54" wide	
68% post-consumer recycled polyester	
32% polyester	
PFOA-Free stain resistant	
ZM201/466387-201 Vast	
ZM202/466387-202 Panda **	
ZM203/466387-203 Skyline *	
ZM204/466387-204 Knight **	
ZM205/466387-205 Quill **	
ZM206/466387-206 Pipe	
ZM207/466387-207 Grate *	
ZM208/466387-208 Gloss	
ZM209/466387-209 Bulb	
ZM210/466387-210 Bride	
ZM211/466387-211 Stark	
ZM212/466387-212 Seashell	
ZM213/466387-213 Antler	
ZM214/466387-214 Crater *	
ZM215/466387-215 Perennial	
ZM216/466387-216 Mulberry	
ZM217/466387-217 Fuchsia *	
ZM218/466387-218 Amethyst *	
ZM219/466387-219 Merlot	
ZM220/466387-220 Magma *	
ZM221/466387-221 Rooster	
ZM222/466387-222 Heat *	
ZM223/466387-223 Clementine	
ZM224/466387-224 Fox	
ZM225/466387-225 Kiss *	
ZM226/466387-226 Bare	
ZM227/466387-227 Blonde	
ZM228/466387-228 Mimosa	
ZM229/466387-229 Comet *	
ZM230/466387-230 Honeydew	
ZM231/466387-231 Wild *	
ZM232/466387-232 Vine	
ZM233/466387-233 Seed	
ZM234/466387-234 Kale *	

\* Colors available on 20-day lead time.

\*\* Colors available on 10-day lead time.

Price category 3 continued on next page

Appendix: Maharam Colors — Seating

- Maharam textiles are on assigned lead times A unless otherwise noted.
- Fabric numbers are listed as Herman Miller fabric number/Maharam fabric number.

# Maharam® Colors — Seating

continued

## Price Category 3

continued

Meld continued	
ZM235/466387-235	Waterfall *
ZM236/466387-236	Nordic *
ZM237/466387-237	Reef *
ZM238/466387-238	Wave
ZM239/466387-239	Isle **
ZM240/466387-240	Creek
ZM241/466387-241	Mariner *
ZM242/466387-242	Globe
ZM243/466387-243	Spa

\* Colors available on  
20-day lead time.

\*\* Colors available on  
10-day lead time.

## Price Category 4

Lariat – Maharam	
54" wide	
100% vinyl	
ZLR01/440401-001	001
ZLR02/440401-002	002
ZLR03/440401-003	003
ZLR04/440401-004	004
ZLR06/440401-006	006
ZLR07/440401-007	007
ZLR08/440401-008	008
ZLR10/440401-010	010
ZLR11/440401-011	011
ZLR12/440401-012	012
ZLR13/440401-013	013
ZLR14/440401-014	014
ZLR15/440401-015	015
ZLR16/440401-016	016
ZLR18/440401-018	018
ZLR20/440401-020	020
ZLR21/440401-021	021
ZLR23/440401-023	023
ZLR24/440401-024	024
ZLR25/440401-025	025
ZLR26/440401-026	026
ZLR27/440401-027	027

Lariat continued	
ZLR28/440401-028	028
ZLR29/440401-029	029
ZLR30/440401-030	030
ZLR31/440401-031	031
ZLR32/440401-032	032
ZLR33/440401-033	033
ZLR34/440401-034	034
ZLR35/440401-035	035
ZLR36/440401-036	036
ZLR37/440401-037	037
ZLR38/440401-038	038
ZLR39/440401-039	Granite
ZLR40/440401-040	Linen
ZLR41/440401-041	Stella
ZLR42/440401-042	Saddle
ZLR43/440401-043	Holly
ZLR44/440401-044	Maroon
ZLR45/440401-045	Siren
ZLR46/440401-046	Reseda
ZLR47/440401-047	Purslane
ZLR48/440401-048	Spire
ZLR49/440401-049	Papyrus
ZLR50/440401-050	Chickadee
ZLR51/440401-051	Requiem

## Price Category 5

Method - Maharam	
54" wide	
100% recycled polyester with 9% ocean-bound plastic	
40G01/466579-001	Inspire
40G02/466579-002	Rhea
40G03/466579-003	Noise
40G04/466579-004	Speedway
40G05/466579-005	Villanelle
40G06/466579-006	Maestro
40G07/466579-007	Destiny
40G08/466579-008	Possess
40G09/466579-009	Waterside
40G10/466579-010	Relax
40G11/466579-011	Delightful
40G12/466579-012	Parrotlet
40G13/466579-013	Verdurous
40G14/466579-014	Bosky
40G15/466579-015	Acreage
40G16/466579-016	Allude
40G17/466579-017	Tweed
40G18/466579-018	Korma
40G19/466579-019	Fossilize
40G20/466579-020	Cattail
40G21/466579-021	Shortcake
40G22/466579-022	Racecar
40G23/466579-023	Courtship
40G24/466579-024	Jam
40G25/466579-025	Sparrow

Price category 5 continued on  
next page

- Maharam textiles are on assigned lead times A unless otherwise noted.
- Fabric numbers are listed as Herman Miller fabric number/Maharam fabric number.

# Maharam® Colors — Seating

continued

## Price Category 5

continued

### Nico - Maharam

54" wide
63% wool
21% polyester
16% solution-dyed nylon
ZNC01/466564-001 Alcazar
ZNC02/466564-002 Ironclad
ZNC03/466564-003 Tune
ZNC04/466564-004 Bridegroom
ZNC05/466564-005 Diode
ZNC06/466564-006 Jest
ZNC07/466564-007 Sanctuary
ZNC08/466564-008 Aquarius
ZNC09/466564-009 Houseboat
ZNC10/466564-010 Olympian
ZNC11/466564-011 Tennis
ZNC12/466564-012 Dressage
ZNC13/466564-013 Zing
ZNC14/466564-014 Bitterroot
ZNC15/466564-015 Gemini
ZNC16/466564-016 Posh
ZNC17/466564-017 Sizzle
ZNC18/466564-018 Cheerful
ZNC19/466564-019 Watermelon
ZNC20/466564-020 Toucan
ZNC21/466564-021 Rosin
ZNC22/466564-022 Jousting
ZNC23/466564-023 Jojoba
ZNC24/466564-024 Dromedary
ZNC25/466564-025 Toasty
ZNC26/466564-026 Casaba
ZNC27/466564-027 Greenhouse
ZNC28/466564-028 Sibyl
ZNC29/466564-029 Spearmint
ZNC30/466564-030 Pothos
ZNC31/466564-031 Calathea
ZNC32/466564-032 Landscape
ZNC33/466564-033 Espalier
ZNC34/466564-034 Gecko
ZNC35/466564-035 Meditation

## Price Category 6

No fabrics available at this time.

## Price Category 7

### Beck - Maharam

55" wide
78% wool
22% nylon
ZB301/466571-001 Overshadow
ZB302/466571-002 Molecule
ZB303/466571-003 Zeitgeist
ZB304/466571-004 Blacksmith
ZB305/466571-005 Cornerstone
ZB306/466571-006 Chainmail
ZB307/466571-007 Buckram
ZB308/466571-008 Callisto
ZB309/466571-009 Interlude
ZB310/466571-010 Letterpress
ZB311/466571-011 Memoir
ZB312/466571-012 Litmus
ZB313/466571-013 Stoic
ZB314/466571-014 Inkpad
ZB315/466571-015 Praxis
ZB316/466571-016 Astute
ZB317/466571-017 Percolate
ZB318/466571-018 Halocline
ZB319/466571-019 Semblance
ZB320/466571-020 Loch
ZB321/466571-021 Lido
ZB322/466571-022 Underwater
ZB323/466571-023 Tetrapod
ZB324/466571-024 Nymph
ZB325/466571-025 Appalachian
ZB326/466571-026 Menthol
ZB327/466571-027 Woodruff
ZB328/466571-028 Malachite
ZB329/466571-029 Botanist
ZB330/466571-030 Woodlet
ZB331/466571-031 Katydid
ZB332/466571-032 Exuberant
ZB333/466571-033 Retrospect

### Beck continued

ZB334/466571-034 Lambic
ZB335/466571-035 Argil
ZB336/466571-036 Brushstroke
ZB337/466571-037 Candescent
ZB338/466571-038 Reedbuck
ZB339/466571-039 Clayware
ZB340/466571-040 Curio
ZB341/466571-041 Whimsy
ZB342/466571-042 Effervescent
ZB343/466571-043 Lingonberry
ZB344/466571-044 Resplendent
ZB345/466571-045 Hollyhock
ZB346/466571-046 Filigree
ZB347/466571-047 Plutonic
ZB348/466571-048 Foundry
ZB349/466571-049 Patisserie

### Cumulus - Maharam

54" wide
100% biodegradable
post-consumer recycled polyester
6VQ01/466609-001 Lenticular
6VQ02/466609-002 Provoke
6VQ03/466609-003 Matrix
6VQ04/466609-004 Saturate
6VQ05/466609-005 Anabranch
6VQ06/466609-006 Outward
6VQ07/466609-007 Backwoods
6VQ08/466609-008 Dreamer
6VQ09/466609-009 Incandescent
6VQ10/466609-010 Minute
6VQ11/466609-011 Bungalow
6VQ12/466609-012 Temperature
6VQ13/466609-013 Stiletto
6VQ14/466609-014 Precise
6VQ15/466609-015 Floccus

- Maharam textiles are on assigned lead times <sup>A</sup> unless otherwise noted.
- Fabric numbers are listed as Herman Miller fabric number/Maharam fabric number.

# Maharam® Colors — Seating

continued

## Price Category 8

## Price Category 9

Appendix: Maharam Colors — Seating

Luce - Maharam
59" wide
75% post-consumer recycled wool
20% polyester
5% nylon
ZLU01/466566-001 Brioche
ZLU02/466566-002 Blanched
ZLU03/466566-003 Relic
ZLU04/466566-004 Sinter
ZLU05/466566-005 Scoria
ZLU06/466566-006 Austere
ZLU07/466566-007 Pigment
ZLU08/466566-008 Alkali
ZLU09/466566-009 Tidal
ZLU10/466566-010 Imbue
ZLU11/466566-011 Reservoir
ZLU12/466566-012 Brine
ZLU13/466566-013 Undertone
ZLU14/466566-014 Prelude
ZLU15/466566-015 Submerge
ZLU16/466566-016 Cypress
ZLU17/466566-017 Awash
ZLU18/466566-018 Adriatic
ZLU19/466566-019 Province
ZLU20/466566-020 Virescent
ZLU21/466566-021 Nettle
ZLU22/466566-022 Agrarian
ZLU23/466566-023 Serpentine
ZLU24/466566-024 Laurel
ZLU25/466566-025 Clarion
ZLU26/466566-026 Gooseberry
ZLU27/466566-027 Swelter
ZLU28/466566-028 Etruscan
ZLU29/466566-029 Coulis
ZLU30/466566-030 Rubescent
ZLU31/466566-031 Akoya
ZLU32/466566-032 Radiant
ZLU33/466566-033 Regent
ZLU34/466566-034 Spectral
ZLU35/466566-035 Thistle

Campana – Maharam
59" wide
85% wool
15% nylon
ZC001/466571-001 Viverine
ZC002/466571-002 Lithograph
ZC003/466571-003 Moonscape
ZC004/466571-004 Brevity
ZC005/466571-005 Linear
ZC006/466571-006 Hinterland
ZC007/466571-007 Mural
ZC008/466571-008 Sloe
ZC009/466571-009 Interstellar
ZC010/466571-010 Mythology
ZC011/466571-011 Scintillate
ZC012/466571-012 Succession
ZC013/466571-013 Visceral
ZC014/466571-014 Hemisphere
ZC015/466571-015 Troposphere
ZC016/466571-016 Skye
ZC017/466571-017 Seaward
ZC018/466571-018 Nemorous
ZC019/466571-019 Allegory
ZC020/466571-020 Olivine
ZC021/466571-021 Reptilian
ZC022/466571-022 Basil
ZC023/466571-023 Fanleaf
ZC024/466571-024 Beachgrass
ZC025/466571-025 Hayfield
ZC026/466571-026 Freesia
ZC027/466571-027 Rhodium
ZC028/466571-028 Undercoat
ZC029/466571-029 Airbrush
ZC030/466571-030 Shellfish
ZC031/466571-031 Mojave
ZC032/466571-032 Renaissance
ZC033/466571-033 Decoupage
ZC034/466571-034 Outback
ZC035/466571-035 Millipede

Gemma – Maharam
55" wide
85% wool
15% nylon
ZGE01/466568-001 Crinoline
ZGE02/466568-002 Angelic
ZGE03/466568-003 Savory
ZGE04/466568-004 Honeycomb
ZGE05/466568-005 Gilded
ZGE06/466568-006 Paddleboat
ZGE07/466568-007 Stagecoach
ZGE08/466568-008 Waterbuck
ZGE09/466568-009 Earnest
ZGE10/466568-010 Auric
ZGE11/466568-011 Carmine
ZGE12/466568-012 Serape
ZGE13/466568-013 Ferric
ZGE14/466568-014 Canyon
ZGE15/466568-015 Alembic
ZGE16/466568-016 Patio
ZGE17/466568-017 Sorrel
ZGE18/466568-018 Root
ZGE19/466568-019 Mansion
ZGE20/466568-020 Buff
ZGE21/466568-021 Starch
ZGE22/466568-022 Dawn
ZGE23/466568-023 Countryside
ZGE24/466568-024 Dewy
ZGE25/466568-025 Reliquary
ZGE26/466568-026 Deluge
ZGE27/466568-027 Overlay
ZGE28/466568-028 Electron
ZGE29/466568-029 Sheath
ZGE30/466568-030 Quietude
ZGE31/466568-031 Jargon
ZGE32/466568-032 Powder
ZGE33/466568-033 Tide
ZGE34/466568-034 Outwash
ZGE35/466568-035 Enamored
ZGE36/466568-036 Smitten
ZGE37/466568-037 Revere
ZGE38/466568-038 Mangosteen
ZGE39/466568-039 Allium
ZGE40/466568-040 Immense
ZGE41/466568-041 Chamber

Gemma continued
ZGE42/466568-042 Cosmos
ZGE43/466568-043 Inklings
ZGE44/466568-044 Rainwater
ZGE45/466568-045 Shade
ZGE46/466568-046 Pendant
ZGE47/466568-047 Axial
ZGE48/466568-048 Fervent
ZGE49/466568-049 Legacy
ZGE50/466568-050 Caliber
ZGE51/466568-051 Temple
ZGE52/466568-052 Evenfall

Jasper - Maharam
53" wide
55% wool
27% solution-dyed nylon
18% cotton
ZJA01/466563-001 Thrill
ZJA02/466563-002 Anise
ZJA03/466563-003 Grapefruit
ZJA04/466563-004 Lifeguard
ZJA05/466563-005 Heartfelt
ZJA06/466563-006 Corsage
ZJA07/466563-007 Earthenware
ZJA08/466563-008 Bear
ZJA09/466563-009 Firelight
ZJA10/466563-010 Dreamcatcher
ZJA11/466563-011 Bobcat
ZJA12/466563-012 Glacial
ZJA13/466563-013 Vaporize
ZJA14/466563-014 Trapdoor
ZJA15/466563-015 Halcyon
ZJA16/466563-016 Observatory
ZJA17/466563-017 Steamboat
ZJA18/466563-018 Aquathlon
ZJA19/466563-019 Cloudless
ZJA20/466563-020 Briny
ZJA21/466563-021 Magical
ZJA22/466563-022 Picnic
ZJA23/466563-023 Herbage
ZJA24/466563-024 Pasture
ZJA25/466563-025 Courtyard
ZJA26/466563-026 Leapfrog

- Maharam textiles are on assigned lead times **A** unless otherwise noted.
- Fabric numbers are listed as Herman Miller fabric number/Maharam fabric number.

# Maharam® Colors — Seating

continued

## Price Category 10

### Firma – Maharam

55" wide
78% wool
22% nylon
3KH01/466582-001 Wrath
3KH02/466582-002 Pantomime
3KH03/466582-003 Shaded
3KH04/466582-004 Prologue
3KH05/466582-005 Framework
3KH06/466582-006 Railroad
3KH07/466582-007 Grommet
3KH08/466582-008 Lunisolar
3KH09/466582-009 Snowpack
3KH10/466582-010 Coldsnap
3KH11/466582-011 Sealift
3KH12/466582-012 Brood
3KH13/466582-013 Intertidal
3KH14/466582-014 Confide
3KH15/466582-015 Secluded
3KH16/466582-016 Leisure
3KH17/466582-017 Portfolio
3KH18/466582-018 Strato
3KH19/466582-019 Fogbow
3KH20/466582-020 Snowcone
3KH21/466582-021 Kazoo
3KH22/466582-022 Esteem
3KH23/466582-023 Mackerel
3KH24/466582-024 Brooch
3KH25/466582-025 Caesious
3KH26/466582-026 Islet
3KH27/466582-027 Biosphere
3KH28/466582-028 Hilltop
3KH29/466582-029 Arboreal
3KH30/466582-030 Lineage
3KH31/466582-031 Comfrey
3KH32/466582-032 Circe
3KH33/466582-033 Ecosystem
3KH34/466582-034 Knack
3KH35/466582-035 Watt
3KH36/466582-036 Epiphany
3KH37/466582-037 Gamma
3KH38/466582-038 Taxicab
3KH39/466582-039 Varietal
3KH40/466582-040 Tale

### Firma continued

3KH41/466582-041 Elemental
3KH42/466582-042 Cuff
3KH43/466582-043 Emu
3KH44/466582-044 Tempeh
3KH45/466582-045 Tephra
3KH46/466582-046 Shellac
3KH47/466582-047 Emporium
3KH48/466582-048 Keratin
3KH49/466582-049 Camwood
3KH50/466582-050 Gloam
3KH51/466582-051 Novela
3KH52/466582-052 Fruitpunch
3KH53/466582-053 Decant
3KH54/466582-054 Milkshake
3KH55/466582-055 Metaphysic
3KH56/466582-056 Carafe
3KH57/466582-057 Voyager
3KH58/466582-058 Tenebrous
3KH59/466582-059 Subtext
3KH60/466582-060 Silent

### Gemma Multi – Maharam

55" wide
85% wool
15% nylon
ZGF01/466569-001 Andromeda
ZGF02/466569-002 Dappled
ZGF03/466569-003 Lyra
ZGF04/466569-004 Flaunt
ZGF05/466569-005 Celluloid
ZGF06/466569-006 Hydrozoa
ZGF07/466569-007 Firefly
ZGF08/466569-008 Pisces
ZGF09/466569-009 Strath
ZGF10/466569-010 Erosion
ZGF11/466569-011 Cabaret
ZGF12/466569-012 Candytuft
ZGF13/466569-013 Juice
ZGF14/466569-014 Fairground
ZGF15/466569-015 Copperplate
ZGF16/466569-016 Sunbird
ZGF17/466569-017 Cinematic
ZGF18/466569-018 Clairvoyant
ZGF19/466569-019 Crocus

### Gemma Multi continued

ZGF20/466569-020 Memoir
ZGF21/466569-021 Roulette
ZGF22/466569-022 Voltaic
ZGF23/466569-023 Compote
ZGF24/466569-024 Lambent
ZGF25/466569-025 Twister
ZGF26/466569-026 Chronicle
ZGF27/466569-027 Sidereal
ZGF28/466569-028 Tanzanite
ZGF29/466569-029 Crystalize
ZGF30/466569-030 Chromium
ZGF31/466569-031 Pallium
ZGF32/466569-032 Spectre
ZGF33/466569-033 Courgette
ZGF34/466569-034 Viper
ZGF35/466569-035 Sunlit
ZGF36/466569-036 Heavenly
ZGF37/466569-037 Vernal
ZGF38/466569-038 Cress
ZGF39/466569-039 Limn
ZGF40/466569-040 Horseradish
ZGF41/466569-041 Shandy
ZGF42/466569-042 Granary
ZGF43/466569-043 Percolate
ZGF44/466569-044 Motor
ZGF45/466569-045 Unicorn
ZGF46/466569-046 Lobster
ZGF47/466569-047 Rhododendron
ZGF48/466569-048 Taffy
ZGF49/466569-049 Rishi
ZGF50/466569-050 Backcountry
ZGF51/466569-051 Buckthorn
ZGF52/466569-052 Coniferous
ZGF53/466569-053 Delphic
ZGF54/466569-054 Hieroglyph
ZGF55/466569-055 Eiderdown
ZGF56/466569-056 Sandbar
ZGF57/466569-057 Tanager

### Gemma Multi Reverse – Maharam

55" wide
85% wool
15% nylon
ZGF58/466569-101 Andromeda
Reverse
ZGF59/466569-102 Dappled
Reverse
ZGF60/466569-103 Lyra
Reverse
ZGF61/466569-104 Flaunt
Reverse
ZGF62/466569-105 Celluloid
Reverse
ZGF63/466569-106 Hydrozoa
Reverse
ZGF64/466569-107 Firefly
Reverse
ZGF65/466569-108 Pisces
Reverse
ZGF66/466569-109 Strath
Reverse
ZGF67/466569-110 Erosion
Reverse
ZGF68/466569-111 Cabaret
Reverse
ZGF69/466569-112 Candytuft
Reverse
ZGF70/466569-113 Juice
Reverse
ZGF71/466569-114 Fairground
Reverse
ZGF72/466569-115 Copperplate
Reverse
ZGF73/466569-116 Sunbird
Reverse
ZGF74/466569-117 Cinematic
Reverse
ZGF75/466569-118 Clairvoyant
Reverse
ZGF76/466569-119 Crocus
Reverse

Price category 10 continued on next page

- Maharam textiles are on assigned lead times **A** unless otherwise noted.
- Fabric numbers are listed as Herman Miller fabric number/Maharam fabric number.

# Maharam® Colors — Seating

continued

## Price Category 10

continued

## Price Category A

### Gemma Multi Reverse *continued*

ZGF77/466569-120	Memoir
	Reverse
ZGF78/466569-121	Roulette
	Reverse
ZGF79/466569-122	Voltaic
	Reverse
ZGF80/466569-123	Compote
	Reverse
ZGF81/466569-124	Lambent
	Reverse
ZGF82/466569-125	Twister
	Reverse
ZGF83/466569-126	Chronicle
	Reverse
ZGF84/466569-127	Sidereal
	Reverse
ZGF85/466569-128	Tanzanite
	Reverse
ZGF86/466569-129	Crystalize
	Reverse
ZGF87/466569-130	Chromium
	Reverse
ZGF88/466569-131	Pallium
	Reverse
ZGF89/466569-132	Spectre
	Reverse
ZGF90/466569-133	Courgette
	Reverse
ZGF91/466569-134	Viper
	Reverse
ZGF92/466569-135	Sunlit
	Reverse
ZGF93/466569-136	Heavenly
	Reverse
ZGF94/466569-137	Vernal
	Reverse
ZGF95/466569-138	Cress
	Reverse
ZGF96/466569-139	Limn
	Reverse

### Gemma Multi Reverse *continued*

ZGF97/466569-140	Horseradish
	Reverse
ZGF98/466569-141	Shandy
	Reverse
ZGF99/466569-142	Granary
	Reverse
ZGFA0/466569-143	Percolate
	Reverse
ZGFA1/466569-144	Motor
	Reverse
ZGFA2/466569-145	Unicorn
	Reverse
ZGFA3/466569-146	Lobster
	Reverse
ZGFA4/466569-147	Rhododendron
	Reverse
ZGFA5/466569-148	Taffy
	Reverse
ZGFA6/466569-149	Rishi
	Reverse
ZGFA7/466569-150	Backcountry
	Reverse
ZGFA8/466569-151	Buckthorn
	Reverse
ZGFA9/466569-152	Coniferous
	Reverse
ZGFB0/466569-153	Delphic
	Reverse
ZGFB1/466569-154	Hieroglyph
	Reverse
ZGFB2/466569-155	Eiderdown
	Reverse
ZGFB3/466569-157	Tanager
	Reverse

### Petra - Maharam

55" wide	
70% wool	
19% linen	
11% nylon	
ZP401/466580-001	Hieroglyph
ZP402/466580-002	Interior
ZP403/466580-003	Samovar
ZP404/466580-004	Calcite
ZP405/466580-005	Silversmith
ZP406/466580-006	Rivet
ZP407/466580-007	Carpolite
ZP408/466580-008	Bonbon
ZP409/466580-009	Dreamy
ZP410/466580-010	Bejewel
ZP411/466580-011	Sashimi
ZP412/466580-012	Spirula
ZP413/466580-013	Chalet
ZP414/466580-014	Reindeer
ZP415/466580-015	Nostalgia
ZP416/466580-016	Trove
ZP417/466580-017	Narcissus
ZP418/466580-018	Yurt
ZP419/466580-019	Congee
ZP420/466580-020	Genepy
ZP421/466580-021	Herbaceous
ZP422/466580-022	Paddock
ZP423/466580-023	Precious
ZP424/466580-024	Biome
ZP425/466580-025	Tinted
ZP426/466580-026	Pelagic
ZP427/466580-027	Bluebill
ZP428/466580-028	Chicory
ZP429/466580-029	Eaglet
ZP430/466580-030	Permafrost
ZP431/466580-031	Atlantic
ZP432/466580-032	Airstream
ZP433/466580-033	Debonair

No fabrics available at this time.

- Maharam textiles are on assigned lead times A unless otherwise noted.
- Fabric numbers are listed as Herman Miller fabric number/Maharam fabric number.

# Maharam® Colors – Seating

continued

## Price Category B

### Medium – Maharam

54" wide
100% polyester
VM01/463490-001 Raven
VM02/463490-002 Smoke
VM03/463490-003 Alloy
VM04/463490-004 Flax
VM07/463490-007 Espresso
VM08/463490-008 Pecan
VM14/463490-014 Laser
VM16/463490-016 Port
VM22/463490-022 Marina
VM29/463490-029 Pistachio
VM32/463490-032 Prospect
VM36/463490-036 Delight
VM39/463490-039 Nautical
VM40/463490-040 Pool
VM44/463490-044 Washed
VM45/463490-045 Sculpture
VM46/463490-046 Thatched
VM47/463490-047 Hike
VM48/463490-048 Tangle
VM49/463490-049 Pacific
VM50/463490-050 Cosmic
VM51/463490-051 Cascade
VM52/463490-052 Blackberry
VM53/463490-053 Nasturtium

### Messenger – Maharam

54" wide
78% recycled polyester
15% polyester, 7% nylon
TI07/458640-007 Shadow
TI08/458640-008 Bayou *
TI24/458640-024 Poppy
TI25/458640-025 Mao
TI29/458640-029 Onyx *
TI31/458640-031 Cloud *
TI38/458640-038 Depth *
TI40/458640-040 Nile *

### Messenger continued

TI41/458640-041 Azure *
TI45/458640-045 Cactus *
TI46/458640-046 Ice *
TI48/458640-048 Neon
TI50/458640-050 Hydrangea
TI53/458640-053 Tangelo
TI54/458640-054 Lumine *
TI58/458640-058 Snow **
TI60/458640-060 Peridot
TI61/458640-061 Capri *
TI62/458640-062 Ultramarine
TI63/458640-063 Squall
TI66/458640-066 Cassis
TI67/458640-067 Aster
TI69/458640-069 Cherry
TI70/458640-070 Vibrant
TI71/458640-071 Satsuma *
TI72/458640-072 Maize
TI76/458640-076 Fossil
TI77/458640-077 Ash
TI78/458640-078 Tusk
TI79/458640-079 Oyster
TI81/458640-081 Husk
TI84/458640-084 Robust
TI85/458640-085 Beyond
TI86/458640-086 Voyage *
TI87/458640-087 Everglade
TI89/458640-089 Blanch **
TI90/458640-090 Longspur
TI91/458640-091 Vireo
TI92/458640-092 Dipper
TI93/458640-093 Gale
TI94/458640-094 Hunter
TI95/458640-095 Lime
TI96/458640-096 Apple
TI97/458640-097 Krill
TI98/458640-098 Catalyst

\* Colors available on 20-day lead time.

\*\* Colors not available on Valor Seating.

## Price Category C

### Manner - Maharam

54" wide
100% recycled polyester
Z2701/466177-001 Magic
Z2702/466177-002 Carob
Z2703/466177-003 Porpoise
Z2704/466177-004 Flint
Z2705/466177-005 Hush
Z2706/466177-006 Nuance
Z2711/466177-011 Ember
Z2712/466177-012 Wagon
Z2713/466177-013 Ablaze
Z2714/466177-014 Peel
Z2716/466177-016 Butterscotch
Z2717/466177-017 Harvest
Z2720/466177-020 Parakeet
Z2722/466177-022 Aquatic
Z2723/466177-023 Cottage
Z2724/466177-024 Dahlia
Z2725/466177-025 Vivid
Z2726/466177-026 Basin
Z2727/466177-027 Schooner
Z2728/466177-028 Slope
Z2729/466177-029 Silverpoint
Z2730/466177-030 Lattice
Z2731/466177-031 Smoky
Z2732/466177-032 Magnetic
Z2733/466177-033 Woad
Z2734/466177-034 Resolute
Z2735/466177-035 Cruise
Z2736/466177-036 Atmospheric
Z2737/466177-037 Cloudburst
Z2738/466177-038 Tidewater
Z2739/466177-039 Firth
Z2740/466177-040 Oceanside
Z2741/466177-041 Grandeur
Z2742/466177-042 Comfort
Z2743/466177-043 Dill
Z2744/466177-044 Poplar
Z2745/466177-045 Citronella
Z2746/466177-046 Passerine

### Manner continued

Z2747/466177-047 Southwest
Z2748/466177-048 Roseate
Z2749/466177-049 Charisma
Z2750/466177-050 Siltstone
Z2751/466177-051 Kimono
Z2752/466177-052 Valiant
Z2753/466177-053 Baroness

### Merit - Maharam

54" wide
76% post-industrial recycled polyester
24% polyester
PFOA-Free stain resistant
88Z01/466444-001 Trickle
88Z02/466444-002 Beluga
88Z03/466444-003 Gunmetal
88Z04/466444-004 Blackout
88Z05/466444-005 Superior
88Z06/466444-006 Ocean
88Z07/466444-007 Highborn
88Z08/466444-008 Immersed
88Z09/466444-009 Rainfall
88Z10/466444-010 Blizzard
88Z11/466444-011 Poolside
88Z12/466444-012 Steel
88Z13/466444-013 Zircon
88Z14/466444-014 Ripple
88Z15/466444-015 Aegean
88Z16/466444-016 Armada
88Z17/466444-017 Hedera
88Z18/466444-018 Rainforest
88Z19/466444-019 Gator
88Z20/466444-020 Vineyard
88Z21/466444-021 Pine
88Z22/466444-022 Kiwi
88Z23/466444-023 Kookaburra
88Z24/466444-024 Bellini
88Z25/466444-025 Sunflower
88Z26/466444-026 Sandstorm

Price category C continued on next page

- Maharam textiles are on assigned lead times A unless otherwise noted.
- Fabric numbers are listed as Herman Miller fabric number/Maharam fabric number.

# Maharam® Colors – Seating

continued

## Price Category C

continued

<b>Merit continued</b>	
88Z27/466444-027	Mudder
88Z28/466444-028	Lynx
88Z29/466444-029	Farro
88Z30/466444-030	Manila
88Z31/466444-031	Starfish
88Z32/466444-032	Brass
88Z33/466444-033	Arrow
88Z34/466444-034	Gelato
88Z35/466444-035	Nectarine
88Z36/466444-036	Macaron
88Z37/466444-037	Alert
88Z38/466444-038	Goji
88Z39/466444-039	Cabernet
88Z40/466444-040	Eggplant
88Z41/466444-041	Hawk
88Z42/466444-042	Stag
88Z43/466444-043	Overcast

<b>Metric – Maharam</b>	
54" wide	
51% recycled polyester	
49% polyester	
Z302/466014-002	Fog
Z303/466014-003	Fleece
Z312/466014-012	Cardinal
Z313/466014-013	Lava
Z318/466014-018	Pollen
Z320/466014-020	Alligator
Z323/466014-023	Tar
Z324/466014-024	Anchor
Z326/466014-026	Admiral
Z327/466014-027	Seaport
Z328/466014-028	Scuba
Z329/466014-029	Skate
Z330/466014-030	Hopscotch
Z331/466014-031	Film
Z332/466014-032	Whale
Z333/466014-033	Downpour
Z334/466014-034	Midday
Z335/466014-035	Talisman

<b>Metric continued</b>	
Z336/466014-036	Hedgerow
Z337/466014-037	Snorkel
Z338/466014-038	Highway
Z339/466014-039	Canary
Z340/466014-040	Sunny
Z341/466014-041	Aztec
Z342/466014-042	Fruit
Z343/466014-043	Galah
Z344/466014-044	Kiln
Z345/466014-045	Moth

<b>Milestone – Maharam</b>	
54" wide	
78% post-industrial recycled polyester	
15% polyester	
7% nylon	
ZML22/403901-022	Pewter
ZML25/403901-025	Charcoal
ZML26/403901-026	Ebony
ZML47/403901-047	Rush
ZML54/403901-054	Linger
ZML55/403901-055	Embrace
ZML57/403901-057	Coffee
ZML58/403901-058	Bison
ZML61/403901-061	Tiger Lily
ZML71/403901-071	Daffodil
ZML78/403901-078	Spruce
ZML79/403901-079	Fountain

<b>Murmur - Maharam</b>	
55" wide	
100% polyester	
PFOA-Free stain resistant	
8EY01/466446-001	Gust
8EY02/466446-002	Harmonica
8EY03/466446-003	Canopy
8EY04/466446-004	Dim
8EY05/466446-005	Peppercorn
8EY06/466446-006	Cauldron
8EY07/466446-007	Conquer
8EY08/466446-008	Rapids
8EY09/466446-009	Seawater
8EY10/466446-010	Baby
8EY11/466446-011	Elderberry
8EY12/466446-012	Iceberg
8EY13/466446-013	Tallgrass
8EY14/466446-014	Underground
8EY15/466446-015	Biome
8EY16/466446-016	Cask
8EY17/466446-017	Argan
8EY18/466446-018	Sundown
8EY19/466446-019	Ignite
8EY20/466446-020	Sultry
8EY21/466446-021	Sangria

## Price Category D

<b>Bluff - Maharam</b>	
54" wide	
100% polyurethane	
Ink-resistant protective top coat	
Polyester backing	
8I801/466489-001	Loom
8I802/466489-002	Helm
8I803/466489-003	Cruller
8I804/466489-004	Folklore
8I805/466489-005	Beguile
8I806/466489-006	Sherpa
8I807/466489-007	Teleport
8I808/466489-008	Annex
8I809/466489-009	Lorimer
8I810/466489-010	Cinema
8I811/466489-011	Zip
8I812/466489-012	Coach
8I813/466489-013	Supernova
8I814/466489-014	Pirate
8I815/466489-015	Academy
8I816/466489-016	Disco
8I817/466489-017	Equator
8I818/466489-018	Brink
8I819/466489-019	Scene
8I820/466489-020	Petrichor
8I821/466489-021	Exotic
8I822/466489-022	Fauna
8I823/466489-023	Calabash
8I824/466489-024	Fuscous
8I825/466489-025	Wildling
8I826/466489-026	Blitz
8I827/466489-027	Allspice
8I828/466489-028	Lumos
8I829/466489-029	Pilot
8I830/466489-030	Jukebox
8I831/466489-031	Dugout
8I832/466489-032	Claret
8I833/466489-033	Flamenco

<b>Mode – Maharam</b>	
54" wide	
80% post-consumer recycled polyester	
20% polyester	
PFOA-Free stain resistant finish	

- Maharam textiles are on assigned lead times **A** unless otherwise noted.
- Fabric numbers are listed as Herman Miller fabric number/Maharam fabric number.

Price category D continued on next page

# Maharam® Colors – Seating

continued

## Price Category D

continued

Mode continued	
ZMD01/466337-001	Stroll
ZMD02/466337-002	Intaglio
ZMD03/466337-003	Ominous
ZMD04/466337-004	Machine
ZMD05/466337-005	Talus
ZMD06/466337-006	Marsh
ZMD07/466337-007	Hollow
ZMD08/466337-008	Sycamore
ZMD09/466337-009	Clavicle
ZMD10/466337-010	Billygoat
ZMD11/466337-011	Spindle
ZMD12/466337-012	Lemon
ZMD13/466337-013	Oxeye
ZMD14/466337-014	Henge
ZMD15/466337-015	Goldenrod
ZMD16/466337-016	Cottontail
ZMD17/466337-017	Lioness
ZMD18/466337-018	Oriole
ZMD19/466337-019	Rust
ZMD20/466337-020	Carotene
ZMD21/466337-021	Blush
ZMD22/466337-022	Vermilion
ZMD23/466337-023	Alder
ZMD24/466337-024	Kermes
ZMD25/466337-025	Barberry
ZMD26/466337-026	Petal
ZMD27/466337-027	Valley
ZMD28/466337-028	Odyssey
ZMD29/466337-029	Ballpoint
ZMD30/466337-030	Toile
ZMD31/466337-031	Paradise
ZMD32/466337-032	Angelfish
ZMD33/466337-033	Denim
ZMD34/466337-034	Crush
ZMD35/466337-035	Jetty
ZMD36/466337-036	Saltwater
ZMD37/466337-037	Mallard
ZMD38/466337-038	Celtic
ZMD39/466337-039	Eucalyptus
ZMD40/466337-040	Bonsai
ZMD41/466337-041	Sassafras
ZMD42/466337-042	Yucca
ZMD43/466337-043	Lichen

## Price Category E

Article – Maharam	
54" wide	
100% vinyl	
ZAT08/458600-008	Marina
ZAT13/458600-013	Flume
ZAT14/458600-014	Storm
ZAT15/458600-015	Toast
ZAT19/458600-019	Fleece
ZAT22/458600-022	Stone
ZAT26/458600-026	Mercury
ZAT29/458600-029	Bluegrass
ZAT31/458600-031	Truffle
ZAT32/458600-032	Gravel
ZAT33/458600-033	Value
ZAT34/458600-034	Tint
ZAT35/458600-035	Snowflake
ZAT36/458600-036	Chalice
ZAT37/458600-037	Trail
ZAT38/458600-038	Pyramid
ZAT39/458600-039	Desert
ZAT40/458600-040	Lei
ZAT41/458600-041	Rouge
ZAT42/458600-042	Karma
ZAT43/458600-043	Opal
ZAT44/458600-044	Periwinkle
ZAT45/458600-045	Vampire
ZAT46/458600-046	Surf
ZAT47/458600-047	Plumage
Dwell - Maharam	
54" wide	
68% post-industrial recycled polyester	
32% post-consumer recycled polyester	
PFOA-Free stain resistant	
Latex backing	
89602/466419-002	Summit
89603/466419-003	Freeze
89604/466419-004	Poolside
89605/466419-005	Teal
89606/466419-006	Mojito
89608/466419-008	Thunder
89609/466419-009	Foil
89611/466419-011	Firecracker

Pick - Maharam	
58" wide	
100% polyester	
with stain resistant finish	
ZP202/466224-002	002
ZP204/466224-004	004
ZP209/466224-009	009
Roster - Maharam	
54" wide	
68% post-consumer recycled polyester	
32% polyester	
PFOA-Free stain resistant	
Acrylic backing	
ZR201/466445-001	Jacana
ZR202/466445-002	Wythe
ZR203/466445-003	Grosgrain
ZR204/466445-004	Ceremony
ZR205/466445-005	Breton
ZR206/466445-006	Frigate
Technic - Maharam	
56" wide	
60% post-industrial recycled polyester	
40% post-consumer recycled polyester	
PFOA-Free stain resistant finish	
Acrylic backing	
ZT301/466226-001	Cumin
ZT302/466226-002	Evergreen
ZT303/466226-003	Cobalt
ZT305/466226-005	Squirrel

## Price Category F

Apt – Maharam	
54" wide	
100% polyurethane/silicone	
Ink-resistant protective top coat	
Polyester backing	
82T12/466392-012	Iris
82T13/466392-013	Nocturnal
82T14/466392-014	Fluid
82T15/466392-015	Eden
82T16/466392-016	Galactic
82T17/466392-017	Shoreline
82T18/466392-018	Jade
82T19/466392-019	Garden
82T20/466392-020	Botanic
82T21/466392-021	Chartreuse
82T23/466392-023	Lyric
82T24/466392-024	Turmeric
82T25/466392-025	Bengal
82T26/466392-026	Core
82T27/466392-027	Mantle
82T28/466392-028	Sorbet
82T32/466392-032	Oak
82T33/466392-033	Castle
82T34/466392-034	Follow
82T35/466392-035	Elixir
82T36/466392-036	Charm
82T37/466392-037	Descend
82T38/466392-009	Sketch
82T39/466392-010	Glacier
82T40/466392-031	Fortress
82T41/466392-030	Lotus
82T42/466392-001	Coconut
82T43/466392-011	Cobblestone
82T44/466392-029	Bloom
82T45/466392-022	Crepe
82T46/466392-006	Hickory
82T47/466392-007	Constellation
82T48/466392-008	Labyrinth
82T49/466392-002	Vibe
82T50/466392-003	Stampede
82T51/466392-004	Lumber
82T52/466392-005	Gingerbread

Price category F continued on next page

- Maharam textiles are on assigned lead times **A** unless otherwise noted.
- Fabric numbers are listed as Herman Miller fabric number/Maharam fabric number.

# Maharam® Colors — Seating

continued

## Price Category F

continued

Brindle - Maharam	
58" wide	
100% polyester	
PFOA-free stain resistant	
Acrylic backing	
87101/466418-001 Calico	
87102/466418-002 Mauve	
87103/466418-003 Torch	
87104/466418-004 Burnt	
87105/466418-005 Barn	
87106/466418-006 Pharaoh	
87107/466418-007 Sandbur	
87108/466418-008 Jungle	
87109/466418-009 Inland	
87110/466418-009 Seagrass	
87111/466418-009 Watercolor	
87112/466418-009 Aquarium	
87113/466418-009 Drill	

Conduit - Maharam	
58" wide	
100% polyester	
PFOA-free stain resistant	
Acrylic backing	
87Z01/466428-001 Space	
87Z02/466428-002 Syrup	
87Z03/466428-003 Nimbus	
87Z04/466428-004 Greystone	
87Z05/466428-005 Fawn	
87Z06/466428-006 Ghost	
87Z07/466428-007 Caribbean	
87Z08/466428-008 Canal	
87Z09/466428-009 Bonfire	

Instill – Maharam	
54" wide	
100% polyurethane	
Ink-resistant protective top coat	
Polyester backing	
74M01/466351-001 Page	
74M02/466351-002 Limestone	
74M03/466351-003 Bobwhite	
74M04/466351-004 Loafer	
74M05/466351-005 Moor	
74M06/466351-006 Barley	
74M07/466351-007 Shaker	
74M08/466351-008 Doe	
74M09/466351-009 Ride	
74M10/466351-010 Squire	
74M11/466351-011 Tannin	
74M12/466351-012 Vitis	
74M13/466351-013 Sonar	
74M14/466351-014 Quail	
74M15/466351-015 Brittanica	
74M16/466351-016 Narwhal	
74M17/466351-017 Synth	
74M18/466351-018 Stowaway	
74M19/466351-019 Koala	
74M20/466351-020 Dorsal	
74M21/466351-021 Stealth	

Keen - Maharam	
54" wide	
61% polyester	
39% polyolefin	
PFOA-Free stain resistant	
Acrylic backing	
89N01/466433-001 Gaur	
89N02/466433-002 Lock	
89N03/466433-003 Elk	
89N04/466433-004 Oatmeal	
89N05/466433-005 Lakefront	
89N06/466433-006 Argent	
89N07/466433-007 Coyote	
89N08/466433-008 Eventide	
89N09/466433-009 Canal	
89N10/466433-010 Rosemary	
89N11/466433-011 Herb	
89N12/466433-012 Ruby	
89N13/466433-013 Loganberry	

Ledger – Maharam	
54" wide	
100% polyurethane	
V9G1/463770-001 001	
V9G2/463770-002 002	
V9G3/463770-003 003	
V9G4/463770-004 004	
V9GG/463770-017 017	
V9GQ/463770-025 025	
V9GS/463770-026 026	
V9GU/463770-028 028	
V9GV/463770-029 029	
V9GW/463770-030 030	
V9GX/463770-031 031	
V9GY/463770-032 032	
V9G18/463770-042 042	
V9G19/463770-043 043	
V9G20/463770-044 044	
V9G21/463770-045 045	
V9G22/463770-046 046	

Loop - Maharam	
57" wide	
48% post-industrial recycled polyester	
26% polyester	
26% post-consumer recycled polyester	
PFOA-Free stain resistant	
Acrylic Backing	
ZLL01/466469-001 Opossum	
ZLL02/466469-002 Foundation	
ZLL03/466469-003 Naval	
ZLL04/466469-004 Buoyant	
ZLL05/466469-005 Mockingbird	
ZLL06/466469-006 Dynasty	
ZLL07/466469-007 Zori	
ZLL08/466469-008 Wildfire	
ZLL09/466469-009 Floral	
ZLL10/466469-010 Penguin	

Multiply - Maharam	
58" wide	
57% post-consumer recycled polyester	
43% post-industrial recycled polyester	
PFOA-Free stain resistant	
Acrylic Backing	
82A01/466341-001 Winter	
82A02/466341-002 Encore	
82A03/466341-003 Swing	
82A04/466341-004 Contrast	
82A05/466341-005 Sterling	
82A06/466341-006 Daze	
82A07/466341-007 Sway	
82A08/466341-008 Sailor	
82A09/466341-009 Mystique	
82A10/466341-010 Deep	
82A11/466341-011 Craft	
82A12/466341-012 Town	
82A13/466341-013 Limit	
82A14/466341-014 Tamale	

Price category F continued on next page

- Maharam textiles are on assigned lead times A unless otherwise noted.
- Fabric numbers are listed as Herman Miller fabric number/Maharam fabric number.

# Maharam® Colors — Seating

continued

## Price Category F

continued

Pepper - Maharam
58" wide
49% polyester
41% post-industrial recycled polyester
10% post-consumer recycled polyester
PFOA-Free stain resistant
Acrylic Backing
8LW01/466486-001 Dojo
8LW02/466486-002 Marengo
8LW03/466486-003 Harlequin
8LW04/466486-004 Pavlova
8LW05/466486-005 Sedona
8LW06/466486-006 Achioté
8LW07/466486-007 Essence
8LW08/466486-008 Genome
8LW09/466486-009 Myriad
8LW10/466486-010 Terrarium

Runner Standard - Maharam
58" wide
57% post-industrial recycled polyester
43% post-consumer recycled polyester
ZRA07/466167-007 Bluff
ZRA09/466167-009 Grove
ZRA10/466167-010 Starboard
ZRA12/466167-012 Carousel

Sequence - Maharam
54" wide
100% solution-dyed polyolefin with silver-based antimicrobial
Z3101/466179-001 Driftwood
Z3104/466179-004 Alfresco
Z3105/466179-005 Plunge
Z3106/466179-006 Starboard
Z3107/466179-007 Veranda
Z3109/466179-009 Flare

Strum - Maharam
54" wide
100% polyurethane with silver-based antimicrobial
Z3301/466122-001 Overcast
Z3302/466122-002 Ridge
Z3304/466122-004 Pigeon
Z3307/466122-007 Bur
Z3308/466122-008 Abalone
Z3311/466122-011 Wheat
Z3312/466122-012 Lemongrass

## Price Category G

Compound - Maharam
54" wide
100% polyurethane silane-based antimicrobial
ZC201/466196-001 001
ZC203/466196-003 003
ZC204/466196-004 004
ZC205/466196-005 005
ZC206/466196-006 006
ZC207/466196-007 007
ZC208/466196-008 008
ZC209/466196-009 009
ZC210/466196-010 010
ZC211/466196-011 011
ZC212/466196-012 012
ZC213/466196-013 013
ZC214/466196-014 014
ZC215/466196-015 015
ZC216/466196-016 016
ZC217/466196-017 017
ZC218/466196-018 018
ZC219/466196-019 019

Emboss - Maharam
54" wide
100% polyurethane Polyester backing
ZEM01/466281-001 Bronze
ZEM02/466281-002 Brass
ZEM03/466281-003 Gold
ZEM04/466281-004 Platinum
ZEM09/466281-009 Ultraviolet
ZEM10/466281-010 Copper
ZEM11/466281-011 Molten

Fold - Maharam
54" wide
100% polyurethane Polyester backing
ZF101/466292-001 Jet
ZF102/466292-002 Chalk
ZF103/466292-003 Smoke
ZF104/466292-004 Putty
ZF105/466292-005 Fatigue
ZF106/466292-006 Splash
ZF107/466292-007 Apple
ZF108/466292-008 Moss
ZF109/466292-009 Graphite
ZF110/466292-010 Midnight

Gild - Maharam
54" wide
100% non-phthalate vinyl Ink-resistant protective top coat Polyester backing
8AR01/466432-005 Grapevine
8AR02/466432-009 Frosting
8AR03/466432-007 Smokey
8AR04/466432-003 Skylight
8AR05/466432-011 Sandstone
8AR06/466432-004 Hurricane
8AR07/466432-002 Wreath
8AR08/466432-001 Rainforest
8AR09/466432-012 Fudge
8AR10/466432-010 Lantern
8AR11/466432-006 Planet
8AR12/466432-008 Reflection

Price category G continued on next page

- Maharam textiles are on assigned lead times A unless otherwise noted.
- Fabric numbers are listed as Herman Miller fabric number/Maharam fabric number.

# Maharam® Colors — Seating

continued

## Price Category G

continued

Pare — Maharam
54" wide
52% wool
26% polyester
22% nylon
PFOA-free stain resistant finish
ZPR01/466359-001 Polaris
ZPR02/466359-002 Mountain
ZPR03/466359-003 Mineral
ZPR04/466359-004 Fresco
ZPR06/466359-006 Wink
ZPR07/466359-007 Concord
ZPR08/466359-008 Strawberry
ZPR09/466359-009 Solar
ZPR10/466359-010 Amulet
ZPR11/466359-011 Zest
ZPR12/466359-012 Elmwood
ZPR13/466359-013 Thyme
ZPR14/466359-014 Frost
ZPR16/466359-016 Denim
ZPR17/466359-017 Blueberry

Pick Crypton - Maharam
54" wide
100% polyester
Crypton finish and backing
ZP107/466235-007 Fresh
ZP108/466235-008 Cool

Runner - Maharam
54" wide
57% post-industrial recycled polyester
43% post-consumer recycled polyester
ZRF01/466108-001 Bluff
ZRF03/466108-003 Grove
ZRF04/466108-004 Starboard
ZRF05/466108-005 Plot
ZRF06/466108-006 Carousel

## Price Category H

Circles — Maharam
55" wide
70% cotton
30% polyester
ZT01/458310-001 Khaki
ZT02/458310-002 Fatigue
ZT03/458310-003 Document
ZT04/458310-004 Engine
ZT05/458310-005 Charcoal

Crosspatch — Maharam
54" wide
75% rayon
25% polyester
ZS01/458920-001 Song

Dot Pattern — Maharam
55" wide
71% cotton
29% polyester
ZK01/458300-001 Document
ZK02/458300-002 Taupe
ZK04/458300-004 Red
ZK05/458300-005 Navy

Offset — Maharam
54" wide
40% cotton
36% nylon
24% wool
ZQF03/465951-003 Coast
ZQF05/465951-005 Oasis

Small Dot Pattern — Maharam
55" wide
71% cotton
29% polyester
ZL01/458320-001 Document
ZL02/458320-002 Sand
ZL03/458320-003 Khaki
ZL04/458320-004 Taupe
ZL05/458320-005 Charcoal
ZL06/458320-006 Document
Reverse
ZL07/458320-007 Red
ZL08/458320-008 Yellow
ZL09/458320-009 Green

## Price Category I

Cursive — Maharam
54" wide
67% solution-dyed acrylic
33% solution-dyed polyester
PFOA-Free stain resistant
7CW01/466335-001 Fast
7CW03/466335-003 Beachcomb
7CW05/466335-005 Swift
7CW07/466335-007 Inkwell
7CW08/466335-008 Rubber

Study - Maharam
54" wide
73% solution-dyed acrylic
27% solution-dyed polyester
ZSY01/466269-001 001
ZSY02/466269-002 002
ZSY03/466269-003 003
ZSY04/466269-004 004
ZSY05/466269-005 005

- Maharam textiles are on assigned lead times **A** unless otherwise noted.
- Fabric numbers are listed as Herman Miller fabric number/Maharam fabric number.

# Maharam® Colors — Seating

continued

## Price Category J-K

No fabrics available at this time.

## Price Category L

### Minicheck - Maharam

55" wide  
 78% cotton  
 22% polyester  
 PFOA-Free stain resistant finish  
 ZMK01/466268-001 Black/  
 White

## Price Category M

### Fruit - Maharam

54" wide  
 55% cotton  
 32% nylon  
 13% post-consumer recycled  
 polyester  
 PFOA-Free stain resistant finish  
 Acrylic backing  
 ZF201/466262-001 Opal  
 ZF202/466262-002 Lime  
 ZF203/466262-003 Olive  
 ZF204/466262-004 Sky  
 ZF207/466262-007 Russet

## Price Category N-Z

No fabrics available at this time.

- Maharam textiles are on assigned lead times **A** unless otherwise noted.
- Fabric numbers are listed as Herman Miller fabric number/Maharam fabric number.

For more information about our products and services or to see a list of dealers, please visit us at [HermanMiller.com](http://HermanMiller.com) or call (800) 851 1196.

© 2023 Herman Miller, Inc., Zeeland, Michigan

#### Distribution Rights

Working together since 1956, Herman Miller and Vitra are the authentic sources of designs by Charles and Ray Eames, Alexander Girard, and George Nelson. All the designs shown in this book are protected by law. Herman Miller has obtained all rights to make and sell these designs. Also, Herman Miller holds exclusive worldwide manufacturing and distribution rights for these products with the following exceptions:

Charles and Ray Eames, George Nelson, and Alexander Girard—Worldwide distribution rights for furniture in all areas except Europe and the Middle East. For those areas, please contact Vitra.

Isamu Noguchi—Worldwide distribution rights for the Noguchi Rudder Table. Distribution rights for the Noguchi Table in North America and Central America only. For all other areas, please contact Vitra.

Magis—Exclusive distribution rights in the US and Canada. For all other areas, please contact Magis.

© **HermanMiller**, 3D Intelligent, 8Z Pellicle, AO, Action Office, Aeron, Aside, Bubble Lamps, Canvas Office Landscape, Caper, Celle, Cosm, Co/Struc, Daisyone, Distil, Eames, Eco-Dematerialized, Embody, Envelop, Ethospace, Exclave, Fine-Tune, FlexFront, Flo, Formcoat, Formwork, Ground Cloth, Intent, Kinemat, Layout Studio, Lino, Live Unframed, Living Office, Maharam, Meridian, Mirra, Motia, Nelson, Pari, Pellicle, Perspectives, Plex, PostureFit, PostureFit SL, Public Office Landscape, Sayl, Setu, Striad, Tu, Ubi, Verus, Wishbone, and Y-Tower are among the registered trademarks of Herman Miller, Inc., and its owned subsidiaries.

™ About Face, AireWeave, Airia, Ambit, Asari Chair by HermanMiller, Backfit, Bubbletack, Burdick Group, Butterfly Back, Canvas Vista, Cellular Suspension, Commend, Compass, Connect, DOT, Duracare, Durawrap, EnhancedAccess, Everywhere, Flex-Edge, Flute, Harmonic, Headway, Herman Miller Select, Hopsak 2, Iota, Keyless Entry, Latitude, Logic Mini, Logic Power Access Solutions, Lyriss, Lyriss 2, Made-to-Measure Storage, Mora, Multiscrim, Nevi, OE1, OE1 Workspace Collection, Overlay, Pixelated Support, Pronta, Renew, Sense, Soft Pad, Stackable, Stackable Storage, Swoop, Thrive, Tone, TriFlex, Twist, Wireframe, and Zeph are among the trademarks of Herman Miller, Inc., and its owned subsidiaries.

SM Herman Miller Options is among the service marks of Herman Miller, Inc.

AAP™ is a trademark of Extron Electronics.

Alexander Girard® is a registered trademark of The Alexander Girard Estate.

Chemsurf® is a registered trademark of Wilsonart International.

Corian® is a registered trademark of E. I. du Pont de Nemours and Company Corporation.

Crypton® is a registered trademark of Crypton, Inc.

DACRON® is a registered trademark of INVISTA S.a r.l.

Danzer® is a registered trademark of Danzer Holding AG.

Decora® is a registered trademark of Leviton Manufacturing Co., Inc.

Edelman® Leather is a registered trademark of Edelman Leather, Inc.

Extron® is a registered trademark of RGB Systems, Inc.

FENIX NTM® is a registered trademark of Arpa Industriale S.p.A.

FLEXNET™ is a trademark of Milliken & Company.

Floor Saver Glide® is a registered trademark of Carpin Manufacturing, Inc.

Forest Stewardship Council® is a registered trademark of the Forest Stewardship Council A.C. (FSC). We are FSC® certified (FSC® C102895).

FSC® is a registered trademark of the Forest Stewardship Council A.C. (FSC).

Geiger® is a registered trademark, and Bumper™, Saiba™, and Ward Bennett™ are trademarks, of Geiger International.

Hang-It-All® is a registered trademark of Lucia Eames Demetrios, d.b.a. Eames Office.

Holophane® is a registered trademark of Holophane.

Ingeo™ is a trademark of Cargill Dow LLC.

iPad® and Mac mini® are registered trademarks of Apple Inc.

Leviton® is a registered trademark of Leviton Manufacturing Co., Inc.

LifeSize® is a registered trademark of LifeSize Communications, Inc.

Logitech G® is a registered trademark of Logitech International S.A.

Magis®, Bombo®, and Me Too® are registered trademarks of Magis S.p.A.

MicrobeCare™ is a trademark of Parasol Medical LLC.

Microsoft® and Natural® Keyboard are registered trademarks of Microsoft Corporation.

Noguchi® and the Noguchi table configuration (trade dress) are registered trademarks, and Rudder Table™ is a trademark, of The Isamu Noguchi Foundation and Garden Museum.

Place Textiles® is a registered trademark of Place Textiles.

Sunbrella® is a registered trademark of Glen Raven, Inc.

SuperSeat™ is a trademark of Dahti Seating, a division of ITW.

Valor™ is among the trademarks owned by Nemschoff, Inc.