



GSA prices effective January 30, 2023
(based on October 3, 2022, commercial price list)
Published July 2023

Workspaces

Public Office Landscape®

General Services Administration Federal Supply Service Authorized Federal Supply Schedule Price List

Online access to contract ordering information, terms and conditions, up-to-date pricing, and the option to create an electronic delivery order is available through GSA Advantage!®, a menu-driven database system.

The Internet address for GSA Advantage! is www.gsaadvantage.gov.

Office Furniture
FSC/PSC 7110/7125
Contract Number: GS-03F-036DA
UEI: Q2K3MSZ843D8
Contract Period: December 21, 2015—December 20, 2025

MillerKnoll, Inc.
855 East Main Avenue
Zeeland, Michigan 49464
(616) 654 3000 Phone
(616) 654 8278 Fax
www.HermanMiller.com/government

Business Size: Large

Contract Information

1a. Special Item Numbers (SIN)

SIN 33721

Furniture Systems, Computer Furniture, Filing and Storage, Tables and Accessories, Upholstered Seating and Multi-Purpose Seating, Project Management, Reconfiguration and Relocation Services, Design/Layout and Installation Services

SIN 33721P

Packaged Offices

SIN 337127

Modular Laboratory Furniture Systems

SIN OLM

Order-Level Materials (OLMs)

This SIN is only for products and/or services used in direct support of the purchase of new furniture. It requires approval from the ordering Contract Officer. Please contact your local MillerKnoll Inc. representative to discuss the appropriate use of this SIN.

SIN 532289

Leasing

Contact MillerKnoll Inc participating government dealer for current leasing information.

1b. Lowest Priced Model

SIN 33721: G9999.B \$10

1c. Not applicable

2. Maximum Order

SIN 33721, 337127, NEW, OLM

\$250,000 net product value

SIN 33721P

\$250,000 net value

3. Minimum Order

\$100 net

4. Geographic Coverage

Continental U.S.

Orders for Alaska, Hawaii, and Puerto Rico will be shipped F.O.B. inland carrier point of exportation.

5. Point of Production

Zeeland, Ottawa County, Michigan

Spring Lake, Ottawa County, Michigan

6. Pricing

Prices shown are list. Discounts include Industrial Funding Fee.

SIN 33721

Standard Lead Time, Single Order Net Purchase \$100 - 250,000, includes approved Herman Miller Options Products.

Product Line	Discount From List
Action Office 1	73.8%
Action Office 2	73.8%
Aeron	64.5%
Ambit Workspace Solutions	74.3%
Aside	64.2%
C-Style Overhead Storage	73.8%
Canvas Office Landscape Channel	74.8%
Canvas Office Landscape Dock	74.8%
Canvas Metal Desk	74.8%
Canvas Office Landscape Metal Storage	74.8%
Canvas Office Landscape Private Office	74.8%
Canvas Office Landscape Wood Storage	74.8%
Canvas Office Landscape Vista	74.8%
Canvas Office Landscape Wall	74.8%
Caper	61.5%
Commend Nurses Station	73.3%
Cosm	61.7%
Eames® Conference & Dining Tables	73.6%
Easton Family	54.91%
Embody	59.7%
Ethospace System	73.8%
Everywhere™ Tables	73.8%
Exclave	61.7%
Headway™ Tables	73.8%
Intent Solution	58.7%
Layout Studio®	60.7%
Lino	63.7%
Meridian Laterals	67.3%
Meridian Pedestals	64.2%
Meridian Towers	62.7%
Meridian Storage	62.7%
Mirra 2	61.7%
Motia Tables	73.8%
Nevi™ Tables	73.8%
Nevi Link	73.8%
OE1 Boundary	72.8%
OE1 Micro Packs	73.8%
OE1 Storage	72.8%
OE1 Tables and Benching	73.8%
Overlay™	62.7%
Plex® Lounge Furniture	59.5%
Public Office Landscape	61.7%
Renew™ Tables	73.8%
Renew Link	73.8%
Sayl	62.2%
Setu	59.7%
Swoop Lounge Furniture	60.7%
Thrive Portfolio	62.0%
Thrive Portfolio-CBS Products Extension	62.0%
Tu Lateral Files	74.3%
Tu Pedestals	73.8%
Tu Storage	74.3%
Tu Towers	74.3%
Tu Wood Cases	74.3%
Tu Wood Cubbies	74.3%
Tu Wood Credenzas	74.3%
Tu Wood Pedestals	74.3%
Tu Wood Towers	74.3%
Valor™ Family	54.91%
Verus	63.7%
Zeph	60.20%

Contract Information

continued

Services

Please refer to section 19 for Terms and Conditions of Installation/ Reconfiguration and Relocation Services.

Project Management

Services under this SIN may be used only in conjunction with the purchase of new furniture. Please contact your local MillerKnoll Inc. representative to discuss the available labor categories (listed below). The hourly rates listed are "Not To Exceed" or "NTE" values.

Furniture Project Manager: \$64.75 per hour
Furniture Project Coordinator: \$49.00 per hour
Build-Out Project Manager: \$80.00 per hour

Reconfiguration and Relocation Services

Reconfiguration and Relocation Services will be provided by MillerKnoll Inc. or its participating dealer based on a fee not to exceed \$55 per hour.

See * Additional Notes for Installation & Reconfiguration and Relocation Services.

Design/Layout

Design service will be provided by MillerKnoll Inc. or its participating dealer based on a fee not to exceed \$65 per hour.

Installation Services

Installation Services will be provided by MillerKnoll Inc. or its participating dealer based on a fee not to exceed \$55 per hour (\$82.50 per hour for after-hours Installation).

See * Additional Notes for Installation & Reconfiguration and Relocation Services.

SIN 337127

Standard Lead Time, Single Order Net Purchase \$100 - 250,000, includes approved Herman Miller Options Products.

Product Line	Discount From List
Action Lab	58.5%
Compass System	58.5%
Co/Struc System	58.5%
Mora System	58.5%
Bedside Cabinets	58.5%

SIN 33721P

Packaged Office Furniture - Maximum Order \$250,000 (net).

Includes packaged furniture solutions for customers needing to furnish an office.

7. Quantity Discounts

Reference item #6.

8. Payment Terms

Net 30 days

9. Government Commercial Credit Card

- Government commercial credit cards are accepted below the micropurchase threshold.
- Government commercial credit cards are accepted above the micropurchase threshold.

10. Foreign Items

None

11. Time of Delivery

- 90 day ARO
- Expedited delivery: Items listed in the 10-Day section of the catalogs are available for expedited delivery.
- Overnight/2-day delivery: Select items may be available for overnight or 2-day delivery. Contact MillerKnoll Inc. or a participating dealer for availability and rates.
- Urgent requirements: Agencies may contact contractor or participating dealer to request faster delivery.

12. F.O.B.

F.O.B. destination except Alaska, Hawaii, and Puerto Rico, which will be shipped F.O.B. inland carrier point of exportation.

13. Ordering Address

- MillerKnoll Inc.
Government Customer Care 0161
855 East Main Avenue
Zeeland MI 49464.
- For supplies and services, the ordering procedures information on Blanket Purchase Agreements (BPA's) are found in Federal Acquisition Regulation (FAR) 8.405-3.

14. Payment Address.

MillerKnoll Inc.
22764 Network Place
Chicago, IL 60673-1227

15. Warranty

MillerKnoll Inc. commercial warranty applies.

16. Export Packing Charge

Prices supplied on request.

17. Terms and Conditions of Government Purchase Card Acceptance

Accepted above and below the micropurchase level.

18. Rental Maintenance and Repair Terms

Not applicable

Contract Information

continued

19. Terms and Conditions of Installation/Reconfiguration and Relocation Services

* Additional Notes for Installation & Reconfiguration and Relocation Services:

FOB Destination (Drop Ship): Price includes product delivery to the site, brought to the tailgate of the truck. The purchaser is responsible for unloading.

Prices effective up to the maximum order by SIN only. Above the MO, pricing shall be negotiated on a case-by-case basis between the client and local dealer.

Standard Services are Subject to the Following Conditions:

Installation will be performed during normal weekday working hours.

Adequate facilities for delivery, unloading, moving and staging/storing the product during the installation process shall be provided.

Service work will not be hindered by other trades.

Electric, heat, and adequate elevator service will be furnished without charge.

The immediate installation area shall be complete and free of debris including the carpet/flooring before installation commences.

Any work requiring a licensed electrician is the responsibility of the buyer.

Additional Charges May Apply For:

Major Metro Markets and any non-ground floor installation.

Major Metro Markets include large population centers and urban environments.

Installation in a clinical/medical environment.

Special restrictions or limits established by local laws, ordinances or the directions of the buyer, including but not limited to restrictions on transportations of materials, street access to the job site and/or dock facilities.

Installations outside of a 50 mile radius of the servicing dealer.

Local Prevailing Wage and/or Union Labor Rates.

Any additional charges shall be quoted by the dealer and approved by the buyer prior to performance of the work.

20. Terms and Conditions of Repair Parts

Not applicable

21. Service and Distribution Points

For service and distribution points nearest you, call (800) 851 1196.

22. Participating Dealers

Access Herman Miller web site for current list of participating dealers: www.HermanMiller.com/where-to-buy/contact-a-dealer/. Select your market by using the filter.

23. Preventive Maintenance

Not applicable

24a. Special Attributes.

2022

MillerKnoll earns its 15th consecutive perfect score in Human Rights Campaign Foundation's 2022 Corporate Equality Index.

2021

The OE1 Trolley and Micro Packs are both winners of the 2021 Archiproducts international design competition in the Office Category.

MillerKnoll is named to Michigan's Best and Brightest in Wellness List for 2021.

MillerKnoll is awarded Platinum Rating in CSR by EcoVadis.

OE1 is named winner of Wallpaper's "Most Futuristic Furniture" Category as part of their first-ever Smart Space Awards.

OE1 receives the Workplace category award from Fast Company's 2021 Innovation by Design Awards.

MillerKnoll is named to Fast Company's Annual List of the World's Most Innovative Companies for 2021.

MillerKnoll is recognized as a "Disclosure Leader" by the Chemical Footprint Project (CFP).

MillerKnoll earns its 14th consecutive perfect score in Human Rights Campaign Foundation's 2021 Corporate Equality Index.

MillerKnoll is named to Newsweek's List of America's Most Responsible Companies 2021.

Great Lakes Women's Business Council awards MillerKnoll for "Excellence in Supplier Diversity" in the Best In Class category.

2020

Herman Miller is recognized with a 2020 FSC® Leadership Award for our commitment to responsible forestry management.

Herman Miller is named one of Investor's Business Daily Top 50 Best ESG (Environmental, Social, and Corporate Governance) Companies.

Working Mother names Herman Miller as one of the Best Companies for Dads.

Herman Miller is awarded Platinum Rating in CSR by EcoVadis.

Herman Miller is named Diversity Inc 2020 Noteworthy Company for recruitment efforts, employee development opportunities, leadership accountability, and supplier diversity.

Cosm, by Studio 7.5, receives an iF Gold Award in the Office and Industry category at the iF World Design Awards 2020.

Contract Information

continued

Herman Miller earns its 13th consecutive perfect score in Human Rights Campaign Foundation's 2020 Corporate Equality Index.

2019

Mora System casework, designed by Collective Ten for Herman Miller, receives silver in the Industrial and Life Science Design/Medical Furniture category at the European Product Design Awards.

Mora System casework is awarded GOOD DESIGN Award 2019, selected for design excellence and innovation.

National Minority Supplier Diversity Council (NMSDC) names Herman Miller as the 2019 Class 1 Corporation of the Year for leadership in supplier diversity.

TIME Magazine names Cosm to its list of 100 Best Inventions of 2019.

Herman Miller is named #12 Overall and #2 in Manufacturing on Investor's Business Daily Best ESG (Environmental, Social, Governance) Companies.

Herman Miller is recognized as a silver level Certified Veteran-Friendly Employer by the Michigan Veterans Affairs Agency for a commitment to veteran hiring, retention, and development.

For the second year in a row, Herman Miller receives a Gold Medal from EcoVadis in recognition of Corporate Social Responsibility achievement measured in categories of environment, labor and human rights, ethics, and sustainable procurement.

Herman Miller is named "Frontrunner" in Chemical Footprint Project by Clean Production Action for our chemical management policies and practices.

Herman Miller receives International Interior Design Association and Contract's best showroom design award in the "Large Showroom" category at NeoCon.

Herman Miller earns its 12th consecutive perfect score in Human Rights Campaign Foundation's 2019 Corporate Equality Index.

Cosm, designed by Studio 7.5 for Herman Miller, receives a Red Dot Best of the Best Product Design Award in the "Office Chairs" category.

Lino, designed by Sam Hecht and Kim Colin for Herman Miller, receives an iF Design Award in the Product Design category.

2018

Overlay, designed by Birsell+Seck, receives Interior Design Best of Year Award in the Partitions and Wall Systems category.

Herman Miller receives the "Corporation of the Year" in consumer products award from the Michigan Minority Supplier Development Council.

Herman Miller achieves the Advanced Excellence in Supplier Diversity Award from the Great Lakes Women's Business Council for doing business with women-owned suppliers.

Great Lakes Women's Business Council awards Herman Miller for "Excellence in Supplier Diversity" in the Advanced category.

WEConnect awards Herman Miller an Honorable Mention for global supplier diversity initiatives.

As one of the top-scoring companies in the industry for the 14th consecutive year, Herman Miller has qualified for inclusion in RobecoSAM's 2018 Sustainability Yearbook and receives the Silver Class distinction for excellent sustainability performance—economic, environmental, and social.

For the 11th consecutive year, Herman Miller receives a perfect score on the Human Rights Campaign Foundation's Corporate Equality Index and is designated as Best Place to Work for LGBT equality. This report evaluates U.S. companies in terms of diversity, particularly LGBT-related policies and practices.

Herman Miller receives Gold Medal from EcoVadis in recognition of Corporate Social Sustainability achievement measured in categories of environment, labor and human rights, ethics, and sustainable procurement. EcoVadis operates the first web-based collaborative platform that allows companies to assess the environmental and social performance of their global suppliers.

Aeron receives Good Design Award from The Chicago Athenaeum Museum of Architecture and Design.

The Cosm Chair wins Mix Interiors "Product of the Year—Task" award.

2017

Herman Miller receives "Rising Star Award" from the Michigan Veterans Affairs Agency (MVAA) for exhibiting new and novel approaches to veteran recruitment and hiring.

Herman Miller is named the 2017 "Corporation of the Year" in the consumer products sector by the Michigan Minority Supplier Development Council (MMSDC).

Herman Miller receives a 2017 SEAL (Sustainability, Environmental Achievement and Leadership) Business Sustainability Award. SEAL Award winners are determined by a holistic methodology measuring applicants against established benchmarks that demonstrate impact and progress toward creating a healthy planet and a sustainable future.

Contract Information

continued

Herman Miller earns the 4 Star Diversity Visionary Award. This award celebrates the diversity, equality, and inclusion work of Herman Miller. The award is presented at the annual Diversity Equity Inclusion Summit, held by the Grand Rapids Area Chamber of Commerce.

Herman Miller is named one of the Best and Brightest in Wellness for the 5th year in a row.

Herman Miller earns its 10th consecutive perfect score in Human Rights Campaign Foundation's 2017 Corporate Equality Index.

As one of the top-scoring companies in the industry for the 13th consecutive year, Herman Miller has qualified for inclusion in RobecoSAM's 2017 Sustainability Yearbook and receives the Bronze Class distinction for excellent economic, environmental, and social sustainability performance. The selection criteria for inclusion in the Yearbook becomes more rigorous each year, and only the top 15 percent of companies within each industry are selected.

Herman Miller once again earns the WorldatWork Seal of Distinction, a unique standard of excellence in work-life effectiveness that shows we provide a distinct, mutually beneficial workplace experience. Herman Miller is the only furniture manufacturer among the 160 companies across the U.S. and Canada honored with the award.

Herman Miller's Mora wins Nightingale Silver Award in the "Furniture Collections" category at the 2017 Healthcare Design Conference.

2016

Herman Miller earns 9th consecutive perfect score in Human Rights Campaign Foundation's Corporate Equality Index and is designated as Best Place to Work for LGBT equality.

Herman Miller is recognized as the Business of the Year at the Annual Meeting of the West Michigan Environmental Action Council (WMEAC) for being an outstanding partner in support of the growth of WMEAC's programs. WMEAC's award goes to the business with the greatest depth and breadth of support, unwavering dedication to environmental action in West Michigan, and a strong corporate commitment to environmental advocacy.

The 101 Best and Brightest Sustainable Companies once again (5th consecutive year) recognizes Herman Miller as an organization in Michigan (and for the first time, in the nation) that exhibits leadership and innovation in its approach to sustainability. This award celebrates those companies that are making their businesses more sustainable, the lives of their employees better, and the community, both locally and globally, more responsible as a whole.

Herman Miller is recognized by the Michigan Minority Supplier Development Council (MMSDC) as a "Corporation of the Year". Additionally, we are the only West Michigan company this year to receive an "Ambassadors Championing Excellence" Award from the

MMSDC.

Herman Miller is recognized with "2016 Excellence in Supplier Diversity Award" from the Great Lakes Women's Business Council.

Herman Miller is recognized as a 2016 Healthiest 100 Workplace in America, ranking 49th in the country for our commitment to health and exceptional corporate wellness programming.

Herman Miller receives the Best and Brightest in Wellness Award for the 4th year in a row. This program is an innovative initiative that recognizes and celebrates quality and excellence in health awareness.

The Michigan Occupational Safety and Health Administration renews Herman Miller's "Star" status, the highest workplace safety and health designation, for the Hickory facility in Spring Lake.

Plex Lounge Furniture from Herman Miller receives #MetropolisLikes award at NeoCon 2016.

Plex Lounge Furniture from Herman Miller receives Interior Design HIP Award for Workplace Seating/Lounge at NeoCon 2016.

Herman Miller is named a 2016 Women on Boards Winning Company. Companies selected for this recognition are considered champions of board diversity as 20 percent or more of their board seats are occupied by women.

Herman Miller is selected for inclusion in the 2016 RobecoSAM Sustainability Yearbook for the 12th consecutive year.

Herman Miller again earns the WorldatWork Work-Life 2016 Seal of Distinction. This award identifies organizations that focus on programs that promote work-life balance and overall well-being.

24b. Section 508 Compliance

Not applicable

25. Data Universal Numbering System (DUNS): 00-601-2801

26. Registered in System for Award Management (www.SAM.gov) Database

Unique Entity ID: Q2K3MSZ843D8

27. Cancellation

Prior to production, no cancellation charge will apply. After production, only actual cost incurred that the contractor can demonstrate if items are sold after 3 months.

Contract Information

continued

28. Restocking Charges

Agencies must notify the contractor for authorization prior to returning any items. The customer agency will be required to pay all packaging and return freight charges. A restocking fee of 50% for Systems Furniture and 35% for all other product lines will be charged for any returned items.

Returns and restocking policy is not applicable to products under SIN 337127.

MillerKnoll Inc. Miscellaneous Information:

Federal ID Number: 38-0837640

Commercial and Government Entity Code (CAGE): 40636

Data Universal Numbering System (DUNS) 00-601-2801

Commercial Entity Code (CEC): 00702290J

Introduction	page 2
Public Office Landscape®	3
Seating	5
Desking and Storage	14
Power	16
Tables	32
Space Delineation	38
Indices	41
By Name	41
By Number	43
Appendices	
20-Day or Less/Assigned Lead-Time Order Information	
Proprietary Textiles Application Chart-Workspaces	
Proprietary Textile Colors-Workspaces	
Proprietary Textiles Application Chart-Seating	
Proprietary Textile Colors-Seating	
Maharam® Application Chart-Seating	
Maharam Colors-Seating	
For the latest materials information, refer to the Materials pages on HermanMiller.com.	

Introduction

A Note on the Organization of This Book

There are a few signals that will help you understand the organization of this book. Once you know them, you should be able to find your way around easily.

Like a newspaper, this book is formatted with columns of text and illustrations that run vertically.

Information wraps from one column to the next and continues for as many pages as it needs to.

Black bars are clues.

A black bar at the top of a page signals the start of information about a product.

This information is divided into two sections, each signaled by a black bar. Product Information includes a description, additional notes, and dimensional drawings. Specification Information, which always begins at the top of a column, includes a series of steps. Each step represents a decision you need to make in order to complete your product number. Steps must be followed sequentially. The number of pages needed to complete information on a product varies; some will be complete in one page; others may fill three or four pages. Just continue going through the steps until you run into the next product, signaled by the black bar at the top of the page.

Black tabs running along the outside edge of the page help you locate what section you are in or what section you want to go to. You can thumb forwards or backwards to find a section; tabs and text appear on both sides of the page.

The additional pages in the back of the book include the appendices and indices. They are signaled by a long black bar running along the outside edge of the page.

The index is presented two ways.

The first index is in alphabetical order by product name. It can be helpful if you are new to the products and numbering scheme or if you are looking for a type of product, such as work chair or round table.

The second index is by product number. It lists, in alphanumeric order, the base product number, typically a five-digit number.

This book is effective January 30, 2023, subject to change without notice. Products may be purchased from authorized Herman Miller dealers who will quote prices upon request. For more information about our products and services or to see a list of dealers, visit www.HermanMiller.com.

All prices are list prices in US Dollars. Additional services, such as planning services, design, storage, and installation, are not included and must be added to these prices when the additional services are requested.

Illustrations, specifications, and prices are based on the latest information at the time of publication. The right is reserved to make changes at any time without notice in prices, fabrics, finishes, materials, specifications, and models, and also to discontinue models and finishes.

Dimensions shown in the drawings are engineering drawing dimensions rounded up to the nearest $\frac{1}{8}$ ". Product is shipped set up or knocked down. Products that include "Shipped knocked down" in the description require some assembly. If this statement does not appear in the description, the product is shipped assembled.

Service problems are normally handled by a Herman Miller authorized dealer. Where this cannot be accomplished on a local level, service problems should be referred to the Customer Care Representative for your region, Herman Miller, Inc., Zeeland, Michigan 49464.

20-Day or Less/Assigned Lead-Time Shipments

All products and options in this price book not designated by an Assigned Program icon  will ship in **20 business days or less** after being acknowledged by Herman Miller.

Products and options designated by an  are on the assigned lead-time program and may ship in 20 days, less than 20 days, or more than 20 days from order acknowledgement.

Seating

Desking and Storage

Power

Tables

Space Delineation

Social Chair

BVS1N.

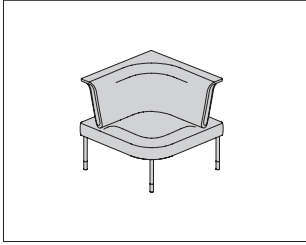

Product Information

Description

This chair has an upholstered foam seat on an expanded polypropylene base, with a Network-wrapped suspension back. The chair can be freestanding next to a desk or connected to other social chairs or café tables. It accepts the attachment of screens. It comes with legs for freestanding applications or without legs when attached to other chairs. Legs have glides that provide up to 2" of adjustment.

Notes

- Chair supports attachment of 2 screens.
- When specified without legs, order seating legs (BVS3.) separately.
- When specifying leg (L) option, legs are welded to seat frame and are not reconfigurable.
- Network color and back loop frame color will match.
- Seat fabric is railroaded.
- Customers Own Material can only be specified for seat fabric. See Customers Own Material Order Information in appendices.
- Seat accepts Customer's Own Material (COM). Yardage is estimated for nondirectional 54"-wide fabrics. Order 2.16 yards of fabric per cushion. For information on multiple quantities or directional fabrics, contact COM Department. See Order Information in Appendices.

Dimensions

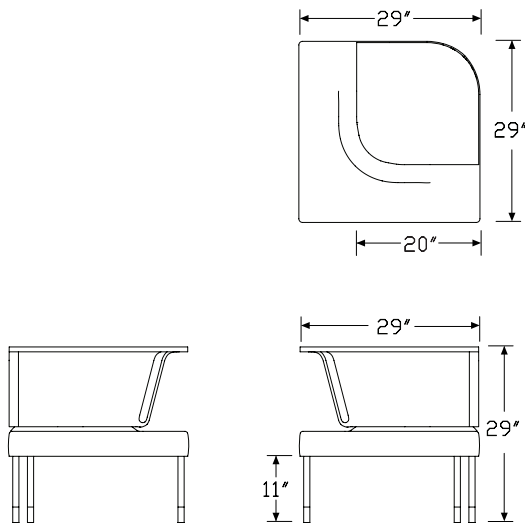

Specification Information

Step 1.

BVS1N.

Step 2. Seat Style

- L** left
- R** right

Step 3. Leg Option

- L** legs
- N** no legs

Step 4. Fire Retardancy

For not fire retardant (*), skip this step.
not fire retardant

Prices for Steps 1-4.

		*
BVS1N.L	L	\$2616
	N	\$2616
	R L	\$2616
	N	\$2616

Step 5. Glide Option

For legs (L)

- C** nylon glide, carpet floors + \$0

Step 6. Leg Finish

For legs (L)

- G1** graphite + \$0
- 91** white + \$0
- MS** metallic silver + \$0

Step 7. Glide Finish

For graphite (G1)

- BK** black + \$0

For white (91)

- 8Q** folkstone grey + \$0

For metallic silver (MS)

- 63** fog + \$0

Step 8. Back Frame Finish		
91	white	+\$0
G1	graphite	+\$0
RO	red	+\$0
97	twilight	+\$0
63	fog	+\$0
79	green apple	+\$0
WBY	wild berry	+\$0

Step 9. Back Knit Color		
Price Category 4		
<i>For white (91)</i>		
1A901	network warm white	+\$0
1A902	network fog	+\$0
1A903	network red	+\$0
1A904	network wild berry	+\$0
1A905	network green apple	+\$0
1A906	network twilight blue	+\$0
1A907	network graphite	+\$0
1DL01	dialogue light brindle	+\$0
1DL02	dialogue dark brindle	+\$0

Price Category 4		
<i>For graphite (G1)</i>		
1A901	network warm white	+\$0
1A902	network fog	+\$0
1A903	network red	+\$0
1A904	network wild berry	+\$0
1A905	network green apple	+\$0
1A906	network twilight blue	+\$0
1A907	network graphite	+\$0
1DL01	dialogue light brindle	+\$0
1DL02	dialogue dark brindle	+\$0

Price Category 4		
<i>For red (RO)</i>		
1A901	network warm white	+\$0
1A902	network fog	+\$0
1A903	network red	+\$0
1A904	network wild berry	+\$0
1A905	network green apple	+\$0
1A906	network twilight blue	+\$0
1A907	network graphite	+\$0

Price Category 4		
<i>For twilight (97)</i>		
1A901	network warm white	+\$0
1A902	network fog	+\$0
1A903	network red	+\$0
1A904	network wild berry	+\$0
1A905	network green apple	+\$0
1A906	network twilight blue	+\$0
1A907	network graphite	+\$0

Price Category 4		
<i>For fog (63)</i>		
1A901	network warm white	+\$0
1A902	network fog	+\$0
1A903	network red	+\$0
1A904	network wild berry	+\$0
1A905	network green apple	+\$0
1A906	network twilight blue	+\$0
1A907	network graphite	+\$0
1DL01	dialogue light brindle	+\$0
1DL02	dialogue dark brindle	+\$0

Price Category 4		
<i>For green apple (79)</i>		
1A901	network warm white	+\$0
1A902	network fog	+\$0
1A903	network red	+\$0
1A904	network wild berry	+\$0
1A905	network green apple	+\$0
1A906	network twilight blue	+\$0
1A907	network graphite	+\$0

Price Category 4		
<i>For wild berry (WBY)</i>		
1A901	network warm white	+\$0
1A902	network fog	+\$0
1A903	network red	+\$0
1A904	network wild berry	+\$0
1A905	network green apple	+\$0
1A906	network twilight blue	+\$0
1A907	network graphite	+\$0

Social Chair *continued*

Step 10. Seat Fabric	
Price Category 1	+\$0
Price Category 10	+\$686
Price Category 2	+\$30
Price Category 3	+\$55
Price Category 4	+\$108
Price Category 5	+\$161
Price Category 7	+\$346
Price Category 8	+\$455
Price Category 9	+\$505
Price Category C	+\$128
Price Category F	+\$253
Price Category I	+\$638

Sectional Seating

BVS2N.

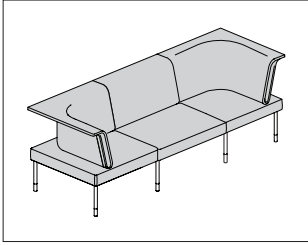

Public Office Landscape® Seating

Product Information

Description

The sectional seat comes in straight, right-corner, and left-corner styles. It has an upholstered foam seat on an expanded polypropylene base, with a Network-wrapped suspension back. Sectional seats connect to other sectional seats and social chairs and accept the attachment of screens.

Notes

Order seating legs (BVS3.) separately.

Corner-style seats support 2 screens. Straight-style seats support 1 screen.

Network color and back loop frame color will match.

Seat fabric is railroaded.

Customers Own Material can only be specified for seat fabric. See

Customers Own Material Order Information in appendices.

Seat accepts Customer's Own Material (COM). Yardage is estimated for nondirectional 54"-wide fabrics.

Seat style—Yardage

CR—2.16

CL—2.16

29—2.21

For information on multiple quantities or directional fabrics, contact COM Department. See Order Information in Appendices.

Dimensions

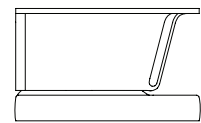
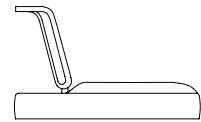
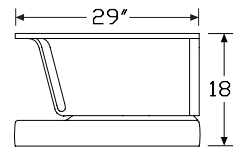
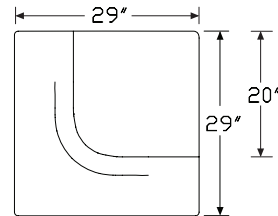
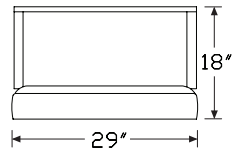
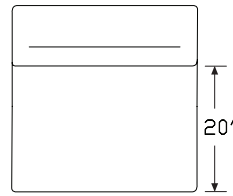

Sectional Seating *continued*

Specification Information

Step 1.

BVS2N.

Step 2. Seat Style

CR	corner right
CL	corner left
29	straight, 29"

Step 3. Fire Retardancy

For not fire retardant (), skip this step.*
not fire retardant

Prices for Steps 1-3.

	*
BVS2N. CR	\$2616
CL	\$2616
29	\$2616

Step 4. Back Frame Finish

91	white	+\$0
G1	graphite	+\$0
RO	red	+\$0
97	twilight	+\$0
63	fog	+\$0
79	green apple	+\$0
WBY	wild berry	+\$0

Step 5. Back Knit Color

Price Category 4

For white (91)

1A901	network warm white	+\$0
1A902	network fog	+\$0
1A903	network red	+\$0
1A904	network wild berry	+\$0
1A905	network green apple	+\$0
1A906	network twilight blue	+\$0
1A907	network graphite	+\$0
1DL01	dialogue light brindle	+\$0
1DL02	dialogue dark brindle	+\$0

Price Category 4

For graphite (G1)

1A901	network warm white	+\$0
1A902	network fog	+\$0
1A903	network red	+\$0
1A904	network wild berry	+\$0
1A905	network green apple	+\$0
1A906	network twilight blue	+\$0
1A907	network graphite	+\$0
1DL01	dialogue light brindle	+\$0
1DL02	dialogue dark brindle	+\$0

Price Category 4

For red (RO)

1A901	network warm white	+\$0
1A902	network fog	+\$0
1A903	network red	+\$0
1A904	network wild berry	+\$0
1A905	network green apple	+\$0
1A906	network twilight blue	+\$0
1A907	network graphite	+\$0

Price Category 4

For twilight (97)

1A901	network warm white	+\$0
1A902	network fog	+\$0
1A903	network red	+\$0
1A904	network wild berry	+\$0
1A905	network green apple	+\$0
1A906	network twilight blue	+\$0
1A907	network graphite	+\$0

Price Category 4

For fog (63)

1A901	network warm white	+\$0
1A902	network fog	+\$0
1A903	network red	+\$0
1A904	network wild berry	+\$0
1A905	network green apple	+\$0
1A906	network twilight blue	+\$0
1A907	network graphite	+\$0
1DL01	dialogue light brindle	+\$0
1DL02	dialogue dark brindle	+\$0

Sectional Seating *continued*

Price Category 4
For green apple (79)

1A901 network warm white	+\$0
1A902 network fog	+\$0
1A903 network red	+\$0
1A904 network wild berry	+\$0
1A905 network green apple	+\$0
1A906 network twilight blue	+\$0
1A907 network graphite	+\$0

Price Category 4
For wild berry (WBY)

1A901 network warm white	+\$0
1A902 network fog	+\$0
1A903 network red	+\$0
1A904 network wild berry	+\$0
1A905 network green apple	+\$0
1A906 network twilight blue	+\$0
1A907 network graphite	+\$0

Step 6. Seat Fabric

Price Category 1	+\$0
Price Category 10	+\$686
Price Category 2	+\$30
Price Category 3	+\$55
Price Category 4	+\$108
Price Category 5	+\$161
Price Category 7	+\$346
Price Category 8	+\$455
Price Category 9	+\$505
Price Category C	+\$128
Price Category F	+\$253
Price Category I	+\$638

Legs

BVS3.

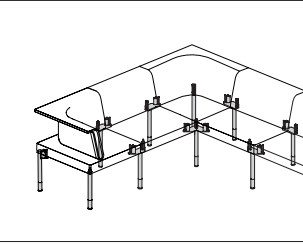

Product Information

Description

Seating legs provide 4 attachment options to accommodate the various configurations of social chairs and sectional seats. Legs have glides that provide up to 2" of adjustment.

Notes

When specifying trivalent chrome (47) finish option, glide color must be specified separately.

Dimensions

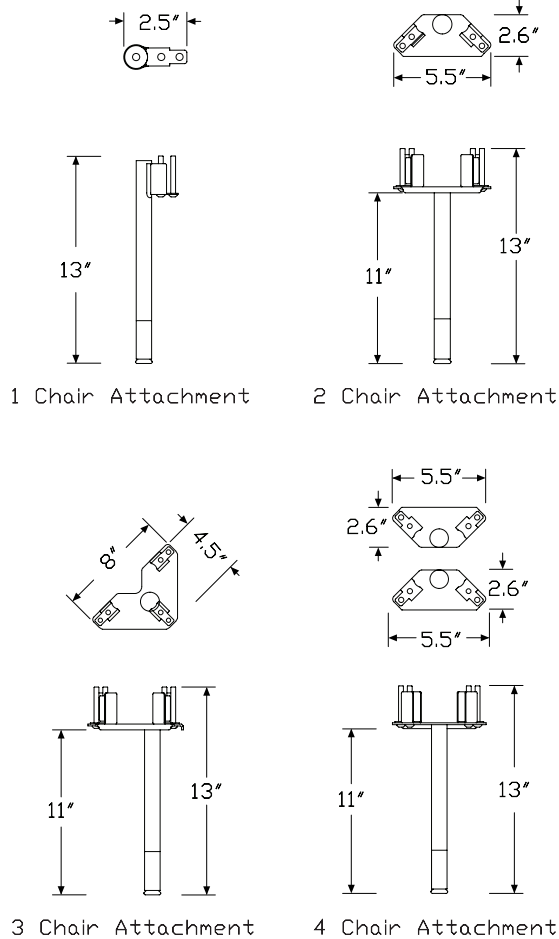

Specification Information

Step 1.

BVS3.

Step 2. Leg Option

- 1 attaches to one chair
- 2 attaches to two chairs
- 3 attaches to three chairs
- 4 attaches to four chairs

Prices for Steps 1-2.

BVS3. 1	\$80
2	\$115
3	\$161
4	\$227

Step 3. Glide Option

C	nylon glide, carpet floors	+\$0
----------	----------------------------	------

Step 4. Leg Finish

91	white	+\$0
G1	graphite	+\$0
MS	metallic silver	+\$0
47	trivalent chrome	+\$10

Step 5. Glide Finish

For graphite (G1)

BK	black	+\$0
-----------	-------	------

For white (91)

8Q	folkstone grey	+\$0
-----------	----------------	------

For metallic silver (MS)

63	fog	+\$0
-----------	-----	------

For trivalent chrome (47)

BK	black	<input type="checkbox"/> A	+\$0
8Q	folkstone grey	<input type="checkbox"/> A	+\$0
63	light grey	<input type="checkbox"/> A	+\$0

Seat Back Ganging Kit

BVS4.

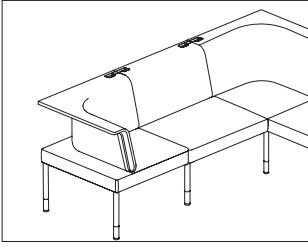

Public Office Landscape® Seating

Product Information

Description
 This seat back ganging kit aligns 2 sectional seats that are side-by-side.

Dimensions

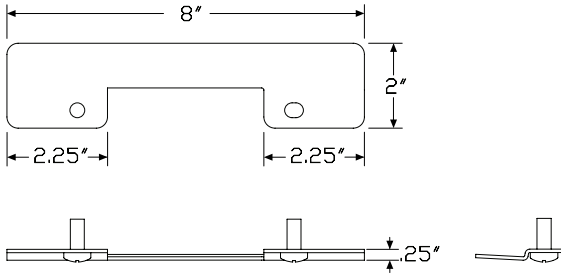

Specification Information

Step 1.	
BVS4.	\$44
Step 2. Leg Option	
2 ganging kit for 2 seats	+\$0

Seat Back Alignment Clip

BVS5.

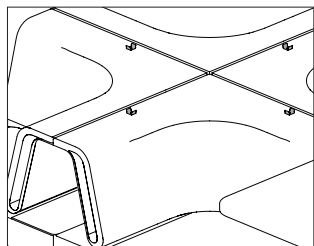

Product Information

Description

This seat back alignment clip aligns 2 chairs that are back-to-back.

Dimensions

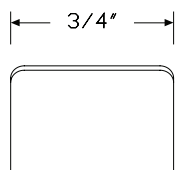
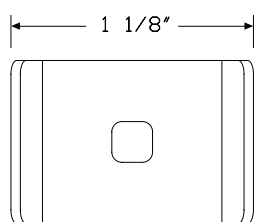

Specification Information

Step 1.

BVS5.1

\$24

Desk and Bin Finishing Kit

BVD4.

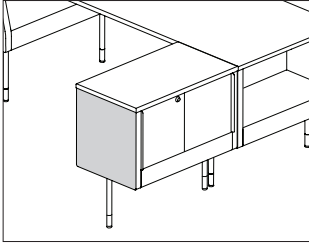

Public Office Landscape® Desking and Storage

Product Information

Description

This finishing kit is painted steel and covers the exposed end of a desk, peninsula table, connecting bin, or freestanding bin.

Notes

Specify kit color to match color of corresponding desk, peninsula table, connecting bin, or freestanding bin.

Dimensions

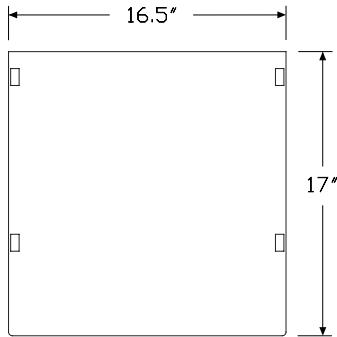

Specification Information

Step 1.

BVD4.

Step 2. Kit Application

- 1 bin finishing kit, single
- 2 bin finishing kit, double

Prices for Steps 1-2.

BVD4. 1	\$76
2	\$127

Step 3. End Cap Material Finish

G1	graphite	+\$0
91	white	+\$0
MS	metallic silver	+\$0

Desk and Bin Ganging Plate

BVD5.

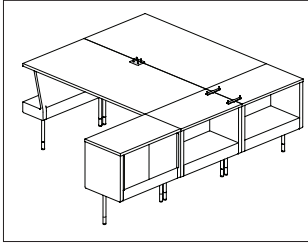

Product Information

Description

These ganging plates provide attachment between units. Attachment hardware included.

Notes

See Planning Guide for more information about settings.

Dimensions

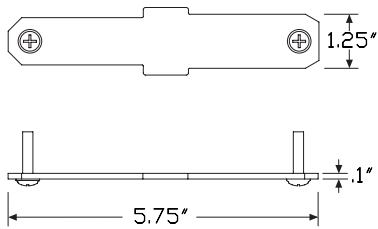

Peninsula table & freestanding bin ganging plates (B)

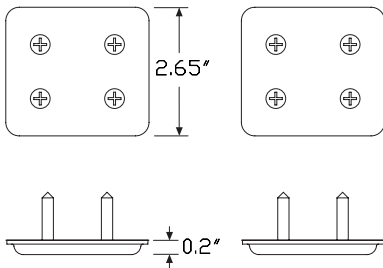
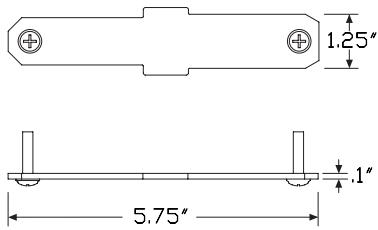

Desk & connecting bin ganging plates (C)

Specification Information

Step 1.

BVD5.

Step 2. Application

- B** bin-to-bin
- C** connecting bin ganging kit

Prices for Steps 1-2.

BVD5. B	\$92
C	\$180

Modular Power Entry, New York BVE02.

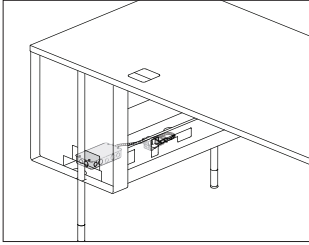

Product Information

Description

This power entry connects a buildings electrical supply from a wall, floor, or column to a desk or connecting bin. It includes a junction box with 8" of wire and a harness. The junction box can be located in the desk or connecting bin. The power entry plugs into any of the ports on the power block. UL listed and Canadian UL listed.

Notes

A licensed electrician must wire power entry.

Dimensions

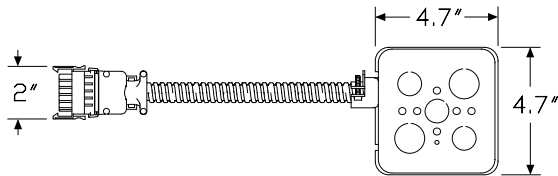
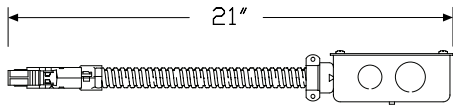

Specification Information

Step 1.

BVE02.

Step 2. Wire Configuration

08 8 wire

Prices for Steps 1-2.

BVE02. 08 \$345

Power Block

BVE03.

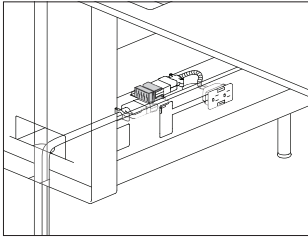

Product Information

Description

This power block has electrical ports for connecting modular power to receptacles and jumpers. UL listed and Canadian UL listed.

Notes

See Planning Guide for more information about power.

Dimensions

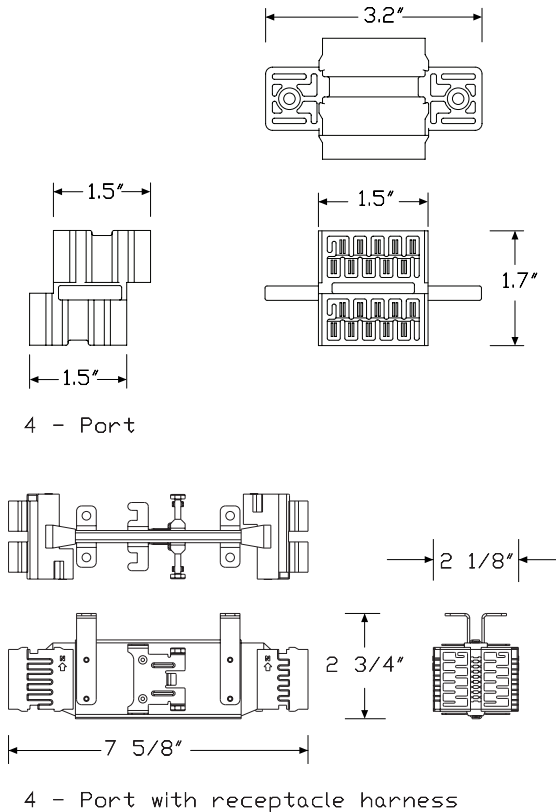

4 - Port

4 - Port with receptacle harness

Specification Information

Step 1.

BVE03.

Step 2. Wire Configuration

08 8 wire

Step 3. Block Configuration

04 4 port

4R 4 port with receptacle harness **A**

Prices for Steps 1-3.

	04	4R
BVE03. 08	\$64	116

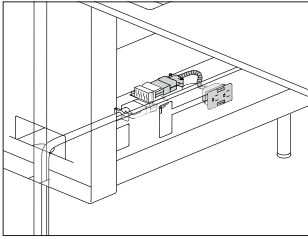

Product Information

Description

This receptacle connects to a power block and provides power to a desk. Package contains 1 duplex receptacle. UL listed and Canadian UL listed.

Dimensions

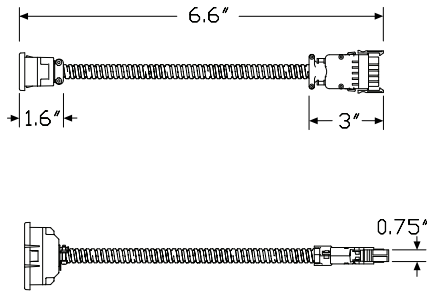

Public Office Landscape® Power

Specification Information

Step 1.

BVE04.

Step 2. Wire Configuration

08 8 wire

Step 3. Duplex Type

For 8 wire (08)

- AN** circuit a - shared neutral, 8 wire
- BN** circuit b - shared neutral, 8 wire
- CN** circuit c - shared neutral, 8 wire
- DN** circuit d - shared neutral, 8 wire
- AG** circuit a - shared neutral isolated ground, 8 wire
- BG** circuit b - shared neutral isolated ground, 8 wire
- CG** circuit c - shared neutral isolated ground, 8 wire
- DG** circuit d - shared neutral isolated ground, 8 wire

Prices for Steps 1-3.

	AN	BN	CN	DN	AG	BG
BVE04. 08	\$143	143	143	143	143	143
					CG	DG
BVE04. 08					\$143	143

Step 4. Duplex Color

- 91** white +\$0
- BK** black +\$0

Modular Power Controlled Duplex

BVE04M

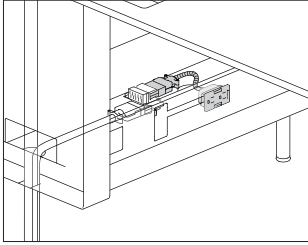

Product Information

Description

This receptacle is to be used for ASHRAE90.1 and Title 24 compliance. A controlled receptacle should be used for any receptacles that are under automated control by the energy management system. The receptacle connects to a power block and provides power to a desk. Package contains 1 duplex receptacle. It is UL listed and Canadian UL listed.

Dimensions

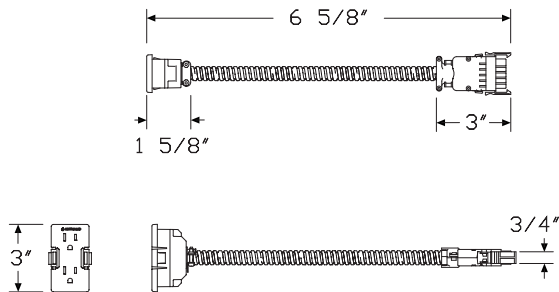

Specification Information

Step 1.

BVE04M.

Step 2. Wire Configuration

08 8 wire

Step 3. Duplex Type

For 8 wire (08)

- AN** circuit a - shared neutral, 8 wire
- BN** circuit b - shared neutral, 8 wire
- CN** circuit c - shared neutral, 8 wire
- DN** circuit d - shared neutral, 8 wire
- AG** circuit a - shared neutral isolated ground, 8 wire
- BG** circuit b - shared neutral isolated ground, 8 wire
- CG** circuit c - shared neutral isolated ground, 8 wire
- DG** circuit d - shared neutral isolated ground, 8 wire

Prices for Steps 1-3.

	AN	BN	CN	DN	AG	BG
BVE04M. 08	\$143	143	143	143	143	143
					CG	DG
BVE04M. 08					\$143	143

Step 4. Duplex Color

- 91** white +\$0
- BK** black +\$0

Power Block-to-Power Block Jumper

BVE05.

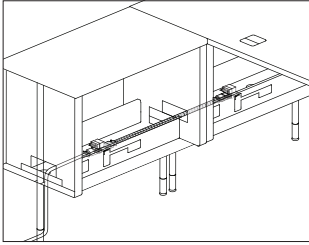

Product Information

Description

This power jumper connects power block to power block. UL listed and Canadian UL listed.

Notes

See Planning Guide for more information about settings.

Dimensions

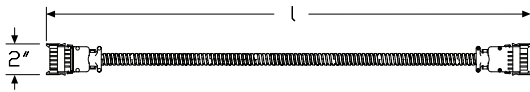

Specification Information

Step 1.

BVE05.

Step 2. Wire Configuration

08 8 wire

Step 3. Jumper Length

29 29" wide

30 52" wide

116 116" wide

134 134" wide

Prices for Steps 1-3.

	29	30	116	134
BVE05. 08	\$143	215	228	257

Corded Power Solution

BVE06.

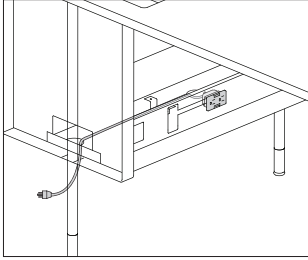

Product Information

Description

This corded power receptacle provides a plug-in solution in lieu of the modular power system. It plugs directly into a wall or floor outlet. Cord comes in 6', 10', and 20' lengths. Package contains 1 duplex receptacle. UL listed and Canadian UL listed.

Dimensions

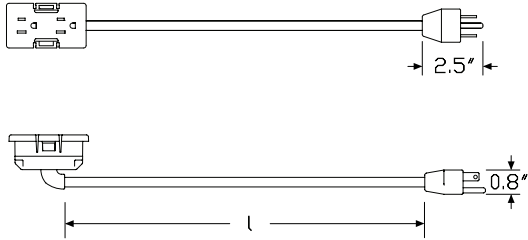

Specification Information

Step 1.

BVE06.

Step 2. Duplex Configuration

1 single duplex

Step 3. Cord Length

06 6' long
10 10' long
20 20' long

Prices for Steps 1-3.

	06	10	20
BVE06. 1	\$130	157	236

Step 4. Duplex Color

91	white		+\$0
BK	black		+\$0

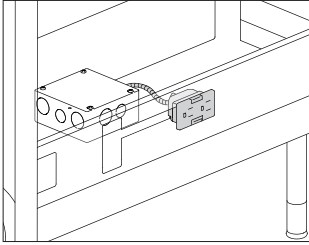

Product Information

Description
 This hardwired receptacle connects to the Chicago Power Junction Box and provides power to the desk. Package contains 1 duplex receptacle. UL listed and Canadian UL listed.

Notes
 A licensed electrician must wire the receptacle to the junction box (BVE08.), ordered separately.

Dimensions

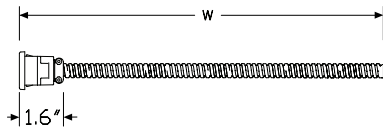

Specification Information

Step 1.

BVE07.

Step 2. Configuration

- A** circuit a
- B** circuit b

Prices for Steps 1-2.

BVE07. A	\$143
B	\$143

Step 3. Duplex Color

91	white	+\$0
BK	black	+\$0

Chicago Power - Controlled Duplex

BVE07M

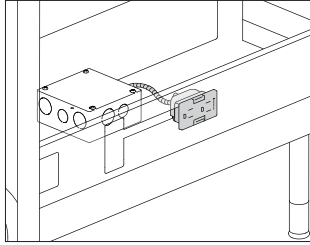

Product Information

Description

This receptacle is to be used for ASHRAE90.1 and Title 24 compliance. A controlled receptacle should be used for any receptacles that are under automated control by the energy management system. This hard-wired receptacle connects to the Chicago power junction box and provides power to a desk. Package contains 1 duplex receptacle. It is UL listed and Canadian UL listed.

Notes

A licensed electrician must wire the receptacle to the junction box (BVE08.), ordered separately.

Dimensions

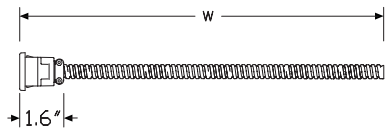

Specification Information

Step 1.

BVE07M. A

Step 2. Configuration

A circuit a A

B circuit b A

Prices for Steps 1-2.

BVE07M. A	\$143
B	\$143

Step 3. Duplex Color

91 white <input type="checkbox"/> A	+\$0
BK black <input type="checkbox"/> A	+\$0

Controlled Receptacle Decal G9999.
(12 per sheet)

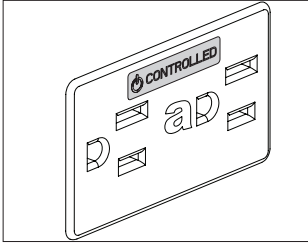

Product Information

Description

This decal is to be used for ASHRAE90.1 and Title 24 compliance. The decal is used to mark standard receptacles (new or existing) that are under automated control by the energy management system. 1 sheet includes 12 clear decals with white or black print.

Dimensions

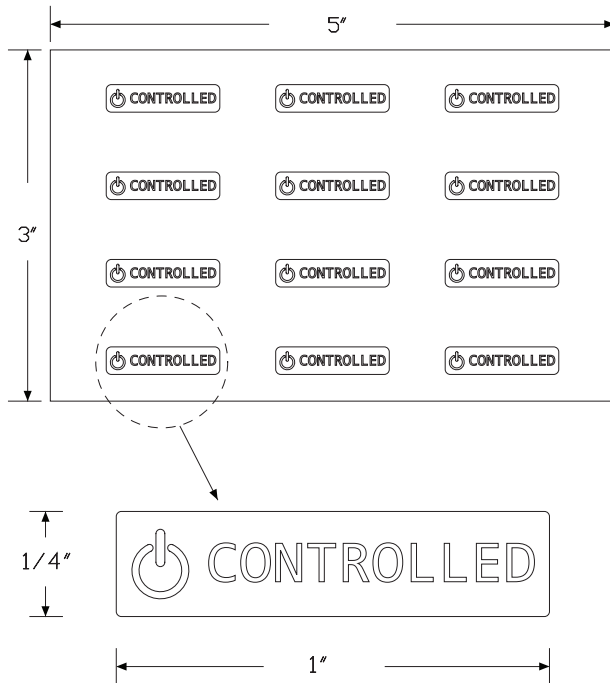

Specification Information

Step 1.

G9999. A

Step 2. Color

B black print A

W white print A

Prices for Steps 1-2.

G9999. B	\$16
W	\$16

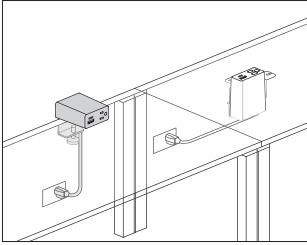

Product Information

Description

This electrical distributor plugs directly into floor, wall, or ceiling drop outlets. Each module configuration presents the same visual appearance. Cable clips and attachment hardware included. Product is UL listed.

Notes

Cable clips for cord management are intended for a 1-time installation.

Clamp versions can be reoriented in the field by a technician.

USB ports provide a combined 20 watts of power to charge most devices and tablets at full speed. USB-C provides 15 watts of power and USB-A provides 10 watts of power individually. When using the USB-C and USB-A ports simultaneously, USB-C remains at 15 watts and USB-A reduces to 5 watts.

Cord color is predetermined. For white (91) finish cords will be white.

For graphite (G1) finish cords will be black.

Grommet mount attachment (Y1414.xxxG) does not come with the mini grommet. Order Logic mini grommet (Y1412.) separately, as needed.

Dimensions

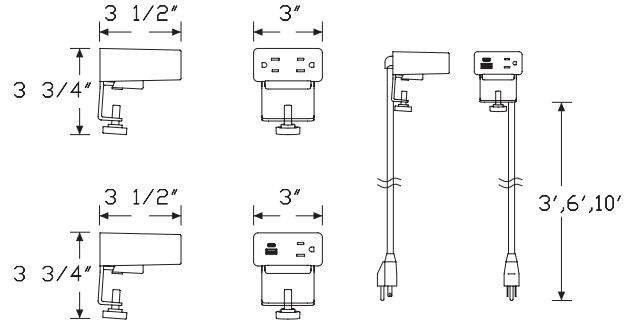

Surface Clamp

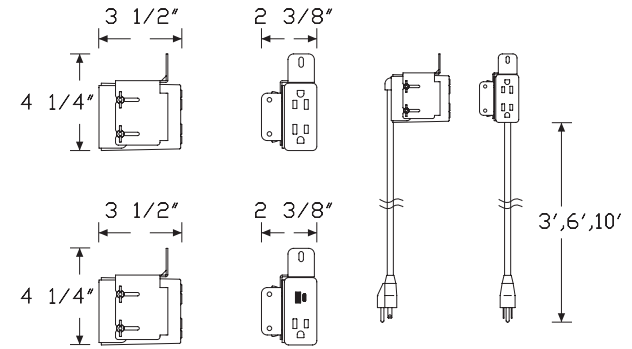

Grommet Mount

Specification Information

Step 1.

Y1414.

Step 2. Configuration

- L** 1 simplex receptacles, 1 powered USB A/C Combo
- K** 2 simplex receptacles

Step 3. Cord/Conduit Length

- 03** 3' cord/conduit
- 06** 6' cord/conduit
- 10** 10' cord/conduit

Step 4. Attachment

- G** grommet mount
- S** surface clamp

Prices for Steps 1-4.

	G	S
Y1414. L 03	\$457	457
06	\$457	457
10	\$468	468
K 03	\$256	256
06	\$256	256
10	\$269	269

Step 5. Finish

- BK** black A +\$0
- 91** white A +\$0
- 98** studio white A +\$0
- G1** graphite A +\$0

Logic G1200 Grommet Pass Thru Y1420.

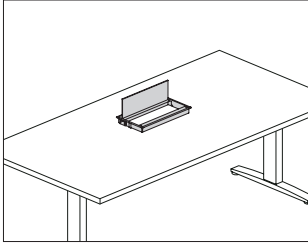

Product Information

Description

This Logic Power Access Solutions™ grommet mounted metal enclosure provides access to cords kept beneath the surface. The unit has an integrated cord keeper.

Notes

Unit size is based on the grommet mounted electrical distributor (Y1425.) with simplex receptacles.

Dimensions

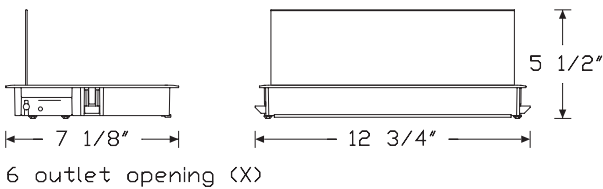
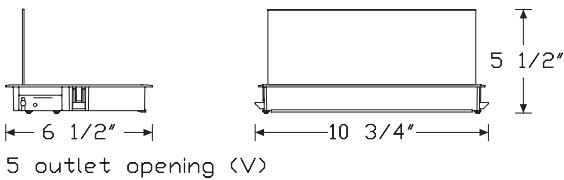
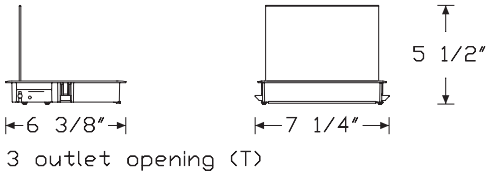

Specification Information

Step 1.

Y1420.

Step 2. Configuration

- T** three outlet opening
- V** five outlet opening
- X** six outlet opening

Prices for Steps 1-2.

Y1420. T	\$294
V	\$323
X	\$351

Step 3. Finish

91 white <input type="checkbox"/>	+\$0
98 studio white <input type="checkbox"/>	+\$0
BK black <input type="checkbox"/>	+\$0
G1 graphite <input type="checkbox"/>	+\$0
MS metallic silver <input type="checkbox"/>	+\$0

Chicago Power - Junction Box BVE08.

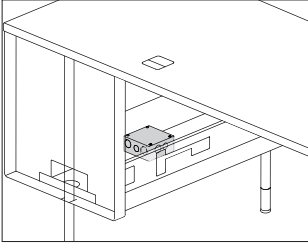

Product Information

Description

This hardwired junction box provides power for up to 2 hardwired Chicago Power Receptacles. UL listed and Canadian UL listed.

Notes

A licensed electrician must wire the junction box to the Chicago power receptacle (BVE07.), ordered separately.

Dimensions

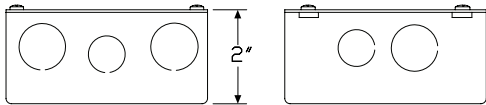
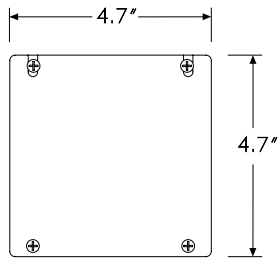

Specification Information

Step 1.

BVE08. \$104

Public Office Landscape® Power

Logic HD Cable Manager

Y1424.

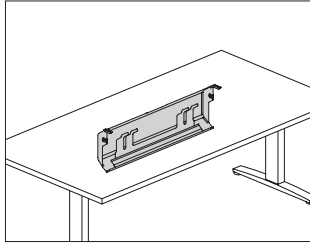

Product Information

Description

This Logic Power Access Solutions™ stand-alone cable management tray mounts to the underside of most surfaces. It can be used with a Logic unit for cord storage, or used alone with cords routed through the back side of the unit. Tray drops down and holds cords in place while working and can be easily stowed back in place.

Dimensions

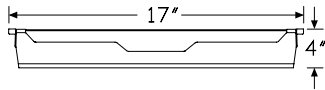
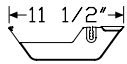

Specification Information

Step 1.

Y1424.

Step 2. Size

17 17" wide tray

Prices for Steps 1-2.

Y1424. 17 \$323

Step 3. Finish

SNA	satin aluminum	+\$0
SNB	satin bronze	+\$0
SNC	satin carbon	+\$0
91	white <input type="checkbox"/>	+\$0
98	studio white <input type="checkbox"/>	+\$0
BK	black <input type="checkbox"/>	+\$0
G1	graphite <input type="checkbox"/>	+\$0
MS	metallic silver <input type="checkbox"/>	+\$0

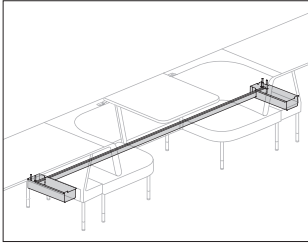

Product Information

Description

This kit includes beam to route power jumper and data between power bridge access desks positioned L-shelf-to-L-shelf with or without social chairs and café table between desk configurations. Attachment hardware included. Power components must be ordered separately.

Notes

Receptacle over only option (NB) supports desk back-to-back configurations with a single or double café and power bridge desk located on left or right side.

Jumper tray only option (00) covers the power block and desk jumper in back-to-back L-shelf configurations with the power bridge desk.

Short bridge option (29) connects L-shelf-to-desk bin configurations with a single social chair between desks. At least 1 desk must be the power bridge desk.

Long bridge option (87) connects L-shelf-to-L-shelf in desk side-to-side configurations with a café table between the power bridge desks.

See Planning Guide for more information about settings.

Public Office Landscape® Power

Dimensions

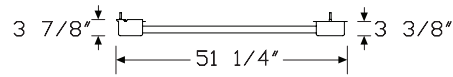
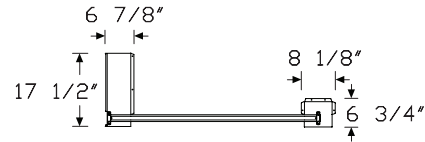

Short Bridge (29)

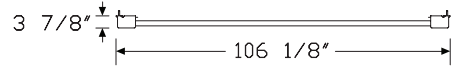

Long Bridge (87)

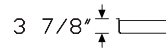
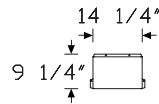

Jumper Tray (00)

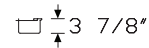
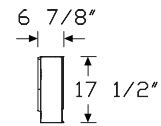

Receptacle Cover (NB)

Specification Information

Step 1.

BVE09.

Step 2. Length

- NB** receptacle cover only
- 00** jumper tray only
- 29** short bridge
- 87** long bridge

Step 3. Desk Bin Orientation

For receptacle cover only (NB)

- L** left bin
- R** right bin

For jumper tray only (00), short bridge (29), or long bridge (87)

- B** left bin and right bin

Prices for Steps 1-3.

	B	L	R
BVE09. NB	—	\$173	173
00	\$143	—	—
29	\$636	—	—
87	\$918	—	—

Step 4. Finish

- 91** white +\$0
- G1** graphite +\$0
- MS** metallic silver +\$0

Single Café Table

BVT1.

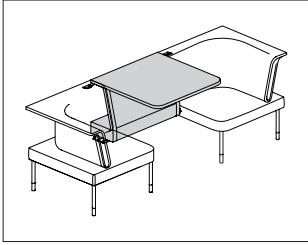

Product Information

Description

This single café table comes with a laminate squared-edge work surface. It has a painted steel shelf, accepts a single 29"-wide screen, and is available with or without power access. Café table includes bag hook. Attachment hardware included.

Notes

Single café table cannot stand alone and must attach between 2 social chairs (BVS1N.).

Power access comes with single grommet to accommodate power at the surface. Grommet color is either graphite or white, matched to the work surface color.

To bring power to the surface of a single café table with power access, order Logic Mini, Grommet Mount (Y1414.) separately.

Bag hook color is matched to shelf color.

Dimensions

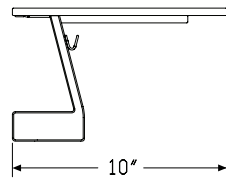
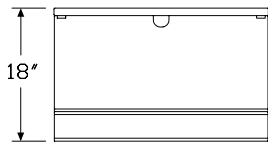
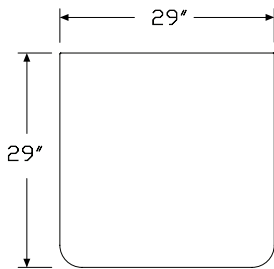

Specification Information

Step 1.

BVT1.

Step 2. Depth

29 29" deep

Step 3. Power Access

P power access

N no power access

Step 4. Top Material

L high-pressure laminate top/thermoplastic edge

Prices for Steps 1-4.

	L
BVT1. 29 P	\$1291
N	\$1217

Step 5. Top Finish

76 light brown walnut	+\$0
8Q folkstone grey	+\$0
91 white	+\$0
98 studio white	+\$0
CL cool grey neutral	+\$0
HF inner tone light	+\$0
HM natural maple	+\$0
HP light anigre	+\$0
HX aged cherry	+\$0
LBA clear on ash	+\$0
LBR phantom ecru	+\$0
LBS phantom cocoa	+\$0
LBU medium matte walnut	+\$0
LBV warm grey teak	+\$0
LBB oak on ash	+\$0
LBC walnut on ash	+\$0
LBF neutral twill	+\$0
LBJ graphite twill	+\$0
LBN classic linen	+\$0
LBQ white twill	+\$0
LT light tone	+\$0
LU soft white	+\$0
WL sandstone	+\$0
WN warm grey neutral	+\$0

Single Café Table *continued*

Step 6. Edge Finish		
76	light brown walnut	+\$0
8Q	folkstone grey	+\$0
91	white	+\$0
98	studio white	+\$0
BU	black umber	+\$0
CL	cool grey neutral	+\$0
HF	inner tone light	+\$0
HM	natural maple	+\$0
HP	light anigre	+\$0
HX	aged cherry	+\$0
LBA	clear on ash	+\$0
LBR	phantom ecru	+\$0
LBS	phantom cocoa	+\$0
LBU	medium matte walnut	+\$0
LBV	warm grey teak	+\$0
LBB	oak on ash	+\$0
LBC	walnut on ash	+\$0
LBF	neutral twill	+\$0
LBJ	graphite twill	+\$0
LBN	classic linen	+\$0
LBQ	white twill	+\$0
LU	soft white	+\$0
WL	sandstone	+\$0
WN	warm grey neutral	+\$0

Step 7. Shelf Finish		
MS	metallic silver	+\$0
G1	graphite	+\$0
91	white	+\$0

Step 8. Grommet Selection		
<i>For power access (P)</i>		
91	white	+\$0
G1	graphite	+\$0

Focus Café Table

BVT2.

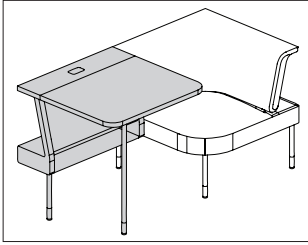

Product Information

Description

The focus café table comes with a laminate squared-edge work surface. It has a painted steel shelf, accepts a single 29"-wide screen, accepts power accessories, and is available with or without power access. Stiffeners, and attachment hardware included.

Notes

Focus café table cannot stand alone and must attach to 1 social chair (BVS1N).

Power accessories in this application will comply with UL 962A. Power access comes with single grommet to accommodate power at the surface. Grommet color is either graphite or white, matched to the work surface color.

To bring power to the surface of a focus café table with power access, order Logic Mini, Grommet Mount (Y1414.) separately.

Dimensions

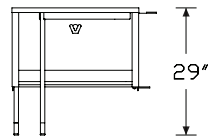
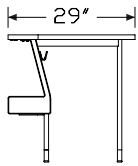
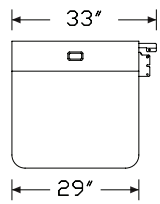

Specification Information

Step 1.

BVT2.

Step 2. Depth

29 29" deep

Step 3. Power Access

P power access

N no power access

Step 4. Surface Application

L table left

R table right

Step 5. Top Material

L high-pressure laminate top/thermoplastic edge

Prices for Steps 1-5.

		LL	RL
BVT2.	29 P	\$1778	1778
	N	\$1672	1672

Step 6. Top Finish		
76	light brown walnut	+\$0
8Q	folkstone grey	+\$0
91	white	+\$0
98	studio white	+\$0
CL	cool grey neutral	+\$0
HF	inner tone light	+\$0
HM	natural maple	+\$0
HP	light anigre	+\$0
HX	aged cherry	+\$0
LBA	clear on ash	+\$0
LBR	phantom ecru	+\$0
LBS	phantom cocoa	+\$0
LBU	medium matte walnut	+\$0
LBV	warm grey teak	+\$0
LBB	oak on ash	+\$0
LBC	walnut on ash	+\$0
LBF	neutral twill	+\$0
LBJ	graphite twill	+\$0
LBN	classic linen	+\$0
LBQ	white twill	+\$0
LT	light tone	+\$0
LU	soft white	+\$0
WL	sandstone	+\$0
WN	warm grey neutral	+\$0

Step 7. Edge Finish		
76	light brown walnut	+\$0
8Q	folkstone grey	+\$0
91	white	+\$0
98	studio white	+\$0
BU	black umber	+\$0
CL	cool grey neutral	+\$0
HF	inner tone light	+\$0
HM	natural maple	+\$0
HP	light anigre	+\$0
HX	aged cherry	+\$0
LBA	clear on ash	+\$0
LBR	phantom ecru	+\$0
LBS	phantom cocoa	+\$0
LBU	medium matte walnut	+\$0
LBV	warm grey teak	+\$0
LBB	oak on ash	+\$0
LBC	walnut on ash	+\$0
LBF	neutral twill	+\$0
LBJ	graphite twill	+\$0
LBN	classic linen	+\$0
LBQ	white twill	+\$0
LU	soft white	+\$0
WL	sandstone	+\$0
WN	warm grey neutral	+\$0

Step 8. Leg Finish		
MS	metallic silver	+\$0
G1	graphite	+\$0
91	white	+\$0

Step 9. Shelf Finish		
<i>For metallic silver (MS)</i>		
MS	metallic silver	+\$0
<i>For graphite (G1)</i>		
G1	graphite	+\$0
<i>For white (91)</i>		
91	white	+\$0

Step 10. Grommet Selection		
<i>For power access (P)</i>		
91	white	+\$0
G1	graphite	+\$0

Double Café Table

BVT3.

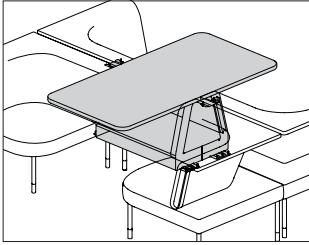

Product Information

Description

This double café table comes with a laminate squared-edge work surface. It has a painted steel shelf and is available with or without power access. Attachment hardware included.

Notes

Double café table cannot stand alone and must attach between 4 social chairs (BVS1N.).

Power access comes with 2 grommets to accommodate power at the surface. Grommet color is either graphite or white, matched to the work surface color.

To bring power to the surface of a double café table with power access, order Logic Mini, Grommet Mount (Y1414.) separately.

Dimensions

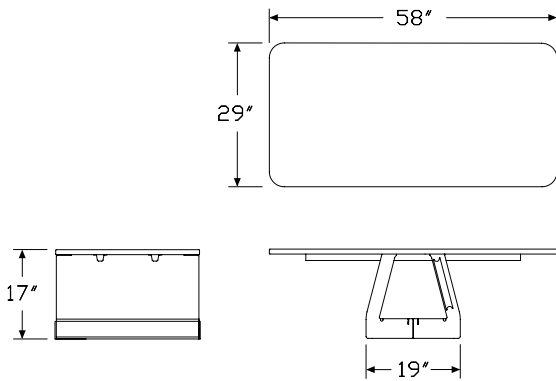

Specification Information

Step 1.

BVT3.

Step 2. Depth

29 29" deep

Step 3. Power Access

P power access

N no power access

Step 4. Top Material

L high-pressure laminate top/thermoplastic edge

Prices for Steps 1-4.

		L
BVT3.	29 P	\$1531
	N	\$1410

Step 5. Top Finish

76	light brown walnut	+\$0
8Q	folkstone grey	+\$0
91	white	+\$0
98	studio white	+\$0
CL	cool grey neutral	+\$0
HF	inner tone light	+\$0
HM	natural maple	+\$0
HP	light anigre	+\$0
HX	aged cherry	+\$0
LBA	clear on ash	+\$0
LBR	phantom ecru	+\$0
LBS	phantom cocoa	+\$0
LBU	medium matte walnut	+\$0
LBV	warm grey teak	+\$0
LBB	oak on ash	+\$0
LBC	walnut on ash	+\$0
LBF	neutral twill	+\$0
LBJ	graphite twill	+\$0
LBN	classic linen	+\$0
LBQ	white twill	+\$0
LT	light tone	+\$0
LU	soft white	+\$0
WL	sandstone	+\$0
WN	warm grey neutral	+\$0

Double Café Table *continued*

Step 6. Edge Finish

76	light brown walnut	+\$0
8Q	folkstone grey	+\$0
91	white	+\$0
98	studio white	+\$0
BU	black umber	+\$0
CL	cool grey neutral	+\$0
HF	inner tone light	+\$0
HM	natural maple	+\$0
HP	light anigre	+\$0
HX	aged cherry	+\$0
LBA	clear on ash	+\$0
LBR	phantom ecru	+\$0
LBS	phantom cocoa	+\$0
LBU	medium matte walnut	+\$0
LBV	warm grey teak	+\$0
LBB	oak on ash	+\$0
LBC	walnut on ash	+\$0
LBF	neutral twill	+\$0
LBJ	graphite twill	+\$0
LBN	classic linen	+\$0
LBQ	white twill	+\$0
LU	soft white	+\$0
WL	sandstone	+\$0
WN	warm grey neutral	+\$0

Step 7. Shelf Finish

MS	metallic silver	+\$0
G1	graphite	+\$0
91	white	+\$0

Step 8. Grommet Selection

For power access (P)

91	white	+\$0
G1	graphite	+\$0

Flat Edge Screen, Single Material BVP1.

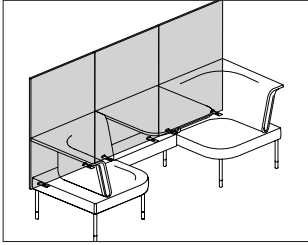

Product Information

Description

Screens attach to social chairs, sectional seats, desks, single café tables, peninsula tables, and freestanding bins. They are tackable with a single fabric covering the entire screen. Attachment is by a push-button mechanism.

Notes

Screen attaches to a social chair (BVS1N.), sectional seat (BVS2N.), and single café table (BVT1.).

Applications with adjacent screens in a line or at a corner require alignment clip (BVP3.), ordered separately.

Screens accept whiteboard overhang (BVP4.), ordered separately.

Screen accepts Customer's Own Material (COM). Yardage is estimated for nondirectional 54"-wide fabrics.

Height—Yardage

42—2.33

54—3.09

68—3.97

For information on multiple quantities or directional fabrics, contact COM Department. See Order Information in Appendices.

Dimensions

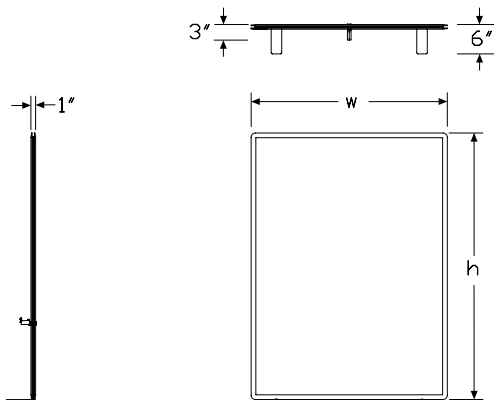

Specification Information

Step 1.

BVP1.

Step 2. Width

29 29" wide

Step 3. Height

42 42" high

54 54" high

68 68" high

Step 4. Screen Material

F fabric

Prices for Steps 1-4.

	F
BVP1. 29 42	\$891
54	\$1147
68	\$1363

Step 5. Fabric

For 42" high (42) with fabric (F)

Price Category 1	+\$0
Price Category 2	+\$26
Price Category 3	+\$60
Price Category 5	+\$161
Price Category B	+\$83
Price Category C	+\$137

For 54" high (54) with fabric (F)

Price Category 1	+\$0
Price Category 2	+\$34
Price Category 3	+\$79
Price Category 5	+\$224
Price Category B	+\$113
Price Category C	+\$188

For 68" high (68) with fabric (F)

Price Category 1	+\$0
Price Category 2	+\$43
Price Category 3	+\$103
Price Category 5	+\$281
Price Category B	+\$142
Price Category C	+\$235

Screen and Desktop Divider Alignment Kit

BVP3.

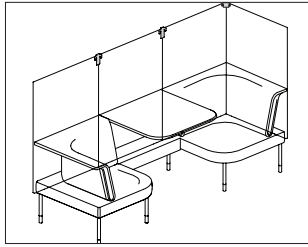

Product Information

Description

This clip comes in 2 types to align screens and desktop dividers either in a line or at a corner. Clip finish is metallic silver (MS).

Dimensions

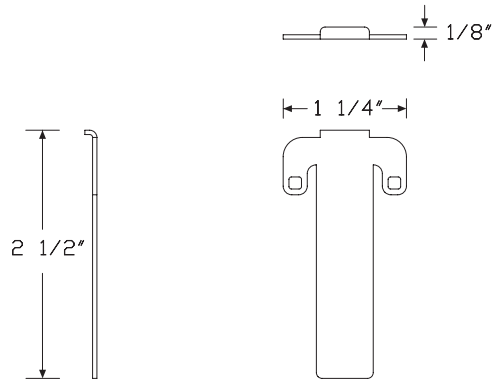

Straight

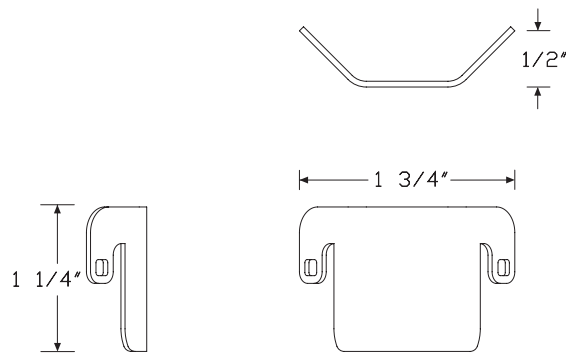

Corner

Specification Information

Step 1.

BVP3.

Step 2. Application

S straight

C corner

Prices for Steps 1-2.

BVP3. S	\$19
C	\$35

Whiteboard Overhang

BVP4.

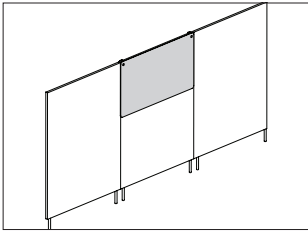

Product Information

Description
 This whiteboard hangs over a screen. It is 25" high when used on 54"-high screens, and 39" high when used on 68"-high screens. Available in 29" width to match screen width. Bracket finish is metallic silver (MS).

Notes
 Available for 54"-high and 68"-high screens only.
 A screen can support only a single whiteboard overhang.

Dimensions

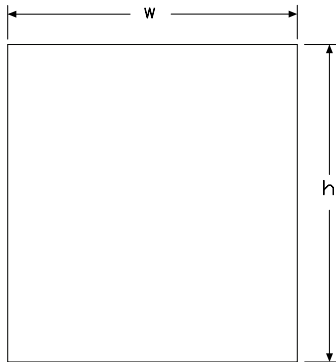

Specification Information

Step 1.
BVP4.

Step 2. Width
29 29" wide

Step 3. Height
54 54" high
68 68" high

Prices for Steps 1-3.

	54	68
BVP4. 29	\$605	807

Public Office Landscape® Space Delineation

Index by Product Name

Public Office Landscape®	
Chicago Power - Controlled Duplex	page(s) 23
Chicago Power - Duplex	22
Chicago Power - Junction Box	28
Controlled Receptacle Decal (12 per sheet)	24
Corded Power Solution	21
Desk and Bin Finishing Kit	14
Desk and Bin Ganging Plate	15
Double Café Table	36
Flat Edge Screen, Single Material	38
Focus Café Table	34
Legs	11
Logic G1200 Grommet Pass Thru	27
Logic HD Cable Manager	29
Logic Mini	25
Modular Power Controlled Duplex	19
Modular Power Duplex	18
Modular Power Entry, New York	16
Power Block	17
Power Block-to-Power Block Jumper	20
Power Bridge	30
Screen and Desktop Divider Alignment Kit	39
Seat Back Alignment Clip	13
Seat Back Ganging Kit	12
Sectional Seating	8
Single Café Table	32
Social Chair	5
Whiteboard Overhang	40



Index by Product Number

BVD4. Desk and Bin Finishing Kit	page(s) 14
BVD5. Desk and Bin Ganging Plate	15
BVE02. Modular Power Entry, New York	16
BVE03. Power Block	17
BVE04. Modular Power Duplex	18
BVE04M Modular Power Controlled Duplex	19
BVE05. Power Block-to-Power Block Jumper	20
BVE06. Corded Power Solution	21
BVE07. Chicago Power - Duplex	22
BVE07M Chicago Power - Controlled Duplex	23
BVE08. Chicago Power - Junction Box	28
BVE09. Power Bridge	30
BVP1. Flat Edge Screen, Single Material	38
BVP3. Screen and Desktop Divider Alignment Kit	39
BVP4. Whiteboard Overhang	40
BVS1N. Social Chair	5
BVS2N. Sectional Seating	8
BVS3. Legs	11
BVS4. Seat Back Ganging Kit	12
BVS5. Seat Back Alignment Clip	13
BVT1. Single Café Table	32
BVT2. Focus Café Table	34
BVT3. Double Café Table	36
G9999. Controlled Receptacle Decal (12 per sheet)	24
Y1414. Logic Mini	25
Y1420. Logic G1200 Grommet Pass Thru	27
Y1424. Logic HD Cable Manager	29





20-Day or Less/Assigned Lead-Time Order Information

GSA

20-Day or Less and Assigned Lead-Time Programs

20-day or less and assigned lead-time products are designed for established Herman Miller dealers with pre-approved credit.

Products are distributed from multiple manufacturing facilities across the United States. All products and options not designated by an Assigned Lead-Time icon  will ship in 20 business days or less after being acknowledged by Herman Miller. Products and options designated by an  are on the assigned lead-time program and will ship in 20 days, less than 20 days, or more than 20 days from order acknowledgement.

Ordering Procedure

Please place orders through Order Manager. If this is not available to you, place orders through mail or fax. Verbal purchase orders will not be accepted.

Order Entry fax number for Meridian® Filing and Storage:

(616) 846 9236.

Order Entry fax number for all other products:

(616) 654 3085.

For more information, contact your Customer Care representative at:

(866) 854 3048 ext 3400.

Shipments and Delivery

Per Herman Miller Terms and Conditions.

Changes and Cancellation

Per Herman Miller Terms and Conditions.



Customer's Own Material Order Information — Workspaces

GSA

Customer's Own Material

Program Overview

The Customer's Own Material (COM) program gives you the option of using textiles other than those listed. Herman Miller will test textiles for application to Herman Miller products and will process orders for those with approved COM textiles only. COM textiles are on assigned lead times.

Omni lists an overview of fabrics that have been tested and indicates whether or not they were approved for application to Herman Miller products.

Specific information on the terms and conditions, testing, approval, and ordering process for COM is listed below. Questions about the COM program and requests for assistance may be directed to your COM representative at:

(616) 654 3400

(866) 854 3048 ext 6543400

Customer's Own Material Warranty

Herman Miller does not warrant COM textiles. COM textiles are tested for application only; they are not tested for performance. The Herman Miller warranty does apply to the underlying products.

Suppliers of COM textiles are responsible for color consistency within commercial tolerances, UV stability, and resistance to soiling and perspiration.

Customer's Own Material Pricing

COM is a Category 1 fabric. There are no application charges for COM fabrics.

Ordering and payment for COM textile yardage are the responsibility of the customer and the textile supplier.

If desired, Herman Miller will purchase COM textiles directly from Maharam, Camira, C.F. Stinson, Guilford of Maine, Luna Textiles, Momentum Textiles and Ultrafabrics to simplify ordering and shipment. For this service, refer to the Supplier Connection program.

Application Note

Herman Miller does not guarantee that Customer's Own Material (COM) fabric patterns will align across panels/tiles or from one screen to the next. We also do not guarantee that COM fabric designs will be positioned consistently in the same location across several panels, tiles, or screens.

Textile Approval

1. Select a COM textile and a Herman Miller product.
2. If your textile does not show as tested in Omni, submit a request. You will be required to select a specific color of the textile and feature of the product to test, i.e., seat, back, etc.
3. Herman Miller will notify you of approval or disapproval within 4 days from receipt of the test yardage.

Customer's Own Material Order Information — Workspaces

continued

GSA

Ordering Products with COM

1. Refer to the specific products to determine the yardage required for COM textiles.
Note: Yardage requirements are based on nondirectional, 54"-wide textiles. 66"-wide textiles are needed for application on 60"-wide products. Additional yardage may be needed due to the unique characteristics of a textile.
2. Obtain the COM ID# in Omni. If the color you are ordering does not have a COM ID# assigned, click "Create ID".
3. Enter your order on Order Manager in Omni.
4. Upon receipt of your purchase order, Herman Miller will send you a PO acknowledgment.
5. Arrangements must be made for the textiles to be shipped from the supplier to Herman Miller for application to the Herman Miller products. Textiles must be tagged with the assigned identification number and the roll yardage quantity. See Omni for shipping procedures and current shipping addresses or contact a COM representative at (616) 654 3400 or (866) 854 3048 ext 6543400.
Products will be scheduled for production when COM textiles are received at Herman Miller. Standard lead times in effect at that time will apply.

Note: If textiles are to be purchased directly by Herman Miller through the Supplier Connection program, Herman Miller will handle the ordering and shipping process and will schedule your order for production upon receipt of your purchase order (dependent on textile availability). Refer to the Supplier Connection program for more information.

Supplier Connection

Program Overview

The Supplier Connection program is a service offered by Herman Miller to purchase approved COM textiles directly from Maharam, Camira, C.F. Stinson, Guilford of Maine, Luna Textiles, Momentum Textiles and Ultrafabrics. When you select a textile through this program, Herman Miller will facilitate the ordering, scheduling, and shipment of the textile directly with the supplier.

Suppliers included in the Supplier Connection program keep an active inventory of textiles that are pre-approved for application to Herman Miller products. Pre-approval applies only to the suitability of a textile for manufacturing and application to a Herman Miller product. Omni provides an overview of fabrics that have been tested and indicates whether or not they were approved for application to Herman Miller products.

Specific information on the terms and conditions, testing, approval, and ordering process for the Supplier Connection program is listed below. Questions and requests for assistance may be directed to your COM representative at:

(616) 654 3400
(866) 854 3048 ext 6543400

Supplier Connection Warranty

Textiles purchased by Herman Miller through the Supplier Connection program are COM and are not warranted by Herman Miller. COM textiles are tested for application only; they are not tested for performance. The Herman Miller warranty does apply to the underlying products.

Suppliers of COM textiles are responsible for color consistency within commercial tolerances, UV stability, and resistance to soiling and perspiration.

Supplier Connection Pricing

Textiles purchased by Herman Miller through the Supplier Connection program are COM. COM is a Category 1 fabric. There are no application charges for COM fabrics.

Payment for textiles purchased by Herman Miller through the Supplier Connection program is the responsibility of the customer or dealer. Herman Miller will invoice the order at the suppliers prices published at the time of the order.

Customer's Own Material Order Information — Workspaces

continued

GSA

Textile Approval

1. Select a COM textile and a Herman Miller product.
2. If your textile does not show as tested in Omni, submit a request.
You will be required to select a specific color of the textile and feature of the product to test, i.e., seat, back, etc.
3. Herman Miller will notify you of approval or disapproval within 4 days from receipt of the test yardage.

Ordering Products with Supplier Connection COM

1. Identify and include the following information on your purchase order:
 - Product number and option
 - Herman Miller's COM identification number
2. Enter your order on Order Manager in Omni.
3. Upon receipt of the purchase order, Herman Miller will process your order and send you a PO acknowledgment. Herman Miller will determine the yardage required to produce your product and will order and schedule for delivery the required textile. Standard lead times in effect at the time the textile is allocated at the supplier will apply to products ordered through this program.



Customer's Own Material/Customer's Own Leather Order Information — Seating

GSA

Packaging

Packaging varies according to individual product. A surcharge may be added for special packaging requests. Contact Customer Care for specific information.

Customer's Own Material/Customer's Own Leather

Program Overview

The Customer's Own Material (COM) and Customer's Own Leather (COL) program gives you the option of using textiles other than those listed. Herman Miller will test textiles for application to Herman Miller products and will process orders for those with approved COM/COL textiles only. COM/COL are assigned lead-time textiles.

Omni lists an overview of fabrics and leathers that have been tested and indicates whether or not they were approved for application to Herman Miller products.

Specific information on the terms and conditions, testing, approval, and ordering process for COM/COL is listed below. Questions about the COM/COL program and requests for assistance may be directed to your COM representative at:

(616) 654 3400

(866) 854 3048 ext 6543400

Customer's Own Material/Customer's Own Leather Warranty

Herman Miller does not warrant COM/COL textiles. COM/COL textiles are tested for application only; they are not tested for performance. The Herman Miller warranty does apply to the underlying products.

Suppliers of COM/COL textiles are responsible for color consistency within commercial tolerances, UV stability, and resistance to soiling and perspiration.

Customer's Own Material/Customer's Own Leather Pricing

COM is a Category 1 fabric. There are no application charges for COM fabrics. COL is a Category 7 textile; refer to prices on specific products to determine the application charge.

Ordering and payment for COM/COL textile yardage are the responsibility of the customer and the textile supplier.

If desired, Herman Miller will purchase COM textiles directly from Maharam, Camira, C.F. Stinson, Guilford of Maine, Luna Textiles, Momentum Textiles and Ultrafabrics to simplify ordering and shipment. For this service, refer to the Supplier Connection program.

Customer's Own Material/Customer's Own Leather Order Information — Seating

continued

GSA

Textile Approval

1. Select a COM textile and a Herman Miller product.
2. If your textile does not show as tested in Omni, submit a request. You will be required to select a specific color of the textile and feature of the product to test, i.e., seat, back, etc.
3. Herman Miller will notify you of approval or disapproval within 4 days from receipt of the test yardage.

Ordering Products with COM/COL

1. Refer to the specific products to determine the yardage required for COM/COL textiles.
Note: Additional yardage may be needed due to the unique characteristics of a textile.
2. Obtain the COM ID# in Omni. If the color you are ordering does not have a COM ID# assigned, click "Create ID".
3. Enter your order on Order Manager in Omni.
4. Upon receipt of your purchase order, Herman Miller will send you a PO acknowledgment.
5. Arrangements must be made for the textiles to be shipped from the supplier to Herman Miller for application to the seating products. Textiles must be tagged with the assigned identification number and the roll yardage quantity. See Omni for shipping procedures and current shipping addresses or contact a COM representative at (616) 654 3400 or (866) 854 3048 ext 6543400.

Products will be scheduled for production when COM/COL textiles are received at Herman Miller. Standard lead times in effect at that time will apply.

Note: If textiles are to be purchased directly by Herman Miller through the Supplier Connection program, Herman Miller will handle the ordering and shipping process and will schedule your order for production upon receipt of your purchase order (dependent on textile availability). Refer to the Supplier Connection program for more information.

Supplier Connection

Program Overview

The Supplier Connection program is a service offered by Herman Miller to purchase approved COM textiles directly from Maharam, Camira, C.F. Stinson, Guilford of Maine, Luna Textiles, Momentum Textiles and Ultrafabrics. When you select a textile through this program, Herman Miller will facilitate the ordering, scheduling, and shipment of the textile directly with the supplier.

Suppliers included in the Supplier Connection program keep an active inventory of textiles that are pre-approved for application to Herman Miller products. Pre-approval applies only to the suitability of a textile for manufacturing and application to a Herman Miller product. Omni provides an overview of fabrics that have been tested and indicates whether or not they were approved for application to Herman Miller products.

Specific information on the terms and conditions, testing, approval, and ordering process for the Supplier Connection program is listed below. Questions and requests for assistance may be directed to your COM representative at:

(616) 654 3400

(866) 854 3048 ext 6543400

Supplier Connection Warranty

Textiles purchased by Herman Miller through the Supplier Connection program are COM and are not warranted by Herman Miller. COM textiles are tested for application only; they are not tested for performance. The Herman Miller warranty does apply to the underlying products.

Suppliers of COM textiles are responsible for color consistency within commercial tolerances, UV stability, and resistance to soiling and perspiration.

Customer's Own Material/Customer's Own Leather Order Information — Seating

continued

GSA

Supplier Connection Pricing

Textiles purchased by Herman Miller through the Supplier Connection program are COM. COM is a Category 1 fabric. There are no application charges for COM fabrics.

Payment for textiles purchased by Herman Miller through the Supplier Connection program is the responsibility of the customer or dealer. Herman Miller will invoice the order at the suppliers prices published at the time of the order.

Textile Approval

1. Select a COM textile and a Herman Miller product.
2. If your textile does not show as tested in Omni, submit a request. You will be required to select a specific color of the textile and feature of the product to test, i.e., seat, back, etc.
3. Herman Miller will notify you of approval or disapproval within 4 days from receipt of the test yardage.

Ordering Products with Supplier Connection COM

1. Identify and include the following information on your purchase order:
 - Product number and option
 - Herman Miller's COM identification number
2. Enter your order on Order Manager in Omni.
3. Upon receipt of the purchase order, Herman Miller will process your order and send you a PO acknowledgment. Herman Miller will determine the yardage required to produce your product and will order and schedule for delivery the required textile. Standard lead times in effect at the time the textile is allocated at the supplier will apply to products ordered through this program.



Proprietary Textiles Application Chart – Workspaces

GSA

- Available

A Assigned lead-time textile.

See following page for exception notes.

	Action Office® Panels/Connectors	Action Office B-Style Tackboards	Action Office/Ethospace E-Style Storage	Ethospace Tiles/Connectors	Ethospace/Canvas Office Landscape® Privacy Doors	Canvas Tiles/Extended Width Tiles/Channel Tiles	Canvas B-/E-Style Storage	Canvas Tackboards	Canvas Metal Desk Hutch Back Panel	Canvas Vista™ Movable Insert and Display Unit	OE1 Boundary Agile Wall Tile	OE1 Boundary Project Board and Screens	OE1 Nook Liner/Felt Screen Liner/Storage Trolley Liner	Overlay™ Performance Wall Cladding	Pari™ Screens/Flat Edge Screens/Channel Screens	Renew™ Link Screens	Exclave® Tackable Boards and Stowage Tackable Backdrop	Exclave Video-Friendly Tackable Boards and Stowage Tackable Backdrop	Personal Side Screen	Tu® Wood Storage Cubby Tackboard	Seating
Price Category 1																					
COM Customer's Own Material A	1	1	1	1	1	1	1	1	1	1	1	1	1	1	1	1	1	1	1	1	
2V__ Chain	•	•	•	•	•	22	•	•	•	•	•	•	•	•	•	•	•	•	•	•	
8T__ Crossing (85__)	2	2	•	•	•	•	2	•	•	•	•	•	•	•	•	•	•	8	•	18	
3DE__ Dex	6	2	•	•	•	•	2	•	•	•	•	•	•	•	•	•	•	•	•	•	
95__ Gem	2	2	•	•	•	•	2	•	•	•	•	•	•	•	•	•	•	•	•	•	
2I__ Grasscloth	•	•	•	•	•	•	•	•	•	•	•	•	•	•	•	•	•	•	•	•	
1MN__ Monologue	2	2	•	•	•	•	2	•	•	•	•	•	•	•	•	•	•	•	•	•	
5T__ Resonance	•	•	•	•	•	•	•	•	•	•	•	•	•	•	•	•	•	•	•	•	
4SC__ Scatter	2	2	•	•	•	•	•	•	•	•	•	•	•	•	•	•	•	•	•	•	
2M__ Silkworm	•	•	•	•	•	•	•	•	•	•	•	•	•	•	•	•	•	•	•	•	
22F__ Slant	6	•	•	•	•	•	•	•	•	•	•	•	•	•	•	•	•	•	•	•	
235__ Tailored	•	•	•	•	•	8	•	•	•	•	•	•	•	•	•	•	•	•	•	•	
1WS__ Whisper	2	2	•	•	•	•	2	•	•	•	•	•	•	•	•	•	•	•	•	•	
Price Category 2																					
3AR__ Aristo	2	2	•	•	•	•	2	•	•	•	•	•	•	•	•	•	•	•	•	•	
92__ Crepe	2	•	•	•	•	•	•	•	•	•	•	•	•	•	•	•	•	8	•	•	
3EP__ Epic	2	2	•	•	•	•	2	•	•	•	•	•	•	•	•	•	•	•	•	•	
84__ Grosgrain	4	•	•	•	•	8	•	•	•	•	•	•	•	•	•	•	•	19	•	•	
4N__ Horizon	2	2	•	•	•	•	•	•	•	•	•	•	•	•	•	•	•	•	•	•	
1LM__ Loom	2	2	•	•	•	•	•	•	•	•	•	•	•	•	•	•	•	•	•	•	
1HA__ Medley	2	2	•	•	•	•	•	•	•	•	•	•	•	•	•	•	•	8	•	•	
4ME__ Mellow	2	2	•	•	•	•	2	•	•	•	•	•	•	•	•	•	•	•	•	•	
3RA__ Rain	•	•	•	•	•	•	•	•	•	•	•	•	•	•	•	•	•	•	•	•	
3SL__ Sequel	•	•	2	•	•	•	2	•	•	•	•	•	•	•	•	•	•	•	•	•	
4TE__ Terra	2	2	•	•	•	•	2	•	•	•	•	•	•	•	•	•	•	•	•	•	
3TW__ Twine	•	•	•	21	•	•	•	•	•	•	•	•	•	•	•	•	•	•	•	•	
8R__ Twist (55__)	5	2	•	•	•	•	2	•	•	•	•	•	•	•	•	•	•	•	•	18	
Price Category 3																					
47__ Ground Cloth®	•	•	•	•	•	•	•	•	•	•	•	•	•	•	•	•	•	8	•	•	
8L__ Savannah	•	•	•	•	•	•	•	•	•	•	•	•	•	•	•	•	•	•	•	•	
8W__ Strands	•	•	•	•	•	•	•	•	•	•	•	•	•	•	•	•	•	•	•	•	

continued on next page

Proprietary Textiles Application Chart — Workspaces

continued

GSA

	Action Office® Panels/Connectors	Action Office B-Style Tackboards	Action Office/Ethospace E-Style Storage	Ethospace Tiles/Connectors	Ethospace/Canvas Office Landscape® Privacy Doors	Canvas Tiles/Extended Width Tiles/Channel Tiles	Canvas B-/E-Style Storage	Canvas Tackboards	Canvas Metal Desk Hutch Back Panel	Canvas Vista™ Movable Insert and Display Unit	OE1 Boundary Agile Wall Tile	OE1 Boundary Project Board and Screens	OE1 Nook Liner/Felt Screen Liner/Storage Trolley Liner	Overlay™ Performance Wall Cladding	Pari™ Screens/Flat Edge Screens/Channel Screens	Renew™ Link Screens	Exclave® Tackable Boards and Stowage Tackable Backdrop	Exclave Video-Friendly Tackable Boards and Stowage Tackable Backdrop	Personal Side Screen	Tu® Wood Storage Cubby Tackboard	Seating
Price Category 4																					
2X__ Glisten	•	•	•	•	•	•	•	•	•	•				•		•				•	
Price Category 5																					
14A__ Hopsak	2	2	•	•	•	2	•	•	•	•			•				•			•	•
Price Category 6																					
No fabrics available at this time.																					

- 1 Refer to price book appendices and Omni for COM information.
- 2 Available on all products except 54" and 60" wide.
- 4 Not available on Action Office (AO®) acoustical panels.
- 5 (8R__), (8T__), (85__), and (5S__) not available on AO acoustical panels and not available on 54"- or 60"-wide products.
- 6 Not available on Action Office (AO®) connectors, cable management, and spacers.
- 8 Available in select colors. See the "Proprietary Textile Colors — Workspaces" appendix.
- 18 Available on seating products in select colors. See the "Proprietary Textile Colors — Seating" appendix.
- 19 Not available in Grosgrain (84__) fabric color 8405.
- 22 Not available as railroaded application option for Chain and Moire on Canvas extended width tiles.

Application Note: Herman Miller cannot guarantee material/pattern alignment in adjacent products. For example, a fabric's pattern may not align from one screen to the next, or from one panel to the next.

Proprietary Textile Colors – Workspaces

GSA

Price Category 1

Customer's Own Material

See Order Information in Appendices.
Assigned lead-time textile. A

Chain

66" wide	
100% recycled polyester	
2V01	Pearl
2V02	Oyster
2V03	Wheat
2V04	Linen
2V05	Wicker
2V06	Bamboo
2V07	Sage
2V08	Spring Wood
2V09	Iceberg

Crossing

54" wide	
86% antimony-free polyester	
14% polyester	
8T03	Wicker *
8T04	Porcelain *
8T05	Warm Grey *
8T10	Tomato
8T13	Green Apple
8T16	Periwinkle
8T17	Cerulean
8T18	Indigo
8T19	Shale *
8T22	Tin *
8T23	Graphite
8T24	Black

Crossing

For systems products only.
54" wide
86% antimony-free polyester
14% polyester
8501 Ivory *
8502 Oyster *

* Crossing colors available on Exclave® Video-friendly Tackable Boards and Stowage Tackable Backdrop

Dex

54" wide	
100% recycled polyester	
3DE01	Frost
3DE02	Silver Pine
3DE03	Stone
3DE04	Shale
3DE05	Charcoal
3DE06	Gossamer
3DE07	Pine

Gem

54" wide	
100% antimony-free polyester	
9502	Tangerine
9503	Red
9507	Twilight
9508	Bayou
9510	Berry Blue
9511	Aqua Green
9512	Green Apple
9514	Black
9515	Slate Grey
9516	Fog

Grasscloth

66" wide	
100% recycled polyester	
2I01	Silver Birch
2I02	Pampas
2I03	Sedge
2I07	Lea
2I08	Taro
2I09	Steam Grey
2I13	Gravel

Monologue

54" wide	
56% recycled polyester	
44% polyester	
1MN01	Linen
1MN02	Alabaster
1MN03	Truffle
1MN04	Folkstone
1MN05	Silver Pine
1MN06	Slate
1MN07	Seed
1MN08	Yellow Oxide
1MN09	Persimmon
1MN10	Tundra
1MN11	Meadow
1MN12	Blue Sky
1MN13	Blue Spruce
1MN14	Deep Sea

Resonance

66" wide	
100% polyester	
5T04	Greige
5T05	Porcelain
5T06	Alabaster
5T15	Iris
5T28	Sugar
5T47	Tobacco
5T54	Saltbush
5T57	Seed
5T58	Sepia
5T60	Iceberg
5T65	Red
5T67	Boysenberry
5T68	Pistachio
5T69	Green Apple
5T71	Jade
5T72	Blue Green
5T74	Twilight

Scatter

54" wide	
100% recycled polyester, with 26% ocean bound plastic	
4SC01	Alpine
4SC02	Fog
4SC03	Shale
4SC04	Persimmon
4SC05	Red Violet
4SC06	Lime Zest
4SC07	Olive
4SC08	Glacier
4SC09	Blue Sky
4SC10	Lagoon
4SC11	Slate Grey
4SC12	Blue Black

Price category 1 continued on next page

Proprietary Textile Colors — Workspaces

continued

GSA

Price Category 1

continued

Silkworm

66" wide
58% recycled polyester
42% polyester

2M01	Cocoon
2M02	Pongee
2M03	Saffron
2M04	Tussah
2M05	Ceylon
2M06	Jasmine
2M07	Shale
2M08	Monsoon

Slant

66" wide
51% polyester
49% recycled polyester

22F04	Pesto
22F06	Neptune
22F07	Blueberry
22F10	Pumpkin
22F12	Silver Birch
22F13	Bluestone
22F15	Shale

Tailored

54" wide
56% polyester
44% recycled polyester

23501	Studio White *
23502	Sugar
23503	Tomato
23504	Orchid
23505	Boysenberry
23506	Chive
23507	Bluegrass
23508	Cobalt
23509	Cadet
23510	Fog
23511	Graphite
23512	Black
23513	Coffee

* Color not available on Canvas Tiles.

Whisper

54" wide
73% recycled polyester
27% polyester,
with 11.3% ocean bound plastic

1WS01	Sand Dollar
1WS02	Pebble
1WS03	Silver Birch
1WS04	Iceberg
1WS05	Silver Pine
1WS06	Carbon
1WS07	Cumin
1WS08	Adobe
1WS09	Strawberry
1WS10	Blush
1WS11	Eggplant
1WS12	Willow
1WS13	Sea Grass
1WS14	Pool
1WS15	Blueberry
1WS16	Glacier
1WS17	Grey
1WS18	Canyon

Price Category 2

Aristo

54" wide
88% recycled polyester
12% polyester
Acrylic backing

3AR01	Forest Moss
3AR02	Light Brindle
3AR03	Mink
3AR04	Copper
3AR05	Adobe
3AR06	Cherry
3AR07	Lilac
3AR08	Green Apple
3AR09	Surf
3AR10	Waterfall
3AR11	Cadet
3AR12	Tin
3AR13	Pewter
3AR14	Grey Brindle
3AR15	Grey Black

Crepe

54" wide
100% recycled polyester,
with 43.6% ocean bound plastic

9201	Licorice
9203	Smoke
9207	Cherry
9223	Cadet
9241	Beachglass
9249	Stone *
9251	Fog *
9252	Slate Grey
9261	Shale
9262	Graphite
9265	Mineral
9266	Persimmon
9267	Juniper
9268	Glacier
9269	Cascade
9270	Navy

* Colors available on Exclave® Video-friendly Tackable Boards and Stowage Tackable Backdrop

Price category 2 continued on next page

Proprietary Textile Colors – Workspaces

continued

GSA

Price Category 2

continued

Epic	
54" wide	
56% recycled polyester	
44% polyester	
Acrylic backing	
3EP01	Alabaster
3EP02	Smoke
3EP03	Falcon
3EP04	Citrus Spring
3EP05	Copper
3EP06	Urban Orange
3EP07	Poppy
3EP08	Wild Plum
3EP09	Sugar Plum
3EP10	Clover
3EP11	Loden
3EP12	Everglade
3EP13	Mist
3EP14	Peacock
3EP15	Cadet
3EP16	Indigo
3EP17	Spring Wood
3EP18	Grey Brindle
3EP19	Seed
3EP20	Carbon Dark

Grosgrain	
66" wide	
100% recycled polyester	
8402	White Ash
8404	Khaki
8405	Oyster *
8408	Spa Blue
8409	Bud
8411	Bayou
8412	Tin

* Color not available on Canvas Dock Mounted Screens, and Thrive® Personal Side Screen.

Horizon	
54" wide	
65% antimony-free polyester	
35% polyester	
4N01	Rye Grass
4N02	Sugar Pine
4N03	Silver Pine
4N04	White Ash
4N05	Spring Wood
4N06	Tamarack
4N07	Mushroom
4N08	Haystack
4N09	Oat Grass
4N10	Forest Moss
4N11	Hickory
4N12	Beech Nut
4N13	Pine Cone
4N14	Poplar
4N15	Elderberry

Loom	
54" wide	
100% polyester	
1LM01	Linen
1LM03	Brick and Mortar
1LM04	Salt and Pepper
1LM05	Black
1LM08	Wild Berry
1LM09	Loden
1LM10	Jade
1LM11	Deep Sea

Medley	
54" wide	
100% polyester	
1HA01	Stone *
1HA02	Trail
1HA03	Charcoal
1HA04	Cinder
1HA05	Citrus
1HA06	Papaya
1HA07	Chutney
1HA08	Tundra
1HA09	Feather Grey *
1HA10	Chartreuse
1HA11	Loden
1HA12	Peacock
1HA13	Bayou *
1HA14	Blue Grotto
1HA15	Blueberry
1HA22	Khaki
1HA23	Pewter
1HA24	Yellow Oxide
1HA25	Vintage Rose
1HA26	Raspberry
1HA27	Acai Berry

* Colors available on Exclave®
Video-friendly Tackable
Boards and Stowage Tackable
Backdrop

Mellow	
54" wide	
100% recycled polyester, with 16% ocean bound plastic	
4ME01	Mineral
4ME02	Pewter
4ME03	Wisteria
4ME04	Olive
4ME05	Glacier
4ME06	Oceanside
4ME07	Charcoal

Rain	
66" wide	
100% recycled polyester	
3RA01	Iceberg
3RA02	Frost
3RA03	Pewter
3RA04	Graphite
3RA05	Warm White
3RA06	Linen
3RA07	Rye
3RA08	Light Brindle

Sequel	
54" wide	
100% vinyl	
100% polyester knit backing	
Resilience® finish	
3SL01	White
3SL02	Pebble
3SL03	Mushroom
3SL04	Stone
3SL05	Chestnut
3SL06	Rattan
3SL07	Black Cherry
3SL08	Tundra
3SL09	Seal
3SL10	Blue Fog
3SL11	Folkstone
3SL12	Shale
3SL13	Slate Grey
3SL14	Charcoal
3SL15	Carbon Dark

Price category 2 continued on next page

Proprietary Textile Colors — Workspaces

continued

GSA

Price Category 2

continued

Terra

54" wide	
100% post-consumer recycled biodegradable polyester *	
4TE01	Spring Wood
4TE02	Zinc
4TE03	Pine Cone
4TE04	Charcoal

* 1% biodegradation in 1,278 days under ASTM D5511 conditions. No evidence of further degradation.

Twine

66" wide	
100% recycled polyester	
3TW01	Silver Birch
3TW02	Ivory
3TW03	Alabaster
3TW04	Bamboo
3TW05	Iceberg
3TW06	Charcoal
3TW07	Feather Grey
3TW08	Shale

Twist

54" wide	
80% antimony-free polyester	
13% recycled polyester	
7% polyester	
8R05	Wicker
8R10	Poppy
8R14	Tin
8R15	Shale
8R16	Graphite
8R17	Birch
8R18	Sepia
8R22	Blueberry
8R23	Green Apple
8R26	Gunmetal
8R27	Cinder
8R28	Citrus
8R29	Pekoe
8R30	Tangerine
8R31	Red Plum
8R32	Wisteria
8R33	Forest
8R34	Jade Dark
8R35	Waterfall
8R36	Midnight Blue
8R37	Carbon Dark

Twist

For systems products only.	
54" wide	
80% antimony-free polyester	
13% recycled polyester	
7% polyester	
5S01	Pearl
5S02	Ivory
5S03	Oyster

Price Category 3

Ground Cloth®

66" wide	
100% polyester	
4701	Vapor Grey
4721	Warm White *
4722	Fog *
4723	Straw *
4724	Red Orange *
4725	Wild Berry *
4726	Green Apple *
4727	Caribbean *
4728	Midnight *
4729	Cappuccino *

* Colors available on Exclave®
Video-friendly Tackable
Boards and Stowage Tackable
Backdrop

Savannah

66" wide	
76% recycled polyester	
24% polypropylene	
8L02	Oyster
8L04	Jute
8L05	Bamboo
8L06	Metal
8L07	Linen
8L10	Frost
8L11	Shale

Strands

66" wide	
100% recycled polyester	
8W01	Pebble
8W02	Porcelain
8W03	Taupe
8W04	Honey
8W05	Khaki
8W06	Rye
8W07	Wicker
8W08	Tin
8W09	Cool Grey

Price Category 4

Glisten

66" wide	
84% polyester	
16% recycled polyester	
2X02	Rye
2X05	Iceberg
2X09	Pewter
2X10	Ash

Proprietary Textile Colors — Workspaces

continued

GSA

Price Category 5

Hopsak	
56" wide	
100% recycled polyester	
14A20	Black
14A22	Raw Umber Dark
14A26	Grey Blue Dark
14A30	Sepia Dark
14A38	Emerald Dark
14A39	Yellow Dark
14A40	Orange
14A41	Sienna
14A42	Olive Green Dark
14A43	Crimson
14A44	Crimson Dark Dark
14A45	Violet Dark
14A46	Pink Dark Dark
14A47	Ultramarine Dark
14A48	Cobalt Blue
14A49	Terra Cotta
14A50	Ochre Dark

Price Category 6

No fabrics available at this time.



Proprietary Textiles Application Chart – Seating

GSA

- Available

[A] Assigned lead-time textile.
See following page for exception notes.

[N] Non-woven textile.

	Aeron® Chairs	Cosm™ Chairs	Mirra® 2 Chairs/Stools	Embody® Chairs	Sayl® Work Chairs/Stools	Sayl Side Chairs	Setu® Chairs/Stools	Zeph™ Chairs	Verus™ Work Chairs/Stools Back	Verus Work Chairs/Stools Seat	Verus Side Chairs Back	Verus Side Chairs Seat	Verus Plus Chairs	Aside® Chairs	Caper® Chairs/Stools	Lino™ Chairs Back	Lino Chairs Seat	OE1 Storage Trolley Cushion Top	Public® Office Landscape Back	Public Office Landscape Seat	Plex™ Lounge Furniture	Swoop™ Lounge Seating - Fully Upholstered	Swoop Lounge Seating - Plywood	Valor™ Seating	Cushion Tops	Workspaces
Price Category 1																										
COM Customer's Own Material [A]					1	1			1	1	1	1	1	1			1	1	1	1	1	1	1	1	1	1
231__ 8Z Pellicle®	•																									
1A7__ AireWeave 2			•																							
8T__ Crossing							•							•				•				•	•		•	•
3DE__ Dex					•	•	•		•	•	•	•	•	•				•		•	19	•	•	•	•	•
4RM__ Duo																•										
6V__ Flexnet™															•											
95__ Gem							•							•				•			•	•			•	•
845__ Intercept		•																								
4W__ Lyris 2™							•																			
1MN__ Monologue					24	22	•		•	•	•						•	•		•	•	•	•	•	•	•
5H2__ Ripple 3D Knit								•																		
4SC__ Scatter					•	•	•		•	•	•	•	•	•			•	•		•	•	•	•	•	•	•
5H1__ Splash 3D Knit								•																		
3DK__ Stretch Knit					21																					
235__ Tailored					•	•	•		•	•	•	•	•	•			•		•	23				•	7	•
1WS__ Whisper					24	•	•		•	•	•	•	•	•			•	•		•	•	•	•	•	•	•
Price Category 2																										
3AR__ Aristo					•	•	•		•	•	•	•	•	•			•	•		•	•	•	•	•	9	•
92__ Crepe					•	•	•		•	•	•	•	•	•			•	•		•	•	•	•	•	•	•
3EP__ Epic					•	•			•	•	•	•	•	•			•	•		•	•	•	•	•	7	•
1LM__ Loom					•	•			•	•	•	•	•	•			•	•		•			•	23	•	•
1MV__ Marvel [N]					21	22	•											•							•	•
1HA__ Medley					•	•	22		•	•	•	•	•	•			•	•		•	•	•	•	•	•	•
4ME__ Mellow					•	22	•		•	•	•	•	•	•			•	•		•	•	•	•	•	•	•
30__ Rhythm					23	•	•		•	•	•	•	•	•			•	•		•	•	•	•	•	•	•
3SL__ Sequel [N]					•	•	•		•	•	•	•	•	8			•	•		•	•	•	•	•	•	•
4TE__ Terra					•	22			•	•	•	•	•	•			•	•		•	•	•	•	•	7	•
8R__ Twist					•	•	•		•	•	•	•	•	•			•	•		•	•	•	•	•	•	•
Price Category 3																										
3AC__ Ace					21	•			•	•	•	•	•	8			•	•		•	19			•	•	
8M__ Latitude™					23	•	•										•					•	•			
Price Category 4																										
3DM__ Daydream					21	•	•		•	•	•	•	•				•	•			•	•	•	•	•	•
1A9__ Network																			•							
3SY__ Sync					•	•	•	•	•	•	•	•	•				•			•	•	•	•	•	•	•

Continued on next page

Proprietary Textiles Application Chart — Seating

continued

GSA

	Aeron® Chairs	Cosm™ Chairs	Mirra® 2 Chairs/Stools	Embody® Chairs	Sayl® Work Chairs/Stools	Sayl Side Chairs	Setu® Chairs/Stools	Zeph™ Chairs	Verus™ Work Chairs/Stools Back	Verus Work Chairs/Stools Seat	Verus Side Chairs Back	Verus Side Chairs Seat	Verus Plus Chairs	Aside® Chairs	Caper® Chairs/Stools	Lino™ Chairs Back	Lino Chairs Seat	OE1 Storage Trolley Cushion Top	Public® Office Landscape Back	Public Office Landscape Seat	Plex™ Lounge Furniture	Swoop™ Lounge Seating - Fully Upholstered	Swoop Lounge Seating - Plywood	Valor™ Seating	Cushion Tops	Workspaces
Price Category 5																										
3CY_ _ Cozy					•	•	•		•	•	•	•	•	•			•				•	•	•	•	•	•
14A_ _ Hopsak					•	•	•		•	•	•	•	•	•			•	•			•	•	•	•	•	•
3SU_ _ Summit					•	•	•		•	•	•	•	•				•				•	•	•	•	•	•
Price Category 6																										
35_ _ Balance				•																						
Price Category 7																										
COL Customer's Own Leather A	1													8				1							1	
Price Category 8																										
No fabrics available at this time																										
Price Category 9																										
21_ _ Leather [N]	23													8			•	•						•		•

Application Note: Herman Miller cannot guarantee material/pattern alignment in adjacent products. For example, a fabric's pattern may not align from one pedestal cushion top to the next, or from one chair to another.

- | | |
|---|---|
| <ul style="list-style-type: none"> 1 Refer to price book appendices and Omni for COM/COL information. 7 Available on 1" Cushion Tops only. 8 Only available on non-upholstered outer back (PB) option. 9 Available on Valor upholstered seat only. 19 Available on Plex seat only. | <ul style="list-style-type: none"> 21 Not available on Sayl upholstered back work chairs. 22 Not available on Sayl side chairs with upholstered backs. 23 Available in select colors. Refer to "Proprietary Textile Colors - Seating" for color offering. 24 Not available on Sayl upholstered High-Back Work Chairs. |
|---|---|

Proprietary Textile Colors — Seating

GSA

Price Category 1

Customer's Own Material
See Order Information in Appendices.
Assigned lead-time textile. **A**

8Z Pellicle®
For New Aeron® Chairs
56% elastomeric
44% polyester
23101 Mineral
23102 Carbon
23103 Graphite

AireWeave™ 2
For Mirra® 2 Chairs
67% elastomeric
33% antimony-free polyester
1A701 Alpine
1A702 Slate Grey
1A703 Graphite
1A704 Lime Green
1A705 Cappuccino
1A706 Urban Orange
1A707 Dark Turquoise
1A708 Twilight

Crossing
54" wide
86% antimony-free polyester
14% polyester
8T03 Wicker
8T04 Porcelain
8T05 Warm Grey
8T10 Tomato
8T13 Green Apple
8T16 Periwinkle
8T17 Cerulean
8T18 Indigo
8T19 Shale
8T22 Tin
8T23 Graphite
8T24 Black

Dex
54" wide
50% recycled polyester
50% polyester
3DE01 Frost
3DE02 Silver Pine
3DE03 Stone
3DE04 Shale
3DE05 Charcoal

Duo
For Lino™ Chairs
52% polyester
48% elastomeric
4RM01 Mineral
4RM02 Poppy
4RM03 Green Leaf
4RM04 Jade
4RM05 Shadow
4RM06 Graphite

Flexnet™
For Caper® Chairs
69% elastomeric
31% polyester
6V01 Black
6V02 Silver Grey

Gem
54" wide
100% antimony-free polyester
9502 Tangerine
9503 Red
9507 Twilight
9508 Bayou
9510 Berry Blue
9511 Aqua Green
9512 Green Apple
9514 Black
9515 Slate Grey
9516 Fog

Intercept
For Cosm™ Chairs
60% elastomeric
40% polyester
84501 Graphite
84502 Carbon
84503 Mineral
84504 Nightfall
84505 Glacier
84506 Canyon

Lyris 2™
For Setu® Chairs
74% elastomeric
26% polyester
4W21 Alpine
4W22 Mango
4W23 Chartreuse
4W25 Berry Blue
4W26 Slate Grey
4W28 Chino
4W29 Rattan
4W30 Java
4W31 Graphite

Monologue
54" wide
56% recycled polyester
44% polyester
1MN01 Linen
1MN02 Alabaster
1MN03 Truffle
1MN04 Folkstone
1MN05 Silver Pine
1MN06 Slate
1MN07 Seed
1MN08 Yellow Oxide
1MN09 Persimmon
1MN10 Tundra
1MN11 Meadow
1MN12 Blue Sky
1MN13 Blue Spruce
1MN14 Deep Sea

Ripple 3D Knit
Available only on Zeph™ Chairs.
knit to size
51% post-consumer recycled polyester
48% polyester
1% lycra
5H201 Black
5H202 Carbon
5H203 Alpine
5H204 Silt
5H205 Tea Rose
5H206 Cocoa
5H207 Persimmon
5H208 Blaze
5H209 Cayenne
5H210 Falcon
5H211 Mustard Seed
5H212 Patina
5H213 Olive
5H214 Moss
5H215 Aloe
5H216 Glacier
5H217 Ultramarine
5H218 Nightfall
5H219 Bluebell
5H220 Boysenberry
5H221 Nightfall/Bluebell
5H222 Patina/Alpine
5H223 Cayenne/Glacier
5H224 Tea Rose/Olive
5H225 Silt/Blaze

Scatter
54" wide
100% recycled polyester,
with 26% ocean bound plastic
4SC01 Alpine
4SC02 Fog
4SC03 Shale
4SC04 Persimmon
4SC05 Red Violet
4SC06 Lime Zest
4SC07 Olive
4SC08 Glacier
4SC09 Blue Sky

Price category 1 continued on next page

Proprietary Textile Colors — Seating

continued

GSA

Price Category 1

continued

Scatter continued

4SC10	Lagoon
4SC11	Slate Grey
4SC12	Blue Black

Stretch Knit

Assigned lead-time textile. A

Available only on Sayl®

Suspension Back Work Chairs

97% polyester, 3% spandex

3DK01	Fog
3DK02	Slate Grey
3DK03	Java
3DK04	Black
3DK05	Red
3DK06	Green Apple
3DK07	Berry Blue

Tailored

54" wide

56% polyester

44% recycled polyester

23501	Studio White *
23502	Sugar *
23503	Tomato
23504	Orchid
23505	Boysenberry
23506	Chive
23507	Bluegrass
23508	Cobalt
23509	Cadet
23510	Fog
23511	Graphite
23512	Black
23513	Coffee

* Colors not available on Plex™ Lounge Furniture.

Splash 3D Knit

Available only on Zeph™ Chairs.
knit to size

54% post-consumer recycled polyester

44% polyester

2% lycra

5H101	Black
-------	-------

Splash 3D Knit continued

5H102	Carbon
5H103	Alpine
5H104	Silt
5H105	Tea Rose
5H106	Cocoa
5H107	Persimmon
5H108	Blaze
5H109	Cayenne
5H110	Falcon
5H111	Mustard Seed
5H112	Patina
5H113	Olive
5H114	Moss
5H115	Aloe
5H116	Glacier
5H117	Ultramarine
5H118	Nightfall
5H119	Bluebell
5H120	Boysenberry

Whisper

54" wide

73% recycled polyester

27% polyester,

with 11.3% ocean bound plastic

1WS01	Sand Dollar
1WS02	Pebble
1WS03	Silver Birch
1WS04	Iceberg
1WS05	Silver Pine
1WS06	Carbon
1WS07	Cumin
1WS08	Adobe
1WS09	Strawberry
1WS10	Blush
1WS11	Eggplant
1WS12	Willow
1WS13	Sea Grass
1WS14	Pool
1WS15	Blueberry

Price Category 2

Aristo

54" wide

88% recycled polyester

12% polyester

Acrylic backing

3AR01	Forest Moss
3AR02	Light Brindle
3AR03	Mink
3AR04	Copper
3AR05	Adobe
3AR06	Cherry
3AR07	Lilac
3AR08	Green Apple
3AR09	Surf
3AR10	Waterfall
3AR11	Cadet
3AR12	Tin
3AR13	Pewter
3AR14	Grey Brindle
3AR15	Grey Black

Crepe

54" wide

100% recycled polyester,
with 43.6% ocean bound plastic

9201	Licorice
9203	Smoke
9207	Cherry
9223	Cadet
9241	Beachglass
9249	Stone
9251	Fog
9252	Slate Grey
9261	Shale
9262	Graphite

Epic

54" wide

56% recycled polyester

44% polyester

Acrylic backing

3EP01	Alabaster
3EP02	Smoke
3EP03	Falcon
3EP04	Citrus Spring
3EP05	Copper
3EP06	Urban Orange
3EP07	Poppy
3EP08	Wild Plum
3EP09	Sugar Plum
3EP10	Clover
3EP11	Loden
3EP12	Everglade
3EP13	Mist
3EP14	Peacock
3EP15	Cadet
3EP16	Indigo
3EP17	Spring Wood
3EP18	Grey Brindle
3EP19	Seed
3EP20	Carbon Dark

Loom

54" wide

100% polyester

1LM01	Linen *
1LM03	Brick and Mortar
1LM04	Salt and Pepper
1LM05	Black
1LM08	Wild Berry
1LM09	Loden
1LM10	Jade
1LM11	Deep Sea

* Color not available on Valor™ Seating

Price category 2 continued on next page

Proprietary Textile Colors — Seating

continued

GSA

Price Category 2

continued

Marvel

54" wide	
100% pvc-free polyurethane	
1MV01	Summer White
1MV02	Sand Dollar
1MV03	Espresso
1MV04	Folkstone Grey
1MV05	Graphite
1MV06	Onyx
1MV07	Polar Blue
1MV08	Blush Grey
1MV09	Woodrose
1MV10	Citrus
1MV11	Adobe
1MV12	Red
1MV13	Kiwi Green
1MV14	Pine
1MV15	Teal Green
1MV16	Twilight

Medley

54" wide	
100% polyester	
1HA01	Stone
1HA02	Trail
1HA03	Charcoal
1HA04	Cinder
1HA05	Citrus
1HA06	Papaya
1HA07	Chutney
1HA08	Tundra
1HA09	Feather Grey
1HA10	Chartreuse
1HA11	Loden
1HA12	Peacock
1HA13	Bayou
1HA14	Blue Grotto
1HA15	Blueberry
1HA22	Khaki
1HA23	Pewter
1HA24	Yellow Oxide
1HA25	Vintage Rose
1HA26	Raspberry
1HA27	Acai Berry

Mellow

54" wide	
100% recycled polyester, with 16% ocean bound plastic	
4ME01	Mineral
4ME02	Pewter
4ME03	Wisteria
4ME04	Olive
4ME05	Glacier
4ME06	Oceanside
4ME07	Charcoal

Rhythm

54" wide	
100% polyester	
3001	Kiwi Green *
3002	Green Apple *
3003	Peacock *
3004	Bayou *
3005	Berry Blue
3006	Iris *
3007	Twilight
3008	Pumpkin *
3009	Poppy *
3010	Molasses *
3011	Mulberry *
3012	Khaki *
3013	Mink *
3014	Black
3015	Charcoal

* Colors not available on Embody® Chair

Sequel

54" wide	
100% vinyl	
100% polyester knit backing	
Resilience® finish	
3SL01	White
3SL02	Pebble
3SL03	Mushroom
3SL04	Stone
3SL05	Chestnut
3SL06	Rattan
3SL07	Black Cherry
3SL08	Tundra
3SL09	Seal
3SL10	Blue Fog
3SL11	Folkstone
3SL12	Shale
3SL13	Slate Grey
3SL14	Charcoal
3SL15	Carbon Dark
3SL28	Navy *

* Color available on Eames® Tandem Sling Seating

Terra

54" wide	
100% post-consumer recycled biodegradable polyester *	
4TE01	Spring Wood
4TE02	Zinc
4TE03	Pine Cone
4TE04	Charcoal

* 1% biodegradation in 1,278 days under ASTM D5511 conditions. No evidence of further degradation.

Twist

54" wide	
80% antimony-free polyester	
13% recycled polyester	
7% polyester	
8R05	Wicker
8R10	Poppy
8R14	Tin
8R15	Shale
8R16	Graphite
8R17	Birch
8R18	Sepia
8R22	Blueberry
8R23	Green Apple
8R26	Gunmetal
8R27	Cinder
8R28	Citrus
8R29	Pekoe
8R30	Tangerine
8R31	Red Plum
8R32	Wisteria
8R33	Forest
8R34	Jade Dark
8R35	Waterfall
8R36	Midnight Blue
8R37	Carbon Dark

Proprietary Textile Colors — Seating

continued

GSA

Price Category 3

Ace

54" wide	
100% polyurethane	
Polyester knit backing	
Stain resistant finish	
3AC01	Summer White
3AC02	White Ash
3AC03	Rye
3AC04	Metal
3AC05	Clay
3AC06	Chestnut
3AC07	Citrus
3AC08	Camelback
3AC09	Chipotle
3AC10	Claret
3AC11	Slate Purple
3AC12	Artichoke
3AC13	Sepia Dark
3AC14	Aloe
3AC15	Flint
3AC16	Blue Sky
3AC17	Oceanside
3AC18	Midnight
3AC19	Spring Wood
3AC20	Frost
3AC21	Lead
3AC22	Black

Latitude™

61" wide	
100% polyester	
8M01	Graphite
8M02	Shadow
8M10	Alpine
8M17	Black
8M21	Slate Grey
8M22	Lime Green
8M23	French Press
8M24	Urban Orange
8M25	Dark Turquoise
8M26	Twilight

Price Category 4

Daydream

54" wide	
48% wool	
41% recycled polyester	
9% nylon	
2% polyester	
3DM01	Rye Grass
3DM02	Silver Birch
3DM03	Pewter
3DM04	Graphite
3DM05	Black
3DM06	Lemongrass
3DM07	Permission
3DM08	Juniper
3DM09	Sea Grass
3DM10	Nightfall

Network

For Public Office Landscape®	
Sectional Back/Social Chair back	
knit to size	
100% polyester	
1A901	Warm White
1A902	Fog
1A903	Red
1A904	Wildberry
1A905	Green Apple
1A906	Twilight
1A907	Graphite

Sync

55" wide	
100% polyester	
3SY01	Pine Cone
3SY02	Citron
3SY03	Canyon
3SY04	Truffle
3SY05	Wild Berry
3SY06	Everglade
3SY07	Glacier
3SY08	Nightfall
3SY09	Dark Mineral
3SY10	Slate Grey
3SY11	Dark Carbon
3SY12	Black

Price Category 5

Cozy

54" wide	
100% wool	
3CY01	Heathered Warm Grey
3CY02	Heathered Rye Grass
3CY03	Heathered Cool Grey
3CY04	Heathered Blue Grey
3CY05	Heathered Black
3CY06	Heathered Persimmon
3CY07	Heathered Loden
3CY08	Heathered Jade
3CY09	Heathered Lagoon
3CY10	Heathered Twilight

Hopsak

56" wide	
100% recycled polyester	
14A20	Black
14A22	Raw Umber Dark
14A26	Grey Blue Dark
14A30	Sepia Dark
14A38	Emerald Dark
14A39	Yellow Dark
14A40	Orange
14A41	Sienna
14A42	Olive Green Dark
14A43	Crimson
14A44	Crimson Dark Dark
14A45	Violet Dark
14A46	Pink Dark Dark
14A47	Ultramarine Dark
14A48	Cobalt Blue
14A49	Terra Cotta
14A50	Ochre Dark

Summit

54" wide	
100% silicone	
Polyester knit backing	
3SU01	Bright White
3SU02	Oyster
3SU03	Zinc
3SU04	Sparrow
3SU05	Taupe
3SU06	Java
3SU07	Black
3SU08	Cherry
3SU09	Beachglass
3SU10	Midnight

Price Category 6

Balance

For Embody® chairs	
100% polyester	
3512	Carbon
3513	Black

Proprietary Textile Colors — Seating

continued

GSA

Price Category 7

Customer's Own Leather
See Order Information in
Appendices. Assigned lead-time
textile. [A](#)

Price Category 8

No fabrics available at this time.

Price Category 9

Leather	
approx. 50 sq. ft. per hide	
100% leather	
2101	Ivory
2109	Black *
2110	Smoke
2111	Graphite
2112	Khaki
2113	Rattan
2114	Truffle
2115	Alpine
2116	Haze
2117	Sable Grey
2118	Dark Mineral **
2119	Dark Carbon ***
2120	Cranberry
2121	Deep Sea

* Armpad color available on
Aeron® Chair, Graphite.

** Armpad color available on
Aeron Chair, Mineral.

*** Armpad color available on
Aeron Chair, Carbon.

Proprietary Textile Colors — Seating

continued

GSA

Price Category 9

Appendix: Proprietary Textile Colors — Seating

Leather	
approx. 50 sq. ft. per hide	
100% leather	
2101	Ivory
2109	Black *
2110	Smoke
2111	Graphite
2112	Khaki
2113	Rattan
2114	Truffle
2115	Alpine
2116	Haze
2117	Sable Grey
2118	Dark Mineral **
2119	Dark Carbon ***
2120	Cranberry
2121	Deep Sea

* Armpad color available on Aeron® Chair, Graphite.
** Armpad color available on Aeron Chair, Mineral.
*** Armpad color available on Aeron Chair, Carbon.

Maharam Application Chart — Seating

GSA

- Available

[A] Maharam textiles are on assigned lead times.

[N] Non-woven textile.

	Sayl® Work Chairs	Sayl Side Chairs	Setu® Chairs	Verus™ Work Chairs/Stools Back	Verus Work Chairs/Stools Seat	Verus Side Chairs Back	Verus Side Chairs Seat	Verus Plus Chairs	Aside® Chairs	Caper® Chairs/Stools	Lino™ Chairs Seat	OE1 Storage Trolley Cushion Top	Public Office Landscape® Seat	Plex® Lounge Furniture	Swoop™ Lounge Seating - Fully Upholstered	Swoop Lounge Seating - Plywood	Valor™ Seating	Cushion Tops
Price Category 1																		
No fabrics available at this time.																		
Price Category 2																		
ZMA__ Metaphor - Maharam	16	16	•	•	•	•	•	•	•	•	•	•	•	•	•	•	•	•
8I1__ Muse - Maharam	16	16		•	•					•		•						26
Price Category 3-4																		
No fabrics available at this time.																		
Price Category 5																		
4OG__ Method - Maharam	16	16	•	•	•	•	•	•	•	•	•	•	•	•	•	•	•	•
ZNC__ Nico - Maharam	•	•	•	•	•	•	•	•	•	•	•	•	•	•	•	•	•	•
Price Category 6-8																		
No fabrics available at this time.																		
Price Category 9																		
ZGE__ Gemma - Maharam	•	•	•	•	•	•	•	•	•	•	•	•	•	•	•	•	•	•
ZJA__ Jasper - Maharam	16	16		•	•	•	•	•	•	•	•	•	•	•	•	•	•	7
Price Category 10																		
3KH__ Firma - Maharam	16		•	•	•	•	•	•	•	•	•	•	•	•	•	•	•	•
ZGF__ Gemma Multi - Maharam	•	•	•	•	•	•	•	•	•	•	•	•	•	•	•	•	•	•
ZGF__ Gemma Multi Reverse - Maharam	•	•	•	•	•	•	•	•	•	•	•	•	•	•	•	•	•	•
ZP4__ Petra - Maharam	16	16		•	•	•	•	•	•	•	•	•	•	•	•	•	•	•
Price Category A																		
No fabrics available at this time.																		
Price Category B																		
TI__ Messenger - Maharam *	•	•	•	•	•	•	•	•	•	•	•	•	•	•	•	•	•	26
Price Category C																		
Z27__ Manner - Maharam	•	•		•	•	•	•	•	•	•	•	•	•	•	•	•	•	•
887__ Merit - Maharam	•	•		•	•	•	•	•	•	•	•	•	•	•	•	•	•	•
Z3__ Metric - Maharam	•	•		•	•	•	•	•	•	•	•	•	•	•	•	•	•	•
8EY__ Murmur - Maharam	•	16		•	•	•	•	•	•	•	•	•	•	•	•	•	•	7
Price Category D																		
8I8__ Bluff - Maharam [N]	16	16		•	•	•	•	•	•	8			•	21		•	•	•
Price Category E																		
896__ Dwell - Maharam	16	16		•	•	•	•	•	•	•	•	•	•	•	•	•	•	7
ZR2__ Roster - Maharam	16	16		•	•	•	•	•	•	•	•	•	•	•	•	•	•	•
Price Category F																		
82T__ Apt [N] - Maharam	18	•		•	•	•	•	•	•	•	•	•	•	•	•	•	•	7
74M__ Instill [N] - Maharam	18	16		•	•	•	•	•	•	•	•	•	•	•	•	•	•	7
89N__ Keen - Maharam	16	16		•	•	•	•	•	•	•	•	•	•	•	•	•	•	•
V9G__ Ledger - Maharam	18	16		•	•	•	•	•	•	•	•	•	•	•	•	•	•	•
ZLL__ Loop - Maharam	16	16		•	•	•	•	•	8	•	•	•	•	•	•	•	•	•
8LW__ Pepper - Maharam	16	16		•	•	•	•	•	•	•	•	•	•	21	•	•	•	9
Z33__ Strum - Maharam [N]		16													•	•	•	7

* Available in select colors on 20-day lead-time. Refer to "Maharam Colors - Seating" for 20-day colors.

Continued on next page

Maharam Application Chart — Seating

continued

GSA

Appendix: Maharam Application Chart — Seating

	Sayl® Work Chairs	Sayl Side Chairs	Setu® Chairs	Verus™ Work Chairs/Stools Back	Verus Work Chairs/Stools Seat	Verus Side Chairs Back	Verus Side Chairs Seat	Verus Plus Chairs	Aside® Chairs	Cape® Chairs/Stools	Lino™ Chairs Seat	OE1 Storage Trolley Cushion Top	Public Office Landscape® Seat	Plex® Lounge Furniture	Swoop™ Lounge Seating - Fully Upholstered	Swoop Lounge Seating - Plywood	Valor™ Seating	Cushion Tops
Price Category G																		
ZC2__ Compound - Maharam [N]	16	16		•	•	•	•		8		•			•	•	•	•	7
8AR__ Gild - Maharam		16		•	•	•	•						•	21	•	•	•	
Price Category H																		
ZT__ Circles - Maharam	16	16																•
ZK__ Dot Pattern - Maharam	•	•	•		•		•		•			•						•
ZL__ Small Dot Pattern - Maharam	•	•	•		•		•		•			•						•
Price Category I																		
7CW__ Cursive - Maharam	16	16		•	•	•	•		8		•	•	•		•		•	•
Price Category J-V																		
No fabrics available at this time.																		

- 7 Available on 1" Cushion Tops only.
- 8 Only available on the Aside nonupholstered outer back option (PB).
- 9 Available on Valor upholstered seat.
- 16 Available on Sayl Chair seat.

- 18 Available on Sayl Chair seat and upholstered mid-back.
- 20 Not available on Plex Club Chair with Headrest.
- 21 Available on Plex seat and on ottoman.
- 26 Available in select colors. Refer to "Maharam Colors - Seating" for color offering.

Maharam Colors – Seating

GSA

Price Category 1

No fabrics available at this time.

Price Category 2

Metaphor – Maharam

54" wide
100% polyester
Acrylic backing
ZMA01/466553-001 Afterfeather
ZMA02/466553-002 Moonflower
ZMA03/466553-003 Handcraft
ZMA04/466553-004 Crossroad
ZMA05/466553-005 Chondrite
ZMA06/466553-006 Detective
ZMA07/466553-007 Steamship
ZMA08/466553-008 Electricity
ZMA09/466553-009 Takeoff
ZMA10/466553-010 Parachute
ZMA11/466553-011 Blueshift
ZMA12/466553-012 Dockyard
ZMA13/466553-013 Bathe
ZMA14/466553-014 Icebound
ZMA15/466553-015 Thermosphere
ZMA16/466553-016 Aboard
ZMA17/466553-017 Agateway
ZMA18/466553-018 Homeland
ZMA19/466553-019 Rockfall
ZMA20/466553-020 Undergrowth
ZMA21/466553-021 Gremolata
ZMA22/466553-022 Patina
ZMA23/466553-023 Sylvan
ZMA24/466553-024 Outfield
ZMA25/466553-025 Windbreak
ZMA26/466553-026 Saguaro
ZMA27/466553-027 Barnwood
ZMA28/466553-028 Cookshop
ZMA29/466553-029 Amandine
ZMA30/466553-030 Bodhran
ZMA31/466553-031 Centerstage
ZMA32/466553-032 Focaccia
ZMA33/466553-033 Bumblebee
ZMA34/466553-034 Microbrew
ZMA35/466553-035 Sauna
ZMA36/466553-036 Gazebo
ZMA37/466553-037 Pirouette
ZMA38/466553-038 Heartbeat
ZMA39/466553-039 Shino
ZMA40/466553-040 Sunrise

Metaphor continued

ZMA41/466553-041 Florist
ZMA42/466553-042 Beadwork
ZMA43/466553-043 Framboise
ZMA44/466553-044 Wisteria
ZMA45/466553-045 Warrior

Muse – Maharam

54" wide
100% post-consumer recycled polyester
8I101/466487-001 Crescendo
8I102/466487-002 Resonate
8I103/466487-003 Runway
8I104/466487-004 Ascend
8I105/466487-005 Veil
8I106/466487-006 Refresh
8I107/466487-007 Clear
8I108/466487-008 Fantasy
8I109/466487-009 Miso
8I110/466487-010 Compass
8I111/466487-011 Bergamot
8I112/466487-012 Grasshopper
8I113/466487-013 Goal
8I114/466487-014 Mistletoe
8I115/466487-015 Seaglass
8I116/466487-016 Frigid
8I117/466487-017 Riverbend
8I118/466487-018 Noble
8I119/466487-019 Pulsar
8I120/466487-020 Vellella
8I121/466487-021 Sailboat
8I122/466487-022 Sparse
8I123/466487-023 Vase
8I124/466487-024 Haven
8I125/466487-025 Mead
8I126/466487-026 Neat
8I127/466487-027 Jovial
8I128/466487-028 Theater
8I129/466487-029 Poinsettia
8I130/466487-030 Celebrate
8I131/466487-031 Spectacle

Price Category 3-4

No fabrics available at this time.

- Maharam textiles are on assigned lead times ^A unless otherwise noted.
- Fabric numbers are listed as Herman Miller fabric number/Maharam fabric number.

Maharam Colors – Seating

continued

GSA

Appendix: Maharam Colors – Seating

Price Category 5

Method – Maharam	
54" wide	
100% recycled polyester with 12% ocean-bound plastic	
40G01/466579-001	Inspire
40G02/466579-002	Rhea
40G03/466579-003	Noise
40G04/466579-004	Speedway
40G05/466579-005	Villanelle
40G06/466579-006	Maestro
40G07/466579-007	Destiny
40G08/466579-008	Possess
40G09/466579-009	Waterside
40G10/466579-010	Relax
40G11/466579-011	Delightful
40G12/466579-012	Parrotlet
40G13/466579-013	Verdurous
40G14/466579-014	Bosky
40G15/466579-015	Acreage
40G16/466579-016	Allude
40G17/466579-017	Tweed
40G18/466579-018	Korma
40G19/466579-019	Fossilize
40G20/466579-020	Cattail
40G21/466579-021	Shortcake
40G22/466579-022	Racecar
40G23/466579-023	Courtship
40G24/466579-024	Jam
40G25/466579-025	Sparrow

Nico - Maharam	
54" wide	
63% wool	
21% polyester	
16% solution-dyed nylon	
ZNC01/466564-001	Alcazar
ZNC02/466564-002	Ironclad
ZNC03/466564-003	Tune
ZNC04/466564-004	Bridegroom
ZNC05/466564-005	Diode
ZNC06/466564-006	Jest
ZNC07/466564-007	Sanctuary
ZNC08/466564-008	Aquarius
ZNC09/466564-009	Houseboat
ZNC10/466564-010	Olympian
ZNC11/466564-011	Tennis
ZNC12/466564-012	Dressage
ZNC13/466564-013	Zing
ZNC14/466564-014	Bitterroot
ZNC15/466564-015	Gemini
ZNC16/466564-016	Posh
ZNC17/466564-017	Sizzle
ZNC18/466564-018	Cheerful
ZNC19/466564-019	Watermelon
ZNC20/466564-020	Toucan
ZNC21/466564-021	Rosin
ZNC22/466564-022	Jousting
ZNC23/466564-023	Jojoba
ZNC24/466564-024	Dromedary
ZNC25/466564-025	Toasty
ZNC26/466564-026	Casaba
ZNC27/466564-027	Greenhouse
ZNC28/466564-028	Sibyl
ZNC29/466564-029	Spearmint
ZNC30/466564-030	Pothos
ZNC31/466564-031	Calathea
ZNC32/466564-032	Landscape
ZNC33/466564-033	Espalier
ZNC34/466564-034	Gecko
ZNC35/466564-035	Meditation

Price Category 6-8

No fabrics available at this time.

Price Category 9

Gemma – Maharam	
55" wide	
85% wool	
15% nylon	
ZGE01/466568-001	Crinoline
ZGE02/466568-002	Angelic
ZGE03/466568-003	Savory
ZGE04/466568-004	Honeycomb
ZGE05/466568-005	Gilded
ZGE06/466568-006	Paddleboat
ZGE07/466568-007	Stagecoach
ZGE08/466568-008	Waterbuck
ZGE09/466568-009	Earnest
ZGE10/466568-010	Auric
ZGE11/466568-011	Carmine
ZGE12/466568-012	Serape
ZGE13/466568-013	Ferric
ZGE14/466568-014	Canyon
ZGE15/466568-015	Alembic
ZGE16/466568-016	Patio
ZGE17/466568-017	Sorrel
ZGE18/466568-018	Root
ZGE19/466568-019	Mansion
ZGE20/466568-020	Buff
ZGE21/466568-021	Starch
ZGE22/466568-022	Dawn
ZGE23/466568-023	Countryside
ZGE24/466568-024	Dewy
ZGE25/466568-025	Reliquary
ZGE26/466568-026	Deluge
ZGE27/466568-027	Overlay
ZGE28/466568-028	Electron
ZGE29/466568-029	Sheath
ZGE30/466568-030	Quietude
ZGE31/466568-031	Jargon
ZGE32/466568-032	Powder
ZGE33/466568-033	Tide
ZGE34/466568-034	Outwash
ZGE35/466568-035	Enamored
ZGE36/466568-036	Smitten
ZGE37/466568-037	Revere
ZGE38/466568-038	Mangosteen
ZGE39/466568-039	Allium
ZGE40/466568-040	Immense
ZGE41/466568-041	Chamber

- Maharam textiles are on assigned lead times **A** unless otherwise noted.
- Fabric numbers are listed as Herman Miller fabric number/Maharam fabric number.

Price category 9 continued on next page

Maharam Colors – Seating

continued

GSA

Price Category 9

continued

Gemma continued

ZGE42/466568-042	Cosmos
ZGE43/466568-043	Inkling
ZGE44/466568-044	Rainwater
ZGE45/466568-045	Shade
ZGE46/466568-046	Pendant
ZGE47/466568-047	Axial
ZGE48/466568-048	Fervent
ZGE49/466568-049	Legacy
ZGE50/466568-050	Caliber
ZGE51/466568-051	Temple
ZGE52/466568-052	Evenfall

Jasper - Maharam

53" wide	
55% wool	
27% solution-dyed nylon	
18% cotton	
ZJA01/466563-001	Thrill
ZJA02/466563-002	Anise
ZJA03/466563-003	Grapefruit
ZJA04/466563-004	Lifeguard
ZJA05/466563-005	Heartfelt
ZJA06/466563-006	Corsage
ZJA07/466563-007	Earthenware
ZJA08/466563-008	Bear
ZJA09/466563-009	Firelight
ZJA10/466563-010	Dreamcatcher
ZJA11/466563-011	Bobcat
ZJA12/466563-012	Glacial
ZJA13/466563-013	Vaporize
ZJA14/466563-014	Trapdoor
ZJA15/466563-015	Halcyon
ZJA16/466563-016	Observatory
ZJA17/466563-017	Steamboat
ZJA18/466563-018	Aquathlon
ZJA19/466563-019	Cloudless
ZJA20/466563-020	Briny
ZJA21/466563-021	Magical
ZJA22/466563-022	Picnic
ZJA23/466563-023	Herbage
ZJA24/466563-024	Pasture
ZJA25/466563-025	Courtyard
ZJA26/466563-026	Leapfrog

Price Category 10

Firma – Maharam

55" wide	
78% wool	
22% nylon	
3KH01/466582-001	Wrath
3KH02/466582-002	Pantomime
3KH03/466582-003	Shaded
3KH04/466582-004	Prologue
3KH05/466582-005	Framework
3KH06/466582-006	Railroad
3KH07/466582-007	Grommet
3KH08/466582-008	Lunisolar
3KH09/466582-009	Snowpack
3KH10/466582-010	Coldsnap
3KH11/466582-011	Sealift
3KH12/466582-012	Brood
3KH13/466582-013	Intertidal
3KH14/466582-014	Confide
3KH15/466582-015	Secluded
3KH16/466582-016	Leisure
3KH17/466582-017	Portfolio
3KH18/466582-018	Strato
3KH19/466582-019	Fogbow
3KH20/466582-020	Snowcone
3KH21/466582-021	Kazoo
3KH22/466582-022	Esteem
3KH23/466582-023	Mackerel
3KH24/466582-024	Brooch
3KH25/466582-025	Caesious
3KH26/466582-026	Islet
3KH27/466582-027	Biosphere
3KH28/466582-028	Hilltop
3KH29/466582-029	Arboreal
3KH30/466582-030	Lineage
3KH31/466582-031	Comfrey
3KH32/466582-032	Circe
3KH33/466582-033	Ecosystem
3KH34/466582-034	Knack
3KH35/466582-035	Watt
3KH36/466582-036	Epiphany
3KH37/466582-037	Gamma
3KH38/466582-038	Taxicab
3KH39/466582-039	Varietal

Gemma Multi – Maharam

55" wide	
85% wool	
15% nylon	
ZGF01/466569-001	Andromeda
ZGF02/466569-002	Dappled
ZGF03/466569-003	Lyra
ZGF04/466569-004	Flaunt
ZGF05/466569-005	Celluloid
ZGF06/466569-006	Hydrozoa
ZGF07/466569-007	Firefly
ZGF08/466569-008	Pisces
ZGF09/466569-009	Strath
ZGF10/466569-010	Erosion
ZGF11/466569-011	Cabaret
ZGF12/466569-012	Candytuft
ZGF13/466569-013	Juice
ZGF14/466569-014	Fairground
ZGF15/466569-015	Copperplate
ZGF16/466569-016	Sunbird
ZGF17/466569-017	Cinematic
ZGF18/466569-018	Clairvoyant
ZGF19/466569-019	Crocus
ZGF20/466569-020	Memoir
ZGF21/466569-021	Roulette
ZGF22/466569-022	Voltaic
ZGF23/466569-023	Compote
ZGF24/466569-024	Lambent
ZGF25/466569-025	Twister
ZGF26/466569-026	Chronicle
ZGF27/466569-027	Sidereal
ZGF28/466569-028	Tanzanite
ZGF29/466569-029	Crystalize
ZGF30/466569-030	Chromium
ZGF31/466569-031	Pallium
ZGF32/466569-032	Spectre
ZGF33/466569-033	Courgette
ZGF34/466569-034	Viper
ZGF35/466569-035	Sunlit
ZGF36/466569-036	Heavenly
ZGF37/466569-037	Vernal
ZGF38/466569-038	Cress
ZGF39/466569-039	Limn
ZGF40/466569-040	Horseradish

Gemma Multi continued

ZGF41/466569-041	Shandy
ZGF42/466569-042	Granary
ZGF43/466569-043	Percolate
ZGF44/466569-044	Motor
ZGF45/466569-045	Unicorn
ZGF46/466569-046	Lobster
ZGF47/466569-047	Rhododendron
ZGF48/466569-048	Taffy
ZGF49/466569-049	Rishi
ZGF50/466569-050	Backcountry
ZGF51/466569-051	Buckthorn
ZGF52/466569-052	Coniferous
ZGF53/466569-053	Delphic
ZGF54/466569-054	Hieroglyph
ZGF55/466569-055	Eiderdown
ZGF56/466569-056	Sandbar
ZGF57/466569-057	Tanager

Gemma Multi Reverse – Maharam

55" wide	
85% wool	
15% nylon	
ZGF58/466569-101	Andromeda
	Reverse
ZGF59/466569-102	Dappled
	Reverse
ZGF60/466569-103	Lyra
	Reverse
ZGF61/466569-104	Flaunt
	Reverse
ZGF62/466569-105	Celluloid
	Reverse
ZGF63/466569-106	Hydrozoa
	Reverse
ZGF64/466569-107	Firefly
	Reverse
ZGF65/466569-108	Pisces
	Reverse
ZGF66/466569-109	Strath
	Reverse
ZGF67/466569-110	Erosion
	Reverse

Price category 10 continued on next page

- Maharam textiles are on assigned lead times ^A unless otherwise noted.
- Fabric numbers are listed as Herman Miller fabric number/Maharam fabric number.

Maharam Colors — Seating

continued

GSA

Price Category 10

continued

Price Category A

Appendix: Maharam Colors — Seating

Gemma Multi Reverse *continued*

ZGF68/466569-111 Cabaret	Reverse
ZGF69/466569-112 Candytuft	Reverse
ZGF70/466569-113 Juice	Reverse
ZGF71/466569-114 Fairground	Reverse
ZGF72/466569-115 Copperplate	Reverse
ZGF73/466569-116 Sunbird	Reverse
ZGF74/466569-117 Cinematic	Reverse
ZGF75/466569-118 Clairvoyant	Reverse
ZGF76/466569-119 Crocus	Reverse
ZGF77/466569-120 Memoir	Reverse
ZGF78/466569-121 Roulette	Reverse
ZGF79/466569-122 Voltaic	Reverse
ZGF80/466569-123 Compote	Reverse
ZGF81/466569-124 Lambent	Reverse
ZGF82/466569-125 Twister	Reverse
ZGF83/466569-126 Chronicle	Reverse
ZGF84/466569-127 Sidereal	Reverse
ZGF85/466569-128 Tanzanite	Reverse
ZGF86/466569-129 Crystalize	Reverse
ZGF87/466569-130 Chromium	Reverse
ZGF88/466569-131 Pallium	Reverse
ZGF89/466569-132 Spectre	Reverse

Gemma Multi Reverse *continued*

ZGF90/466569-133 Courgette	Reverse
ZGF91/466569-134 Viper	Reverse
ZGF92/466569-135 Sunlit	Reverse
ZGF93/466569-136 Heavenly	Reverse
ZGF94/466569-137 Vernal	Reverse
ZGF95/466569-138 Cress	Reverse
ZGF96/466569-139 Limn	Reverse
ZGF97/466569-140 Horseradish	Reverse
ZGF98/466569-141 Shandy	Reverse
ZGF99/466569-142 Granary	Reverse
ZGFA0/466569-143 Percolate	Reverse
ZGFA1/466569-144 Motor	Reverse
ZGFA2/466569-145 Unicorn	Reverse
ZGFA3/466569-146 Lobster	Reverse
ZGFA4/466569-147 Rhododendron	Reverse
ZGFA5/466569-148 Taffy	Reverse
ZGFA6/466569-149 Rishi	Reverse
ZGFA7/466569-150 Backcountry	Reverse
ZGFA8/466569-151 Buckthorn	Reverse
ZGFA9/466569-152 Coniferous	Reverse
ZGFB0/466569-153 Delphic	Reverse
ZGFB1/466569-154 Hieroglyph	Reverse

Gemma Multi Reverse *continued*

ZGFB2/466569-155 Eiderdown	Reverse
ZGFB3/466569-157 Tanager	Reverse

Petra - Maharam

55" wide	
70% wool	
19% linen	
11% nylon	
ZP401/466580-001 Hieroglyph	
ZP402/466580-002 Interior	
ZP403/466580-003 Samovar	
ZP404/466580-004 Calcite	
ZP405/466580-005 Silversmith	
ZP406/466580-006 Rivet	
ZP407/466580-007 Carpolite	
ZP408/466580-008 Bonbon	
ZP409/466580-009 Dreamy	
ZP410/466580-010 Bejewel	
ZP411/466580-011 Sashimi	
ZP412/466580-012 Spirula	
ZP413/466580-013 Chalet	
ZP414/466580-014 Reindeer	
ZP415/466580-015 Nostalgia	
ZP416/466580-016 Trove	
ZP417/466580-017 Narcissus	
ZP418/466580-018 Yurt	
ZP419/466580-019 Congee	
ZP420/466580-020 Genepy	
ZP421/466580-021 Herbaceous	
ZP422/466580-022 Paddock	
ZP423/466580-023 Precious	
ZP424/466580-024 Biome	
ZP425/466580-025 Tinted	
ZP426/466580-026 Pelagic	
ZP427/466580-027 Bluebill	
ZP428/466580-028 Chicory	
ZP429/466580-029 Eaglet	
ZP430/466580-030 Permafrost	
ZP431/466580-031 Atlantic	
ZP432/466580-032 Airstream	
ZP433/466580-033 Debonair	

No fabrics available at this time.

- Maharam textiles are on assigned lead times A unless otherwise noted.
- Fabric numbers are listed as Herman Miller fabric number/Maharam fabric number.

Maharam Colors — Seating

continued

GSA

Price Category B

Messenger — Maharam	
54" wide	
78% post-industrial recycled polyester	
15% polyester	
7% nylon	
TI07/458640-007	Shadow
TI08/458640-008	Bayou *
TI24/458640-024	Poppy
TI25/458640-025	Mao
TI29/458640-029	Onyx *
TI31/458640-031	Cloud *
TI38/458640-038	Depth *
TI40/458640-040	Nile *
TI41/458640-041	Azure *
TI45/458640-045	Cactus *
TI46/458640-046	Ice *
TI48/458640-048	Neon
TI50/458640-050	Hydrangea
TI53/458640-053	Tangelo
TI54/458640-054	Lumine *
TI58/458640-058	Snow **
TI60/458640-060	Peridot
TI61/458640-061	Capri *
TI62/458640-062	Ultramarine
TI63/458640-063	Squall
TI66/458640-066	Cassia
TI67/458640-067	Aster

Messenger continued	
TI69/458640-069	Cherry
TI70/458640-070	Vibrant
TI71/458640-071	Satsuma *
TI72/458640-072	Maize
TI76/458640-076	Fossil
TI77/458640-077	Ash
TI78/458640-078	Tusk
TI79/458640-079	Oyster **
TI81/458640-081	Husk
TI84/458640-084	Robust
TI85/458640-085	Beyond
TI86/458640-086	Voyage *
TI87/458640-087	Everglade
TI89/458640-089	Blanch **
TI90/458640-090	Longspur
TI91/458640-091	Vireo
TI92/458640-092	Dipper
TI93/458640-093	Gale
TI94/458640-094	Hunter
TI95/458640-095	Lime
TI96/458640-096	Apple
TI97/458640-097	Krill
TI98/458640-098	Catalyst

* Colors available on 20-day lead time.
 ** Colors not available on Eames Molded Fiberglass and Molded Plastic Side Chairs.

Price Category C

Manner - Maharam	
54" wide	
65% post-industrial recycled polyester	
35% post-consumer recycled polyester	
Z2701/466177-001	Magic
Z2702/466177-002	Carob
Z2703/466177-003	Porpoise
Z2704/466177-004	Flint
Z2705/466177-005	Hush *
Z2706/466177-006	Nuance
Z2711/466177-011	Ember
Z2712/466177-012	Wagon
Z2713/466177-013	Ablaze
Z2714/466177-014	Peel
Z2716/466177-016	Butterscotch
Z2717/466177-017	Harvest
Z2720/466177-020	Parakeet
Z2722/466177-022	Aquatic
Z2723/466177-023	Cottage
Z2724/466177-024	Dahlia
Z2725/466177-025	Vivid
Z2726/466177-026	Basin
Z2727/466177-027	Schooner
Z2728/466177-028	Slope
Z2729/466177-029	Silverpoint
Z2730/466177-030	Lattice
Z2731/466177-031	Smoky
Z2732/466177-032	Magnetic
Z2733/466177-033	Woad
Z2734/466177-034	Resolute
Z2735/466177-035	Cruise
Z2736/466177-036	Atmospheric
Z2737/466177-037	Cloudburst
Z2738/466177-038	Tidewater
Z2739/466177-039	Firth
Z2740/466177-040	Oceanside
Z2741/466177-041	Grandeur
Z2742/466177-042	Comfort
Z2743/466177-043	Dill
Z2744/466177-044	Poplar
Z2745/466177-045	Citronella
Z2746/466177-046	Passerine

Manner continued	
Z2747/466177-047	Southwest
Z2748/466177-048	Roseate
Z2749/466177-049	Charisma
Z2750/466177-050	Siltstone
Z2751/466177-051	Kimono
Z2752/466177-052	Valiant
Z2753/466177-053	Baroness

* Color not available on Eames Aluminum Group, Executive Chairs, Upholstered Molded Plywood Chairs, and Sofa Compact.

Merit - Maharam	
54" wide	
76% post-industrial recycled polyester	
24% polyester	
PFOA-Free stain resistant	
88Z01/466444-001	Trickle
88Z02/466444-002	Beluga
88Z03/466444-003	Gunmetal
88Z04/466444-004	Blackout
88Z05/466444-005	Superior
88Z06/466444-006	Ocean
88Z07/466444-007	Highborn
88Z08/466444-008	Immersed
88Z09/466444-009	Rainfall
88Z10/466444-010	Blizzard
88Z11/466444-011	Poolside
88Z12/466444-012	Steel
88Z13/466444-013	Zircon
88Z14/466444-014	Ripple
88Z15/466444-015	Aegean
88Z16/466444-016	Armada
88Z17/466444-017	Hedera
88Z18/466444-018	Rainforest
88Z19/466444-019	Gator
88Z20/466444-020	Vineyard
88Z21/466444-021	Pine
88Z22/466444-022	Kiwi
88Z23/466444-023	Kookaburra

Price category C continued on next page

- Maharam textiles are on assigned lead times ^A unless otherwise noted.
- Fabric numbers are listed as Herman Miller fabric number/Maharam fabric number.

Maharam Colors – Seating

continued

GSA

Price Category C

continued

Merit continued

88Z24/466444-024	Bellini
88Z25/466444-025	Sunflower
88Z26/466444-026	Sandstorm
88Z27/466444-027	Mudder
88Z28/466444-028	Lynx
88Z29/466444-029	Farro
88Z30/466444-030	Manila
88Z31/466444-031	Starfish
88Z32/466444-032	Brass
88Z33/466444-033	Arrow
88Z34/466444-034	Gelato
88Z35/466444-035	Nectarine
88Z36/466444-036	Macaron
88Z37/466444-037	Alert
88Z38/466444-038	Goji
88Z39/466444-039	Cabernet
88Z40/466444-040	Eggplant
88Z41/466444-041	Hawk
88Z42/466444-042	Stag
88Z43/466444-043	Overcast

Metric – Maharam

54" wide	
51% post-industrial recycled polyester	
49% polyester	
Z302/466014-002	Fog
Z303/466014-003	Fleece
Z312/466014-012	Cardinal
Z313/466014-013	Lava
Z318/466014-018	Pollen
Z320/466014-020	Alligator
Z323/466014-023	Tar
Z324/466014-024	Anchor
Z326/466014-026	Admiral
Z327/466014-027	Seaport
Z328/466014-028	Scuba
Z329/466014-029	Skate
Z330/466014-030	Hopscotch
Z331/466014-031	Film
Z332/466014-032	Whale
Z333/466014-033	Downpour
Z334/466014-034	Midday

Metric continued

Z335/466014-035	Talisman
Z336/466014-036	Hedgerow
Z337/466014-037	Snorkel
Z338/466014-038	Highway
Z339/466014-039	Canary
Z340/466014-040	Sunny
Z341/466014-041	Aztec
Z342/466014-042	Fruit
Z343/466014-043	Galah
Z344/466014-044	Kiln
Z345/466014-045	Moth

Murmur - Maharam

55" wide	
100% polyester	
PFOA-Free stain resistant	
8EY01/466446-001	Gust
8EY02/466446-002	Harmonica
8EY03/466446-003	Canopy
8EY04/466446-004	Dim
8EY05/466446-005	Peppercorn
8EY06/466446-006	Cauldron
8EY07/466446-007	Conquer
8EY08/466446-008	Rapids
8EY09/466446-009	Seawater
8EY10/466446-010	Baby
8EY11/466446-011	Elderberry
8EY12/466446-012	Iceberg
8EY13/466446-013	Tallgrass
8EY14/466446-014	Underground
8EY15/466446-015	Biome
8EY16/466446-016	Cask
8EY17/466446-017	Argan
8EY18/466446-018	Sundown
8EY19/466446-019	Ignite
8EY20/466446-020	Sultry
8EY21/466446-021	Sangria

Price Category D

Bluff - Maharam

54" wide	
100% polyurethane	
Ink-resistant protective top coat	
Polyester backing	
8I801/466489-001	Loom
8I802/466489-002	Helm
8I803/466489-003	Cruller
8I804/466489-004	Folklore
8I805/466489-005	Beguile
8I806/466489-006	Sherpa
8I807/466489-007	Teleport
8I808/466489-008	Annex
8I809/466489-009	Lorimer
8I810/466489-010	Cinema
8I811/466489-011	Zip
8I812/466489-012	Coach
8I813/466489-013	Supernova
8I814/466489-014	Pirate
8I815/466489-015	Academy
8I816/466489-016	Disco
8I817/466489-017	Equator
8I818/466489-018	Brink
8I819/466489-019	Scene
8I820/466489-020	Petrichor
8I821/466489-021	Exotic
8I822/466489-022	Fauna
8I823/466489-023	Calabash
8I824/466489-024	Fuscous
8I825/466489-025	Wildling
8I826/466489-026	Blitz
8I827/466489-027	Allspice
8I828/466489-028	Lumos
8I829/466489-029	Pilot
8I830/466489-030	Jukebox
8I831/466489-031	Dugout
8I832/466489-032	Claret
8I833/466489-033	Flamenco

Price Category E

Dwell - Maharam

54" wide	
66% post-industrial recycled polyester	
32% post-consumer recycled polyester	
PFOA-Free stain resistant	
Latex backing	
89602/466419-002	Summit
89603/466419-003	Freeze
89604/466419-004	Poolside
89605/466419-005	Teal
89606/466419-006	Mojito
89608/466419-008	Thunder
89609/466419-009	Foil
89611/466419-011	Firecracker

Roster - Maharam

54" wide	
68% post-consumer recycled polyester	
32% polyester	
PFOA-Free stain resistant	
Acrylic backing	
ZR201/466445-001	Jacana
ZR202/466445-002	Wythe
ZR203/466445-003	Grosgrain
ZR204/466445-004	Ceremony
ZR205/466445-005	Breton
ZR206/466445-006	Frigate

- Maharam textiles are on assigned lead times A unless otherwise noted.
- Fabric numbers are listed as Herman Miller fabric number/Maharam fabric number.

Maharam Colors – Seating

continued

GSA

Price Category F

Apt – Maharam	
54" wide	
100% polyurethane/silicone	
Ink-resistant protective top coat	
Polyester backing	
82T12/466392-012 Iris	
82T13/466392-013 Nocturnal	
82T14/466392-014 Fluid	
82T15/466392-015 Eden	
82T16/466392-016 Galactic	
82T17/466392-017 Shoreline	
82T18/466392-018 Jade	
82T19/466392-019 Garden	
82T20/466392-020 Botanic	
82T21/466392-021 Chartreuse	
82T23/466392-023 Lyric	
82T24/466392-024 Turmeric	
82T25/466392-025 Bengal	
82T26/466392-026 Core	
82T27/466392-027 Mantle	
82T28/466392-028 Sorbet	
82T32/466392-032 Oak	
82T33/466392-033 Castle	
82T34/466392-034 Follow	
82T35/466392-035 Elixir	
82T36/466392-036 Charm	
82T37/466392-037 Descend	
82T38/466392-009 Sketch	
82T39/466392-010 Glacier	
82T40/466392-031 Fortress	
82T41/466392-030 Lotus	
82T42/466392-001 Coconut	
82T43/466392-011 Cobblestone	
82T44/466392-029 Bloom	
82T45/466392-022 Crepe	
82T46/466392-006 Hickory	
82T47/466392-007 Constellation	
82T48/466392-008 Labyrinth	
82T49/466392-002 Vibe	
82T50/466392-003 Stampede	
82T51/466392-004 Lumber	
82T52/466392-005 Gingerbread	

Instill – Maharam	
54" wide	
100% polyurethane	
Ink-resistant protective top coat	
Polyester backing	
74M01/466351-001 Page	
74M02/466351-002 Limestone	
74M03/466351-003 Bobwhite	
74M04/466351-004 Loafer	
74M05/466351-005 Moor	
74M06/466351-006 Barley	
74M07/466351-007 Shaker	
74M08/466351-008 Doe	
74M09/466351-009 Ride	
74M10/466351-010 Squire	
74M11/466351-011 Tannin	
74M12/466351-012 Vitis	
74M13/466351-013 Sonar	
74M14/466351-014 Quail	
74M15/466351-015 Brittanica	
74M16/466351-016 Narwhal	
74M17/466351-017 Synth	
74M18/466351-018 Stowaway	
74M19/466351-019 Koala	
74M20/466351-020 Dorsal	
74M21/466351-021 Stealth	

Keen - Maharam	
54" wide	
61% polyester	
39% polyolefin	
PFOA-Free stain resistant	
Acrylic backing	
89N01/466433-001 Gaur	
89N02/466433-002 Lock	
89N03/466433-003 Elk	
89N04/466433-004 Oatmeal	
89N05/466433-005 Lakefront	
89N06/466433-006 Argent	
89N07/466433-007 Coyote	
89N08/466433-008 Eventide	
89N09/466433-009 Canal	
89N10/466433-010 Rosemary	
89N11/466433-011 Herb	
89N12/466433-012 Ruby	
89N13/466433-013 Loganberry	

Ledger – Maharam	
54" wide	
100% polyurethane	
V9G1/463770-001 001	
V9G2/463770-002 002	
V9G3/463770-003 003	
V9G4/463770-004 004	
V9GG/463770-017 017	
V9GQ/463770-025 025	
V9GS/463770-026 026	
V9GU/463770-028 028	
V9GV/463770-029 029	
V9GW/463770-030 030	
V9GX/463770-031 031	
V9GY/463770-032 032	
V9G18/463770-042 042	
V9G19/463770-043 043	
V9G20/463770-044 044	
V9G21/463770-045 045	
V9G22/463770-046 046	

Loop - Maharam	
57" wide	
48% post-industrial recycled polyester	
26% polyester	
26% post-consumer recycled polyester	
PFOA-Free stain resistant	
Acrylic Backing	
ZLL01/466469-001 Opossum	
ZLL02/466469-002 Foundation	
ZLL03/466469-003 Naval	
ZLL04/466469-004 Buoyant	
ZLL05/466469-005 Mockingbird	
ZLL06/466469-006 Dynasty	
ZLL07/466469-007 Zori	
ZLL08/466469-008 Wildfire	
ZLL09/466469-009 Floral	
ZLL10/466469-010 Penguin	

Pepper - Maharam	
58" wide	
49% polyester	
41% post-industrial recycled polyester	
10% post-consumer recycled polyester	
PFOA-Free stain resistant	
Acrylic Backing	
8LW01/466486-001 Dojo	
8LW02/466486-002 Marengo	
8LW03/466486-003 Harlequin	
8LW04/466486-004 Pavlova	
8LW05/466486-005 Sedona	
8LW06/466486-006 Achioté	
8LW07/466486-007 Essence	
8LW08/466486-008 Genome	
8LW09/466486-009 Myriad	
8LW10/466486-010 Terrarium	

Strum - Maharam	
54" wide	
100% polyurethane	
with silver-based antimicrobial	
Z3301/466122-001 Overcast	
Z3302/466122-002 Ridge	
Z3304/466122-004 Pigeon	
Z3307/466122-007 Bur	
Z3308/466122-008 Abalone	
Z3311/466122-011 Wheat	
Z3312/466122-012 Lemongrass	

Appendix: Maharam Colors – Seating

- Maharam textiles are on assigned lead times ^A unless otherwise noted.
- Fabric numbers are listed as Herman Miller fabric number/Maharam fabric number.

Maharam Colors — Seating

continued

GSA

Appendix: Maharam Colors — Seating

Price Category G	Price Category H	Price Category I	Price Category J-V
<p>Compound - Maharam</p> <p>54" wide 100% polyurethane silane-based antimicrobial</p> <p>ZC201/466196-001 Quartz ZC203/466196-003 Weathered ZC204/466196-004 Cliff ZC205/466196-005 Espresso ZC206/466196-006 Smolder ZC207/466196-007 Blaze ZC208/466196-008 Mandarin ZC209/466196-009 Maple ZC210/466196-010 Perennial ZC211/466196-011 Mountainside ZC212/466196-012 Tundra ZC213/466196-013 Manatee ZC214/466196-014 Marine ZC215/466196-015 Twilight ZC216/466196-016 Shelter ZC217/466196-017 Vessel ZC218/466196-018 Smoke ZC219/466196-019 Fog</p> <p>Gild - Maharam</p> <p>54" wide 100% non-phthalate vinyl Ink-resistant protective top coat Polyester backing</p> <p>8AR01/466432-005 Grapevine 8AR02/466432-009 Frosting 8AR03/466432-007 Smokey 8AR04/466432-003 Skylight 8AR05/466432-011 Sandstone 8AR06/466432-004 Hurricane 8AR07/466432-002 Wreath 8AR08/466432-001 Rainforest 8AR09/466432-012 Fudge 8AR10/466432-010 Lantern 8AR11/466432-006 Planet 8AR12/466432-008 Reflection</p>	<p>Circles — Maharam</p> <p>55" wide 70% cotton 30% polyester</p> <p>ZT01/458310-001 Khaki ZT02/458310-002 Fatigue ZT03/458310-003 Document ZT04/458310-004 Engine</p> <p>Dot Pattern — Maharam</p> <p>55" wide 71% cotton 29% polyester</p> <p>ZK01/458300-001 Document ZK02/458300-002 Taupe ZK04/458300-004 Red ZK05/458300-005 Navy</p> <p>Small Dot Pattern — Maharam</p> <p>55" wide 71% cotton 29% polyester</p> <p>ZL01/458320-001 Document ZL02/458320-002 Sand ZL03/458320-003 Khaki ZL04/458320-004 Taupe ZL05/458320-005 Charcoal ZL06/458320-006 Document Reverse ZL07/458320-007 Red ZL08/458320-008 Yellow ZL09/458320-009 Green</p>	<p>Cursive – Maharam</p> <p>54" wide 67% solution-dyed acrylic 33% solution-dyed polyester PFOA-Free stain resistant</p> <p>7CW01/466335-001 Fast 7CW03/466335-003 Beachcomb 7CW05/466335-005 Swift 7CW06/466335-006 Jetstream 7CW07/466335-007 Inkwell 7CW08/466335-008 Rubber</p>	<p>No fabrics available at this time.</p>

- Maharam textiles are on assigned lead times A unless otherwise noted.
- Fabric numbers are listed as Herman Miller fabric number/Maharam fabric number.

For more information about our products and services or to see a list of dealers, please visit us at HermanMiller.com or call (800) 851 1196.

© 2023 Herman Miller, Inc., Zeeland, Michigan

Distribution Rights

Working together since 1956, Herman Miller and Vitra are the authentic sources of designs by Charles and Ray Eames, Alexander Girard, and George Nelson. All the designs shown in this book are protected by law. Herman Miller has obtained all rights to make and sell these designs. Also, Herman Miller holds exclusive worldwide manufacturing and distribution rights for these products with the following exceptions:

Charles and Ray Eames, George Nelson, and Alexander Girard—Worldwide distribution rights for furniture in all areas except Europe and the Middle East. For those areas, please contact Vitra.

Isamu Noguchi—Worldwide distribution rights for the Noguchi Rudder Table. Distribution rights for the Noguchi Table in North America and Central America only. For all other areas, please contact Vitra.

Magis—Exclusive distribution rights in the US and Canada. For all other areas, please contact Magis.

© HermanMiller, ●, Action Office, Aeron, Aside, Canvas Office Landscape, Caper, Cosm, Co/Struc, Eames, Embody, Ethospace, Exclave, Fine-Tune, FlexFront, Formcoat, Ground Cloth, Layout Studio, Lino, Maharam, Meridian, Mirra, Motia, Nelson, Pellicle, Perspectives, Plex, PostureFit, PostureFit SL, Resolve, Sayl, Setu, Tu, Verus, and Y-Tower are among the registered trademarks of Herman Miller, Inc., and its owned subsidiaries.

™ AireWeave, Bubbletack, Cellular Suspension, Commend, Compass, Connect, DOT, Durawrap, Everywhere, Flex-Edge, Headway, Hopsak 2, Intent, Iota, Keyless Entry, Latitude, Lyris 2, Mora, Multiscrim, Nevi, Overlay, Renew, Stackable, Swoop, Thrive, TriFlex, Twist, Valor, Vista and Zeph are among the trademarks of Herman Miller, Inc., and its owned subsidiaries.

Chemsurf® is a registered trademark of Wilsonart International.

Corian® is a registered trademark of E.I. du Pont de Nemours and Company Corporation.

FLEXNET™ is a trademark of Milliken & Company.

Floor Saver Glide® is a registered trademark of Carpin Manufacturing, Inc.

Forest Stewardship Council® is a registered trademark of the Forest Stewardship Council A.C. (FSC). We are FSC® certified (FSC® C102895).

FSC® is a registered trademark of the Forest Stewardship Council A.C. (FSC).

Geiger® is a registered trademark of Geiger International.

MicrobeCare™ is a trademark of Parasol Medical LLC.

Microsoft® and Natural® Keyboard are registered trademarks of Microsoft Corporation.

Place Textiles® is a registered trademark of Place Textiles.