







13 714 705



- 160mm projection
- fixed spout
- rectangular spray pattern with 40 individual jets
- height of mixer 108 mm
- height up to aerator 94 mm
- hole diameter 35 mm
- 2x screw-in M 10 x 1 pressure hose, leak-tested
- 1/2" connection
- max. flow 4 l/min
- lead-free
- This product can help a building to meet requirements of Green Building Rating Systems, e.g. LEED®, BREEAM®, DGNB

	Dark Chrome	13 714 705-19
	Chrome	13 714 705-00
	Brushed Platinum	13 714 705-06
	Brushed Champagne (22kt Gold)	13 714 705-46
	Champagne (22kt Gold)	13 714 705-47
	Brushed Dark Platinum	13 714 705-99

13 714 705

mm [inches]

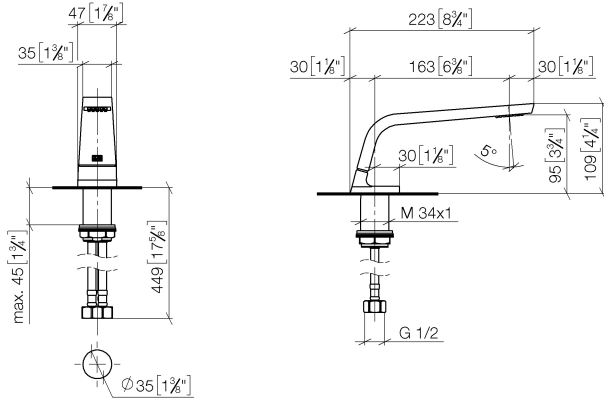

Flow rate chart

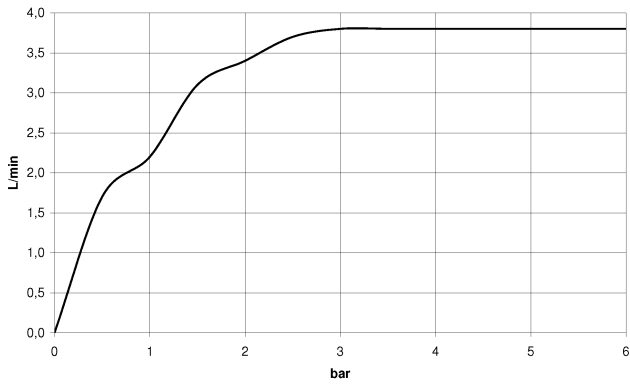

Certificates

GDV_0400279. IAPMO_N-4976. IAPMO_6397.

13 714 705

Parts for other
finishes can be found
here: [Chrome](#)

