

# Understanding and Specifying Steelcase Series 1 Work Chairs

## Product Details

Steelcase Series 1	180
Steelcase Series 1 Upholstery	184
Dimensions	186

## Specifying

### Work Chair

3D Microknit Back with Standard Upholstery on Seat	188
Air Back with Standard Upholstery on Seat	179

### Stool

3D Microknit Back with Standard Upholstery on Seat	192
Air Back with Standard Upholstery on Seat	193

### Accessories

196

## Work Chairs

**Highly adjustable task seating** offers maximum personalization for fit and comfort for a range of duration and use. By making a series of simple adjustments, you can customize the chair to your body, preferences, and tasks. These chairs provide continuous, stable, comfort, and can be quickly adjusted to support you in upright, and reclining work postures.

- Gesture 442 Series
- Leap 462 Series
- Think 465 Series
- Amia 482 Series
- Reply 466 Series

## Adjustability Features

► See page 26 for a comparison to other chairs. **Steelcase Series 1**

### Mechanisms

Weight-activated ●

### Seat Adjustments

Pneumatic height ●

Seat depth ●

### Back Adjustments

Lumbar height ●

### Arm Adjustments

Arm height ●

Arm width ●

Arm pivot ●

Arm depth ●

### Other Features

Foot ring height (stool) ●

# Steelcase Series 1



Now available as a **CarbonNeutral product**, making sure our commitment to a more sustainable future helps yours too.

**Essential ergonomics** –

Steelcase Series 1 provides essential ergonomics at a great value, complete with our signature quality. This exceptional entry point into high-performance seating is characterized by space efficiency, weight-activated controls, and a supportive seat.

**Back frame and seat shell** are plastic.

**Lumbar height** adjusts over 2 1/4" to provide additional lower back support.

**Arm caps** can pivot independently 40° inward and 40° outward to accommodate individual user preferences.

**Seat height** adjusts within a 5" range with a pneumatic adjustment mechanism. Short or tall range is available as an option. Stools have a 7 3/4" range.

**Comfort dial back control** provides three settings for the user's personal preference and work style.

**Casters** have hard, dual-wheels that roll smoothly on carpets. They are 2 1/2" for increased mobility. Soft, dual-wheel roll-control casters are available as an option for use on hard floors or chair mats. Glides are also available as an option.

*Tip: Do not roll the chair across asphalt during installation as this may damage the casters.*

**Arm height** can adjust independently within a 5" range to help relieve upper back and shoulder fatigue.

**Arm width** adjusts 4" overall to support forearms in neutral position.

**Arm depth** can retract 2" to allow user to get closer to the worksurface and into tight corners.

**Seat depth** adjusts within a 2 1/4" range to accommodate users of varying leg lengths.

**Five-star base** is available in paint, plastic, or polished aluminum.

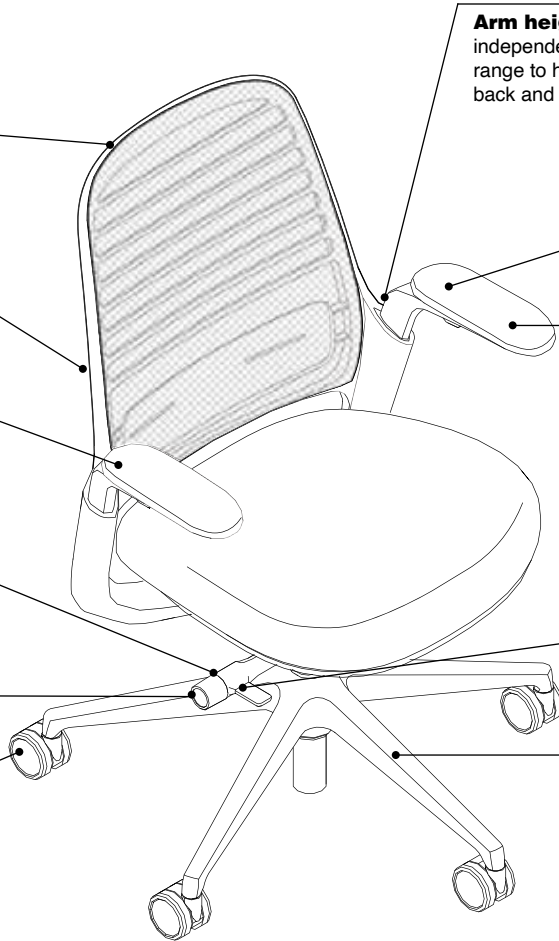

**Product Details**

**Steelcase Series 1** is available in two back designs: 3D microknit (with lumbar and back flexors) and the polypropylene air back.

**3D Microknit Back**

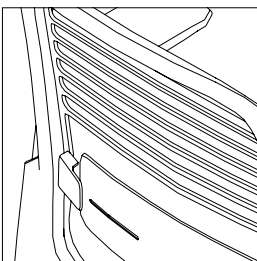

**LiveBack Flexor System** conforms to and mimics the spine to provide flexibility and continuous lower-back support. An additional adjustable lumbar for extra support comes standard.

**Air Back**

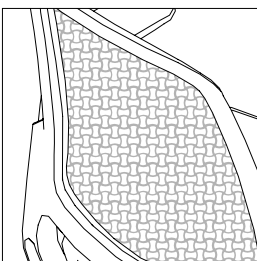

**Air LiveBack technology** specially engineered geometric wave pattern in the polypropylene back flexes in two dimensions to encourage movement and posture changes while providing the spine with responsive support.

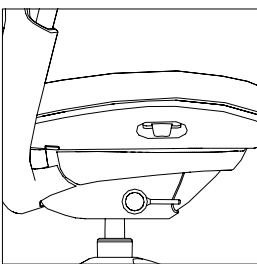

**Advanced weight-activated mechanism with a natural fluid motion** keeps users oriented to their work.

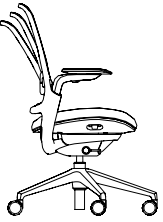

**Comfort dial** has three settings that allow for the user's personal preference and work style.

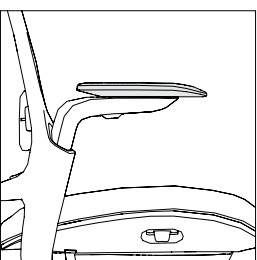

**Pill-shaped arms with soft caps** are standard.

**Uncartoned** request on your dealer purchase order means Steelcase Series 1 chairs will ship fully assembled.

**Cartoned** request on the dealer purchase order means Steelcase Series 1 chairs will ship knocked down in seven pieces. This allows for shipment in a smaller carton. Assembly does not require tools.

*Tip: Assembly instructions are included on the box.*

**Product Weight**  
• Series 1 chair: 29.2 pounds



CarbonNeutral.com  
**CarbonNeutral product** Series 1 helps organizations achieve their carbon emissions goals. Add **CN** to the end of the style number to specify Series 1 with CarbonNeutral product certification.

**Adjustment Features**

**Adjustability instructions** are included with every chair.

**Seat Adjustments**

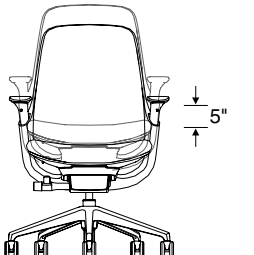

**Seat height** adjusts pneumatically. To lower, hold handle up while seated. To raise, hold handle up and keep your weight off the chair. Standard range of adjustability is 5" from 16 1/2"H to 21 1/2"H. A short 3" range of adjustability (14 3/4" to 17 3/4") and a tall 4 3/4" range of adjustability (17 1/4" to 22") is available as an option. A 7 3/4" range of adjustability (23" to 30 3/4") is available on stools.

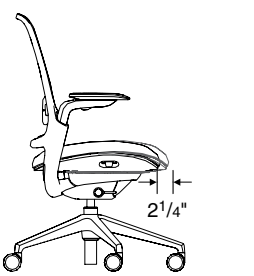

**Seat depth** adjusts 2 1/4" (15 1/2"-17 3/4") by pulling handle up. Slide seat forward or back to accommodate various leg lengths. Release handle to lock.

**Back Adjustments**

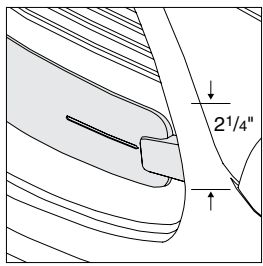

**Lumbar height** (3D microknit back) adjusts 2 1/4" (6 1/2" to 8 3/4" from seat) by grabbing exposed tabs and sliding the lumbar support up or down.



Weight-activated setting  
Boosted setting



Upright setting

**Comfort dial** has three settings: (1) weight-activated setting; (2) boosted setting that has more resistance than your body is providing; and (3) an upright back lock setting.

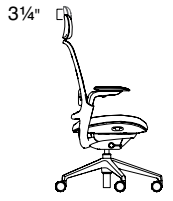

**Headrest** adjusts 3/4" vertically to support the head and neck of the user in both upright and recline postures. The plastic stalk and underside of the headrest will coordinate to match the frame color specified: black or seagull. The foam pad of the headrest is available in 3D Microknit. The headrest may be ordered as an option and must be field installed or as its own style number which ships in its own carton and must be field installed.

**Arm Adjustments**

**Rectilinear height-, width-, pivot-, and depth-adjustable arms** come standard on all arm models of chairs and stools.

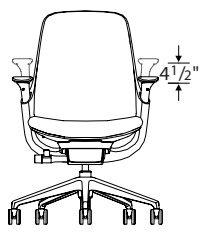

**Arm height** adjusts independently within a range of 4 1/2" (6 1/2"-11" from the seat). Push button on outside and under arm cap in while moving arms up or down. Releasing buttons locks arms in position.

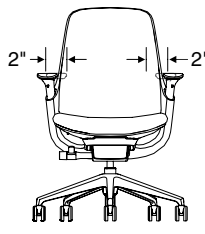

**Arm width** can be adjusted 2" each, 4" overall. Grasp arm cap and move in or out.

Steelcase Series 1, continued

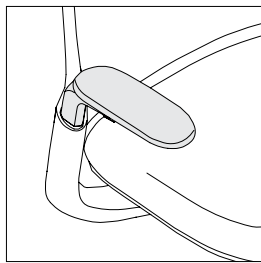

**Arms** pivot independently, 40° inward and outward. Grasp arm and push front to left or right.

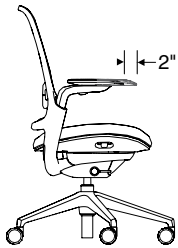

**Arm depth** adjusts by sliding arm caps back 2". Friction-fit mechanism keeps arms in position.

**Other Features**

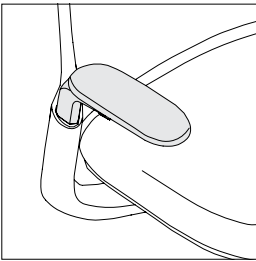

**Height-only adjustable arm** is also available and adjusts 4½".



**Armless models** are also available.

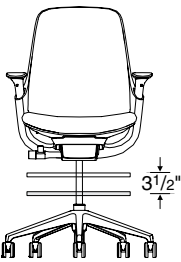

**Foot ring height on stools** adjusts by rotating it counterclockwise to unlock. Then raise or lower ring to desired position before rotating it clockwise to lock. The foot ring has a diameter of 20".

**Soft dual-wheel roll-control casters** feature an internal brake that activates when the chair is not under load to reduce shifting when user stands up.

**Coat hanger (option)** is field installed. The color will coordinate with the frame of the chair but will not match the frame exactly. The coat hanger supports up to ten pounds and is not intended to hold bags or backpacks.

**Surface Materials**

▶ See *Surface Materials Reference Manual* for further information.

**Upholstery**

- Fabric\*
- Fabric with soil-retardant treatment (option)
- 3D Microknit (back and headrest only)
- Elmosoft leather
- Select Surfaces leather
- Leather
- Vinyl
- Customer's Own Leather (COL)
- Customer's Own Material (COM)

**Air Back**

- 6205 Black
- 6053 Seagull
- 6249 Platinum Solid
- 6BD6 Lagoon
- 6BD7 Saffron

**Hard components**

Back frame, seat shell, arm retainer, stool ring, headrest, and hanger

- 6053 Seagull
- 6205 Black\*

**Base**

- 6205 Black\*
- 7243 Seagull
- 8046 Polished Aluminum

**Pneumatic cylinders**

- 6205 Black\*

Flexors and lumbar finishes are determined by the 3D Microknit color unless specified as contrasting.

Seat shell is determined by the frame finish.

- 6053 Seagull
- 6205 Black\*

**Arms**

- 6059 Sterling Dark (on seagull chair)
- 6205 Black (on black chair)\*

**All Steelcase seating with standard upholstery fabrics**

complies with requirements of the State of California Technical Bulletin 117-2013. All standard seating is labeled to be in compliance with California 117-2013.

**Programs & Services**

▶ See *Surface Materials Reference Manual* for further detail about programs and services offered for seating.

**The Customer's Own Material (COM) Program**

offers the opportunity for customers to select fabrics that are not offered through the standard Steelcase surface materials program for use on Steelcase products. Through the COM program, Steelcase will test your materials for application on Steelcase products. Once approved, you can place your order. Steelcase will facilitate the entire ordering process and give you a production schedule. Steelcase will order the COM fabric directly from the textile manufacturer. For up-to-date information regarding fabric test results for all COM fabrics and details regarding yardage requirements for most seating lines, visit the COM website. To locate the COM website:

- Visit [www.steelcase.com](http://www.steelcase.com)

**Soil retardants** are treatments that provide long-term soil and stain resistance to a fabric without affecting the shade or the integrity of the fabric. The following Steelcase Textiles are available pre-treated with soil retardant. (You do not need to select the soil-retardant option for these fabrics and incur the upcharge.)

- Jacks
- Link

For information on soil retardant fabrics on Select Surfaces, please refer to the *Surface Materials Reference Manual*.

Soil-retardant treatment is available on all other seating fabrics at an additional upcharge per seating unit. To order this option, please select "Soil-Retardant Treatment" under "Optional Accessories."

For soil-retardant treatment on COMs, please select "Soil-Retardant Treatment" under "Optional Accessories." Minimums or additional yardage may be required. Please contact the vendor directly for specific information.

Extended lead times may be necessary for this service.

Contact your Steelcase Solutions Fulfillment Team Representative at 1.888.STEELCASE (1.888.783.3522) or send an email to [line-one@steelcase.com](mailto:line-one@steelcase.com).

**Dimensions**

▶ Page 186



# Steelcase Series 1 Upholstery

## What Is It?

### 3D Microknit Back

Back

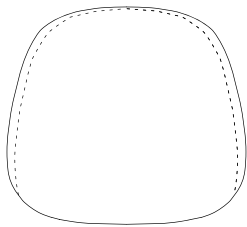
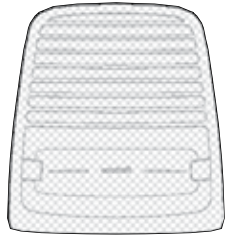

Seat

Fabric, leather, or vinyl-covered seat; 3D Microknit back only

**A Cogent:** Connect fabric can be specified on the seat to color match the 3D Microknit, except seagull.

*Tip: 3D Microknit back has no stitched seams. Upholstery seams on seat are driven by specified seat fabric.*

**Stitched seams** are included on the seat cushion of the following:

- Leather
- Vinyl
- Upholstery
- Select Customer's Own Material/ Vinyl (COM)

*Tip: There are no stitching seams in Cogent:Connect.*

### Air Back

Back

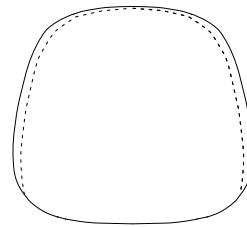
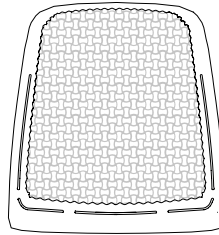

Seat

Fabric, leather, or vinyl-covered seat.

**A Cogent:** Connect fabric can be specified on the seat to color match the Air Back colors, except seagull and platinum solid. Cogent: Connect in nickel coordinates with platinum solid.

*Tip: Upholstery seams on seat are driven by specified seat fabric.*

**Stitched seams** are included on the seat cushion of the following:

- Leather
- Vinyl
- Upholstery
- Select Customer's Own Material/ Vinyl (COM)

*Tip: There are no stitching seams in Cogent:Connect.*

**What Is It?**

**Series 1 3D Microknit Back (with lumbar and back flexors)**

**Series 1 Air Back**

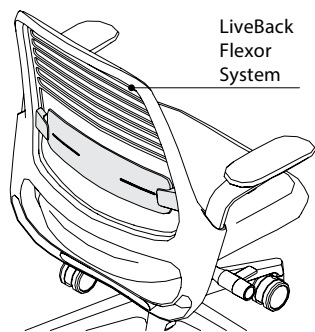
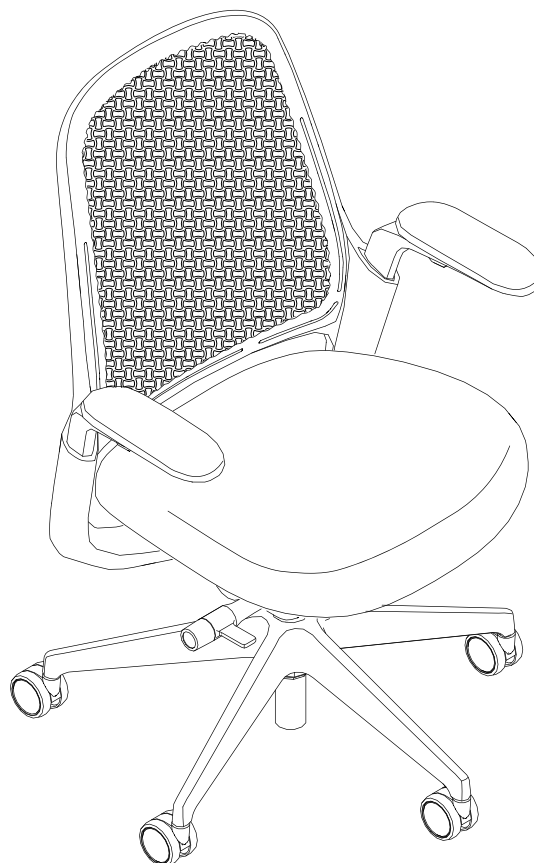

LiveBack  
Flexor  
System

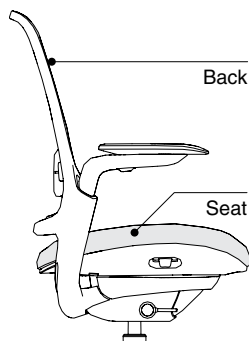

Back

Seat

**Back flexors** are fully exposed. Lumbar and flexor colors always match. Lumbar and flexors will also match the 3D Microknit fabric unless contrasting outer back is selected.

**Exception:** Eight 3D microknit colors are only available with contrasting outer back (3D microknit is a different color than the lumbar and flexors): Seagull, Honey, Saffron, Merlot, Aubergine, Lagoon, Peacock, and Jungle.

**Seat and back assemblies** can be removed and replaced if damaged.

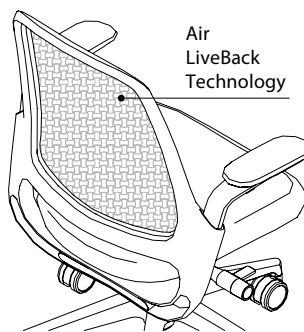

Air  
LiveBack  
Technology

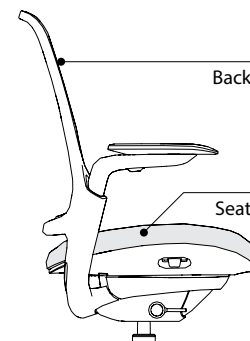

Back

Seat

**Seat and back assemblies** can be removed and replaced if damaged.

# Dimensions

## Steelcase Series 1

Features	Overall Depth	Width	Height	Seat Depth	Functional Seat Depth	Seat Width	Seat Height from Floor	Ring Height from Floor	Back Width	Back Height from Seat	Lumbar Height from Seat
----------	---------------	-------	--------	------------	-----------------------	------------	------------------------	------------------------	------------	-----------------------	-------------------------

**Steelcase Series 1**

Chair											
Arms	21" to 23 <sup>3</sup> / <sub>4</sub> "	23 <sup>1</sup> / <sub>2</sub> " to 27"	36 <sup>1</sup> / <sub>2</sub> " to 41 <sup>1</sup> / <sub>4</sub> "	18 <sup>1</sup> / <sub>2</sub> "	15 <sup>1</sup> / <sub>2</sub> " to 17 <sup>3</sup> / <sub>4</sub> "	19 <sup>1</sup> / <sub>2</sub> "	16 <sup>1</sup> / <sub>2</sub> " to 21 <sup>1</sup> / <sub>2</sub> " (14 <sup>3</sup> / <sub>4</sub> " to 17 <sup>3</sup> / <sub>4</sub> ", 17 <sup>1</sup> / <sub>4</sub> " to 22" optional)	N.A.	17 <sup>1</sup> / <sub>4</sub> "	21 <sup>1</sup> / <sub>2</sub> "	6 <sup>1</sup> / <sub>2</sub> " to 8 <sup>3</sup> / <sub>4</sub> "

Stool											
Arms	21" to 23 <sup>3</sup> / <sub>4</sub> "	23 <sup>1</sup> / <sub>2</sub> " to 27"	42 <sup>1</sup> / <sub>4</sub> " to 50"	18 <sup>1</sup> / <sub>2</sub> "	15 <sup>1</sup> / <sub>2</sub> " to 17 <sup>3</sup> / <sub>4</sub> "	19 <sup>1</sup> / <sub>2</sub> "	23" to 30 <sup>3</sup> / <sub>4</sub> "	11 <sup>1</sup> / <sub>2</sub> " to 15"	17 <sup>1</sup> / <sub>4</sub> "	21 <sup>1</sup> / <sub>2</sub> "	6 <sup>1</sup> / <sub>2</sub> " to 8 <sup>3</sup> / <sub>4</sub> "

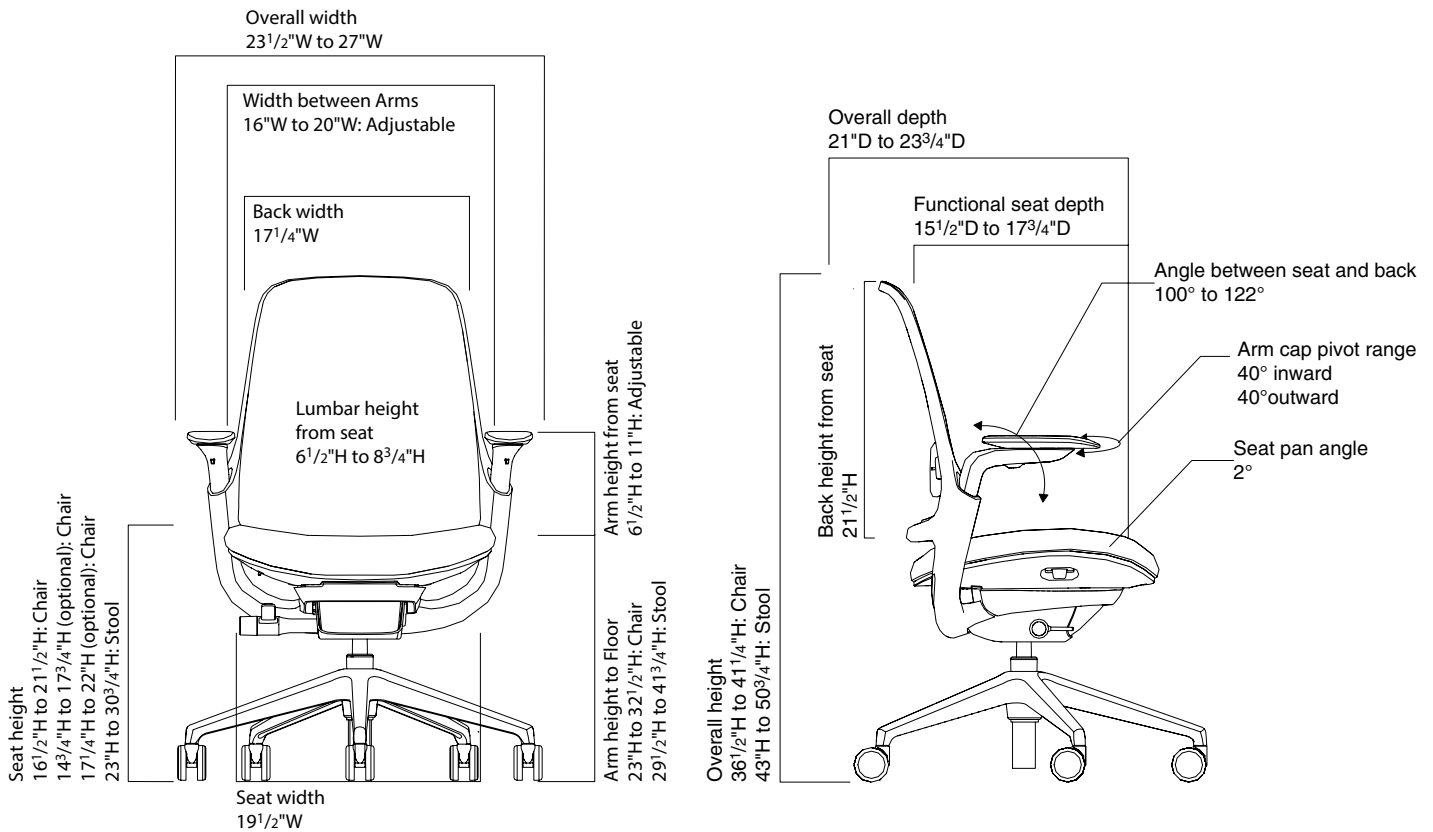



• Width • Between • Adjustable • Arms	• Width • Between • Height- • Adjustable • Arms	• Arm • to • Floor	• Arm • Height • from • Seat	• Arm Cap • Pivot • Range	• Angle • Between • Seat and • Back	• Seat • Pan • Angle	• Headrest • Height • Adjustment • Range
--	---	--------------------------	---------------------------------------	---------------------------------	--	----------------------------	---

16" to 20½"	19"	23" to 32½"	6½" to 11"	40° outward 40° inward	100° to 122°	2°	3¼"
-------------	-----	-------------	------------	---------------------------	--------------	----	-----

16" to 20½"	19"	29½" to 41¾"	6½" to 11"	40° outward 40° inward	100° to 122°	2°	3¼"
-------------	-----	--------------	------------	---------------------------	--------------	----	-----

# Steelcase Series 1 Work Chair

## 3D Microknit Back with Standard Upholstery on Seat



Standard Includes		Required to Specify
<ul style="list-style-type: none"> <li>▶ Need help? Product details, page 180</li> </ul>	<ul style="list-style-type: none"> <li>• 5" pneumatic seat-height adjustment (16½"–21½")</li> <li>• Frame: plastic</li> <li>• Base: paint or plastic</li> <li>• 2¼" seat depth adjustment</li> <li>• Pill height-, width-, pivot-, and depth-adjustable arms</li> <li>• Adjustable lumbar</li> <li>• Back: 3D Microknit on back</li> <li>• Standard upholstery design on seat: fabric price group 1</li> <li>• 2½"-diameter, hard-composition, dual-wheel casters: black only</li> </ul>	<ol style="list-style-type: none"> <li>1 Style number</li> <li>2 Frame (see below under Required Selections)</li> <li>3 3D Microknit color number for back</li> <li>4 Plastic color number for outer back, if contrasting outer back is selected</li> <li>5 Fabric color number for upholstery on seat</li> <li>6 Plastic color number for base:             <ul style="list-style-type: none"> <li>6205 Black (black and seagull frame)</li> <li>7243 Seagull (seagull frame only)</li> </ul> </li> <li>7 Options, if selected (see below)</li> </ol> <ul style="list-style-type: none"> <li>▶ See <i>Surface Materials</i>, page 634.</li> </ul>

	Required Selections	U.S. Price	Required to Specify
<b>Frame</b>	<ul style="list-style-type: none"> <li>• Black color scheme</li> <li>• Seagull color scheme</li> </ul>	No cost +\$ 46	Specify with 6205 Black. Specify with 6053 Seagull.

	Options	U.S. Price	Required to Specify
<b>Surface Materials</b>	<b>Upholstery on seat</b>		
	• Fabric price group 1	No cost	Specify fabric color number.
	• Fabric price group 2	+\$ 12	Specify fabric color number.
	• Fabric price group 3	+\$ 35	Specify fabric color number.
	• Fabric price group 4	+\$ 48	Specify fabric color number.
	• Fabric price group 5	+\$ 61	Specify fabric color number.
	• Fabric price group 6	+\$ 76	Specify fabric color number.
	• Fabric price group 7	+\$ 84	Specify fabric color number.
	• Fabric price group 8	+\$111	Specify fabric color number.
	• Fabric price group 9	+\$136	Specify fabric color number.
• Fabric price group 10	+\$154	Specify fabric color number.	
• Steelcase leather upholstery	+\$238	Specify leather color number.	
• Select Surfaces leather price group 1	+\$238	▶ See <i>Surface Materials Reference Manual</i> . Specify Elmosoft leather color number.	
• Elmosoft leather upholstery	+\$279	▶ See <i>Surface Materials Reference Manual</i> .	
• Select Surfaces leather price group 2	+\$279	▶ See <i>Surface Materials Reference Manual</i> .	
• Customer's Own Material (COM)	No cost	▶ See <i>Surface Materials Reference Manual</i> .	
	<b>Soil-retardant treatment</b>	+\$ 36	Specify with soil-retardant treatment.
	<b>Back color scheme</b>		
	• Contrasting outer back	+\$ 16	Specify with contrasting outer back and select plastic color number.
<b>Arms</b>	• Height-only adjustable	–\$ 12	Specify with height-only adjustable.
	• Armless	–\$ 87	Specify without arms.
<b>Base</b>	• Black	No cost	Specify with black base.
	• Polished aluminum base	+\$182	Specify with aluminum base.
<b>Headrest</b>	• Headrest	+\$160	Specify with headrest.
<b>Coat Hanger</b>	• Coat hanger	+\$ 45	Specify with coat hanger.
<b>Lumbar</b>	• Adjustable lumbar	No cost	Specify with adjustable lumbar.
	• Fixed lumbar	No cost	Specify with fixed lumbar.
<b>Seat Height</b>	• 3¼" short-range pneumatic seat-height adjustment	+\$ 82	Specify with short-range pneumatic seat-height adjustment.
	• 4¾" tall-range pneumatic seat-height adjustment	+\$ 82	Specify with tall-range pneumatic seat-height adjustment.
<b>Casters</b>	• Soft, dual-wheel roll-control casters for use on hard floors	+\$ 36	Specify with soft roll-control casters.
<b>Glides</b>	• Plastic glides	+\$ 36	Specify with glides.
<b>CarbonNeutral Product</b>	• CarbonNeutral product certification	+\$ 35	Add suffix <b>CN</b> to the end of the style number.

Tip: When ordering seagull frame the arms are 6059 Sterling Dark Solid. When ordering black frame, arms are black.

Tip: 3D Microknit, lumbar, and back flexors colors match unless contrasting outer back is selected.

Tip: Eight additional 3D Microknit colors are available when contrasting outer back is selected.

Tip: Base finish matches frame finish, unless seagull frame is selected, then black base is also available.

Tip: Order black base on seagull frame for lowest maintenance.

Tip: A headrest and a coat hanger cannot be attached on a Steelcase Series 1 chair simultaneously.

▶ Detailed dimensions, page 94

Specification Information

• Style • Number	• U.S. • Base • Price
435A00	\$987



  
**For Canadian Pricing**  
Multiply U.S. Price by the  
Canadian price factor.  
▶ See page 1 for details.

# Steelcase Series 1 Work Chair

Air Back with Standard Upholstery on Seat



Standard Includes	Required to Specify
-------------------	---------------------

<ul style="list-style-type: none"> <li>▶ Need help? Product details, page 180</li> </ul>	<ul style="list-style-type: none"> <li>• 5" pneumatic seat-height adjustment (16½"-21½")</li> <li>• Frame: plastic</li> <li>• Base: plastic</li> <li>• 2¼" seat depth adjustment</li> <li>• Pill height-, width-, pivot-, and depth-adjustable arms</li> <li>• Back: air back with integrated Air LiveBack technology: plastic groups 1 and 2</li> <li>• Standard upholstery design on seat: fabric price group 1</li> <li>• 2½"-diameter, hard-composition, dual-wheel casters: black only</li> </ul>	<ol style="list-style-type: none"> <li>1 Style number</li> <li>2 Frame (see below under Required Selections)</li> <li>3 Plastic color number for air back</li> <li>4 Fabric color number for upholstery on seat</li> <li>5 Plastic color number for base:                             <ul style="list-style-type: none"> <li>7243 Seagull (seagull frame only)</li> <li>6205 Black (black and seagull frame)</li> </ul> </li> <li>7 Options, if selected (see below)</li> </ol> <p>▶ See <i>Surface Materials</i>, page 634.</p>
--	--	--

Required Selections	U.S. Price	Required to Specify
---------------------	------------	---------------------

<b>Frame</b>	<ul style="list-style-type: none"> <li>• Black color scheme</li> <li>• Seagull color scheme</li> </ul>	<p>No cost</p> <p>+\$ 46</p> <p>Specify with 6205 Black.</p> <p>Specify with 6053 Seagull.</p>
--------------	--	--

Options	U.S. Price	Required to Specify
---------	------------	---------------------

<b>Surface Materials</b>	<b>Upholstery on seat</b>	No cost	Specify fabric color number.
	• Fabric price group 1	+\$ 12	Specify fabric color number.
	• Fabric price group 2	+\$ 35	Specify fabric color number.
	• Fabric price group 3	+\$ 48	Specify fabric color number.
	• Fabric price group 4	+\$ 61	Specify fabric color number.
	• Fabric price group 5	+\$ 76	Specify fabric color number.
	• Fabric price group 6	+\$ 84	Specify fabric color number.
	• Fabric price group 7	+\$111	Specify fabric color number.
	• Fabric price group 8	+\$136	Specify fabric color number.
	• Fabric price group 9	+\$154	Specify fabric color number.
	• Fabric price group 10	+\$238	Specify fabric color number.
	• Steelcase leather upholstery	+\$238	Specify leather color number.
	• Select Surfaces leather price group 1	+\$279	Specify leather color number.
	• Elmosoft leather upholstery	+\$279	Specify leather color number.
	• Select Surfaces leather price group 2	No cost	Specify leather color number.
	• Customer's Own Material (COM)	No cost	Specify fabric color number.
	<b>Plastic Air Back</b>		
	• Black	No cost	Specify plastic color 6205 Black.
	• Platinum Solid	No cost	Specify plastic color 6249 Platinum Solid.
	• Seagull	No cost	Specify plastic color 6053 Seagull.
	• Lagoon	No cost	Specify plastic color 6BD6 Lagoon.
	• Saffron	No cost	Specify plastic color 6BD7 Saffron.
	<b>Soil-retardant treatment</b>	+\$ 36	Specify with soil-retardant treatment.
<b>Arms</b>	<ul style="list-style-type: none"> <li>• Height-only adjustable</li> <li>• Armless</li> </ul>	<p>-\$ 12</p> <p>-\$ 87</p>	<p>Specify with height-only adjustable arms.</p> <p>Specify without arms.</p>
<b>Base</b>	<ul style="list-style-type: none"> <li>• Plastic base</li> <li>• Polished aluminum base</li> </ul>	<p>No cost</p> <p>+\$182</p>	<p>Specify plastic color number.</p> <p>Specify with aluminum base.</p>
<b>Headrest</b>	<ul style="list-style-type: none"> <li>• Headrest</li> </ul>	+\$160	Specify with headrest.
<b>Coat Hanger</b>	<ul style="list-style-type: none"> <li>• Coat hanger</li> </ul>	+\$ 45	Specify with coat hanger.
<b>Seat Height</b>	<ul style="list-style-type: none"> <li>• 3¼" low-range pneumatic seat height adjustment</li> <li>• 4¾" high-range pneumatic seat height adjustment</li> </ul>	<p>-\$ 82</p> <p>-\$ 82</p>	<p>Specify with short-range pneumatic seat height adjustment.</p> <p>Specify with tall-range pneumatic seat height adjustment.</p>
<b>Casters</b>	<ul style="list-style-type: none"> <li>• Soft, dual-wheel roll-control casters for use on hard floors</li> </ul>	+\$ 36	Specify with soft roll-control casters.
<b>Glides</b>	<ul style="list-style-type: none"> <li>• Plastic glides</li> </ul>	+\$ 36	Specify with glides.
<b>CarbonNeutral Product</b>	<ul style="list-style-type: none"> <li>• CarbonNeutral product certification</li> </ul>	+\$ 35	Add suffix <b>CN</b> to the end of the style number.

Tip: When ordering seagull frame the arms are 6059 Sterling Dark Solid. When ordering black frame, arms are black.

Tip: Base finish matches frame finish, unless seagull frame is selected, then black base is also available.

Tip: Order black base on seagull frame for lowest maintenance.



**For Canadian Pricing**

Multiply U.S. Price by the Canadian price factor.

▶ See page 1 for details.

Specification Information

• Style            • U.S. Base  
• Number        • Price

435A00AIR     \$903



Steelcase Series 1



**For Canadian Pricing**

Multiply U.S. Price by the Canadian price factor.

▶ See page 1 for details.

# Steelcase Series 1 Stool

3D Microknit with Standard Upholstery on Seat



Standard Includes		Required to Specify
<ul style="list-style-type: none"> <li>▶ Need help? Product details, page 180</li> </ul>	<ul style="list-style-type: none"> <li>• 7¾" pneumatic seat-height adjustment (23"-30¾")</li> <li>• Frame: plastic</li> <li>• Base: plastic</li> <li>• 2¼" seat depth adjustment</li> <li>• Pill height-, width-, pivot-, and depth-adjustable arms</li> <li>• Column and adjustable foot ring: black</li> <li>• Adjustable lumbar</li> <li>• Back: 3D Microknit</li> <li>• Standard upholstery design on seat: fabric price group 1</li> <li>• 2½"-diameter, hard-composition, dual-wheel casters: black only</li> </ul>	<ol style="list-style-type: none"> <li>1 Style number</li> <li>2 Frame (see below under Required Selections)</li> <li>3 3D Microknit color number for back</li> <li>4 Plastic color number for outer back, if contrasting outer back is selected</li> <li>5 Fabric color number for upholstery on seat</li> <li>6 Plastic color number for base: 6053 Seagull (seagull frame only) 6205 Black (black and seagull frame)</li> <li>7 Options, if selected (see below)</li> </ol> <ul style="list-style-type: none"> <li>▶ See <i>Surface Materials</i>, page 634.</li> </ul>

Required Selections	U.S. Price	Required to Specify
<b>Frame</b>		
<ul style="list-style-type: none"> <li>• Black color scheme</li> <li>• Seagull color scheme</li> </ul>	<p>No cost +\$ 46</p>	<p>Specify with 6205 Black. Specify with 6053 Seagull.</p>

Options	U.S. Price	Required to Specify
<b>Surface Materials</b>		
<b>Upholstery on seat</b>		
<ul style="list-style-type: none"> <li>• Fabric price group 1</li> <li>• Fabric price group 2</li> <li>• Fabric price group 3</li> <li>• Fabric price group 4</li> <li>• Fabric price group 5</li> <li>• Fabric price group 6</li> <li>• Fabric price group 7</li> <li>• Fabric price group 8</li> <li>• Fabric price group 9</li> <li>• Fabric price group 10</li> <li>• Steelcase leather upholstery</li> <li>• Select Surfaces leather price group 1</li> <li>• Elmosoft leather upholstery</li> <li>• Select Surfaces leather price group 2</li> <li>• Customer's Own Material (COM)</li> </ul>	<p>No cost +\$ 12 +\$ 35 +\$ 48 +\$ 61 +\$ 76 +\$ 84 +\$ 111 +\$136 +\$154 +\$238 +\$238 +\$279 +\$279 No cost</p>	<p>Specify fabric color number. Specify fabric color number. Specify fabric color number. Specify fabric color number. Specify fabric color number. Specify fabric color number. Specify fabric color number. Specify fabric color number. Specify fabric color number. Specify fabric color number. Specify fabric color number. Specify leather color number. ▶ See <i>Surface Materials Reference Manual</i>. Specify Elmosoft leather color number. ▶ See <i>Surface Materials Reference Manual</i>. ▶ See <i>Surface Materials Reference Manual</i>.</p>
<b>Soil-retardant treatment</b>	+\$ 36	Specify with soil-retardant treatment.
<b>Back color scheme</b>		
<ul style="list-style-type: none"> <li>• Contrasting outer back</li> </ul>	+\$ 16	Specify with contrasting outer back and select plastic color number.

<b>Arms</b>	<ul style="list-style-type: none"> <li>• Height-only adjustable</li> <li>• Armless</li> </ul>	<p>-\$ 12 -\$ 87</p>	<p>Specify with height-only adjustable. Specify without arms.</p>
<b>Base</b>	<ul style="list-style-type: none"> <li>• Plastic base</li> <li>• Polished aluminum base</li> </ul>	<p>No cost +\$182</p>	<p>Specify plastic color number. Specify with aluminum base.</p>
<b>Headrest</b>	<ul style="list-style-type: none"> <li>• Headrest</li> </ul>	+\$160	Specify with headrest.
<b>Coat Hanger</b>	<ul style="list-style-type: none"> <li>• Coat hanger</li> </ul>	+\$ 45	Specify with coat hanger.
<b>Lumbar</b>	<ul style="list-style-type: none"> <li>• Adjustable lumbar</li> <li>• Fixed lumbar</li> </ul>	<p>No cost No cost</p>	<p>Specify with adjustable lumbar. Specify with fixed lumbar.</p>
<b>Casters</b>	<ul style="list-style-type: none"> <li>• Soft, dual-wheel roll-control casters for use on hard floors</li> </ul>	+\$ 36	Specify with soft roll-control casters.
<b>Glides</b>	<ul style="list-style-type: none"> <li>• Plastic glides</li> </ul>	+\$ 36	Specify with glides.
<b>CarbonNeutral Product</b>	<ul style="list-style-type: none"> <li>• CarbonNeutral product certification</li> </ul>	+\$ 35	Add suffix <b>CN</b> to the end of the style number.

Tip: When ordering seagull frame the arms are 6059 Sterling Dark Solid. When ordering black frame, arms are black.

Tip: 3D Microknit, lumbar, and back flexors colors match unless contrasting outer back is selected.

Tip: Eight additional 3D Microknit colors are available when contrasting outer back is selected.

Tip: Base finish matches frame finish, unless seagull frame is selected, then black base is also available.

Tip: Order black base on seagull frame for lowest maintenance.

Tip: Stool ring is always black for lower cleaning maintenance, even on the seagull frame.

Tip: A headrest and a coat hanger cannot be attached on a Steelcase Series 1 chair simultaneously.

▶ Detailed dimensions, page 94

Specification Information

• Style • Number	• U.S. Base • Price
435B00	\$1239



  
**For Canadian Pricing**  
Multiply U.S. Price by the  
Canadian price factor.  
▶ See page 1 for details.

# Steelcase Series 1 Stool

Air Back with Standard Upholstery on Seat



Standard Includes		Required to Specify
<ul style="list-style-type: none"> <li>▶ Need help? Product details, page 180</li> </ul>	<ul style="list-style-type: none"> <li>• 7¾" pneumatic seat-height adjustment (23"-30¾")</li> <li>• Frame: plastic</li> <li>• Base: plastic</li> <li>• 2¼" seat depth adjustment</li> <li>• Pill height-, width-, pivot-, and depth-adjustable arms</li> <li>• Column and adjustable foot ring: black</li> <li>• Back: air back with integrated Air LiveBack technology: plastic groups 1 and 2</li> <li>• Standard upholstery design on seat: fabric price group 1</li> <li>• 2½"-diameter, hard-composition, dual-wheel casters: black only</li> </ul>	<ol style="list-style-type: none"> <li>1 Style number</li> <li>2 Frame (see below under Required Selections)</li> <li>3 Plastic color number for air back</li> <li>4 Fabric color number for upholstery on seat</li> <li>5 Plastic color number for base:                         <ul style="list-style-type: none"> <li>7243 Seagull (seagull frame only)</li> <li>6205 Black (black and seagull frame)</li> </ul> </li> <li>7 Options, if selected (see below)                         <ul style="list-style-type: none"> <li>▶ See <i>Surface Materials</i>, page 634.</li> </ul> </li> </ol>

Tip: When ordering seagull frame the arms are 6059 Sterling Dark Solid. When ordering black frame, arms are black.

Required Selections	U.S. Price	Required to Specify
<b>Frame</b>	<ul style="list-style-type: none"> <li>• Black color scheme</li> <li>• Seagull color scheme</li> </ul>	<ul style="list-style-type: none"> <li>No cost</li> <li>+\$ 46</li> </ul> <p>Specify with 6205 Black. Specify with 6053 Seagull.</p>

Options	U.S. Price	Required to Specify
<b>Surface Materials</b>	<b>Upholstery on seat</b>	
	<ul style="list-style-type: none"> <li>• Fabric price group 1</li> <li>• Fabric price group 2</li> <li>• Fabric price group 3</li> <li>• Fabric price group 4</li> <li>• Fabric price group 5</li> <li>• Fabric price group 6</li> <li>• Fabric price group 7</li> <li>• Fabric price group 8</li> <li>• Fabric price group 9</li> <li>• Fabric price group 10</li> <li>• Steelcase leather upholstery</li> <li>• Select Surfaces leather price group 1</li> <li>• Elmosoft leather upholstery</li> <li>• Select Surfaces leather price group 2</li> <li>• Customer's Own Material (COM)</li> </ul>	<ul style="list-style-type: none"> <li>No cost</li> <li>+\$ 12</li> <li>+\$ 35</li> <li>+\$ 48</li> <li>+\$ 61</li> <li>+\$ 76</li> <li>+\$ 84</li> <li>+\$111</li> <li>+\$136</li> <li>+\$154</li> <li>+\$238</li> <li>+\$238</li> <li>+\$279</li> <li>+\$279</li> <li>No cost</li> </ul> <p>Specify fabric color number. Specify fabric color number. Specify fabric color number. Specify fabric color number. Specify fabric color number. Specify fabric color number. Specify fabric color number. Specify fabric color number. Specify fabric color number. Specify fabric color number. Specify leather color number. Specify leather color number. Specify leather color number. Specify leather color number. Specify fabric color number.</p>
	<b>Air Back</b>	
	<ul style="list-style-type: none"> <li>• Black</li> <li>• Platinum Solid</li> <li>• Seagull</li> <li>• Lagoon</li> <li>• Saffron</li> </ul>	<ul style="list-style-type: none"> <li>No cost</li> <li>No cost</li> <li>No cost</li> <li>No cost</li> <li>No cost</li> </ul> <p>Specify plastic color 6205 Black. Specify plastic color 6249 Platinum Solid. Specify plastic color 6053 Seagull. Specify plastic color 6BD6 Lagoon. Specify plastic color 6BD7 Saffron.</p>
	<b>Soil-retardant treatment</b>	
	+\$ 36	Specify with soil-retardant treatment.
<b>Arms</b>	<ul style="list-style-type: none"> <li>• Height-only adjustable</li> <li>• Armless</li> </ul>	<ul style="list-style-type: none"> <li>-\$ 12</li> <li>-\$ 87</li> </ul> <p>Specify with height-only adjustable arms. Specify without arms.</p>
<b>Base</b>	<ul style="list-style-type: none"> <li>• Black</li> <li>• Polished aluminum base</li> </ul>	<ul style="list-style-type: none"> <li>No cost</li> <li>+\$182</li> </ul> <p>Specify with black base. Specify with aluminum base.</p>
<b>Headrest</b>	• Headrest	+\$160 Specify with headrest.
<b>Coat Hanger</b>	• Coat hanger	+\$ 45 Specify with coat hanger.
<b>Casters</b>	• Soft, dual-wheel roll-control casters for use on hard floors	+\$ 36 Specify with soft roll-control casters.
<b>Glides</b>	• Plastic glides	+\$ 36 Specify with glides.
<b>CarbonNeutral Product</b>	• CarbonNeutral product certification	+\$ 35 Add suffix <b>CN</b> to the end of the style number.

Tip: Stool ring is always black for lower cleaning maintenance, even on the seagull frame.

Tip: Base finish matches frame finish, unless seagull frame is selected, then black base is also available.

Tip: Order black base on seagull frame for lowest maintenance.



**For Canadian Pricing**  
Multiply U.S. Price by the Canadian price factor.  
▶ See page 1 for details.



**Specification Information**

• Style • Number	• U.S. Base • Price
<b>435B00AIR</b>	\$1154



  
**For Canadian Pricing**  
Multiply U.S. Price by the  
Canadian price factor.  
▶ See page 1 for details.

# Steelcase Series 1 Accessories

## Steelcase Series 1 Headrest

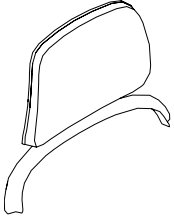

*Tip: A headrest and a coat hanger cannot be attached on a Steelcase Series 1 chair simultaneously.*

*Tip: Stand alone add on accessories are not available with CarbonNeutral product certification.*

Standard Includes	Required to Specify
-------------------	---------------------

- |  |  |  |
|--|--|--|
| <ul style="list-style-type: none"> <li>▶ Need help? Product details, page 180</li> </ul> | <ul style="list-style-type: none"> <li>• Headrest frame: plastic</li> <li>• Headrest: 3D Microknit</li> <li>• 3" adjustment range</li> </ul> | <ul style="list-style-type: none"> <li>1 Style number</li> <li>2 Plastic color number for frame:                             <ul style="list-style-type: none"> <li>6053 Seagull</li> <li>6205 Black</li> </ul> </li> <li>3 3D Microknit color number for headrest                             <ul style="list-style-type: none"> <li>▶ See <i>Surface Materials</i>, page 634.</li> </ul> </li> </ul> |
|--|--|--|

Specification Information	
Style Number	U.S. Price

435HEADREST	\$160
-------------	-------

## Steelcase Series 1 Coat Hanger

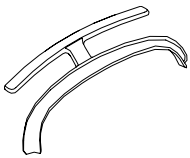

*Tip: A headrest and a coat hanger cannot be attached on a Steelcase Series 1 chair simultaneously.*

*Tip: Stand alone add on accessories are not available with CarbonNeutral product certification.*

Standard Includes	Required to Specify
-------------------	---------------------

- |  |   |
|--|---|
| <ul style="list-style-type: none"> <li>• Coat hanger: plastic</li> </ul> | <ul style="list-style-type: none"> <li>1 Style number</li> <li>2 Plastic color number for coat hanger:                             <ul style="list-style-type: none"> <li>6053 Seagull</li> <li>6205 Black</li> </ul> </li> </ul> |
|--|---|

Specification Information	
Style Number	U.S. Price

435COATHANGER	\$45
---------------	------



**For Canadian Pricing**  
 Multiply U.S. Price by the Canadian price factor.  
 ▶ See page 1 for details.