

HAWORTH

Haworth Health

North America Price List and Specification Guide – February 2024



Electronic Update Page – Haworth Health Price Book

- The table below lists all of the updates and addendums added to this price list since the original version was created.
- All **Update** pages will replace the existing pages within the document.
- All **New** pages will be placed at the back of the document.

Link	Date	Pages	Description
Click Here	July 2024	1A-4A	New – Ergotron - CareFit Combo and accessories Price List pages added.



This Haworth North American price book contains US list prices.
Canadian customers can convert the US list price into their Canadian equivalent by going to www.Haworth.com/Canada to find the current Canadian multipliers. These multiplier factors allow you to convert the US list price into a Canadian list price.

Price List Overview

The following overview explains how information is organized within the Haworth® Health price list.

- 1 Front Cover**
 - Includes the price book title and pricing effectivity date.
- 2 Canadian Conversion / Update Page**
 - Pricing conversion information for converting US pricing into the equivalent Canadian pricing is located on the footer of this page.
 - All Price Book updates will be listed on this page including the date, page number and description of the update.
- 3 Price List Table of Contents**
 - Price List table of contents with page numbers.
- 4 Statement of Line**
 - Provides a pictorial outline of the entire product offering.
- 5 Price List**

Each price list page contains the following:

 - Product Illustration
 - Catalog Number
 - To Order Specify – sequencing for ordering product options and finishes
 - List Prices
 - Product Specification Dimensions
 - Features
 - Specification Tips
 - Class, Discount Group Number (used for discounting) and GSA information
- 6 Finishes, Fabrics and COM**
 - Lists information for material finishes and availability.
 - Provides COM information and requirements (if applicable).
- 7 Index**
 - Products are listed alphabetically by alpha-numeric catalog numbers with price list page number.
- 8 Warranty Policy and Terms of Sale**
 - Provides information about the Haworth policy for non-obsolescence, warranty and Terms-of-Sale.

Additional Information and Resources

Prices are subject to change without notice or approval. Haworth dealers should always submit proposals through Lynx before presenting to customers. See North American Terms of Sale for more information.

Online Resources

haworth.com

- Haworth's corporate website provides access to price books and a variety of other resources and publications.

surfaces.haworth.com

- Website provides access to the most current fabrics and finishes offered across Haworth's various product lines.

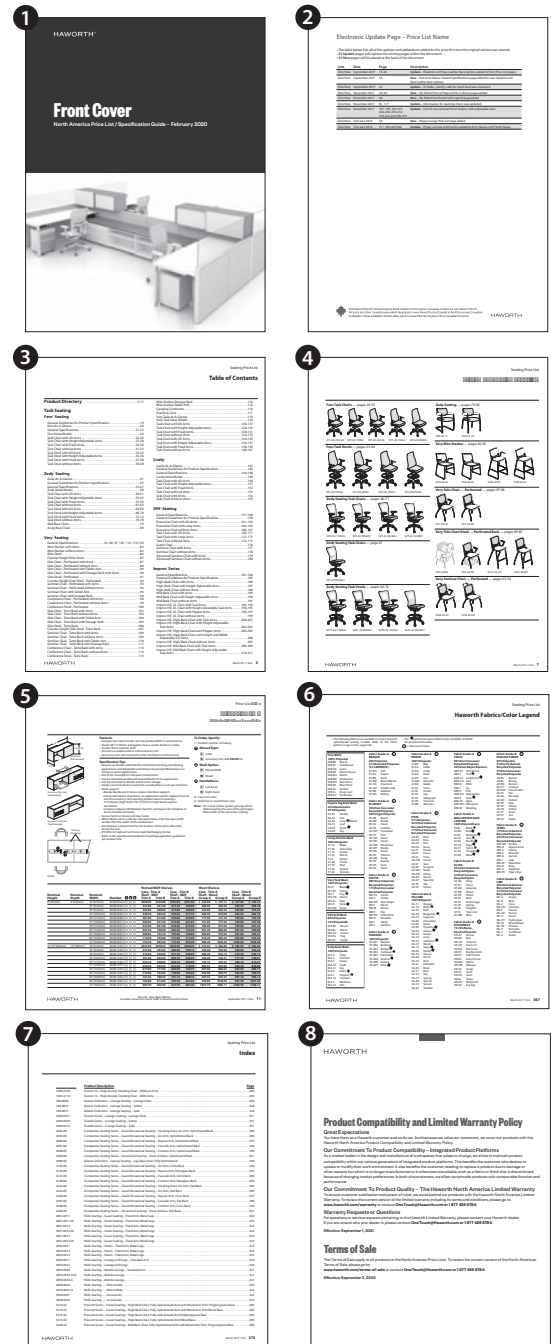

Table of Contents

Statement of Line 5

Mobile Carts

Slim Laptop Cart	11
T-Slot Scanner/Printer Holder for CareFit Slim	11
Slim 2.0 LCD Cart	12
Side-Mount Wipes Holder for CareFit Slim 2.0	13
Side-Mount Scanner Bracket for CareFit Slim 2.0	13
Side-Mount Scanner Holder for CareFit Slim 2.0	13
Side-Mount Printer Bracket for CareFit Slim 2.0	14
Mini CPU Holder for CareFit Slim 2.0	14
Front Shelf for CareFit Slim 2.0	14
Battery	15
Smart Battery Dock	15
4-Bay Charger	15
LCD Cart - LiFe Powered	16
Telepresence Cart - Powered - Single Monitor	17
Telepresence Cart - Powered Back-to-Back Monitor	18
Coiled Extension Cord	19
Power Strip	19
Vinyl Cord Cover	19
Power Strip Mounting Kit and Cord Wrap	19
StyleView Scanner Shelf	20
StyleView Wire Basket	20
SV Hook	20
T-Slot Wipes Holder	21
T-Nut Kit	21

Wall Mounted Workstations

Enclosure	22
Horizontal Scanner Bracket	23
Vertical Scanner Bracket	23
Laminate Kit	23
Sit-Stand Wall Mount System	24
Sit-Stand Wall Mount LCD Arm	25
Sit-Stand Wall Mount Keyboard Arm	25
Wall Mount Monitor Arm	26
Dual Monitor and Handle Kit	26
Sit-Stand Vertical Lift - High Traffic Area	27
Vertical Lift - High Traffic Area	27
Vertical Lift Auto-Retracting Keyboard Kit	27
Sit-Stand Combo System - with Worksurface and Panning Pivot	28
Sit-Stand Arm Extender	28
Wrist Rest - Antimicrobial	29
Scanner Shelf - VESA Attached	29
Scanner Holder - Wall Mount	29
Notebook Tray	29
Wall Plate	30
Steel Stud Wall Mounting Kit	30
Small CPU Holder	31
Universal CPU Holder	31
Mini PC Mount	31
Wall Track	32
Wall Track Mounting Kit	32
Track Mount Bracket Kit	32

Task Seating — Soji – Cleanable+

Soji-At-A-Glance	33
Task Chair with 4D Arms — Plastic Base	34
Task Chair with 4D Arms — Aluminum Base	35
Task Chair with Height Adjustable Arms — Plastic Base	36
Task Chair with Height Adjustable Arms — Aluminum Base	37
Task Chair with Fixed Arms — Plastic Base	38
Task Chair with Fixed Arms — Aluminum Base	39

Task Chair without Arms — Plastic Base	40
Task Chair without Arms — Aluminum Base	41
Task Stool with 4D Arms — Plastic Base	42
Task Stool with 4D Arms — Aluminum Base	43
Task Stool with Height Adjustable Arms — Plastic Base	44
Task Stool with Height Adjustable Arms — Aluminum Base	45
Task Stool with Fixed Arms — Plastic Base	46
Task Stool with Fixed Arms — Aluminum Base	47
Task Stool without Arms — Plastic Base	48
Task Stool without Arms — Aluminum Base	49

Task Seating — Zody LX – Cleanable+

Zody LX At-A-Glance	50-51
Zody LX General Specifications	52-54
Task Chair	55-56
Task Stool	57-58
Dual Posture	59-60

Exam Room Seating

Stools	61
Maari with Arms	62
Maari without Arms	63

Patient Room

Recliner Options At-A-Glance - Benson Collection	64
Three Position Wall-Saver Recliner	65
Three Position Glider Recliner	66
Bariatric Recliner - Standard Arms	67
Bariatric Recliner - Transfer Arms	68
Sleep Recliner - Standard Arms	69-70
Sleep Recliner - Transfer Arms	71
Pull-Out Sleeper Chair	72
Pull-Out Sleeper Sofa	73
Sleeper Flip Sofa	74
Overbed Tables — Options At-A-Glance	75
Single Top	76
Dual Top	76

Channel Accessories

Mounting Kit for Channel Cover Tile	77
Spacer Bracket	77
Channel Cover Tile	78
Frame Tube Cover	78
Bottom Tile Cover	78
Variable Height Cover — 3" Wide Aluminum	79
Variable Height Cover — 12" Wide ChemSurf	79
Inside End Cover	79
Reagent Shelf, Inboard Mount	80
Reagent Shelf, Outboard Mount	80

Individual Tiles

Steel Tile	81
ChemSurf Tile	82-83

Spanning In-line — Individual Tiles

Spanning Steel Tile	84-85
Spanning ChemSurf Tile	86-87

Finishes and Fabrics 88-89

Index 90-92

Lifetime Product Warranty Inside Back Cover

Statement of Line

Mobile Carts — pages 11-21

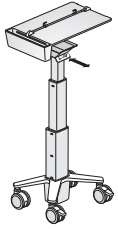

C50-1100-0
Slim Laptop Cart

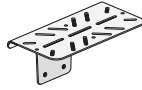

98-465
T-Slot Scanner/Printer Holder for CareFit Slim

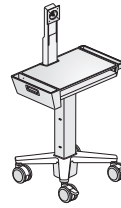

C50-3500-0
Slim 2.0 LCD Cart

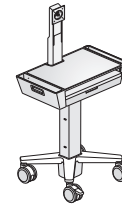

C50-3510-0
Slim 2.0 LCD Cart

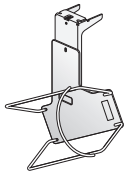

98-451
Side-Mount Wipes Holder for CareFit Slim 2.0



98-466
Side-Mount Scanner Bracket for CareFit Slim 2.0



98-467
Side-Mount Scanner Holder for CareFit Slim 2.0



98-468
Side-Mount Printer Bracket for CareFit Slim 2.0

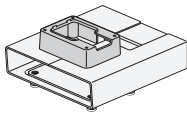

98-470
Mini CPU Holder for CareFit Slim 2.0

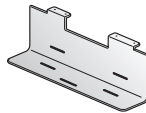

98-476
Front Shelf for CareFit Slim 2.0



98-246
Battery

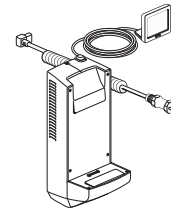

98-247
Smart Battery Dock

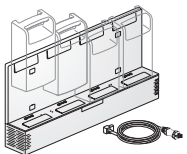

98-258
4-Bay Charger

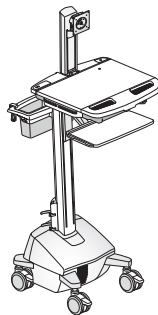
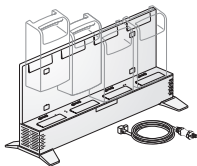

SV42-6302-1
LCD Cart - LiFe Powered

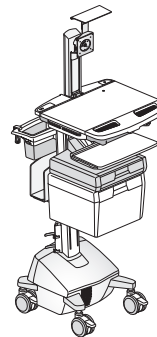

SV44-53E1-1
Telepresence Cart - Powered - Single Monitor

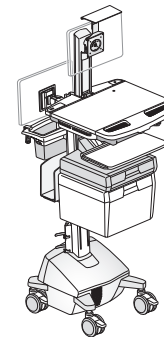

SV44-57E1-1
Telepresence Cart - Powered Back-to-Back Monitor

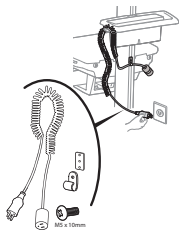

97-464
Coiled Extension Cord

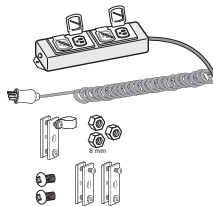

97-466-214
Power Strip



98-453
Vinyl Cord Cover

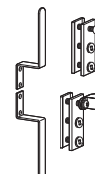

60-590
Power Strip Mounting Kit and Cord Wrap

Statement of Line

Mobile Carts, (cont'd) — pages 11-21



97-780-194
StyleView Scanner Shelf



98-135-216
StyleView Wire Basket



97-999
SV Hook



98-450
T-Slot Wipes Holder

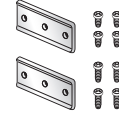

97-631
T-Nut Kit

Wall Mounted Workstations — pages 22-32

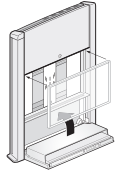

61-367
Enclosure

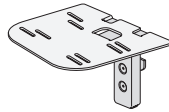

98-424
Horizontal Scanner Bracket

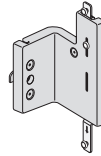

98-425
Vertical Scanner Bracket

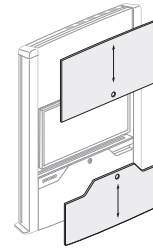

98-419
Laminate Kit

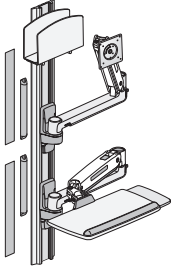

45-359-026
45-358-026
Sit-Stand Wall Mount System

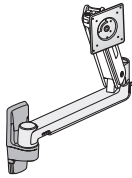

45-353-026
45-383-026
Sit-Stand Wall Mount LCD Arm

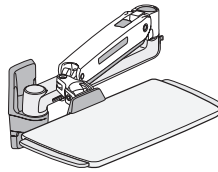

45-354-026
Sit-Stand Wall Mount Keyboard Arm

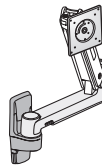

45-243
Wall Mount Monitor Arm

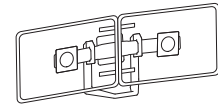

97-783
Dual Monitor and Handle Kit

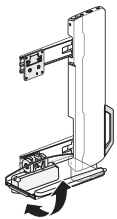

61-081
Sit-Stand Vertical Lift - High Traffic Area

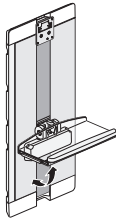

60-593
Vertical Lift - High Traffic Area

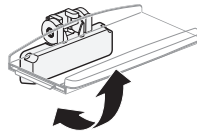

97-487-800
Vertical Lift Auto-Retracting Keyboard Kit

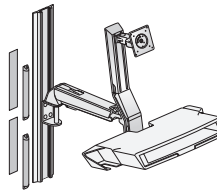

45-583
Sit-Stand Combo System - with Worksurface and Panning Pivot

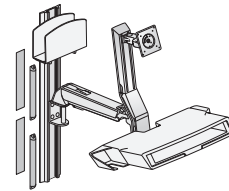

45-594
Sit-Stand Combo System - with Worksurface and Panning Pivot

Statement of Line

Wall Mounted Workstations , (cont'd) — pages 22-32

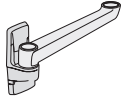

45-261
Sit-Stand Arm Extender

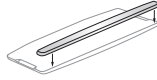

97-533
Wrist Rest - Antimicrobial

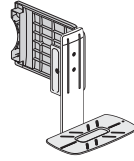

97-815
Scanner Shelf - VESA Attached

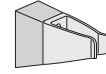

97-566
Scanner Holder - Wall Mount



50-193-200
Notebook Tray



97-101-003
Wall Plate



60-591-003
Steel Stud Wall Mounting Kit

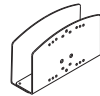

80-063
Small CPU Holder

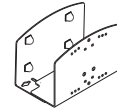

97-468
Universal CPU Holder

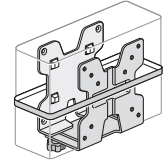

80-107
Mini PC Mount



31-018-182
Wall Track



(10) Toggle Anchors



(6) Wood Stud Screws



(10) Screws 1/4-20 x 2"



(6) Steel Stud Screws



97-091
Track Mount Bracket Kit

Task Seating — Soji - Cleanable+ — pages 33-49



SJT-3C-711A
Task Chair with 4D Arms — Plastic Base



SJT-3C-711A
Task Chair with 4D Arms — Aluminum Base



SJT-3C-401X
Task Chair with Height Adjustable Arms — Plastic Base



SJT-3C-411X
Task Chair with Height Adjustable Arms — Aluminum Base



SJT-3C-111A
Task Chair with Fixed Arms — Plastic Base



SJT-3C-111A
Task Chair with Fixed Arms — Aluminum Base



SJT-3C-011A
Task Chair without Arms — Plastic Base



SJT-3C-011A
Task Chair without Arms — Aluminum Base

Statement of Line

Task Seating — Soji — Cleanable+, (cont'd) — pages 33-49



SJTC-701X
SJTC-701A
**Task Stool with 4D Arms —
Plastic Base**



SJTC-701X
SJTC-701A
**Task Stool with 4D Arms —
Aluminum Base**



SJTC-401X
SJTC-401A
**Task Stool with Height
Adjustable Arms — Plastic Base**



SJTC-401X
SJTC-401A
**Task Stool with Height
Adjustable Arms — Aluminum Base**



SJTC-101X
SJTC-101A
**Task Stool with Fixed Arms —
Plastic Base**



SJTC-101X
SJTC-101A
**Task Stool with Fixed Arms —
Aluminum Base**



SJTC-001X
SJTC-001A
**Task Stool without Arms —
Plastic Base**



SJTC-001X
SJTC-001A
**Task Stool without Arms —
Aluminum Base**

Task Seating — Zody LX — Cleanable+ — pages 50-60



S2UC-33-0
Task Chair



S2UC-33-1
Task Chair



S2UC-33-4
Task Chair



S2UC-33-7
Task Chair



S2US-33-0
Task Stool



S2US-33-1
Task Stool



S2US-33-4
Task Stool



S2US-33-7
Task Stool



S2UD-33-1
Dual Posture



S2UD-33-4
Dual Posture



S2UD-33-7
Dual Posture

Statement of Line

Exam Room Seating — pages 61-63



HE105-N
Stools

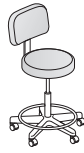

HE106-R
Stools



S75-44-11
Maari with Arms



S75-24-11
Maari with Arms



S75-22-11
Maari with Arms



S75-44-01
Maari without Arms



S75-24-01
Maari without Arms



S75-22-01
Maari without Arms

Patient Room — Benson Collection — pages 64-76



BNWR
Three Position Wall-Saver
Recliner

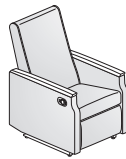

BNGR
Three Position Glider
Recliner

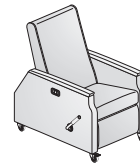

BNBR-22-S
Bariatric Recliner -
Standard Arms

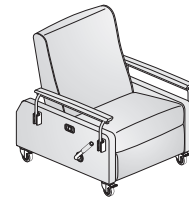

BNBR-22-T
Bariatric Recliner -
Transfer Arms



BNSR-22-S
Sleep Recliner -
Standard Arms



BNSR-22-T
Sleep Recliner -
Transfer Arms

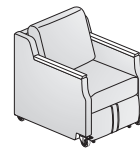

BNSC
Pull-Out Sleeper
Chair

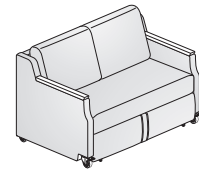

BNSS
Pull-Out Sleeper
Sofa

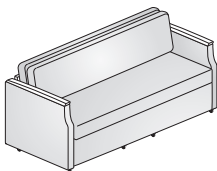

BNSF
Sleeper Flip Sofa



HE810-R-LNNN
Single Top Overbed
Table



HE820-R-LL
Dual Top Overbed
Table

Statement of Line

Channel Accessories — For use with Compose — pages 77-80

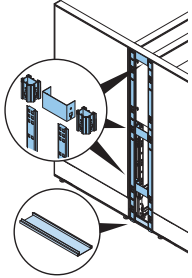

VZCH
Mounting Kit for Channel
Cover Tile

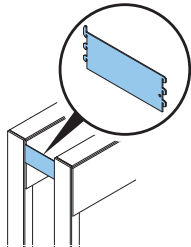

VZCS-0012-U
Spacer Bracket

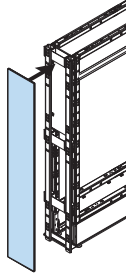

VZTI-PNN
Channel Cover Tile

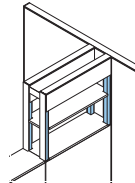

VZCU-P
Frame Tube Cover

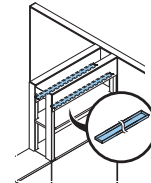

VZCB-P
Bottom Tile Cover

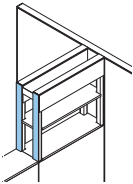

VZVZ-P
Variable Height Cover —
3" Wide Aluminum

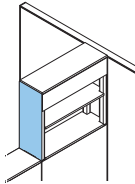

TS00-4TRY
Variable Height Cover —
12" Wide ChemSurf

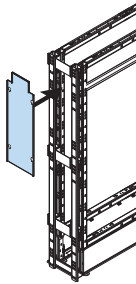

VZCF-P
Inside End Cover

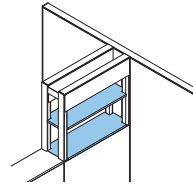

UZSR-CMIL
UZSR-CMIU
Reagent Shelf, Inboard
Mount

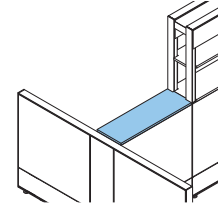

UZSR-CMO
Reagent Shelf, Outboard
Mount

Individual Tiles — For use with Compose — pages 81-84



VZTI-PNN
Steel Tile

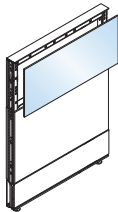

VZTI-DNN (No Port)
ChemSurf Tile

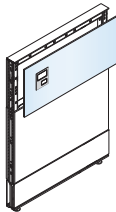

VZTI-DLN (One Port - Left)
ChemSurf Tile

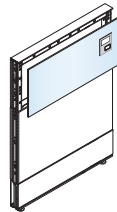

VZTI-DRN (One Port - Right)
ChemSurf Tile

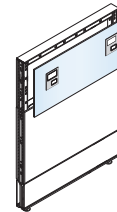

VZTI-D2N (Two Ports - Double)
ChemSurf Tile

Spanning In-line — Individual Tiles — For use with Compose — pages 84-87

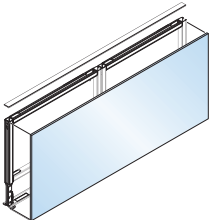

VZTI-PNS
Spanning Steel Tile

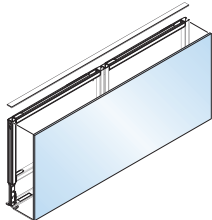

VZTI-DNS
Spanning ChemSurf Tile

Mobile Carts

Ergotron — CareFit Slim Laptop Cart

Slim Laptop Cart

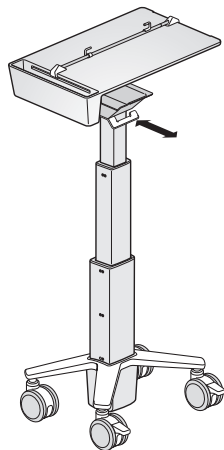

C50-1100-0

Features

- Includes: Assembled cart, four dual casters, laptop security bracket, storage bin and storage tray.
- Handle pull lift offers 24.1”(612mm) lift for a vertical range of 24.5”(622mm) to 49.1”(1247mm) from floor for sit-to-stand functionality.
- Worksurface dimensions: 13.9”(353mm)D x 21”(533mm)W
- Weight capacity: 12 lbs.
- Laptop security bracket holds laptops up to 16.75”(425mm)W
- Casters: Ultra-smooth 4”(102mm) gliding casters. Two locking casters and one tracking caster for improved maneuverability.
- Cart is 14.7”(373mm)D x 18.9”(480mm)W
- Universal mounting slots for accessories and equipment.
- Integrated storage area and pull out cable storage tray with quick connect hardware.

Specification Tip

- Refer to CareFit Slim Accessories page for compatible accessories.

To Order, Specify:

- 1) Product number.

	Number	Price
	C50-1100-0	\$1954.29

T-Slot Scanner/Printer Holder for CareFit Slim



98-465

Features

- Includes: Bracket, shelf, T-slot connector and attachment hardware.
- Shelf surface is 3.6”(91mm)D x 7.4”(188mm)W
- Weight capacity: 2 lbs.

Specification Tips

- Compatible with CareFit Slim LCD Carts.
- Attaches to the horizontal T-slot spanning the back of the CareFit Slim LCD Cart.
- Can be mounted on left or right-hand side of cart.

To Order, Specify:

- 1) Product number.

Description	Number	Price
White	98-465	\$186.60

Mobile Carts

Ergotron — CareFit Slim 2.0 LCD Cart

Slim 2.0 LCD Cart

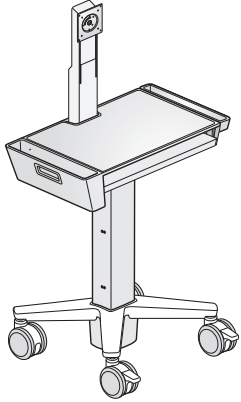

C50-3500-0

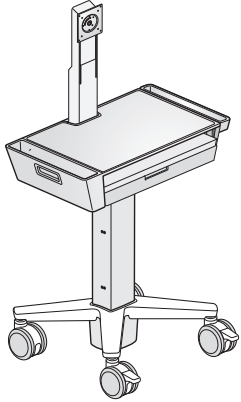

C50-3510-0

Features

- Includes: Assembled cart with pull out keyboard tray, four dual casters, monitor riser assembly, storage bin, storage drawer (if applicable) and hardware.
- Handle pull lift allows monitor and keyboard to move in tandem 17.5"(445mm) adjusting from 29.25"(743mm) to 46.75"(1187mm) from floor for sit-to-stand functionality. Monitor can also rise independently 5"(127mm) for a total monitor travel of 22.5"(572mm).
- Worksurface dimensions: 14.3"(363mm)D x 20.7"(526mm)W
- Monitor:
 - Maximum screen size: 27"(686mm)
 - Maximum weight capacity: 20 lbs.
 - Tilts 25°
 - Pans 90°
 - Rotates 90°
- Storage bin weight capacity: 1 lb.
- Keyboard tray weight capacity: 2 lbs.
- Total cart weight capacity: 32 lbs.
- Pull out keyboard tray has slide out mouse tray. Mouse tray can slide out on the left or right side.
- Casters: Ultra-smooth 4"(102mm) gliding casters. Four locking casters and one tracking caster for improved maneuverability.
- Cart is 16.7"(424mm)D x 18"(457mm)W.
- Universal mounting slots for accessories and equipment.
- Optional drawer and cable management keep supplies and cords out of the way.

Specification Tips

- Minor assembly required.
- Refer to CareFit Slim Accessories page for compatible accessories.

To Order, Specify:

- 1) Product number.

Description	Number	Price
No drawer	C50-3500-0	\$3146.62
Drawer	C50-3510-0	3268.41

Mobile Carts

Ergotron — CareFit Slim 2.0 Accessories

Side-Mount Wipes Holder for CareFit Slim 2.0

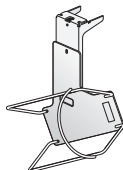

98-451

Features

- Includes: Bracket, holder and attachment hardware.
- Hold a cylindrical container 5”(127mm) in diameter and up to 10”(254mm) tall.
- Weight capacity: 2.5 lbs.

Specification Tip

- Mounts on the left-hand side of the CareFit Slim 2.0 LCD Cart.

To Order, Specify:

- 1) Product number.

Description	Number	Price
White	98-451	\$312.35

Side-Mount Scanner Bracket for CareFit Slim 2.0



98-466

Features

- Includes: Two piece bracket, cable clips and attachment hardware.
- Slot width for scanner is 1.25”(32mm)
- Weight capacity: 1.5 lbs.

Specification Tips

- Compatible with CareFit Slim 2.0 LCD Carts.
- Mounts on the right-hand side of the cart.

To Order, Specify:

- 1) Product number.

Description	Number	Price
White	98-466	\$219.05

Side-Mount Scanner Holder for CareFit Slim 2.0



98-467

Features

- Includes: Bracket, shelf, cable clips and attachment hardware.
- Shelf dimensions: 3.6”(91mm)D x 7.4”(188mm)W
- Weight capacity 1.5 lbs.

Specification Tips

- Compatible with CareFit Slim 2.0 LCD Carts.
- Mounts on the right-hand side of the cart.

To Order, Specify:

- 1) Product number.

Description	Number	Price
White	98-467	\$174.43

Mobile Carts

Ergotron — CareFit Slim 2.0 Accessories

Side-Mount Printer Bracket for CareFit Slim 2.0



98-468

Features

- Includes: Bracket and attachment hardware.
- Weight capacity: 2 lbs.

Specification Tips

- Side-Mount Scanner Holder (98-467) is required for attachment of this bracket to the cart.
- Compatible with CareFit Slim 2.0 LCD Carts.
- Designed for use with Zebra ZQ610 or ZQ620 Mobile Printer.

To Order, Specify:

- 1) Product number.

Description	Number	Price
White	98-468	\$85.19

Mini CPU Holder for CareFit Slim 2.0

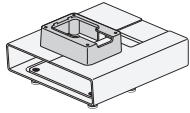

98-470

Features

- Includes: Holder, four thumbscrews, pad and attachment hardware.
- Weight capacity: 3 lbs.

Specification Tips

- Compatible with CareFit Slim 2.0 LCD Carts.
- CPU held in place by tightening thumbscrews on the bottom of the unit.
- Maximum CPU size: 1.6"(41mm)H x 7"(178mm)D x 7"(178mm)W
Note: Include space needed for cables and CPU ventilation when determining size of the CPU.

To Order, Specify:

- 1) Product number.

Description	Number	Price
White	98-470	\$373.20

Front Shelf for CareFit Slim 2.0

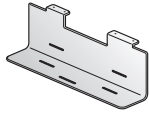

98-476

Features

- Includes: Shelf, pad and attachment hardware.
- Shelf surface: 3.75"(92mm)D x 18.6"(472mm)W
- Weight capacity: 3 lbs.

Specification Tip

- Compatible with CareFit Slim 2.0 LCD Carts.

To Order, Specify:

- 1) Product number.

Description	Height	Depth	Width	Number	Price
White	7.9"(201mm)	3.75"(92mm)	18.6"(472mm)	98-476	\$243.81

Mobile Carts

Ergotron — LifeKinnex

Battery



98-246

Features

- Includes: One Lithium Iron Phosphate battery.
- Battery runtime can be monitored with the LED light bar on the face of the battery.
- Magnetic alignment feature supports easy swapping process.
- Battery capacity: 245 Wh
- Battery weight: 6.7 lbs.

To Order, Specify:

- 1) Product number.

Specification Tips

- Attaches directly to carts equipped with a T-slot column by using a T-slot mount and screws.
- Can be used with docking station; separately specified.
- Battery ships with a 30% charge and cannot be air freighted.

Description	Height	Depth	Width	Number	Price
White	10.2"(259mm)	3.1"(79mm)	6"(152mm)	98-246	\$2437.39

Smart Battery Dock

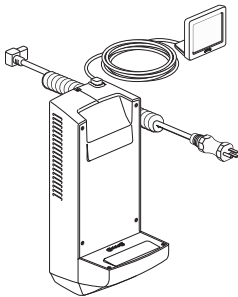

98-247

Features

- Includes: Charger and inverter, cable management cover, cable wrap and ties, mounting hardware, input power cord, output power cord and user-interface screen.
- Internal battery maintains continuous power during battery swaps.
- User-interface screen is an LCD scale gauge showing remaining battery capacity.
- Battery dock weight is 9.9 lbs.
- Input cord is coiled and the output cord is straight to connect to the outlet strip.

To Order, Specify:

- 1) Product number.

Specification Tips

- LiFeKinnex battery separately specified.
- Attaches directly to carts equipped with a T-slot column by using a T-slot mount and screws.

Height*	Depth*	Width*	Number	Price
14"(356mm)	6.4"(163mm)	6"(152mm)	98-247	\$3663.15

* Dimensions include dock and battery.

4-Bay Charger

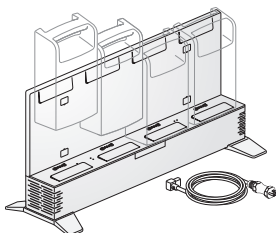
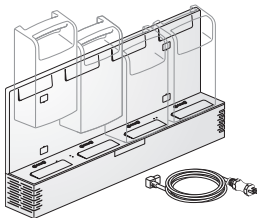

98-258

Features

- Includes: Four-bay charger, 5' input power cord, wall mounting hardware, deck-mount feet and cable restraint clip.
- Can be used as a desk top unit or wall mounted.
- Charges up to four LiFeKinnex batteries simultaneously.
- LED indicates which battery is ready for use.
- Dimensions:
Wall-Mounted - 12"(305mm)"H x 3.8"(97mm)D x 25"(635mm)W
Desk Top - 12.7"(323mm)H x 8.5"(216mm)D x 25.7"(653mm)W

To Order, Specify:

- 1) Product number.

Specification Tip

- LiFeKinnex batteries separately specified

Number	Price
98-258	\$5793.45

Mobile Carts

Ergotron — StyleView LCD Cart

LCD Cart - LiFe Powered

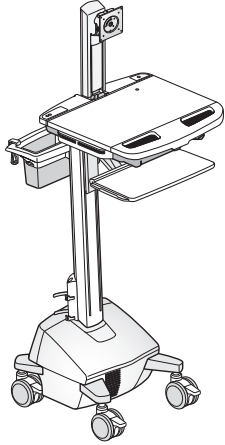

SV42-6302-1

Features

- Includes: LCD pivot, worksurface, CPU lock, CPU compartment, four-port USB hub, scanner holder bracket, mouse holder, wrist rest, keyboard tray, mouse tray, keyboard lights, rear handle, storage basket, cable storage, four casters, LiFe battery power system, integrated AC outlets, 10' coiled cord and power system user interface.
- LCD and worksurface adjust 20"(508mm) in tandem using Constant Force™ technology. LCD Pivot adjusts 5"(127mm) independently; maximum LCD height adjustment of 25"(635mm).
- LCD Pivot tilts 25° and pans 24°.
- Screen rotates 90°.
- Worksurface dimensions: 19.75"(502mm)D x 22.4"(569mm)W
- Back-tilt keyboard tilts 12° and includes a left or right-hand mouse tray.
- Keyboard tray dimensions: 8.5"(216mm)D x 17.5"(445mm)W.
- Maximum screen size: 24"(610mm)
- Total weight capacity of height adjustment assembly is 31 lbs.
 - LCD Pivot: 5-11 lbs.
 - Worksurface: 5 lbs.
 - Keyboard tray: 3 lbs.
 - CPU compartment: 13 lbs.
- CPU compartment interior dimensions: 4"(102mm)H x 8"(203mm)D x 17.76"(451mm)W
- Casters: Four ultra-smooth 4" gliding and locking casters. One caster has full swivel and uni-directional capabilities.
- Wheel-to-Wheel base dimensions: 17"(432mm)D x 15.5"(394mm)W.
- Height of cart is 50.5"(1283mm) with screen in lowered position.
- Four amber LED lights activated by a button on the worksurface provide light over the keyboard tray. Includes 15 minute auto shut-off.
- Power cord: 10' coiled cord with NEMA 5-15P Hospital Grade plug.
- 40 Ah Power system with one 40Ah, 12 V DC Lithium Iron Phosphate (LiFe) battery.

Specification Tips

- Ships fully assembled.
- **For use with 120 volt 60 hertz power source only.**
- Cart has T-slot channel on column to allow additional T-slot accessories.
- When measuring for CPU compartment include mounted accessories, protruding cables, port replicators or docking stations.

To Order, Specify:

- 1) Product number.

	Number	Price
	SV42-6302-1	\$11583.01

Mobile Carts

Ergotron — StyleView Telepresence Cart

Telepresence Cart - Powered - Single Monitor

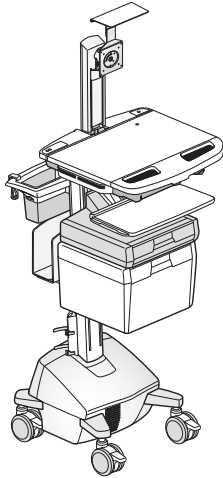

SV44-53E1-1

Features

- Includes: LCD pivot, auto-locking drawer system, worksurface, camera shelf, codec holder, power strip, CPU lock, CPU compartment, four-port USB hub, scanner holder bracket, mouse holder, wrist rest, keyboard tray, mouse tray, rear handle, storage basket, cable storage, four casters, two-battery 66Ah power system, integrated AC outlets, and power system user interface.
- LCD and worksurface adjust 12”(305mm) in tandem using Constant Force™ technology. LCD Pivot adjusts 5”(127mm) independently; maximum LCD height adjustment of 17”(432mm).
- LCD Pivot tilts 25° and pans 24°.
- Screen rotates 90°.
- Worksurface dimensions: 19.75”(502mm)D x 22.4”(569mm)W
- Maximum screen size: 24”(610mm)
- Total cart weight capacity: 39 lbs.
 - LCD Pivot capacity: 5-14 lbs.
 - Worksurface capacity: 5 lbs.
 - Keyboard tray: 2 lbs.
 - CPU compartment: 13 lbs.
 - Camera shelf: 2 lbs.
 - Drawer: 2 lbs.
 - Storage basket: 5 lbs.
- Casters: Four ultra-smooth 4”(102mm) gliding and locking casters. One caster has full swivel and uni-directional capabilities.
- Wheel-to-Wheel base dimensions: 17”(432mm)D x 15.5”(394mm)W.
- Back-tilt keyboard tilts 12° and includes a left or right-hand mouse tray.
- Keyboard pans fully side-to-side.
- Keyboard tray dimensions: 8.5”(216mm)D x 17.5”(445mm)W.
- Four amber LED lights activated by a button on the worksurface provide light over the keyboard tray. Includes 15 minute auto shut-off.
- Coiled power cord is 10’ long with NEMA 5-15P hospital grade grounded plug.
- CPU compartment is ventilated and includes heavy duty keys and locks, security cable and three outlet power strip. Compartment dimensions: 4”(102mm)H x 14.75”(375mm)D x 17.75”(451mm)W
- Back of cart contains four outlet power strip with individual outlet covers and 3’ - 4’ coiled power cord.
- Height of cart is 50.5”(1283)mm with screen in lowered position.
- Drawer system consists of primary top drawer, drawer dividers and large lower drawer.
- Auto-lock drawers - cart stores variable length PINs (5 character max) for up to 100 users to allow electronically controlled access.

Specification Tips

- Ships fully assembled.
- **For use with 120 volt 60 hertz power source only.**
- Cart has T-slot channel on column to allow additional T-slot accessories.
- When measuring for CPU compartment include mounted accessories, protruding cables, port replicators or docking stations.

To Order, Specify:

- 1) Product number.

	Number	Price
	SV44-53E1-1	\$11521.23

Mobile Carts

Ergotron — StyleView Telepresence Cart

Telepresence Cart - Powered Back-to-Back Monitor

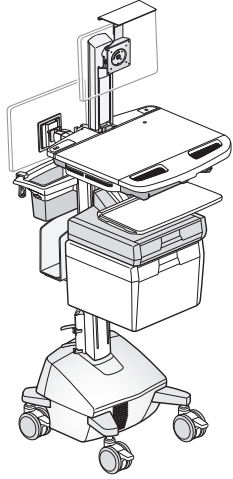

SV44-57E1-1

Features

- Includes: Front and rear LCD pivot, auto-locking drawer system, worksurface, camera shelf, codec holder, power strip, CPU lock, CPU compartment, four-port USB hub, scanner holder bracket, mouse holder, wrist rest, keyboard tray, mouse tray, rear handle, storage basket, cable storage, four casters, two-battery 66Ah power system, integrated AC outlets, and power system user interface.
- Front LCD pivot:
 - Height Adjustment: LCD and worksurface adjust 12”(305mm) in tandem using Constant Force™ technology. LCD pivot adjusts 5”(127mm) independently; maximum front LCD height adjustment of 17”(432mm)
 - Tilts: 25°
 - Pans: 24°
 - Rotates: 90°
- Rear LCD pivot:
 - No height adjustment
 - Tilts: 180°
 - Pans: 180°
- Maximum screen size: 24”(610mm)
- Total cart weight capacity: 39 lbs.
 - Front LCD Pivot capacity: 5-14 lbs.
 - Rear LCD capacity: 23 lbs.
 - Worksurface capacity: 5 lbs.
 - Keyboard tray: 2 lbs.
 - CPU compartment: 13 lbs.
 - Camera shelf: 2 lbs
 - Drawer: 2 lbs.
 - Storage basket: 5 lbs.
- Casters: Four ultra-smooth 4”(102mm) gliding and locking casters. One caster has full swivel and uni-directional capabilities.
- Wheel-to-Wheel base dimensions: 17”(432mm)D x 15.5”(394mm)W.
- Back-tilt keyboard tilts 12° and includes a left or right-hand mouse tray.
- Keyboard pans fully side-to-side.
- Keyboard tray dimensions: 8.5”(216mm)D x 17.5”(445mm)W.
- Four amber LED lights activated by a button on the worksurface provide light over the keyboard tray. Includes 15 minute auto shut-off.
- Coiled power cord is 10’ long with NEMA 5-15P hospital grade grounded plug.
- CPU compartment is ventilated and includes heavy duty keys and locks, security cable and three outlet power strip. Compartment dimensions: 4”(102mm)H x 14.75”(375mm)D x 17.75”(451mm)W
- Drawer system consists of primary top drawer, drawer dividers and large lower drawer.
- Auto-lock drawers - cart stores variable length PINs (5 character max) for up to 100 users to allow electronically controlled access.
- Height of cart is 50.5”(1283mm) with screen in lowered position.
- Back of cart contains four outlet power strip with individual outlet covers and 3’ - 4’ coiled power cord.

Specification Tips

- Ships fully assembled.
- **For use with 120 volt 60 hertz power source only.**
- Cart has T-slot channel on column to allow additional T-slot accessories.
- When measuring for CPU compartment include mounted accessories, protruding cables, port replicators or docking stations.

To Order, Specify:

- 1) Product number.

	Number	Price
	SV44-57E1-1	\$11772.21

Mobile Carts

Ergotron — Cart Accessories

Coiled Extension Cord

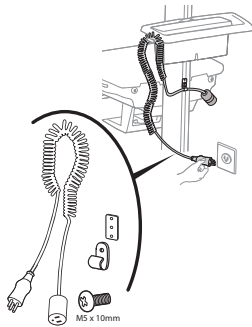

97-464

Features

- Includes: One coiled medical grade cord and connector, cord hook and hardware.
- Cord extends up to 8'.

Specification Tips

- Compatible with CareFit and StyleView carts.
- **For use with 120 volt 60 hertz power sources only.**

To Order, Specify:

- 1) Product number.

Description	Number	Price
Grey	97-464	\$247.61

Power Strip

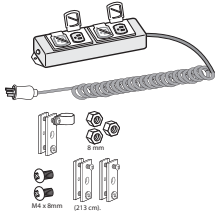

97-466-214

Features

- Includes: Coiled extension cord, four outlet power strip, outlet covers, mounting hardware and cord hanger.
- Power strip has aluminum housing with four NEMA 5-15R hospital grade receptacles
- Receptacles are matched in pairs facing opposite direction from each other to ensure open outlets are not covered by larger power adapters.
- Switchless design prevents accidental shutoff.
- 15 amp coiled cord with medical grade plug extends 3' - 4'.

Specification Tips

- Compatible with all Ergotron carts.
- **For use with 120 volt 60 hertz power sources only.**

To Order, Specify:

- 1) Product number.

Description	Number	Price
	97-466-214	\$361.91

Vinyl Cord Cover



98-453

Features

- Includes: Vinyl wrap with zipper and zip ties.
- Wrap length 32.3"(820mm)
- Vinyl surface for easy cleaning.
- Cords move freely inside wrap.

Specification Tip

- Compatible with LifeKinnex Power Systems and StyleView and CareFit Slim LCD carts.

To Order, Specify:

- 1) Product number.

Description	Number	Price
White	98-453	\$251.51

Power Strip Mounting Kit and Cord Wrap

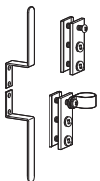

60-590

Features

- Includes: One steel cable-winding bracket, strain-relief clip, and two T-slot brackets.
- Weight capacity: 5 lbs.

Specification Tips

- Compatible with a variety of power strips (not included) and attaches to any Ergotron cart with integrated T-slot channel.
- Attaches at any point along the channel.

To Order, Specify:

- 1) Product number.

Description	Number	Price
	60-590	\$60.96

Mobile Carts

Ergotron — T-Slot Accessories

StyleView Scanner Shelf



97-780-194

Features

- Includes: Metal tray, bracket, Velcro, strap and mounting hardware.
- Scanner base can be attached to shelf with included Velcro or strap.
- Weight capacity: 2 lbs.
- Shelf dimensions: 4"(102mm)D x 8"(203mm)W

Specification Tips

- Compatible with StyleView carts and Ergotron wall track; separately specified.
- Attaches to the StyleView cart's worksurface with included bracket or in the T-slot on the back of the cart.
- When attaching to wall track a separately specified Track Mount Bracket (97-091) is required.
- Attachment of shelf impacts overall weight capacity of the cart.

To Order, Specify:

- 1) Product number.

Description	Number	Price
Silver	97-780-194	\$102.85

StyleView Wire Basket

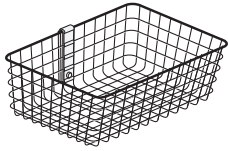

98-135-216

Features

- Includes: One welded-wire basket and T-slot channel bracket.
- Available in two sizes - small and large.
- Weight Capacity: 5 lbs

Specification Tips

- Compatible with any cart with a T-slot channel.
- Installs at any height along the T-slot channel on the column.

To Order, Specify:

- 1) Product number.

Description	Height	Depth	Width	Number	Price
Small	6"(152mm)	10.25"(260mm)	12.3"(312mm)	98-136-216	\$137.15
Large	6"(152mm)	12.8"(325mm)	17"(432mm)	98-135-216	186.67

SV Hook



97-999

Features

- Includes: Storage hook, T-slot bracket and hardware.
- Weight Capacity: 20 lbs

Specification Tips

- Compatible with Ergotron carts and desks with a T-slot channel.
- Installs at any height along the T-slot channel on the column.

To Order, Specify:

- 1) Product number.

Description	Number	Price
White	97-999	\$26.89

Mobile Carts

Ergotron — T-Slot Accessories

T-Slot Wipes Holder



98-450

Features

- Includes: Holder, T-slot connector and attachment hardware.
- Attaches to any Ergotron cart's vertical or horizontal T-slot channel.
- Hold a cylindrical container 5"(127mm) in diameter and up to 10"(254mm) tall.
- Weight capacity: 2.5 lbs.

To Order, Specify:

- 1) Product number.

Specification Tip

- Compatible with Ergotron carts with T-slot channels.

Description	Number	Price
White	98-450	\$163.81

T-Nut Kit



97-631

Features

- Includes: Two aluminum t-nut brackets, four 10mm screws and four 12mm screws.
- Kit used to attach users' equipment to back of carts with T-slot channels.
- Weight Capacity:
 - 15 lbs. on non-powered cart without drawers
 - 20 lbs. on powered cart with drawers.

To Order, Specify:

- 1) Product number.

Specification Tips

- Compatible with any Ergotron cart with a T-slot channel.
- Consider weight of component being mounted and the height on the cart to avoid tip hazard.

	Number	Price
	97-631	\$25.41

Wall Mounted Workstations

Ergotron — CareFit

Enclosure

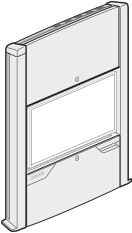
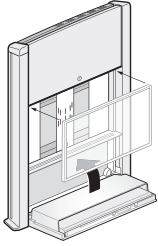

61-367

Features

- Includes: Enclosure, fold-up keyboard and mouse tray, removable writing surface, wrist rest, cable management hardware, installation hardware and digital lock with rechargeable battery.
- Height adjustment range of 20”(508mm) allows for a sitting or standing posture using Constant Force™ technology.
- Low profile design stays within 4”(102mm) of wall when keyboard is folded up.
- Fits most screens 24”(610mm) - 27”(686mm).
- Keyboard tray dimensions: 19.5”(495mm)D x 24.7”(627mm)W.
- Writing surface dimensions: 7.4”(188mm)D x 24.7”(627mm)W.
- Weight capacity:
 - Monitor: 7-12.5 lbs
 - Keyboard Tray: 0.5-3 lbs.

Specification Tips

- Mounts directly to architectural wall with included attachment hardware.
- T-slots in side rails accommodate separately specified vertical or horizontal scanner mounts.
- Front is customizable with separately specified laminate fronts.

To Order, Specify:

- 1) Product number.

Description	Height	Depth	Width	Number	Price
Snow White	39”(991mm)	4”(102mm)	33”(838mm)	61-367-030	\$2712.18
Matte Black				61-367-060	2712.18

Wall Mounted Workstations

Ergotron — CareFit Enclosure Accessories

Horizontal Scanner Bracket

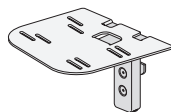

98-424

Features

- Includes: Two shelf options, T-slot bracket and attachment hardware.
- Bracket attaches to T-slot on left or right side rail of the CareFit Enclosure.
- Can be installed at any height and repositioned as needed.
- Base of scanner is secured to the mounting plate with separately specified screws.
- Weight capacity: 2 lbs.

To Order, Specify:

- 1) Product number.

Specification Tips

- Designed for use with the following scanners:
 - Zebra DS8178 Wireless Scanner (presentation style)
 - Honeywell Xenon 1902H
 - DataLogic Gryphon GM4400
 - Code CR2600 Handle + Palm kits
 - Code CR2700 Series
- Filler strip on CareFit Enclosure must be removed to install T-slot bracket.

Description	Number	Price
Snow White	98-424-030	\$165.87
Matte Black	98-424-060	165.87

Vertical Scanner Bracket

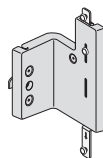

98-425

Features

- Includes: Vertical holder, T-slot bracket and attachment hardware.
- Bracket attaches to T-slot on left or right side rail of the CareFit Enclosure.
- Can be installed at any height and repositioned as needed.
- Weight capacity: 2 lbs.

To Order, Specify:

- 1) Product number.

Specification Tips

- Designed for use with the following scanners:
 - Zebra DS8178 Wireless Scanner (standard cradle)
 - Symbol LS4278
- Filler strip on CareFit Enclosure must be removed to install T-slot bracket.

Description	Number	Price
Snow White	98-425-030	\$165.87
Matte Black	98-425-060	165.87

Laminate Kit

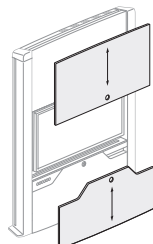

98-419

Features

- Includes: Two high-pressure laminate panels and adhesive.
- Laminate panels attach to front of the CareFit Enclosure using included adhesive.
- Wood grain direction is vertical.

To Order, Specify:

- 1) Product number.

Description	Number	Price
Fonthill Pear	98-419-888	\$675.73
Manitoba Maple	98-419-906	675.73
Phantom Cocoa	98-419-889	675.73
Phantom Ecu	98-419-890	675.73
Walnut Heights	98-419-891	675.73
Wild Cherry	98-419-887	675.73

Wall Mounted Workstations

Ergotron — LX

Sit-Stand Wall Mount System

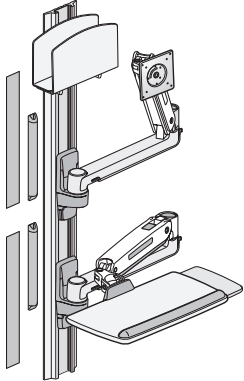

45-359-026
45-358-026

Features

- Includes: 10"(254mm) and 34"(864mm) wall tracks, two black track covers, LCD arm, keyboard arm, wrist rest, mouse holder small or medium CPU holder, two 10"(254mm) cable channels and mounting hardware.
- Polished aluminum with silver (medium) or black (small) CPU holder.
- Provide 20"(508mm) lift range using Constant Force™ technology.
- Keyboard tray dimensions: 8.9"(226mm)D x 18.33"(466mm)W.
- Weight capacity:
 - Monitor: 7-25 lbs.
 - Keyboard: 5 lbs.
 - CPU: 40 lbs.
- Maximum screen size: 42"(1067mm).
- Monitor tilts 70° up and 5° down.
- CPU size range:
 - Small: 1.32"(34mm)W - 3.75"(95mm)W.
 - Medium: 3.37"(86mm)W - 8"(203mm)W
 - Medium can accommodate CPU as small 2"(51mm)W using included plastic spacer.
- Screen rotates 360°.
- Rotation Stop on wall-mount base limits turn of extension base connection to 180° and prevents extension from contacting wall when panning.
- Keyboard folds for storage to within 6.8"(173mm) of wall. Monitor arm folds back to a depth of 5.5"(140mm).
- Locking connections between arm, extension and base prevents disconnections caused by jarring or impacts as well as increased theft deterrence.
- Base and CPU holder include anchor holes for cable locks.
- Extra long USB, power or video cables may be needed to span between standing and sitting heights.

To Order, Specify:

- 1) Product number.

Specification Tip

- Mounts directly to architectural wall.

Description	Number	Price
Small CPU Holder	45-359-026	\$2349.26
Medium CPU Holder	45-358-026	2349.26

Wall Mounted Workstations

Ergotron — LX

Sit-Stand Wall Mount LCD Arm

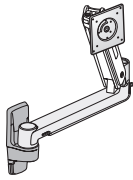

45-353-026
45-383-026

Features

- Includes: Arm, extension, wall-mount base, VESA bracket and hardware.
- Provide 20”(508mm) lift range using Constant Force™ technology.
- Arm provides 33”(838mm) of extension with 62”(1575mm) of side-to-side motion.
- Weight capacity: Standard 7-25 lbs.; HD (heavy duty) 14-30 lbs.
- Maximum screen size: Standard 42”(1067mm); HD (heavy duty) 46”(1168mm).
- Monitor tilt: Standard 70° up and 5° down; HD (heavy duty) 75° up and 5° down.
- Monitor pans 360°. Rotation Stop on wall-mount base limits turn of extension base connection to 180° and prevents extension from contacting wall when panning.
- Screen rotates 360° on the standard model and 90° on the HD model..
- Folds to fit within 4.5”(114mm) of the wall.
- Base includes anchor holes for cable locks.
- Meets ETL Environmental VOC+ standards.

To Order, Specify:

- 1) Product number.

Specification Tips

- Mounting options:
 - Attached directly to sturdy vertical surfaces. Where applicable, install to wood stud.
 - Attaches to Wall track using separately specified bracket (97-091).
- Can be configured to hold a laptop with separately specified Notebook Tray (50-193-200).
- Extra long USB, power or video cables may be needed to span between standing and sitting heights.

Description	Number	Price
Standard		
Polished Aluminum	45-353-026	\$669.23
HD - Heavy Duty		
Polished Aluminum	45-383-026	\$752.91

Sit-Stand Wall Mount Keyboard Arm

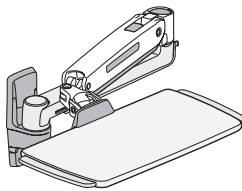

45-354-026

Features

- Includes: Arm, extension, wall-mount base, Keyboard tray, slide-out mouse tray, wrist rest, mouse holder and hardware.
- Provide 20” lift range using Constant Force™ technology.
- Arm can be used with or without the extension.
- Arm provides 42”(1067mm) of extension.
- Weight capacity: 5 lbs.
- Keyboard tray : 8.9”(226mm)D x 18.3”(465mm)W
 - In down position has back tilt of 5°.
 - Folds upright 90° in storage position.
- Mouse tray: 8”(203mm)D x 8”(203mm)W
 - Slides out to either left or right side.
- Folds to fit within 5.8”(147mm) of the wall.
- Base includes anchor holes for cable locks.
- Meets ETL Environmental VOC+ standards.

To Order, Specify:

- 1) Product number.

Specification Tips

- Mounting options:
 - Attached directly to sturdy vertical surfaces. Where applicable, install to wood stud.
 - Attaches to Wall track using separately specified bracket (97-091).
- Extra long USB or power cables may be needed to span between standing and sitting heights.

Description	Number	Price
Polished Aluminum	45-354-026	\$845.58

Wall Mounted Workstations

Ergotron — LX

Wall Mount Monitor Arm

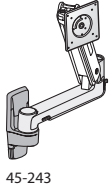

45-243

Features

- Includes: LX arm, extension, wall-mount base and hardware.
- Provide 13”(330mm) lift range using Constant Force™ technology.
- Arm extension range up to 25”(635mm).
- Weight capacity: 7-25 lbs.
–Note: monitors greater than 20 lbs may have reduced range of motion.
- Maximum screen size: 34”(864mm).
- Monitor tilts 70° up and 5° down.
- Monitor pans 360°.
- Screen rotates 360°.
- Folds to fit within 4”(102mm) of the wall.
- Base includes anchor holes for cable locks.
- Meets ETL Environmental VOC+ standards.

To Order, Specify:

- 1) Product number.

Specification Tips

- Mounting options:
 - Attached directly to sturdy vertical surfaces. Where applicable, install to wood stud.
 - Attaches to Wall Plate or Wall track using separately specified bracket (97-091).
- Can be configured to hold a laptop with separately specified Notebook Tray (50-193-200)

Description	Number	Price
Polished Aluminum	45-243-026	\$428.79
Matte Black	45-243-224	428.79

Dual Monitor and Handle Kit

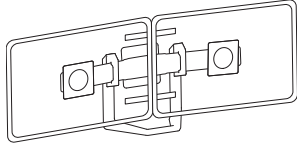

97-783

Features

- Includes: Monitor bow, two monitor pivots, handle and mounting hardware.
- For use with screens 26”(660mm) or smaller.
- Maximum weight capacity is 18 pounds per arm.
- Maximum combined weight is 36 pounds.
- Rotates 360°.
- Arm in polished aluminum, bow and handle in black.

To Order, Specify:

- 1) Product number.

Specification Tips

- This product adds an additional 6 pounds to your mounting solution. Monitor arm's maximum weight capacity must be reduced by 6 pounds.
- Attaches to mounts with four-hole interface of 50 x 50 mm or 100 x 100 mm.

Description	Number	Price
Polished Aluminum/Black	97-783	\$267.32

Wall Mounted Workstations

Ergotron — StyleView Vertical Lift

Sit-Stand Vertical Lift - High Traffic Area

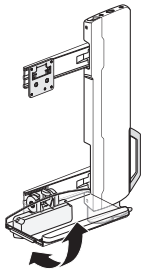

61-081

Features

- Includes: Wall-mounted steel vertical lift kit including, monitor mount, auto-retractable keyboard tray, slide out mouse tray, mouse pouch, wrist rest, integrated cable management and hardware.
- Low profile Sit-Stand Vertical Lift provides 18”(457mm) of vertical adjustment using Constant Force™ technology.
- Auto-retracting keyboard tray folds up for low profile of 4”(102mm).
- Maximum screen size: 24”(610mm) and/or 25 lbs.
- Monitor tilt range of 20° forward and 10° back.
- Keyboard tray tilts 0° to -10°.
- Keyboard tray dimensions: 9”(229mm)D x 16.5”(419mm)W.
- Total weight capacity: 30 lbs.
- Mouse tray can be placed on the right or left side.
- Integrated cable management can be configured on right or left hand side.

To Order, Specify:

- 1) Product number.

Specification Tip

- Mounts directly to architectural wall.

Description	Number	Price
Black	61-081-085	\$1818.07
White	61-081-062	1683.40

Vertical Lift - High Traffic Area

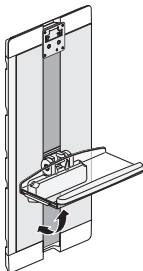

60-593

Features

- Includes: Wall-mounted steel vertical lift kit including, monitor mount, keyboard tray and mouse tray, scanner or mouse holder, wrist rest, integrated cable management and hardware.
- Low profile vertical lift provides 9”(229mm) of vertical adjustment.
- Maximum screen size: 24”(610mm) and/or 25 lbs.
- Monitor tilt range of +5°/-5°.
- Keyboard tray folds up for low profile of 4”(102mm).
- Keyboard tray tilts 0° to -10°.
- Keyboard tray dimensions: 9”(229mm)D x 16.5”(419mm)W.
- Total weight capacity: 30 lbs.
- Mouse tray can be placed on the right or left side.
- Integrated cable management can be configured on right or left hand side.

To Order, Specify:

- 1) Product number.

Specification Tips

- Accepts auto-retracting keyboard kit; separately specified.
- Mounts directly to architectural wall.

Description	Number	Price
Black	60-593-195	\$1306.41
White	60-593-216	1306.41

Vertical Lift Auto-Retracting Keyboard Kit

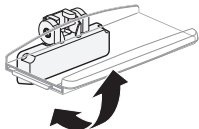

97-487-800

Features

- Includes: Auto-retracting keyboard lift assembly, wrist rest and one each of black, white and grey covers, Velcro and applicable hardware.
- Keyboard tray from existing Vertical Lift High Traffic unit is used.
- Weight capacity: 0.75 lbs to 2.5 lbs.(Includes weight of keyboard, mouse, mouse pad, wrist rest and adhesive materials.
- Keyboard depth not to exceed 7”(178mm).

To Order, Specify:

- 1) Product number.

Specification Tips

- Two adjustment options:
 - Full auto-retraction - Keyboard retracts immediately after use.
 - Manual initialization - Auto-retract can be set so lift only occurs with manual intervention.
- For use with StyleView Vertical Lift High Traffic models.

Number	Price
97-487-800	\$251.42

Wall Mounted Workstations

Ergotron — StyleView Sit-Stand Combo

Sit-Stand Combo System - with Worksurface and Panning Pivot

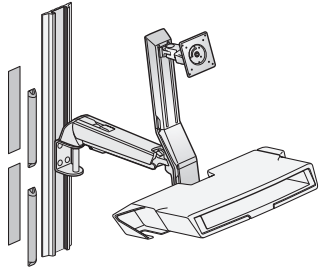

45-583

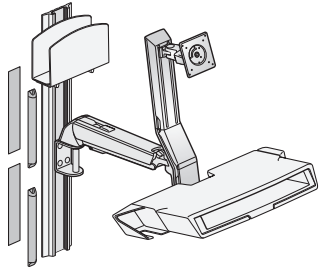

45-594

Features

- Includes: Combo arm, wall mount bracket, track mount bracket kit, height-adjustable LCD mount, wrist rest, scanner holder, mouse holder, worksurface with integrated keyboard tray, slide-out mouse tray, VESA monitor mounting kit and cable ties.
- Optional CPU holder can be ordered and will also include 34”(864mm) wall track, two track covers, CPU holder, CPU spacer, two 10”(254mm) cable channels, CPU and arm track mount bracket kits and wall track fasteners for concrete or wood.
- Maximum screen size: 24”(610mm).
- Weight capacity:
 - Display: 6-18 lbs.
 - Worksurface: 10 lbs.
 - Mouse and barcode scanner: 4 lbs.
- Extends up to 43”(1092mm) from wall.
- Lift: LCD and keyboard in tandem adjust 20”(508mm) with a single motion using Constant Force™ technology. LCD adjusts 5”(127mm) independently for a maximum LCD height adjustment of 25”(635mm).
- Screen rotates 90° for portrait or landscape use.
- Tilt: monitor tilts 30° (-5°/+25°)
- Combo arm system pans 360°. Monitor independently pans 180°.
- Small CPU holder: 1.37”(34mm)W - 3.75”(95mm)W.
- Medium CPU holder: 3.37”(86mm)W - 8”(203mm)W.
- Worksurface dimensions: 10.6”(269mm)D x 22.75”(578mm)W.
- Keyboard tray dimensions: 9”(229mm)D x 18.6”(472mm)W.
- Maximum allowable keyboard height: 1.35”(34mm)
- Back-tilt keyboard tray adjustable from 0° to -10°
- Keyboard and arm fold up, out of the way when not in use.

To Order, Specify:

- 1) Product number.

Specification Tips

- Mounts directly to architectural wall.
- Additional separately specified accessories include:
 - StyleView Sit-Stand Combo Extender Arm
 - Notebook Tray

Description	Number	Price
Combo Arm with Worksurface and Panning		
Polished Aluminum	45-583-026	\$2037.42
White	45-583-216	2037.42
Combo Arm with Worksurface and Panning and Small CPU Holder		
Polished Aluminum	45-594-026	\$2510.84
White	45-594-216	2510.84
Combo Arm with Worksurface and Panning and Medium CPU Holder		
Polished Aluminum	45-595-026	\$2510.84
White	45-595-216	2510.84

Sit-Stand Arm Extender

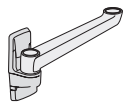

45-261

Features

- Includes: Arm, pivot covers and mounting brackets.
- Adds additional 17”(432mm) extension from the wall.

To Order, Specify:

- 1) Product number.

Specification Tips

- Designed for use with StyleView Sit-Stand Combo System.
- Replaces Vertical Mount Base when installed.

Description	Number	Price
Polished Aluminum	45-261-026	\$421.17
White	45-261-216	421.17

Wall Mounted Workstations

Ergotron — Accessories

Wrist Rest - Antimicrobial

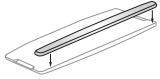

97-533

Features

- Includes: Black wrist rest, adhesive tape, alcohol wipe.
- Attaches to keyboard tray with adhesive strips.
- Antimicrobial treated.

To Order, Specify:

- 1) Product number.

Description	Height	Depth	Width	Number	Price
Black	0.9"(23mm)	1.4"(36mm)	16.5"(419mm)	97-533	\$76.19

Scanner Shelf - VESA Attached

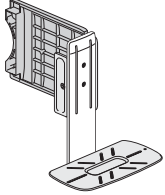

97-815

Features

- Includes: Angle bracket and shelf, VESA mount bracket, and hardware.
- Scanner shelf can be mounted on either side of a monitor 17"(432mm) to 24"(610mm).
- Weight capacity: 1.5 lbs.
- Cable management routes power cord for the scanner base.

To Order, Specify:

- 1) Product number.

Specification Tips

- Will not interfere with movement of monitor screen.
- Does not include scanner base or scanner.
- Includes hardware to lockout portrait/landscape screen rotation to keep monitor level.

Description	Number	Price
Black	97-815	\$129.52
White	97-815-062	125.71

Scanner Holder - Wall Mount

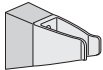

97-566

Features

- Includes: Scanner holder and mounting hardware.
- Compatible with most barcode scanners.
- Weight capacity: 1.5 lbs.
- Mounting surface is 3.5"(89mm)H x 1.75"(44mm)W.

To Order, Specify:

- 1) Product number.

Description	Number	Price
Black	97-566	\$47.20

Notebook Tray

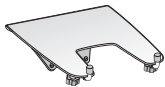

50-193-200

Features

- Includes: Metal tray, adjustable rails, Velcro, non-slip pad, clips and attachment hardware.
- Tray is 9"(229mm)W and adjusts 9.25"(235mm)D to 15.75"(400mm)D. Accommodates most laptops.
- Velcro, non-slip pad or clips hold laptop in place.
- Can be used with or without docking stations.
- Weight capacity: 2.5 lbs - 12 lbs.

To Order, Specify:

- 1) Product number.

Specification Tip

- Must be used with arm, pivot or cart; separately specified.

Description	Number	Price
Black	50-193-200	\$106.67

Wall Mounted Workstations

Ergotron — Accessories

Wall Plate	Features	To Order, Specify:				
 <p>97-101-003</p>	<ul style="list-style-type: none"> Includes: One wall plate. Provides extra support when attaching Ergotron arm or pivot to a wall. Wall plate is 8.38”(213mm)H x 3.5”(89mm)W. <hr/> <p>Specification Tips</p> <ul style="list-style-type: none"> Fasteners for attaching to wall must be field supplied. Not for use with HD Arms. 	<p>1) Product number.</p> <table border="1" data-bbox="381 478 1481 548"> <thead> <tr> <th data-bbox="381 478 1031 506">Number</th> <th data-bbox="1031 478 1481 506">Price</th> </tr> </thead> <tbody> <tr> <td data-bbox="381 506 1031 533">97-101-003</td> <td data-bbox="1031 506 1481 533">\$72.38</td> </tr> </tbody> </table>	Number	Price	97-101-003	\$72.38
Number	Price					
97-101-003	\$72.38					

Steel Stud Wall Mounting Kit	Features	To Order, Specify:				
 <p>60-591-003</p>	<ul style="list-style-type: none"> Includes: Aluminum wall plate, six screws and six anchors. Weight capacity: 50 lbs. Wall plate is 8.375”(213mm)H x 3.5”(89mm)W <hr/> <p>Specification Tips</p> <ul style="list-style-type: none"> Securely attaches Ergotron wall mounts to steel-stud constructed walls. Use on steel stud only. Center holes must go into steel stud. Not for use with wood studs or walls without studs. 	<p>1) Product number.</p> <table border="1" data-bbox="381 919 1481 989"> <thead> <tr> <th data-bbox="381 919 1031 947">Number</th> <th data-bbox="1031 919 1481 947">Price</th> </tr> </thead> <tbody> <tr> <td data-bbox="381 947 1031 974">60-591-003</td> <td data-bbox="1031 947 1481 974">\$144.76</td> </tr> </tbody> </table>	Number	Price	60-591-003	\$144.76
Number	Price					
60-591-003	\$144.76					

Wall Mounted Workstations

Ergotron CPU Holder

Small CPU Holder



80-063

Features

- Includes: One vertical steel CPU holder, mounting hardware and fasteners.
- Mounts to any sturdy vertical surface.
- CPU Holder is 6”(152mm)H x 10”(254mm)D.
- Accommodates CPUs 1.4”(25mm) to 3.75”(76mm)W.
- Weight capacity: 50 lbs.

To Order, Specify:

- 1) Product number.

Description	Number	Price
Black	80-063-200	\$138.38
White	80-063-216	138.38

Universal CPU Holder

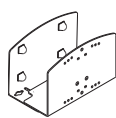

97-468

Features

- Includes: One vertical steel CPU holder, mounting hardware and fasteners.
- Mounts to any sturdy vertical surface.
- CPU Holder is 6.6”(152mm)H x 10”(254mm)D.
- Accommodates CPUs 2”(51mm) to 8”(203mm)W.
- Weight capacity: 40 lbs.

To Order, Specify:

- 1) Product number.

Silver	97-468-202	\$182.71
White	97-468-216	182.71

Mini PC Mount

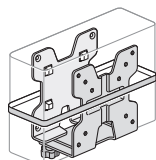

80-107

Features

- Includes: Steel holder, mounting hardware, mounting pads and strap.
- Mounting pads and strap included for increased stability.
- Weight capacity: 6 lbs.

To Order, Specify:

- 1) Product number.

Specification Tips

- Mounting Options:
 - VESA mount; between monitor and VESA plate interfaces.
Note: Monitor must weigh less than 18 lbs.
 - Pole with a diameter of 1.38”(35mm) - 1.58”(40mm).
 - Ergotron Wall Track
 - Under desktop to wood surface.
- Accommodates CPU dimensions:
 - Height: 6.8”(173mm) - 10”(254mm)
 - Depth: 0.85”(22mm) - 2.3”(58mm)
 - Width: 4”(102mm) - 9”(229mm)

Description	Number	Price
Black	80-107-200	\$102.85
White	80-107-216	102.85

Wall Mounted Workstations

Ergotron — Wall Track

Wall Track

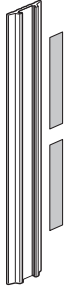

31-018-182

Features

- Includes: Aluminum wall track with cable management channel covers.
- Accommodates entire computer system; LX wall mount arms and universal CPU holders.
- Wall track is 5"(127mm)W.

Specification Tips

- Fasteners to attach to wall are separately specified. For metal or wood studs order 97-531. For hollow walls order 90-011.
- Requires Track Mount Bracket Kit to attach Ergotron components; separately specified.
- OSHPD pre-approved for California hospital requirements.

To Order, Specify:

- 1) Product number.

Description	Height	Depth	Width	Number	Price
Silver	26"(660mm)	0.9"(23mm)	5"(127mm)	31-017-182	\$177.43
Silver	34"(864mm)	0.9"(23mm)	5"(127mm)	31-018-182	219.86
White	34"(864mm)	0.9"(23mm)	5"(127mm)	31-018-216	219.86
Silver	42"(1067mm)	0.9"(23mm)	5"(127mm)	31-039-182	285.43

Wall Track Mounting Kit



(10) Toggle Anchors



(10) Screws 1/4-20 x 2"
90-011



(6) Wood Stud Screws



(6) Steel Stud Screws
97-531

Features

- Includes: Hollow wall mount: Ten toggle anchors and screws. Steel/Wood stud mounting: Six wood mounting screws and six steel stud mounting screws.
- Used to install Wall Track to walls.

To Order, Specify:

- 1) Product number.

Description	Number	Price
Hollow Wall Mounting	90-011	\$68.57
Steel/Wood Stud Mounting	97-531	32.67

Track Mount Bracket Kit

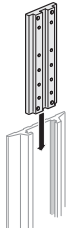

97-091

Features

- Includes: Aluminum track mount bracket and hardware.
- Slides onto wall track.
- Attaches arms, pivots, and universal CPU holder to wall track.

To Order, Specify:

- 1) Product number.

Number	Price
97-091	\$80.01

Task Seating

Soji-At-A-Glance

Features

Pneumatic seat height adjustment:

- Standard model adjusts 16.4"-21"
- Low position model adjusts 14.75"-17.5"
- Stool adjusts 22"-29.5"

Synchronous tilt mechanism provides 23° of back recline.

Standard tilt mechanism control regulates the amount of resistance of the back.

Standard five-star base in plastic or optional aluminum. Optional low position base in aluminum.

Hard casters available for carpet flooring and soft casters for hard flooring.

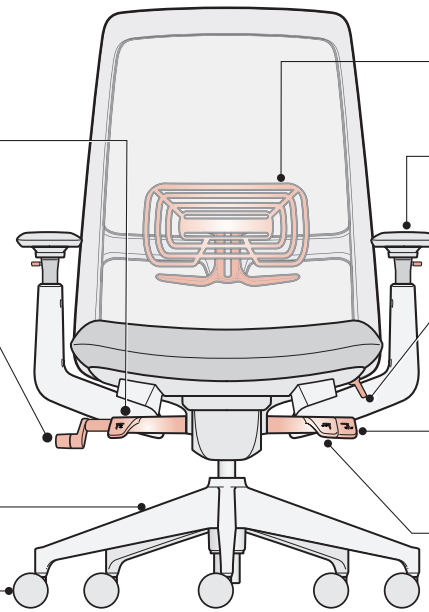

Front View

Optional height adjustable lumbar has 3.5" of height adjustment.

Arms available fixed, height adjustable and 4D; armless.

Optional forward tilt allows seat pan to move downward 5° from the initial position. Forward tilt not available on stool.

Single position back lock to lock back of chair in the upright position.

Seat standard fixed or optional adjustable (2.5" seat depth range).

Aesthetic Options

Arm Caps:
Black or Fog

Arm Uprights:
Black, Fog or Snow

Mechanism and Cover:
Black

Casters:
• Hard: Black or Two-Tone Grey
• Soft: Black

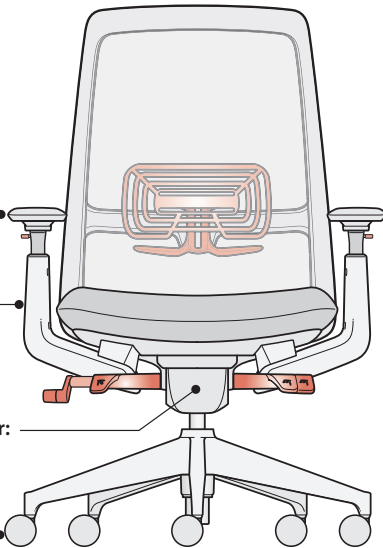

Front View

Frame:
Black, Fog or Snow

Lumbar:
Black or Fog

Controls:
Black

Base:
• Plastic: Black or Fog
• Aluminum: Black, Metallic Silver or Polished Aluminum

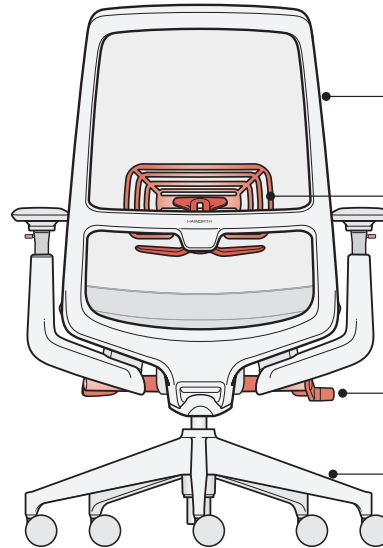

Back View

Task Seating — Soji – Cleanable+

Task Chair with 4D Arms — **Plastic Base**



SJT-3C-711A

Dimensions

- *SH: 16.4"-21.0"
(417mm-533mm)
- H: 39"-44"
(991mm-1118mm)
- D: 27"(686mm)
- W: 28"(711mm)
- *SW: 20"(508mm)
- *SD: 16.25"-18.75"
(413mm-476mm)
- *AH: 7.4"-11.4"
(188mm-290mm)

* All measurements taken with the BIFMA chair measuring device.

Plastic Trim Color	Lumbar	Arm Caps	Backing Material for Cleanable Upholstered Back
TR-F Black	TR-F Black	TR-F Black	Wellington, Black XJ-BL
TR-7 Fog	TR-7 Fog	TR-7 Fog	Wellington, Steel XJ-SL
TR-UFM Snow	TR-7 Fog	TR-7 Fog	Wellington, Steel XJ-SL

Features

- Seat and back must be faux leather for a fully cleanable chair.
- Inner Back / Seat: Customer specified faux leather.
- Backing material: Wellington Black or Steel as determined by trim color. See chart.
- Available as a fixed seat or with seat depth adjustment (2.5"(64mm) range).
- Base: Plastic five-star base.
- Arms: 4D arms have height adjustment range of 4"(102mm). Arms move front to back, side to side and pivot in and out.
- Lumbar: Available with optional lumbar support with 3.5"(89mm) adjustment.
- Mechanism: Synchronized tilt; standard tilt tension adjustment.
- Height adjustment: Standard pneumatic.
- Back Lock: Standard single position upright back lock.
- Optional Forward Tilt: 5° downward from initial position. Only available on chairs with seat depth adjustment.
- Casters: Hard casters in black or two-tone grey; Soft casters black only.
- COM yardage: Seat: 0.62 / Back: 1.25

Specification Tips

- Ships standard assembled. Optional knocked down shipment comes in three pieces; assembly does not require tools.
- Lumbar color defaults based on trim color specified and is available in Black or Fog only.
 - Black will be received if plastic trim color is Black.
 - Fog will be received if Fog or Snow plastic trim is ordered.
- Reference color chart for applied backing material for cleanable upholstery back. Backer material determined by trim color.

To Order, Specify:

1) Product number, including;

1 Caster Option:

- 5 Hard Casters (Black)
- 6 Soft Casters (Black), add \$57.29 to list
- 7 Hard Two-Tone Casters (Grey)

2) Seat surface material and color.

3) Back surface material and color.

4) Plastic trim color (frame and arm uprights).
TR-F Black
TR-7 Fog, add \$92.13 list.
TR-UFM Snow, add \$148.82 list.

5) Base color.
TR-F Black
TR-7 Fog

Description	Number ¹	Fabric Grade								
		A	B	C	D	E	F	G	H	
Upholstered Back, No Lumbar Adjustment										
Back Lock w/Fixed Seat	SJT-3C-701X	A	\$1180.76	\$1270.00	\$1365.66	\$1410.38	\$1448.60	\$1531.52	\$1608.04	\$1812.10
Back Lock w/Seat Depth Adjustment	SJT-3C-701A	A	1209.12	1298.36	1394.02	1438.74	1476.96	1559.88	1636.40	1840.46
Back Lock & Forward Tilt w/Seat Depth Adjustment	SJT-3C-704A	A	1260.19	1349.43	1445.09	1489.81	1528.03	1610.95	1687.47	1891.53
Upholstered Back, Lumbar Adjustment										
Back Lock w/Fixed Seat	SJT-3C-711X	A	\$1248.79	\$1338.03	\$1433.69	\$1478.41	\$1516.63	\$1599.55	\$1676.07	\$1880.13
Back Lock w/Seat Depth Adjustment	SJT-3C-711A	A	1277.15	1366.39	1462.05	1506.77	1544.99	1627.91	1704.43	1908.49
Back Lock & Forward Tilt w/Seat Depth Adjustment	SJT-3C-714A	A	1328.22	1417.46	1513.12	1557.84	1596.06	1678.98	1755.50	1959.56

The following options require modification of the product number.

Knocked Down Shipment To specify, change the 11th digit from an A to K and deduct \$42.52 list; **Example:** SJT-3C-701X5K

Task Seating — Soji – Cleanable+

Task Chair with 4D Arms — Aluminum Base



SJT-3C-711A

Dimensions

- *SH: 16.4"-21.0"
(417mm-533mm)
- H: 39"-44"
(991mm-1118mm)
- D: 27"(686mm)
- W: 28"(711mm)
- *SW: 20"(508mm)
- *SD: 16.25"-18.75"
(413mm-476mm)
- *AH: 7.4"-11.4"
(188mm-290mm)

Low position seat height:
14.75"-17.5"
(375mm-445mm)

* All measurements taken with the BIFMA chair measuring device.

Features

- Seat and back must be faux leather for a fully cleanable chair.
- Inner Back / Seat: Customer specified faux leather.
- Backing material: Wellington Black or Steel as determined by trim color. See chart.
- Available as a fixed seat or with seat depth adjustment (2.5"(64mm) range).
- Base: Aluminum five-star base.
- Arms: 4D arms have height adjustment range of 4"(102mm). Arms move front to back, side to side and pivot in and out.
- Lumbar: Available with optional lumbar support with 3.5"(89mm) adjustment.
- Mechanism: Synchronized tilt; standard tilt tension adjustment.
- Height adjustment: Standard pneumatic.
- Back Lock: Standard single position upright back lock.
- Optional Forward Tilt: 5° downward from initial position. Only available on chairs with seat depth adjustment.
- Casters: Hard casters in black or two-tone grey; Soft casters black only.
- COM yardage: Seat: 0.62 / Back: 1.25

To Order, Specify:

1) Product number, including;

1 Caster Option: Standard Base

- 1 Std. Base Hard Casters (Black)
- 2 Std. Base Soft Casters (Black), add **\$57.29** to list
- T Std. Base Hard Two-Tone Casters (Grey)

Low Base

- 3 Low Base, Hard Casters (Black)
- 4 Low Base, Soft Casters (Black), add **\$57.29** to list

2) Seat surface material and color.
3) Back surface material and color.

4) Plastic trim color (frame and arm uprights).
TR-F Black
TR-7 Fog, add **\$92.13** list.
TR-UFM Snow, add **\$148.82** list.

5) Base color.
TR-F Black
TR-LE Metallic Silver
PM-P Polished Aluminum, add **\$135.06** list.

Specification Tips

- Ships standard assembled. Optional knocked down shipment comes in three pieces; assembly does not require tools.
- Lumbar color defaults based on trim color specified and is available in Black or Fog only.
–Black will be received if plastic trim color is Black.
–Fog will be received if Fog or Snow plastic trim is ordered.
- Reference color chart for applied backing material for cleanable upholstery back. Backer material determined by trim color.

Plastic Trim Color	Lumbar	Arm Caps	Backing Material for Cleanable Upholstered Back
TR-F Black	TR-F Black	TR-F Black	Wellington, Black XJ-BL
TR-7 Fog	TR-7 Fog	TR-7 Fog	Wellington, Steel XJ-SL
TR-UFM Snow	TR-7 Fog	TR-7 Fog	Wellington, Steel XJ-SL

Description	Number 1	Fabric Grade								
		A	B	C	D	E	F	G	H	
Upholstered Back, No Lumbar Adjustment										
Back Lock w/Fixed Seat	SJT-3C-701X	A	\$1268.85	\$1358.09	\$1453.75	\$1498.47	\$1536.69	\$1619.61	\$1696.13	\$1900.19
Back Lock w/Seat Depth Adjustment	SJT-3C-701A	A	1297.21	1386.45	1482.11	1526.83	1565.05	1647.97	1724.49	1928.55
Back Lock & Forward Tilt w/Seat Depth Adjustment	SJT-3C-704A	A	1348.28	1437.52	1533.18	1577.90	1616.12	1699.04	1775.56	1979.62
Upholstered Back, Lumbar Adjustment										
Back Lock w/Fixed Seat	SJT-3C-711X	A	\$1336.88	\$1426.12	\$1521.78	\$1566.50	\$1604.72	\$1687.64	\$1764.16	\$1968.22
Back Lock w/Seat Depth Adjustment	SJT-3C-711A	A	1365.24	1454.48	1550.14	1594.86	1633.08	1716.00	1792.52	1996.58
Back Lock & Forward Tilt w/Seat Depth Adjustment	SJT-3C-714A	A	1416.31	1505.55	1601.21	1645.93	1684.15	1767.07	1843.59	2047.65

The following options require modification of the product number.

Knocked Down Shipment

To specify, change the 11th digit from an A to K and deduct **\$42.52** list; **Example:** SJT-3C-701X1K

Task Seating — Soji – Cleanable+

Task Chair with Height Adjustable Arms — Plastic Base



SJT-3C-401X

Dimensions

- *SH: 16.4"-21.0"
(417mm-533mm)
- H: 39"-44"
(991mm-1118mm)
- D: 27"(686mm)
- W: 28"(711mm)
- *SW: 20"(508mm)
- *SD: 16.25"-18.75"
(413mm-476mm)
- *AH: 7.4"-11.4"
(188mm-290mm)

* All measurements taken with the BIFMA chair measuring device.

Features

- Seat and back must be faux leather for a fully cleanable chair.
- Inner Back / Seat: Customer specified faux leather.
- Backing material: Wellington Black or Steel as determined by trim color. See chart.
- Available as a fixed seat or with seat depth adjustment (2.5"(64mm) range).
- Base: Plastic five-star base.
- Arms: Height adjustable with 4"(102mm) range.
- Lumbar: Available with optional lumbar support with 3.5"(89mm) adjustment.
- Mechanism: Synchronized tilt; standard tilt tension adjustment.
- Height adjustment: Standard pneumatic.
- Back Lock: Standard single position upright back lock.
- Optional Forward Tilt: 5° downward from initial position. Only available on chairs with seat depth adjustment.
- Casters: Hard casters in black or two-tone grey; Soft casters black only.
- COM yardage: Seat: 0.62 / Back: 1.25

To Order, Specify:

1) Product number, including;

1 Caster Option:

- 5 Hard Casters (Black)
- 6 Soft Casters (Black), add \$57.29 to list
- 7 Hard Two-Tone Casters (Grey)

2) Seat surface material and color.

3) Back surface material and color.

4) Plastic trim color (frame and arm uprights).
TR-F Black
TR-7 Fog, add \$92.13 list.
TR-UFM Snow, add \$148.82 list.

5) Base color.
TR-F Black
TR-7 Fog

Plastic Trim Color	Lumbar	Arm Caps	Backing Material for Cleanable Upholstered Back
TR-F Black	TR-F Black	TR-F Black	Wellington, Black XJ-BL
TR-7 Fog	TR-7 Fog	TR-7 Fog	Wellington, Steel XJ-SL
TR-UFM Snow	TR-7 Fog	TR-7 Fog	Wellington, Steel XJ-SL

Specification Tips

- Ships standard assembled. Optional knocked down shipment comes in three pieces; assembly does not require tools.
- Lumbar color defaults based on trim color specified and is available in Black or Fog only.
–Black will be received if plastic trim color is Black.
–Fog will be received if Fog or Snow plastic trim is ordered.
- Reference color chart for applied backing material for cleanable upholstery back. Backer material determined by trim color.

Description	Number 1	Fabric Grade								
		A	B	C	D	E	F	G	H	
Upholstered Back, No Lumbar Adjustment										
Back Lock w/Fixed Seat	SJT-3C-401X	A	\$1154.16	\$1243.40	\$1339.06	\$1383.78	\$1422.00	\$1504.92	\$1581.44	\$1785.50
Back Lock w/Seat Depth Adjustment	SJT-3C-401A	A	1182.52	1271.76	1367.42	1412.14	1450.36	1533.28	1609.80	1813.86
Back Lock & Forward Tilt w/Seat Depth Adjustment	SJT-3C-404A	A	1233.59	1322.83	1418.49	1463.21	1501.43	1584.35	1660.87	1864.93
Upholstered Back, Lumbar Adjustment										
Back Lock w/Fixed Seat	SJT-3C-411X	A	\$1222.19	\$1311.43	\$1407.09	\$1451.81	\$1490.03	\$1572.95	\$1649.47	\$1853.53
Back Lock w/Seat Depth Adjustment	SJT-3C-411A	A	1250.55	1339.79	1435.45	1480.17	1518.39	1601.31	1677.83	1881.89
Back Lock & Forward Tilt w/Seat Depth Adjustment	SJT-3C-414A	A	1301.62	1390.86	1486.52	1531.24	1569.46	1652.38	1728.90	1932.96

The following options require modification of the product number.

Knocked Down Shipment

To specify, change the 11th digit from an A to K and deduct \$42.52 list; Example: SJT-3C-401X5K

Task Seating — Soji – Cleanable+

Task Chair with Height Adjustable Arms — Aluminum Base



SJT-3C-411X

Dimensions

- *SH: 16.4"-21.0"
(417mm-533mm)
- H: 39"-44"
(991mm-1118mm)
- D: 27"(686mm)
- W: 28"(711mm)
- *SW: 20"(508mm)
- *SD: 16.25"-18.75"
(413mm-476mm)
- *AH: 7.4"-11.4"
(188mm-290mm)

Low position seat height:
14.75"-17.5"
(375mm-445mm)

* All measurements taken with the BIFMA chair measuring device.

Features

- Seat and back must be faux leather for a fully cleanable chair.
- Inner Back / Seat: Customer specified faux leather.
- Backing material: Wellington Black or Steel as determined by trim color. See chart.
- Available as a fixed seat or with seat depth adjustment (2.5"(64mm) range).
- Base: Aluminum five-star base.
- Arms: Height adjustable with 4"(102mm) range.
- Lumbar: Available with optional lumbar support with 3.5"(89mm) adjustment.
- Mechanism: Synchronized tilt; standard tilt tension adjustment.
- Height adjustment: Standard pneumatic.
- Back Lock: Standard single position upright back lock.
- Optional Forward Tilt: 5° downward from initial position. Only available on chairs with seat depth adjustment.
- Casters: Hard casters in black or two-tone grey; Soft casters black only.
- COM yardage: Seat: 0.62 / Back: 1.25

Specification Tips

- Ships standard assembled. Optional knocked down shipment comes in three pieces; assembly does not require tools.
- Lumbar color defaults based on trim color specified and is available in Black or Fog only.
 - Black will be received if plastic trim color is Black.
 - Fog will be received if Fog or Snow plastic trim is ordered.
- Reference color chart for applied backing material for cleanable upholstery back. Backer material determined by trim color.

To Order, Specify:

1) Product number, including;

1) Caster Option: Standard Base

- 1** Std. Base Hard Casters (Black)
- 2** Std. Base Soft Casters (Black), add **\$57.29** to list
- T** Std. Base Hard Two-Tone Casters (Grey)

Low Base

- 3** Low Base, Hard Casters (Black)
- 4** Low Base, Soft Casters (Black), add **\$57.29** to list

2) Seat surface material and color.

3) Back surface material and color.

4) Plastic trim color (frame and arm uprights).
TR-F Black
TR-7 Fog, add **\$92.13** list.
TR-UFM Snow, add **\$148.82** list.

5) Base color.
TR-F Black
TR-LE Metallic Silver
PM-P Polished Aluminum, add **\$135.06** list.

Plastic Trim Color	Lumbar	Arm Caps	Backing Material for Cleanable Upholstered Back
TR-F Black	TR-F Black	TR-F Black	Wellington, Black XJ-BL
TR-7 Fog	TR-7 Fog	TR-7 Fog	Wellington, Steel XJ-SL
TR-UFM Snow	TR-7 Fog	TR-7 Fog	Wellington, Steel XJ-SL

Description	Number ¹	Fabric Grade								
		A	B	C	D	E	F	G	H	
Upholstered Back, No Lumbar Adjustment										
Back Lock w/Fixed Seat	SJT-3C-401X	A	\$1242.25	\$1331.49	\$1427.15	\$1471.87	\$1510.09	\$1593.01	\$1669.53	\$1873.59
Back Lock w/Seat Depth Adjustment	SJT-3C-401A	A	1270.61	1359.85	1455.51	1500.23	1538.45	1621.37	1697.89	1901.95
Back Lock & Forward Tilt w/Seat Depth Adjustment	SJT-3C-404A	A	1321.68	1410.92	1506.58	1551.30	1589.52	1672.44	1748.96	1953.02
Upholstered Back, Lumbar Adjustment										
Back Lock w/Fixed Seat	SJT-3C-411X	A	\$1310.28	\$1399.52	\$1495.18	\$1539.90	\$1578.12	\$1661.04	\$1737.56	\$1941.62
Back Lock w/Seat Depth Adjustment	SJT-3C-411A	A	1338.64	1427.88	1523.54	1568.26	1606.48	1689.40	1765.92	1969.98
Back Lock & Forward Tilt w/Seat Depth Adjustment	SJT-3C-414A	A	1389.71	1478.95	1574.61	1619.33	1657.55	1740.47	1816.99	2021.05

The following options require modification of the product number.

Knocked Down Shipment

To specify, change the 11th digit from an **A** to **K** and deduct **\$42.52** list; **Example:** SJT-3C-401X1K

Task Seating — Soji – Cleanable+

Task Chair with Fixed Arms — Plastic Base



SJT-3C-111A

Dimensions

- *SH: 16.4"-21.0"
(417mm-533mm)
- H: 39"-44"
(991mm-1118mm)
- D: 27"(686mm)
- W: 28"(711mm)
- *SW: 20"(508mm)
- *SD: 16.25"-18.75"
(413mm-476mm)
- *AH: 9"(229mm)

* All measurements taken with the BIFMA chair measuring device.

Features

- Seat and back must be faux leather for a fully cleanable chair.
- Inner Back / Seat: Customer specified faux leather.
- Backing material: Wellington Black or Steel as determined by trim color. See chart.
- Available as a fixed seat or with seat depth adjustment (2.5"(64mm) range).
- Base: Plastic five-star base.
- Arms: Fixed height.
- Lumbar: Available with optional lumbar support with 3.5"(89mm) adjustment.
- Mechanism: Synchronized tilt; standard tilt tension adjustment.
- Height adjustment: Standard pneumatic.
- Back Lock: Standard single position upright back lock.
- Optional Forward Tilt: 5° downward from initial position. Only available on chairs with seat depth adjustment.
- Casters: Hard casters in black or two-tone grey; Soft casters black only.
- COM yardage: Seat: 0.62 / Back: 1.25

To Order, Specify:

1) Product number, including;

1 Caster Option:

- 5 Hard Casters (Black)
- 6 Soft Casters (Black), add \$57.29 to list
- 7 Hard Two-Tone Casters (Grey)

2) Seat surface material and color.

3) Back surface material and color.

4) Plastic trim color (frame and arm uprights).
TR-F Black
TR-7 Fog, add \$92.13 list.
TR-UFM Snow, add \$148.82 list.

5) Base color.
TR-F Black
TR-7 Fog

Plastic Trim Color	Lumbar	Arm Caps	Backing Material for Cleanable Upholstered Back
TR-F Black	TR-F Black	TR-F Black	Wellington, Black XJ-BL
TR-7 Fog	TR-7 Fog	TR-7 Fog	Wellington, Steel XJ-SL
TR-UFM Snow	TR-7 Fog	TR-7 Fog	Wellington, Steel XJ-SL

Specification Tips

- Ships standard assembled. Optional knocked down shipment comes in three pieces; assembly does not require tools.
- Lumbar color defaults based on trim color specified and is available in Black or Fog only.
–Black will be received if plastic trim color is Black.
–Fog will be received if Fog or Snow plastic trim is ordered.
- Reference color chart for applied backing material for cleanable upholstery back. Backer material determined by trim color.

Description	Number 1	Fabric Grade								
		A	B	C	D	E	F	G	H	
Upholstered Back, No Lumbar Adjustment										
Back Lock w/Fixed Seat	SJT-3C-101X	A	\$1093.32	\$1182.56	\$1278.22	\$1322.94	\$1361.16	\$1444.08	\$1520.60	\$1724.66
Back Lock w/Seat Depth Adjustment	SJT-3C-101A	A	1121.68	1210.92	1306.58	1351.30	1389.52	1472.44	1548.96	1753.02
Back Lock & Forward Tilt w/Seat Depth Adjustment	SJT-3C-104A	A	1172.75	1261.99	1357.65	1402.37	1440.59	1523.51	1600.03	1804.09
Upholstered Back, Lumbar Adjustment										
Back Lock w/Fixed Seat	SJT-3C-111X	A	\$1161.35	\$1250.59	\$1346.25	\$1390.97	\$1429.19	\$1512.11	\$1588.63	\$1792.69
Back Lock w/Seat Depth Adjustment	SJT-3C-111A	A	1189.71	1278.95	1374.61	1419.33	1457.55	1540.47	1616.99	1821.05
Back Lock & Forward Tilt w/Seat Depth Adjustment	SJT-3C-114A	A	1240.78	1330.02	1425.68	1470.40	1508.62	1591.54	1668.06	1872.12

The following options require modification of the product number.

Knocked Down Shipment

To specify, change the 11th digit from an A to K and deduct \$42.52 list; Example: SJT-3C-101X5K

Task Seating — Soji – Cleanable+

Task Chair with Fixed Arms — Aluminum Base



SJT-3C-111A

Dimensions

- *SH: 16.4"-21.0"
(417mm-533mm)
- H: 39"-44"
(991mm-1118mm)
- D: 27"(686mm)
- W: 28"(711mm)
- *SW: 20"(508mm)
- *SD: 16.25"-18.75"
(413mm-476mm)
- *AH: 9"(229mm)

Low position seat height:
14.75"-17.5"
(375mm-445mm)

* All measurements taken with the BIFMA chair measuring device.

Features

- Seat and back must be faux leather for a fully cleanable chair.
- Inner Back / Seat: Customer specified faux leather.
- Backing material: Wellington Black or Steel as determined by trim color. See chart.
- Available as a fixed seat or with seat depth adjustment (3"(76mm) range).
- Base: Aluminum five-star base.
- Arms: Fixed height.
- Lumbar: Available with optional lumbar support with 3.5"(89mm) adjustment.
- Mechanism: Synchronized tilt; standard tilt tension adjustment.
- Height adjustment: Standard pneumatic.
- Back Lock: Standard single position upright back lock.
- Optional Forward Tilt: 5° downward from initial position. Only available on chairs with seat depth adjustment.
- Casters: Hard casters in black or two-tone grey; Soft casters black only.
- COM yardage: Seat: 0.62 / Back: 1.25

To Order, Specify:

1) Product number, including;

1) Caster Option: Standard Base

- 1** Std. Base Hard Casters (Black)
- 2** Std. Base Soft Casters (Black), add **\$57.29** to list
- T** Std. Base Hard Two-Tone Casters (Grey)

Low Base

- 3** Low Base, Hard Casters (Black)
- 4** Low Base, Soft Casters (Black), add **\$57.29** to list

2) Seat surface material and color.

3) Back surface material and color.

4) Plastic trim color (frame and arm uprights).
TR-F Black
TR-7 Fog, add **\$92.13** list.
TR-UFM Snow, add **\$148.82** list.

5) Base color.
TR-F Black
TR-LE Metallic Silver
PM-P Polished Aluminum, add **\$135.06** list.

Specification Tips

- Ships standard assembled. Optional knocked down shipment comes in three pieces; assembly does not require tools.
- Lumbar color defaults based on trim color specified and is available in Black or Fog only.
–Black will be received if plastic trim color is Black.
–Fog will be received if Fog or Snow plastic trim is ordered.
- Reference color chart for applied backing material for cleanable upholstery back. Backer material determined by trim color.

Plastic Trim Color	Lumbar	Arm Caps	Backing Material for Cleanable Upholstered Back
TR-F Black	TR-F Black	TR-F Black	Wellington, Black XJ-BL
TR-7 Fog	TR-7 Fog	TR-7 Fog	Wellington, Steel XJ-SL
TR-UFM Snow	TR-7 Fog	TR-7 Fog	Wellington, Steel XJ-SL

Description	Number ¹	Fabric Grade								
		A	B	C	D	E	F	G	H	
Upholstered Back, No Lumbar Adjustment										
Back Lock w/Fixed Seat	SJT-3C-101X	A	\$1181.41	\$1270.65	\$1366.31	\$1411.03	\$1449.25	\$1532.17	\$1608.69	\$1812.75
Back Lock w/Seat Depth Adjustment	SJT-3C-101A	A	1209.77	1299.01	1394.67	1439.39	1477.61	1560.53	1637.05	1841.11
Back Lock & Forward Tilt w/Seat Depth Adjustment	SJT-3C-104A	A	1260.84	1350.08	1445.74	1490.46	1528.68	1611.60	1688.12	1892.18
Upholstered Back, Lumbar Adjustment										
Back Lock w/Fixed Seat	SJT-3C-111X	A	\$1249.44	\$1338.68	\$1434.34	\$1479.06	\$1517.28	\$1600.20	\$1676.72	\$1880.78
Back Lock w/Seat Depth Adjustment	SJT-3C-111A	A	1277.80	1367.04	1462.70	1507.42	1545.64	1628.56	1705.08	1909.14
Back Lock & Forward Tilt w/Seat Depth Adjustment	SJT-3C-114A	A	1328.87	1418.11	1513.77	1558.49	1596.71	1679.63	1756.15	1960.21

The following options require modification of the product number.

Knocked Down Shipment

To specify, change the 11th digit from an **A** to **K** and deduct **\$42.52** list; **Example:** SJT-3C-101X1K

Task Seating — Soji – Cleanable+

Task Chair without Arms — Plastic Base



SJT-3C-011A

Dimensions

- *SH: 16.4"-21.0"
(417mm-533mm)
- H: 39"-44"
(991mm-1118mm)
- D: 27"(686mm)
- W: 28"(711mm)
- *SW: 20"(508mm)
- *SD: 16.25"-18.75"
(413mm-476mm)

* All measurements taken with the BIFMA chair measuring device.

Features

- Seat and back must be faux leather for a fully cleanable chair.
- Inner Back / Seat: Customer specified faux leather.
- Backing material: Wellington Black or Steel as determined by trim color. See chart.
- Available as a fixed seat or with seat depth adjustment (2.5"(64mm) range).
- Base: Plastic five-star base.
- Lumbar: Available with optional lumbar support with 3.5"(89mm) adjustment.
- Mechanism: Synchronized tilt; standard tilt tension adjustment.
- Height adjustment: Standard pneumatic.
- Back Lock: Standard single position upright back lock.
- Optional Forward Tilt: 5° downward from initial position. Only available on chairs with seat depth adjustment.
- Casters: Hard casters in black or two-tone grey; Soft casters black only.
- COM yardage: Seat: 0.62 / Back: 1.25

To Order, Specify:

- 1) Product number, including:
 - 1** **Caster Option:**
 - 5** Hard Casters (Black)
 - 6** Soft Casters (Black), add **\$57.29** to list
 - 7** Hard Two-Tone Casters (Grey)
- 2) Seat surface material and color.
- 3) Back surface material and color.
- 4) Plastic trim color (frame and arm uprights).
 - TR-F Black
 - TR-7 Fog, add **\$92.13** list.
 - TR-UFM Snow, add **\$148.82** list.
- 5) Base color.
 - TR-F Black
 - TR-7 Fog

Plastic Trim Color	Lumbar	Arm Caps	Backing Material for Cleanable Upholstered Back
TR-F Black	TR-F Black	TR-F Black	Wellington, Black XJ-BL
TR-7 Fog	TR-7 Fog	TR-7 Fog	Wellington, Steel XJ-SL
TR-UFM Snow	TR-7 Fog	TR-7 Fog	Wellington, Steel XJ-SL

Specification Tips

- Ships standard assembled. Optional knocked down shipment comes in three pieces; assembly does not require tools.
- Lumbar color defaults based on trim color specified and is available in Black or Fog only.
 - Black will be received if plastic trim color is Black.
 - Fog will be received if Fog or Snow plastic trim is ordered.
- Reference color chart for applied backing material for cleanable upholstery back. Backer material determined by trim color.

Description	Number 1	Fabric Grade								
		A	B	C	D	E	F	G	H	
Upholstered Back, No Lumbar Adjustment										
Back Lock w/Fixed Seat	SJT-3C-001X	A	\$1013.83	\$1103.07	\$1198.73	\$1243.45	\$1281.67	\$1364.59	\$1441.11	\$1645.17
Back Lock w/Seat Depth Adjustment	SJT-3C-001A	A	1042.19	1131.43	1227.09	1271.81	1310.03	1392.95	1469.47	1673.53
Back Lock & Forward Tilt w/Seat Depth Adjustment	SJT-3C-004A	A	1093.26	1182.50	1278.16	1322.88	1361.10	1444.02	1520.54	1724.60
Upholstered Back, Lumbar Adjustment										
Back Lock w/Fixed Seat	SJT-3C-011X	A	\$1081.86	\$1171.10	\$1266.76	\$1311.48	\$1349.70	\$1432.62	\$1509.14	\$1713.20
Back Lock w/Seat Depth Adjustment	SJT-3C-011A	A	1110.22	1199.46	1295.12	1339.84	1378.06	1460.98	1537.50	1741.56
Back Lock & Forward Tilt w/Seat Depth Adjustment	SJT-3C-014A	A	1161.29	1250.53	1346.19	1390.91	1429.13	1512.05	1588.57	1792.63

The following options require modification of the product number.

Knocked Down Shipment

To specify, change the 11th digit from an **A** to **K** and deduct **\$42.52** list; **Example:** SJT-3C-001X**K**

Task Seating — Soji – Cleanable+

Task Chair without Arms — Aluminum Base



SJT-3C-011A

Dimensions

- *SH: 16.4"-21.0"
(417mm-533mm)
- H: 39"-44"
(991mm-1118mm)
- D: 27"(686mm)
- W: 28"(711mm)
- *SW: 20"(508mm)
- *SD: 16.25"-18.75"
(413mm-476mm)

Low position seat height:
14.75"-17.5"
(375mm-445mm)

* All measurements taken with the BIFMA chair measuring device.

Features

- Seat and back must be faux leather for a fully cleanable chair.
- Inner Back / Seat: Customer specified faux leather.
- Backing material: Wellington Black or Steel as determined by trim color. See chart.
- Available as a fixed seat or with seat depth adjustment (2.5"(64mm) range).
- Base: Aluminum five-star base.
- Lumbar: Available with optional lumbar support with 3.5"(89mm) adjustment.
- Mechanism: Synchronized tilt; standard tilt tension adjustment.
- Height adjustment: Standard pneumatic.
- Back Lock: Standard single position upright back lock.
- Optional Forward Tilt: 5° downward from initial position. Only available on chairs with seat depth adjustment.
- Casters: Hard casters in black or two-tone grey; Soft casters black only.
- COM yardage: Seat: 0.62 / Back: 1.25

To Order, Specify:

1) Product number, including;

1) Caster Option: Standard Base

- 1** Std. Base Hard Casters (Black)
- 2** Std. Base Soft Casters (Black), add **\$57.29** to list
- T** Std. Base Hard Two-Tone Casters (Grey)

Low Base

- 3** Low Base, Hard Casters (Black)
- 4** Low Base, Soft Casters (Black), add **\$57.29** to list

2) Seat surface material and color.

3) Back surface material and color.

4) Plastic trim color (frame and arm uprights).
TR-F Black
TR-7 Fog, add **\$92.13** list.
TR-UFM Snow, add **\$148.82** list.

5) Base color.
TR-F Black
TR-LE Metallic Silver
PM-P Polished Aluminum, add **\$135.06** list.

Specification Tips

- Ships standard assembled. Optional knocked down shipment comes in three pieces; assembly does not require tools.
- Lumbar color defaults based on trim color specified and is available in Black or Fog only.
–Black will be received if plastic trim color is Black.
–Fog will be received if Fog or Snow plastic trim is ordered.
- Reference color chart for applied backing material for cleanable upholstery back. Backer material determined by trim color.

Plastic Trim Color	Lumbar	Arm Caps	Backing Material for Cleanable Upholstered Back
TR-F Black	TR-F Black	TR-F Black	Wellington, Black XJ-BL
TR-7 Fog	TR-7 Fog	TR-7 Fog	Wellington, Steel XJ-SL
TR-UFM Snow	TR-7 Fog	TR-7 Fog	Wellington, Steel XJ-SL

Description	Number 1	Fabric Grade								
		A	B	C	D	E	F	G	H	
Upholstered Back, No Lumbar Adjustment										
Back Lock w/Fixed Seat	SJT-3C-001X	A	\$1101.92	\$1191.16	\$1286.82	\$1331.54	\$1369.76	\$1452.68	\$1529.20	\$1733.26
Back Lock w/Seat Depth Adjustment	SJT-3C-001A	A	1130.28	1219.52	1315.18	1359.90	1398.12	1481.04	1557.56	1761.62
Back Lock & Forward Tilt w/Seat Depth Adjustment	SJT-3C-004A	A	1181.35	1270.59	1366.25	1410.97	1449.19	1532.11	1608.63	1812.69
Upholstered Back, Lumbar Adjustment										
Back Lock w/Fixed Seat	SJT-3C-011X	A	\$1169.95	\$1259.19	\$1354.85	\$1399.57	\$1437.79	\$1520.71	\$1597.23	\$1801.29
Back Lock w/Seat Depth Adjustment	SJT-3C-011A	A	1198.31	1287.55	1383.21	1427.93	1466.15	1549.07	1625.59	1829.65
Back Lock & Forward Tilt w/Seat Depth Adjustment	SJT-3C-014A	A	1249.38	1338.62	1434.28	1479.00	1517.22	1600.14	1676.66	1880.72

The following options require modification of the product number.

Knocked Down Shipment

To specify, change the 11th digit from an **A** to **K** and deduct **\$42.52** list; **Example:** SJT-3C-001X**K**

Task Seating — Soji – Cleanable+

Task Stool with 4D Arms — Plastic Base



SJTC-701X
SJTC-701A

Dimensions
 *SH: 22"-29.5"
 (559mm-749mm)
 H: 44.6"-52.5"
 (1133mm-1334mm)
 D: 27"(686mm)
 W: 28"(711mm)
 *SW: 20"(508mm)
 *SD: 16.25"-18.75"
 (413mm-476mm)
 *AH: 7.4"-11.4"
 (188mm-290mm)

* All measurements taken with the BIFMA chair measuring device.

Features

- Seat and back must be faux leather for a fully cleanable chair.
- Inner Back / Seat: Customer specified faux leather.
- Backing material: Wellington Black or Steel as determined by trim color. See chart.
- Available as a fixed seat or with seat depth adjustment (2.5"(64mm) range).
- Base: Plastic five-star base.
- Arms: 4D arms have height adjustment range of 4"(102mm). Arms move front to back, side to side and pivot in and out.
- Lumbar: Available with optional lumbar support with 3.5"(89mm) adjustment.
- Mechanism: Synchronized tilt; standard tilt tension adjustment.
- Height adjustment: Standard pneumatic.
- Back Lock: Standard single position upright back lock.
- Casters: Hard casters in black or two-tone grey; Soft casters black only.
- COM yardage: Seat: 0.62 / Back: 1.25

To Order, Specify:

- 1) Product number, including;
 - 1** **Caster Option:**
 - 5** Hard Casters (Black)
 - 6** Soft Casters (Black), add **\$57.29** to list
 - 7** Hard Two-Tone Casters (Grey)
- 2) Seat surface material and color.
- 3) Back surface material and color.
- 4) Plastic trim color (frame and arm uprights).
 - TR-F Black
 - TR-7 Fog, add **\$92.13** list.
 - TR-UFM Snow, add **\$148.82** list.
- 5) Base color.
 - TR-F Black
 - TR-7 Fog

Plastic Trim Color	Lumbar	Arm Caps	Backing Material for Cleanable Upholstered Back
TR-F Black	TR-F Black	TR-F Black	Wellington, Black XJ-BL
TR-7 Fog	TR-7 Fog	TR-7 Fog	Wellington, Steel XJ-SL
TR-UFM Snow	TR-7 Fog	TR-7 Fog	Wellington, Steel XJ-SL

Specification Tips

- Ships standard assembled.
- Lumbar color defaults based on trim color specified and is available in Black or Fog only.
 - Black will be received if plastic trim color is Black.
 - Fog will be received if Fog or Snow plastic trim is ordered.
- Reference color chart for applied backing material for cleanable upholstery back. Backer material determined by trim color.

Description	Number 1	Fabric Grade								
		A	B	C	D	E	F	G	H	
Upholstered Back, No Lumbar Adjustment										
Back Lock w/Fixed Seat	SJTC-3C-701X	A	\$1732.71	\$1821.95	\$1917.61	\$1962.33	\$2000.55	\$2083.47	\$2159.99	\$2364.05
Back Lock w/Seat Depth Adjustment	SJTC-3C-701A	A	1761.07	1850.31	1945.97	1990.69	2028.91	2111.83	2188.35	2392.41
Upholstered Back, Lumbar Adjustment										
Back Lock w/Fixed Seat	SJTC-3C-711X	A	\$1800.74	\$1889.98	\$1985.64	\$2030.36	\$2068.58	\$2151.50	\$2228.02	\$2432.08
Back Lock w/Seat Depth Adjustment	SJTC-3C-711A	A	1829.10	1918.34	2014.00	2058.72	2096.94	2179.86	2256.38	2460.44

Task Seating — Soji – Cleanable+

Task Stool with 4D Arms — Aluminum Base



SJTC-701X
SJTC-701A

Dimensions

- *SH: 22"-29.5"
(559mm-749mm)
- H: 44.6"-52.5"
(1133mm-1334mm)
- D: 27"(686mm)
- W: 28"(711mm)
- *SW: 20"(508mm)
- *SD: 16.25"-18.75"
(413mm-476mm)
- *AH: 7.4"-11.4"
(188mm-290mm)

* All measurements taken with the BIFMA chair measuring device.

Features

- Seat and back must be faux leather for a fully cleanable chair.
- Inner Back / Seat: Customer specified faux leather.
- Backing material: Wellington Black or Steel as determined by trim color. See chart.
- Available as a fixed seat or with seat depth adjustment (2.5"(64mm) range).
- Base: Aluminum five-star base.
- Arms: 4D arms have height adjustment range of 4"(102mm). Arms move front to back, side to side and pivot in and out.
- Lumbar: Available with optional lumbar support with 3.5"(89mm) adjustment.
- Mechanism: Synchronized tilt; standard tilt tension adjustment.
- Height adjustment: Standard pneumatic.
- Back Lock: Standard single position upright back lock.
- Casters: Hard casters in black or two-tone grey; Soft casters black only.
- COM yardage: Seat: 0.62 / Back: 1.25

To Order, Specify:

- 1) Product number, including;
 - 1** Caster Option: Standard Base
 - 1** Std. Base Hard Casters (Black)
 - 2** Std. Base Soft Casters (Black), add **\$57.29** to list
 - T** Std. Base Hard Two-Tone Casters (Grey)
- 2) Seat surface material and color.
- 3) Back surface material and color.
- 4) Plastic trim color (frame and arm uprights).
 - TR-F Black
 - TR-7 Fog, add **\$92.13** list.
 - TR-UFM Snow, add **\$148.82** list.
- 5) Base color.
 - TR-F Black
 - TR-LE Metallic Silver
 - PM-P Polished Aluminum, add **\$135.06** list.

Plastic Trim Color	Lumbar	Arm Caps	Backing Material for Cleanable Upholstered Back
TR-F Black	TR-F Black	TR-F Black	Wellington, Black XJ-BL
TR-7 Fog	TR-7 Fog	TR-7 Fog	Wellington, Steel XJ-SL
TR-UFM Snow	TR-7 Fog	TR-7 Fog	Wellington, Steel XJ-SL

Specification Tips

- Ships standard assembled.
- Lumbar color defaults based on trim color specified and is available in Black or Fog only.
 - Black will be received if plastic trim color is Black.
 - Fog will be received if Fog or Snow plastic trim is ordered.
- Reference color chart for applied backing material for cleanable upholstery back. Backer material determined by trim color.

Description	Number ¹	Fabric Grade							
		A	B	C	D	E	F	G	H
Upholstered Back, No Lumbar Adjustment									
Back Lock w/Fixed Seat	SJTC-3C-701X A	\$1820.80	\$1910.04	\$2005.70	\$2050.42	\$2088.64	\$2171.56	\$2248.08	\$2452.14
Back Lock w/Seat Depth Adjustment	SJTC-3C-701A A	1849.16	1938.40	2034.06	2078.78	2117.00	2199.92	2276.44	2480.50
Upholstered Back, Lumbar Adjustment									
Back Lock w/Fixed Seat	SJTC-3C-711X A	\$1888.83	\$1978.07	\$2073.73	\$2118.45	\$2156.67	\$2239.59	\$2316.11	\$2520.17
Back Lock w/Seat Depth Adjustment	SJTC-3C-711A A	1917.19	2006.43	2102.09	2146.81	2185.03	2267.95	2344.47	2548.53

Task Seating — Soji – Cleanable+

Task Stool with Height Adjustable Arms — Plastic Base



SJTC-401X
SJTC-401A

Dimensions

- *SH: 22"-29.5"
(559mm-749mm)
- H: 44.6"-52.5"
(1133mm-1334mm)
- D: 27"(686mm)
- W: 28"(711mm)
- *SW: 20"(508mm)
- *SD: 16.25"-18.75"
(413mm-476mm)
- *AH: 7.4"-11.4"
(188mm-290mm)

* All measurements taken with the BIFMA chair measuring device.

Features

- Seat and back must be faux leather for a fully cleanable chair.
- Inner Back / Seat: Customer specified faux leather.
- Backing material: Wellington Black or Steel as determined by trim color. See chart.
- Available as a fixed seat or with seat depth adjustment (2.5"(64mm) range).
- Base: Plastic five-star base.
- Arms: Height adjustable with 4"(102mm) range.
- Lumbar: Available with optional lumbar support with 3.5"(89mm) adjustment.
- Mechanism: Synchronized tilt; standard tilt tension adjustment.
- Height adjustment: Standard pneumatic.
- Back Lock: Standard single position upright back lock.
- Casters: Hard casters in black or two-tone grey; Soft casters black only.
- COM yardage: Seat: 0.62 / Back: 1.25

To Order, Specify:

1) Product number, including;

1 Caster Option:

- 5 Hard Casters (Black)
- 6 Soft Casters (Black), add \$57.29 to list
- 7 Hard Two-Tone Casters (Grey)

2) Seat surface material and color.

3) Back surface material and color.

4) Plastic trim color (frame and arm uprights).
TR-F Black
TR-7 Fog, add \$92.13 list.
TR-UFM Snow, add \$148.82 list.

5) Base color.
TR-F Black
TR-7 Fog

Plastic Trim Color	Lumbar	Arm Caps	Backing Material for Cleanable Upholstered Back
TR-F Black	TR-F Black	TR-F Black	Wellington, Black XJ-BL
TR-7 Fog	TR-7 Fog	TR-7 Fog	Wellington, Steel XJ-SL
TR-UFM Snow	TR-7 Fog	TR-7 Fog	Wellington, Steel XJ-SL

Specification Tips

- Ships standard assembled.
- Lumbar color defaults based on trim color specified and is available in Black or Fog only.
–Black will be received if plastic trim color is Black.
–Fog will be received if Fog or Snow plastic trim is ordered.
- Reference color chart for applied backing material for cleanable upholstery back. Backer material determined by trim color.

Description	Number	①	Fabric Grade							
			A	B	C	D	E	F	G	H
Upholstered Back, No Lumbar Adjustment										
Back Lock w/Fixed Seat	SJTC-3C-401X	A	\$1706.11	\$1795.35	\$1891.01	\$1935.73	\$1973.95	\$2056.87	\$2133.39	\$2337.45
Back Lock w/Seat Depth Adjustment	SJTC-3C-401A	A	1734.47	1823.71	1919.37	1964.09	2002.31	2085.23	2161.75	2365.81
Upholstered Back, Lumbar Adjustment										
Back Lock w/Fixed Seat	SJTC-3C-411X	A	\$1774.14	\$1863.38	\$1959.04	\$2003.76	\$2041.98	\$2124.90	\$2201.42	\$2405.48
Back Lock w/Seat Depth Adjustment	SJTC-3C-411A	A	1802.50	1891.74	1987.40	2032.12	2070.34	2153.26	2229.78	2433.84

Task Seating — Soji – Cleanable+

Task Stool with Height Adjustable Arms — Aluminum Base



SJTC-401X
SJTC-401A

Dimensions

- *SH: 22"-29.5"
(559mm-749mm)
- H: 44.6"-52.5"
(1133mm-1334mm)
- D: 27"(686mm)
- W: 28"(711mm)
- *SW: 20"(508mm)
- *SD: 16.25"-18.75"
(413mm-476mm)
- *AH: 7.4"-11.4"
(188mm-290mm)

* All measurements taken with the BIFMA chair measuring device.

Features

- Seat and back must be faux leather for a fully cleanable chair.
- Inner Back / Seat: Customer specified faux leather.
- Backing material: Wellington Black or Steel as determined by trim color. See chart.
- Available as a fixed seat or with seat depth adjustment (2.5"(64mm) range).
- Base: Aluminum five-star base.
- Arms: Height adjustable with 4"(102mm) range.
- Lumbar: Available with optional lumbar support with 3.5"(89mm) adjustment.
- Mechanism: Synchronized tilt; standard tilt tension adjustment.
- Height adjustment: Standard pneumatic.
- Back Lock: Standard single position upright back lock.
- Casters: Hard casters in black or two-tone grey; Soft casters black only.
- COM yardage: Seat: 0.62 / Back: 1.25

To Order, Specify:

- 1) Product number, including;
 - 1** Caster Option: Standard Base
 - 1** Std. Base Hard Casters (Black)
 - 2** Std. Base Soft Casters (Black), add **\$57.29** to list
 - T** Std. Base Hard Two-Tone Casters (Grey)
- 2) Seat surface material and color.
- 3) Back surface material and color.
- 4) Plastic trim color (frame and arm uprights).
 - TR-F Black
 - TR-7 Fog, add **\$92.13** list.
 - TR-UFM Snow, add **\$148.82** list.
- 5) Base color.
 - TR-F Black
 - TR-LE Metallic Silver
 - PM-P Polished Aluminum, add **\$135.06** list.

Plastic Trim Color	Lumbar	Arm Caps	Backing Material for Cleanable Upholstered Back
TR-F Black	TR-F Black	TR-F Black	Wellington, Black XJ-BL
TR-7 Fog	TR-7 Fog	TR-7 Fog	Wellington, Steel XJ-SL
TR-UFM Snow	TR-7 Fog	TR-7 Fog	Wellington, Steel XJ-SL

Specification Tips

- Ships standard assembled.
- Lumbar color defaults based on trim color specified and is available in Black or Fog only.
 - Black will be received if plastic trim color is Black.
 - Fog will be received if Fog or Snow plastic trim is ordered.
- Reference color chart for applied backing material for cleanable upholstery back. Backer material determined by trim color.

Description	Number ¹	Fabric Grade								
		A	B	C	D	E	F	G	H	
Upholstered Back, No Lumbar Adjustment										
Back Lock w/Fixed Seat	SJTC-3C-401X	A	\$1794.20	\$1883.44	\$1979.10	\$2023.82	\$2062.04	\$2144.96	\$2221.48	\$2425.54
Back Lock w/Seat Depth Adjustment	SJTC-3C-401A	A	1822.56	1911.80	2007.46	2052.18	2090.40	2173.32	2249.84	2453.90
Upholstered Back, Lumbar Adjustment										
Back Lock w/Fixed Seat	SJTC-3C-411X	A	\$1862.23	\$1951.47	\$2047.13	\$2091.85	\$2130.07	\$2212.99	\$2289.51	\$2493.57
Back Lock w/Seat Depth Adjustment	SJTC-3C-411A	A	1890.59	1979.83	2075.49	2120.21	2158.43	2241.35	2317.87	2521.93

Task Seating — Soji – Cleanable+

Task Stool with Fixed Arms — Plastic Base



SJTC-101X
SJTC-101A

Dimensions

- *SH: 22"-29.5"
(559mm-749mm)
- H: 44.6"-52.5"
(1133mm-1334mm)
- D: 27"(686mm)
- W: 28"(711mm)
- *SW: 20"(508mm)
- *SD: 16.25"-18.75"
(413mm-476mm)
- *AH: 9"(229mm)

* All measurements taken with the BIFMA chair measuring device.

Features

- Seat and back must be faux leather for a fully cleanable chair.
- Inner Back / Seat: Customer specified faux leather.
- Backing material: Wellington Black or Steel as determined by trim color. See chart.
- Available as a fixed seat or with seat depth adjustment (2.5"(64mm) range).
- Base: Plastic five-star base.
- Arms: Fixed height.
- Lumbar: Available with optional lumbar support with 3.5"(89mm) adjustment.
- Mechanism: Synchronized tilt; standard tilt tension adjustment.
- Height adjustment: Standard pneumatic.
- Back Lock: Standard single position upright back lock.
- Casters: Hard casters in black or two-tone grey; Soft casters black only.
- COM yardage: Seat: 0.62 / Back: 1.25

To Order, Specify:

- 1) Product number, including;
 - 1** **Caster Option:**
 - 5** Hard Casters (Black)
 - 6** Soft Casters (Black), add **\$57.29** to list
 - 7** Hard Two-Tone Casters (Grey)
- 2) Seat surface material and color.
- 3) Back surface material and color.
- 4) Plastic trim color (frame and arm uprights).
 - TR-F Black
 - TR-7 Fog, add **\$92.13** list.
 - TR-UFM Snow, add **\$148.82** list.
- 5) Base color.
 - TR-F Black
 - TR-7 Fog

Plastic Trim Color	Lumbar	Arm Caps	Backing Material for Cleanable Upholstered Back
TR-F Black	TR-F Black	TR-F Black	Wellington, Black XJ-BL
TR-7 Fog	TR-7 Fog	TR-7 Fog	Wellington, Steel XJ-SL
TR-UFM Snow	TR-7 Fog	TR-7 Fog	Wellington, Steel XJ-SL

Specification Tips

- Ships standard assembled.
- Lumbar color defaults based on trim color specified and is available in Black or Fog only.
 - Black will be received if plastic trim color is Black.
 - Fog will be received if Fog or Snow plastic trim is ordered.
- Reference color chart for applied backing material for cleanable upholstery back. Backer material determined by trim color.

Description	Number ¹	Fabric Grade							
		A	B	C	D	E	F	G	H
Upholstered Back, No Lumbar Adjustment									
Back Lock w/Fixed Seat	SJTC-3C-101X A	\$1645.27	\$1734.51	\$1830.17	\$1874.89	\$1913.11	\$1996.03	\$2072.55	\$2276.61
Back Lock w/Seat Depth Adjustment	SJTC-3C-101A A	1673.63	1762.87	1858.53	1903.25	1941.47	2024.39	2100.91	2304.97
Upholstered Back, Lumbar Adjustment									
Back Lock w/Fixed Seat	SJTC-3C-111X A	\$1713.30	\$1802.54	\$1898.20	\$1942.92	\$1981.14	\$2064.06	\$2140.58	\$2344.64
Back Lock w/Seat Depth Adjustment	SJTC-3C-111A A	1741.66	1830.90	1926.56	1971.28	2009.50	2092.42	2168.94	2373.00

Task Seating — Soji – Cleanable+

Task Stool with Fixed Arms — Aluminum Base



SJTC-101X
SJTC-101A

Dimensions

- *SH: 22"-29.5"
(559mm-749mm)
- H: 44.6"-52.5"
(1133mm-1334mm)
- D: 27"(686mm)
- W: 28"(711mm)
- *SW: 20"(508mm)
- *SD: 16.25"-18.75"
(413mm-476mm)
- *AH: 9"(229mm)

* All measurements taken with the BIFMA chair measuring device.

Features

- Seat and back must be faux leather for a fully cleanable chair.
- Inner Back / Seat: Customer specified faux leather.
- Backing material: Wellington Black or Steel as determined by trim color. See chart.
- Available as a fixed seat or with seat depth adjustment (3"(76mm) range).
- Base: Aluminum five-star base.
- Arms: Fixed height.
- Lumbar: Available with optional lumbar support with 3.5"(89mm) adjustment.
- Mechanism: Synchronized tilt; standard tilt tension adjustment.
- Height adjustment: Standard pneumatic.
- Back Lock: Standard single position upright back lock.
- Casters: Hard casters in black or two-tone grey; Soft casters black only.
- COM yardage: Seat: 0.62 / Back: 1.25

To Order, Specify:

- 1) Product number, including;
 - 1** Caster Option: Standard Base
 - 1** Std. Base Hard Casters (Black)
 - 2** Std. Base Soft Casters (Black), add **\$57.29** to list
 - T** Std. Base Hard Two-Tone Casters (Grey)
- 2) Seat surface material and color.
- 3) Back surface material and color.
- 4) Plastic trim color (frame and arm uprights).
 - TR-F Black
 - TR-7 Fog, add **\$92.13** list.
 - TR-UFM Snow, add **\$148.82** list.
- 5) Base color.
 - TR-F Black
 - TR-LE Metallic Silver
 - PM-P Polished Aluminum, add **\$135.06** list.

Plastic Trim Color	Lumbar	Arm Caps	Backing Material for Cleanable Upholstered Back
TR-F Black	TR-F Black	TR-F Black	Wellington, Black XJ-BL
TR-7 Fog	TR-7 Fog	TR-7 Fog	Wellington, Steel XJ-SL
TR-UFM Snow	TR-7 Fog	TR-7 Fog	Wellington, Steel XJ-SL

Specification Tips

- Ships standard assembled.
- Lumbar color defaults based on trim color specified and is available in Black or Fog only.
 - Black will be received if plastic trim color is Black.
 - Fog will be received if Fog or Snow plastic trim is ordered.
- Reference color chart for applied backing material for cleanable upholstery back. Backer material determined by trim color.

Description	Number ¹	Fabric Grade								
		A	B	C	D	E	F	G	H	
Upholstered Back, No Lumbar Adjustment										
Back Lock w/Fixed Seat	SJTC-3C-101X	A	\$1733.36	\$1822.60	\$1918.26	\$1962.98	\$2001.20	\$2084.12	\$2160.64	\$2364.70
Back Lock w/Seat Depth Adjustment	SJTC-3C-101A	A	1761.72	1850.96	1946.62	1991.34	2029.56	2112.48	2189.00	2393.06
Upholstered Back, Lumbar Adjustment										
Back Lock w/Fixed Seat	SJTC-3C-111X	A	\$1801.39	\$1890.63	\$1986.29	\$2031.01	\$2069.23	\$2152.15	\$2228.67	\$2432.73
Back Lock w/Seat Depth Adjustment	SJTC-3C-111A	A	1829.75	1918.99	2014.65	2059.37	2097.59	2180.51	2257.03	2461.09

Task Seating — Soji – Cleanable+

Task Stool without Arms — Plastic Base



SJTC-001X
SJTC-001A

Dimensions

- *SH: 22"-29.5"
(559mm-749mm)
- H: 44.6"-52.5"
(1133mm-1334mm)
- D: 27"(686mm)
- W: 28"(711mm)
- *SW: 20"(508mm)
- *SD: 16.25"-18.75"
(413mm-476mm)

* All measurements taken with the BIFMA chair measuring device.

Features

- Seat and back must be faux leather for a fully cleanable chair.
- Inner Back / Seat: Customer specified faux leather.
- Backing material: Wellington Black or Steel as determined by trim color. See chart.
- Available as a fixed seat or with seat depth adjustment (2.5"(64mm) range).
- Base: Plastic five-star base.
- Lumbar: Available with optional lumbar support with 3.5"(89mm) adjustment.
- Mechanism: Synchronized tilt; standard tilt tension adjustment.
- Height adjustment: Standard pneumatic.
- Back Lock: Standard single position upright back lock.
- Casters: Hard casters in black or two-tone grey; Soft casters black only.
- COM yardage: Seat: 0.62 / Back: 1.25

To Order, Specify:

- 1) Product number, including:
 - 1** **Caster Option:**
 - 5** Hard Casters (Black)
 - 6** Soft Casters (Black), add **\$57.29** to list
 - 7** Hard Two-Tone Casters (Grey)
- 2) Seat surface material and color.
- 3) Back surface material and color.
- 4) Plastic trim color (frame and arm uprights).
 - TR-F Black
 - TR-7 Fog, add **\$92.13** list.
 - TR-UFM Snow, add **\$148.82** list.
- 5) Base color.
 - TR-F Black
 - TR-7 Fog

Specification Tips

- Ships standard assembled.
- Lumbar color defaults based on trim color specified and is available in Black or Fog only.
 - Black will be received if plastic trim color is Black.
 - Fog will be received if Fog or Snow plastic trim is ordered.
- Reference color chart for applied backing material for cleanable upholstery back. Backer material determined by trim color.

Plastic Trim Color	Lumbar	Arm Caps	Backing Material for Cleanable Upholstered Back
TR-F Black	TR-F Black	TR-F Black	Wellington, Black XJ-BL
TR-7 Fog	TR-7 Fog	TR-7 Fog	Wellington, Steel XJ-SL
TR-UFM Snow	TR-7 Fog	TR-7 Fog	Wellington, Steel XJ-SL

Description	Number 1	Fabric Grade							
		A	B	C	D	E	F	G	H
Upholstered Back, No Lumbar Adjustment									
Back Lock w/Fixed Seat	SJTC-3C-001X A	\$1565.78	\$1655.02	\$1750.68	\$1795.40	\$1833.62	\$1916.54	\$1993.06	\$2197.12
Back Lock w/Seat Depth Adjustment	SJTC-3C-001A A	1594.14	1683.38	1779.04	1823.76	1861.98	1944.90	2021.42	2225.48
Upholstered Back, Lumbar Adjustment									
Back Lock w/Fixed Seat	SJTC-3C-011X A	\$1633.81	\$1723.05	\$1818.71	\$1863.43	\$1901.65	\$1984.57	\$2061.09	\$2265.15
Back Lock w/Seat Depth Adjustment	SJTC-3C-011A A	1662.17	1751.41	1847.07	1891.79	1930.01	2012.93	2089.45	2293.51

Task Seating — Soji – Cleanable+

Task Stool without Arms — Aluminum Base



SJTC-001X
SJTC-001A

Dimensions

- *SH: 22"-29.5"
(559mm-749mm)
- H: 44.6"-52.5"
(1133mm-1334mm)
- D: 27"(686mm)
- W: 28"(711mm)
- *SW: 20"(508mm)
- *SD: 16.25"-18.75"
(413mm-476mm)

* All measurements taken with the BIFMA chair measuring device.

Features

- Seat and back must be faux leather for a fully cleanable chair.
- Inner Back / Seat: Customer specified faux leather.
- Backing material: Wellington Black or Steel as determined by trim color. See chart.
- Available as a fixed seat or with seat depth adjustment (2.5"(64mm) range).
- Base: Aluminum five-star base.
- Lumbar: Available with optional lumbar support with 3.5"(89mm) adjustment.
- Mechanism: Synchronized tilt; standard tilt tension adjustment.
- Height adjustment: Standard pneumatic.
- Back Lock: Standard single position upright back lock.
- Casters: Hard casters in black or two-tone grey; Soft casters black only.
- COM yardage: Seat: 0.62 / Back: 1.25

To Order, Specify:

- 1) Product number, including;
 - 1** Caster Option: Standard Base
 - 1** Std. Base Hard Casters (Black)
 - 2** Std. Base Soft Casters (Black), add **\$57.29** to list
 - T** Std. Base Hard Two-Tone Casters (Grey)
- 2) Seat surface material and color.
- 3) Back surface material and color.
- 4) Plastic trim color (frame and arm uprights).
 - TR-F Black
 - TR-7 Fog, add **\$92.13** list.
 - TR-UFM Snow, add **\$148.82** list.
- 5) Base color.
 - TR-F Black
 - TR-LE Metallic Silver
 - PM-P Polished Aluminum, add **\$135.06** list.

Specification Tips

- Ships standard assembled.
- Lumbar color defaults based on trim color specified and is available in Black or Fog only.
 - Black will be received if plastic trim color is Black.
 - Fog will be received if Fog or Snow plastic trim is ordered.
- Reference color chart for applied backing material for cleanable upholstery back. Backer material determined by trim color.

Plastic Trim Color	Lumbar	Arm Caps	Backing Material for Cleanable Upholstered Back
TR-F Black	TR-F Black	TR-F Black	Wellington, Black XJ-BL
TR-7 Fog	TR-7 Fog	TR-7 Fog	Wellington, Steel XJ-SL
TR-UFM Snow	TR-7 Fog	TR-7 Fog	Wellington, Steel XJ-SL

Description	Number 1	Fabric Grade							
		A	B	C	D	E	F	G	H
Upholstered Back, No Lumbar Adjustment									
Back Lock w/Fixed Seat	SJTC-3C-001X <input type="checkbox"/> A	\$1653.87	\$1743.11	\$1838.77	\$1883.49	\$1921.71	\$2004.63	\$2081.15	\$2285.21
Back Lock w/Seat Depth Adjustment	SJTC-3C-001A <input type="checkbox"/> A	1682.23	1771.47	1867.13	1911.85	1950.07	2032.99	2109.51	2313.57
Upholstered Back, Lumbar Adjustment									
Back Lock w/Fixed Seat	SJTC-3C-011X <input type="checkbox"/> A	\$1721.90	\$1811.14	\$1906.80	\$1951.52	\$1989.74	\$2072.66	\$2149.18	\$2353.24
Back Lock w/Seat Depth Adjustment	SJTC-3C-011A <input type="checkbox"/> A	1750.26	1839.50	1935.16	1979.88	2018.10	2101.02	2177.54	2381.60

Task Seating

Zody LX At-A-Glance

Designer	ITO Design and Haworth Design Studio
Awards/Achievements	NeoCon Silver, Best of NeoCon, Seating: Ergonomic Desk/Task, June 2022, USA Metropolis Likes: Task Seating (winner) June 2022, USA Greenguard Gold Cradle to Cradle Certified Bronze

Zody LX A high-performing chair that blends science-based wellness and comfort with sustainability and international design.

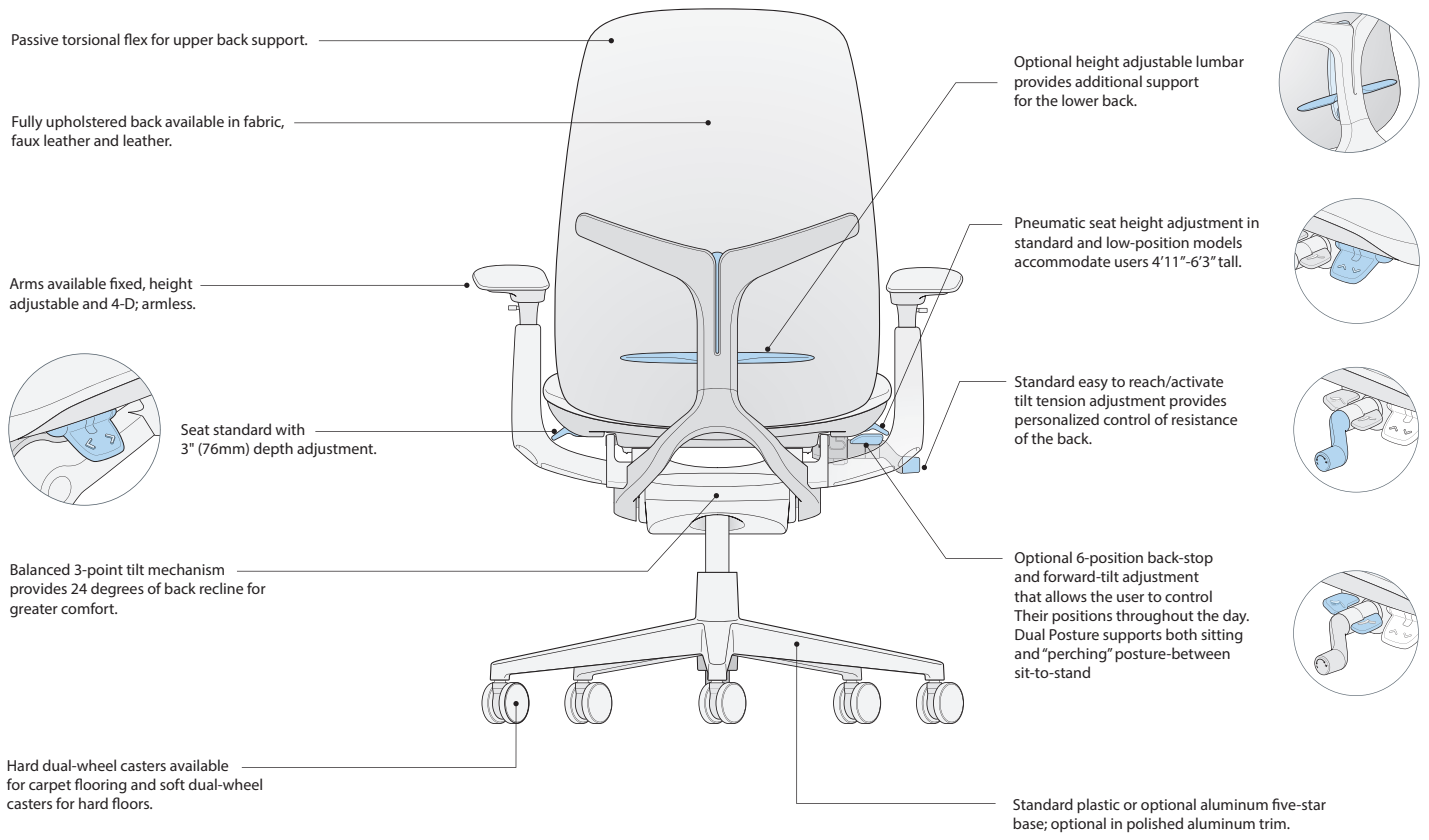

Note: Forward-tilt option not available on Stool.

Task Seating

Zody LX At-A-Glance

Environmental Factors	<ul style="list-style-type: none"> • Zody LX has been evaluated for its human health, environmental health, lifecycle attributes, renewable energy, water stewardship and social responsibility characteristics against stringent certification criteria and is considered an ecologically intelligent product. • Refer to Product Environmental Data sheet (PED) for recycled content and certifications. • Zody LX is produced in an ISO 14001 certified manufacturing facility. • Components are identified with ISO recycling symbols and material information to assist in the recycling effort, where practical. • Haworth will take back Zody LX chairs after their useful life and recycle the components. Please contact Haworth's Material Recovery Center at (616)393-1215.
COM & COL General Information	<p>To order a COM fabric (Customer's Own Material), contact the Haworth Inquiry Center (1.800.426.8562), your local Haworth dealer, or go to surfaces.haworth.com to find out if the COM you have selected has already been tested and approved. The surface collection site also has information on the Haworth alliance program with Carnegie, Luna Textiles, and Maharam as well as our industry-leading Pre-Approved COM program.</p> <p>COM fabrics are placed into Grades based on the cost per linear yard. If a fabric's cost exceeds the range of our highest Grade it will be noted as Non-Graded. The product will be priced at Grade A; the COM fabric costs will appear as a separate line item. The fabric charge will be Haworth's purchase cost plus a 4% administrative fee (based on the cost of the fabric). Yardage calculations will include any applicable fabric repeat.</p> <p>COM Leather products will be priced at a leather Grade A; COL costs will appear as a separate line item. The leather costs will be Haworth's purchase cost plus a 4% administrative fee (based on the cost of the leather).</p>
Finishes and Fabrics	For available finishes and fabrics please visit surfaces.haworth.com
Stain Repellent	<p>Stain Repellent or Stain Repellent with Moisture Barrier available on fabric surfaces only.</p> <p>Stain Repellent only: To specify add "P" to the end of the product number. Example: SZUC-22-731A5AP</p> <p>Stain Repellent with Moisture Barrier: To specify add "D" to the end of the product number. Example: SZUC-22-731A5AD</p>
Shipping Weights (Including packaging)	<ul style="list-style-type: none"> • Chairs with arms: 58 pounds/1 chair per carton/19.4 cubic feet • Chairs without arms: 52.6 pounds/1 chair per carton/19.4 cubic feet • Dual Posture with arms: 60.6 pounds/1 chair per carton/22.1 cubic feet • Dual Posture without arms: 55.2 pounds/1 chair per carton/22.1 cubic feet • Stool with arms: 61 pounds/1 stool per carton/22.1 cubic feet • Stool without arms: 55.6 pounds/1 stool per carton/22.1 cubic feet

Task Seating

Zody LX General Specifications

Balanced 3-point tilt



Features:

- Balanced 3-point tilt mechanism.
- Back reclines 24° from the upright position.
- Seat pan moves downward 3° from the initial position.

Benefits:

- Comfortable relaxed posture.
- Recline allows for the opening of the users' chest cavity providing good airflow to promote alertness.
- Users' feet remain flat.

Tilt Tension Control

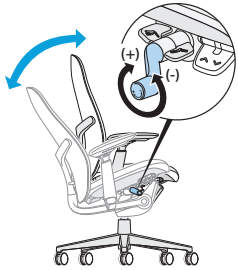

Feature:

- Easy-to-reach and easy-to-activate side-mounted tilt tension control regulates the amount of resistance felt when leaning back in the chair and the effort required to recline the chair backwards.

Benefit:

- Personalized support to accommodate users of different body types and different work styles.

Seat Height Adjustment

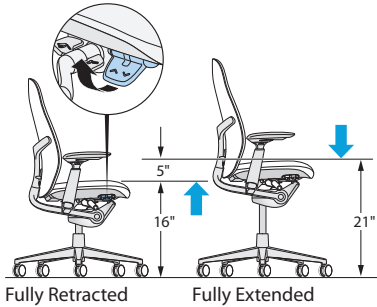

Features:

- Pneumatic seat height adjustment.
- Task chair seat height adjusts 5" (127mm) from 16" to 21" (406mm to 533mm) in standard models. Low-position adjusts 14.7" to 18" (373 to 457mm).
- Task stool seat height adjusts 7.3" (185mm) from 21" to 28.3" (533mm to 719mm).
- Dual Posture adjusts 17.5" to 24.2" (445mm to 615mm).

Benefits:

- Ensures the comfort of the lower limbs by avoiding pressure on the underside of the thigh caused by a seat pan that is too high, or decreased thigh-to-torso angle if the seat pan is too low.
- Accommodates for users between approximately 4'11" (1499mm) and 6'3" (1905mm) tall to provide good leg circulation.
- Seat height adjustment also is important in setting the proper hand position and allowing for a proper sitting eye height.

Seat Depth Adjustment

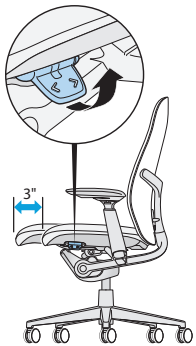

Features:

- 3" (76mm) of seat depth range.
- Waterfall edge.

Benefit:

- Supports the thighs, allows users to rest against the seat back for back support, and avoids pressure on the back of the knees of small to tall users.

Task Seating

Zody LX General Specifications

Lumbar

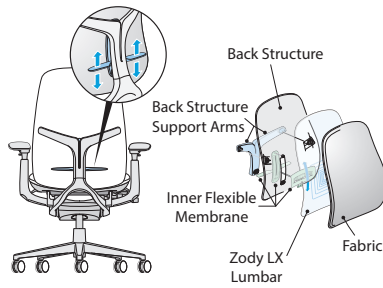

Features:

- Optional height adjustable lumbar.
- Range of 4”(102mm) of height adjustment.

Benefits:

- Lumbar adjustment maintains the natural curvature of the spine at the lower back and allows users to choose the support that feels right for them.

4D Arm

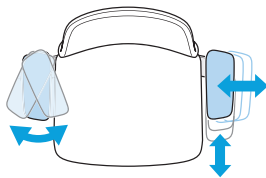

Features:

- Optional 4D arm.
- Arm adjusts in 4 ways:
 - Height adjustment: 4”(102mm)
 - Side-to-side arm cap adjustment range: 4”(102mm) [2”(51mm) each arm cap]
 - Front-to-back adjustment range: 2”(51mm)
 - Pivoting: In 20°; out 20°

Benefits:

- Arms support the muscular system of users’ neck and shoulders and proper arm support provides back relief. Arms can be an aid in standing or sitting down.
- Height adjustment accommodates for users with varying elbow rest heights so that users avoid lifting their shoulders or leaning sideways to get arm support.
- Front-to-back adjustment adjusts the armrest length, which is important because it allows users to get close to the worksurface while maintaining the effective use of the backrest.
- Side-to-side adjustment ensures a comfortable resting position for the arms with proper support of the forearm while allowing for easy entry/exit of the chair.
- Pivoting provides proper support of the forearm when performing tasks involving keying and mousing.

Adjustable Height Arm

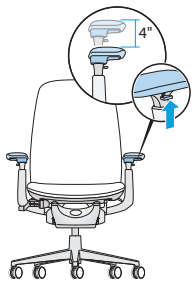

Feature:

- Optional height adjustable arms adjust 4”(102mm) vertically.

Benefit:

- Height adjustment accommodates users with varying elbow rest heights so that users avoid lifting their shoulders or leaning sideways to get arm support.

Back Stop

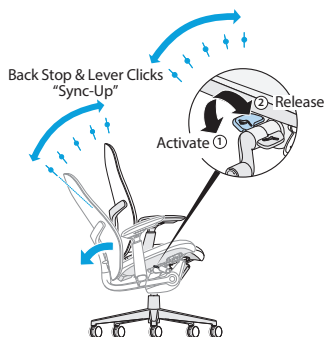

Features:

- Optional back stop;
- Back stops in 6 positions - upright and every 4° backward.

Benefit:

- Allows users the choice of selecting an upright position or limiting the amount of recline while performing different tasks.

Task Seating

Zody LX General Specifications

Back Stop/Forward Tilt

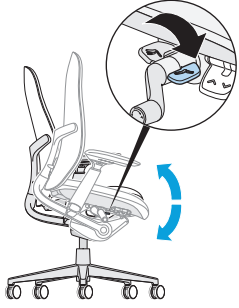

Feature:

- Optional back-stop and forward tilt.
- Back stops in 6 positions, upright and every 4° backward.
- Seat pan moves downward 5° from the initial position.

Benefits:

- Allows users to sit forward in the chair for task intensive work.
- Allows users to vary their posture for maximum comfort and for changes in task requirements.

Note: Not available on task stool.

Dual Posture

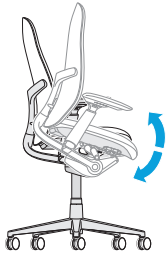

Features:

- Increased seat height range of 17.5”(445mm)-24.2”(615mm).
- Seat pan moves downward 5° from initial position with an increased degree of forward tilt.

Benefit:

- Promotes the in-between “perch” posture of sit-to-stand. Ideal for use with a height adjustable table.

Base

Standard Plastic Base

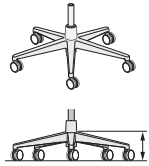

- TR-F Black
- TR-7 Fog

Note: When plastic base is specified all metal trim defaults to base color.

Hard casters in Black or Two-Tone Grey.
Soft casters in Black.

Optional Aluminum Base

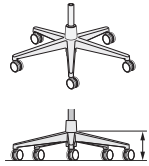

- TR-TF Pitch
- TR-LE Metallic Silver
- TR-MC Metallic Champagne
- TR-UFS Snowfall
- PM-P Polished Aluminum

Hard casters in Black, Two-Tone White or Two-Tone Grey.
Soft casters in Black.

Low Position Base (Aluminum only)

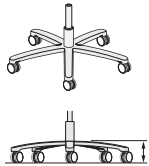

- TR-TF Pitch
- TR-LE Metallic Silver
- TR-MC Metallic Champagne
- TR-UFS Snowfall

Soft casters in Black.

Ergonomic Standards Guidelines

- All Zody LX models meet or exceed all ANSI/BIFMA durability standards for office seating.
- Zody LX meets the following ergonomic standards/guidelines:
 - BSR/HFES 100-2002
 - BIFMA G1-2002
 - CSA-Z412-2000
 - CAN/CGSB 44.232-2002
 - HFES 2007

Task Seating — Zody LX – Cleanable+

Task Chair



S2UC-33-0



S2UC-33-1



S2UC-33-4



S2UC-33-7

Dimensions*

- *SH: 16"-21"(406mm-533mm)
(Std. base)
14.7"-18"(373mm-457mm)
(Low base)
- H: 38.8"-43.8"(986mm-1113mm)
(Std. base)
37.5"-40.8"(953mm-1036mm)
(Low base)
- D: 29"(737mm)
- W: 29"(737mm)
- *SW: 19.5"(495mm)
- *SD: 16.4"-19.4"(417mm-493mm)
- *AH: 7.6"-11.6"(193mm-295mm)
(Height Adjustable and 4D)
8.5"(216mm) (Fixed)

* Measurements taken with ISO chair measuring device.

Features

- Back: Fully upholstered in faux leather.
- Seat: Upholstered in faux leather with 3"(76mm) adjustable seat depth range.
- Base options:
 - Plastic standard five-star base.
Casters: Hard casters in black or two-tone grey; Soft casters black only.
 - Aluminum standard five-star base.
Casters: Hard casters in black, two-tone white or two-tone grey; Soft casters black only.
 - Aluminum low-position five-star base.
Not available in PM-P Polished Aluminum.
Casters: Hard or soft casters in black only.
 - Aluminum base available on chairs with arms only.
Not available on armless chairs.
- Arm options:
 - No arms
 - Fixed arms
 - Height Adjustable; 4"(102mm) height adjustment range.
 - 4D; 4"(102mm) height adjustment, 4"(102mm) side-to-side range, 2"(51mm) front-to-back range and pivots 20° in and 20° out.
- Arm Cap will match plastic trim color (Black or Fog). When Snow is specified, arm cap will default to Fog.
- Height adjustment: Pneumatic or low-position pneumatic.
- Back Stop: Tilt stop in 6 positions.
- Back Stop/Forward Tilt; Tilt stop in 6 positions plus forward tilt 5° downward from initial position.
- Lumbar adjustment options:
 - No Lumbar
 - Height Adjustable Lumbar: 4"(102mm) height adjustment.
- COM yardage:
 - Back: 0.80
 - Seat: 0.75

Upcharge for mixed grade surfaces, refer to the electronic design and specification tools.

To Order, Specify:

- 1) Product number, including:

1 Base/Caster Option:

Plastic Base

- 5** Plastic Base, Hard Caster
- 6** Plastic Base, Soft Caster, add **\$60.74** list
- 7** Plastic Base, Two-Tone Grey Caster, add **\$23.33** list

Aluminum Base

- 1** Aluminum Base, Hard Caster, add **\$104.97** list
- 2** Aluminum Base, Soft Caster, add **\$165.71** list
- T** Aluminum Base, Two-Tone Grey Caster, add **\$128.30** list
- W** Aluminum Base, White Caster, add **\$128.30** list

Low Base - Aluminum

- 3** Aluminum Low Base, Hard Caster, add **\$104.97** list
- 4** Aluminum Low Base, Soft Caster, add **\$165.71** list

- 2) Seat upholstery.
- 3) Back upholstery.
- 4) Plastic trim color.¹
 - TR-F Black
 - TR-7 Fog, add **\$104.97** list
 - TR-UFM Snow,² add **\$174.95** list
- 5) Aluminum trim color.³
 - TR-TF Pitch
 - TR-LE Metallic Silver
 - TR-MC Metallic Champagne
 - TR-UFS Snowfall
 - PM-P Polished Aluminum
- 6) Base trim color.
 - Plastic
 - TR-F Black
 - TR-7 Fog, add **\$23.33** list
 - Aluminum
 - TR-TF Pitch
 - TR-LE Metallic Silver
 - TR-MC Metallic Champagne
 - TR-UFS Snowfall, add **\$23.33** list
 - PM-P Polished Aluminum, add **\$338.23** list

¹ Plastic trim color for Y-brace, arm caps, seat pan cover.

² When TR-UFM Snow trim is specified, arm cap and head rest will default to TR-7 Fog.

³ Aluminum trim color for back support, arm supports/uprights.

Task Seating — Zody LX – Cleanable+

Task Chair

Plastic Base* Adjustments	Arm	Number ①	Fabric Grade								
			A	B	C	D	E	F	G	H	
No Lumbar Adjustment											
Back Stop	No arm	S2UC-33-001A	A	\$1352.90	\$1439.37	\$1531.53	\$1577.69	\$1612.25	\$1695.85	\$1770.72	\$1975.34
	Fixed	S2UC-33-101A	A	1539.51	1625.98	1718.14	1764.30	1798.86	1882.46	1957.33	2161.95
	Height Adjustable	S2UC-33-401A	A	1586.16	1672.63	1764.79	1810.95	1845.51	1929.11	2003.98	2208.60
	4D	S2UC-33-701A	A	1625.81	1712.28	1804.44	1850.60	1885.16	1968.76	2043.63	2248.25
Back Stop/ Forward Tilt	No arm	S2UC-33-004A	A	1476.53	1563.00	1655.16	1701.32	1735.88	1819.48	1894.35	2098.97
	Fixed	S2UC-33-104A	A	1663.14	1749.61	1841.77	1887.93	1922.49	2006.09	2080.96	2285.58
	Height Adjustable	S2UC-33-404A	A	1709.79	1796.26	1888.42	1934.58	1969.14	2052.74	2127.61	2332.23
	4D	S2UC-33-704A	A	1749.44	1835.91	1928.07	1974.23	2008.79	2092.39	2167.26	2371.88
Height Adjustable Lumbar											
Back Stop	No arm	S2UC-33-031A	A	\$1466.03	\$1552.50	\$1644.66	\$1690.82	\$1725.38	\$1808.98	\$1883.85	\$2088.47
	Fixed	S2UC-33-131A	A	1652.64	1739.11	1831.27	1877.43	1911.99	1995.59	2070.46	2275.08
	Height Adjustable	S2UC-33-431A	A	1699.29	1785.76	1877.92	1924.08	1958.64	2042.24	2117.11	2321.73
	4D	S2UC-33-731A	A	1738.94	1825.41	1917.57	1963.73	1998.29	2081.89	2156.76	2361.38
Back Stop/ Forward Tilt	No arm	S2UC-33-034A	A	1589.66	1676.13	1768.29	1814.45	1849.01	1932.61	2007.48	2212.10
	Fixed	S2UC-33-134A	A	1776.27	1862.74	1954.90	2001.06	2035.62	2119.22	2194.09	2398.71
	Height Adjustable	S2UC-33-434A	A	1822.92	1909.39	2001.55	2047.71	2082.27	2165.87	2240.74	2445.36
	4D	S2UC-33-734A	A	1862.57	1949.04	2041.20	2087.36	2121.92	2205.52	2280.39	2485.01

* Pricing based on Plastic base with hard casters.

Task Seating — Zody LX – Cleanable+

Task Chair



S2US-33-0



S2US-33-1



S2US-33-4



S2US-33-7

Dimensions*

- *SH: 21"-28.3"(533mm-719mm)
- H: 43.8"-51.1"(1113mm-1298mm)
- D: 29"(737mm)
- W: 29"(737mm)
- *SW: 19.5"(495mm)
- *SD: 16.4"-19.4"(417mm-493mm)
- *AH: 7.6"-11.6"(193mm-295mm)
(Height Adjustable and 4D)
8.5"(216mm) (Fixed)

* Measurements taken with ISO chair measuring device.

Features

- Back: Fully upholstered in faux leather.
- Seat: Upholstered in faux leather with 3"(76mm) adjustable seat depth range.
- Base options:
 - Plastic standard five-star base.
Casters: Hard casters in black or two-tone grey; Soft casters black only.
 - Aluminum standard five-star base.
Casters: Hard casters in black, two-tone white or two-tone grey; Soft casters black only.
 - Aluminum base available on chairs with arms only. Not available on armless chairs.
- Arm options:
 - No arms
 - Fixed arms
 - Height Adjustable; 4"(102mm) height adjustment range.
 - 4D; 4"(102mm) height adjustment, 4"(102mm) side-to-side range, 2"(51mm) front-to-back range and pivots 20° in and 20° out.
- Arm Cap will match plastic trim color (Black or Fog). When Snow is specified, arm cap will default to Fog.
- Height adjustment: Pneumatic.
- Back Stop: Tilt stop in 6 positions.
- Lumbar adjustment options:
 - No Lumbar
 - Height Adjustable Lumbar: 4"(102mm) height adjustment.
- COM yardage:
 - Back: 0.80
 - Seat: 0.75

Upcharge for mixed grade surfaces, refer to the electronic design and specification tools.

To Order, Specify:

- 1) Product number, including:

1 Base/Caster Option:**Plastic Base**

- 5** Plastic Base, Hard Caster
- 6** Plastic Base, Soft Caster, add **\$60.74** list
- 7** Plastic Base, Two-Tone Grey Caster, add **\$23.33** list

Aluminum Base

- 1** Aluminum Base, Hard Caster, add **\$104.97** list
- 2** Aluminum Base, Soft Caster, add **\$165.71** list
- T** Aluminum Base, Two-Tone Grey Caster, add **\$128.30** list
- W** Aluminum Base, White Caster, add **\$128.30** list

- 2) Seat upholstery.
- 3) Back upholstery.
- 4) Plastic trim color.¹
 - TR-F Black
 - TR-7 Fog, add **\$104.97** list
 - TR-UFM Snow,² add **\$174.95** list
- 5) Aluminum trim color.³
 - TR-TF Pitch
 - TR-LE Metallic Silver
 - TR-MC Metallic Champagne
 - TR-UFS Snowfall
 - PM-P Polished Aluminum
- 6) Base trim color.
 - Plastic*
 - TR-F Black
 - TR-7 Fog, add **\$23.33** list
 - Aluminum*
 - TR-TF Pitch
 - TR-LE Metallic Silver
 - TR-MC Metallic Champagne
 - TR-UFS Snowfall, add **\$23.33** list
 - PM-P Polished Aluminum, add **\$338.23** list

¹ Plastic trim color for Y-brace, arm caps, seat pan cover.

² When TR-UFM Snow trim is specified, arm cap will default to TR-7 Fog.

³ Aluminum trim color for back support, arm supports/uprights.

Task Seating — Zody LX – Cleanable+

Task Stool

Plastic Base* Adjustments	Arm	Number ①	Fabric Grade								
			A	B	C	D	E	F	G	H	
No Lumbar Adjustment											
Back Stop	No arm	S2US-33-001A	A	\$1652.64	\$1739.11	\$1831.27	\$1877.43	\$1911.99	\$1995.59	\$2070.46	\$2275.08
	Fixed	S2US-33-101A	A	1839.25	1925.72	2017.88	2064.04	2098.60	2182.20	2257.07	2461.69
	Height Adjustable	S2US-33-401A	A	1885.90	1972.37	2064.53	2110.69	2145.25	2228.85	2303.72	2508.34
	4D	S2US-33-701A	A	1925.55	2012.02	2104.18	2150.34	2184.90	2268.50	2343.37	2547.99
Height Adjustable Lumbar											
Back Stop	No arm	S2US-33-031A	A	\$1765.77	\$1852.24	\$1944.40	\$1990.56	\$2025.12	\$2108.72	\$2183.59	\$2388.21
	Fixed	S2US-33-131A	A	1952.38	2038.85	2131.01	2177.17	2211.73	2295.33	2370.20	2574.82
	Height Adjustable	S2US-33-431A	A	1999.03	2085.50	2177.66	2223.82	2258.38	2341.98	2416.85	2621.47
	4D	S2US-33-731A	A	2038.68	2125.15	2217.31	2263.47	2298.03	2381.63	2456.50	2661.12

* Pricing based on Plastic base with hard casters.

Task Seating — Zody LX – Cleanable+

Dual Posture



S2UD-33-1



S2UD-33-4



S2UD-33-7

Dimensions*

- *SH: 17.5"-24.2"(445mm-615mm)
- H: 40.3"-47"(1024mm-1194mm)
- D: 29"(737mm)
- W: 29"(737mm)
- *SW: 19.5"(495mm)
- *SD: 16.4"-19.4"(417mm-493mm)
- *AH: 7.6"-11.6"(193mm-295mm)
(Height Adjustable and 4D)
8.5"(216mm) (Fixed)

* Measurements taken with ISO chair measuring device.

Features

- Back: Fully upholstered in faux leather.
- Seat: Upholstered in faux leather with 3"(76mm) adjustable seat depth range.
- Base options:
 - Aluminum standard five-star base.
 - Casters: Hard casters in black, two-tone white or two-tone grey; Soft casters black only.
- Arm options:
 - Fixed arms
 - Height Adjustable; 4"(102mm) height adjustment range.
 - 4D; 4"(102mm) height adjustment, 4"(102mm) side-to-side range, 2"(51mm) front-to-back range and pivots 20° in and 20° out.
- Arm Cap will match plastic trim color (Black or Fog). When Snow is specified, arm cap will default to Fog.
- Height adjustment: Pneumatic.
- Back Stop/Forward Tilt; Tilt stop in 6 positions plus forward tilt 5° downward from initial position.
- Lumbar adjustment options:
 - No Lumbar
 - Height Adjustable Lumbar: 4"(102mm) height adjustment.
- COM yardage:
 - Back: 0.80
 - Seat: 0.75

Upcharge for mixed grade surfaces, refer to the electronic design and specification tools.

To Order, Specify:

- 1) Product number, including:

1 Base/Caster Option:

Aluminum Base

- 1** Aluminum Base, Hard Caster
- 2** Aluminum Base, Soft Caster, add **\$165.71** list
- T** Aluminum Base, Two-Tone Grey Caster, add **\$128.30** list
- W** Aluminum Base, White Caster, add **\$128.30** list

- 2) Seat upholstery.
- 3) Back upholstery.
- 4) Plastic trim color.¹
 - TR-F Black
 - TR-7 Fog, add **\$104.97** list
 - TR-UFM Snow,² add **\$174.95** list
- 5) Aluminum trim color.³
 - TR-TF Pitch
 - TR-LE Metallic Silver
 - TR-MC Metallic Champagne
 - TR-UFS Snowfall
 - PM-P Polished Aluminum
- 6) Base trim color.
 - TR-TF Pitch
 - TR-LE Metallic Silver
 - TR-MC Metallic Champagne
 - TR-UFS Snowfall, add **\$23.33** list
 - PM-P Polished Aluminum, add **\$338.23** list

¹ Plastic trim color for Y-brace, arm caps, seat pan cover.

² When TR-UFM Snow trim is specified, arm cap will default to TR-7 Fog.

³ Aluminum trim color for back support, arm supports/uprights.

Task Seating — Zody LX – Cleanable+

Dual Posture

Adjustments	Arm	Number	①	Fabric Grade							
				A	B	C	D	E	F	G	H
No Lumbar Adjustment											
Back Stop/ Forward Tilt	Fixed	S2UD-33-104A	A	\$2001.37	\$2087.84	\$2180.00	\$2226.16	\$2260.72	\$2344.32	\$2419.19	\$2623.81
	Height Adjustable	S2UD-33-404A	A	2048.02	2134.49	2226.65	2272.81	2307.37	2390.97	2465.84	2670.46
	4D	S2UD-33-704A	A	2087.67	2174.14	2266.30	2312.46	2347.02	2430.62	2505.49	2710.11
Height Adjustable Lumbar Adjustment											
Back Stop/ Forward Tilt	Fixed	S2UD-33-134A	A	\$2114.50	\$2200.97	\$2293.13	\$2339.29	\$2373.85	\$2457.45	\$2532.32	\$2736.94
	Height Adjustable	S2UD-33-434A	A	2161.15	2247.62	2339.78	2385.94	2420.50	2504.10	2578.97	2783.59
	4D	S2UD-33-734A	A	2200.80	2287.27	2379.43	2425.59	2460.15	2543.75	2618.62	2823.24

Exam Room Seating

Description	Number	Price
Stools		
Pneumatic		
Stool	HE100-N	\$ 995.66
Stool with Footring	HE100-R	1214.48
Back Stool	HE101-N	1424.21
Back Stool with Footring	HE101-R	1643.03



HE105-N

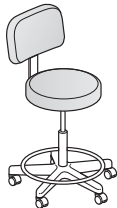

HE106-R

Features

- Seat: 16”(406mm) vacuum formed seamless seat.
- Base: Standard five star black plastic.
- Height Adjustment: Pneumatic or threaded.
 - Pneumatic adjusts from 17.25”(438mm) to 22.5”(572mm). Standard in black.
 - Threaded adjusts from 20.5”(521mm) to 28”(711mm). Standard in stainless steel.
- Casters: 2”(51mm) twin wheel carpet casters.
- Optional back and stainless steel footring available.
- Ships unassembled.

To Order, Specify:

- 1) Product number.
- 2) Seat/Back color.

Exam Room Seating

Maari

With Arms



S75-44-11



S75-24-11



S75-22-11

Dimensions

*SH: 16"-21"
(406mm-533mm)
H: 32"(813mm)
D: 28.5"(724mm)
W: 28.5"(724mm)
*SW: 18.5"(470mm)
*SD: 16.75"(425mm)
*AH: 8.5"(216mm)
Between Arms: 22"(559mm)

* All measurements taken with the BIFMA chair measuring device.

Features

- Seat: High-strength polymer shell with optional upholstered seat pad.
- Back: High-strength polymer shell with optional upholstered back pad.
- Base: Five-star height adjustable base with casters.
- Height adjustment range: 16"(406mm)-21"(533mm)
- Arm caps: Polypropylene.
- Casters: Hard casters will be color matched to the base. Soft casters available in Black only.
- Tablet option:
 - Tablet arm available right or left handed.
 - Dual-pivot tablet rotates 360° at both the arm's pivot joint and tablet surface connection point.
 - Tablet surface is 11.5"(292mm)D x 19"(483mm)W and 0.75"(19mm) thick.
 - Tablet surface available in painted MDF, laminate and wood in White Oak or Walnut.
- COM yardage / COL square footage:
 - Seat: 0.75/6.75
 - Back: 0.75/6.75

Specification Tips

- Tablet arm handedness can be changed in the field; however, tablet option cannot be added or removed in the field.
- Pivot arm/tablet will need to be field installed to the support arm.

To Order, Specify:

1) Product number, including:

1 Seat Surface:

- 1 Leather
- 2 Fabric
- 3 Faux Leather
- 4 Polymer

2 Back Surface:

- 1 Leather
- 2 Fabric
- 3 Faux Leather
- 4 Polymer

3 Caster Option:

- 1 Hard Casters
- 2 Soft Casters, add \$59.84 list

4 Tablet Option (if applicable):

- R Right Hand
- L Left Hand

- 2) Shell color (required for upholstered and non-upholstered).
- 3) Seat upholstery and color (if applicable).
- 4) Back upholstery and color (if applicable).
- 5) Base trim color.
Add \$78.35 list for Smooth Plaster & Matte finish.
- 6) Trim color for arm caps.
- 7) Tablet surface color (if applicable).
- 8) Tablet arm trim color (if applicable).
TR-F Black
TR-M1 Black Matte
TR-PLS Smooth Plaster
TR-M2 Smooth Plaster Matte

Tablet Description	Number	1 2 3 4				Price	Fabric Grade								Leather Grade A	Leather Grade B
		A	B	C	D		E	F	G	H						
Polymer Shell Without Optional Upholstered Pad																
No Tablet	S75-	4	4	-1		\$ 860.65	N/A	N/A	N/A	N/A	N/A	N/A	N/A	N/A	N/A	
Painted MDF	S75-	4	4	-1	P	1559.03	N/A	N/A	N/A	N/A	N/A	N/A	N/A	N/A	N/A	
Wood- White Oak	S75-	4	4	-1	W	2510.79	N/A	N/A	N/A	N/A	N/A	N/A	N/A	N/A	N/A	
Wood - Walnut	S75-	4	4	-1	W	2578.78	N/A	N/A	N/A	N/A	N/A	N/A	N/A	N/A	N/A	
Polymer Shell With Upholstered Seat Pad																
No Tablet	S75-	4	4	-1		N/A	\$1025.88	\$1049.29	\$1060.31	\$1085.11	\$1101.64	\$1177.38	\$1225.57	\$1304.07	\$1185.61	\$1385.31
Painted MDF	S75-	4	4	-1	P	N/A	1724.26	1747.67	1758.69	1783.49	1800.02	1875.76	1923.95	2002.45	1883.99	2083.69
Wood- White Oak	S75-	4	4	-1	W	N/A	2676.02	2699.43	2710.45	2735.25	2751.78	2827.52	2875.71	2954.21	2835.75	3035.45
Wood - Walnut	S75-	4	4	-1	W	N/A	2744.01	2767.42	2778.44	2803.24	2819.77	2895.51	2943.70	3022.20	2903.74	3103.44
Polymer Shell With Upholstered Seat and Back Pads																
No Tablet	S75-	4	4	-1		N/A	\$1191.11	\$1237.93	\$1259.97	\$1309.57	\$1342.63	\$1494.11	\$1590.49	\$1747.49	\$1510.57	\$1909.97
Painted MDF	S75-	4	4	-1	P	N/A	1889.49	1936.31	1958.35	2007.95	2041.01	2192.49	2288.87	2445.87	2208.95	2608.35
Wood- White Oak	S75-	4	4	-1	W	N/A	2841.25	2888.07	2910.11	2959.71	2992.77	3144.25	3240.63	3397.63	3160.71	3560.11
Wood - Walnut	S75-	4	4	-1	W	N/A	2909.24	2956.06	2978.10	3027.70	3060.76	3212.24	3308.62	3465.62	3228.70	3628.10

Exam Room Seating

Maari — Five-Star Base Chair

Without Arms



S75-44-01



S75-24-01



S75-22-01

Dimensions

- *SH: 16"-21"
(406mm-533mm)
- H: 32"(813mm)
- D: 28.5"(724mm)
- W: 28.5"(724mm)
- *SW: 18.5"(470mm)
- *SD: 16.75"(425mm)

* All measurements taken with the BIFMA chair measuring device.

Features

- Seat: High-strength polymer shell with optional upholstered seat pad.
- Back: High-strength polymer shell with optional upholstered back pad.
- Base: Five-star height adjustable base with casters.
- Height adjustment range: 16"(406mm)-21"(533mm)
- Casters: Hard casters will be color matched to the base. Soft casters available in Black only.
- Tablet option:
 - Tablet arm available right or left handed.
 - Dual-pivot tablet rotates 360° at both the arm's pivot joint and tablet surface connection point.
 - Tablet surface is 11.5"(292mm)D x 19"(483mm)W and 0.75"(19mm) thick.
 - Tablet surface available in painted MDF, laminate and wood in White Oak or Walnut.
- COM yardage / COL square footage:
 - Seat: 0.75/6.75
 - Back: 0.75/6.75

Specification Tips

- Tablet arm handedness can be changed in the field; however, tablet option cannot be added or removed in the field.
- Pivot arm/tablet will need to be field installed to the support arm.

To Order, Specify:

1) Product number, including:

1 Seat Surface:

- 1 Leather
- 2 Fabric
- 3 Faux Leather
- 4 Polymer

2 Back Surface:

- 1 Leather
- 2 Fabric
- 3 Faux Leather
- 4 Polymer

3 Caster Option:

- 1 Hard Casters
- 2 Soft Casters, add **\$59.84** list

4 Tablet Option (if applicable):

- R Right Hand
- L Left Hand

- 2) Shell color (required for upholstered and non-upholstered).
- 3) Seat upholstery and color (if applicable).
- 4) Back upholstery and color (if applicable).
- 5) Base trim color.
Add **\$78.35** list for Smooth Plaster & Matte finish.
- 6) Tablet surface color (if applicable).
- 7) Tablet arm trim color (if applicable).
TR-F Black
TR-M1 Black Matte
TR-PLS Smooth Plaster
TR-M2 Smooth Plaster Matte

Tablet Description	Number	① ② ③ ④				Price	Fabric Grade								Leather Grade A	Leather Grade B
		A	B	C	D		E	F	G	H						
Polymer Shell Without Optional Upholstered Pad																
No Tablet	S75-	4	4	-0	\$ 771.14	N/A	N/A	N/A	N/A	N/A	N/A	N/A	N/A	N/A	N/A	
Painted MDF	S75-	4	4	-0	1469.52	N/A	N/A	N/A	N/A	N/A	N/A	N/A	N/A	N/A	N/A	
Wood - White Oak	S75-	4	4	-0	2421.28	N/A	N/A	N/A	N/A	N/A	N/A	N/A	N/A	N/A	N/A	
Wood - Walnut	S75-	4	4	-0	2489.27	N/A	N/A	N/A	N/A	N/A	N/A	N/A	N/A	N/A	N/A	
Polymer Shell With Upholstered Seat Pad																
No Tablet	S75-	4	4	-0	N/A	\$ 936.37	\$ 959.78	\$ 970.80	\$ 995.60	\$1012.13	\$1087.87	\$1136.06	\$1214.56	\$1096.10	\$1295.80	
Painted MDF	S75-	4	4	-0	N/A	1634.75	1658.16	1669.18	1693.98	1710.51	1786.25	1834.44	1912.94	1794.48	1994.18	
Wood - White Oak	S75-	4	4	-0	N/A	2586.51	2609.92	2620.94	2645.74	2662.27	2738.01	2786.20	2864.70	2746.24	2945.94	
Wood - Walnut	S75-	4	4	-0	N/A	2654.50	2677.91	2688.93	2713.73	2730.26	2806.00	2854.19	2932.69	2814.23	3013.93	
Polymer Shell With Upholstered Seat and Back Pads																
No Tablet	S75-	4	4	-0	N/A	\$1101.60	\$1148.42	\$1170.46	\$1220.06	\$1253.12	\$1404.60	\$1500.98	\$1657.98	\$1421.06	\$1820.46	
Painted MDF	S75-	4	4	-0	N/A	1799.98	1846.80	1868.84	1918.44	1951.50	2102.98	2199.36	2356.36	2119.44	2518.84	
Wood - White Oak	S75-	4	4	-0	N/A	2751.74	2798.56	2820.60	2870.20	2903.26	3054.74	3151.12	3308.12	3071.20	3470.60	
Wood - Walnut	S75-	4	4	-0	N/A	2819.73	2866.55	2888.59	2938.19	2971.25	3122.73	3219.11	3376.11	3139.19	3538.59	

Patient Room

Recliner Options At-A-Glance - Benson Collection

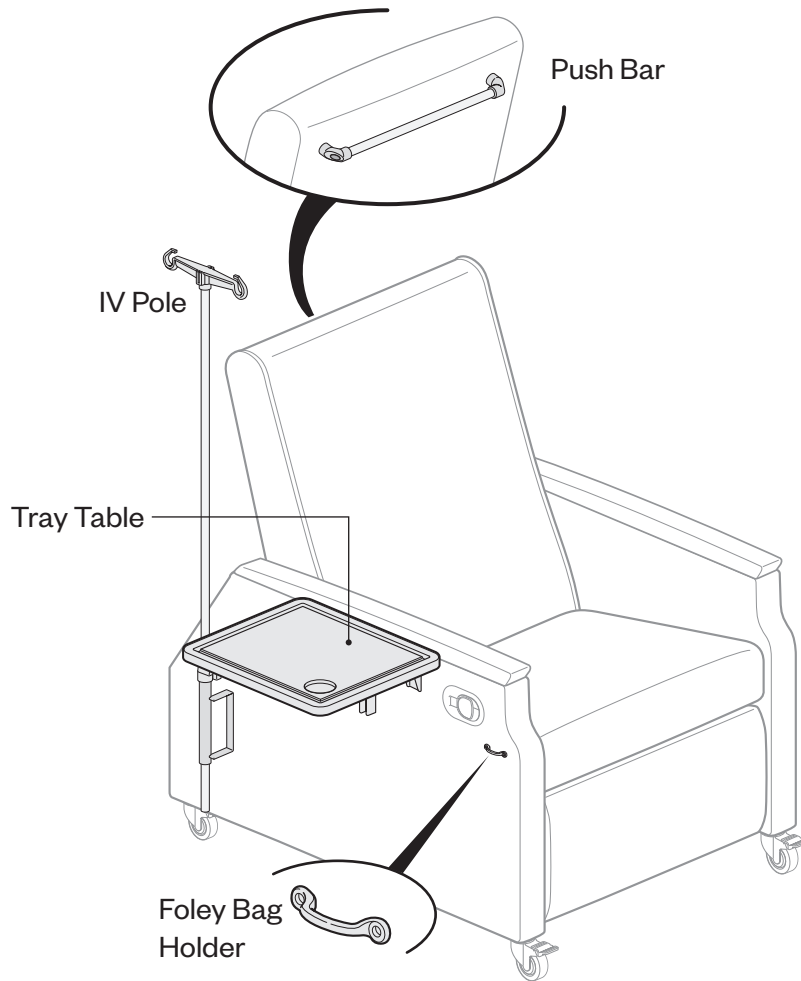

Patient Room Recliners — Benson Collection

Three Position Wall-Saver Recliner

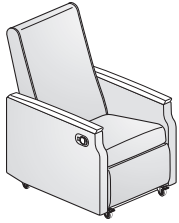

BNWR

Dimensions

- SH: 18.5"(470mm)
- AH: 25.5"(648mm)
- TH: 42.5"(1080mm)
- SD: 23"(584mm)
- TD: 37"(940mm)
- SW: 22"(559mm)
- TW: 28"(711mm)

Features

- Includes: Three position fully upholstered reclining chair on casters.
- Arms: Upholstered arms or upholstered arms with polyurethane or wood arm caps.
- Polyurethane arm caps standard in black.
- Casters: Non-marring rear swivel and front fixed locking casters.
- Three positions include: Fully closed, leg rest elevated only, and leg rest activated with back reclined.
- Wall-saver back recline mechanism is weight activated.
- Leg rest operated by right-hand actuator.
- Available accessory options include:
 - Left-hand folding tray table; charcoal gray with integrated cup holder and spill guard edge. Weight capacity 44 lbs.
 - Left- or right-hand front Foley bag holder; black
 - Left- or right-hand IV pole; aluminum, height adjustable charcoal gray plastic hooks
 - Left-hand folding tray table/Foley bag holder combination
 - Left-hand folding tray table/IV pole combination
 - Left- or right-hand Foley bag holder/IV pole combination
 - Left-hand folding tray table/Foley bag holder/IV pole combination
- Handedness determined from a seated position.
- COM yardage:
 - Seat, front panel: 2
 - Back and arms: 5

Upcharge for mixed grade fabric surfaces, refer to the electronic design and specification tools.

To Order, Specify:

1) Product number, including:

1 Seat & Front Panel

- 2 Fabric
- 3 Faux Leather

2 Back & Arms

- 2 Fabric
- 3 Faux Leather

3 Left-Hand Accessories

- 0 None
- 1 Folding Tray Table, add **\$764.01** list
- 2 Front Foley Bag Holder, add **\$283.52** list
- 3 IV Pole, add **\$634.19** list
- 4 Folding Tray Table & Foley Bag Holder, add **\$1047.53** list
- 5 Folding Tray Table & IV Pole, add **\$1398.20** list
- 6 Foley Bag Holder & IV Pole, add **\$917.71** list
- 7 Folding Tray Table, Foley Bag Holder & IV Pole, add **\$1681.73** list

4 Right-Hand Accessories

- 0 None
- 2 Front Foley Bag Holder, add **\$283.52** list
- 3 IV Pole, add **\$634.19** list
- 6 Foley Bag Holder & IV Pole, add **\$917.71** list

- 2) Seat & front panel surface and color.
- 3) Back & arms surface and color.
- 4) Arm Cap surface and color (if applicable)
 - Polyurethane -
 - TR-F Black
 - Wood -
 - M2-N Natural Maple
 - M2-W33 Carmel on Maple
 - M2-W15 Espresso on Maple
 - M2-W32 Pacific on Maple

Arm Cap	Number				Fabric Grade								
	1	2	3	4	A	B	C	D	E	F	G	H	
No Arm Cap	BNWR-	■	S-	■	NS	\$5539.10	\$6016.61	\$6188.21	\$6374.74	\$6688.11	\$7001.47	\$7353.63	\$7650.58
Polyurethane	BNWR-	■	S-	■	PS	6012.13	6489.64	6661.24	6847.77	7161.14	7474.50	7826.66	8123.61
Wood	BNWR-	■	S-	■	WS	6080.77	6558.28	6729.88	6916.41	7229.78	7543.14	7895.30	8192.25

Patient Room

Recliners — Benson Collection

Three Position Glider Recliner

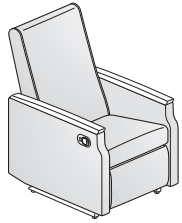

BNGR

Dimensions

- SH: 18.5"(470mm)
- AH: 25.5"(648mm)
- TH: 42.5"(1080mm)
- SD: 23"(584mm)
- TD: 37"(940mm)
- SW: 22"(559mm)
- TW: 28"(711mm)

Features

- Includes: Three position fully upholstered reclining chair on a fixed metal base.
- Arms: Upholstered arms or upholstered arms with polyurethane or wood arm caps.
- Polyurethane arm caps standard in black.
- Three positions include: Fully closed, leg rest elevated only, and leg rest activated with back reclined.
- Back recline mechanism is weight activated.
- Leg rest operated by right-hand actuator.
- Handedness determined from a seated position.
- Accessories not available.
- COM yardage:
Seat, front panel: 2
Back and arms: 5

Upcharge for mixed grade fabric surfaces, refer to the electronic design and specification tools.

To Order, Specify:

1) Product number, including:

① Seat & Front Panel

- 2 Fabric
- 3 Faux Leather

② Back & Arms

- 2 Fabric
- 3 Faux Leather

2) Seat & front panel surface and color.

3) Back & arms surface and color.

4) Arm Cap surface and color (if applicable)

- Polyurethane -
- TR-F Black
- Wood -
- M2-N Natural Maple
- M2-W33 Carmel on Maple
- M2-W15 Espresso on Maple
- M2-W32 Pacific on Maple

Arm Cap	Number ① ②	Fabric Grade								
			A	B	C	D	E	F	G	H
No Arm Cap	BNGR- ■ S-00NG	\$5655.49	\$6128.52	\$6303.11	\$6489.64	\$6803.00	\$7116.37	\$7468.53	\$7765.48	
Polyurethane	BNGR- ■ S-00PG	6128.52	6601.55	6776.14	6962.67	7276.03	7589.40	7941.56	8238.51	
Wood	BNGR- ■ S-00WG	6197.16	6670.19	6844.78	7031.31	7344.67	7658.04	8010.20	8307.15	

Patient Room Recliners — Benson Collection

Bariatric Recliner - Standard Arms

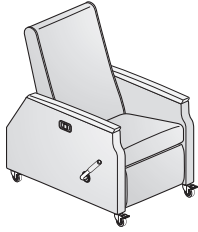

BNBR-22-S

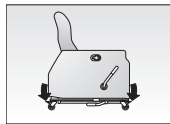

Casters

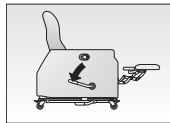

To Raise Footrest

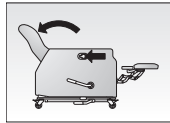

To Recline Back

Dimensions

- SH: 20"(508mm)
- AH: 27"(686mm)
- TH: 42.5"(1080mm)
- SD: 21"(533mm)
- TD: 39"(991mm)
- SW: 28"(711mm)
- TW: 37.5"(953mm)

Features

- Includes: Infinite position fully upholstered reclining chair on casters.
- Arms: Upholstered arms or upholstered arms with polyurethane or wood arm caps.
- Polyurethane arm caps standard in black.
- Casters: 3" rubber swivel or central locking casters.
- Central locking casters have a three position pedal; unlocked, total lock, or front caster directional lock only.
- Infinite position reclining system up to 45°.
- Leg rest operated by right-hand lever.
- Back activated by right-hand actuator.
- Available accessory options include:
 - Left-hand folding tray table; charcoal gray with integrated cup holder and spill guard edge. Weight capacity 44 lbs.
 - Left- or right-hand front Foley bag holder; nickel plated
 - Left- or right-hand IV pole; aluminum, height adjustable charcoal gray plastic hooks
 - Left-hand folding tray table/Foley bag holder combination
 - Left-hand folding tray table/IV pole combination
 - Left- or right-hand Foley bag holder/IV pole combination
 - Left-hand folding tray table/Foley bag holder/IV pole combination
 - Push Bar; stainless steel
- Handedness determined from a seated position.
- COM yardage:
 - Seat, front panel: 3
 - Back and arms: 6

Specification Tip

- Right-hand IV pole can not be specified with central locking casters.
- Upcharge for mixed grade fabric surfaces, refer to the electronic design and specification tools.

To Order, Specify:

- 1) Product number, including:

1 Seat & Front Panel

- 2 Fabric
- 3 Faux Leather

2 Back & Arms

- 2 Fabric
- 3 Faux Leather

3 Left-Hand Accessories

- 0 None
- 1 Folding Tray Table, add \$661.05 list
- 2 Front Foley Bag Holder, add \$249.20 list
- 3 IV Pole, add \$552.12 list
- 4 Folding Tray Table & Foley Bag Holder, add \$910.25 list
- 5 Folding Tray Table & IV Pole, add \$1213.17 list
- 6 Foley Bag Holder & IV Pole, add \$801.32 list
- 7 Folding Tray Table, Foley Bag Holder & IV Pole, add \$1462.37 list

4 Right-Hand Accessories

- 0 None
- 2 Front Foley Bag Holder, add \$249.20 list
- 3 IV Pole, add \$552.12 list
- 6 Foley Bag Holder & IV Pole, add \$801.32 list

- 2) Seat & front panel surface and color.
- 3) Back & arms surface and color.
- 4) Arm Cap surface and color (if applicable)
 - Polyurethane -
 - TR-F Black
 - Wood -
 - M2-N Natural Maple
 - M2-W33 Carmel on Maple
 - M2-W15 Espresso on Maple
 - M2-W32 Pacific on Maple

Arm Cap	Number				Fabric Grade							
	1	2	3	4	A	B	C	D	E	F	G	H
No Push Bar / Swivel Locking Casters												
No Arm Cap	BNBR-	S-		NNS	\$ 7607.31	\$ 8217.63	\$ 8438.47	\$ 8681.70	\$ 9081.62	\$ 9486.01	\$ 9939.64	\$10320.16
Polyurethane	BNBR-	S-		PNS	8080.34	8690.66	8911.50	9154.73	9554.65	9959.04	10412.67	10793.19
Wood	BNBR-	S-		WNS	8148.98	8759.30	8980.14	9223.37	9623.29	10027.68	10481.31	10861.83
No Push Bar / Central Locking Casters												
No Arm Cap	BNBR-	S-		NNC	\$ 9906.81	\$10517.13	\$10737.97	\$10981.20	\$11381.12	\$11785.51	\$12239.14	\$12619.66
Polyurethane	BNBR-	S-		PNC	10379.84	10990.16	11211.00	11454.23	11854.15	12258.54	12712.17	13092.69
Wood	BNBR-	S-		WNC	10448.48	11058.80	11279.64	11522.87	11922.79	12327.18	12780.81	13161.33
Push Bar / Swivel Locking Casters												
No Arm Cap	BNBR-	S-		NYS	\$ 8104.22	\$ 8714.54	\$ 8935.38	\$ 9178.61	\$ 9578.53	\$ 9982.92	\$10436.55	\$10817.07
Polyurethane	BNBR-	S-		PYS	8577.25	9187.57	9408.41	9651.64	10051.56	10455.95	10909.58	11290.10
Wood	BNBR-	S-		WYS	8645.89	9256.21	9477.05	9720.28	10120.20	10524.59	10978.22	11358.74
Push Bar / Central Locking Casters												
No Arm Cap	BNBR-	S-		NYC	\$10403.72	\$11014.04	\$11234.88	\$11478.11	\$11878.03	\$12282.42	\$12736.05	\$13116.57
Polyurethane	BNBR-	S-		PYC	10876.75	11487.07	11707.91	11951.14	12351.06	12755.45	13209.08	13589.60
Wood	BNBR-	S-		WYC	10945.39	11555.71	11776.55	12019.78	12419.70	12824.09	13277.72	13658.24

Patient Room

Recliners — Benson Collection

Bariatric Recliner - Transfer Arms



BNBR-22-T

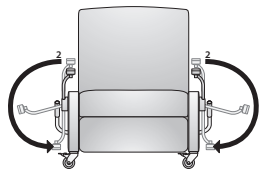
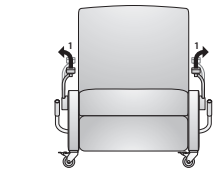

Dimensions

- SH: 20"(508mm)
- AH: 27"(686mm)
- TH: 42.5"(1080mm)
- SD: 21"(533mm)
- TD: 39"(991mm)
- SW: 28"(711mm)
- TW: 37.5"(953mm)

Features

- Includes: Infinite position fully upholstered reclining chair on casters.
- Arms: Steel structure folding transfer arms with polyurethane arm caps.
- Polyurethane arm caps standard in black.
- Casters: 3" rubber swivel or central locking casters.
- Central locking casters have a three position pedal; unlocked, total lock, or front caster directional lock only.
- Infinite position reclining system up to 45°.
- Leg rest operated by right-hand lever.
- Back activated by right-hand actuator.
- Available accessory options include:
 - Left- or right-hand back Foley bag holder; nickel plated
 - Left- or right-hand IV pole; aluminum, height adjustable charcoal gray plastic hooks
 - Left- or right-hand Foley bag holder/IV pole combination
 - Push Bar; stainless steel
- Handedness determined from a seated position.
- COM yardage:
 - Seat, front panel: 3
 - Back and arms: 6

Specification Tip

- Right-hand IV pole can not be specified with central locking casters.

Upcharge for mixed grade fabric surfaces, refer to the electronic design and specification tools.

To Order, Specify:

1) Product number, including:

1 Seat & Front Panel

- 2 Fabric
- 3 Faux Leather

2 Back & Sides

- 2 Fabric
- 3 Faux Leather

3 Left-Hand Accessories

- 0 None
- 2 Back Foley Bag Holder, add \$249.20 list
- 3 IV Pole, add \$552.12 list
- 6 Foley Bag Holder & IV Pole, add \$801.32 list

4 Right-Hand Accessories

- 0 None
- 2 Back Foley Bag Holder, add \$249.20 list
- 3 IV Pole, add \$552.12 list
- 6 Foley Bag Holder & IV Pole, add \$801.32 list

2) Seat & front panel surface and color.

3) Back & side surface and color.

Arm Cap	Number				Fabric Grade								
	1	2	3	4	A	B	C	D	E	F	G	H	
No Push Bar / Swivel Locking Casters													
Polyurethane	BNBR-		T-		PNS	\$ 9545.69	\$ 9682.97	\$ 9903.82	\$10147.05	\$10546.97	\$10951.36	\$11404.99	\$11785.50
No Push Bar / Central Locking Casters													
Polyurethane	BNBR-		T-		PNC	\$11845.19	\$11982.47	\$12203.32	\$12446.55	\$12846.47	\$13250.86	\$13704.49	\$14085.00
Push Bar / Swivel Locking Casters													
Polyurethane	BNBR-		T-		PYS	\$10042.60	\$10179.88	\$10400.73	\$10643.96	\$11043.88	\$11448.27	\$11901.90	\$12282.41
Push Bar / Central Locking Casters													
Polyurethane	BNBR-		T-		PYC	\$12342.10	\$12479.38	\$12700.23	\$12943.46	\$13343.38	\$13747.77	\$14201.40	\$14581.91

Patient Room

Recliners — Benson Collection

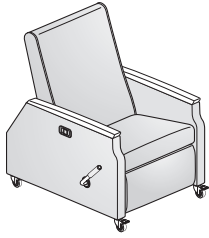
Sleep Recliner -
Standard Arms

BNSR-22-5

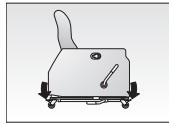

Casters

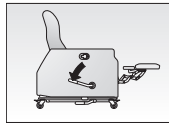

To Raise Footrest

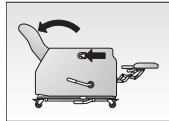

To Recline Back

Dimensions

SH: 20"(508mm)
 AH: 27"(686mm)
 TH: 42.5"(1080mm)
 SD: 21"(533mm)
 TD: 39"(991mm)
 SW: 23"(584mm)
 TW: 32.5"(826mm)

Features

- Includes: Infinite position fully upholstered reclining chair on casters.
- Arms: Upholstered arms or upholstered arms with polyurethane or wood arm caps.
- Polyurethane arm caps standard in black.
- Casters: 3" rubber swivel or central locking casters.
- Central locking casters have a three position pedal; unlocked, total lock, or front caster directional lock only.
- Infinite position recline up to a horizontal position for 72" long sleeping surface.
- Leg rest operated by right-hand lever.
- Back activated by right-hand actuator.
- Available accessory options include:
 - Left-hand folding tray table; charcoal gray with integrated cup holder and spill guard edge. Weight capacity 44 lbs.
 - Left- or right-hand front Foley bag holder; nickel plated.
 - Left- or right-hand IV pole; aluminum, height adjustable charcoal gray plastic hooks.
 - Left-hand folding tray table/Foley bag holder combination
 - Left-hand folding tray table/IV pole combination.
 - Left- or right-hand Foley bag holder/IV pole combination
 - Left-hand folding tray table/ Foley bag holder/IV pole combination
 - Foot Tray
 - Push Bar; stainless steel
- Handedness determined from a seated position.
- COM yardage:
 - Seat, front panel: 2
 - Back and arms: 5

Specification Tip

- Right-hand IV pole can not be specified with central locking casters.

Upcharge for mixed grade fabric surfaces, refer to the electronic design and specification tools.

To Order, Specify:

- 1) Product number, including:

❶ Seat & Front Panel

- ❷ Fabric
- ❸ Faux Leather

❷ Back & Arms

- ❷ Fabric
- ❸ Faux Leather

❸ Left-Hand Accessories

- ❶ None
- ❶ Folding Tray Table, add **\$661.05** list
- ❷ Front Foley Bag Holder, add **\$249.20** list
- ❸ IV Pole, add **\$552.12** list
- ❷ Folding Tray Table & Foley Bag Holder, add **\$910.25** list
- ❸ Folding Tray Table & IV Pole, add **\$1213.17** list
- ❸ Foley Bag Holder & IV Pole, add **\$801.32** list
- ❸ Folding Tray Table, Foley Bag Holder & IV Pole, add **\$1462.37** list

❹ Right-Hand Accessories

- ❶ None
- ❷ Front Foley Bag Holder, add **\$249.20** list
- ❸ IV Pole, add **\$552.12** list
- ❸ Foley Bag Holder & IV Pole, add **\$801.32** list

❺ Foot Tray Option

- ❷ No Foot Tray
- ❸ Foot Tray, add **\$799.83** list

- 2) Seat & front panel surface and color.
- 3) Back & arms surface and color.
- 4) Arm cap surface and color (if applicable).
 Polyurethane -
 TR-F Black
 Wood -
 M2-N Natural Maple
 M2-W33 Carmel on Maple
 M2-W15 Espresso on Maple
 M2-W32 Pacific on Maple

Patient Room

Recliners — Benson Collection

Arm Cap	Number					Fabric Grade										
	1	2	3	4	5	A	B	C	D	E	F	G	H			
No Push Bar / Swivel Locking Casters																
No Arm Cap	BNSR-	■	■	S-	■	NN	■	NS	\$5946.47	\$6420.99	\$6594.09	\$ 6780.62	\$ 7093.98	\$ 7407.35	\$ 7759.51	\$ 8056.46
Polyurethane	BNSR-	■	■	S-	■	PN	■	NS	6419.50	6894.02	7067.12	7253.65	7567.01	7880.38	8232.54	8529.49
Wood	BNSR-	■	■	S-	■	WN	■	NS	6488.14	6962.66	7135.76	7322.29	7635.65	7949.02	8301.18	8598.13
No Push Bar / Central Locking Casters																
No Arm Cap	BNSR-	■	■	S-	■	NN	■	NC	\$8245.97	\$8720.49	\$8893.59	\$ 9080.12	\$ 9393.48	\$ 9706.85	\$10059.01	\$10355.96
Polyurethane	BNSR-	■	■	S-	■	PN	■	NC	8719.00	9193.52	9366.62	9553.15	9866.51	10179.88	10532.04	10828.99
Wood	BNSR-	■	■	S-	■	WN	■	NC	8787.64	9262.16	9435.26	9621.79	9935.15	10248.52	10600.68	10897.63
Push Bar / Swivel Locking Casters																
No Arm Cap	BNSR-	■	■	S-	■	NY	■	NS	\$6443.38	\$6917.90	\$7091.00	\$ 7277.53	\$ 7590.89	\$ 7904.26	\$ 8256.42	\$ 8553.37
Polyurethane	BNSR-	■	■	S-	■	PY	■	NS	6916.41	7390.93	7564.03	7750.56	8063.92	8377.29	8729.45	9026.40
Wood	BNSR-	■	■	S-	■	WY	■	NS	6985.05	7459.57	7632.67	7819.20	8132.56	8445.93	8798.09	9095.04
Push Bar / Central Locking Casters																
No Arm Cap	BNSR-	■	■	S-	■	NY	■	NC	\$8742.88	\$9217.40	\$9390.50	\$ 9577.03	\$ 9890.39	\$10203.76	\$10555.92	\$10852.87
Polyurethane	BNSR-	■	■	S-	■	PY	■	NC	9215.91	9690.43	9863.53	10050.06	10363.42	10676.79	11028.95	11325.90
Wood	BNSR-	■	■	S-	■	WY	■	NC	9284.55	9759.07	9932.17	10118.70	10432.06	10745.43	11097.59	11394.54

Patient Room Recliners — Benson Collection

Sleep Recliner - Transfer Arms



BNSR-22-T

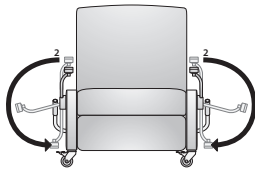
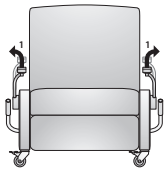

Dimensions

- SH: 20"(508mm)
- AH: 27"(686mm)
- TH: 42.5"(1080mm)
- SD: 21"(533mm)
- TD: 39"(991mm)
- SW: 23"(584mm)
- TW: 32.5"(826mm)

Features

- Includes: Infinite position fully upholstered reclining chair on casters.
- Arms: Steel structure folding transfer arms with polyurethane arm caps.
- Polyurethane arm caps standard in black.
- Casters: 3" rubber swivel or central locking casters.
- Central locking casters have a three position pedal; unlocked, total lock, or front caster directional lock only.
- Infinite position recline able to recline to a horizontal position for 72" long sleeping surface.
- Leg rest operated by right-hand lever.
- Back activated by right-hand actuator.
- Available accessory options include:
 - Left- or right-hand back Foley bag holder; nickel plated.
 - Left- or right-hand IV pole; aluminum, height adjustable charcoal gray plastic hooks.
 - Left- or right-hand Foley bag holder/IV pole combination
 - Foot Tray
 - Push Bar; stainless steel
- Handedness determined from a seated position.
- COM yardage:
 - Seat, front panel: 2
 - Back and arms: 5

Specification Tip

- Right-hand IV pole can not be specified with central locking casters.

Upcharge for mixed grade fabric surfaces, refer to the electronic design and specification tools.

To Order, Specify:

1) Product number, including:

1 Seat & Front Panel

- 2 Fabric
- 3 Faux Leather

2 Back & Sides

- 2 Fabric
- 3 Faux Leather

3 Left-Hand Accessories

- 0 None
- 2 Back Foley Bag Holder, add \$249.20 list
- 3 IV Pole, add \$552.12 list
- 6 Foley Bag Holder & IV Pole, add \$801.32 list

4 Right-Hand Accessories

- 0 None
- 2 Back Foley Bag Holder, add \$249.20 list
- 3 IV Pole, add \$552.12 list
- 6 Foley Bag Holder & IV Pole, add \$801.32 list

5 Foot Tray Option

- N No Foot Tray
- Y Foot Tray, add \$799.83 list

2) Seat & front panel surface and color.

3) Back & arms surface and color.

Arm Cap	Number	Fabric Grade					C	D	E	F	G	H
		1	2	3	4	5						
No Push Bar / Swivel Locking Casters												
Polyurethane	BNSR- T- PN NS	\$ 7411.83	\$ 7886.35	\$ 8059.45	\$ 8245.98	\$ 8559.34	\$ 8872.71	\$ 9224.87	\$ 9521.82			
No Push Bar / Central Locking Casters												
Polyurethane	BNSR- T- PN NC	\$ 9711.33	\$ 10185.85	\$ 10358.95	\$ 10545.48	\$ 10858.84	\$ 11172.21	\$ 11524.37	\$ 11821.32			
Push Bar / Swivel Locking Casters												
Polyurethane	BNSR- T- PY NS	\$ 7908.74	\$ 8383.26	\$ 8556.36	\$ 8742.89	\$ 9056.25	\$ 9369.62	\$ 9721.78	\$ 10018.73			
Push Bar / Central Locking Casters												
Polyurethane	BNSR- T- PY NC	\$ 10208.24	\$ 10682.76	\$ 10855.86	\$ 11042.39	\$ 11355.75	\$ 11669.12	\$ 12021.28	\$ 12318.23			

Patient Room

Sleepers — Benson Collection

Pull-Out Sleeper Chair

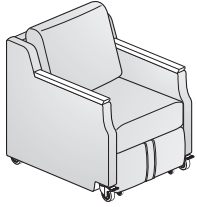

BNSC

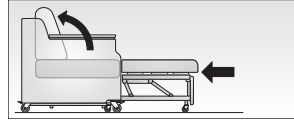
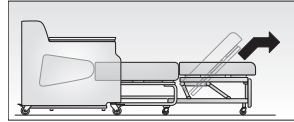
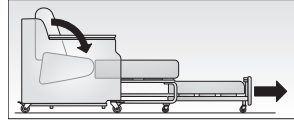

Dimensions

SH: 19"(483mm)
 AH: 28.5"(724mm)
 TH: 38"(965mm)
 SD: 21"(533mm)
 TD: 37"(940mm)
 SW: see below
 TW: see below

Features

- Includes: Sleeper with wall-saver forward pull-out extension on casters.
- Sleeper surface extends to 74"(1880mm) with an intermediate chaise position.
- Arms: Upholstered arms or upholstered arms with polyurethane or wood arm caps.
- Polyurethane arm caps standard in black.
- Casters: 3"(76mm) non-marring rear swivel and front fixed locking casters. Ottoman also supported by swivel casters.
- COM yardage:
 - 30"(762mm)W: Seat, inner back, front panel: 4.25
Outer back and arms: 7.75
 - 33"(838mm)W: Seat, inner back, front panel: 4.5
Outer back and arms: 8
 - 36"(914mm)W: Seat, inner back, front panel: 7
Outer back and arms: 8.25
 - 54"(1372mm)W: Seat, inner back, front panel: 8.5
Outer back and arms: 10

Upcharge for mixed grade fabric surfaces, refer to the electronic design and specification tools.

To Order, Specify:

1) Product number, including:

1 Inner Seat/Back & Front Panel

- 2 Fabric
- 3 Faux Leather

2 Outer Back & Arms

- 2 Fabric
- 3 Faux Leather

2) Seat, inner back & front panel surface and color.

3) Outer back & arms surface and color.

4) Arm Cap surface and color (if applicable)
 Polyurethane -
 TR-F Black
 Wood -
 M2-N Natural Maple
 M2-W33 Carmel on Maple
 M2-W15 Espresso on Maple
 M2-W32 Pacific on Maple

Arm Cap	Number 1 2	Fabric Grade							
		A	B	C	D	E	F	G	H
30"(762mm)W (24"(610mm)SW)									
No Arm Cap	BNSC-30 -N	\$6547.84	\$ 7226.80	\$ 7473.01	\$ 7741.61	\$ 8187.78	\$ 8636.94	\$ 9139.82	\$ 9563.61
Polyurethane	BNSC-30 -P	7020.87	7699.83	7946.04	8214.64	8660.81	9109.97	9612.85	10036.64
Wood	BNSC-30 -W	7089.51	7768.47	8014.68	8283.28	8729.45	9178.61	9681.49	10105.28
33"(838mm)W (27"(686mm)SW)									
No Arm Cap	BNSC-33 -N	\$6547.84	\$ 7226.80	\$ 7473.01	\$ 7741.61	\$ 8187.78	\$ 8636.94	\$ 9139.82	\$ 9563.61
Polyurethane	BNSC-33 -P	7020.87	7699.83	7946.04	8214.64	8660.81	9109.97	9612.85	10036.64
Wood	BNSC-33 -W	7089.51	7768.47	8014.68	8283.28	8729.45	9178.61	9681.49	10105.28
36"(914mm)W (30"(762mm)SW)									
No Arm Cap	BNSC-36 -N	\$7041.76	\$ 8350.43	\$ 8645.89	\$ 8968.21	\$ 9503.91	\$10041.11	\$10646.95	\$11154.30
Polyurethane	BNSC-36 -P	7514.79	8823.46	9118.92	9441.24	9976.94	10514.14	11119.98	11627.33
Wood	BNSC-36 -W	7583.43	8892.10	9187.56	9509.88	10045.58	10582.78	11188.62	11695.97
54"(1372mm)W (48"(1219mm)SW)									
No Arm Cap	BNSC-54 -N	\$8323.58	\$11049.86	\$11394.56	\$11769.10	\$12394.34	\$13022.56	\$13728.38	\$14319.30
Polyurethane	BNSC-54 -P	8796.61	11522.89	11867.59	12242.13	12867.37	13495.59	14201.41	14792.33
Wood	BNSC-54 -W	8865.25	11591.53	11936.23	12310.77	12936.01	13564.23	14270.05	14860.97

Patient Room Sleepers — Benson Collection

Pull-Out Sleeper Sofa

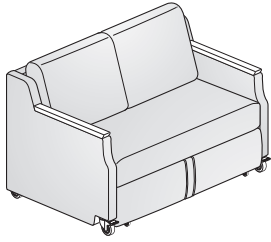

BNSS

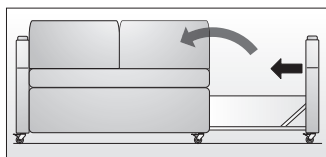
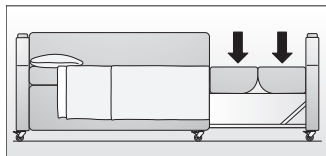
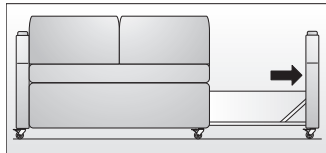
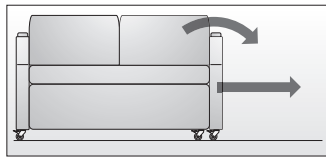

Left-Hand Extension shown

Dimensions

SH: 19.5"(495mm)
 AH: 28.5"(724mm)
 TH: 33.5"(851mm)
 SD: 22"(559mm)
 TD: 33"(838mm)
 SW: 48.5"(1232mm)
 TW: 55"(1397mm)

Features

- Includes: Sleeper sofa with side pull-out extension on casters.
- Pewter pull handle and steel sliding carriage extend sleeper surface to 76"(1930mm)". Total extended width of 83"(2108mm)".
- Right or left-hand extension available. Handedness determined from seated position.
- Arms: Upholstered arms or upholstered arms with polyurethane or wood arm caps.
- Polyurethane arm caps standard in black.
- Casters: Non-marring swivel casters.
- COM yardage:
 Seat, inner back, front panel: 5
 Outer back and arms: 8

Upcharge for mixed grade fabric surfaces, refer to the electronic design and specification tools.

To Order, Specify:

1) Product number, including:

1 Inner Seat/Back & Front Panel

- 2 Fabric
- 3 Faux Leather

2 Outer Back & Arms

- 2 Fabric
- 3 Faux Leather

2) Seat, inner back & front panel surface and color.

3) Outer back & arms surface and color.

4) Arm Cap surface and color (if applicable)
 Polyurethane -
 TR-F Black
 Wood -
 M2-N Natural Maple
 M2-W33 Carmel on Maple
 M2-W15 Espresso on Maple
 M2-W32 Pacific on Maple

Arm Cap	Number 1 2	Fabric Grade							
		A	B	C	D	E	F	G	H
Left-Hand Extension									
No Arm Cap	BNSS- L-N	\$7872.92	\$8619.03	\$8890.61	\$9186.07	\$ 9677.01	\$10169.44	\$10724.54	\$11190.11
Polyurethane	BNSS- L-P	8345.95	9092.06	9363.64	9659.10	10150.04	10642.47	11197.57	11663.14
Wood	BNSS- L-W	8414.59	9160.70	9432.28	9727.74	10218.68	10711.11	11266.21	11731.78
Right-Hand Extension									
No Arm Cap	BNSS- R-N	\$7872.92	\$8619.03	\$8890.61	\$9186.07	\$ 9677.01	\$10169.44	\$10724.54	\$11190.11
Polyurethane	BNSS- R-P	8345.95	9092.06	9363.64	9659.10	10150.04	10642.47	11197.57	11663.14
Wood	BNSS- R-W	8414.59	9160.70	9432.28	9727.74	10218.68	10711.11	11266.21	11731.78

Patient Room

Sleepers — Benson Collection

Sleeper Flip Sofa

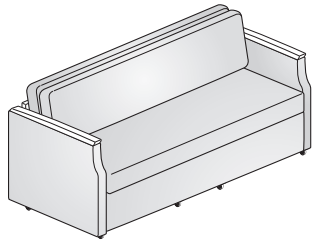

BNSF

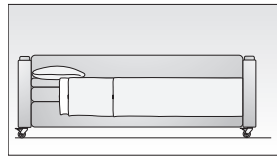
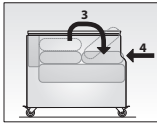
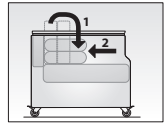
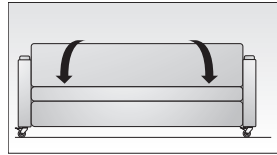

Dimensions

- SH: 20"(508mm)
- AH: 29"(737mm)
- TH: 34.5"(876mm)
- SD: 21"(533mm)
- TD: 33.5"(851mm)
- SW: see below
- TW: see below

Features

- Includes: Sleeper sofa with fold down back cushion on casters.
- Arms: Upholstered arms or upholstered arms with polyurethane or wood arm caps.
- Polyurethane arm caps standard in black.
- Casters: Non-marring total lock casters.
- COM yardage:
 - 75"(1905mm)W: Seat, inner back, front panel: 5.75
Outer back and arms: 12.75
 - 79"(2007mm)W: Seat, inner back, front panel: 5.75
Outer back and arms: 12.75
 - 83"(2108mm)W: Seat, inner back, front panel: 5.75
Outer back and arms: 12.75
 - 87"(2210mm)W: Seat, inner back, front panel: 5.75
Outer back and arms: 12.75

Upcharge for mixed grade fabric surfaces, refer to the electronic design and specification tools.

To Order, Specify:

1) Product number, including:

1 Inner Seat/Back & Front Panel

- 2 Fabric
- 3 Faux Leather

2 Outer Back & Arms

- 2 Fabric
- 3 Faux Leather

2) Seat, inner back & front panel surface and color.

3) Outer back & arms surface and color.

4) Arm Cap surface and color (if applicable)
 Polyurethane -
 TR-F Black
 Wood -
 M2-N Natural Maple
 M2-W33 Carmel on Maple
 M2-W15 Espresso on Maple
 M2-W32 Pacific on Maple

Arm Cap	Number 1 2	Fabric Grade							
		A	B	C	D	E	F	G	H
75"(1905mm)W (68"(1727mm)SW)									
No Arm Cap	BNSF-75 -N	\$8589.19	\$ 9402.45	\$ 9699.40	\$10020.22	\$10557.42	\$11094.62	\$11700.46	\$12207.81
Polyurethane	BNSF-75 -P	9062.22	9875.48	10172.43	10493.25	11030.45	11567.65	12173.49	12680.84
Wood	BNSF-75 -W	9130.86	9944.12	10241.07	10561.89	11099.09	11636.29	12242.13	12749.48
79"(2007mm)W (72"(1829mm)SW)									
No Arm Cap	BNSF-79 -N	\$8874.20	\$10008.28	\$10315.68	\$10649.94	\$11208.02	\$11770.59	\$12400.30	\$12928.55
Polyurethane	BNSF-79 -P	9347.23	10481.31	10788.71	11122.97	11681.05	12243.62	12873.33	13401.58
Wood	BNSF-79 -W	9415.87	10549.95	10857.35	11191.61	11749.69	12312.26	12941.97	13470.22
83"(2108mm)W (76"(1930mm)SW)									
No Arm Cap	BNSF-83 -N	\$9159.22	\$10578.32	\$10887.20	\$11221.46	\$11779.55	\$12340.62	\$12968.84	\$13500.07
Polyurethane	BNSF-83 -P	9632.25	11051.35	11360.23	11694.49	12252.58	12813.65	13441.87	13973.10
Wood	BNSF-83 -W	9700.89	11119.99	11428.87	11763.13	12321.22	12882.29	13510.51	14041.74
87"(2210mm)W (80"(2032mm)SW)									
No Arm Cap	BNSF-87 -N	\$9426.32	\$11163.26	\$11488.56	\$11843.71	\$12436.12	\$13030.02	\$13697.04	\$14258.11
Polyurethane	BNSF-87 -P	9899.35	11636.29	11961.59	12316.74	12909.15	13503.05	14170.07	14731.14
Wood	BNSF-87 -W	9967.99	11704.93	12030.23	12385.38	12977.79	13571.69	14238.71	14799.78

Patient Room

Overbed Tables — Options At-A-Glance

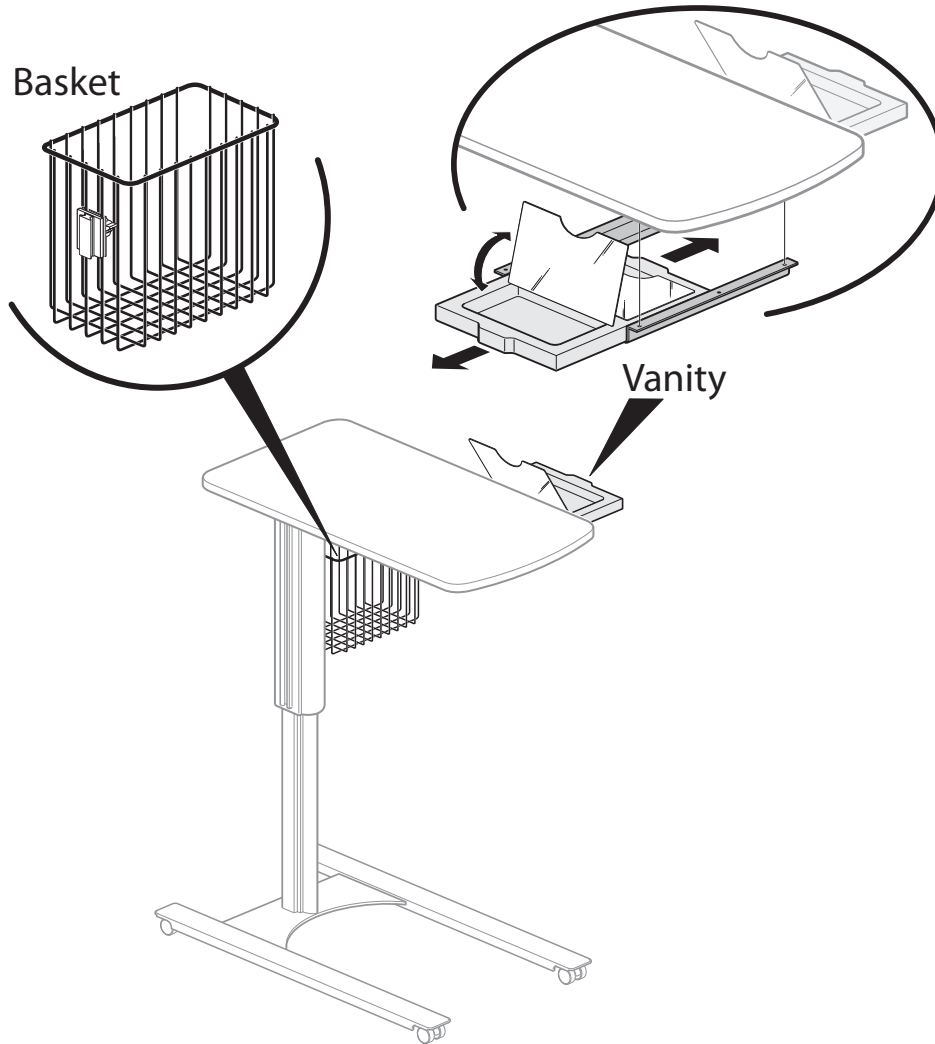

Patient Room

Overbed Tables

	Description	Height	Depth	Width	Number ① ②	Price
Single Top	Laminate	30"(762mm)-41"(1041mm)	17"(432mm)	32"(813mm)	HE810-R-L ■ ■ N	\$1951.17
	Thermofoil				HE810-R-T ■ ■ N	1991.30
	Spill Guard Thermofoil				HE810-R-G ■ ■ N	1991.30



HE810-R-LNNN

Features

- Includes rectangular top, anodized aluminum height adjustable column and heavy duty steel base.
- Pneumatic air lift column adjusts from 30"(762mm)-41"(1041mm).
- Top available in laminate, Thermofoil and Thermofoil with spill guard.
- Optional accessories include chrome storage basket, and taupe vanity drawer with mirror.
- Vanity option includes 2.5"(64mm)H x 13"(330mm)W x 14.5"(368mm)D vanity drawer and mirror.
- Storage basket is 9"(229mm)H x 10"(254mm)W x 6"(152mm)D.
- Holds 100 pounds of evenly distributed weight.

To Order, Specify:

- 1) Product number, including:

① Basket Option:

- N No Basket
- B Basket, add **\$247.98** list

② Vanity Option:

- N No Vanity
- D Vanity, add **\$446.78** list

- 2) Top surface and color.
- 3) Base color.

Dual Top	Thermofoil	30"(762mm)-41"(1041mm)	17"(432mm)	45.5"(1156mm)	HE820-R-TT ■ ■ N	\$2997.92
	Thermofoil/Cup holder				HE820-R-TC ■ ■ N	3196.69
	Spill Guard Thermofoil				HE820-R-GT ■ ■ N	3103.14
	Spill Guard Thermofoil/Cup holder				HE820-R-GC ■ ■ N	3301.91

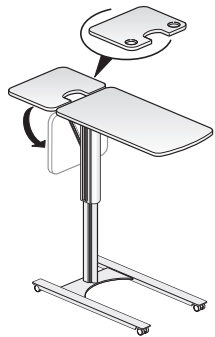

HE820-R-LL

Features

- Includes two piece rectangular top, anodized aluminum height adjustable column and heavy duty steel base.
- Secondary surface can be folded and unfolded with one hand.
- Pneumatic air lift column adjusts from 30"(762mm)-41"(1041mm).
- Top available in Thermofoil and Thermofoil with spill guard.
- Spill guard option applies to primary surface only.
- Secondary Thermofoil top available with integrated cup holders.
- Optional accessories include chrome storage basket, and taupe vanity drawer with mirror.
- Vanity option includes 2.5"(64mm)H x 13"(330mm)W x 14.5"(368mm)D vanity drawer and mirror.
- Storage basket is 9"(229mm)H x 10"(254mm)W x 6"(152mm)D.
- Holds 100 pounds of evenly distributed weight.

To Order, Specify:

- 1) Product number, including:

① Basket Option:

- N No Basket
- B Basket, add **\$247.98** list

② Vanity Option:

- N No Vanity
- D Vanity, add **\$446.78** list

- 2) Top surface and color.
- 3) Base color.

Channel Accessories

For use with Compose

Mounting Kit for Channel Cover Tile

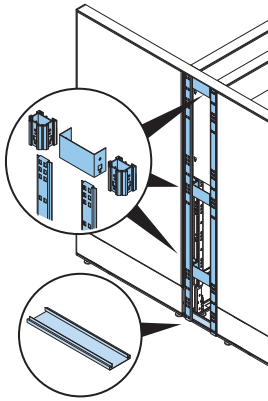

VZCH

Features

- 42"(1067mm)H includes four corner blocks, two lower spacer brackets, two 12"(305mm) tile mounting rails, light blocks, one channel pan and mounting hardware.
- 50"(1270mm)H-78"(1981mm)H includes six corner blocks, three lower spacer brackets, two 12"(305mm) tile mounting rails, light blocks, one channel pan and mounting hardware.

Specification Tips

- Used for mounting Channel Cover Tile.
- Channel Cover Tile is required and must be specified separately.
- Specify height to match utility channel height.
- Two Compose panel frames of equal height required to use Channel Cover Tile Mounting Kit.

To Order, Specify:

- 1) Product number.
(No finish specification required.)

Nominal Height	Nominal Width	Number	Price
40"(1016mm)	12"(305mm)	VZCH-4200	\$ 893.80
48"(1219mm)		VZCH-5000	937.69
56"(1422mm)		VZCH-5800	973.37
64"(1626mm)		VZCH-6600	991.17
72"(1829mm)		VZCH-7400	1009.00
78"(1981mm)		VZCH-8000	1041.70

Spacer Bracket

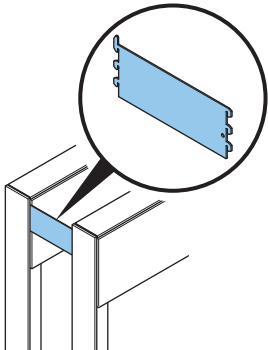

VZCS-0012-U

Feature

- Includes one painted steel Spacer Bracket and attachment hardware
3"(76mm)H and .075"(2mm) thick.

Specification Tips

- Provides support for the utility channel.
- One bracket required in top position for variable height condition.
- One bracket required in top and bottom position for each in-line panel junction.
- Two Compose panel frames of equal height required to use Spacer Bracket.

To Order, Specify:

- 1) Product number.
- 2) Trim color.

Nominal Height	Nominal Width	Number	Trim A	Trim B
12"(305mm)		VZCS-0012-U	\$33.86	\$39.22

Channel Accessories

For use with Compose

Channel Cover Tile

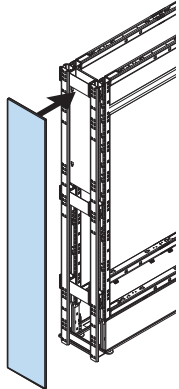

VZTI-PNN

Feature

- Includes one painted 0.375"(10mm) thick steel Channel Tile Cover and attachment hardware.

Specification Tips

- Used to cover the Channel Cover Tile Mounting Kit at the end of utility channel.
- Channel Cover Mounting kit is required; specified separately.
- One cover required to finish each exposed end of the utility channel.
- Channel Tile Cover does not interfere with attachment of panel mounted components.
- To specify height, subtract 2"(51mm) from the panel height.

To Order, Specify:

- Product number.
- Trim color.

Nominal Height	Nominal Width	Number	Trim A	Trim B
40"(1016mm)	12"(305mm)	VZTI-4012-PNN	\$283.10	\$298.10
48"(1219mm)		VZTI-4812-PNN	300.86	319.21
56"(1422mm)		VZTI-5612-PNN	335.85	357.17
64"(1626mm)		VZTI-6412-PNN	370.78	395.26
72"(1829mm)		VZTI-7212-PNN	411.00	438.44

Frame Tube Cover

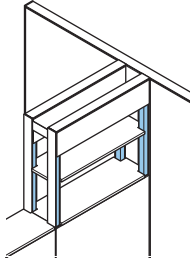

VZCU-P

Feature

- Includes one painted .030"(1mm) thick steel Channel Tile Cover and attachment hardware.

Specification Tips

- Used in upper utility channel conditions above Inboard Mount Reagent Shelf to finish inside of exposed Compose panel frame.
- Two Frame Tube Covers required per Compose panel frame.
- Frame Tube Cover does not interfere with attachment of panel mounted components.
- Bottom Tile Cover required; specify separately.**
- To specify height of Frame Tube Cover subtract the height of Inboard Reagent Shelf and the height of the upper tile from the frame height.

To Order, Specify:

- Product number.
- Trim color.

Nominal Height	Nominal Width	Number	Trim A	Trim B
16"(406mm)	2"(51mm)	VZCU-1600-P	\$83.78	\$88.78
48"(1219mm)		VZCU-2400-P	87.34	92.34

Bottom Tile Cover

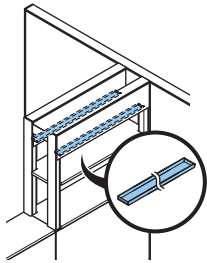

VZCB-P

Feature

- Includes one painted 0.625"(16mm) thick metal Bottom Tile Cover.

Specification Tips

- Used in upper utility channel conditions to finish the lower gap between tiles mounted on Compose upper panel frames.
- One Bottom Tile Cover required per Compose panel frame.
- Specify Bottom Tile Cover width to match Compose panel width.
- Frame Tube Cover required; specify separately.**

To Order, Specify:

- Product number.
- Trim color.

Nominal Height	Nominal Width	Number	Trim A	Trim B
24"(610mm)	2"(51mm)	VZCB-0024-P	\$ 90.93	\$101.62
30"(762mm)		VZCB-0030-P	98.59	109.28
36"(914mm)		VZCB-0036-P	106.25	116.94
42"(1067mm)		VZCB-0042-P	113.91	124.60
48"(1219mm)		VZCB-0048-P	121.57	132.26

Channel Accessories

For use with Compose

Variable Height Cover — 3" Wide Aluminum

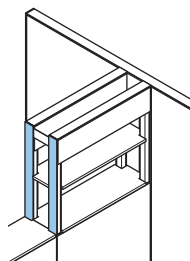

VZVZ-P

Feature

- Includes one 0.25"(6mm) thick painted aluminum Variable Height Cover and attachment hardware.

Specification Tips

- Variable height cover attaches directly to Compose panel frame and adds 0.25"(0mm) to panel frame.
- Used in upper utility channel conditions to finish exposed Compose panel frame above Outboard Mount Reagent Shelf.
- One Variable Height Cover required per Compose panel frame.
- 23"(584mm) cover is used when Outboard Mount Reagent Shelf is located at 50"(1270mm)H.
- 31"(787mm) cover is used when Outboard Mount Reagent Shelf is located at 42"(1067mm)H.
- Not recommended for use with the Outboard Reagent Shelf in the upper position. The Variable Height Trim will not be flush with the top of the shelf.

To Order, Specify:

- Product number.
- Trim color.

Nominal Height	Nominal Width	Number	Trim A	Trim B
23"(584mm)	3"(76mm)	VZVZ-2300-P	\$227.90	\$241.66
31"(787mm)		VZVZ-3100-P	256.86	277.50

Variable Height Cover — 12" Wide ChemSurf

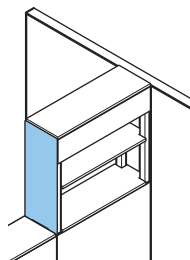

TS00-4TRY

Feature

- Includes one ChemSurf 0.81"(0mm)T Variable Height Cover and attachment hardware.

Specification Tips

- Variable Height Cover 12"(305mm) wide is required for (2) compose panel frames.
- Used in upper utility channel conditions to finish exposed Compose panel frame above Outboard Mount Reagent Shelf, when Outboard Reagent Shelf is used in upper position to provide flush trim.
- 31"(787mm) cover is used when Outboard Mount Reagent Shelf is located at 42"(1067mm)H.

To Order, Specify:

- Product number.
- Chemsurf laminate surface color.
- Edgeband color.

Nominal Height	Nominal Width	Number	Price
23"(584mm)	12"(305mm)	TS00-4TRY	\$ 967.99
31"(787mm)		TS00-4RHH	1089.31

Inside End Cover

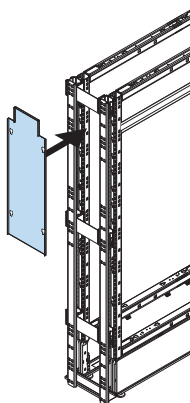

VZCF-P

Feature

- Includes one 0.375"(0mm) thick painted metal Inside End Cover and attachment hardware.

Specification Tips

- For use with Reagent Shelf application.
- Finishes the inside of upper utility channel opening.
- 24"(610mm) cover is used when lower mount Inboard Reagent Shelf is located at 50"(1270mm) high.
- 32"(813mm) cover is used when lower mount Inboard Reagent Shelf is located at 42"(1067mm) high.
- Inside End Cover does not interfere with attachment of panel mounted components.

To Order, Specify:

- Product number.
- Trim color.

Nominal Height	Nominal Width	Number	Trim A	Trim B
24"(610mm)	12"(305mm)	VZCF-2400-P	\$114.08	\$124.77
32"(813mm)		VZCF-3200-P	137.26	147.95

Channel Accessories

For use with Compose

Reagent Shelf, Inboard Mount

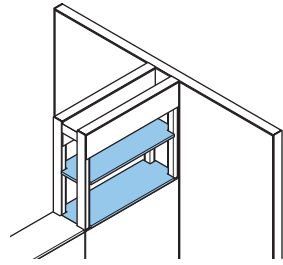

UZSR-CMIL
UZSR-CMIU

Features

- Includes one 0.81”(21mm) thick ChemSurf Reagent Shelf and four painted attachment brackets.
- 36”(914mm)-48”(1219mm) wide Reagent Shelf also includes stiffener.

Specification Tips

- Lower mount shelf is used to enclose the top of the utility channel and provides surface for storage.
- Upper mount shelf provides surface for storage.
- Attachment brackets install on same size Compose panel side trim rail.

To Order, Specify:

- 1) Product number.
- 2) Chemsurf laminate surface color.
- 3) Edgeband color.
- 4) Trim color (Upper Inboard Mount only)

Nominal Height	Lower Shelf Number	Price	Upper Shelf Number	Price
24”(610mm)	UZSR-0024-CMIL	\$1890.48	UZSR-0024-CMIU	\$1890.48
30”(762mm)	UZSR-0030-CMIL	1960.18	UZSR-0030-CMIU	1953.53
36”(914mm)	UZSR-0036-CMIL	2029.88	UZSR-0036-CMIU	2016.58
42”(1067mm)	UZSR-0042-CMIL	2099.58	UZSR-0042-CMIU	2079.63
48”(1219mm)	UZSR-0048-CMIL	2169.28	UZSR-0048-CMIU	2142.68

Reagent Shelf, Outboard Mount

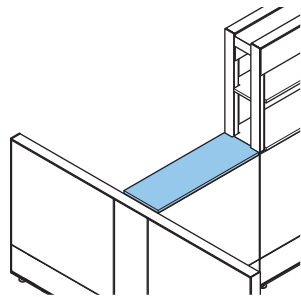

UZSR-CMO

Feature

- Includes one 0.81”(0mm) thick Chemsurf Reagent Shelf and four painted attachment brackets.

Specification Tips

- Shelf is used to enclose the top of utility channel and provides surface for storage.
- To be installed in component mounting rails on same size Compose panel.
- Attachment and support brackets are installed within the utility channel.
- Use with aluminum 3”(76mm)W Variable Height Covers (VZVZ) to accommodate thickness of the Outboard Mount Reagent Shelf.

To Order, Specify:

- 1) Product number.
- 2) Chemsurf laminate surface color.
- 3) Edgeband color.

Nominal Height	Number	Price
24”(610mm)	UZSR-0024-CMO	\$1392.86
30”(762mm)	UZSR-0030-CMO	1432.69
36”(914mm)	UZSR-0036-CMO	1472.52
42”(1067mm)	UZSR-0042-CMO	1512.35
48”(1219mm)	UZSR-0048-CMO	1552.18

Individual Tiles

For use with Compose

Steel Tile

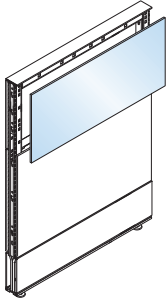

VZTI-PNN

Feature

- Includes one painted metal tile and attachment brackets.

Specification Tips

- When designing for segmentation, Aligner/Light Blocks are required and separately specified. Refer to Compose price list
- Additional sizes for Steel Tiles can be found in the Compose price list.
- Refer to Compose Specification Guide for Planning with Tiles and Aligner/Light Blocks.
- 8"(203mm) tiles may not be installed in raceway position in place of base raceway cover
- Vertical panel frame face dimensions:
 - Panel frame/non-raceway cover = frame height minus 2"(51mm)
 - Panel frame with raceway cover = frame height minus 10"(254mm)
- No power access available if tile is in raceway position.

To Order, Specify:

- 1) Product number.
- 2) Trim color.

Nominal Height	Nominal Width	Number	Trim A	Trim B
40"(1016mm)	18"(457mm)	VZTI-4018-PNN	\$317.48	\$342.96
	24"(610mm)	VZTI-4024-PNN	351.86	387.82
	30"(762mm)	VZTI-4030-PNN	386.24	432.68
	36"(914mm)	VZTI-4036-PNN	420.62	477.54
	42"(1067mm)	VZTI-4042-PNN	455.00	522.40
	48"(1219mm)	VZTI-4048-PNN	489.38	567.26
72"(1829mm)	60"(1524mm)	VZTI-4060-PNN	558.14	656.98
	18"(457mm)	VZTI-7218-PNN	\$472.52	\$518.52
	24"(610mm)	VZTI-7224-PNN	534.04	598.60
	30"(762mm)	VZTI-7230-PNN	595.56	678.68
	36"(914mm)	VZTI-7236-PNN	657.08	758.76
	42"(1067mm)	VZTI-7242-PNN	718.60	838.84

Individual Tiles

For use with Compose

ChemSurf Tile

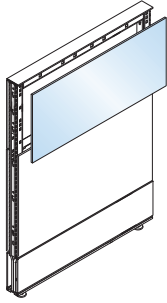

VZTI-DNN (No Port)

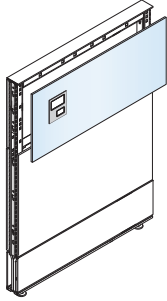

VZTI-DLN (One Port – Left)

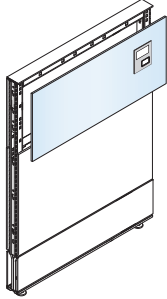

VZTI-DRN (One Port – Right)

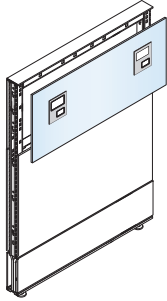

VZTI-D2N (Two Ports – Double)

Feature

- Includes one ChemSurf laminate tile and attachment brackets.

Specification Tips

- When designing for segmentation, Aligner/Light Blocks are required and separately specified. Refer to Compose price list.
- Refer to Compose Specification Guide for Planning with Tiles and Aligner/Light Blocks.
 - If using ChemSurf laminate tiles up to 32”(813mm) in height, refer to Compose Minimum Return Width Guidelines.
 - If using ChemSurf laminate tiles above 32”(813mm) in height, add 6”(152mm) to Compose Minimum Return Width Guidelines.
- Edge detail (core) is black. When mixing with Compose standard Laminate tiles, it is recommended to specify laminate with charcoal trim to match.
- 8”(203mm) tiles may not be installed in raceway position in place of base raceway cover.
- Vertical panel frame face dimensions:
 - Panel frame/non-raceway cover = frame height minus 2”(51mm)
 - Panel frame with raceway cover = frame height minus 10”(254mm)
- No power access available if tile is in raceway position.

To Order, Specify:

- Product number.

1 Port Option

- N** No Port
- Technology Port Option:
 - L** One Port – Left
 - R** One Port – Right
 - 2** Two Ports – Double

- Chemsurf laminate surface color.
- Edgeband trim color.
- Non-metallic trim color for bezels (if applicable).

Nominal Height	Nominal Width	Number ①	No Port Price	Single Port Price	Double Port Price
8”(203mm)	18”(457mm)	VZTI-0818-D N	\$ 210.37	N/A	N/A
	24”(610mm)	VZTI-0824-D N	240.71	N/A	N/A
	30”(762mm)	VZTI-0830-D N	271.06	N/A	N/A
	36”(914mm)	VZTI-0836-D N	301.40	N/A	N/A
	42”(1067mm)	VZTI-0842-D N	331.74	N/A	N/A
	48”(1219mm)	VZTI-0848-D N	362.09	N/A	N/A
16”(406mm)	60”(1524mm)	VZTI-0860-D N	422.77	N/A	N/A
	18”(457mm)	VZTI-1618-D N	\$ 301.40	N/A	N/A
	24”(610mm)	VZTI-1624-D N	362.09	\$ 449.49	N/A
	30”(762mm)	VZTI-1630-D N	422.77	510.17	\$ 631.05
	36”(914mm)	VZTI-1636-D N	483.46	570.86	691.74
	42”(1067mm)	VZTI-1642-D N	544.15	631.55	752.43
24”(610mm)	48”(1219mm)	VZTI-1648-D N	604.83	692.23	813.11
	60”(1524mm)	VZTI-1660-D N	726.21	813.61	934.49
	18”(457mm)	VZTI-2418-D N	\$ 392.43	N/A	N/A
	24”(610mm)	VZTI-2424-D N	483.46	\$ 570.86	N/A
	30”(762mm)	VZTI-2430-D N	574.49	661.89	\$ 782.77
	36”(914mm)	VZTI-2436-D N	665.52	752.92	873.80
32”(813mm)	42”(1067mm)	VZTI-2442-D N	756.55	843.95	964.83
	48”(1219mm)	VZTI-2448-D N	847.58	934.98	1055.86
	60”(1524mm)	VZTI-2460-D N	1029.64	1117.04	1237.92
	18”(457mm)	VZTI-3218-D N	\$ 483.46	N/A	N/A
	24”(610mm)	VZTI-3224-D N	604.83	\$ 692.23	N/A
	30”(762mm)	VZTI-3230-D N	726.21	813.61	\$ 934.49
40”(1016mm)	36”(914mm)	VZTI-3236-D N	847.58	934.98	1055.86
	42”(1067mm)	VZTI-3242-D N	968.95	1056.35	1177.23
	48”(1219mm)	VZTI-3248-D N	1090.33	1177.73	1298.61
	60”(1524mm)	VZTI-3260-D N	1333.07	1420.47	1541.35
	18”(457mm)	VZTI-4018-D N	\$ 574.49	N/A	N/A
	24”(610mm)	VZTI-4024-D N	726.21	N/A	N/A
48”(1219mm)	30”(762mm)	VZTI-4030-D N	877.92	N/A	N/A
	36”(914mm)	VZTI-4036-D N	1029.64	N/A	N/A
	42”(1067mm)	VZTI-4042-D N	1181.36	N/A	N/A
	48”(1219mm)	VZTI-4048-D N	1333.07	N/A	N/A
	60”(1524mm)	VZTI-4060-D N	1636.51	N/A	N/A

Individual Tiles

For use with Compose

Nominal Height	Nominal Width	Number ①	No Port Price	Single Port Price	Double Port Price
48"(1219mm)	18"(457mm)	VZTI-4818-D ■ N	\$ 665.52	N/A	N/A
	24"(610mm)	VZTI-4824-D ■ N	847.58	N/A	N/A
	30"(762mm)	VZTI-4830-D ■ N	1029.64	N/A	N/A
	36"(914mm)	VZTI-4836-D ■ N	1211.70	N/A	N/A
	42"(1067mm)	VZTI-4842-D ■ N	1393.76	N/A	N/A
	48"(1219mm)	VZTI-4848-D ■ N	1575.82	N/A	N/A
	60"(1524mm)	VZTI-4860-D ■ N	1939.94	N/A	N/A
56"(1422mm)	18"(457mm)	VZTI-5618-D ■ N	\$ 756.55	N/A	N/A
	24"(610mm)	VZTI-5624-D ■ N	968.95	N/A	N/A
	30"(762mm)	VZTI-5630-D ■ N	1181.36	N/A	N/A
	36"(914mm)	VZTI-5636-D ■ N	1393.76	N/A	N/A
	42"(1067mm)	VZTI-5642-D ■ N	1606.16	N/A	N/A
	48"(1219mm)	VZTI-5648-D ■ N	1818.57	N/A	N/A
	60"(1524mm)	VZTI-5660-D ■ N	2243.37	N/A	N/A
64"(1626mm)	18"(457mm)	VZTI-6418-D ■ N	\$1411.46	N/A	N/A
	24"(610mm)	VZTI-6424-D ■ N	1654.21	N/A	N/A
	30"(762mm)	VZTI-6430-D ■ N	1896.95	N/A	N/A
	36"(914mm)	VZTI-6436-D ■ N	2139.70	N/A	N/A
	42"(1067mm)	VZTI-6442-D ■ N	2382.45	N/A	N/A
	48"(1219mm)	VZTI-6448-D ■ N	2625.19	N/A	N/A
	60"(1524mm)	VZTI-6460-D ■ N	3110.69	N/A	N/A
72"(1829mm)	18"(457mm)	VZTI-7218-D ■ N	\$1502.49	N/A	N/A
	24"(610mm)	VZTI-7224-D ■ N	1775.58	N/A	N/A
	30"(762mm)	VZTI-7230-D ■ N	2048.67	N/A	N/A
	36"(914mm)	VZTI-7236-D ■ N	2321.76	N/A	N/A
	42"(1067mm)	VZTI-3642-D ■ N	2594.85	N/A	N/A
	48"(1219mm)	VZTI-3648-D ■ N	2867.94	N/A	N/A
	60"(1524mm)	VZTI-7260-D ■ N	3414.12	N/A	N/A

Spanning In-line — Individual Tiles

For use with Compose

Spanning Steel Tile

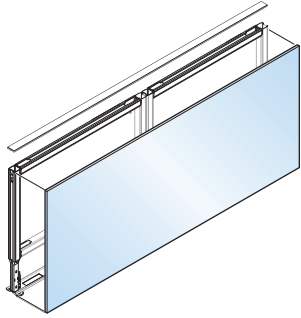

VZTI-PNS

Features

- Includes one in-line spanning steel tile and attachment clips.
- Spans a maximum of two full panel frames or stack frames in an in-line panel application.

Specification Tips

- Spanning tile width equals the sum of two separately specified full panel or stack frames in an in-line panel application.
- Opposite side of the full panel frame or stack frames may have tiles the same width as each frame or another spanning tile may be used.
- A full panel frame allows for independent planning options for each side of the panel; tile type and height may be the same or different per side.
- May be used with a base raceway cover the same width as the full panel frame or the tile may go to the floor; a spanning base raceway cover is not available.
- Separately specified aluminum top trim is required; top trim may span both of the full panel frames or may be the same width as each full panel frame.
- All Compose trim to be aluminum for the Utility Channel application.
- **Aligner/Light Blocks are separately specified per tile configuration;** see Specification Guide for details.
- 8”(203mm)H tile is not for use in the panel frame base raceway in place of the base raceway cover.
- Using a tile which goes to the floor prohibits power access in the panel frame base raceway and is not for use with a concealed base feed.
- Only internal Power Base base feed can be used if using a tile which goes to the floor.
- Vertical panel frame face dimensions:
 - Full Panel Frame/No Raceway Cover = Full Panel Frame height minus 2”(51mm) (for use with tile which goes to the floor)
 - Full Panel Frame/With Raceway Cover = Full Panel Frame height minus 10”(254mm)

To Order, Specify:

- 1) Product number.
- 2) Trim color.

Nominal Height	Nominal Width	Number	Trim A	Trim B
8”(203mm)	36”(914mm)	VZTI-0836-PNS	\$273.22	\$283.77
	42”(1067mm)	VZTI-0842-PNS	283.26	295.57
	48”(1219mm)	VZTI-0848-PNS	293.30	307.37
	54”(1372mm)	VZTI-0854-PNS	303.34	319.17
	60”(1524mm)	VZTI-0860-PNS	313.38	330.97
	66”(1676mm)	VZTI-0866-PNS	323.42	342.77
	72”(1829mm)	VZTI-0872-PNS	333.46	354.57
	78”(1981mm)	VZTI-0878-PNS	343.50	366.37
16”(406mm)	36”(914mm)	VZTI-1636-PNS	\$322.05	\$344.29
	42”(1067mm)	VZTI-1642-PNS	337.93	364.21
	48”(1219mm)	VZTI-1648-PNS	353.81	384.13
	54”(1372mm)	VZTI-1654-PNS	369.69	404.05
	60”(1524mm)	VZTI-1660-PNS	385.57	423.97
	66”(1676mm)	VZTI-1666-PNS	401.45	443.89
	72”(1829mm)	VZTI-1672-PNS	417.33	463.81
	78”(1981mm)	VZTI-1678-PNS	433.21	483.73
24”(610mm)	36”(914mm)	VZTI-2436-PNS	\$344.75	\$378.62
	42”(1067mm)	VZTI-2442-PNS	366.77	406.82
	48”(1219mm)	VZTI-2448-PNS	388.79	435.02
	54”(1372mm)	VZTI-2454-PNS	410.81	463.22
	60”(1524mm)	VZTI-2460-PNS	432.83	491.42
	66”(1676mm)	VZTI-2466-PNS	454.85	519.62
	72”(1829mm)	VZTI-2472-PNS	476.87	547.82
	78”(1981mm)	VZTI-2478-PNS	498.89	576.02

Spanning In-line — Individual Tiles

For use with Compose

Nominal Height	Nominal Width	Number	Trim A	Trim B
32"(813mm)	36"(914mm)	VZTI-3236-PNS	\$458.31	\$502.73
	42"(1067mm)	VZTI-3242-PNS	484.99	537.45
	48"(1219mm)	VZTI-3248-PNS	511.67	572.17
	54"(1372mm)	VZTI-3254-PNS	538.35	606.89
	60"(1524mm)	VZTI-3260-PNS	565.03	641.61
	66"(1676mm)	VZTI-3266-PNS	591.71	676.33
	72"(1829mm)	VZTI-3272-PNS	618.39	711.05
	78"(1981mm)	VZTI-3278-PNS	645.07	745.77
40"(1016mm)	36"(914mm)	VZTI-4036-PNS	\$628.82	\$685.74
	42"(1067mm)	VZTI-4042-PNS	663.20	730.60
	48"(1219mm)	VZTI-4048-PNS	697.58	775.46
	54"(1372mm)	VZTI-4054-PNS	731.96	820.32
	60"(1524mm)	VZTI-4060-PNS	766.34	865.18
	66"(1676mm)	VZTI-4066-PNS	800.72	910.04
	72"(1829mm)	VZTI-4072-PNS	835.10	954.90
	78"(1981mm)	VZTI-4078-PNS	869.48	999.76

Spanning In-line — Individual Tiles

For use with Compose

Spanning ChemSurf Tile

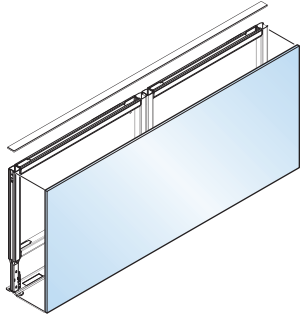

VZTI-DNS

Features

- Includes two fixed-height steel leg assemblies, support beam, rail, Includes one in-line spanning laminate tile with 1mm edgeband and attachment clips.
- Spans a maximum of two full panel frames or stack frames in an in-line panel application.

Specification Tips

- Spanning tile width equals the sum of two separately specified full panel or stack frames in an in-line panel application.
- Opposite side of the full panel frame or stack frames may have tiles the same width as each frame or another spanning tile may be used.
- A full panel frame allows for independent planning options for each side of the panel; tile type and height may be the same or different per side.
- Aligner/Light Blocks are separately specified per tile configuration; see Specification Guide for details.
- Separately specified aluminum top trim is required; top trim may span both of the full panel frames or may be the same width as each full panel frame.
- All Compose trim to be aluminum for the Utility Channel application.
- May be used with a base raceway cover the same width as each full panel frame or the tile may go to the floor; a spanning base raceway cover is not available.
- 8”(203mm)H tile is not for use in the panel frame base raceway in place of the base raceway cover.
- Using a tile which goes to the floor prohibits power access in the panel frame base raceway and is not for use with a concealed base feed.
- Only internal Power Base base feed can be used if using a tile which goes to the floor.
- Vertical panel frame face dimensions:
 - Full Panel Frame/No Raceway Cover = Full Panel Frame height minus 2”(51mm) (for use with tile which goes to the floor)
 - Full Panel Frame/With Raceway Cover = Full Panel Frame height minus 10”(254mm)

To Order, Specify:

- 1) Product number.
- 2) Chemsurf laminate surface color.
- 3) Edgeband trim color.

Laminate Tile widths greater than 60”(1524mm) wide are not available on 56”(1422mm), 64”(1626mm) or 72”(1829mm) high tiles.

Nominal Height	Nominal Width	Number	Price
8”(203mm)	36”(914mm)	VZTI-0836-DNS	\$ 583.34
	42”(1067mm)	VZTI-0842-DNS	613.68
	48”(1219mm)	VZTI-0848-DNS	644.03
	54”(1372mm)	VZTI-0854-DNS	674.37
	60”(1524mm)	VZTI-0860-DNS	704.71
	66”(1676mm)	VZTI-0866-DNS	599.73
	72”(1829mm)	VZTI-0872-DNS	687.80
	78”(1981mm)	VZTI-0878-DNS	707.07
	84”(2134mm)	VZTI-0884-DNS	726.34
	90”(2286mm)	VZTI-0890-DNS	745.61
16”(406mm)	96”(2438mm)	VZTI-0896-DNS	764.88
	36”(914mm)	VZTI-1636-DNS	\$ 765.40
	42”(1067mm)	VZTI-1642-DNS	826.09
	48”(1219mm)	VZTI-1648-DNS	886.77
	54”(1372mm)	VZTI-1654-DNS	947.46
	60”(1524mm)	VZTI-1660-DNS	1008.15
	66”(1676mm)	VZTI-1666-DNS	811.70
	72”(1829mm)	VZTI-1672-DNS	919.04
	78”(1981mm)	VZTI-1678-DNS	957.58
	84”(2134mm)	VZTI-1684-DNS	996.12
24”(610mm)	90”(2286mm)	VZTI-1690-DNS	1034.66
	96”(2438mm)	VZTI-1696-DNS	1073.20
	36”(914mm)	VZTI-2436-DNS	\$ 947.46
	42”(1067mm)	VZTI-2442-DNS	1038.49
	48”(1219mm)	VZTI-2448-DNS	1129.52
	54”(1372mm)	VZTI-2454-DNS	1220.55
	60”(1524mm)	VZTI-2460-DNS	1311.58
	66”(1676mm)	VZTI-2466-DNS	1023.67
	72”(1829mm)	VZTI-2472-DNS	1150.28
	78”(1981mm)	VZTI-2478-DNS	1208.09
	84”(2134mm)	VZTI-2484-DNS	1265.90
	90”(2286mm)	VZTI-2490-DNS	1323.71

Spanning In-line — Individual Tiles

For use with Compose

Nominal Height	Nominal Width	Number	Price	
32"(813mm)	36"(914mm)	VZTI-3236-DNS	\$1129.52	
	42"(1067mm)	VZTI-3242-DNS	1250.89	
	48"(1219mm)	VZTI-3248-DNS	1372.27	
	54"(1372mm)	VZTI-3254-DNS	1493.64	
	60"(1524mm)	VZTI-3260-DNS	1615.01	
	66"(1676mm)	VZTI-3266-DNS	1235.64	
	72"(1829mm)	VZTI-3272-DNS	1381.52	
	78"(1981mm)	VZTI-3278-DNS	1458.60	
	84"(2134mm)	VZTI-3284-DNS	1535.68	
	90"(2286mm)	VZTI-3290-DNS	1612.76	
40"(1016mm)	96"(2438mm)	VZTI-3296-DNS	1689.84	
	36"(914mm)	VZTI-4036-DNS	\$1311.58	
	42"(1067mm)	VZTI-4042-DNS	1463.30	
	48"(1219mm)	VZTI-4048-DNS	1615.01	
	54"(1372mm)	VZTI-4054-DNS	1766.73	
	60"(1524mm)	VZTI-4060-DNS	1918.45	
	66"(1676mm)	VZTI-4066-DNS	1447.61	
	72"(1829mm)	VZTI-4072-DNS	1612.76	
	78"(1981mm)	VZTI-4078-DNS	1709.11	
	84"(2134mm)	VZTI-4084-DNS	1805.46	
48"(1219mm)	90"(2286mm)	VZTI-4090-DNS	1901.81	
	96"(2438mm)	VZTI-4096-DNS	1998.16	
	36"(914mm)	VZTI-4836-DNS	\$1493.64	
	42"(1067mm)	VZTI-4842-DNS	1675.70	
	48"(1219mm)	VZTI-4848-DNS	1857.76	
	54"(1372mm)	VZTI-4854-DNS	2039.82	
	60"(1524mm)	VZTI-4860-DNS	2221.88	
	66"(1676mm)	VZTI-4866-DNS	1659.58	
	72"(1829mm)	VZTI-4872-DNS	1844.00	
	78"(1981mm)	VZTI-4878-DNS	1959.62	
56"(1422mm)	84"(2134mm)	VZTI-4884-DNS	2075.24	
	90"(2286mm)	VZTI-4890-DNS	2190.86	
	96"(2438mm)	VZTI-4896-DNS	2306.48	
	36"(914mm)	VZTI-5636-DNS	\$1675.70	
	42"(1067mm)	VZTI-5642-DNS	1888.10	
	48"(1219mm)	VZTI-5648-DNS	2100.51	
	54"(1372mm)	VZTI-5654-DNS	2312.91	
	60"(1524mm)	VZTI-5660-DNS	2525.31	
	64"(1626mm)	36"(914mm)	VZTI-6436-DNS	\$2421.64
		42"(1067mm)	VZTI-6442-DNS	2664.39
48"(1219mm)		VZTI-6448-DNS	2907.13	
54"(1372mm)		VZTI-6454-DNS	3149.88	
60"(1524mm)		VZTI-6460-DNS	3392.63	
72"(1829mm)	36"(914mm)	VZTI-7236-DNS	\$2603.70	
	42"(1067mm)	VZTI-7242-DNS	2876.79	
	48"(1219mm)	VZTI-7248-DNS	3149.88	
	54"(1372mm)	VZTI-7254-DNS	3422.97	
	60"(1524mm)	VZTI-7260-DNS	3696.06	

Finish/Color Legends

Benson

Polyurethane

TR-F Black

Wood

M2-N Natural Maple
 M2-W33 Carmel on Maple
 M2-W15 Espresso on Maple
 M2-W32 Pacific on Maple

Compose

Trim

Grade A

Smooth

TR-R Beige
 TR-AK Chalk
 TR-K Charcoal
 TR-J Graphite*
 TR-G Gray Tone*
 TR-AA Putty*
 TR-E Smoke*
 TR-PLS Smooth Plaster
 TR-FM Snow

Grade B

Smooth

TR-1C Accent Blue
 TR-1G Blue Jay
 TR-1R Brownstone
 TR-1N Night
 TR-1Q Park
 TR-RR Rusty Red
 TR-1M Sable
 TR-1J Sky Blue

Smooth Metallic

TR-MC Metallic Champagne
 TR-MG Metallic Gunmetal
 TR-LE Metallic Silver

Textured

TR-TG Grout
 TR-TF Pitch
 TR-TW Plaster

Textured Metallic

TR-HE Hellenic

ChemSurf

Laminate Finishes

Grade A

Solid Color

H-H62 Gray Tone
 H-HAA Putty

Patterned

H-HP1 Linen Casual
 H-HP2 Linen Classic

Edgeband

Solid Color

H-H62 Gray Tone
 H-HAA Putty

Patterned Edgeband

HP-P1 Linen Casual
 HP-P2 Linen Classic

*Coordinates with preferred third party manufacturers.

Maari

Shell / Arm Caps

Polymer Colors

TR-1T Balsam
 TR-F Black
 TR-CF Coffee
 TR-G Gray Tone
 TR-1V Indigo
 TR-RR Rusty Red
 TR-PLS Smooth Plaster
 TR-1W Water
 TR-1K Wren

Base

Trim

TR-F Black
 TR-PLS Smooth Plaster

Matte Trim Color

TR-M1 Black Matte
 TR-M2 Smooth Plaster Matte

Tablet

Wood Finish

VH-W35 Plank Walnut
 VB-W35 Plank White Oak

Painted MDF

PW-F Black
 PW-PL Polar

Laminate

Haworth Standard
 Grade A and Grade B laminate

Overbed Tables

Trim Colors

TR-T33 Bone
 TR-T32 Graphite Gray
 TR-T34 Taupe

Thermofoil

TF-H40 Café
 TF-H0C Crystal
 TF-H60 Walnut

Laminate

H-H40 Café
 H-H0C Crystal
 H-H60 Walnut

Soji

Trim Colors

TR-F Black
 TR-7 Fog
 TR-UFM Snow

Zody LX

Aluminum Base and Arm Uprights

Paint Colors

TR-MC Metallic Champagne
 TR-LE Metallic Silver
 TR-UFS Snow Fall
 PM-P Polished Aluminum

Trim Colors

TR-F Black
 TR-7 Fog
 TR-UFM Snow

Plastic Base

TR-F Black
 TR-7 Fog

ALERT: These materials are current, however they are being considered for future obsolescence due to low volume.

Trim Colors

TR-1E Accent Orange
 TR-CTS Chartreuse
 TR-DM Dark Bronze Metallic
 TR-1H Terra
 TR-1K Wren

Fabric Pattern Usage

Products are restricted to fabric patterns that meet applicability standards for tailoring. A dot in the matrix indicates fabric acceptability on product series or specific models listed. Fabrics are listed alphabetically by grades.

Grade: Pattern (Surface Code)

Haworth Fabrics

	Series/Model				
	Benson	Exam Room Stools	Maari	Soji Cleanable+	Zody LX Cleanable+
A: Blanket (4H)			●		
A: Hobson (3J)			●		
A: Morse (4J)			●		
A: Novelty (3L)			●		
A: Pixel (2A)			●		
A: Tellure (3A)			●		
A: Twist (MM)			●		
A: Wellington Faux Leather (XJ)	●		●	●	●
B: Diagonale (4N)			●		
B: English Tweed (4E)			●		
B: Floyd by Kvadrat (S6)			●		
B: Gauge (1X)			●		
B: Kaleidoscope (S4)			●		
B: Pemberton (SN)	●		●		
B: Ramie (4V)			●		
B: Reflect by Kvadrat (SB)			●		
B: Squares (4A)			●		
B: Tech (MV)			●		
C: Dots (6K)			●		
C: King II (67)			●		
C: Maya II (68)			●		
C: Oceanic (4T)			●		
C: Scapes (3S)			●		
D: Atlas by Kvadrat (LW)			●		
D: Big Arrow (4D)			●		
D: Big Diagonale (1K)			●		
D: Clara 2 by Kvadrat (NV)			●		
D: Class II (66)			●		
D: Cotswold (JB)			●		
D: Main Line Flax (6M)			●		
D: Melange Nap by Kvadrat (S7)			●		
D: Recheck by Kvadrat (RP)			●		
D: Tangram (LV)			●		
E: Brisa Faux Leather (XG)			●	●	●
E: Steelcut Trio by Kvadrat (SY)			●		
F: Divina Melange 3 (SV)			●		
F: Hallingdal 65 by Kvadrat (SZ)			●		
Exam Faux Leather		●			
Leathers					
A: Plains Leather (XP)			●		
B: Nature Leather (XE)			●		

Haworth Alliance
 For information on the Haworth Alliance Program, please refer to: surfaces.haworth.com
Customer's Own Material (COM)
 For Customer's Own Material (COM) information including requesting a new COM, please refer to: surfaces.haworth.com

*For most current finish and fabric availability please reference surfaces.haworth.com.

ALERT: These materials are current, however they are being considered for future obsolescence due to low volume.

Grade A
Twist (MM)

Grade B
Gauge (1X)

Grade D
Tangram (LV)

Index

Products are listed alphabetically in this index by alpha-numeric prefix/suffix codes.

Product Code	Product Description	Page
31-018-182	Wall Mounted Workstations – Wall Track	32
45-243	Wall Mounted Workstations – Wall Mount Monitor Arm	26
45-261	Wall Mounted Workstations – Sit-Stand Arm Extender	28
45-353-026	Wall Mounted Workstations – Sit-Stand Wall Mount LCD Arm	25
45-354-026	Wall Mounted Workstations – Sit-Stand Wall Mount Keyboard Arm	25
45-358-026	Wall Mounted Workstations – Sit-Stand Wall Mount System	24
45-359-026	Wall Mounted Workstations – Sit-Stand Wall Mount System	24
45-383-026	Wall Mounted Workstations – Sit-Stand Wall Mount LCD Arm	25
45-583	Wall Mounted Workstations – Sit-Stand Combo System - with Worksurface and Panning Pivot	28
45-594	Wall Mounted Workstations – Sit-Stand Combo System - with Worksurface and Panning Pivot	28
50-193-200	Wall Mounted Workstations – Notebook Tray	29
60-590	Mobile Carts – Power Strip Mounting Kit and Cord Wrap	19
60-591-003	Wall Mounted Workstations – Steel Stud Wall Mounting Kit	30
60-593	Wall Mounted Workstations – Vertical Lift - High Traffic Area	27
61-081	Wall Mounted Workstations – Sit-Stand Vertical Lift - High Traffic Area	27
61-367	Wall Mounted Workstations – Enclosure	22
80-063	Wall Mounted Workstations – Small CPU Holder	31
80-107	Wall Mounted Workstations – Mini PC Mount	31
90-011	Wall Mounted Workstations – Wall Track Mounting Kit	32
97-091	Wall Mounted Workstations – Track Mount Bracket Kit	32
97-101-003	Wall Mounted Workstations – Wall Plate	30
97-464	Mobile Carts – Coiled Extension Cord	19
97-466-214	Mobile Carts – Power Strip	19
97-468	Wall Mounted Workstations – Universal CPU Holder	31
97-487-800	Wall Mounted Workstations – Vertical Lift Auto-Retracting Keyboard Kit	27
97-531	Wall Mounted Workstations – Wall Track Mounting Kit	32
97-533	Wall Mounted Workstations – Wrist Rest - Antimicrobial	29
97-566	Wall Mounted Workstations – Scanner Holder - Wall Mount	29
97-631	Mobile Carts – T-Nut Kit	21
97-780-194	Mobile Carts – StyleView Scanner Shelf	20
97-783	Wall Mounted Workstations – Dual Monitor and Handle Kit	26
97-815	Wall Mounted Workstations – Scanner Shelf - VESA Attached	29
97-999	Mobile Carts – SV Hook	20
98-135-216	Mobile Carts – StyleView Wire Basket	20
98-246	Mobile Carts – Battery	15
98-247	Mobile Carts – Smart Battery Dock	15
98-258	Mobile Carts – 4-Bay Charger	15
98-419	Wall Mounted Workstations – Laminate Kit	23
98-424	Wall Mounted Workstations – Horizontal Scanner Bracket	23
98-425	Wall Mounted Workstations – Vertical Scanner Bracket	23
98-450	Mobile Carts – T-Slot Wipes Holder	21
98-451	Mobile Carts – Side-Mount Wipes Holder for CareFit Slim 2.0	13
98-453	Mobile Carts – Vinyl Cord Cover	19
98-465	Ergotron — CareFit Slim Accessories – T-Slot Scanner/Printer Holder for CareFit Slim	11
98-466	Mobile Carts – Side-Mount Scanner Bracket for CareFit Slim 2.0	13
98-467	Mobile Carts – Side-Mount Scanner Holder for CareFit Slim 2.0	13
98-468	Mobile Carts – Side-Mount Printer Bracket for CareFit Slim 2.0	14

Index

<u>Product Code</u>	<u>Product Description</u>	<u>Page</u>
98-470	Mobile Carts – Mini CPU Holder for CareFit Slim 2.0	14
98-476	Mobile Carts – Front Shelf for CareFit Slim 2.0	14
BNBR-22-S	Patient Room – Bariatric Recliner - Standard Arms	67
BNBR-22-T	Patient Room – Bariatric Recliner - Transfer Arms	68
BNGR	Patient Room – Three Position Glider Recliner	66
BNSC	Patient Room – Pull-Out Sleeper Chair	72
BNSF	Patient Room – Sleeper Flip Sofa	74
BNSR-22-S	Patient Room – Sleep Recliner - Standard Arms	69
BNSR-22-T	Patient Room – Sleep Recliner - Transfer Arms	71
BNSS	Patient Room – Pull-Out Sleeper Sofa	73
BNWR	Patient Room – Three Position Wall-Saver Recliner	65
C50-1100-0	Mobile Carts – Slim Laptop Cart	11
C50-3500-0	Mobile Carts – Slim 2.0 LCD Cart	12
C50-3510-0	Mobile Carts – Slim 2.0 LCD Cart	12
HE105-N	Exam Room Seating – Stools	61
HE106-R	Exam Room Seating – Stools	61
HE810-R-LNHN	Patient Room – Single Top	76
HE820-R-LL	Patient Room – Dual Top	76
S2UC-33-0	Task Seating — Zody LX – Cleanable+ – Task Chair	55
S2UC-33-1	Task Seating — Zody LX – Cleanable + – Task Chair	55
S2UC-33-4	Task Seating — Zody LX – Cleanable + – Task Chair	55
S2UC-33-7	Task Seating — Zody LX – Cleanable + – Task Chair	55
S2UD-33-1	Task Seating — Zody LX – Cleanable+ – Dual Posture	59
S2UD-33-4	Task Seating — Zody LX – Cleanable + – Task Chair	59
S2UD-33-7	Task Seating — Zody LX – Cleanable + – Task Chair	59
S2US-33-0	Task Seating — Zody LX – Cleanable+ – Task Stool	57
S2US-33-1	Task Seating — Zody LX – Cleanable+ – Task Stool	57
S2US-33-4	Task Seating — Zody LX – Cleanable+ – Task Stool	57
S2US-33-7	Task Seating — Zody LX – Cleanable+ – Task Stool	57
S75-22-01	Exam Room Seating – Without Arms	63
S75-22-11	Exam Room Seating – With Arms	62
S75-24-01	Exam Room Seating – Without Arms	63
S75-24-11	Exam Room Seating – With Arms	62
S75-44-01	Exam Room Seating – Without Arms	63
S75-44-11	Exam Room Seating – With Arms	62
SJT-3C-011A	Task Seating — Soji – Cleanable+ – Task Chair without Arms — Aluminum Base	41
SJT-3C-011A	Task Seating — Soji – Cleanable+ – Task Chair without Arms — Plastic Base	40
SJT-3C-111A	Task Seating — Soji – Cleanable+ – Task Chair with Fixed Arms — Aluminum Base	39
SJT-3C-111A	Task Seating — Soji – Cleanable+ – Task Chair with Fixed Arms — Plastic Base	38
SJT-3C-401X	Task Seating — Soji – Cleanable+ – Task Chair with Height Adjustable Arms — Plastic Base	36
SJT-3C-411X	Task Seating — Soji – Cleanable+ – Task Chair with Height Adjustable Arms — Aluminum Base	37
SJT-3C-711A	Task Seating — Soji – Cleanable+ – Task Chair with 4D Arms — Aluminum Base	35
SJT-3C-711A	Task Seating — Soji – Cleanable+ – Task Chair with 4D Arms — Plastic Base	34
SJTC-001A	Task Seating — Soji – Cleanable+ – Task Stool without Arms — Aluminum Base	49
SJTC-001A	Task Seating — Soji – Cleanable+ – Task Stool without Arms — Plastic Base	48
SJTC-001X	Task Seating — Soji – Cleanable+ – Task Stool without Arms — Aluminum Base	49
SJTC-001X	Task Seating — Soji – Cleanable+ – Task Stool without Arms — Plastic Base	48
SJTC-101A	Task Seating — Soji – Cleanable+ – Task Stool with Fixed Arms — Aluminum Base	47
SJTC-101A	Task Seating — Soji – Cleanable+ – Task Stool with Fixed Arms — Plastic Base	46

Index

Product Code	Product Description	Page
SJTC-101X	Task Seating — Soji – Cleanable+ – Task Stool with Fixed Arms — Aluminum Base	.47
SJTC-101X	Task Seating — Soji – Cleanable+ – Task Stool with Fixed Arms — Plastic Base	.46
SJTC-401A	Task Seating — Soji – Cleanable+ – Task Stool with Height Adjustable Arms — Aluminum Base	.45
SJTC-401A	Task Seating — Soji – Cleanable+ – Task Stool with Height Adjustable Arms — Plastic Base	.44
SJTC-401X	Task Seating — Soji – Cleanable+ – Task Stool with Height Adjustable Arms — Aluminum Base	.45
SJTC-401X	Task Seating — Soji – Cleanable+ – Task Stool with Height Adjustable Arms — Plastic Base	.44
SJTC-701A	Task Seating — Soji – Cleanable+ – Task Stool with 4D Arms — Aluminum Base	.43
SJTC-701A	Task Seating — Soji – Cleanable+ – Task Stool with 4D Arms — Plastic Base	.42
SJTC-701X	Task Seating — Soji – Cleanable+ – Task Stool with 4D Arms — Aluminum Base	.43
SJTC-701X	Task Seating — Soji – Cleanable+ – Task Stool with 4D Arms — Plastic Base	.42
SV42-6302-1	Mobile Carts – LCD Cart - LiFe Powered	.16
SV44-53E1-1	Mobile Carts – Telepresence Cart - Powered - Single Monitor	.17
SV44-57E1-1	Mobile Carts – Telepresence Cart - Powered Back-to-Back Monitor	.18
TS00-4TRY	Channel Accessories – Variable Height Cover — 12” Wide ChemSurf	.79
UZSR-CMIL	Channel Accessories – Reagent Shelf, Inboard Mount	.80
UZSR-CMIU	Channel Accessories – Reagent Shelf, Inboard Mount	.80
UZSR-CMO	Channel Accessories – Reagent Shelf, Outboard Mount	.80
VZCB-P	Channel Accessories – Bottom Tile Cover	.78
VZCF-P	Channel Accessories – Inside End Cover	.79
VZCH	Channel Accessories – Mounting Kit for Channel Cover Tile	.77
VZCS-0012-U	Channel Accessories – Spacer Bracket	.77
VZCU-P	Channel Accessories – Frame Tube Cover	.78
VZTI-D2N	Individual Tiles – ChemSurf Tile	.82
VZTI-DLN	Individual Tiles – ChemSurf Tile	.82
VZTI-DNN	Individual Tiles – ChemSurf Tile	.82
VZTI-DNS	Spanning In-line — Individual Tiles – Spanning ChemSurf Tile	.86
VZTI-DRN	Individual Tiles – ChemSurf Tile	.82
VZTI-PNN	Channel Accessories – Channel Cover Tile	.78
VZTI-PNN	Individual Tiles – Steel Tile	.81
VZTI-PNS	Spanning In-line — Individual Tiles – Spanning Steel Tile	.84
VZVZ-P	Channel Accessories – Variable Height Cover — 3” Wide Aluminum	.79

Product Compatibility and Limited Warranty Policy

Great Expectations

You have them as a Haworth customer and so do we. And because we value our customers, we cover our products with the Haworth North America Product Compatibility and Limited Warranty Policy.

Our Commitment To Product Compatibility – Integrated Product Platforms

As a market leader in the design and manufacture of workspaces that adapt to change, we strive to maintain product compatibility within our various generations of integrated product platforms. This benefits the customer who desires to update or modify their work environment. It also benefits the customer needing to replace a product due to damage or other reasons but which is no longer manufactured or is otherwise unavailable, such as a fabric or finish that is discontinued because of changing market preferences. In both circumstances, we often can provide products with comparable function and performance.

Our Commitment To Product Quality – The Haworth North America Limited Warranty

To ensure customer satisfaction and peace of mind, we stand behind our products with the Haworth North America Limited Warranty. To review the current version of the limited warranty including its terms and conditions, please go to:

www.haworth.com/warranty or contact OneTouch@Haworth.com or 1 877 429 6784.

Warranty Requests or Questions

For questions or service requests pertaining to the Haworth Limited Warranty, please contact your Haworth dealer.

If you are unsure who your dealer is, please contact **OneTouch@Haworth.com or 1 877 429 6784.**

Effective: September 1, 2021

Terms of Sale

The Terms of Sale apply to all products in the North America Price Lists. To review the current version of the North American Terms of Sale, please go to:

www.haworth.com/terms-of-sale or contact OneTouch@Haworth.com or 1 877 429 6784.

Effective: September 2, 2022

HAWORTH

HAWORTH® is a registered trademark of Haworth, Inc.
© Haworth, Inc. All rights reserved. 2024 2.24 | Item #LIT21016
haworth.com | 800 344 2600

Wall-Mounted Workstations

Ergotron - CareFit Combo System

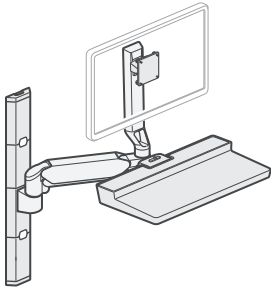

45-618-251

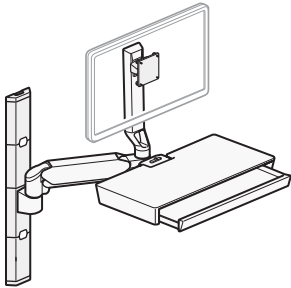

45-619-251

Features

- Includes combo arm, keyboard tray, wall mount base, track mount adapter, 34"(864mm) wall track, track mount bracket, wall track covers, cable ties and mounting hardware.
- Optional integrated worksurface available.
- Maximum screen size: 27"(686mm)
- Weight capacity:
 - Display: 8-22 lbs.
 - Keyboard and mouse: 1.5 lbs.
- Lift: Monitor and keyboard adjust 20"(508mm) in tandem with single motion using Constant Force™ technology. Monitor adjusts 5"(127mm) independently for a maximum monitor height adjustment of 25"(635mm).
- Screen rotates 360°.
- Tilt: Monitor tilts 25° (-5°/+20°). Keyboard tilts 90° up for space-saving storage.
- Pans 180° at two points for a total 360° side to side motion.
- Folds to within 9"(229mm) of wall in stowed position.
- Extension adds additional 18.5"(470mm) from wall.
- Worksurface dimensions: 14"(356mm)D x 27.5"(699mm)W
 - Keyboard area: 7.9"(201mm)D x 24.7"(627mm)W
 - Note: Keyboard area has additional space for extra cable and power brick storage as well as space for RFID badge scanner holder.

To Order, Specify:

- 1) Product number.

Specification Tips

- Mounts directly to architectural wall.
- Additional separately specified accessories include:
 - CareFit Extender Accessory

Description	Number	Price
CareFit Combo		
White	45-618-251	\$2083.33
CareFit Combo with Worksurface		
White	45-619-251	\$2604.17

Wall-Mounted Workstations

Ergotron - CareFit Combo Arm

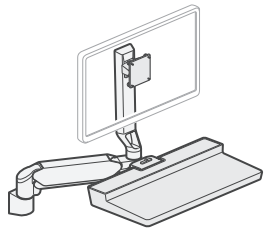

45-621-251

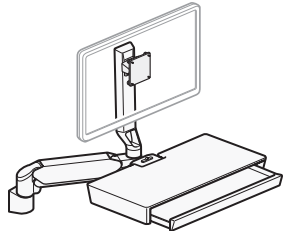

45-622-251

Features

- Includes combo arm, keyboard tray, wall mount base, track mount adapter, cable ties and mounting hardware.
- Optional integrated work surface available.
- Maximum screen size: 27"(686mm)
- Weight capacity:
 - Display: 8-22 lbs.
 - Keyboard and mouse: 1.5 lbs.
- Lift: Monitor and keyboard adjust 20"(508mm) in tandem with single motion using Constant Force™ technology. Monitor adjusts 5"(127mm) independently for a maximum monitor height adjustment of 25"(635mm).
- Screen rotates 360°.
- Tilt: Monitor tilts 25° (-5°/+20°). Keyboard tilts 90° up for space-saving storage.
- Pans 180° at two points for a total 360° side to side motion.
- Folds to within 9"(229mm) of wall in stowed position.
- Extension adds additional 18.5"(470mm) from wall.
- Worksurface dimensions: 14"(356mm)D x 27.5"(699mm)W
 - Keyboard area: 7.9"(201mm)D x 24.7"(627mm)W
 - Note: Keyboard area has additional space for extra cable and power brick storage as well as space for RFID badge scanner holder.

To Order, Specify:

- 1) Product number.

Specification Tip

- Mounts to Ergotron 34"(864mm) Wall Track

Description	Number	Price
CareFit Combo Arm		
White	45-621-251	\$1860.12
CareFit Combo Arm with Worksurface		
White	45-622-251	\$2336.31

Wall-Mounted Workstations

Ergotron - CareFit Combo Accessories

CPU Wall Cabinet

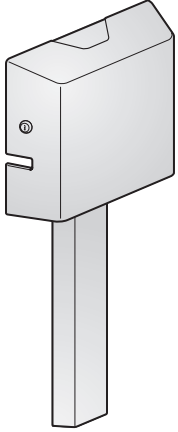

98-543-251

Features

- Includes cabinet enclosure, wall track cover, strap, two keys and attachment hardware.
- Maximum CPU size: 8.5"(216mm)H x 2"(51mm)D x 9.5"(241mm)W
- Maximum power brick size: 3"(76mm)H x 1"(25mm)D x 6"(152mm)W
- Weight capacity: 5 lbs.

To Order, Specify:

- 1) Product number.

Specification Tip

- Can be mounted above or below the system.

Description	Height	Depth	Width	Number	Price
White	12.5"	4"	14.85"	98-543-251	\$327.38

CPU Tray

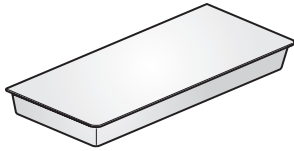

98-548-251

Features

- Includes tray, strap, and attachment hardware.
- Maximum CPU size: 7"(178mm)H x 1.4"(36mm)D x 7"(178mm)W
- Weight capacity: 4 lbs.

To Order, Specify:

- 1) Product number.

Description	Height	Depth	Width	Number	Price
White	3.8"	11.6"	24.5"	98-548-251	\$327.38

Extender

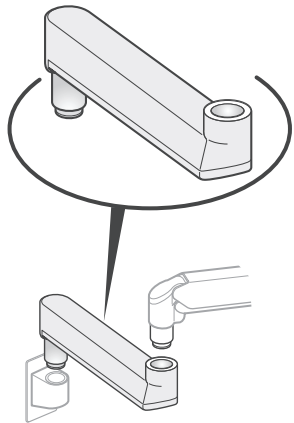

98-547-251

Features

- Includes extender arm, cable channel cover, end caps, cable tie and wrap.
- Extender is 23.3"(592mm)W

To Order, Specify:

- 1) Product number.

Specification Tip

- Extender may not be mounted to a hollow wall.

Description	Number	Price
White	98-547-251	\$505.95

Wireless Scanner Bracket

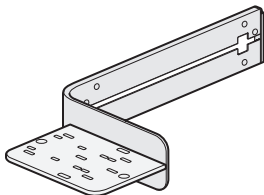

98-549-251

Features

- Includes scanner bracket with shelf, adapter bar and attachment hardware.
- Attaches to the right or left-hand side of the CareFit Combo keyboard tray.
- Cords route through keyboard tray and arm.
- Bracket is 4"(102mm)W x 5.5"(140mm)D.

To Order, Specify:

- 1) Product number.

Description	Number	Price
White	98-549-251	\$130.95

Wall-Mounted Workstations

Ergotron - CareFit Combo Accessories

Scanner Bracket

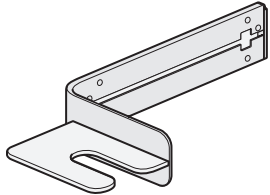

98-551-251

Features

- Includes scanner bracket and attachment hardware.
- Attaches to the right or left-hand side of the CareFit Combo keyboard tray.
- Cords route through keyboard tray and arm.
- Scanner bracket is 4"(102mm)W x 5.5"(140mm)D with a 1.25"(32mm) cutout for scanner handle.

To Order, Specify:

- 1) Product number.

Description	Number	Price
White	98-551-251	\$130.95

Printer Bracket

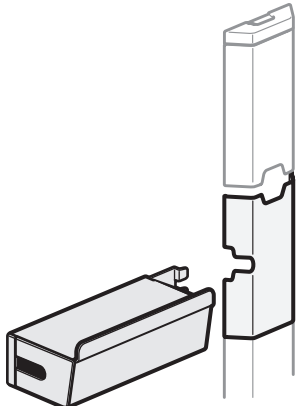

98-578-251

Features

- Includes printer shelf with cord box, end caps, wall track bracket, wall track cover, and attachment hardware.
- Shelf surface is 9.1"(231mm) x 4.5"(114mm)
- Weight capacity: 3 lbs.
- Can be attached at any height on a Wall Track.

To Order, Specify:

- 1) Product number.

Specification Tip

- Shelf should be mounted at a height that aligns with Wall Track Cover opening.

Description	Number	Price
White	98-578-251	\$202.38

Wall Track 34" Covers

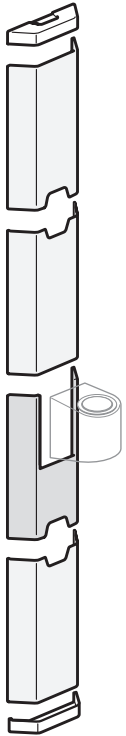

98-609-030

Features

- Includes three standard covers, one arm attachment cover and two end caps.
- Tool-less, snap-fit installation.

To Order, Specify:

- 1) Product number.

Description	Number	Price
White	98-609-030	\$163.69