

**PRODUCT SPECIFICATIONS**

Elkay Crosstown 18 Gauge Stainless Steel 33" x 22" x 9" Equal Double Bowl Dual Mount Sink Kit with Aqua Divide. Sink is handmade/fabricated from 18 gauge 304 Stainless Steel with a Polished Satin finish, Rear Center drain placement, and Full spray sides and bottom with Sides and Bottom pads.

<b>Installation Type:</b>	Drop-in, Sink Kits, Undermount
<b>Material:</b>	304 Stainless Steel
<b>Special Features:</b>	Aqua Divide Slim Rim
<b>Finish:</b>	Polished Satin
<b>Gauge:</b>	18
<b>Sound Deadening:</b>	Full spray sides and bottom with Sides and Bottom pads
<b>Number of Bowls:</b>	2
<b>Sink Dimensions:</b>	33" x 22" x 9"
<b>Bowl 1 Dimensions:</b>	14-3/4" x 16-3/4" x 9"
<b>Bowl 2 Dimensions:</b>	14-3/4" x 16-3/4" x 9"
<b>Drain Size:</b>	3-1/2" (89mm)
<b>Drain Location:</b>	Rear Center
<b>Minimum Cabinet Size:</b>	36"
<b>Mounting Hardware:</b>	Part # 64090022 included for drop-in installation for countertops thicker than 3/4" (19mm) up to 1-1/2" (38.1mm) thick.
<b>Template Included:</b>	Yes
<b>Cutout Template #:</b>	<a href="#">1000001180</a>

Template is available for download at [elkay.com](#). CAD software will be required to open the template.

**Cutout Dimensions for Drop-in Installation:**  
32-3/8" x 21-3/8" (822mm x 543mm) with 1/2" (12mm) corner radius

**Hole Drilling Configurations:**

1-1/2" (38mm) Diameter Faucet Holes on 4" (102mm) Centers

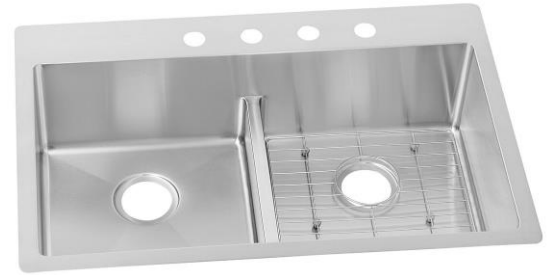
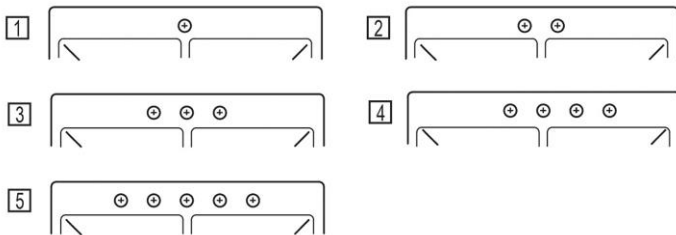

**Included with Product:** two CTXBG1315 Bottom Grid

A Century of Tradition and Quality. For more than 100 years, Elkay has been making innovative products and providing exceptional customer care. We take pride in offering plumbing products that make life easier, inspire change and leave the world a better place.



**Product Compliance:** ASME A112.19.3/CSA B45.4



Sinks are listed by IAPMO® as meeting the applicable requirements of the Uniform Plumbing Code®, International Plumbing Code®, and National Plumbing Code of Canada.

[Clean and Care Manual \(PDF\)](#)  
[Installation Instructions \(PDF\) - 1000005237](#)  
[Warranty \(PDF\)](#)

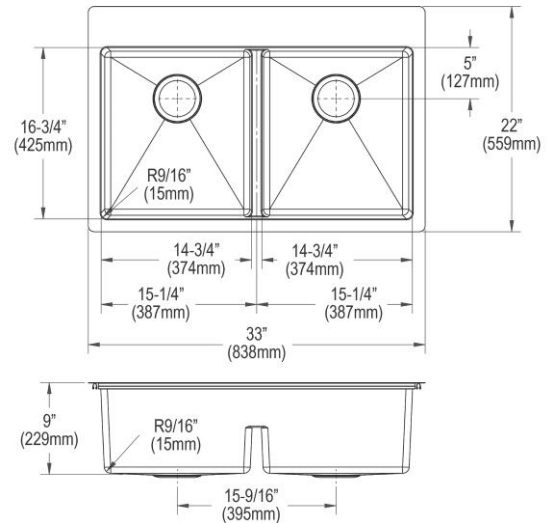



PART: \_\_\_\_\_ QTY: \_\_\_\_\_  
 PROJECT: \_\_\_\_\_  
 CONTACT: \_\_\_\_\_  
 DATE: \_\_\_\_\_  
 NOTES: \_\_\_\_\_  
 APPROVAL: \_\_\_\_\_

In keeping with our policy of continuing product improvement, Elkay reserves the right to change product specifications without notice. Please visit [elkay.com](#) for the most current version of Elkay product specification sheets. This specification describes an Elkay product with design, quality, and functional benefits to the user. When making a comparison of other producers' offerings, be certain these features are not overlooked. Latest version of the spec sheet available: [https://www.elkayfiles.com/spec-sheets/ECTSRA33229TBG\\_spec.pdf](https://www.elkayfiles.com/spec-sheets/ECTSRA33229TBG_spec.pdf)

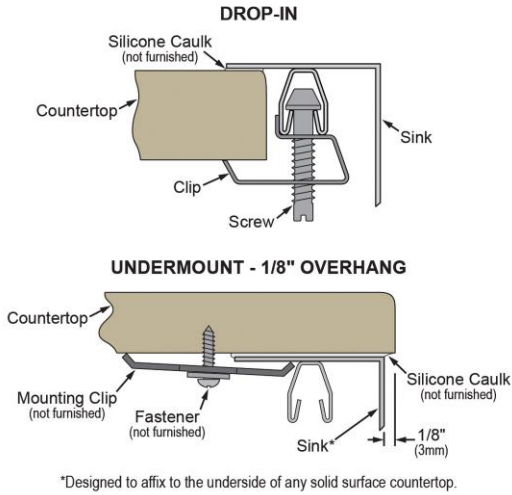
**Installation Profile:**

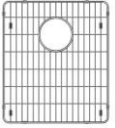

\*Designed to affix to the underside of any solid surface countertop.

Included Accessories		
<a href="#">CTXBG1315</a>	Elkay Crosstown Stainless Steel 13-1/2" x 15-1/2" x 1-1/4" Bottom Grid <a href="#">Spec Sheet (PDF)</a>	
Optional Accessories		
<a href="#">LK35</a>	Elkay 3-1/2" Drain Fitting Type 304 Stainless Steel Body Strainer Basket and Tailpiece <a href="#">Spec Sheet (PDF)</a>	
<a href="#">LKDD</a>	Elkay 3-1/2" Drain Fitting Deep Strainer Basket <a href="#">Spec Sheet (PDF)</a>	

*In keeping with our policy of continuing product improvement, Elkay reserves the right to change product specifications without notice. Please visit [elkay.com](http://elkay.com) for the most current version of Elkay product specification sheets. This specification describes an Elkay product with design, quality, and functional benefits to the user. When making a comparison of other producers' offerings, be certain these features are not overlooked. Latest version of the spec sheet available: [https://www.elkayfiles.com/spec-sheets/ECTSRA33229TBG\\_spec.pdf](https://www.elkayfiles.com/spec-sheets/ECTSRA33229TBG_spec.pdf)*