

HAWI

Mario Ferrarini | 2024





HAWI

Mario Ferrarini | 2024

The partnership between Lapalma and Mario Ferrarini goes ahead with a good wind behind it. That crisp air that appeared to give momentum to the interplay of dynamic appeal and stability of the Cross stool, designed by Mario Ferrarini for the company in 2022, now seems to sculpt the fluid and generous shapes of the HAWI chair, one of the new products that Lapalma is presenting at the next Salone del Mobile Milano. Its creation was inspired by the skilful manual sanding of wood. Stackable, it is exceptionally versatile, suiting various tastes and types of use.

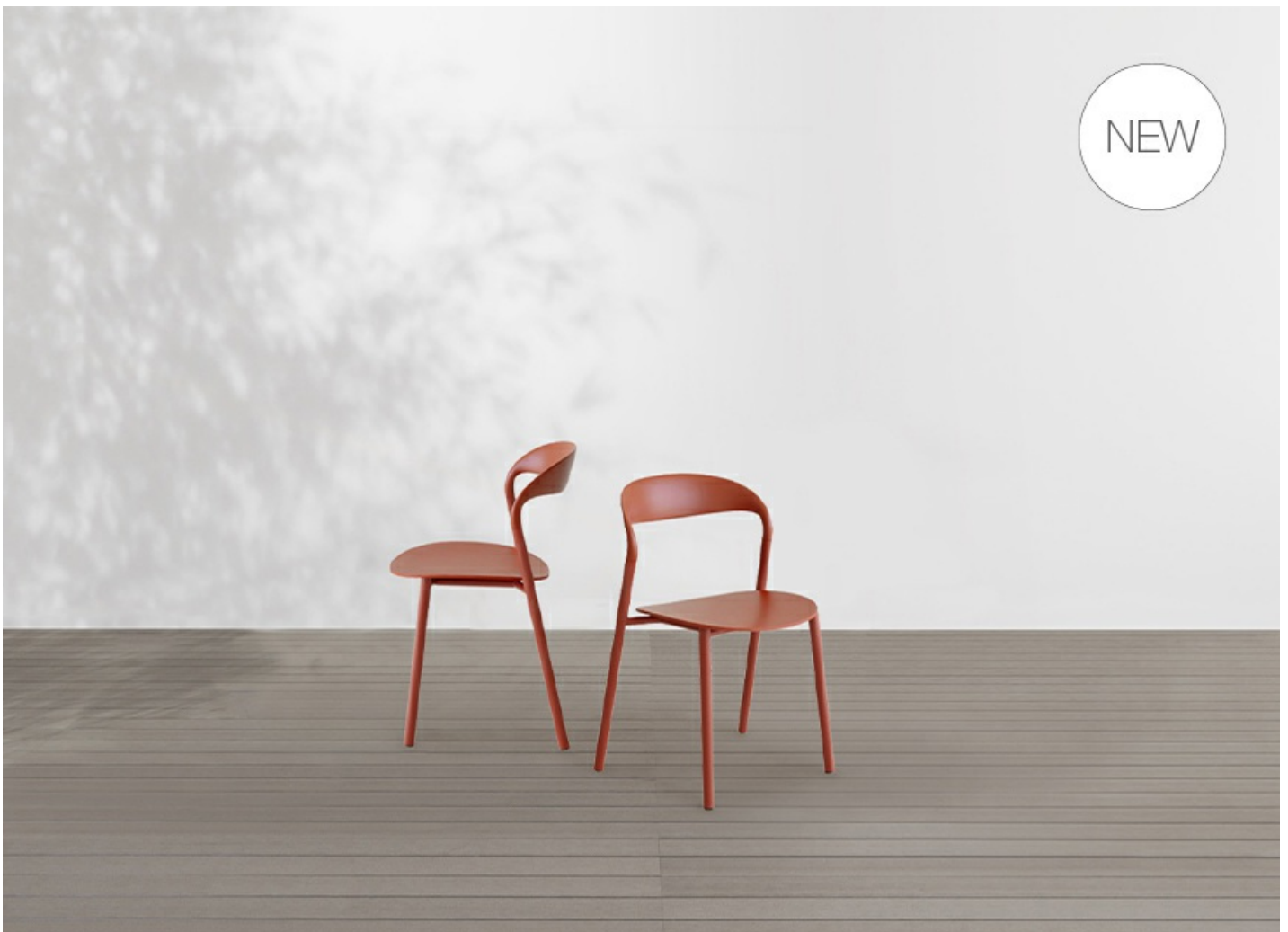





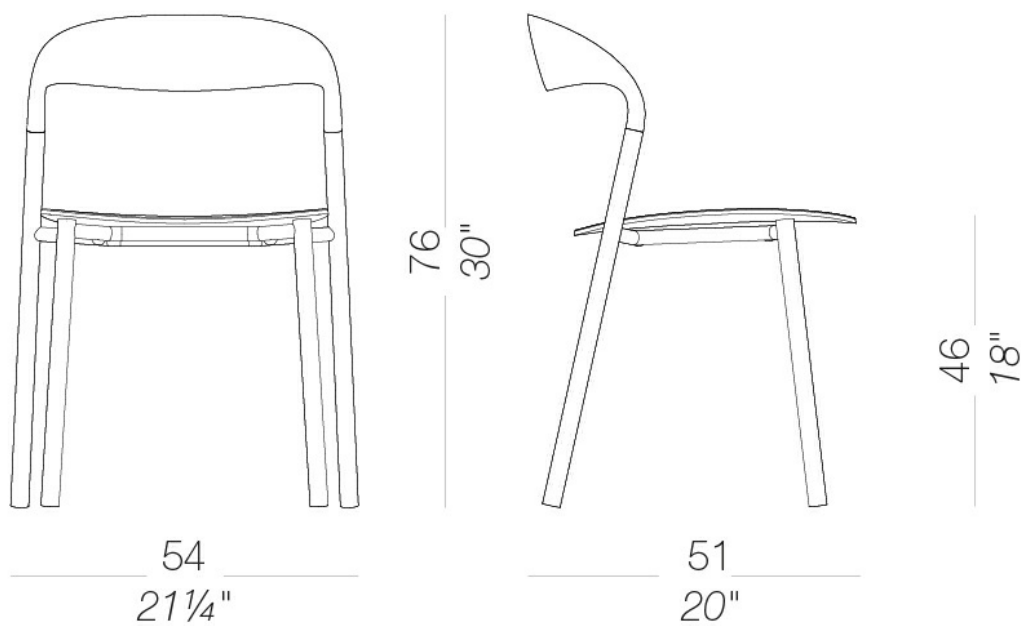

| ES420 4-legged stackable





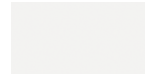

Stackable chair with powder-coated steel frame and polypropylene backrest and seat in various colours. Nylon feet with integrated felt.

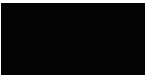
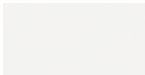

seat/back

							
plastics polypropylene mattone 1 Colors	plastics polypropylene perla 1 Colors	plastics polypropylene tortora 1 Colors	plastics polypropylene celeste 1 Colors	plastics polypropylene nero 1 Colors	plastics polypropylene bianco 1 Colors	plastics polypropylene pistacchio 1 Colors	plastics polypropylene oliva 1 Colors

frame

						
powder coating black 1 Colors	powder coating white 1 Colors	powder coating pistacchio 1 Colors	powder coating mattone 1 Colors	powder coating celeste 1 Colors	powder coating oliva 1 Colors	powder coating tortora 1 Colors

consult the portfolio for the range of colors, fabrics, eco-leather, soft-leather.

use and maintenance instructions

Clean all parts in wood, leather, fabric and metal with a damp cloth or a diluted neutral cleaner. Do not use cleaners with alcohol, bleach, solvent or abrasive products. Any liquid spilt on the product must be wiped up immediately. When lifting or moving the product, hold it on the structure and not under the seat. The product should not be subjected to unbalanced weights, as it is designed for a proper rest on the foothold (on four legs or on the base). Our company relieves from any responsibility in case of damage caused to fragile floors. Avoid any improper use of the product: do not step on the product, on the footrest or on the armrests. Avoid any movements that could compromise the proper functionality of the product or the safety of the users. Wood and leather, being natural materials, could be easily damaged. Small impurities or imperfections are within quality standard range. Do not expose the product to weather conditions or atmospheric agents, nor to heat sources over 40°C. Also products for outdoor use could be afflicted by atmospheric agents. The product could undergo possible exterior changes due to particular exposure to heat, humidity and saltiness. An appropriate and frequent maintenance and cleaning of the product enhances its durability. The product could change colour and shade, if exposed to direct sunlight. Maintenance has to be carried out by experienced staff. Dispose of the package only after assembling the product, in order to avoid the loss of ironmongery and components. Once the product has been dismantled, the product itself or its components must be given to the public garbage disposal system, according to the legislation in force.