

Features

- Two Lever handles offer separate control of hot and cold water
- 7-11/16" (195 mm) spout reach
- 1.2 gpm (4.5 lpm) maximum flow rate at 60 psi (4.14 bar)
- Coordinates with other products in the Tone collection
- This product can help a building earn Water Efficiency points in LEED® Green Building Rating System

Material

- Premium material construction for durability and reliability
- KOHLER finishes resist corrosion and tarnishing

Installation

- Wall-mount
- Requires rough-in kit (sold separately)

Required Products/Accessories

For wall-mount installation
K-410-K Wall-mount Valve

Adapters, Rough-in and Extension Kits

1349542 Range: 2-1/2" (64 mm) -
3-1/2" (89 mm)

Recommended Products/Accessories

K-23726 Drain treatment
K-23723 Faucet cleaner
K-27425 18" towel bar
K-27426 24" towel bar
K-27427 Robe hook
K-27428 Towel ring
K-27429 Pivoting toilet paper holder

Optional Products/Accessories

K-7107 Decorative Drain
K-7108 Decorative Drain
K-7129 Drain
K-7129-A Bathroom sink grid drain with overflow
K-8801 Sink drain and strainer with tailpiece
K-33151 Clicker drain without overflow
K-25322 Clicker drain with overflow



ADA	CSA B651	OBC
-----	----------	-----

Codes/Standards







ASME A112.18.1/CSA B125.1
NSF/ANSI/CAN 61
NSF/ANSI/CAN 372
DOE - Energy Policy Act 1992
EPA WaterSense®
California Energy Commission (CEC)
ADA
ICC/ANSI A117.1
CSA B651
OBC

KOHLER® Faucet Lifetime Limited Warranty

See website for detailed warranty information.

Available Colors/Finishes

Color tiles intended for reference only.

Color	Code	Description
	CP	Polished Chrome
	BN	Vibrant® Brushed Nickel
	BL	Matte Black
	2MB	Vibrant® Brushed Moderne Brass
	CBL	Matte Black with Polished Chrome
	BMB	Matte Black with Moderne Brass

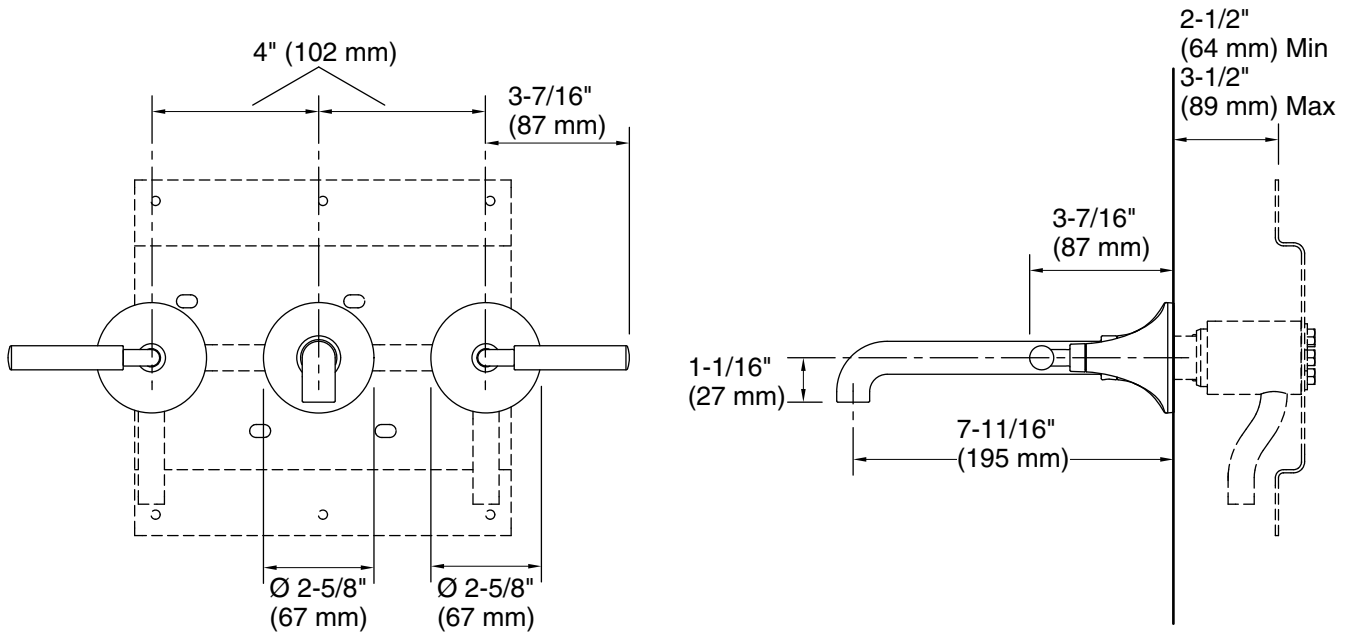

Technical Information

All product dimensions are nominal.

Faucet flow rate: 1.2 gal/min (4.5 l/min)

Drain included: No

Drain with overflow: No

Spout:

Spout reach: 7-11/16" (195 mm)

Notes

Install this product according to the installation instructions.

ADA, OBC, CSA B651 compliant when installed to the specific requirements of these regulations.