

Features

- 36" minimum base cabinet width
- Double-equal bowls
- 9" (229 mm) depth provides generous workspace
- Five oversized faucet holes
- Bowl slopes toward drain to minimize water pooling
- Offset drains increase workspace in the sink and storage space underneath
- Includes K-6239 colander with integral cutting board, K-6194 utility rack with soaking cup, and K-9238 bottom sink rack

Material

- KOHLER® enameled cast iron

Installation

- Undermount

Recommended Products/Accessories

- K-9238 Sink Rack
- K-8801 Sink drain and strainer with tailpiece
- K-8799 Sink drain and strainer basket
- K-23726 Drain treatment
- K-23725 Cast iron cleaner
- 1411886 Undermount sink kit 23"

Optional Products/Accessories

- K-11352 Disposal Flange with Stopper
- K-9000 P-Trap

Included Components

- K-6194 Utility Rack With Soaking Cup
- K-6239 Colander with Cutting Board
- K-9238 Sink Rack



Codes/Standards









ASME A112.19.1/CSA B45.2

KOHLER® Enameled Cast Iron Kitchen and Bathroom Sink Lifetime Limited Warranty

See website for detailed warranty information.

Available Colors/Finishes

Color tiles intended for reference only.

Color	Code	Description
	0	White
	FF	Sea Salt™
	96	Biscuit
	NY	Dune
	95	Ice™ Grey
	58	Thunder™ Grey
	7	Black Black™
	TRF	Truffle

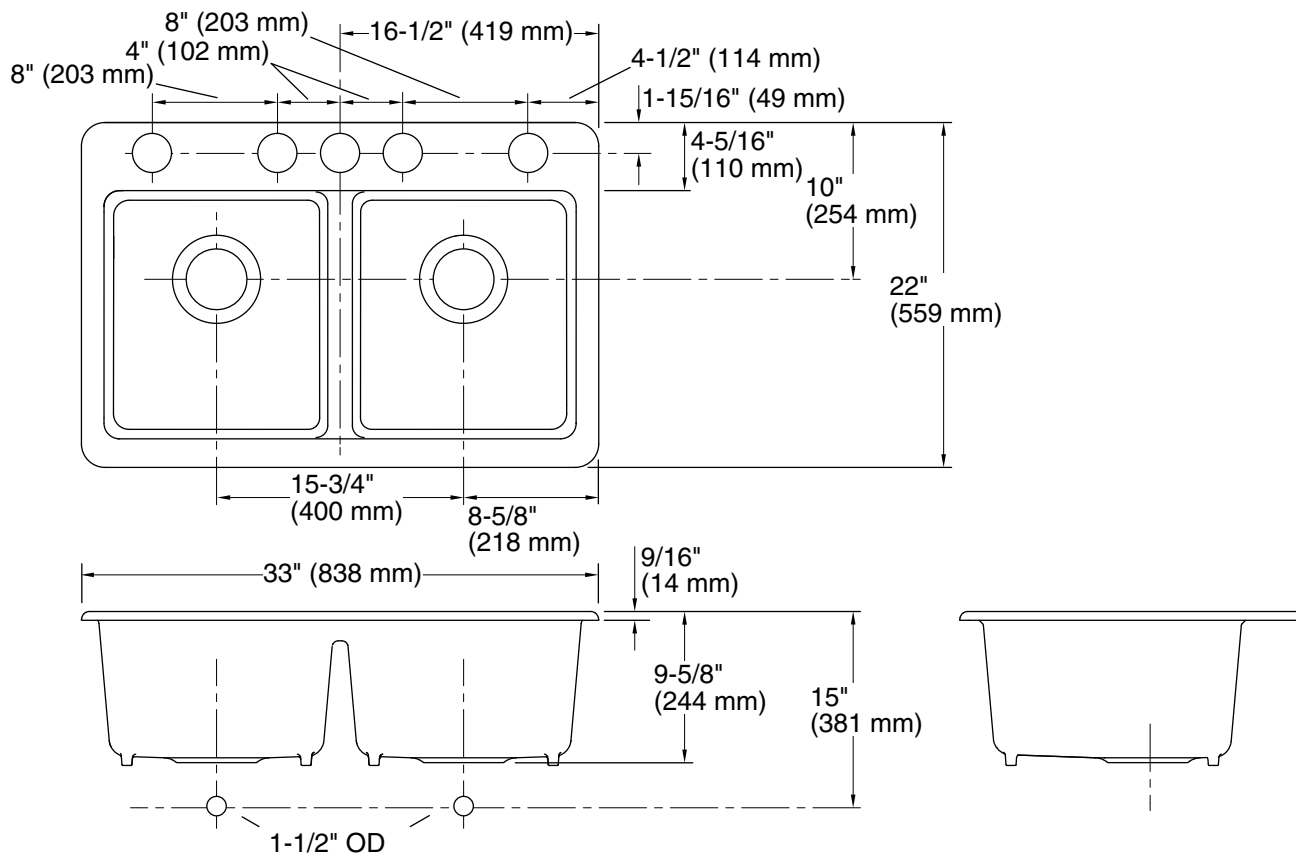

Technical Information

All product dimensions are nominal.

Basin configuration: Equal Bowls

Center(s): 8" (203 mm)

Min. base cabinet width: 36" (914 mm)

Bowl area (Double Equal Basins):
 Length: 14-5/16" (363 mm)
 Width: 15-13/16" (402 mm)
 Bowl depth: 9" (229 mm)
 Water depth: 9" (229 mm)

Number of deck holes: 5

Drain hole: 3-7/8" (98 mm)

Template: 1166727-7, required, included

Notes

Install this product according to the installation instructions.