

Description
Descripción

Wooden sideboards available in different sizes and finishes. Base with steel legs available in different colors, with the option of polished chrome finish. This collection, in addition to the door and drawer modules, includes an open module with shelf in smoked glass finish. Aparadores de madera disponibles en diferentes medidas y acabados. Base de patas de acero disponible en diferentes colores, con opción de acabado cromo brillo. Esta colección, además de los módulos de puertas y cajones, incluye un módulo diáfano con balda en acabado cristal fumé.

Wood finish Oak
Acabado madera
Roble



Wood finish Walnut
Acabado madera
Nogal

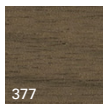

Wood lacquer finish
Acabado lacas madera



Glass finish
Acabado de cristal



Technical Stone 8 finish
Acabado Technical
Stone 8

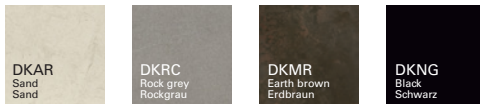

Technical Stone 8 Premium finish
Acabado Technical
Stone 8 Premium

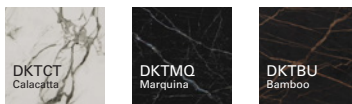

M1 marble finish
Acabado de mármol
M1



M3 marble finish
Acabado de mármol
M3



Aluminum finish
Acabado aluminio

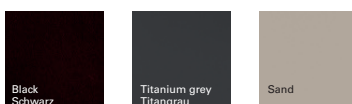

Intellectual property Propiedad intelectual

All our collections are protected by international industrial design registries, designs patents, copyrights and intellectual Property laws. Unauthorized use of AW International Property is a criminal offence and can lead to prosecution. Todas nuestras colecciones están protegidas por registros de diseño industrial, diseño de patente, copyright y derechos de propiedad intelectual en todo el mundo. El uso no autorizado de los diseños y propiedad intelectual de AW supone un delito que puede ser sometido a acción judicial.



CONFIGURATION DIAGRAM
CONFIGURACIÓN DIAGRAMA

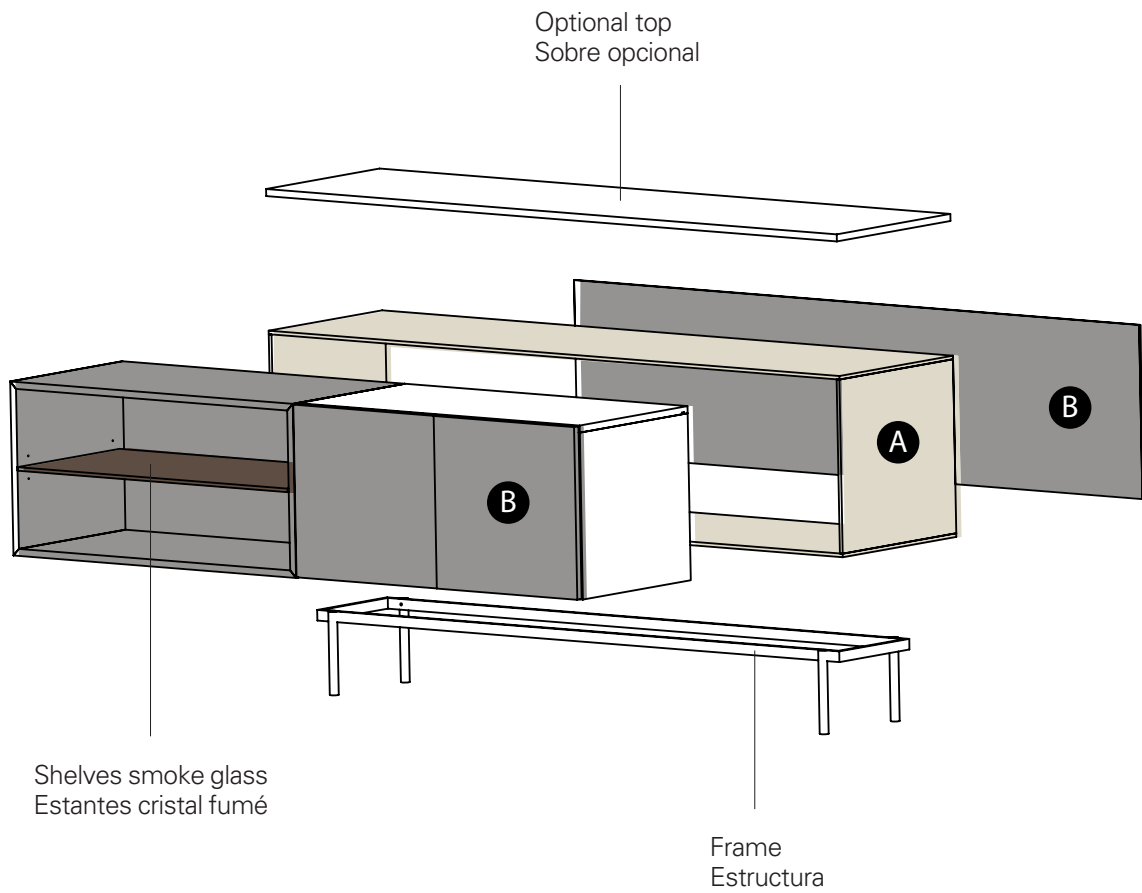

- A** Exterior material / Material exterior
- B** Front and back material / Material frontal y posterior

CZ09000

60.50 x 21.00

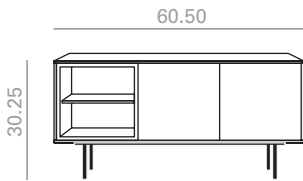

Exterior material / Material exterior	Front and back material / Material frontal y posterior		
Oak Roble	*Oak Roble	Walnut Nogal	Lacquered Lacado
	\$	\$	\$
	9,283	9,869	8,331
lbs	0	0	0
1 box / bulto Ft	0	0	0

Exterior material / Material exterior	Front and back material / Material frontal y posterior		
Walnut Nogal	*Oak Roble	Walnut Nogal	Lacquered Lacado
	\$	\$	\$
	9,387	9,979	8,426
lbs	0	0	0
1 box / bulto Ft	0	0	0

Exterior material / Material exterior	Front and back material / Material frontal y posterior		
Lacquered Lacado	*Oak Roble	Walnut Nogal	Lacquered Lacado
	\$	\$	\$
	8,948	9,489	7,993
lbs	0	0	0
1 box / bulto Ft	0	0	0



*Incremento por lacado mate y premium
*Matte lacquered and premium upcharge

| 359 |



Incremento por estructura en cromo brillo
Polished chrome frame up charge

| 354 |

CZ09001

80.25 x 21.00

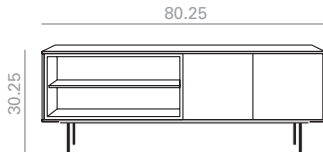

Exterior material / Material exterior	Front and back material / Material frontal y posterior		
Oak Roble	*Oak Roble	Walnut Nogal	Lacquered Lacado
	\$	\$	\$
	11,398	11,552	9,346
lbs	0	0	0
1 box / bulto Ft	0	0	0

Exterior material / Material exterior	Front and back material / Material frontal y posterior		
Walnut Nogal	*Oak Roble	Walnut Nogal	Lacquered Lacado
	\$	\$	\$
	11,630	11,784	9,571
lbs	0	0	0
1 box / bulto Ft	0	0	0

Exterior material / Material exterior	Front and back material / Material frontal y posterior		
Lacquered Lacado	*Oak Roble	Walnut Nogal	Lacquered Lacado
	\$	\$	\$
	10,421	10,938	8,421
lbs	0	0	0
1 box / bulto Ft	0	0	0



*Incremento por lacado mate y premium
*Matte lacquered and premium upcharge

| 488 |



Incremento por estructura en cromo brillo
Polished chrome frame up charge

| 590 |

CZ09002

100.00 x 21.00

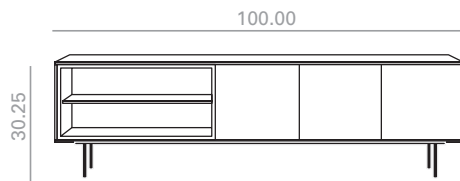

Exterior material / Material exterior	Front and back material / Material frontal y posterior		
Oak Roble	*Oak Roble	Walnut Nogal	Lacquered Lacado
	\$	\$	\$
	12,633	13,231	10,563
lbs	0	0	0
1 box / bulto Ft	0	0	0

Exterior material / Material exterior	Front and back material / Material frontal y posterior		
Walnut Nogal	*Oak Roble	Walnut Nogal	Lacquered Lacado
	\$	\$	\$
	13,392	13,524	11,283
lbs	0	0	0
1 box / bulto Ft	0	0	0

Exterior material / Material exterior	Front and back material / Material frontal y posterior		
Lacquered Lacado	*Oak Roble	Walnut Nogal	Lacquered Lacado
	\$	\$	\$
	11,936	12,460	9,901
lbs	0	0	0
1 box / bulto Ft	0	0	0



*Incremento por lacado mate y premium
*Matte lacquered and premium upcharge

| 616 |



Incremento por estructura en cromo brillo
Polished chrome frame up charge

| 829 |

CZ09003

119.50 x 21.00

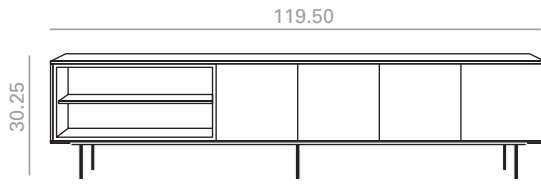

Exterior material / Material exterior	Front and back material / Material frontal y posterior		
Oak Roble	*Oak Roble	Walnut Nogal	Lacquered Lacado
	\$	\$	\$
	15,081	15,803	12,942
lbs	0	0	0
1 box / bulto Ft	0	0	0

Exterior material / Material exterior	Front and back material / Material frontal y posterior		
Walnut Nogal	*Oak Roble	Walnut Nogal	Lacquered Lacado
	\$	\$	\$
	15,858	16,031	13,684
lbs	0	0	0
1 box / bulto Ft	0	0	0

Exterior material / Material exterior	Front and back material / Material frontal y posterior		
Lacquered Lacado	*Oak Roble	Walnut Nogal	Lacquered Lacado
	\$	\$	\$
	14,322	14,979	12,224
lbs	0	0	0
1 box / bulto Ft	0	0	0











*Incremento por lacado mate y premium
*Matte lacquered and premium upcharge

| 745 |



Incremento por estructura en cromo brillo
Polished chrome frame up charge

| 1,124 |

Optional table tops / Sobres opcionales 10.75				
Top measures Medidas Sobres	Technical Stone 8	Low Iron Glass Cristal óptico	Marble M1 Mármol M1	Marble M3 Mármol M3
	\$	\$	\$	\$
60.50x21.00	1,886	2,093	1,538	3,222
 lbs	110	126	154	154
1 box / bulto  Ft	18.25	18.25	18.25	18.25
80.25x21.00	2,298	2,363	2,008	3,913
 lbs	149	153	168	168
1 box / bulto  Ft	21	21	21	21
100.00x21.00	2,759	2,835	2,502	4,893
 lbs	165	165	217	217
1 box / bulto  Ft	25.5	25.5	25.5	25.5
119.50x21.00	3,149	3,241	3,081	5,714
 lbs	180	198	235	235
1 box / bulto  Ft	32.25	32.25	32.25	32.25



***Marble shiny upcharge
Incremento por mármol
brillo

CONFIGURATION DIAGRAM
CONFIGURACIÓN DIAGRAMA

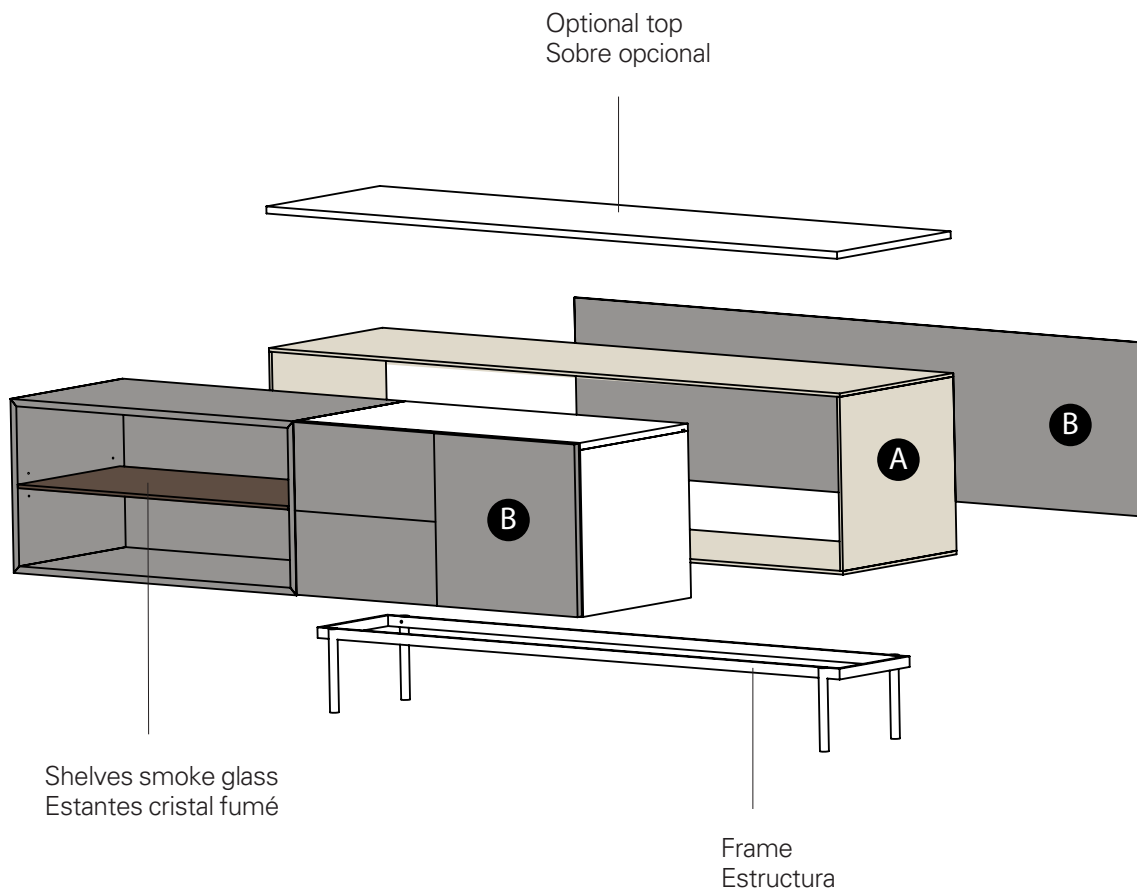

- A** Exterior material / Material exterior
- B** Front and back material / Material frontal y posterior

CZ09100

60.50 x 21.00

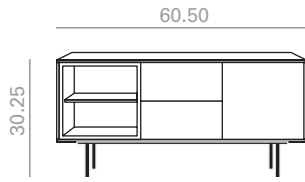

Exterior material / Material exterior	Front and back material / Material frontal y posterior		
Oak Roble	*Oak Roble	Walnut Nogal	Lacquered Lacado
	\$	\$	\$
	11,803	12,387	10,533
lbs	0	0	0
1 box / bulto Ft	0	0	0

Exterior material / Material exterior	Front and back material / Material frontal y posterior		
Walnut Nogal	*Oak Roble	Walnut Nogal	Lacquered Lacado
	\$	\$	\$
	11,902	12,493	10,621
lbs	0	0	0
1 box / bulto Ft	0	0	0

Exterior material / Material exterior	Front and back material / Material frontal y posterior		
Lacquered Lacado	*Oak Roble	Walnut Nogal	Lacquered Lacado
	\$	\$	\$
	11,458	12,005	10,201
lbs	0	0	0
1 box / bulto Ft	0	0	0



*Incremento por lacado mate y premium
*Matte lacquered and premium upcharge

| 359 |



Incremento por estructura en cromo brillo
Polished chrome frame up charge

| 354 |

CZ09101
80.25 x 21.00

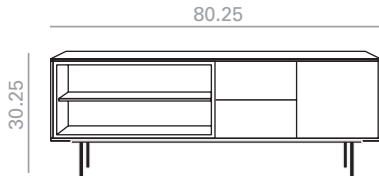

Exterior material / Material exterior	Front and back material / Material frontal y posterior		
Oak Roble	*Oak Roble	Walnut Nogal	Lacquered Lacado
	\$	\$	\$
	13,486	14,066	11,520
lbs	0	0	0
1 box / bulto Ft	0	0	0

Exterior material / Material exterior	Front and back material / Material frontal y posterior		
Walnut Nogal	*Oak Roble	Walnut Nogal	Lacquered Lacado
	\$	\$	\$
	13,696	14,301	11,727
lbs	0	0	0
1 box / bulto Ft	0	0	0

Exterior material / Material exterior	Front and back material / Material frontal y posterior		
Lacquered Lacado	*Oak Roble	Walnut Nogal	Lacquered Lacado
	\$	\$	\$
	12,546	13,036	11,053
lbs	0	0	0
1 box / bulto Ft	0	0	0



*Incremento por lacado mate y premium
*Matte lacquered and premium upcharge

| 488 |



Incremento por estructura en cromo brillo
Polished chrome frame up charge

| 590 |

CZ09102

100.00 x 21.00

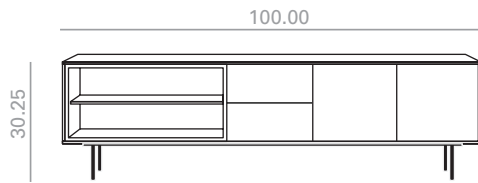

Exterior material / Material exterior	Front and back material / Material frontal y posterior		
Oak Roble	*Oak Roble	Walnut Nogal	Lacquered Lacado
	\$	\$	\$
	14,674	15,241	13,194
lbs	0	0	0
1 box / bulto Ft	0	0	0

Exterior material / Material exterior	Front and back material / Material frontal y posterior		
Walnut Nogal	*Oak Roble	Walnut Nogal	Lacquered Lacado
	\$	\$	\$
	15,403	16,039	13,382
lbs	0	0	0
1 box / bulto Ft	0	0	0

Exterior material / Material exterior	Front and back material / Material frontal y posterior		
Lacquered Lacado	*Oak Roble	Walnut Nogal	Lacquered Lacado
	\$	\$	\$
	14,008	14,508	12,536
lbs	0	0	0
1 box / bulto Ft	0	0	0



*Incremento por lacado mate y premium
*Matte lacquered and premium upcharge

| 616 |



Incremento por estructura en cromo brillo
Polished chrome frame up charge

| 829 |

CZ09103

119.50 x 21.00

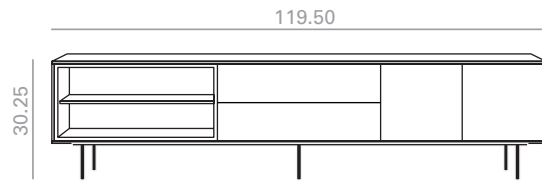

Exterior material / Material exterior	Front and back material / Material frontal y posterior		
Oak Roble	*Oak Roble	Walnut Nogal	Lacquered Lacado
	\$	\$	\$
	17,344	18,039	15,292
lbs	0	0	0
1 box / bulto Ft	0	0	0

Exterior material / Material exterior	Front and back material / Material frontal y posterior		
Walnut Nogal	*Oak Roble	Walnut Nogal	Lacquered Lacado
	\$	\$	\$
	18,087	18,860	15,999
lbs	0	0	0
1 box / bulto Ft	0	0	0

Exterior material / Material exterior	Front and back material / Material frontal y posterior		
Lacquered Lacado	*Oak Roble	Walnut Nogal	Lacquered Lacado
	\$	\$	\$
	16,615	17,243	14,604
lbs	0	0	0
1 box / bulto Ft	0	0	0











*Incremento por lacado mate y premium
*Matte lacquered and premium upcharge

| 745 |



Incremento por estructura en cromo brillo
Polished chrome frame up charge

| 1,124 |

Optional table tops / Sobres opcionales 10.75				
Top measures Medidas Sobres	Technical Stone 8	Low Iron Glass Cristal óptico	Marble M1 Mármol M1	Marble M3 Mármol M3
	\$	\$	\$	\$
60.50x21.00	1,886	2,093	1,538	3,222
 lbs	110	126	154	154
1 box / bulto  Ft	18.25	18.25	18.25	18.25
80.25x21.00	2,298	2,363	2,008	3,913
 lbs	149	153	168	168
1 box / bulto  Ft	21	21	21	21
100.00x21.00	2,759	2,835	2,502	4,893
 lbs	165	165	217	217
1 box / bulto  Ft	25.5	25.5	25.5	25.5
119.50x21.00	3,149	3,241	3,081	5,714
 lbs	180	198	235	235
1 box / bulto  Ft	32.25	32.25	32.25	32.25



***Marble shiny upcharge
Incremento por mármol
brillo

CONFIGURATION DIAGRAM
CONFIGURACIÓN DIAGRAMA

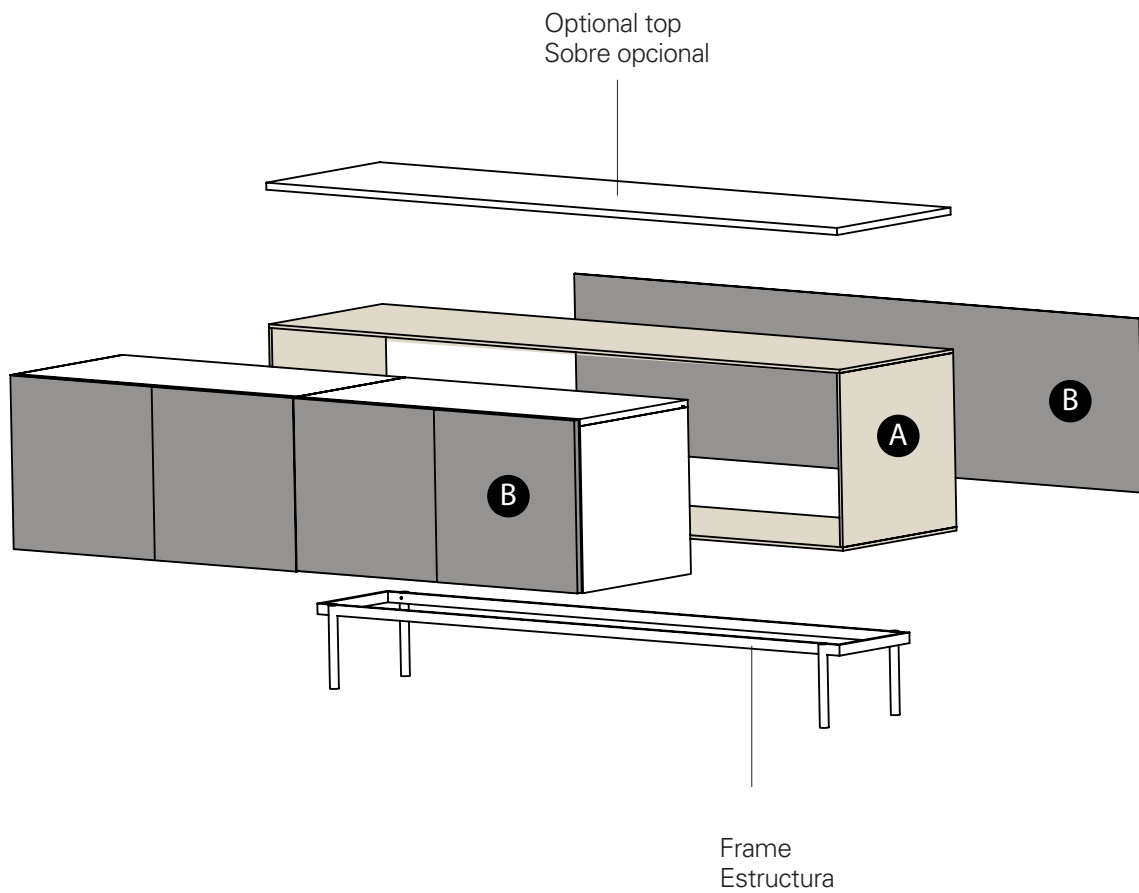

- A** Exterior material / Material exterior
- B** Front and back material / Material frontal y posterior

CZ09200

60.50 x 21.00

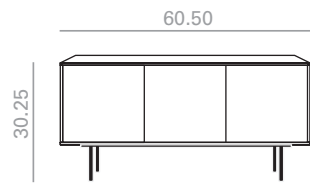

Exterior material / Material exterior	Front and back material / Material frontal y posterior		
Oak Roble	*Oak Roble	Walnut Nogal	Lacquered Lacado
	\$	\$	\$
	7,708	8,129	7,494
lbs	0	0	0
1 box / bulto Ft	0	0	0

Exterior material / Material exterior	Front and back material / Material frontal y posterior		
Walnut Nogal	*Oak Roble	Walnut Nogal	Lacquered Lacado
	\$	\$	\$
	7,807	8,240	7,596
lbs	0	0	0
1 box / bulto Ft	0	0	0

Exterior material / Material exterior	Front and back material / Material frontal y posterior		
Lacquered Lacado	*Oak Roble	Walnut Nogal	Lacquered Lacado
	\$	\$	\$
	7,352	7,734	7,156
lbs	0	0	0
1 box / bulto Ft	0	0	0



*Incremento por lacado mate y premium
*Matte lacquered and premium upcharge

| 359 |



Incremento por estructura en cromo brillo
Polished chrome frame up charge

| 354 |

CZ09201

80.25 x 21.00

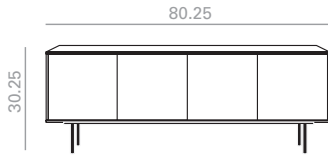

Exterior material / Material exterior	Front and back material / Material frontal y posterior		
Oak Roble	*Oak Roble	Walnut Nogal	Lacquered Lacado
	\$	\$	\$
	10,405	10,954	10,129
lbs	0	0	0
1 box / bulto Ft	0	0	0

Exterior material / Material exterior	Front and back material / Material frontal y posterior		
Walnut Nogal	*Oak Roble	Walnut Nogal	Lacquered Lacado
	\$	\$	\$
	10,632	11,203	10,345
lbs	0	0	0
1 box / bulto Ft	0	0	0

Exterior material / Material exterior	Front and back material / Material frontal y posterior		
Lacquered Lacado	*Oak Roble	Walnut Nogal	Lacquered Lacado
	\$	\$	\$
	9,427	9,877	9,197
lbs	0	0	0
1 box / bulto Ft	0	0	0



*Incremento por lacado mate y premium
*Matte lacquered and premium upcharge

| 488 |



Incremento por estructura en cromo brillo
Polished chrome frame up charge

| 590 |

CZ09202

100.00 x 21.00

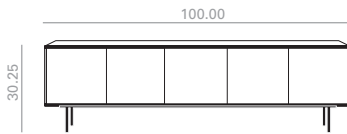

Exterior material / Material exterior	Front and back material / Material frontal y posterior		
Oak Roble	*Oak Roble	Walnut Nogal	Lacquered Lacado
	\$	\$	\$
	11,646	12,230	11,343
lbs	0	0	0
1 box / bulto Ft	0	0	0

Exterior material / Material exterior	Front and back material / Material frontal y posterior		
Walnut Nogal	*Oak Roble	Walnut Nogal	Lacquered Lacado
	\$	\$	\$
	12,398	13,070	12,062
lbs	0	0	0
1 box / bulto Ft	0	0	0

Exterior material / Material exterior	Front and back material / Material frontal y posterior		
Lacquered Lacado	*Oak Roble	Walnut Nogal	Lacquered Lacado
	\$	\$	\$
	10,943	11,465	10,685
lbs	0	0	0
1 box / bulto Ft	0	0	0



*Incremento por lacado mate y premium
*Matte lacquered and premium upcharge

| 616 |



Incremento por estructura en cromo brillo
Polished chrome frame up charge

| 829 |

CZ09203

119.50 x 21.00

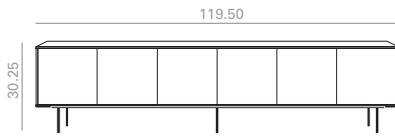

Exterior material / Material exterior	Front and back material / Material frontal y posterior		
Oak Roble	*Oak Roble	Walnut Nogal	Lacquered Lacado
	\$	\$	\$
	14,087	14,809	13,722
lbs	0	0	0
1 box / bulto Ft	0	0	0

Exterior material / Material exterior	Front and back material / Material frontal y posterior		
Walnut Nogal	*Oak Roble	Walnut Nogal	Lacquered Lacado
	\$	\$	\$
	14,864	15,076	14,460
lbs	0	0	0
1 box / bulto Ft	0	0	0

Exterior material / Material exterior	Front and back material / Material frontal y posterior		
Lacquered Lacado	*Oak Roble	Walnut Nogal	Lacquered Lacado
	\$	\$	\$
	13,090	13,744	12,766
lbs	0	0	0
1 box / bulto Ft	0	0	0











*Incremento por lacado mate y premium
*Matte lacquered and premium upcharge

| 745 |



Incremento por estructura en cromo brillo
Polished chrome frame up charge

| 1,124 |

Optional table tops / Sobres opcionales 10.75				
Top measures Medidas Sobres	Technical Stone 8	Low Iron Glass Cristal óptico	Marble M1 Mármol M1	Marble M3 Mármol M3
	\$	\$	\$	\$
60.50x21.00	1,886	2,093	1,538	3,222
 lbs	110	126	154	154
1 box / bulto  Ft	18.25	18.25	18.25	18.25
80.25x21.00	2,298	2,363	2,008	3,913
 lbs	149	153	168	168
1 box / bulto  Ft	21	21	21	21
100.00x21.00	2,759	2,835	2,502	4,893
 lbs	165	165	217	217
1 box / bulto  Ft	25.5	25.5	25.5	25.5
119.50x21.00	3,149	3,241	3,081	5,714
 lbs	180	198	235	235
1 box / bulto  Ft	32.25	32.25	32.25	32.25



***Marble shiny upcharge
Incremento por mármol
brillo

| 68 |

CONFIGURATION DIAGRAM
CONFIGURACIÓN DIAGRAMA

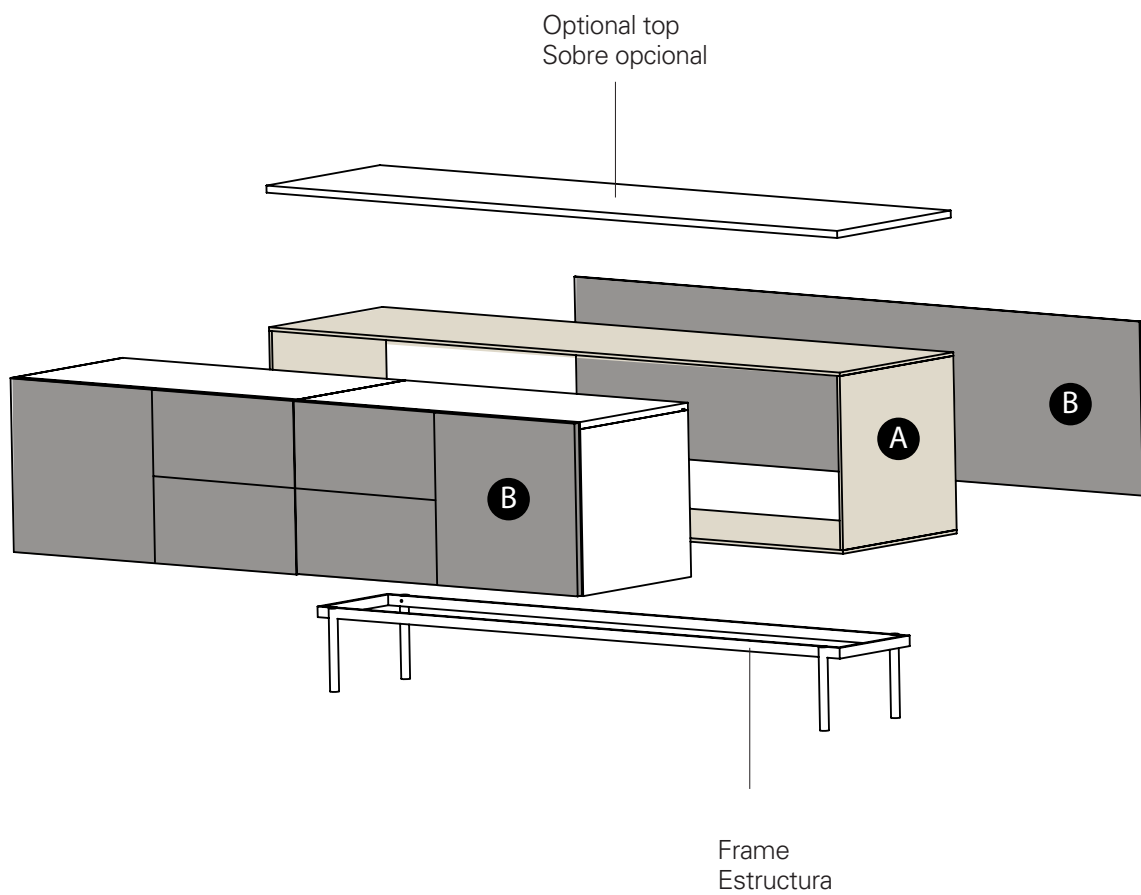

- A** Exterior material / Material exterior
- B** Front and back material / Material frontal y posterior

CZ09300

60.50 x 21.00

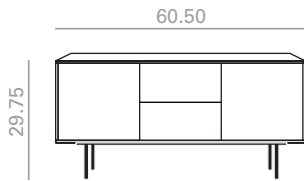

Exterior material / Material exterior
Oak Roble
lbs
1 box / bulto Ft

Front and back material / Material frontal y posterior		
*Oak Roble	Walnut Nogal	Lacquered Lacado
\$	\$	\$
10,013	10,421	9,815
0	0	0
0	0	0

Exterior material / Material exterior
Walnut Nogal
lbs
1 box / bulto Ft

Front and back material / Material frontal y posterior		
*Oak Roble	Walnut Nogal	Lacquered Lacado
\$	\$	\$
10,117	10,533	9,911
0	0	0
0	0	0

Exterior material / Material exterior
Lacquered Lacado
lbs
1 box / bulto Ft

Front and back material / Material frontal y posterior		
*Oak Roble	Walnut Nogal	Lacquered Lacado
\$	\$	\$
9,679	10,052	9,489
0	0	0
0	0	0



*Incremento por lacado mate y premium
*Matte lacquered and premium upcharge

| 488 |



Incremento por estructura en cromo brillo
Polished chrome frame up charge

| 354 |

CZ09301
80.25 x 21.00

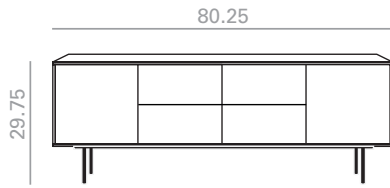

Exterior material / Material exterior	Front and back material / Material frontal y posterior		
Oak Roble	*Oak Roble	Walnut Nogal	Lacquered Lacado
	\$	\$	\$
	14,536	15,060	14,275
lbs	0	0	0
1 box / bulto Ft	0	0	0

Exterior material / Material exterior	Front and back material / Material frontal y posterior		
Walnut Nogal	*Oak Roble	Walnut Nogal	Lacquered Lacado
	\$	\$	\$
	14,756	15,301	14,476
lbs	0	0	0
1 box / bulto Ft	0	0	0

Exterior material / Material exterior	Front and back material / Material frontal y posterior		
Lacquered Lacado	*Oak Roble	Walnut Nogal	Lacquered Lacado
	\$	\$	\$
	13,600	14,036	13,380
lbs	0	0	0
1 box / bulto Ft	0	0	0



*Incremento por lacado mate y premium
*Matte lacquered and premium upcharge

| 488 |



Incremento por estructura en cromo brillo
Polished chrome frame up charge

| 590 |

CZ09302

100.00 x 21.00

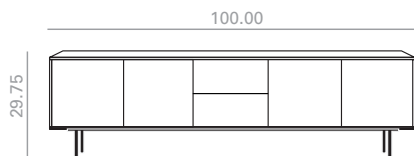

Exterior material / Material exterior	Front and back material / Material frontal y posterior		
Oak Roble	*Oak Roble	Walnut Nogal	Lacquered Lacado
	\$	\$	\$
	16,893	17,528	16,437
lbs	0	0	0
1 box / bulto Ft	0	0	0

Exterior material / Material exterior	Front and back material / Material frontal y posterior		
Walnut Nogal	*Oak Roble	Walnut Nogal	Lacquered Lacado
	\$	\$	\$
	17,155	17,811	16,679
lbs	0	0	0
1 box / bulto Ft	0	0	0

Exterior material / Material exterior	Front and back material / Material frontal y posterior		
Lacquered Lacado	*Oak Roble	Walnut Nogal	Lacquered Lacado
	\$	\$	\$
	15,837	16,364	15,437
lbs	0	0	0
1 box / bulto Ft	0	0	0



*Incremento por lacado mate y premium
*Matte lacquered and premium upcharge

616



Incremento por estructura en cromo brillo
Polished chrome frame up charge

829

CZ09303

119.50 x 21.00

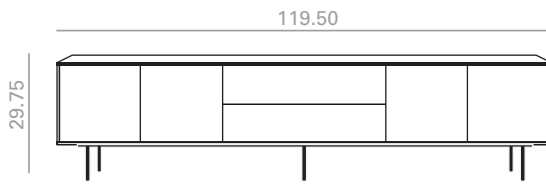

Exterior material / Material exterior	Front and back material / Material frontal y posterior		
Oak Roble	*Oak Roble	Walnut Nogal	Lacquered Lacado
	\$	\$	\$
	17,358	18,068	17,019
lbs	0	0	0
1 box / bulto Ft	0	0	0

Exterior material / Material exterior	Front and back material / Material frontal y posterior		
Walnut Nogal	*Oak Roble	Walnut Nogal	Lacquered Lacado
	\$	\$	\$
	18,110	18,878	17,723
lbs	0	0	0
1 box / bulto Ft	0	0	0

Exterior material / Material exterior	Front and back material / Material frontal y posterior		
Lacquered Lacado	*Oak Roble	Walnut Nogal	Lacquered Lacado
	\$	\$	\$
	16,645	17,261	16,325
lbs	0	0	0
1 box / bulto Ft	0	0	0











*Incremento por lacado mate y premium
*Matte lacquered and premium upcharge

| 745 |



Incremento por estructura en cromo brillo
Polished chrome frame up charge

| 1,124 |

Optional table tops / Sobres opcionales 10.75				
Top measures Medidas Sobres	Technical Stone 8	Low Iron Glass Cristal óptico	Marble M1 Mármol M1	Marble M3 Mármol M3
	\$	\$	\$	\$
60.50x21.00	1,886	2,093	1,538	3,222
 lbs	110	126	154	154
1 box / bulto  Ft	18.25	18.25	18.25	18.25
80.25x21.00	2,298	2,363	2,008	3,913
 lbs	149	153	168	168
1 box / bulto  Ft	21	21	21	21
100.00x21.00	2,759	2,835	2,502	4,893
 lbs	165	165	217	217
1 box / bulto  Ft	25.5	25.5	25.5	25.5
119.50x21.00	3,149	3,241	3,081	5,714
 lbs	180	198	235	235
1 box / bulto  Ft	32.25	32.25	32.25	32.25



***Marble shiny upcharge
Incremento por mármol
brillo

| 68 |